

**User Manual**

# SOM-AB5810

**ADVANTECH**

*Enabling an Intelligent Planet*

---

## Copyright

The documentation and the software included with this product are copyrighted 2014 by Advantech Co., Ltd. All rights are reserved. Advantech Co., Ltd. reserves the right to make improvements in the products described in this manual at any time without notice. No part of this manual may be reproduced, copied, translated or transmitted in any form or by any means without the prior written permission of Advantech Co., Ltd. Information provided in this manual is intended to be accurate and reliable. However, Advantech Co., Ltd. assumes no responsibility for its use, nor for any infringements of the rights of third parties, which may result from its use.

## Acknowledgements

Intel and Pentium are trademarks of Intel Corporation.

Microsoft Windows and MS-DOS are registered trademarks of Microsoft Corp.

All other product names or trademarks are properties of their respective owners.

## Product Warranty (2 years)

Advantech warrants to you, the original purchaser, that each of its products will be free from defects in materials and workmanship for two years from the date of purchase.

This warranty does not apply to any products which have been repaired or altered by persons other than repair personnel authorized by Advantech, or which have been subject to misuse, abuse, accident or improper installation. Advantech assumes no liability under the terms of this warranty as a consequence of such events.

Because of Advantech's high quality-control standards and rigorous testing, most of our customers never need to use our repair service. If an Advantech product is defective, it will be repaired or replaced at no charge during the warranty period. For out-of-warranty repairs, you will be billed according to the cost of replacement materials, service time and freight. Please consult your dealer for more details.

If you think you have a defective product, follow these steps:

1. Collect all the information about the problem encountered. (For example, CPU speed, Advantech products used, other hardware and software used, etc.) Note anything abnormal and list any onscreen messages you get when the problem occurs.
2. Call your dealer and describe the problem. Please have your manual, product, and any helpful information readily available.
3. If your product is diagnosed as defective, obtain an RMA (return merchandise authorization) number from your dealer. This allows us to process your return more quickly.
4. Carefully pack the defective product, a fully-completed Repair and Replacement Order Card and a photocopy proof of purchase date (such as your sales receipt) in a shippable container. A product returned without proof of the purchase date is not eligible for warranty service.
5. Write the RMA number visibly on the outside of the package and ship it prepaid to your dealer.

# Declaration of Conformity

## CE

This product has passed the CE test for environmental specifications. Test conditions for passing included the equipment being operated within an industrial enclosure. In order to protect the product from being damaged by ESD (Electrostatic Discharge) and EMI leakage, we strongly recommend the use of CE-compliant industrial enclosure products.

## FCC Class B

Note: This equipment has been tested and found to comply with the limits for a Class B digital device, pursuant to part 15 of the FCC Rules. These limits are designed to provide reasonable protection against harmful interference in a residential installation. This equipment generates, uses and can radiate radio frequency energy and, if not installed and used in accordance with the instructions, may cause harmful interference to radio communications. However, there is no guarantee that interference will not occur in a particular installation. If this equipment does cause harmful interference to radio or television reception, which can be determined by turning the equipment off and on, the user is encouraged to try to correct the interference by one or more of the following measures:

- Reorient or relocate the receiving antenna.
- Increase the separation between the equipment and receiver.
- Connect the equipment into an outlet on a circuit different from that to which the receiver is connected.
- Consult the dealer or an experienced radio/TV technician for help.

# Technical Support and Assistance

1. Visit the Advantech website at <http://support.advantech.com> where you can find the latest information about the product.
2. Contact your distributor, sales representative, or Advantech's customer service center for technical support if you need additional assistance. Please have the following information ready before you call:
  - Product name and serial number
  - Description of your peripheral attachments
  - Description of your software (operating system, version, application software, etc.)
  - A complete description of the problem
  - The exact wording of any error messages

---

## Warnings, Cautions and Notes

**Warning!** Warnings indicate conditions, which if not observed, can cause personal injury!



**Caution!** Cautions are included to help you avoid damaging hardware or losing data. e.g.



*There is a danger of a new battery exploding if it is incorrectly installed. Do not attempt to recharge, force open, or heat the battery. Replace the battery only with the same or equivalent type recommended by the manufacturer. Discard used batteries according to the manufacturer's instructions.*

**Note!** Notes provide optional additional information.



## Document Feedback

To assist us in making improvements to this manual, we welcome comments and constructive criticism. Please send all such - in writing to:

support@advantech.com

## Packing List

Before setting up the system, check that the items listed below are included and in good condition. If any items are missing, please contact your dealer immediately.

- SOM-AB5810 Module
- 1 x I/O Bracket for SOM-AB5810
- 1 x Serial ATA Cable 7P/7P 30cm
- 1 x Flat COM Port Cable
- 1 x POST M2.5\*5L
- 1 x NUT M2.5 x 5 x 3 mm
- 1 x A Cable 2\*5P-2.54/USB-A (F)\*2 17.5cm W/BKT F/5
- 2 x A CABLE SATA 15P/1\*4P-2.5 35cm (For DC-in SKU only)

# Safety Instructions

1. Read these safety instructions carefully.
2. Keep this User Manual for later reference.
3. Disconnect this equipment from any AC outlet before cleaning. Use a damp cloth. Do not use liquid or spray detergents for cleaning.
4. For plug-in equipment, the power outlet socket must be located near the equipment and must be easily accessible.
5. Keep this equipment away from humidity.
6. Put this equipment on a reliable surface during installation. Dropping it or letting it fall may cause damage.
7. The openings on the enclosure are for air convection. Protect the equipment from overheating. **DO NOT COVER THE OPENINGS.**
8. Make sure the voltage of the power source is correct before connecting the equipment to the power outlet.
9. Position the power cord so that people cannot step on it. Do not place anything over the power cord.
10. All cautions and warnings on the equipment should be noted.
11. If the equipment is not used for a long time, disconnect it from the power source to avoid damage by transient overvoltage.
12. Never pour any liquid into an opening. This may cause fire or electrical shock.
13. Never open the equipment. For safety reasons, the equipment should be opened only by qualified service personnel.
14. If one of the following situations arises, get the equipment checked by service personnel:
  - The power cord or plug is damaged.
  - Liquid has penetrated into the equipment.
  - The equipment has been exposed to moisture.
  - The equipment does not work well, or you cannot get it to work according to the user's manual.
  - The equipment has been dropped and damaged.
  - The equipment has obvious signs of breakage.
15. **DO NOT LEAVE THIS EQUIPMENT IN AN ENVIRONMENT WHERE THE STORAGE TEMPERATURE MAY GO BELOW -20° C (-4° F) OR ABOVE 60° C (140° F). THIS COULD DAMAGE THE EQUIPMENT. THE EQUIPMENT SHOULD BE IN A CONTROLLED ENVIRONMENT.**
16. **CAUTION: DANGER OF EXPLOSION IF BATTERY IS INCORRECTLY REPLACED. REPLACE ONLY WITH THE SAME OR EQUIVALENT TYPE RECOMMENDED BY THE MANUFACTURER, DISCARD USED BATTERIES ACCORDING TO THE MANUFACTURER'S INSTRUCTIONS.**

The sound pressure level at the operator's position according to IEC 704-1:1982 is no more than 70 dB (A).

**DISCLAIMER:** This set of instructions is given according to IEC 704-1. Advantech disclaims all responsibility for the accuracy of any statements contained herein.

## Safety Precaution - Static Electricity

Follow these simple precautions to protect yourself from harm and the products from damage.

- To avoid electrical shock, always disconnect the power from your PC chassis before you work on it. Don't touch any components on the CPU card or other cards while the PC is on.
- Disconnect power before making any configuration changes. The sudden rush of power as you connect a jumper or install a card may damage sensitive electronic components.

## Battery Information

Batteries, battery packs, and accumulators should not be disposed of as unsorted household waste.

Please use the public collection system to return, recycle, or treat them in compliance with the local regulations.



# Contents

<b>Chapter 1</b>	<b>General Information .....</b>	<b>1</b>
1.1	Introduction .....	2
1.2	SOM-AB5810 Connectors and Jumper Settings.....	3
1.2.1	SOM-AB5810 Connector Location.....	3
	Figure 1.1 SOM-AB5810 Connector Location (ATX SKU) - Front Side .....	3
	Figure 1.2 SOM-AB5810 Connector Location (ATX SKU) - Back Side .....	4
	Figure 1.3 SOM-AB5810 Connector Location (DC-in SKU) - Front Side .....	4
	Figure 1.4 SOM-AB5810 Connector Location (DC-in SKU) - Back Side .....	5
1.2.2	I/O Connector Location .....	5
1.2.3	Button Location .....	6
1.2.4	Jumper and Switch Location.....	6
	Figure 1.5 SOM-AB5810 Default Jumper Settings .....	7
1.2.5	Connector List.....	8
	Table 1.1: Connector List .....	8
1.2.6	Jumper, Switch and Button List .....	9
	Table 1.2: Jumper, Switch and Button List .....	9
1.2.7	Connector Pin Definition .....	9
	Table 1.3: (GPIO1) GPIO Pin Header .....	9
	Table 1.4: (LPC_PH1) Low Pin Count Pin Header.....	10
	Table 1.5: (LVDS1) LVDS Interface Connector .....	10
	Table 1.6: (LVDS_INVERTER1) LVDS Inverter Wafer Box .....	11
	Table 1.7: (JDCIN1) Wide Range DC Input Connector .....	11
	Table 1.8: (SYS_FAN1) System Fan Connector .....	12
	Table 1.9: (SMART_FAN1) Smart Fan Connector .....	12
	Table 1.10: (I2C1) I2C Wafer Box .....	12
	Table 1.11: (SMB1) SMBus Wafer Box .....	12
	Table 1.12: (COM2) COM Port Connector (RS232/422/485).....	13
	Table 1.13: (COM1) COM Port Connector (RS232).....	13
	Table 1.14: (COM3) COM Port Connector (same signals as COM1) .....	14
	Table 1.15: (CN41) USB 2.0 Port 6 & 7 Pin Header.....	14
	Table 1.16: (CN2&CN3) SATA Power Connector (DC-in SKU only) .....	15
	Table 1.17: (J16) Front Panel Connector .....	15
	Table 1.18: (ATX1) 24 pins ATX Standard Connector .....	16
1.2.8	Jumper Settings .....	16
	Table 1.19: (J2, J3) BIOS Disable0, BIOS Disable1 .....	16
	Table 1.20: (J4) LVDS GND / eDP Hot Plug Selection .....	16
	Table 1.21: (J5) LVDS Inverter Voltage Selection.....	17
	Table 1.22: (J6, J7) LVDS Panel Voltage Selection .....	17
	Table 1.23: (J18) Normal Operation / Clear COMS Selection .....	17
	Table 1.24: (J19) COM2 RS232 / RS422 / RS485 Selection .....	17
	Table 1.25: (J20) mSATA / Mini-PCIe Selection .....	18
	Table 1.26: (SW_LPC_SIO1 & SW_LPC_SIO2) SIO Switch .....	18





# Chapter 1

General Information

---

## 1.1 Introduction

SOM-AB5810 is the newest Mini-ITX application board. Featuring pin-to-pin compatibility with COM Express® Basic and Compact type 6 pin-out CPU modules- compatible Advantech CPU models include SOM-5892 with 3rd Gen. Intel® Core™, SOM-5894, and SOM-6894 with 4th Gen. Intel® Core™. SOM-AB5810 supports both normal and wide-range temperature demands, as well as a choice of ATX power supply or DC-in 19V adapter. SOM-AB5810 is ideal for harsh environments and perfect for outdoor surveillance, industrial automation, digital signage, kiosk applications and much more.

SOM-AB5810 is designed for two different types of power selection- ATX power supply and DC-in 19V via an adapter. An optional ATX power supply can deliver under 47W to the CPU module board (Note: ATX power supply should be more than 200W). For the DC-in 19V adapter power design, it can deliver under 17W to the CPU module. For the I/O interface, SOM-AB5810 supports standard and low profile design types. The standard I/O interface fits with a standard Mini-ITX I/O shielding and standard Mini-ITX chassis without alterations. The low profile I/O interface can meet both standard I/O shielding or customized interface within a low profile chassis design.

Advantech's compact or basic CPU modules for SOM-AB5810 are preloaded with Advantech's SUSIAccess remote device management software and iManager firmware self-management tool, which provides an invaluable suite of programmable APIs such as multi-level watchdog timer, hardware monitoring, and many other intelligent tools that can add greater value to your applications.

## 1.2 SOM-AB5810 Connectors and Jumper Settings

### 1.2.1 SOM-AB5810 Connector Location

#### 1.2.1.1 SOM-AB5810 Connector Location (ATX SKU)

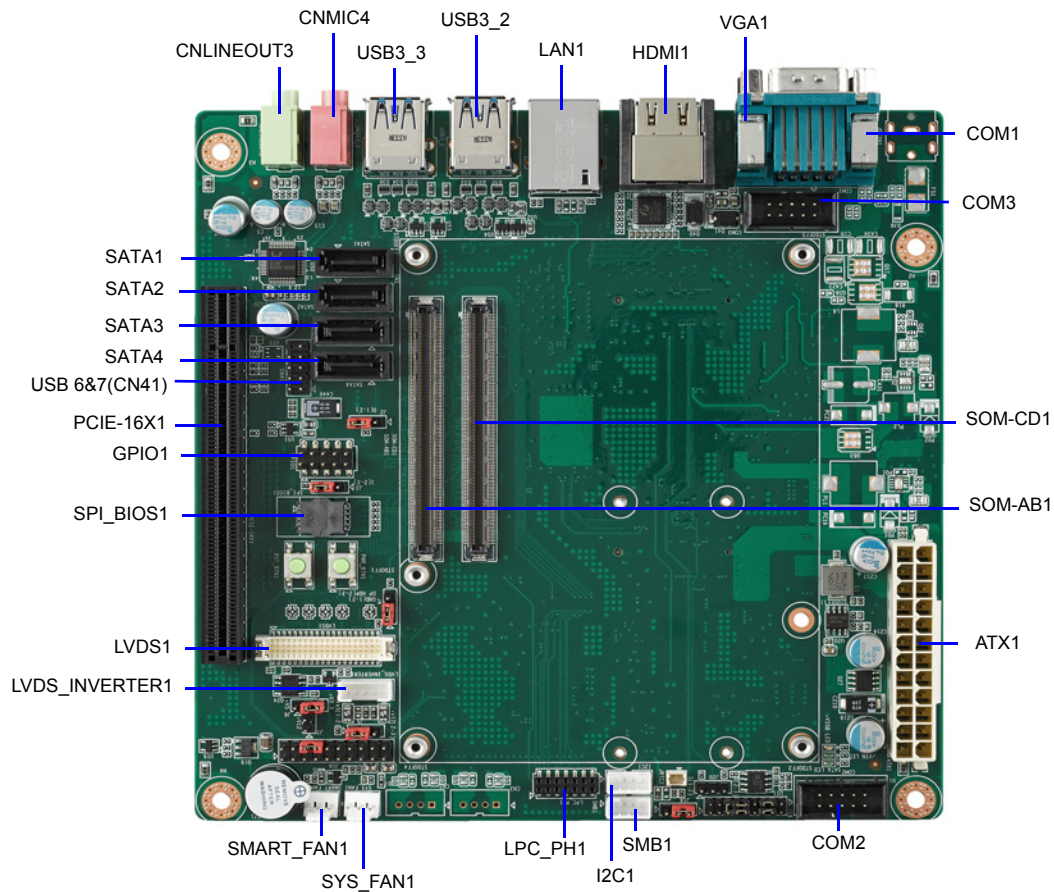


Figure 1.1 SOM-AB5810 Connector Location (ATX SKU) - Front Side

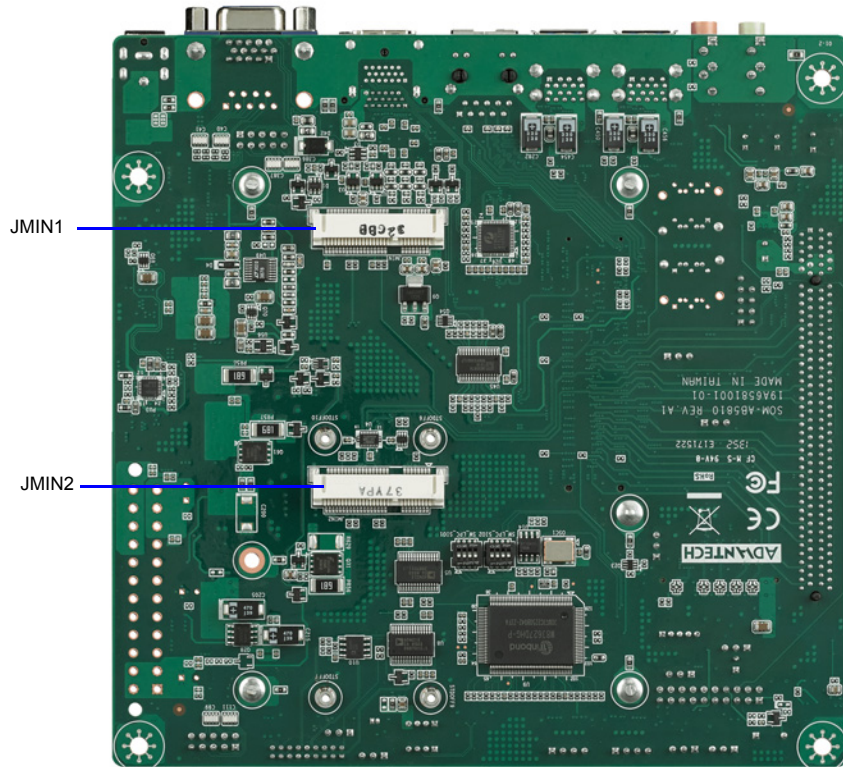


Figure 1.2 SOM-AB5810 Connector Location (ATX SKU) - Back Side

### 1.2.1.2 SOM-AB5810 Connector Location (DC-in SKU)

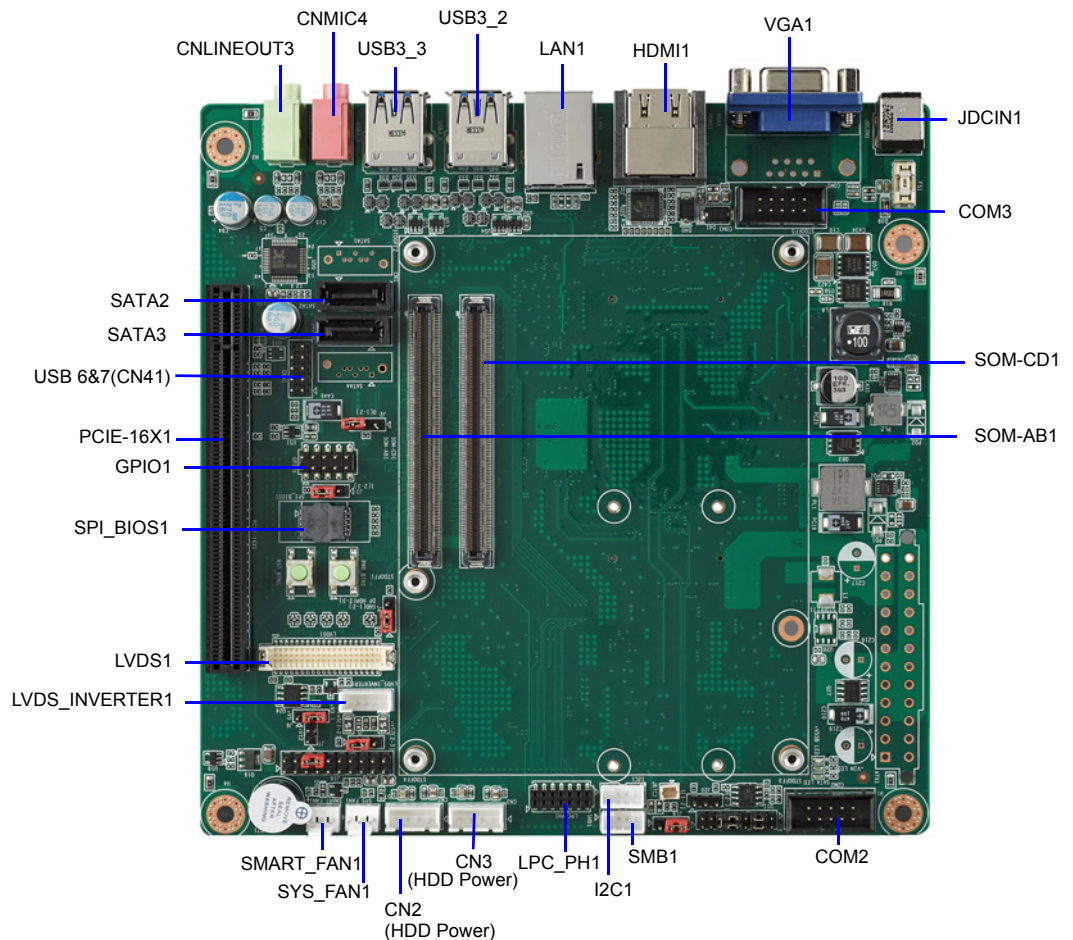


Figure 1.3 SOM-AB5810 Connector Location (DC-in SKU) - Front Side

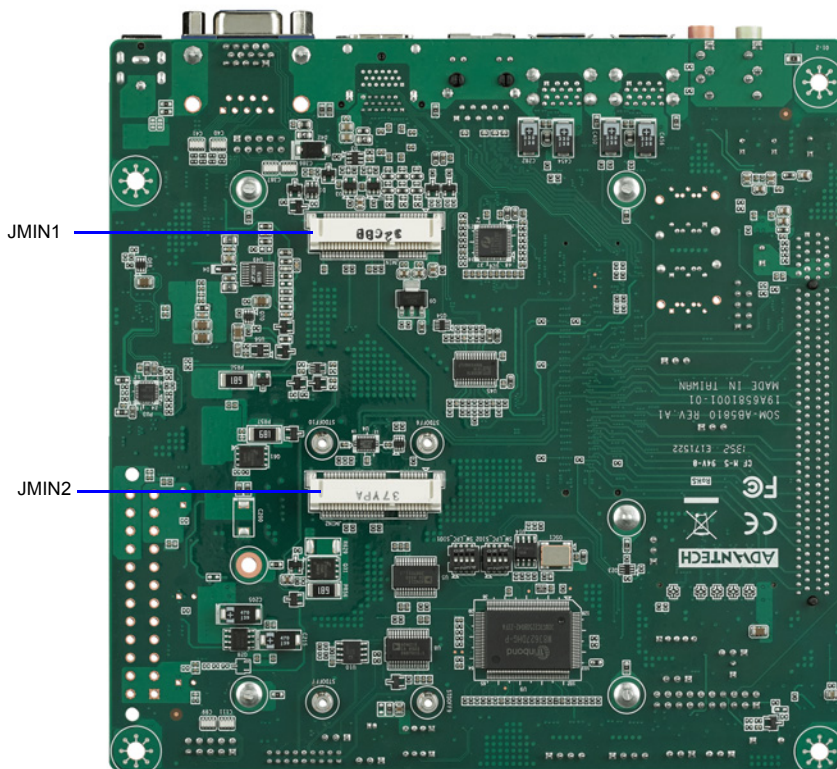
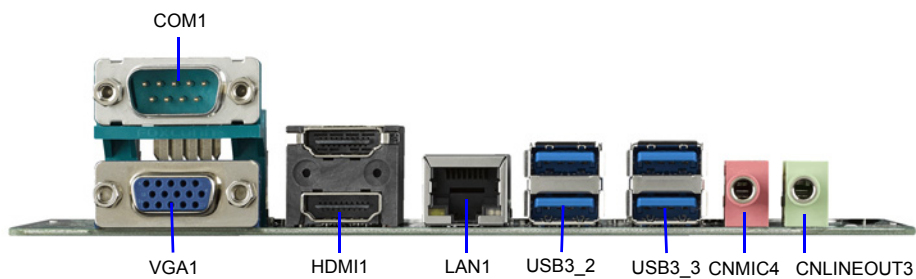


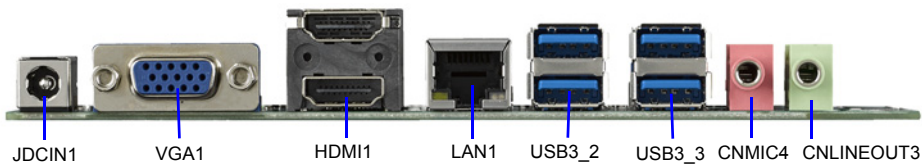
Figure 1.4 SOM-AB5810 Connector Location (DC-in SKU) - Back Side

## 1.2.2 I/O Connector Location

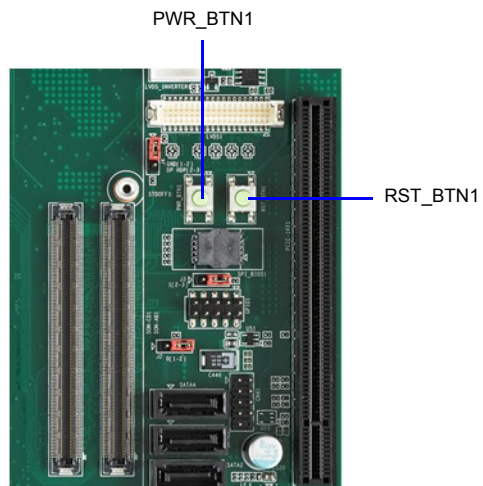
ATX SKU:



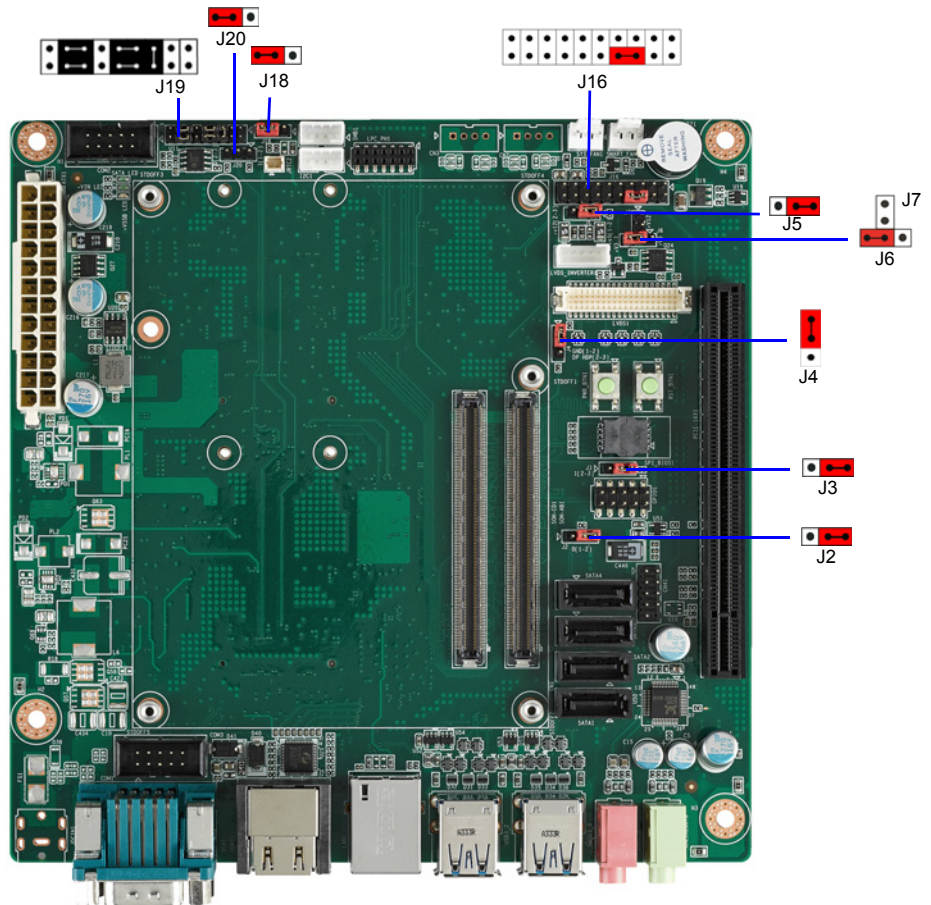
DC-in SKU:



### 1.2.3 Button Location



### 1.2.4 Jumper and Switch Location



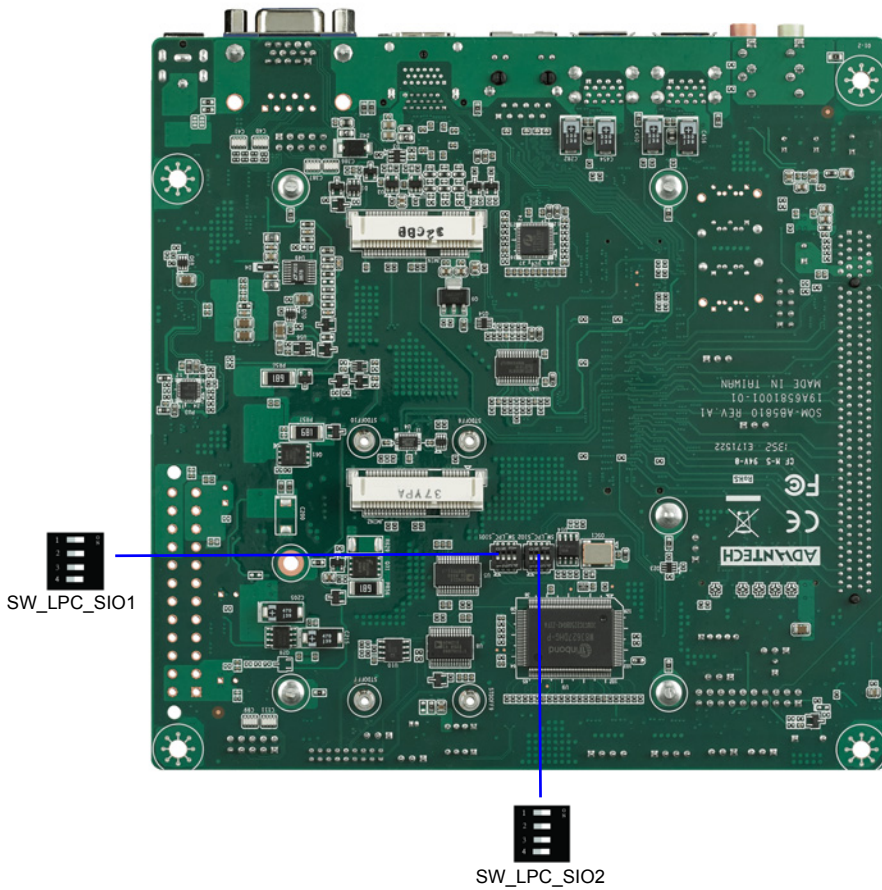


Figure 1.5 SOM-AB5810 Default Jumper Settings

## 1.2.5 Connector List

Table 1.1: Connector List			
Label	Function	Label	Function
ATX1	ATX Connector	JMIN1	Mini-PCle Connector (include USB2.0 Port4)
JDCIN1	DC Power in Connector (DC-in SKU Only)	JMIN2	Mini-PCle Connector (include USB2.0 Port5)
CN2	SATA Power Connector (DC-in SKU Only)	PCIE-16x1	PCle x16 slot (ATX SKU: x16; DC-in SKU: x1)
CN3	SATA Power Connector (DC-in SKU Only)	CNLINEOUT3	Line-out Connector
J16	Front Panel Connector	CNMIC4	Micro Phone Connector
COM1	COM Port Connector (RS232, ATX SKU Only)	SATA1	SATA Connector (ATX SKU Only)
COM2	COM Port Connector (RS232/422/485)	SATA2	SATA Connector
COM3	COM Port Connector (the same port as COM1)	SATA3	SATA Connector
I2C1	I2C Wafer Box	SATA4	SATA Connector (ATX SKU Only)
SMBus	SMBus Wafer Box	USB3_2	USB3.0/2.0 Port0 and Port1 Connector
LPC_PH1	Low Pin Count Pin Header	USB3_3	USB3.0/2.0 Port2 and Port3 Connector
SYS_FAN1	System Fan Connector	HDMI1	HDMI Connector (DDI1& DDI2)
SMART_FAN1	Smart Fan Connector	SOM-AB1	COMe Board to Board Connector (Type 6)
GPIO1	GPIO Pin Header	SOM-CD1	COMe Board to Board Connector (Type 6)
LVDS_INVERTER1	LVDS Inverter Power Wafer Box		
LVDS1	LVDS Interface Connector		
LAN1	LAN Connector		
VGA1	CRT Connector		
SPI_BIOS1	SPI BIOS Socket		
CN41	USB 2.0 Port 6& Port 7 Pin Header		

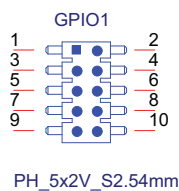


## 1.2.6 Jumper, Switch and Button List

**Table 1.2: Jumper, Switch and Button List**

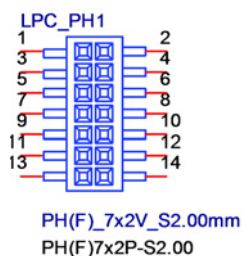
Label	Function
J2, J3	BIOS Selection
J4	LVDS GND / eDP Hot Plug Selection
J5	LVDS Inverter Voltage Selection
J6, J7	LVDS Panel Voltage Selection
J18	Normal Operation / Clear COMS Selection
J19	COM2 RS232 / RS422 / RS485 Selection
J20	mSATA/PCIe Selection
SW_LPC_SIO1-2	SIO Enable/Disable Switch1-2
PWR_BTN1	Power Button
RST_BTN1	Reset Button

## 1.2.7 Connector Pin Definition



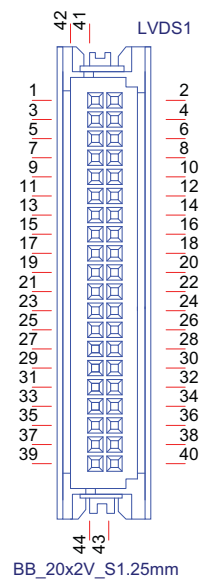
**Table 1.3: (GPIO1) GPIO Pin Header**

Pin	Signal	Pin	Signal
1	GPI0	6	GPO2
2	GPO0	7	GPI3
3	GPI1	8	GPO3
4	GPO1	9	GND
5	GPI2	10	GND



**Table 1.4: (LPC\_PH1) Low Pin Count Pin Header**

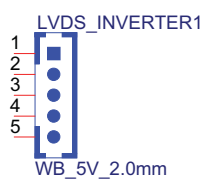
Pin	Signal	Pin	Signal
1	CLK33M_PH	8	GND
2	LPC_AD1	9	LPC_AD2
3	PLTRST#	10	SMB_CLK
4	LPC_AD0	11	SERIRQ
5	LPC_FRAME#	12	SMBDATA
6	+V3.3	13	+V5
7	LPC_AD3	14	+V5

**Table 1.5: (LVDS1) LVDS Interface Connector**

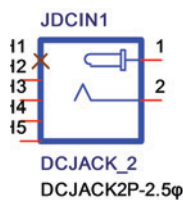
Pin	Signal	Pin	Signal
1	Vin_LVDS_panel	21	LVDS0_Z_D2+
2	Vin_LVDS_panel	22	LVDS1_Z_D2+
3	GND	23	GND
4	GND	24	GND
5	Vin_LVDS_panel	25	LVDS0_Z_CLK-
6	Vin_LVDS_panel	26	LVDS1_Z_CLK-
7	LVDS0_Z_D0-	27	LVDS0_Z_CLK+
8	LVDS1_Z_D0-	28	LVDS1_Z_CLK+
9	LVDS0_Z_D0+	29	GND
10	LVDS1_Z_D0+	30	GND
11	GND	31	LVDS_DDC_SC
12	GND	32	LVDS_DDC_SD

**Table 1.5: (LVDS1) LVDS Interface Connector**

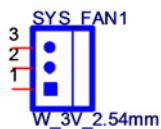
13	LVDS0_Z_D1-	33	GND
14	LVDS1_Z_D1-	34	GND
15	LVDS0_Z_D1+	35	LVDS0_Z_D3
16	LVDS1_Z_D1+	36	LVDS1_Z_D3-
17	GND	37	LVDS0_Z_D3+
18	GND	38	LVDS1_Z_D3+
19	LVDS0_Z_D2-	39	Pull-down via 4.7K ohm to GND
20	LVDS1_Z_D2-	40	LVDS_CTRL

**Table 1.6: (LVDS\_INVERTER1) LVDS Inverter Wafer Box**

Pin	Signal
1	+V12_Z_LVDS
2	GND
3	LVDS_BKLT_Z_EN#
4	LVDS_Z_VBR
5	+V5_LVDS

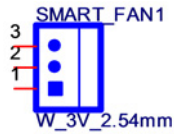
**Table 1.7: (JDCIN1) Wide Range DC Input Connector**

Pin	Signal
1	+VDCIN
2	GND



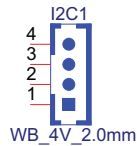
**Table 1.8: (SYS\_FAN1) System Fan Connector**

Pin	Signal
1	GND
2	+V12
3	SYSFAN_IN



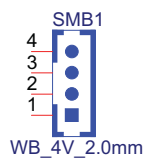
**Table 1.9: (SMART\_FAN1) Smart Fan Connector**

Pin	Signal
1	GND
2	+V_FAN
3	FANTACH_R1



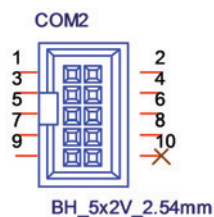
**Table 1.10: (I2C1) I<sup>2</sup>C Wafer Box**

Pin	Signal
1	GND
2	I2C_DAT
3	I2C_CLK
4	+V3.3



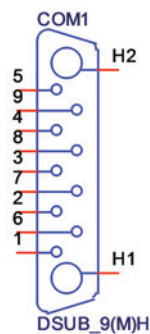
**Table 1.11: (SMB1) SMBus Wafer Box**

Pin	Signal
1	GND
2	SMB_DAT
3	SMB_CLK
4	+V3.3

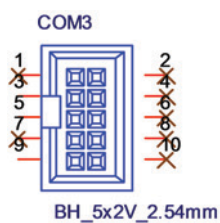


**Table 1.12: (COM2) COM Port Connector (RS232/422/485)**

Pin	Signal	Pin	Signal
1	COM2_DCD#	6	COM2_CTS#
2	COM2_DSR#	7	COM2_DTR#
3	COM2_RXD	8	COM2_RI#
4	COM2_RTS#	9	GND
5	COM2_TXD	10	NC

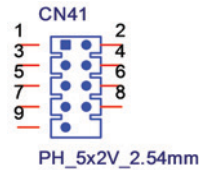
**Table 1.13: (COM1) COM Port Connector (RS232)**

Pin	Signal	Pin	Signal
1	COM1_z_DCD#	6	COM1_z_DSR#
2	COM1_z_RXD	7	COM1_z_RTS#
3	COM1_z_TXD	8	COM1_z_CTS#
4	COM1_z_DTR#	9	COM1_z_RI#
5	GND		



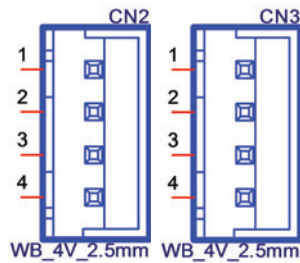
**Table 1.14: (COM3) COM Port Connector (same signals as COM1)**

Pin	Signal	Pin	Signal
1	COM1_DCD#	6	COM1_CTS#
2	COM1_DSR#	7	COM1_DTR#
3	COM1_RXD	8	COM1_RI#
4	COM1_RTS#	9	GND
5	COM1_TXD	10	NC



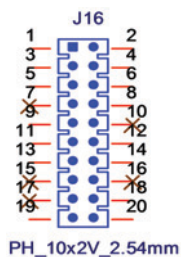
**Table 1.15: (CN41) USB 2.0 Port 6 & 7 Pin Header**

Pin	Signal	Pin	Signal
1	5V	6	USB7_P+
2	5V	7	GND
3	USB6_P-	8	GND
4	USB7_P-	9	GND
5	USB6_P+		



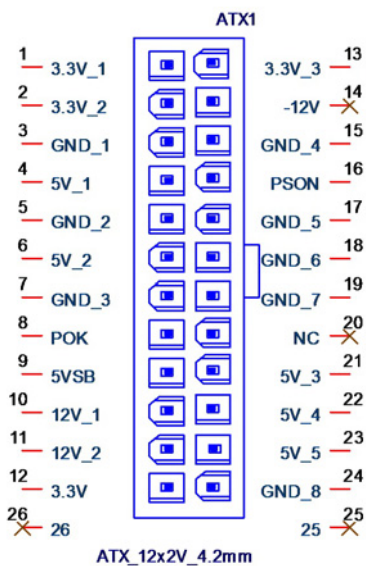
**Table 1.16: (CN2&CN3) SATA Power Connector (DC-in SKU only)**

Pin	Signal
1	5V
2	GND
3	GND
4	12V



**Table 1.17: (J16) Front Panel Connector**

Pin	Function
3-5	Power LED (Pin3 is positive)
6-8	Buzzer Enable (Default enable)
12-14	HDD LED (Pin14 is positive)
11-13	Power Button
18-20	Reset Button



**Table 1.18: (ATX1) 24 pins ATX Standard Connector**

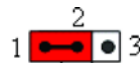
Pin	Signal	Pin	Signal
1	+V3.3	13	+V3.3
2	+V3.3	14	NC
3	GND	15	GND
4	+V5	16	PSON
5	GND	17	GND
6	+V5	18	GND
7	GND	19	GND
8	ATX_PWROK	20	NC
9	+V5SB	21	+V5
10	+V12	22	+V5
11	+V12	23	+V5
12	+V3.3	24	GND

## 1.2.8 Jumper Settings



**Table 1.19: (J2, J3) BIOS Disable0, BIOS Disable1**

BIOS_DIS1# (J3)	BIOS_DIS0# (J2)	Chipset SPI CS1# Destination	Chipset SPI CS0# Destination	Carrier SPI_CS#	SPI Descriptor	BIOS Entry
2-3 (1)	2-3 (1)	Module	Module	High	Module	SPI0/SPI1 [Default]
2-3 (1)	1-2 (0)	Module	Module	High	Module	Carrier FWH
1-2 (0)	2-3 (1)	Module	Carrier	SPI0	Carrier	SPI0/SPI1
1-2 (0)	1-2 (0)	Carrier	Module	SPI1	Module	SPI0/SPI1



**Table 1.20: (J4) LVDS GND / eDP Hot Plug Selection**

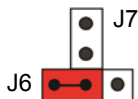
Pin	Function
1-2	LVDS GND [Default]
2-3	eDP Hot Plug





**Table 1.21: (J5) LVDS Inverter Voltage Selection**

Pin	Function
1-2	+V5 [Default]
2-3	+V12



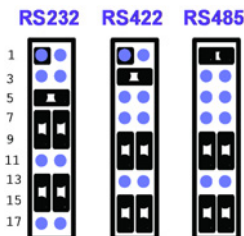
**Table 1.22: (J6, J7) LVDS Panel Voltage Selection**

Pin	Function
J6 1-2	+V5
J6 2-3	+V3.3 [Default]
J6 & J7 2-2	+V12



**Table 1.23: (J18) Normal Operation / Clear COMS Selection**

Pin	Function
1-2	Clear CMOS
2-3	Normal Operation [Default]



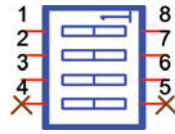
**Table 1.24: (J19) COM2 RS232 / RS422 / RS485 Selection**

Pin	Function
5-6, 7-9, 8-10 , 13-15, 14-16	RS232 [Default]
3-4, 9-11, 10-12, 15-17, 16-18	RS422
1-2, 9-11, 10-12, 15-17, 16-18	RS485



**Table 1.25: (J20) mSATA / Mini-PCle Selection**

<b>J10</b>	<b>Function</b>
1-2	mSATA
2-3	Mini-PCle [Default]



**Table 1.26: (SW\_LPC\_SIO1 & SW\_LPC\_SIO2) SIO Switch**

<b>Dip Switch</b>	<b>1-8</b>	<b>2-7</b>	<b>3-6</b>	<b>4-5</b>	<b>Function</b>
SW_LPC_SIO1~2	ON	ON	ON	ON	SIO Enable [Default]
	OFF	OFF	OFF	OFF	SIO Disable



**ADVANTECH**

*Enabling an Intelligent Planet*

**[www.advantech.com](http://www.advantech.com)**

Please verify specifications before quoting. This guide is intended for reference purposes only.

All product specifications are subject to change without notice.

No part of this publication may be reproduced in any form or by any means, electronic, photocopying, recording or otherwise, without prior written permission of the publisher.

All brand and product names are trademarks or registered trademarks of their respective companies.

© Advantech Co., Ltd. 2014

## Free Manuals Download Website

<http://myh66.com>

<http://usermanuals.us>

<http://www.somanuals.com>

<http://www.4manuals.cc>

<http://www.manual-lib.com>

<http://www.404manual.com>

<http://www.luxmanual.com>

<http://aubethermostatmanual.com>

Golf course search by state

<http://golfingnear.com>

Email search by domain

<http://emailbydomain.com>

Auto manuals search

<http://auto.somanuals.com>

TV manuals search

<http://tv.somanuals.com>