



L 75280 FL
L 75480 FL

EN User manual



 **AEG**
perfekt in form und funktion

CONTENTS

1. SAFETY INFORMATION	3
2. SAFETY INSTRUCTIONS	3
3. TECHNICAL INFORMATION	5
4. PRODUCT DESCRIPTION	6
5. CONTROL PANEL	7
6. PROGRAMMES	10
7. BEFORE FIRST USE	13
8. USING THE APPLIANCE	13
9. HINTS AND TIPS	17
10. CARE AND CLEANING	18
11. TROUBLESHOOTING	23
12. INSTALLATION	25
13. ENVIRONMENT CONCERNS	31

FOR PERFECT RESULTS

Thank you for choosing this AEG product. We have created it to give you impeccable performance for many years, with innovative technologies that help make life simpler – features you might not find on ordinary appliances. Please spend a few minutes reading to get the very best from it.

Visit our website for:



Get usage advice, brochures, trouble shooter, service information:
www.aeg.com



Register your product for better service:
www.aeg.com/productregistration



Buy Accessories, Consumables and Original spare parts for your appliance:
www.aeg.com/shop

CUSTOMER CARE AND SERVICE

We recommend the use of original spare parts.
When contacting Service, ensure that you have the following data available.
The information can be found on the rating plate. Model, PNC, Serial Number.



Warning / Caution-Safety information



General information and tips



Environmental information

Subject to change without notice.

1. SAFETY INFORMATION

Before the installation and use of the appliance, carefully read the supplied instructions. The manufacturer is not responsible if an incorrect installation and use causes injuries and damages. Always keep the instructions with the appliance for future reference.

1.1 Children and vulnerable people safety



WARNING!

Risk of suffocation, injury or permanent disability.

- Do not let persons, children included, with reduced physical sensory, reduced mental functions or lack of experience and knowledge use the appliance. They must have supervision or instruction for the operation of the appliance by a person who is responsible for their safety.
- Do not let children play with the appliance.
- Keep all packaging away from children.
- Keep all detergents away from children.
- Keep children and pets away from the appliance door when it is open.
- If the appliance has a child safety device, we recommend you activate it.

1.2 General Safety

- Before maintenance, deactivate the appliance and disconnect the mains plug from the mains socket.
- Do not change the specification of this appliance.
- Obey the maximum load volume of 8 kg (refer to the "Programme chart" chapter).

2. SAFETY INSTRUCTIONS

2.1 Installation

- Remove all the packaging and the transit bolts.
- Keep the transit bolts. When you move the appliance again you must block the drum.
- Do not install or use a damaged appliance.
- Do not install or use the appliance where the temperature is less than 0 °C or where it is exposed to the weather.
- Obey the installation instruction supplied with the appliance.
- Make sure that the floor where you install the appliance is flat, stable, heat resistant and clean.
- Do not install the appliance where the appliance door can not be fully opened.
- Always be careful when you move the appliance because it is heavy. Always wear safety gloves.
- Make sure that there is air circulation between the appliance and the floor.
- Adjust the feet to have the necessary space between the appliance and the carpet.

Electrical connection



WARNING!

Risk of fire and electrical shock.

- The appliance must be earthed.
- Make sure that the electrical information on the rating plate agrees with the power supply. If not, contact an electrician.
- Always use a correctly installed shock-proof socket.
- Do not use multi-plug adapters and extension cables.
- Make sure not to cause damage to the mains plug and to the mains cable. Should the appliance power supply cable need to be replaced, this must be carried out by our Service Centre.
- Connect the mains plug to the mains socket only at the end of the installation. Make sure that there is access to the mains plug after the installation.

- Do not pull the mains cable to disconnect the appliance. Always pull the mains plug.
- Do not touch the mains cable or the mains plug with wet hands.
- This appliance complies with the E.E.C. Directives.

Water connection

- Make sure not to cause damage to the water hoses.
- The appliance is to be connected to the water mains using the new supplied hose-sets. Old hose sets must not be reused.
- Before you connect the appliance to new pipes or pipes not used for a long time, let the water flow until it is clean.
- The first time you use the appliance, make sure that there is no leakage.

2.2 Use



WARNING!

Risk of injury, electrical shock, fire, burns or damage to the appliance.

- Use this appliance in a household environment.
- Do not change the specification of this appliance.
- Obey the safety instructions on the detergent packaging.
- Do not put flammable products or items that are wet with flammable products in, near or on the appliance.
- Do not touch the glass of the door while a programme operates. The glass can be hot.
- Make sure that you remove all metal objects from the laundry.
- Do not put a container to collect possible water leakage under the appliance. Contact the Service to ensure which accessories can be used.

2.3 Care and Cleaning



WARNING!

Risk of injury or damage to the appliance.

- Before maintenance, deactivate the appliance and disconnect the mains plug from the mains socket.
- Do not use water spray and steam to clean the appliance.
- Clean the appliance with a moist soft cloth. Only use neutral detergents. Do not use abrasive products, abrasive cleaning pads, solvents or metal objects.
- Disconnect the appliance from the mains supply.
- Cut off the mains cable and discard it.
- Remove the door catch to prevent children and pets to get closed in the appliance.

2.4 Disposal



WARNING!

Risk of injury or suffocation.

3. TECHNICAL INFORMATION

Dimensions	Width / Height / Depth	600 / 850 / 605 mm
	Total depth	640 mm
Electrical connection:	Voltage	230 V
	Overall power	2200 W
	Fuse	10 A
	Frequency	50 Hz
Level of protection against ingress of solid particles and moisture ensured by the protective cover, except where the low voltage equipment has no protection against moisture		IPX4
Water supply pressure	Minimum	0,5 bar (0,05 MPa)
	Maximum	8 bar (0,8 MPa)
Water supply ¹⁾		Cold water
Maximum load	Cotton	8 kg
Spin speed	Maximum	1200 rpm (L 75280 FL)
		1400 rpm (L 75480 FL)

¹⁾ Connect the water inlet hose to a water tap with a 3/4" thread.

4. PRODUCT DESCRIPTION

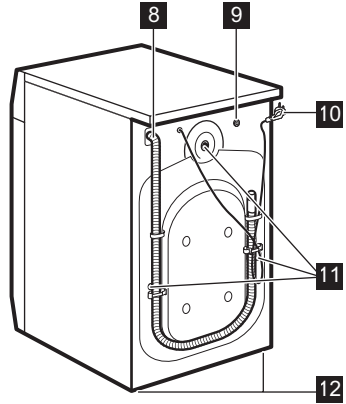
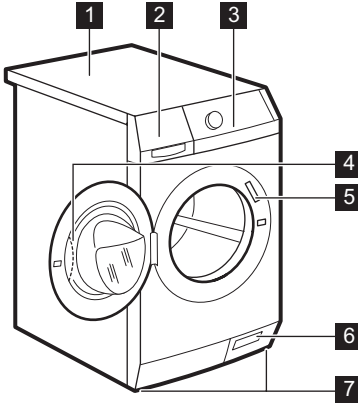

- 1** Worktop
- 2** Detergent dispenser
- 3** Control panel
- 4** Door handle
- 5** Rating plate
- 6** Drain pump
- 7** Feet for the appliance level

- 8** Water drain hose
- 9** Water inlet valve
- 10** Mains cable
- 11** Transit bolts
- 12** Feet for the appliance level

4.1 Accessories

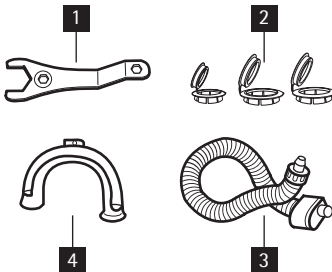

- 1** **Spanner**
To remove the transit bolts.
- 2** **Plastic caps**
To close the holes on the rear side of the cabinet after the removal of the transit bolts.
- 3** **Anti-flood inlet hose**
To prevent possible leakage
- 4** **Plastic hose guide**
To connect the drain hose on the edge of a sink.

5. CONTROL PANEL

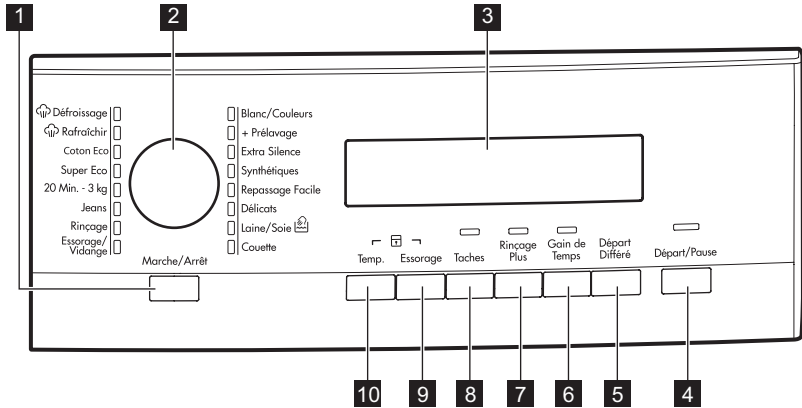

- 1** On/Off button (**Marche/Arrêt**)
- 2** Programme knob
- 3** Display
- 4** Start/Pause button (**Départ/Pause**)
- 5** Delay start button (**Départ Différé**)
- 6** Time saving button (**Gain de Temps**)
- 7** Extra rinse button (**Rinçage Plus**)
- 8** Stain button (**Taches**)
- 9** Spin reduction button (**Essorage**)
- 10** Temperature button (**Temp.**)

The AUTO Stand-by function automatically deactivates the appliance to decrease the energy consumption when:

- You do not use the appliance for 5 minutes before you press button **4**.
 - All settings are cancelled.
 - Press button **1** to activate the appliance again.
 - Set again the washing programme and all possible options.
- After 5 minutes from the end of the washing programme. Refer to 'At the end of programme'.

5.1 On Off button **1**

Press this button to activate or deactivate the appliance. A tune sounds when the appliance is activated.

5.2 Programme knob **2**







Turn this knob to set a programme. The related programme indicator comes on.

5.3 Display **3**



The display shows:

- | | |
|----------|---|
| A | • The maximum temperature of the programme. |
| B | • The default spin speed of the programme.
• 'No Spin' ¹⁾ and 'Rinse Hold' symbols. |

C	
Symbols	Description
	Washing phase
	Rinse phases
	Spin phase
	Child lock
	<p>You cannot open the appliance door when the symbol is on. You can open the door only when the symbol goes off.</p> <p>If the programme is completed but the symbol stays on:</p> <ul style="list-style-type: none"> • There is water in the drum. • The 'Rinse Hold' function is on.
	Delay start
D	
	<ul style="list-style-type: none"> • The programme time When the programme starts, the time decreases with steps of 1 minute. • The delay start When you press the delay start button, the display shows the delay start time. • Alarm codes If the appliance has a malfunction, the display shows alarm codes. Refer to 'Troubleshooting' chapter. • Err The display shows this message for some seconds if: <ul style="list-style-type: none"> – You set a function that is not applicable for the programme. – You change the programme while it operates. The indicator of the Start/Pause button 4 flashes. •  When the programme is completed.

1) Only available for Spin/Drain programme.

2) The symbols appear on the display when the related phase or function is set.

5.4 Start/Pause button **4**

Press button **4** to start or interrupt a programme.

5.5 Delay start button **5**

Press button **5** to delay the start of a programme from 30 minutes to 20 hours.

5.6 Time save button **6**

Press the button **6** to decrease the programme duration.

- Press one time to set 'Shortened duration' for items with daily soil.
- Press two times to set 'Extra Quick' for items with almost no soil.



Some programmes accept only one of the two functions.

5.7 Extra rinse button

Press button  to add rinsing phases to a programme.

Use this function for persons allergic to detergents and in areas where the water is soft.

5.8 Stain button

Press button  to add the stain phase to a programme.

Use this function for laundry with hard stains to remove.

When you set this function, put the stain remover into compartment .

 This function increases the programme duration.
This function is not available with a temperature lower than 40° C.



5.9 Spin button

Press this button to:

- Decrease the maximum speed of the spin phase when you set a programme.

 The display shows only the spin speeds available with the set programme.

- Deactivate the spin phase.
- Activate the 'Rinse Hold' function. Set this function to prevent fabric creases. The appliance does not drain the water when the programme is completed.

	Spin phase is off.
	'Rinse Hold' function is on.



5.10 Temperature button

Press button  to change the default temperature.

--	= cold water
----	--------------

5.11 Acoustic signals function







You can hear the acoustic signals when:

- You activate the appliance.
 - You deactivate the appliance.
 - You press the buttons.
 - The programme is completed.
 - The appliance has a malfunction.
- To **deactivate/activate** the acoustic signals, press button  and button  at the same time for 6 seconds.



 If you deactivate the acoustic signals, they continue operate only when you press the buttons and when a malfunction occurs.

5.12 Child lock function

This function prevents children to play with the control panel.







- To activate the function, press button  and button  at the same time until the display shows the symbol .
- To deactivate the function, press button  and button  at the same time until the symbol  goes off.

You can activate the function:

- Before you press the Start/Pause button : the appliance cannot start.
- After you press the Start/Pause button , all the buttons and the programme knob are deactivated.

5.13 Permanent extra rinse function

With this function you can keep the extra rinse function permanently on when you set a new programme.

- To activate the function press button  and button  at the same time until the indicator of button  is on.
- To deactivate the function press button  and button  at the same time until the indicator of button  is off.

6. PROGRAMMES

Programme Temperature	Type of load max. weight of load	Cycle description	Functions
Blanc/Couleurs 95° - Cold	White and coloured cotton with normal soil. max. 8 kg	Wash Rinses Long spin	SPIN REDUC-TION RINSE HOLD STAIN ¹⁾ EXTRA RINSE TIME SAVE ²⁾
Blanc/Couleurs + Prélavage 95° - Cold	White and coloured cotton with heavy soil. max. 8 kg	Prewash Wash Rinses Long spin	SPIN REDUC-TION RINSE HOLD STAIN EXTRA RINSE TIME SAVE ²⁾
Extra Silence Extra Silent 95° - Cold	White and coloured cotton with normal soil. max. 8 kg	Stop with water in the drum Rinses Long spin	STAIN EXTRA RINSE TIME SAVE ²⁾
Synthétiques 60° - Cold	Synthetic or mixed fabric items with normal level of soil. max. 4 kg	Wash Rinses Short spin	SPIN REDUC-TION RINSE HOLD STAIN ¹⁾ EXTRA RINSE TIME SAVE ²⁾
Repassage Facile³⁾ 60° - Cold	Synthetic fabric items with normal soil. max. 4 kg	Wash Rinses Short spin	RINSE HOLD EXTRA RINSE TIME SAVE
Déliçats 40° - Cold	Delicate fabrics as acrylics, viscose, polyester items with normal soil. max. 4 kg	Wash Rinses Short spin	SPIN REDUC-TION RINSE HOLD STAIN ¹⁾ EXTRA RINSE TIME SAVE ²⁾
Laine / Soie 40° - Cold	Machine washable wool. Hand washable wool and delicate fabrics with «hand washing» care symbol. max. 2 kg	Wash Rinses Short spin	SPIN REDUC-TION RINSE HOLD
Couette 60° - 30°	One synthetic blanket, duvet, bed-spread and so on. max. 3 kg	Wash Rinses Short spin	SPIN REDUC-TION

Programme Temperature	Type of load max. weight of load	Cycle description	Functions
Essorage / Vi- dange⁴⁾	All fabrics The maximum load of the laundry is re- lated to the type of laundry.	Drainage of the water Spin phase at the maximum speed.	SPIN REDUC- TION NO SPIN
Rinçage Cold	Hand washing items.	Rinses Long spin	SPIN REDUC- TION RINSE HOLD EXTRA RINSE ⁵⁾
Jeans 60° - Cold	All items in jeans. Jersey made items with hi-tech materi- als. max. 4 kg	Wash Rinses Short spin	SPIN REDUC- TION RINSE HOLD EXTRA RINSE TIME SAVE ²⁾
20 Min. - 3 Kg 30°	Cotton and synthet- ic items with light soil or worn only one time.	Wash Rinses Short spin	SPIN REDUC- TION
Super Eco⁶⁾ Cold	Mixed fabrics (cot- ton and synthetic items). max. 3 kg	Wash Rinses Long spin	SPIN REDUC- TION RINSE HOLD EXTRA RINSE
Coton Eco⁷⁾ 60° - 40° ⁸⁾	White and fast col- oured cotton with normal soil. max. 8 kg	Wash Rinses Long spin	SPIN REDUC- TION RINSE HOLD STAIN EXTRA RINSE TIME SAVE

1) The Stain function is not available with a temperature lower than 40°C.

2) if you set the Extra Quick function, we recommend you to decrease the quantity of the load. It is possible to keep the full load but the washing results are not good.

3) The wash and spin phase is soft to prevent the creases of the laundry. The appliance adds some rinses.

4) The default phase of the spin speed is related to cotton items. Set the spin speed. Make sure that it agrees with the laundry.

5) Press EXTRA RINSE button to add rinses. With a low spin speed the appliance performs delicate rinses and a short spin.



6) Set this programme to decrease the time and the consumption of energy and water. Use a special detergent for very low temperature.

7) Set this programme to have a good washing results and decrease the energy consumption. The time of the washing programme is extended.

8) Standard programmes for the Energy Label consumption values. According to regulation 1061/2010, the «Coton Eco 60 °C» and «Coton Eco 40 °C» are respectively the «standard 60 °C cotton programme» and the «standard 40 °C cotton programme». Set this programme to have a good washing results and decrease the energy consumption. The time of the washing programme is extended.

 The washing temperature of the washing phase may differ from the temperature declared for the selected programme.

STEAM PROGRAMMES

Programme ¹⁾	Type of load	Max. load
Steam Rafrāichir This cycle removes odours from the laundry.		up to 1.5 Kg
 Steam does not remove animal odours.	Cotton and synthetic items.	
Steam Défroissage This programme helps to dewrinkle the laundry.		up to 1.5 Kg
 Steam can be used for dried, washed or worn once laundry. These programmes can reduce creases and odours and make your laundry more smooth. Do not use any detergent. If necessary, remove stains by washing or using localized stain removal. Steam programmes do not perform any hygienic cycle.		
Do not set the Steam programme for this type of clothes: <ul style="list-style-type: none"> • Clothes which is not specified on the care label as being suitable for tumble-drying. • Clothes with inclusion of plastic, metal, wooden parts or alike. 		

¹⁾ If you set a Steam programme with dried laundry, at the end of the cycle the laundry feels humid. It is better to expose clothes to the fresh air for about 10 minutes to let the humidity dry. Laundry should be removed from the drum as quick as possible. After a steam cycle, clothes may to be ironed anyway, but with less effort!

6.1 Consumption values

 The data of this table are approximate. Different causes can change the data: the quantity and type of laundry, the water and ambient temperature.

Programmes	Load (kg)	Energy consumption (kWh)	Water consumption (litre)	Approximate programme duration (minutes)	Remaining moisture (%) ¹⁾	
					L 75280 FL	L 75480 FL
Cottons 60 °C	8	1.60	72	168	53	52
Cottons 40 °C	8	1.00	72	164	53	52
Synthetics 40 °C	4	0.60	50	110	35	35
Delicates 40 °C	4	0.70	60	91	35	35
Wool/Hand wash 30 °C	2	0.35	57	58	30	30

Programmes	Load (kg)	Energy consumption (kWh)	Water consumption (litre)	Approximate programme duration (minutes)	Remaining moisture (%) ¹⁾ L 75280 FL	Remaining moisture (%) ¹⁾ L 75480 FL
Standard cotton programmes						
Standard 60 °C cotton	8	1.04	46	208	53	52
Standard 60 °C cotton	4	0.65	45	156	53	52
Standard 40 °C cotton	4	0.50	44	156	53	52

1) At the end of spin phase.

Off Mode (W)	Left-On Mode (W)
0.6	0.6

The values of power consumption of the «Off-mode » and «Left-on mode» are in compliance with the EU Commission regulation 1015/2010 implementing directive 2009/125/EC.

7. BEFORE FIRST USE

1. To activate the drain system, put 2 litre of water in the main wash compartment of the detergent dispenser.
2. Put a small quantity of detergent in the main wash compartment of the

detergent dispenser. Set and start a programme for cotton at the highest temperature without laundry. This removes all possible dirt from the drum and the tub.

8. USING THE APPLIANCE

1. Open the water tap.
2. Connect the mains plug to the mains socket.
3. Press button **1** to activate the appliance.
4. Put the laundry in the appliance.
5. Use the correct quantity of detergent and additives.
6. Set and start the correct programme for the type of laundry and soil.

8.1 Loading the laundry



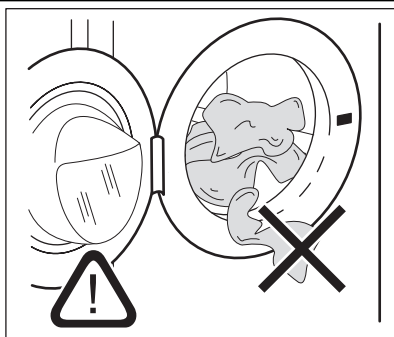



1. Open the appliance door.
2. Put the laundry in the drum, one item at a time. Shake the items before you put them in the appliance. Make sure not to put too much laundry in the drum.
3. Close the door.

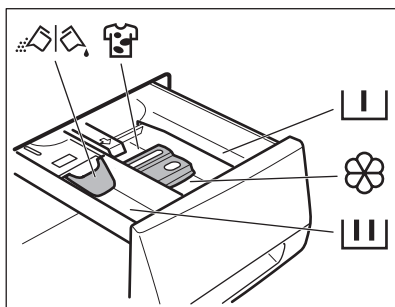

Make sure that no laundry stays between the seal and the door. There is a risk of water leakage or damage to the laundry.

8.2 Filling the detergent and additives



	<p>The detergent compartment for the prewash phase and the soak programme. Add the detergent for prewash and soak before the start of the programme.</p>
	<p>The detergent compartment for the washing phase. If you use a liquid detergent, put it immediately before you start the programme.</p>
	<p>Liquid additives compartment (fabric conditioner, starch). Put the product in the compartment before you start the programme.</p>
<p>MAX</p>	<p>This is the maximum level for the quantity of liquid additives.</p>
	<p>The compartment for the stain remover. Put the product in the compartment and set the stain function before you start the programme.</p>
	<p>Flap for powder or liquid detergent Turn it (up or down) in the correct position to use powder or liquid detergent.</p>
	<p>Always obey the instructions that you find on the packaging of the detergent products.</p>

Check the position of the flap

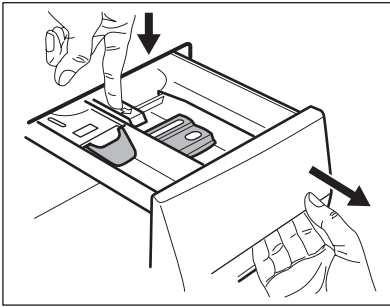

1. Pull out the detergent dispenser until it stops.
2. Press the lever down to remove the dispenser.

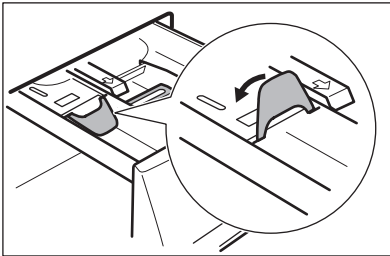

3. To use powder detergent, turn the flap up.

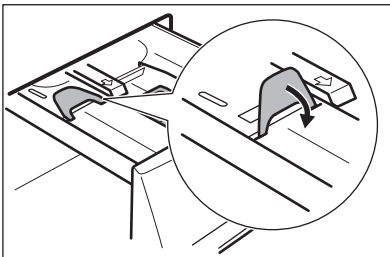

4. To use liquid detergent, turn the flap down.



With the flap in the position DOWN:

- Do not use gelatinous or thick liquid detergents.
- Do not put more liquid detergent than the limit showed in the flap.
- Do not set the prewash phase.
- Do not set the delay start function.

5. Measure out the detergent and the fabric conditioner.
6. Carefully close the detergent dispenser. Make sure that the flap does not cause a blockage when you close the drawer.

8.3 Setting and starting a programme

1. Turn the programme knob. The related programme indicator comes on.
2. The indicator of button **4** flashes with red colour.
3. The display shows the default temperature and spin speed. To change the temperature and/or the spin speed, press the related buttons.
4. Set the available functions. The indicator of the set function comes on or the display shows the related symbol.

- Press button **4** to start the programme. The indicator of button **4** is on.

 The drain pump can operate for a short time when the appliance fills water.

 The appliance adjust automatically the cycle time to the laundry you have put in the drum to have perfect washing results in the minimum necessary time. After approximately 15 minutes from the start of the programme, the display shows the new time value.

8.4 Interrupt a programme

- Press button **4**. The indicator flashes.
- Press button **4** again. The washing programme continues.

8.5 Cancel a programme

- Press button **1** to cancel the programme and to deactivate the appliance.
- Press button **1** again to activate the appliance. Now, you can set a new washing programme.

 The appliance does not drain the water.

8.6 Change a function

You can change only some functions before they operate.

- Press button **4**. The indicator flashes.
- Change the function set.

8.7 Set the delay start

- Press button **5** again and again until the display shows the number of minutes or hours. The related symbols comes on.
- Press button **4**, the appliance starts the countdown of the delay start.

When the countdown is completed, the programme starts automatically.

 Before you press button **4** to start the appliance, you can cancel or change the set of the delay start.

You cannot set the delay start with the **Steam** programme.

8.8 Cancel the delay start

- Press button **4**. The related indicator flashes.
- Press button **5** again and again until the display shows **0'**.
- Press button **4**. The programme starts.

8.9 Open the door

While a programme or the delay start operates, the appliance door is locked.

To open the appliance door:

- Press button **4**. The door lock symbol in the display goes off.
- Open the appliance door.
- Close the appliance door and press button **4**. The programme or the delay start continues.

 If the temperature and level of the water in the drum are too high, the door lock symbol stays on and you cannot open the door. To open the door do the steps that follow:

- Deactivate the appliance.
- Wait for some minutes.
- Make sure that no water is in the drum.



If you deactivate the appliance, it is necessary to set the programme again.

8.10 At the end of the programme

- The appliance stops automatically.
- The acoustic signals operate.
- In the display  comes on.
- The indicator of the Start/Pause button **4** goes off.

- The door lock symbol goes off.
- Press button **1** to deactivate the appliance. After five minutes from the end of the programme, the energy saving function automatically deactivates the appliance.



When you activate the appliance again, the display shows the end of the last set programme. Turn the programme knob to set a new cycle.

- Remove the laundry from the appliance. Make sure that the drum is empty.
- Keep the door ajar, to prevent mildew and odours.
- Close the water tap.

The washing programme is completed, but there is water in the drum:

- The drum turns regularly to prevent the creases in the laundry.

- The door stays locked.
- You must drain the water to open the door.

To drain the water:

1. If necessary, decrease the spin speed.
2. Press the Start/Pause button **4**. The appliance drains the water and spins.
3. When the programme is completed and the door lock symbol goes off, you can open the door.
4. Deactivate the appliance.



The appliance drains and spins automatically after approximately 18 hours.

9. HINTS AND TIPS

9.1 The laundry load

- Divide the laundry in: white, coloured, synthetics, delicates and wool.
- Obey the washing instructions that are on the laundry care labels.
- Do not wash together white and coloured items.
- Some coloured items can discolour with the first wash. We recommend that you wash them separately for the first times.
- Button up pillowcases, close zippers, hooks and poppers. Tie up belts.
- Empty the pockets and unfold the items.
- Turn inside out multilayered fabrics, wool and items with painted illustrations.
- Remove hard stains.
- Wash with a special detergent heavy soil stains.
- Be careful with the curtains. Remove the hooks or put the curtains in a washing bag or pillowcase.

- Do not wash in the appliance :
 - Laundry without hems or with cuts
 - Underwired bras.
 - Use a washing bag to wash small items.
- A very small load can cause balance problems with the spin phase. If this occurs, adjust manually the items in the tub and start the spin phase again.

9.2 Stubborn stains

For some stains, water and detergent is not sufficient.

We recommend that you remove these stains before you put the items in the appliance.

Special stain removers are available. Use the special stain remover that is applicable to the type of stain and fabric.

9.3 Detergents and additives

- Only use detergents and additives specially made for washing machines.

- Do not mix different types of detergents.
- To help the environment, do not use more than the correct quantity of detergent.
- Obey the instructions that you find on the on packaging of these products.
- Use the correct products for the type and colour of the fabric, the programme temperature and the level of soil.
- If you use liquid detergents, do not set the prewash phase.
- If your appliance has not the detergent dispenser with the flap device, add the liquid detergents with a dosing ball.

use a water softener for washing machines. In areas where the water hardness is soft it is not necessary to use a water softener.

To know the water hardness in your area, contact your local water authority.

Obey the instructions that you find on the packaging of the products.

Equivalent scales measure the water hardness:

- German degrees (°dH).
- French degrees (°TH).
- mmol/l (millimol for each litre - international unit for the hardness of water).
- Clarke degrees.

9.4 Water hardness

If the water hardness in your area is high or moderate, we recommend that you

Water hardness table

Level	Type	Water hardness			
		°dH	°T.H.	mmol/l	Clarke
1	soft	0-7	0-15	0-1.5	0-9
2	medium	8-14	16-25	1.6-2.5	10-16
3	hard	15-21	26-37	2.6-3.7	17-25
4	very hard	> 21	> 37	>3.7	>25

10. CARE AND CLEANING



WARNING!

Disconnect the appliance from the mains supply before you clean it.

10.1 Descaling

The water we use contains limescale. If it becomes necessary, use a water softener to remove limescales.

Use a special product made for washing machines. Obey the instructions that you find on the packaging of the manufacturer.

Do this separately from the laundry wash.

10.2 External cleaning

Clean the appliance only with soap and warm water. Fully dry all the surfaces.



CAUTION!

Do not use alcohol, solvents or chemical products.

10.3 Maintenance wash

With the low temperature programmes it is possible that some detergent stays in the drum. Make regularly a maintenance wash. To do this:

- Empty the laundry from the drum.

- Set the hottest cotton wash programme
- Use a correct quantity of powder detergent with biological properties.

After each wash, keep the door open for a while to prevent mould and to let unpleasant smells go out.

10.4 Door seal

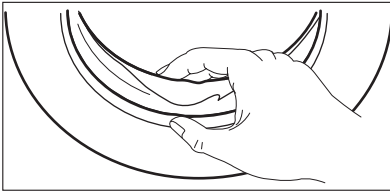

Regularly examine the seal and remove all objects from the inner part.

10.5 Drum

Regularly examine the drum to prevent limescale and rust particles. Only use special products to remove rust particles from the drum. To do this:

- Clean the drum with special product for stainless steel.
- Start a short programme for cotton at the maximum temperature with a small quantity of detergent.

10.6 Detergent dispenser

To clean the dispenser:

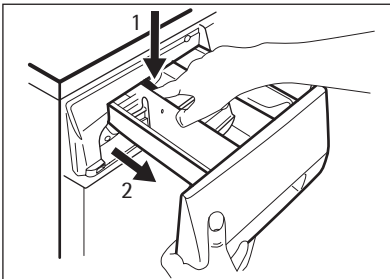

1. Press the lever.
2. Pull the dispenser out.

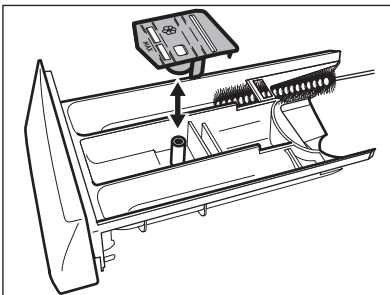

3. Remove the top part of the liquid additive compartment.
4. Clean all the parts with water.

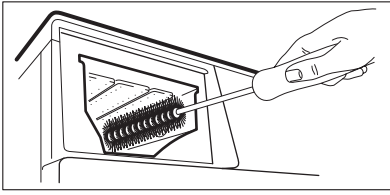

5. Clean the dispenser recess with a brush.
6. Put back the dispenser in the recess.

10.7 Drain pump



Regularly examine the drain pump and make sure that it is clean.

Clean the pump if:

- The appliance does not drain the water.
- The drum cannot turn.
- The appliance makes an unusual noise because of the blockage of the drain pump.

- The display shows an alarm code because of the problem with water drain.



WARNING!

1. Disconnect the mains plug from the mains socket.
2. Do not remove the filter while the appliance operates. Do not clean the drain pump if the water in the appliance is hot. The water must be cold before you clean the drain pump.

To clean the drain pump:

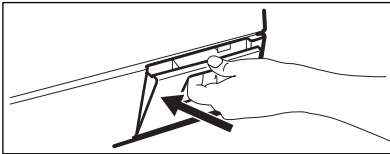

1. Open the drain pump door.

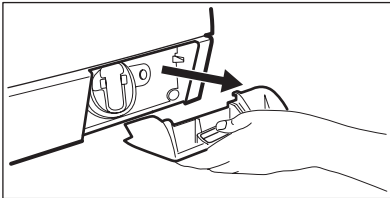

2. Pull the flap out to remove it.

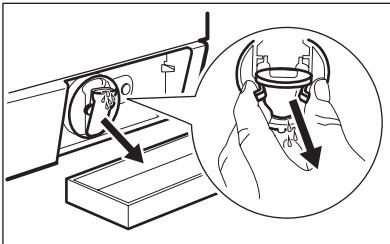

3. Put a container below the recess of the drain pump to collect the water that flows out.
4. Press the two levers and pull forward the drainage duct to let the water flow out.

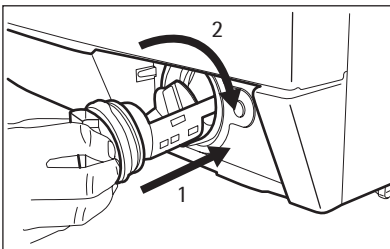
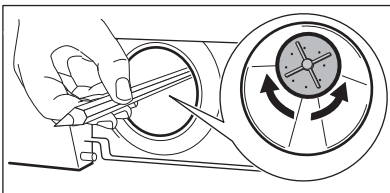
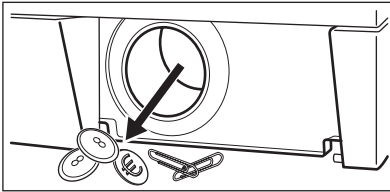
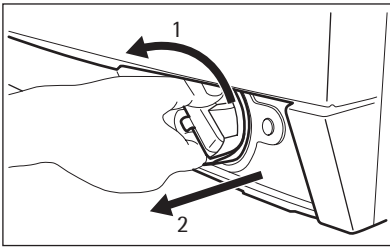

5. When the container is full of water, put the drainage duct back again and empty the container. Do steps 4 and 5 again and again until no more water flows out from the drain pump.
6. Pull back the drainage duct and turn the filter to remove it.
7. Remove fluff and objects from the pump.
8. Make sure that the impeller of the pump can turn. If this does not occur, contact the service centre.
9. Clean the filter under the water tap and put it back in the pump into the special guides.
10. Make sure that you tighten correctly the filter to prevent leakages.
11. Put the flap back and close the drain pump door.

10.8 The inlet hose filter and the valve filter

It could be necessary to clean the filters when:

- The appliance does not fill with water.
- The appliance fills with the water for a long time.

- The indicator of button **4** flashes and the display shows the related alarm. Refer to 'Troubleshooting'.



WARNING!

Disconnect the mains plug from the mains socket.

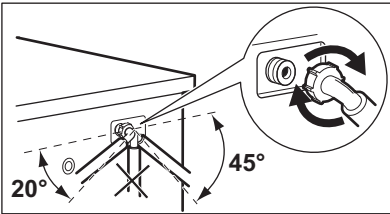
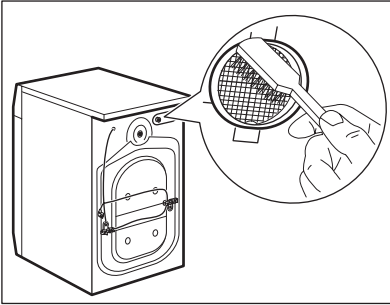
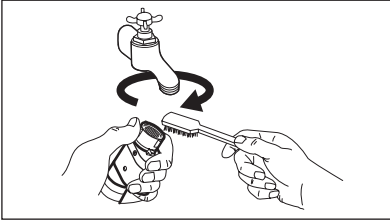
To clean the water inlet filters:

1. Close the water tap.
2. Remove the water inlet hose from the water tap.
3. Clean the filter in the inlet hose with a stiff brush.
4. Remove the inlet hose behind the appliance.
5. Clean the filter in the valve with a stiff brush or a towel.
6. Install again the inlet hose. Make sure that the couplings are tight to prevent leakages.
7. Open the water tap.

10.9 Emergency drain

Because of a malfunction, the appliance cannot drain the water.

If this occurs, do steps (1) through (6) of 'To clean the drain pump'.

If necessary, clean the pump.

Put the drainage duct back and close the drain pump flap.

When you drain the water with the emergency drain procedure, you must activate again the drain system:

1. Put 2 litres of water in the main wash compartment of the detergent dispenser.
2. Start the programme to drain the water.

10.10 Frost precautions

If the appliance is installed in an area where the temperature can be less than

0 °C, remove the remaining water from the inlet hose and the drain pump.

1. Disconnect the mains plug from the mains socket.
2. Close the water tap.
3. Remove the water inlet hose
4. Put the two ends of the inlet hose in a container and let the water flow out of the hose.
5. Empty the drain pump. Refer to the emergency drain procedure
6. When the drain pump is empty, install the inlet hose again.

**WARNING!**

Make sure that the temperature is more than 0 °C before you use the appliance again.

The manufacturer is not responsible for damages caused by low temperatures.

11. TROUBLESHOOTING

The start of the appliance does not occur or it stops during operation. First try to find a solution to the problem (refer to the table). If not, contact the service centre.

With some problems, the acoustic signals operate and the display shows an alarm code:

- **E10** - The appliance does not fill with water.

- **E20** - The appliance does not drain the water.
- **E40** - The appliance door is open or not closed correctly.
- **EFO** - The anti-flood device is on.



WARNING!

Deactivate the appliance before you do the checks.

Problem	Possible cause	Possible solution
The appliance does not fill with water.	The water tap is closed.	Open the water tap.
	The water inlet hose is damaged.	Make sure that the water inlet hose has no damages.
	The filters in the water inlet hose is blocked .	Clean the filters. Refer to 'Care and cleaning'.
	The water tap is blocked or is furred with lime-scale.	Clean the water tap.
	The connection of the water inlet hose is not correct.	Make sure that the connection is correct.
	The water pressure is too low.	Contact your local water authority.
The appliance does not drain the water.	The water drain hose is damaged.	Make sure that the water drain hose has no damages.
	The filter of the drain pump is blocked.	Clean the filter of the drain pump. Refer to 'Care and cleaning'.
	The connection of the water drain hose is not correct.	Make sure that the connection is correct.
	A washing programme without the drain phase is set.	Set the drain programme.
	The function Rinse & Hold is on.	Set the drain programme.
The appliance door is open or not closed correctly.		Close the door correctly.

Problem	Possible cause	Possible solution
The anti-flood device is on.		<ul style="list-style-type: none"> • Disconnect the appliance. • Close the water tap. • Contact the service centre.
The spin phase does not operate.	The spin phase is off.	Set the spin programme.
	The filter of the drain pump is blocked.	Clean the filter of the drain pump. Refer to 'Care and cleaning'.
	Balance problems with the laundry load.	Adjust manually the items in the tub and start the spin phase again.
The programme does not start.	The mains plug is not connected in the mains socket.	Put in the mains plug.
	Blow out fuse in the household fuse box.	Replace the fuse.
	You did not press button 4 .	Press button 4 .
	The delay start is set.	To start immediately the programme, cancel the delay start.
	The Child Lock function is activated.	Deactivate the Child Lock function.
There is water on the floor.	Leakages from the couplings of the water hoses.	Make sure that the couplings are tight.
	Leakages from the drain pump.	Make sure that the drain pump filter is tight.
	The water drain hose is damaged.	Make sure that the water inlet hose has no damages.
You cannot open the appliance door.	The washing programme is in operation.	Let the washing programme end.
	There is water in the drum.	Set the drain or the spin programme.
The appliance makes an unusual noise.	Incorrect level of the appliance.	Adjust the level of the appliance. Refer to 'Installation'.
	You did not remove the packaging and/or the transit bolts.	Remove the packaging and/or the transit bolts. Refer to 'Installation'.
	The load is very small.	Add more laundry in the drum.

Problem	Possible cause	Possible solution
The appliance fills with water and drain immediately.	The end of the drain hose is too low.	Make sure that the drain hose is in the correct position.
The washing results are not satisfactory.	The detergent you used was not sufficient or correct.	Increase the detergent quantity or use a different one.
	You did not remove the stubborn stains before you wash the laundry.	Use special products to remove the stubborn stains.
	Incorrect temperature was set.	Make sure that you set the correct temperature.
	Too much laundry load.	Decrease the laundry load.

After the check, activate the appliance. The programme continues from the point of interruption. If the problem occurs again, contact the service centre.

If the display shows other alarm codes, contact the service centre.

12. INSTALLATION

12.1 Fixing plate kit (4055171146)

Available from your authorized dealer.

If you install the appliance on a plinth, secure the appliance in the fixing plates. Follow the instructions supplied with the kit.

12.2 Unpacking

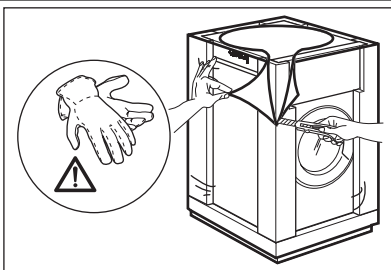

1. Use the gloves. Remove the external film. If necessary, use a cutter.

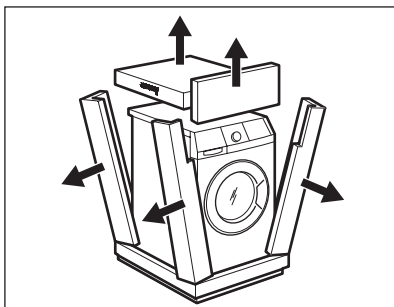

2. Remove the cardboard top.
3. Remove the polystyrene packaging materials.

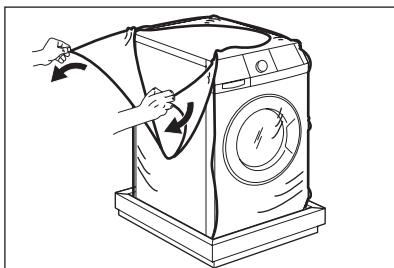

4. Remove the internal film.

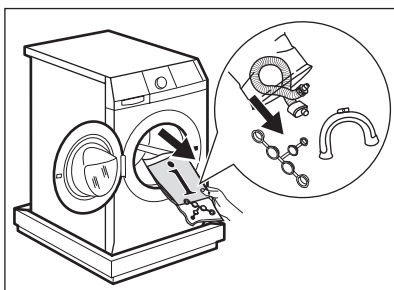

5. Open the door. Remove the polystyrene piece from the door seal and all the items from the drum.

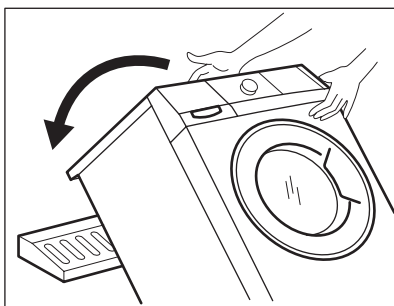

6. Put one of the polystyrene packaging elements on the floor behind the appliance. Carefully put down the appliance with the rear side on it. Make sure not to damage the hoses.

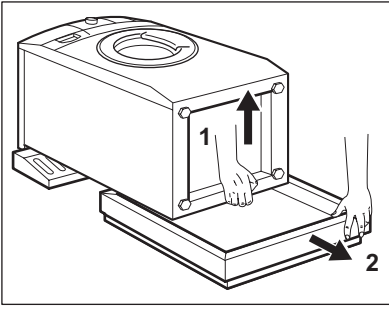

7. Remove the polystyrene protection from the bottom.
8. Pull up the appliance in vertical position.

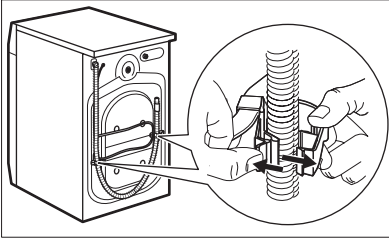

9. Remove the power supply cable and the drain hose from the hose holders.

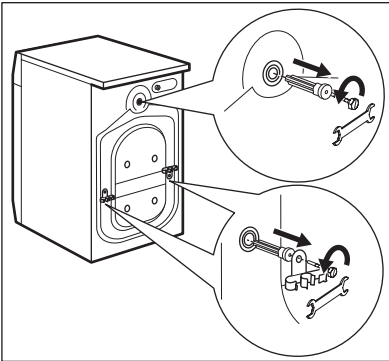

10. Remove the three bolts. Use the key supplied with the appliance.
11. Pull out the plastic spacers.

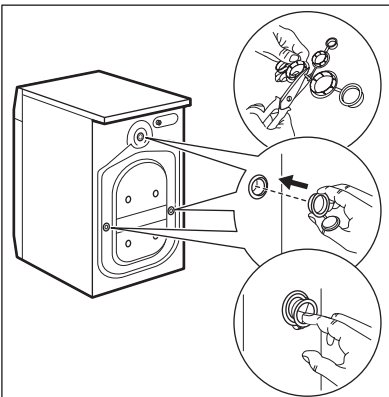

12. Put the plastic caps in the holes. You can find these caps in the user manual bag.



WARNING!

Remove all the packaging and the transit bolts before you install the appliance.



We recommend that you keep the packaging and the transit bolts for when you move the appliance.

12.3 Positioning and levelling

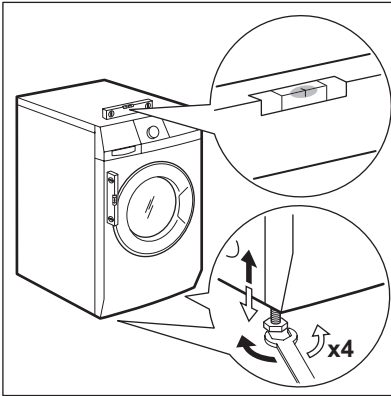

- Install the appliance on a flat hard floor.
- Make sure that carpets do not stop the air circulation below the appliance.
- Make sure that the appliance does not touch the wall or other units
- Loosen or tighten the feet to adjust the level. A correct adjustment of the appliance level prevents the vibration, noise and the movement of the appliance when in operation.

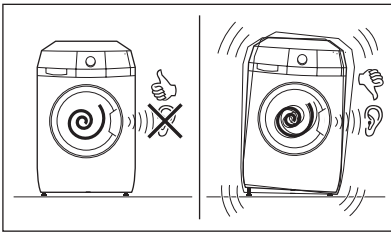

- The appliance must be level and stable.



CAUTION!

Do not put cardboard, wood or equivalent materials below the appliance feet to adjust the level.

12.4 The inlet hose

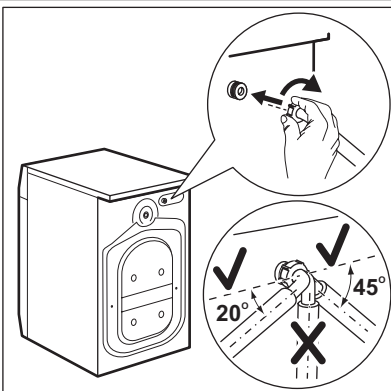

- Connect the hose to the appliance. Turn the inlet hose only left or right. Loose the ring nut to set it in the correct position.

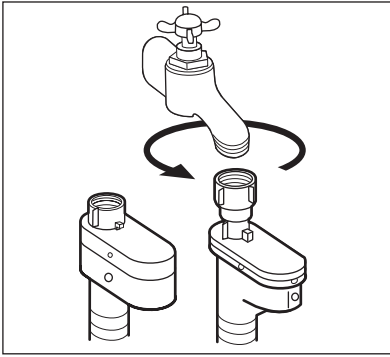

- Connect the water inlet hose to the cold water tap with 3/4 thread.



CAUTION!

Make sure that there are no leaks from the couplings.



Do not use an extension hose if the inlet hose is too short. Contact the service centre for the replacement of the inlet hose.

Water-stop device

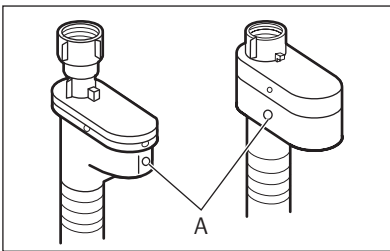

The inlet hose has a water stop device. This device prevents water leaks in the hose because of its natural ageing. The red sector in the window «A» shows this fault.

If this occur, close the water tap and contact the service centre to replace the hose.

12.5 Water drainage

There are different procedures to connect the drain hose:

With the plastic hose guide.

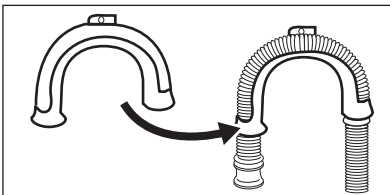

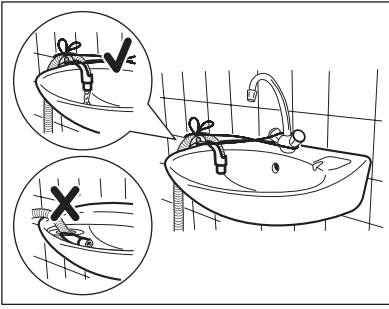

- On the edge of a sink.
- Make sure that the plastic guide cannot move when the appliance drains. Attach the guide to the water tap or the wall.

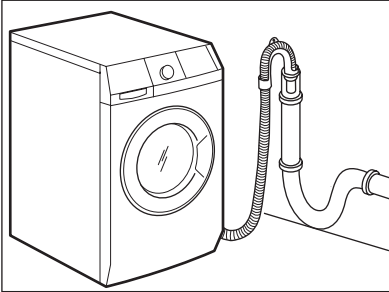

- To a stand pipe with vent-hole.
Refer to the illustration. Directly into a drain pipe at a height of not less than 60 cm and not more than 100 cm. The end of the drain hose must always be ventilated, i.e. the inner diameter of the drainpipe must be larger than the external diameter of the drain hose.

Without the plastic hose guide.

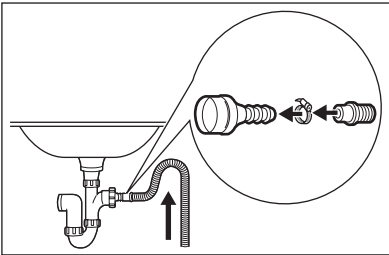

- To a sink spigot.
Refer to the illustration. Put the drain hose in the spigot and tighten it with a clip. Make sure that the drain hose makes a loop to prevent that remaining particles go in the appliance from the sink.

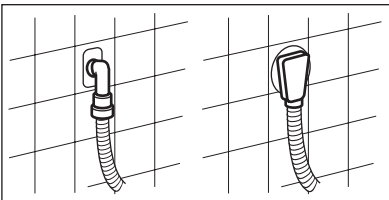



- Directly to a built-in drain pipe in the room wall and tighten it with a clip.



You can extend the drain hose to maximum 400 cm. Contact the service centre for the other drain hose and the extension.

13. ENVIRONMENT CONCERNS

Recycle the materials with the symbol . Put the packaging in applicable containers to recycle it. Help protect the environment and human health and to recycle waste of electrical and electronic

appliances. Do not dispose appliances marked with the symbol  with the household waste. Return the product to your local recycling facility or contact your municipal office.

www.aeg.com/shop



132936301-A-262012



Free Manuals Download Website

<http://myh66.com>

<http://usermanuals.us>

<http://www.somanuals.com>

<http://www.4manuals.cc>

<http://www.manual-lib.com>

<http://www.404manual.com>

<http://www.luxmanual.com>

<http://aubethermostatmanual.com>

Golf course search by state

<http://golfingnear.com>

Email search by domain

<http://emailbydomain.com>

Auto manuals search

<http://auto.somanuals.com>

TV manuals search

<http://tv.somanuals.com>