

Comfort-Cire[®]

HEAT CONTROLLER

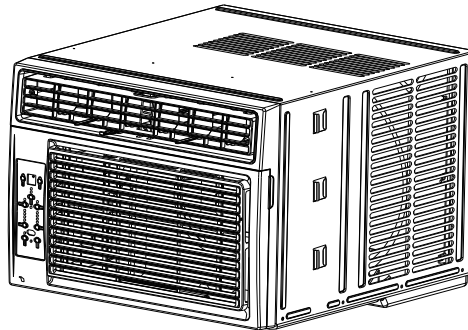

Room Air Conditioner Owner's Manual for: RADS-61P RADS-81P

Table of Contents





Important Safety Instructions.....	1-3
Installation Instructions.....	4-8
Normal Sounds.....	9
Air Conditioner Features.....	9-11
Care and Cleaning.....	11-12
Troubleshooting Tips.....	12-13
Limited Express Warranty.....	14

IMPORTANT SAFETY INSTRUCTIONS

















READ THIS MANUAL

Inside you will find many helpful hints on how to use and maintain your air conditioner properly. Just a little preventive care on your part can save you a great deal of time and money over the life of your air conditioner. You'll find many answers to common problems in the chart of troubleshooting tips. If you review our chart of Troubleshooting Tips first, you may not need to call for service at all.

To prevent injury to the user or other people and property damage, the following instructions must be followed. Incorrect operation due to ignoring of instructions may cause harm or damage. The seriousness is classified by the following indications.

 WARNING	This symbol indicates the possibility of death or serious injury.		
 CAUTION	This symbol indicates the possibility of injury or damage to property.		
	Never do this.		Always do this.

WARNING

<p> Plug in power plug properly.</p> <ul style="list-style-type: none"> Otherwise, it may cause electric shock or fire due to excess heat generation. 	<p> Do not operate or stop the unit by inserting or pulling out the power plug.</p> <ul style="list-style-type: none"> It may cause electric shock or fire due to heat generation. 	<p> Do not damage or use an unspecified power cord.</p> <ul style="list-style-type: none"> It may cause electric shock or fire. If the power cord is damaged, it must be replaced by the manufacturer or an authorised service center or a similarly qualified person in order to avoid a hazard.
<p> Always install circuit breaker and a dedicated power circuit.</p> <ul style="list-style-type: none"> Incorrect installation may cause fire and electric shock. 	<p> Do not operate with wet hands or in damp environment.</p> <ul style="list-style-type: none"> It may cause electric shock. 	<p> Do not direct airflow at room occupants.</p> <ul style="list-style-type: none"> This could damage your health.
<p> Always ensure effective grounding.</p> <ul style="list-style-type: none"> Incorrect grounding may cause electric shock. 	<p> Do not allow water to run into electric parts.</p> <ul style="list-style-type: none"> It may cause failure of machine or electric shock. 	<p> Do not modify power cord length or share the outlet with other appliances.</p> <ul style="list-style-type: none"> It may cause electric shock or fire due to heat generation.
<p> Unplug the unit if strange sounds, smell, or smoke come from it.</p> <ul style="list-style-type: none"> It may cause fire and electric shock. 	<p> Do not use the socket if it is loose or damaged.</p> <ul style="list-style-type: none"> It may cause fire and electric shock. 	<p> Do not open the unit during operation.</p> <ul style="list-style-type: none"> It may cause electric shock.
<p> Keep firearms away.</p> <ul style="list-style-type: none"> It may cause fire. 	<p> Do not use the power cord close to heating appliances.</p> <ul style="list-style-type: none"> It may cause fire and electric shock. 	<p> Do not use the power cord near flammable gas or combustibles, such as gasoline, benzene, thinner, etc.</p> <ul style="list-style-type: none"> It may cause an explosion or fire.
<p> Ventilate room before operating air conditioner if there is a gas leakage from another appliance.</p> <ul style="list-style-type: none"> It may cause explosion, fire and, burns. 	<p> Do not disassemble or modify unit.</p> <ul style="list-style-type: none"> It may cause failure and electric shock. 	

IMPORTANT SAFETY INSTRUCTIONS

CAUTION

<p>⊖ When the air filter is to be removed, do not touch the metal parts of the unit.</p> <p>● It may cause an injury.</p>	<p>⊖ Do not put a pet or house plant where it will be exposed to direct air flow.</p> <p>● This could injure the pet or plant.</p>	<p>⊖ Ventilate the room well when used together with a stove, etc.</p> <p>● An oxygen shortage may occur.</p>
<p>⊖ Do not use strong detergent such as wax or thinner but use a soft cloth.</p> <p>● Appearance may be deteriorated due to change of product color or scratching of its surface.</p>	<p>⊖ Do not clean the air conditioner with water.</p> <p>● Water may enter the unit and degrade the insulation. It may cause an electric shock.</p>	<p>⊖ Do not use for special purposes.</p> <p>● Do not use this air conditioner to preserve precision devices, food, pets, plants, and art objects. It may cause deterioration of quality, etc.</p>
<p>⊖ Stop operation and close the window in storm or hurricane.</p> <p>● Operation with windows opened may cause wetting of indoor and soaking of household furniture.</p>	<p>⊖ When the unit is to be cleaned, switch off, and turn off the circuit breaker.</p> <p>● Do not clean unit when power is on as it may cause fire and electric shock, it may cause an injury.</p>	<p>⊖ Ensure that the installation bracket of the outdoor appliance is not damaged due to prolonged exposure.</p> <p>● If bracket is damaged, there is concern of damage due to falling of unit.</p>
<p>⊖ Always insert the filters securely. Clean filter once every two weeks.</p> <p>● Operation without filters may cause failure.</p>	<p>⊖ Hold the plug by the head of the power plug when taking it out.</p> <p>● It may cause electric shock and damage.</p>	<p>⊖ Turn off the main power switch when not using the unit for a long time.</p> <p>● It may cause failure of product or fire.</p>
<p>⊖ Do not place obstacles around air-inlets or inside of air-outlet.</p> <p>● It may cause failure of appliance or accident.</p>	<p>⊖ Do not place heavy object on the power cord and ensure that the cord is not compressed.</p> <p>● There is danger of fire or electric shock.</p>	<p>⊖ Do not drink water drained from air conditioner.</p> <p>● It contains contaminants and could make you sick.</p>
<p>⊖ Use caution when unpacking and installing. Sharp edges could cause injury.</p>	<p>⊖ If water enters the unit, turn the unit off at the power outlet and switch off the circuit breaker. Isolate supply by taking the power-plug out and contact a qualified service technician.</p>	

CAUTION

- This appliance is not intended for use by persons (including children) with reduced physical, sensory or mental capabilities or lack of experience and knowledge, unless they have been given supervision or instruction concerning use of the appliance by a person responsible for their safety.
- Children should be supervised to ensure that they do not play with this appliance.
- If the supply cord is damaged, it must be replaced by the manufacturer, its service agent or similarly qualified persons in order to avoid a hazard.
- This appliance shall be installed in accordance with national wiring regulations
- Do not operate your air conditioner in a wet room such as a bathroom or laundry room.
- Any appliance with electric heater shall have at least 1 meter space to combustible materials.
- Contact an authorized service technician for repair or maintenance of this unit.
- Contact an authorized installer for installation of this unit.

IMPORTANT SAFETY INSTRUCTIONS

NOTE:
 The power supply cord with this air conditioner contains a current detection device designed to reduce the risk of fire. Please refer to the section Operation of Current Device for details. In the event that the power supply cord is damaged, it cannot be repaired-it must be replaced with a cord from the Product Manufacturer.

WARNING
 Avoid fire hazard or electric shock. Do not use an extension cord or an adaptor plug. Do not remove any prong from the power cord.

Grounding type wall receptacle

Do not, under any circumstances, cut, remove, or bypass the grounding prong.

Power supply cord with 3-prong grounding plug and current detection device

WARNING
For Your Safety
 Do not store or use gasoline or other flammable vapors and liquids in the vicinity of this or any other appliance.

WARNING
Prevent Accidents
 To reduce the risk of fire, electrical shock, or injury to persons when using your air conditioner, follow basic precautions, including the following:

- Be sure the electrical service is adequate for the model you have chosen. This information can be found on the serial plate, which is located on the side of the the cabinet and behind the grille.
- If the air conditioner is to be installed in a window, you will probably want to clean both sides of the glass first. If the window is a triple-track type with a screen panel included, remove the screen completely before installation.
- Be sure the air conditioner has been securely and correctly installed according to the installation instructions in this manual. Save this manual for possible future use in removing or installing this unit.
- When handling the air conditioner, be careful to avoid cuts from sharp metal fins on front and rear coils.

WARNING
Electrical Information
 The complete electrical rating of your new room air conditioner is stated on the serial plate. Refer to the rating when checking the electrical requirements.

- Be sure the air conditioner is properly grounded. To minimize shock and fire hazards, proper grounding is important. The power cord is equipped with a three-prong grounding plug for protection against shock hazards.
- Your air conditioner must be used in a properly grounded wall receptacle. If the wall receptacle you intend to use is not adequately grounded or protected by a time delay fuse or circuit breaker, have a qualified electrician install the proper receptacle. Ensure the receptacle is accessible after the unit installation.
- Do not run air conditioner without side protective cover in place. This could result in mechanical damage within the air conditioner.
- **Do not use an extension cord or an adapter plug.**

Operation of Current Device (Applicable to the unit adopts current detection device only)
 The power supply cord contains a current device that senses damage to the power cord. To test your power supply cord do the following:

1. Plug in the Air Conditioner.
2. The power supply cord will have TWO buttons on the plug head. Press the TEST button, you will notice a click as the RESET button pops out.
3. Press the RESET button, again you will notice a click as the button engages.
4. The power supply cord is now supplying electricity to the unit. (On some products this it also indicated by a light on the plug head.)

NOTE:

- Do not use this device to turn the unit on or off.
- Always make sure the RESET button is pushed in for correct operation.
- The power supply must be replaced if it fails reset when either the TEST button is pushed, or it cannot be reset. A new one can be obtained from the product manufacturer.
- If power supply cord is damaged, it cannot be repaired. It MUST be replaced by one obtained from the product manufacturer.

NOTE: This air conditioner is designed to be operated under condition as follows:

Cooling operation	Outdoor temp:	64-109°F/18-43°C (64-125°F/18-52°C for special tropical models)
	Indoor temp:	62-90°F/17-32°C
Heating operation	Outdoor temp:	23-76°F/-5-24°C
	Indoor temp:	32-80°F/0-27°C

Note: Performance may be reduced outside of these operating temperatures.

INSTALLATION INSTRUCTIONS



BEFORE YOU BEGIN

Read these instructions completely and carefully.

IMPORTANT- Save these instructions for local inspector's use.

IMPORTANT- Observe all governing codes and ordinances.

Note to Installer- Be sure to leave these instructions with the Consumer.

Note to Consumer- Keep these instructions for future reference.

Skill level- Installation of this appliance requires basic mechanical skills.

Completion time- Approximately 1 hour. We recommend that two people install this product.

Proper installation is the responsibility of the installer.

Product failure due to improper installation is not covered under the Warranty.

You **MUST** use all supplied parts and use proper installation procedures as described in these instructions when installing this air conditioner.



WINDOW REQUIREMENTS

Your air conditioner is designed to install in standard double hung windows with opening widths of 23 to 36 inches (584mm to 914mm).

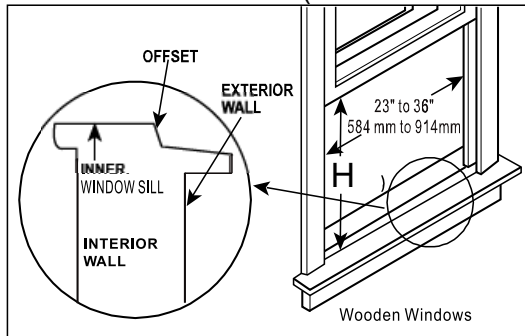

Model	5000~8000Btu/h	10000~12000Btu/h
H	14"(356mm)	15-1/2"(394mm)

Table 1



CAUTION

Do not, under any circumstances, cut or remove the third (ground) prong from the power cord.

Do not change the plug on the power cord of the air conditioner.

Aluminum house wiring may present special problems- consult a qualified electrician.

When handling unit, be careful to avoid cuts from sharp metal edges and aluminum fins on front and rear coils.

TOOLS YOU WILL NEED

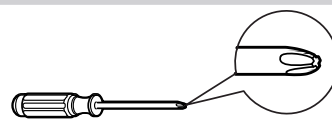

Screwdriver



Level

TOOLS YOU MAY USE



Screwdriver



Pencil

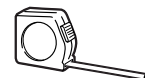

Ruler or tape measure

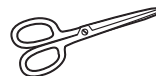

Scissors or knife



NOTE:

Save Carton and these Installation Instructions for future reference. The carton is the best way to store unit during winter, or when not in use.

INSTALLATION INSTRUCTIONS

1 PREPARE THE WINDOW

Lower sash must open sufficiently to allow a clear vertical opening (H) of following size (see Table 1). Side louvers and the rear of the AC must have clear air space to allow enough airflow through the condenser, for heat removal. The rear of the unit must be outdoors, not inside a building or garage.

Mounting Hardware

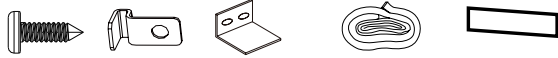

- 3/4" (or 1/2") Lock Frame Sash Lock Window sash Weather
Screws (7) (2) (1) seal foam stripping
(1) (10" x 3/4" x 1/12")
(5)

NOET: Weather stripping is only for Energy star models.

2 PREPARE AIR CONDITIONER

A: Remove the air conditioner from the carton and place on a flat surface.

B: Remove top rail and R1 hardware (R1 hardware only for Energy star models) from the packaging material as shown in Fig. A.

Top Rail Hardware

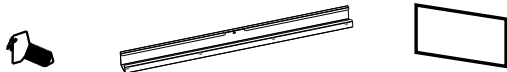

- 3/8" Screws (4) Top Rail (1) R1 hardware (2)

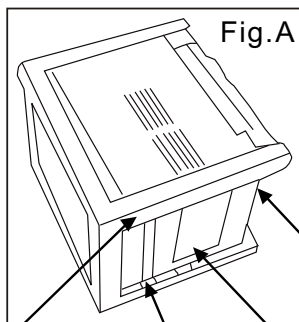

Labels in Fig. A:
 Packaging
 Top Rail
 R1 hardware (for $\ge 10000\text{ Btu/h}$ models only)

C: Align the hole in the top rail with those in the top of the unit as shown in Fig. B

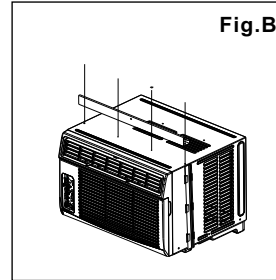

D: Secure the top rail to the unit with the 3/8" Screws as shown in Fig. C.

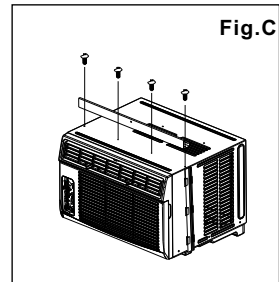

NOTE: For safety reasons, all four(4) screws MUST be securely fastened.

NOTE: The top rail hardware and the Fig. A, Fig. B and Fig. C are not applicable to the units more than 10000 Btu/h. Before installing unit, the top rail must be assembled on the unit (For <math>< 10000\text{ Btu/h}</math> models only).

3 INSTALL THE ACCORDION PANELS

NOTE: Top rail and Sliding Panels at each side are offset to provide the proper pitch to the rear of (5/16"). This is necessary for proper condensed water utilization and drainage. If you are not using the Side Panels for any reason, this pitch to the rear must be maintained.

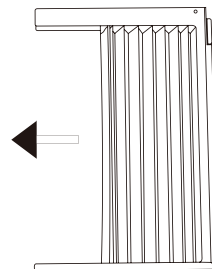

Fig.1

A. Place unit on floor, a bench or a table. Hold the Accordion Panel in one hand and gently pull back the center to free the open end. See Fig.1

INSTALLATION INSTRUCTIONS

- B. Slide the free end "ϕ" section of the panel directly into the cabinet as shown in Fig. 2. Slide the panel down. Be sure to leave enough space to slip the top and bottom of the frame into the rails on the cabinet.

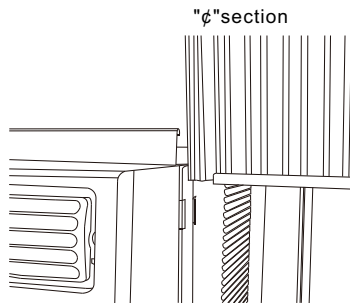

Fig.2

- C. Once the panel has been installed on the side of the cabinet, make sure it sits securely inside the frame channel by making slight adjustments. Slide the top and bottom ends of the frame into the top and bottom rails of the cabinet. Fig.3.

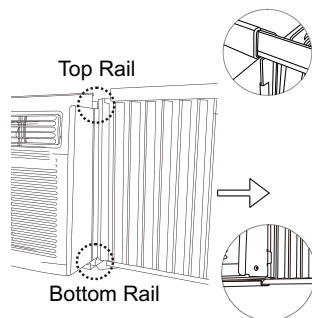
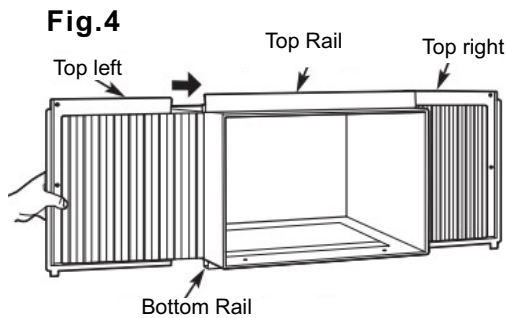

Fig.3

- D. Slide the panel all the way in and repeat on the other side.



NOTE: If storm window blocks AC, see Fig. 11.

4 SECURE THE ACCORDION PANELS

- A. Keep a firm grip on the air conditioner, carefully place the unit into the window opening so the bottom of the air conditioner frame is against the window sill (Fig.5). Carefully close the window behind the top rail of the unit.

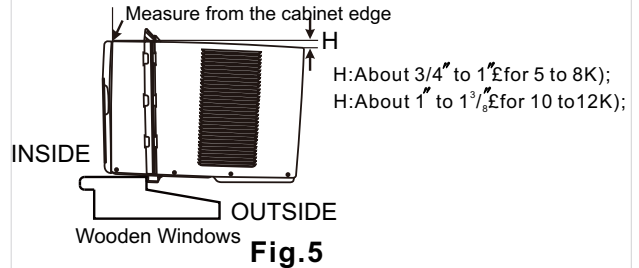

- NOTE:** Check that air conditioner is tilted back about H (Fig.5)(tilted about 3° to 4° downward to the outside). After proper installation, condensate should not drain from the overflow drain hole during normal use, correct the slope otherwise.

- B. Extend the side panels out against the window frame (Fig.6).

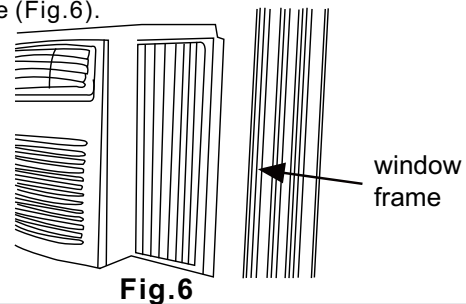

Fig.6

5 INSTALL SUPPORT BRACKET

- A. Place the frame lock between the frame extensions and the window sill as shown(Fig.7). Drive 3 / 4 " (19mm) or 1 / 2 " (12.7mm) locking screws through the frame lock and into the sill .

- NOTE:** To prevent window sill from splitting, drill 1 / 8 " (3mm) pilot holes before driving screws.

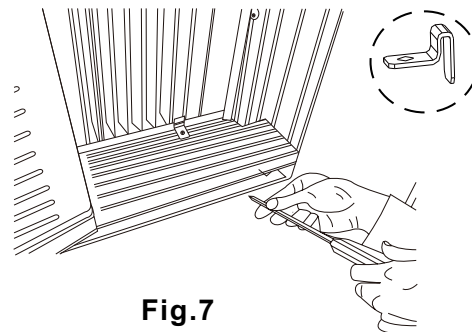

Fig.7

INSTALLATION INSTRUCTIONS

B. Drive 3/4" (19mm) or 1/2" (12.7mm) locking screws through frame holes into window sash (Fig.8).

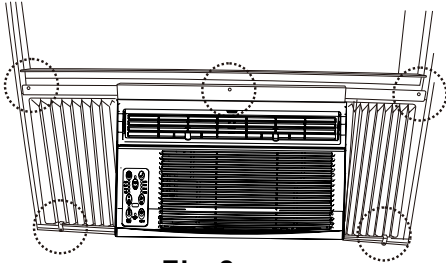

Fig.8

C. To secure lower sash in place, attach right angle sash lock with 3/4" (19mm) or 1/2" (12.7mm) screw as shown (Fig.9).



Fig.9

D. Cut Window sash seal foam and insert it in the space between the upper and lower sashes (Fig.10).

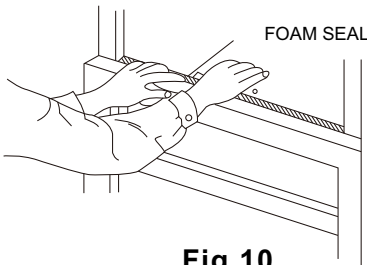

Fig.10

6 INSTALL R1 HARDWARE (only be applicable to Energy star models)

In order to minimize air leaks and ensure optimal insulation, it is necessary to install the included R1 hardware to the side curtain. Follow the instructions below.

Step 1. After the unit is installed to the window, measure the inner width of the side curtain as shown (Fig.11).

Step 2. Remark a line on the provide R1 insulation panel according to a length 1/8" (3mm) less than the measured width in step 1, then cut the R1 insulation panel along the line (Fig.12).

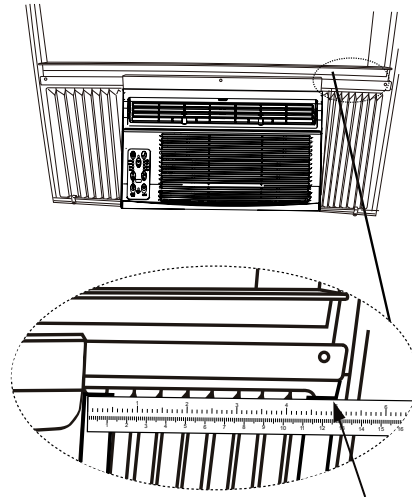

Measure the inner width of the side curtain

Fig.11

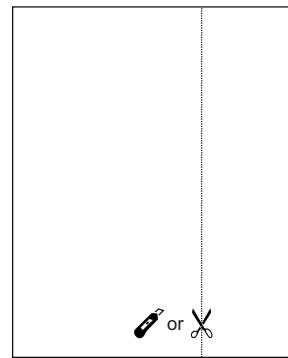

Fig.12

Step 3. Slide the R1 insulation panel into the side curtain, the side with pattern should facing the indoor side. (Fig.13).

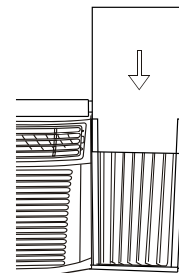

Fig.13

Step 4. Repeat on the other side.

INSTALLATION INSTRUCTIONS

7 INSTALL WEATHER STRIPPING (only be applicable to Energy star models)

In order to minimize air leaks between the room air conditioner and the window opening, trim the weather stripping with a proper length, peel off the protective backing and plug any gaps if needed (Fig.14).

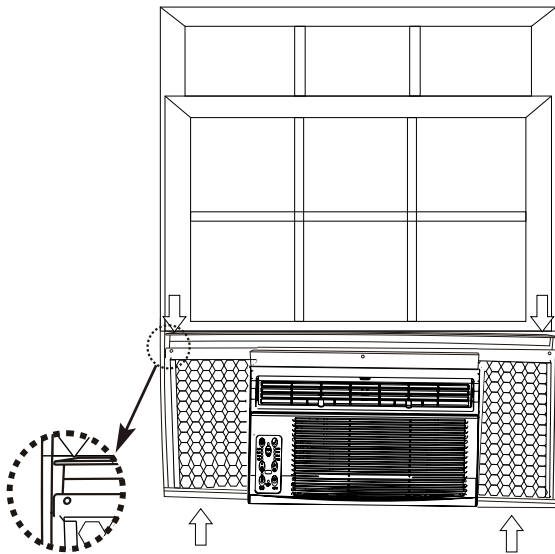

Fig.14

If AC is Blocked by Storm Window

Add wood as shown in Fig.15, or remove storm window before air conditioner is installed.

If Storm Window Frame must remain, be sure the drain holes or slots are not caulked or painted shut. Accumulated Rain Water or Condensation must be allowed to drain out.

Removing AC From Window

Turn AC off, and disconnect power cord. Remove sash seal from between windows, and unscrew safety sash lock. Remove screws installed through frame and frame-lock. Remove the R1 Panel and close (slide) side panels into frame. Keeping a firm grip on air conditioner, raise sash and carefully remove. Be carefully not to spill any remaining water while lifting unit from window. Store parts WITH air conditioner.

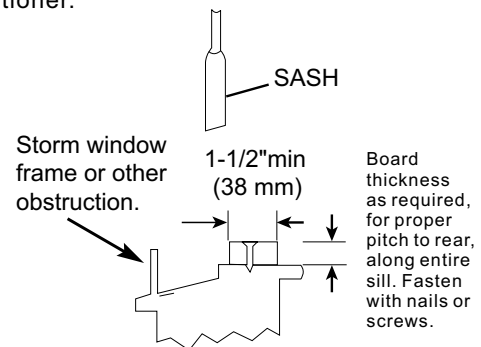
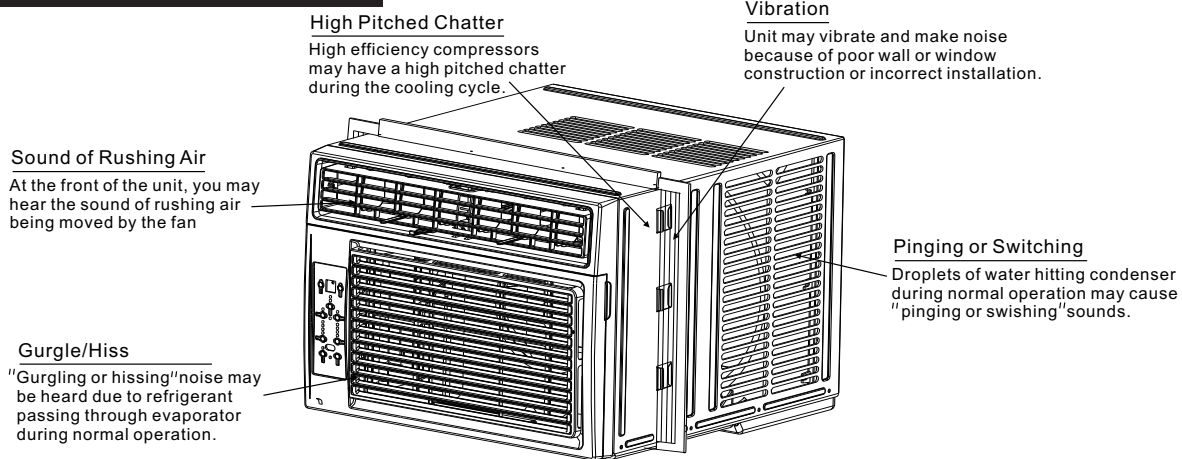

Fig.15

NORMAL SOUNDS



NOTE:
All the illustrations in this manual are for explanation purpose only. Your air conditioner may be slightly different. The actual shape shall prevail.

AIR CONDITIONER FEATURES

ELECTRONIC CONTROL OPERATING INSTRUCTIONS

Before you begin, thoroughly familiarize yourself with the control panel as shown below and all its functions, then follow the symbol for the functions you desire. **The unit can be controlled by the unit control alone or with the remote.**

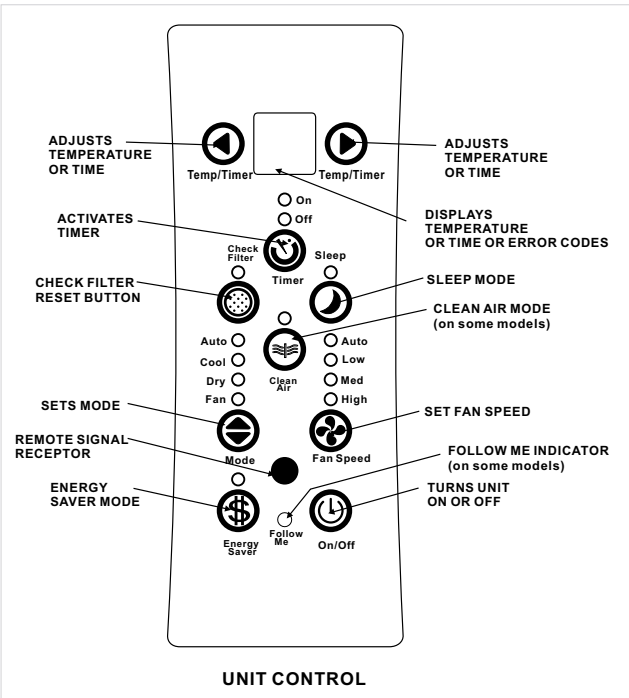

TO TURN UNIT ON OR OFF:

Press **ON/OFF** button to turn unit on or off.
NOTE: The unit will initiate automatically the Energy Saver function under Cool, Dry, Auto (only Auto-Cooling and Auto-Fan) modes.

TO CHANGE TEMPERATURE SETTING:

Press **UP/DOWN** button to change temperature setting.
NOTE: Press or hold either UP (▲) or DOWN (▼) button until the desired temperature is seen on the display. This temperature will be automatically maintained anywhere between 62°F (17°C) and 86°F (30°C). If you want the display to read the actual room temperature, see "To Operate on Fan Only" section.

CLEAN AIR FEATURE: (on some models)

Press **Clean Air** button, the ion generator is energized and will help to remove pollen and impurities from the air, and trap them in the filter.

AIR CONDITIONER FEATURES

TO ADJUST FAN SPEEDS:

Press  to select the Fan Speed in four steps-Auto, Low, Med or High. Each time the button is pressed, the fan speed is shifted. On Dry mode, the fan speed is controlled at Low automatically.

SLEEP FEATURE:

Press  Sleep button to initiate the sleep mode. In this mode the selected temperature will increase by 2°F/1(or 2)°C 30 minutes after the mode is selected. The temperature will then increase by another 2°F/1(or 2)°C after an additional 30 minutes. This new temperature will be maintained for 6 hours before it returns to the originally selected temperature. This ends the Sleep mode and the unit will continue to operate as originally programmed. The Sleep mode program can be cancelled at any time during operation by pressing the Sleep button again.

CHECK FILTER FEATURE:

Press  Check filter button to initiate the is feature. This feature is a reminder to clean the Air Filter for more efficient operation. The LED(light) will illuminate after 250 hours of operation. To reset after cleaning the filter, press the Check Filter button and the light will go off.

ENERGY SAVER FEATURE:

Press  Energy saver button to initiate this function. This function is available on COOL, DRY, AUTO (only AUTO-COOLING and AUTO-FAN) modes. The fan will continue to run for 3 minutes after the compressor shuts off. The fan then cycles on for 2 minutes at 10 minute intervals until the room temperature is above the set temperature, at which time the compressor turns back on and Cooling Starts.

FOLLOW ME FEATURE:(on some models)

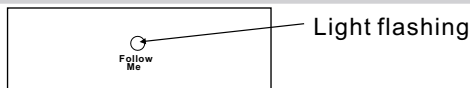

This feature can be activated from the remote control ONLY. The remote control serves as a remote thermostat allowing for the precise temperature control at its location.

To activate the Follow Me feature, point the remote control towards the unit and press the Follow Me button. The remote display is actual temperature at its location. The remote control will send this signal to the air conditioner every 3 minutes interval until press the Follow Me button again. If the unit does not receive the Follow Me signal during any 7 minutes interval, the unit will beep to indicate the Follow Me mode has ended.

TO SELECT THE OPERATING MODE:

To choose operating mode, press  Mode button. Each time you press the button, a mode is selected in a sequence that goes from Auto, Cool, Dry and Fan. The indicator light beside will be illuminated and remained on once the mode is selected.

The unit will initiate automatically the Energy Saver function under Cool, Dry, Auto(only Auto-Cooling and Auto-Fan) modes.

To operate on Auto feature:

- When you set the air conditioner in AUTO mode, it will automatically select cooling, heating(cooling only models without), or fan only operation depending on what temperature you have selected and the room temperature.
- The air conditioner will control room temperature automatically round the temperature point set by you.
- In this mode, the fan speed cannot be adjusted, it starts automatically at a speed according to the room temperature.

To operate on Fan Only:

- Use this function only when cooling is not desired, such as for room air circulation or to exhaust stale air(on some models). (Remember to open the vent during this function, but keep it closed during cooling for maximum cooling efficiency.) You can choose any fan speed you prefer.
- During this function, the display will show the actual room temperature, not the set temperature as in the cooling mode.
- In Fan only mode, the temperature is not adjusted.

To operate on Dry mode:

- In this mode, the air conditioner will generally operate in the form of a dehumidifier. Since the conditioned space is a closed or sealed area, some degree of cooling will continue.

TIMER: AUTO START/STOP FEATURE:

- When the unit is on or off, first press  Timer button, the TIMER ON indicator light illuminates. It indicates the Auto Start program is initiated.
- When the time of TIMER ON is displayed, press the Timer button again, the TIMER OFF indicator light illuminates. It indicates the Auto Stop program is initiated.
- Press or hold the UP or DOWN button to change the Auto time by 0.5 hour increments, up to 10 hours, then at 1 hour increments up to 24 hours. The control will count down the time remaining until start.
- The selected time will register in 5 seconds, and the system will automatically revert back to display the previous temperature setting or room temperature when the unit is on. (when the unit is off, there is no display.)
- Turning the unit ON or OFF at any time or adjusting the timer setting to 0.0 will cancel the Auto Start/Stop timed program.

AIR CONDITIONER FEATURES

DISPLAYS:

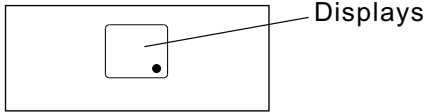

DISPLAYS:

Shows the set temperature in " °C" or " °F" and the Auto-timer settings. While on Fan only mode, it shows the room temperature.

Error codes:

AS-Room temperature sensor error-Unplug the unit and plug it back in.If error repeats, call for service.
NOTE:In Fan only mode,it will display"LO" or "HI".

- -Evaporator temperature sensor error-Unplug the unit and plug it back in.If error repeats, call for service.
NOTE: "•" is displayed as shown in the left picture.

HS -Electric heating sensor error-Unplug the unit and plug it back in.If error repeats, call for service.

NOTE:

If the unit breaks off unexpectedly due to the power cut, it will restart with the previous function setting automatically when the power resumes.

Air Directional Louvers

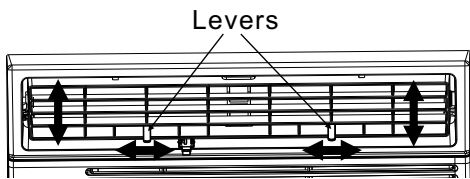

Air Direction

The louvers will allow you to direct the air flow Up or Down(on some models) and Left or Right throughout the room as needed. Pivot horizontal louvers until the desired Up/Down direction is obtained.

Move the Levers from side to side until the desired Left/Right direction is obtained.

ADDITIONAL THINGS YOU SHOULD KNOW

Now that you have mastered the operating procedure, here are more features in your control that you should become familiar with.

- The Cool circuit has an automatic 3 minute time delayed start if the unit is turned off and on quickly. This prevents overheating of the compressor and possible circuit breaker tripping.The fan will continue to run during this time.
- The control is capable of displaying temperature in degrees Fahrenheit or degrees Celsius. To convert from one to the other, press and hold the Left and Right Temp/Timer buttons at the same time, for 3 seconds.

Fresh Air Vent Control (on 10000~12000Btu/h models):

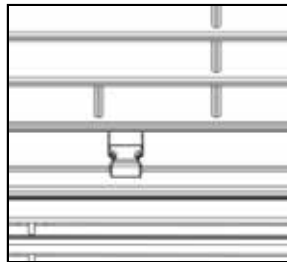

Fig. A (VENT CLOSED)

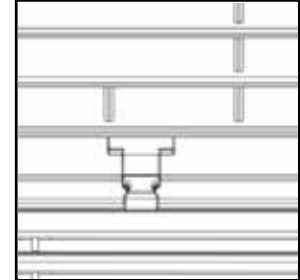

Fig. B (VENT OPEN)

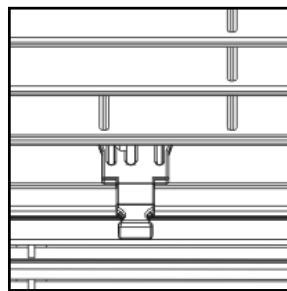

Fig. C (VENT & EXHAUST OPEN)

The Fresh Air Vent allows the air conditioner to:

1. Recirculate inside air - Vent Closed (See Fig. A)
2. Draw fresh air into the room- Vent Open (see Fig. B)
3. Exchange air from the room and draw fresh air into the room - Vent and Exhaust Open (see Fig. C)

CARE AND CLEANING

CAUTION

Clean your air conditioner occasionally to keep it looking new. **Be sure to unplug the unit before cleaning to prevent shock or fire hazards.**

Air Filter Cleaning

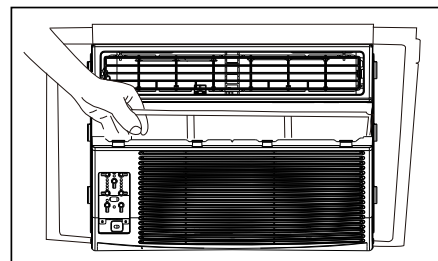

The air filter should be checked at least once a month to see if cleaning is necessary. Trapped particles in the filter can build up and cause an accumulation of frost on the cooling coils.

CARE AND CLEANING

Air Filter Cleaning

- Push the vent handle to the Vent Closed position (where applicable). Open the front panel.
- Take the filter by the center and pull up and out.
- Wash the filter using liquid dishwashing detergent and warm water. Rinse filter thoroughly. Gently shake excess water from the filter. Be sure the filter is thoroughly dry before replacing. Or, instead of washing you may vacuum the filter clean.

Note: Never use hot water over 40°C (104°F) to clean the air filter. Never attempt to operate the unit without the air filter.

Cabinet Cleaning

- Be sure to unplug the air conditioner to prevent shock or fire hazard. The cabinet and front may be dusted with an oil-free cloth or washed with a cloth dampened in a solution of warm water and mild liquid dishwashing detergent. Rinse thoroughly and wipe dry.
- Never use harsh cleaners, wax or polish on the cabinet front.
- Be sure to wring excess water from the cloth before wiping around the controls. Excess water in or around the controls may cause damage to the air conditioner.
- Plug in air conditioner.

Winter Storage

If you plan to store the air conditioner during the winter, remove it carefully from the window according to the installation instructions. Cover it with plastic or return it to the original carton.

TROUBLESHOOTING TIPS

Before calling for service, review this list. It may save your time and expense. This list includes common occurrences that are not the result of defective workman-ship or materials in this appliance.

Problem	Solution
Air conditioner does not start	<i>Wall plug disconnected. Push plug firmly into wall outlet.</i>
	<i>House fuse blown or circuit breaker tripped. Replace fuse with time delay type or reset circuit breaker.</i>
	<i>Plug Current Device Tripped. Press the RESET button.</i>
	<i>Power is OFF. Turn power ON.</i>
Air from unit does not feel cold enough	<i>Room temperature below 62°F(17°C). Cooling may not occur until room temperature rises above 62°F(17°C).</i>
	<i>Temperature sensing behind air filter element touching cold coil. Keep it from the cold coil.</i>
	<i>Set to a Lower temperature.</i>
	<i>Compressor stopped when changing modes. Wait for 3 minutes after set to the COOL mode.</i>
Air conditioner cooling, but room is too warm- ice forming on cooling coil behind decorative front.	<i>Outdoor temperature below 64°F(18°C). To defrost the coil, set FAN ONLY mode.</i>
	<i>Air filter may be dirty. Clean filter. Refer to Care and Cleaning section. To defrost, set to FAN ONLY mode.</i>
	<i>Thermostat set too cold for night-time cooling. To defrost the coil, set to FAN ONLY mode. Then, set temperature to a Higher setting.</i>

TROUBLESHOOTING TIPS

Problem	Solution
Air conditioner cooling, but room is too warm- NO ice forming on cooling coil behind decorative front.	<i>Dirty air filter- air restricted. Clean air filter. Refer to Care and Cleaning section.</i>
	<i>Temperature is set too High, set temperature to a Lower setting.</i>
	<i>Air directional louvers positioned improperly. Position louvers for better air distribution.</i>
	<i>Front of units is blocked by drapes, blinds, furniture, etc. - restricts air distribution. Clear blockage in front of unit.</i>
	<i>Doors, windows, registers, etc. Open- cold air escapes. Close doors, windows, registers.</i>
	<i>Unit recently turned on in hot room. Allow additional time to remove " Stored heat" from walls, ceiling, floor and furniture.</i>
Air conditioner turns on and off rapidly	<i>Dirty air filter- air restricted. Clean air filter.</i>
	<i>Outside temperature extremely hot. Set FAN speed to a Higher setting to bring air past cooling coils more frequently.</i>
Noise when unit is cooling	<i>Air movement sound. This is normal . If too loud, set to a slower FAN setting.</i>
	<i>Window vibration - poor installation. Refer to installation instructions or check with installer.</i>
Water dripping INSIDE when unit is cooling.	<i>Improper installation. Tilt air conditioner slightly to the outside to allow water drainage. Refer to installation instructions - check with installer.</i>
Water dripping OUTSIDE when unit is cooling.	<i>Unit removing large quantity of moisture from humid room. This is normal during excessively humid days.</i>
Remote Sensing Deactivating Prematurely (some models)	<i>Remote control not located within range. Place remote control within 20 feet & 180°, radius of the front of the unit.</i>
	<i>Remote control signal obstructed. Remove obstruction.</i>
Room too cold	<i>Set temperature too low. Increase set temperature.</i>

LIMITED EXPRESS WARRANTY

Congratulations on purchasing your new HVAC equipment. It's been designed for long life and reliable service, and is backed by one of the strongest warranties in the industry. Your unit automatically qualifies for the warranty coverage listed below, providing you keep your proof of purchase (receipt) for the equipment and meet the warranty conditions.

LIMITED ONE (1) YEAR PARTS AND LABOR EXPRESS WARRANTY

Comfort-Aire® warrants all parts of the Room Air Conditioner with electronic controls to be free from defects in workmanship and materials for normal use and maintenance for one (1) year from the date of purchase by the original consumer. This Express Limited Warranty applies only when the Room Air Conditioner is installed and operated per Comfort-Aire® installation and operating instructions for normal use. Ready access to the unit for service is the responsibility of the owner.

LIMITED FIVE (5) YEAR SEALED SYSTEM WARRANTY

The sealed system only is warranted to be free from defects in workmanship and materials for normal use and maintenance for a four additional years, for a total of five (5) years from the date of purchase by the original consumer. The sealed system consists of compressor, evaporator, condenser, and interconnecting tubing. This five year warranty applies only when the system is installed and operated per Comfort-Aire® installation and operation instructions for normal use.

EXCEPTIONS

The Limited Express Warranty does not cover normal maintenance. Comfort-Aire® recommends that regular inspection/maintenance be performed at least once a season and proof of maintenance be kept. Additionally, labor charges (except as described in the Limited One Year Warranty paragraph), diagnostic charges, transportation charges for replacement parts, replacement of refrigerant or filters, and any other service calls/repairs are not covered by this Limited Warranty. It also does not cover any portion or component of the system that is not supplied by Comfort-Aire®, regardless of the cause of failure of such portion or component.

CONDITIONS FOR WARRANTY COVERAGE

- Unit must be operated according to Comfort-Aire® operating instructions included with the unit and cannot have been subjected to accident, alteration, improper repair, neglect or misuse, or an act of God (such as a flood)
- Serial numbers and/or rating plate have not been altered or removed
- Performance cannot be impaired by use of any product not authorized by Comfort-Aire®, or by any adjustments or adaptations to components
- Damage has not been a result of inadequate wiring or voltage conditions, use during brown-out conditions, or circuit interruptions
- Air flow around any section of the unit has not been restricted
- Unit remains in the original installation
- Unit was not purchased over the internet

DURATION OF WARRANTY & REGISTRATION

The warranty begins on the date of purchase by the original consumer. The consumer must retain a receipted bill of sale as proof of warranty period. Without this proof, the express warranty begins on the date of shipment from the factory.

REMEDY PROVIDED BY THE LIMITED EXPRESS WARRANTY

The sole remedy under the Limited Warranty is replacement of the defective part. If replacement parts are required within the period of this warranty, Comfort-Aire® replacement parts shall be used; any warranty on the replacement part(s) shall not affect the applicable original unit warranty. Ready access to the unit for service is the owner's responsibility. Labor to diagnose and replace the defective part is not covered by this Limited Express Warranty. If for any reason the replacement part/product is no longer available during the warranty period, Comfort-Aire® shall have the right to allow a credit in the amount of the current suggested retail price of the part/product instead of providing repair or replacement.

LIMITATION OF LIABILITY

1. There are no other express or implied warranties. Comfort-Aire® makes no warranty of merchantability. We do not warrant that the unit is suitable for any particular purpose or can be used in buildings or rooms of any particular size or condition except as specifically provided in this document. There are no other warranties, express or implied, which extend beyond the description in this document.
2. All warranties implied by law are limited in duration to the one-term of the parts warranty. Your exclusive remedy is limited to the replacement of defective parts. **We will not be liable for any consequential or incidental damages caused by any defect in this unit.**
3. This warranty gives you specific legal rights and you may also have other rights which vary from state to state. Some states do not allow limitation on how long an implied warranty lasts or do not allow the exclusion or limitation of incidental or consequential damages, so the above limitations or exclusions may not apply to you.
4. No warranties are made for units sold outside the continental United States and Canada. Your distributor or final seller may provide a warranty on units sold outside these areas.
5. Comfort-Aire® will not be liable for damages if our performance regarding warranty resolution is delayed by events beyond our control including accident, alteration, abuse, war, government restrictions, strikes, fire, flood, or other acts of God.

HOW TO OBTAIN WARRANTY SERVICE OR PARTS

If you have a warranty claim, contact Service Power, our network of service providers, at 866-557-1865. If they are unable to take care of your claim, write to Comfort-Aire®, PO Box 1089, Jackson MI 49204. Enclose a description of the problem and a report of inspection by your installer or service person. Include the model number, serial number and date of purchase.

Owner responsibilities are set forth in the instruction manual—read it carefully.

KEEP THIS INFORMATION AS A RECORD OF YOUR PURCHASE

PRODUCT IDENTIFICATION

Model Number _____

Serial Number _____

Date of Purchase _____

INSTALLATION

Installer Name (if used) _____

Phone Number/Contact Information _____

Date Installation Completed _____

- Component of new HVAC system Replacement only

Remember to retain your bill of sale as proof of warranty period.

Due to ongoing product improvements, specifications and dimensions are subject to change and correction without notice or incurring obligations. Determining the application and suitability for use of any product is the responsibility of the installer. Additionally, the installer is responsible for verifying dimensional data on the actual product prior to beginning any installation preparations.

Incentive and rebate programs have precise requirements as to product performance and certification. All products meet applicable regulations in effect on date of manufacture; however, certifications are not necessarily granted for the life of a product. Therefore, it is the responsibility of the applicant to determine whether a specific model qualifies for these incentive/rebate programs.

Comfort-Aire®

1900 Wellworth Ave., Jackson MI 49203 • Ph. 517-787-2100 • www.comfort-aire.com



www.marsdelivers.com • www.heatcontroller.com

Free Manuals Download Website

<http://myh66.com>

<http://usermanuals.us>

<http://www.somanuals.com>

<http://www.4manuals.cc>

<http://www.manual-lib.com>

<http://www.404manual.com>

<http://www.luxmanual.com>

<http://aubethermostatmanual.com>

Golf course search by state

<http://golfingnear.com>

Email search by domain

<http://emailbydomain.com>

Auto manuals search

<http://auto.somanuals.com>

TV manuals search

<http://tv.somanuals.com>