

# Dell Advanced Projector 7760

## User's Guide



# Notes, Cautions, and Warnings



**NOTE:** A NOTE indicates important information that helps you make better use of your projector



**CAUTION:** A CAUTION indicates potential damage to hardware or loss of data if instructions are not followed.



**WARNING:** A WARNING indicates a potential for property damage, personal injury, or death.

---

**Information in this document is subject to change without notice.  
© 2016 Dell Inc. All rights reserved.**

Reproduction of these materials in any manner whatsoever without the written permission of Dell Inc. is strictly forbidden.

Trademarks used in this text: Dell and the DELL logo are trademarks of Dell Inc.; DLP and DLP logo are trademarks of TEXAS INSTRUMENTS INCORPORATED; Microsoft and Windows are either trademarks or registered trademarks of Microsoft Corporation in the United States and/or other countries.

Other trademarks and trade names may be used in this document to refer to either the entities claiming the marks and names or their products. Dell Inc. disclaims any proprietary interest in trademarks and trade names other than its own.

Model: Dell Advanced Projector 7760

September 2016 Rev. A00

# Contents

<b>1</b>	<b>About Your Dell Projector</b> . . . . .	<b>4</b>
	Projector Box Contents . . . . .	4
	Projector Top and Bottom View . . . . .	5
	Projector Connections . . . . .	6
	Remote Control . . . . .	9
<b>2</b>	<b>Adjusting Projector Image</b> . . . . .	<b>13</b>
	Adjusting Projected Zoom . . . . .	13
	Adjusting Projector Focus and Zoom . . . . .	14
	Adjusting Projector Position . . . . .	15
	Adjusting Image Corners . . . . .	17
	Adjusting Image Size . . . . .	18
<b>3</b>	<b>Connecting Wireless Display Adapter</b> . . . . .	<b>21</b>
	Installing Wireless Display Adapter . . . . .	21
	Setting up the Wireless Display Adapter . . . . .	23
	Setting up the Optional Dell WR517 Wireless Receiver . . . . .	24
	Using LAN Display . . . . .	26
<b>4</b>	<b>Troubleshooting</b> . . . . .	<b>34</b>
	Troubleshooting Tips . . . . .	34
	Guiding Signals . . . . .	38
<b>5</b>	<b>Maintenance</b> . . . . .	<b>39</b>
	Replacing Remote Control Batteries . . . . .	39
<b>6</b>	<b>Specifications</b> . . . . .	<b>41</b>
<b>7</b>	<b>Additional Information</b> . . . . .	<b>44</b>
<b>8</b>	<b>Contacting Dell</b> . . . . .	<b>45</b>

# 1

## About Your Dell Projector

---

Your projector comes with all the items shown below. Ensure that you have all the items, and contact Dell if anything is missing.

### Projector Box Contents

---

#### Package Contents

---

Power cable

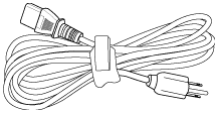

VGA cable (VGA to VGA)

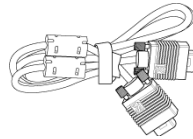

Remote control



AAA Batteries (2)



CD, User's Guide, and Documentation



## Projector Top and Bottom View

Top View

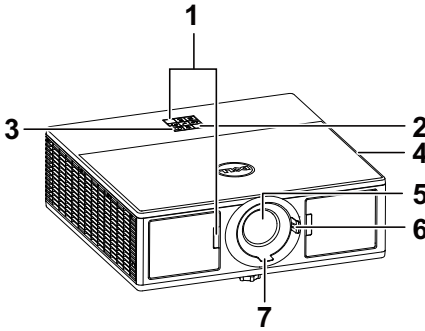

Bottom View

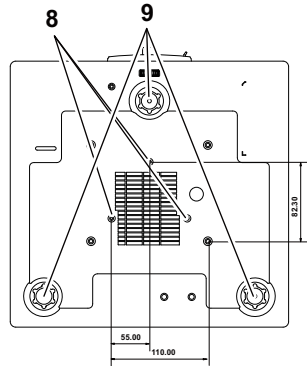

- |   |                                  |
|---|----------------------------------|
| 1 | IR receivers                     |
| 2 | Status indicators                |
| 3 | Power button                     |
| 4 | 20W (2 x 10W) speakers           |
| 5 | Lens                             |
| 6 | Zoom ring                        |
| 7 | Focus ring                       |
| 8 | Mounting holes for ceiling mount |
| 9 | Tilt adjustment wheel            |



**NOTE:** Ceiling mount screw hole M3 x 6.5 mm depth.  
Recommended torque < 15 kgf-cm.

# Projector Connections

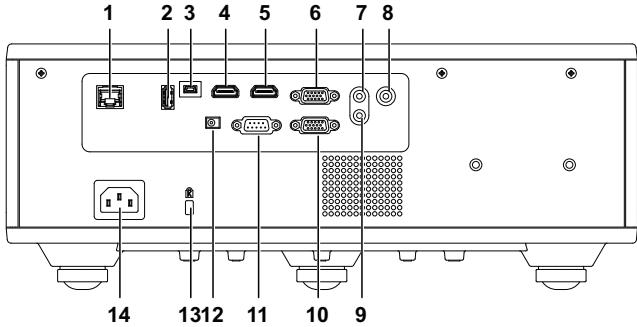

1 RJ45 connector	8 Microphone connector
2 + 5V/1.8A DC out connector	9 Audio output connector
3 Mini USB (mini type B) connector for firmware upgrade	10 VGA output (monitor loop through) connector
4 HDMI 2 connector	11 RS232 connector
5 HDMI 1 connector	12 + 12V DC out connector
6 VGA input connector	13 Security cable slot
7 Audio input connector	14 Power cord connector

**CAUTION:** Before you begin any of the procedures in this section, follow the Safety Instructions as described on page 7.

## **CAUTION: Safety Instructions**

- 1 Do not use the projector near appliances that generate a lot of heat.
- 2 Do not use the projector in areas where there is an excessive amount of dust. The dust may cause the system to fail and the projector will automatically shutdown.
- 3 Ensure that the projector is mounted in a well-ventilated area.
- 4 Do not block the ventilation slots and openings on the projector.
- 5 Ensure the projector operates between ambient temperatures (5 °C to 40 °C).
- 6 Do not try to touch the ventilation outlet as it can become very hot after the projector has been turned on or immediately after it is turned off.
- 7 Do not look into the lens while the projector is on as it may cause injury to your eyes.
- 8 Do not place any objects near or in front of the projector or cover its lens while the projector is on as the heat may cause the object to melt or burn.
- 9 Do not use alcohol to wipe the lens.



### **NOTE:**

- Do not attempt to ceiling mount the projector by yourself. It should be installed by a qualified technician.
- Recommended Projector Ceiling Mount Kit (P/N: C3505). For more information, see the Dell Support website at **dell.com/support**.
- For more information, see the Safety Information that shipped with your projector.
- The 7760 projector can only be used indoors.

 **WARNING: Laser Safety Notice**









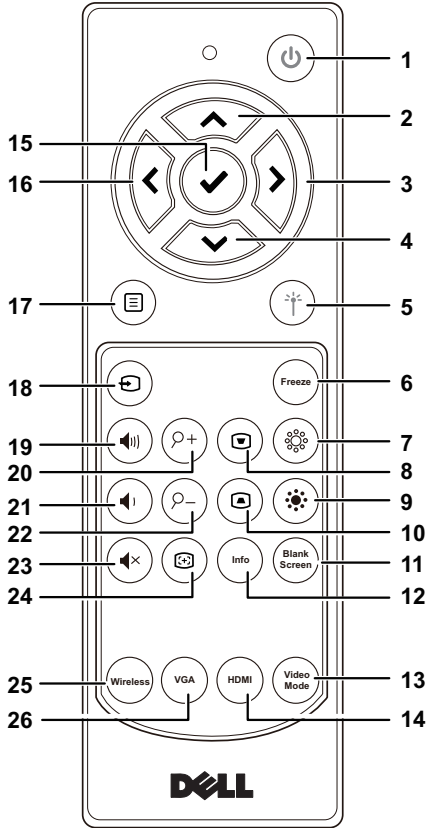





- This projector is a Class 2 laser device that conforms with IEC 60825-1:2007 and CFR 1040.10 and 1040.11.
- Class 2 Laser product - Do not stare into the laser beam.
- This product contains Class-4 laser module. Do not attempt to dismantle the product.
- Any operation or adjustment not specifically instructed by the user's guide creates the risk of hazardous laser radiation exposure.
- Do not stare into beam when the projector is on. The bright light may result in permanent eye damage.
- Without following the control, adjustment or operation procedure may cause damage by the exposure of laser radiation.
- Adequate instructions for assembly, operation, and maintenance, including clear warnings concerning precautions to avoid possible exposure to laser and collateral radiation in excess of the accessible emission limits in Class 2.







## Remote Control



1	Power 	Turns the projector on or off.
2	Up 	Press to navigate through the On-Screen Display (OSD) Menu items.
3	Right 	Press to navigate through the On-Screen Display (OSD) Menu items.
4	Down 	Press to navigate through the On-Screen Display (OSD) Menu items.

5	Laser 	Point the remote control at the screen, press and hold the laser button to activate the laser light.  <b>⚠ WARNING: Do not look at the laser when it is active. Avoid pointing the laser at your eyes.</b>
6	Freeze	Press to pause the screen image, then press "Freeze" again to resume normal projection.
7	Brightness + 	Press to increase the brightness.
8	Keystone adjustment +	Press to adjust image distortion caused by tilting the projector (+/-30 degrees).
9	Brightness - 	Press to decrease the brightness.
10	Keystone adjustment -	Press to adjust image distortion caused by tilting the projector (+/-30 degrees).
11	Blank screen	Press to hide/unhide the image.
12	Info	Press to display the projector information.
13	Video mode	The projector has preset configurations that are optimized for displaying data (presentation slides) or video (movies, games, etc.).  Press the <b>Video Mode</b> button to toggle between <b>Presentation mode</b> , <b>Bright mode</b> , <b>Movie mode</b> , <b>sRGB</b> , or <b>Custom mode</b> .  Pressing the <b>Video Mode</b> button once will show the current display mode. Pressing the <b>Video Mode</b> button again will switch between modes.
14	HDMI	Press to choose HDMI 1 or HDMI 2 source.
15	Enter 	Press to confirm the selection.
16	Left 	Press to navigate through the On-Screen Display (OSD) Menu items.
17	Menu 	Press to activate the OSD.
18	Source 	Press to switch between sources: VGA, HDMI 1, HDMI 2, Wireless Display, and LAN Display.
19	Volume up 	Press to increase the volume.

20	Zoom + 	Press to increase the image.
21	Volume down 	Press to decrease the volume.
22	Zoom - 	Press to decrease the image.
23	Mute 	Press to mute or un-mute the projector speaker.
24	Auto Adjust 	Press to auto adjust the displayed image.
25	Wireless	Press to choose Wireless Display source.
26	VGA	Press to choose VGA source.

## Remote Control Operating Range

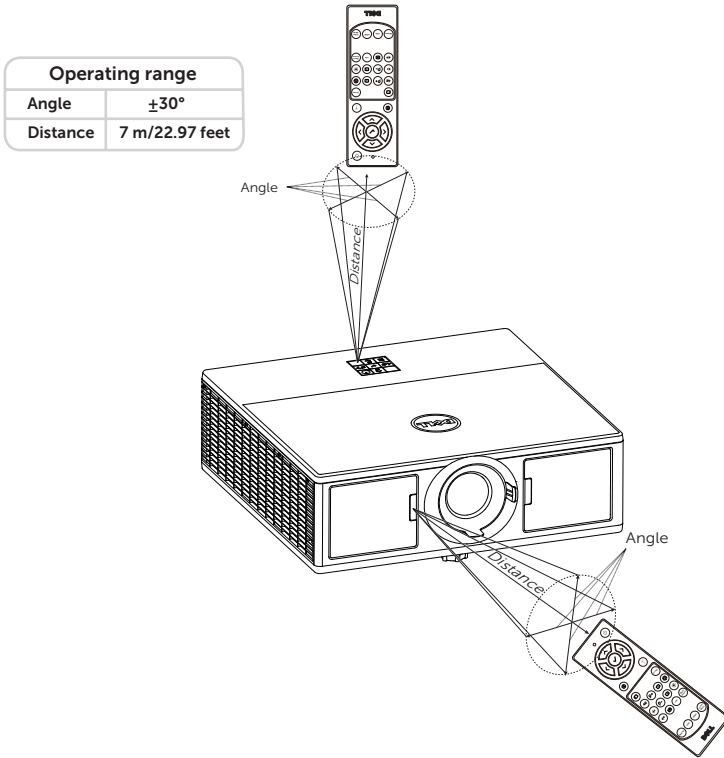

**NOTE:** Actual operating range may slightly differ from the diagram. Weak batteries will also prevent the remote control from properly operating the projector.

# 2

## Adjusting Projector Image

### Adjusting Projected Zoom

#### Raising the Projector Height

- 1 Raise the projector to the desired display angle, and use the front tilt adjustment wheel to fine-tune the display angle.

#### Lowering the Projector Height

- 1 Lower the projector, and use the front tilt adjustment wheel to fine-tune the display angle.

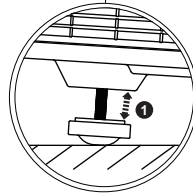
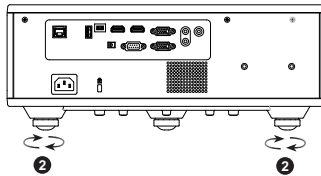
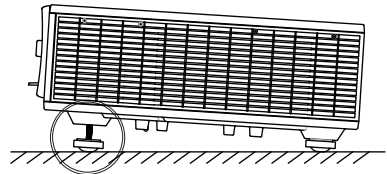
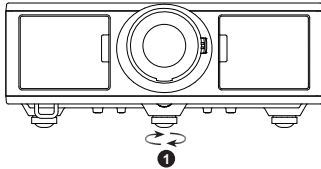

- 
- |   |  |
|---|--|
| 1 | Front tilt adjustment wheel<br>(Angle of tilt: 0 to 3.6 degrees) |
| 2 | Tilt adjustment wheel  |
-

# Adjusting Projector Focus and Zoom

- 1 Open the front side door of the projector.
- 2 Unlock the lens shift lock, before you adjust the lens shift.
- 3 Turn the vertical/horizontal lens shift knob to shift the lens.
- 4 After adjusting the lens shift, lock the lens shift lock.
- 5 Pull the zoom ring adjustment up and down to zoom in and out.
- 6 Rotate the focus ring until the image is clear. The projector focuses at distances ranging between 4.27 ft to 26.25 ft (1.3 m to 8.0 m).
- 7 Close the front side door of the projector.

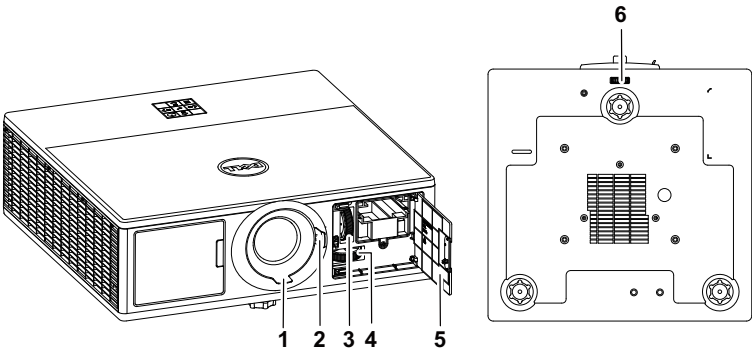

1	Focus ring
2	Zoom ring
3	Vertical lens shift knob
4	Horizontal lens shift knob
5	Front side door
6	Lens shift lock

## Adjusting Projector Position

When you select a position for the projector, consider the size and shape of your screen, the location of your power outlets, and the distance between the projector and the rest of your equipment. Follow these general guidelines:

- Position the projector on a flat surface at a right angle to the screen. The projector (with the standard lens) must be at least 3.28 feet (1 m) from the projection screen.
- Position the projector to the required distance from the screen. The distance from the lens of the projector to the screen, the zoom setting, and the video format determine the size of the projected image.
- Lens throw ratio: 1.2 ~ 2.13
- 360 degree free orientation operation

You can set up or install the 7760 in the following ways:

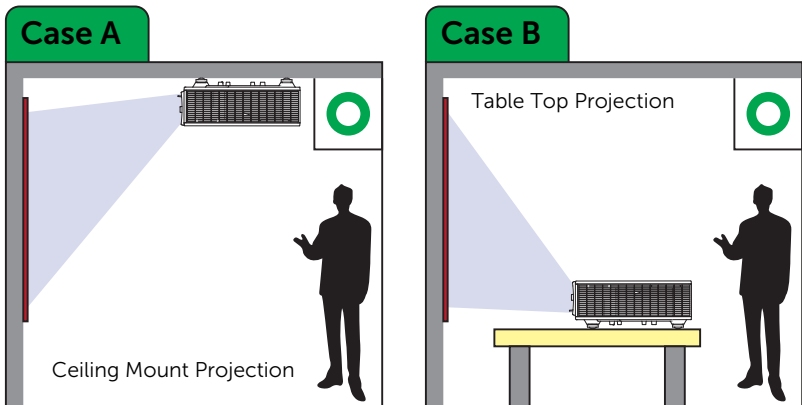

**Case C**

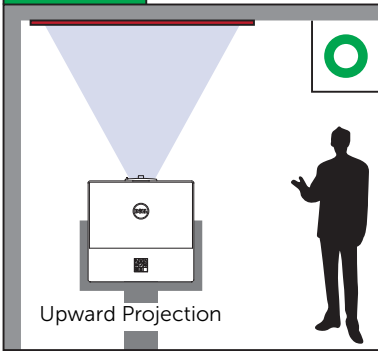

**Case D**

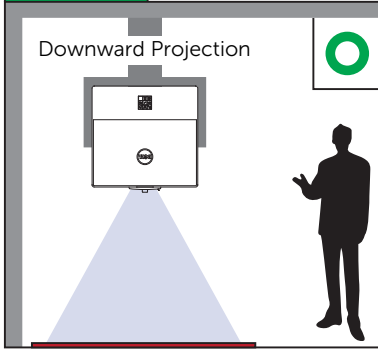

**Case E**

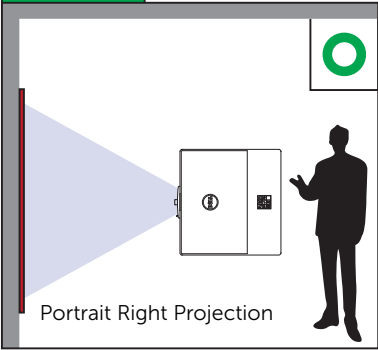

**Case F**

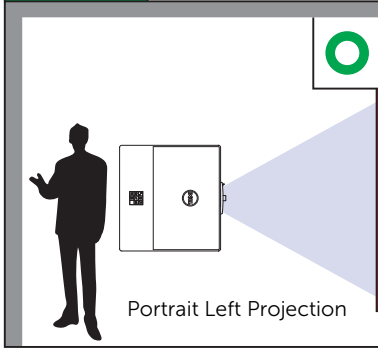



## Adjusting Image Corners



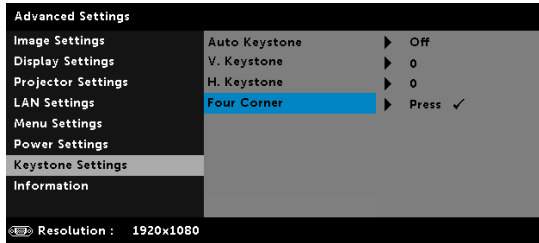

You can use the four corner setting to adjust the shape and size of an image that is unevenly rectangular on all sides.

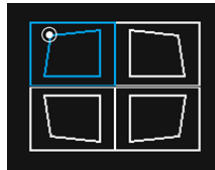

1 Advanced Settings -> Keystone Settings -> Four Corner

2 At four corner screen, use , ,  and  to select one corner and press  to confirm.



3 Use , ,  and  to adjust the image shape as necessary.



4 When you are finished, press "Menu" button to exit.



**NOTE:** The function is unavailable when H./V. Keystone is adjusted.

# Adjusting Image Size

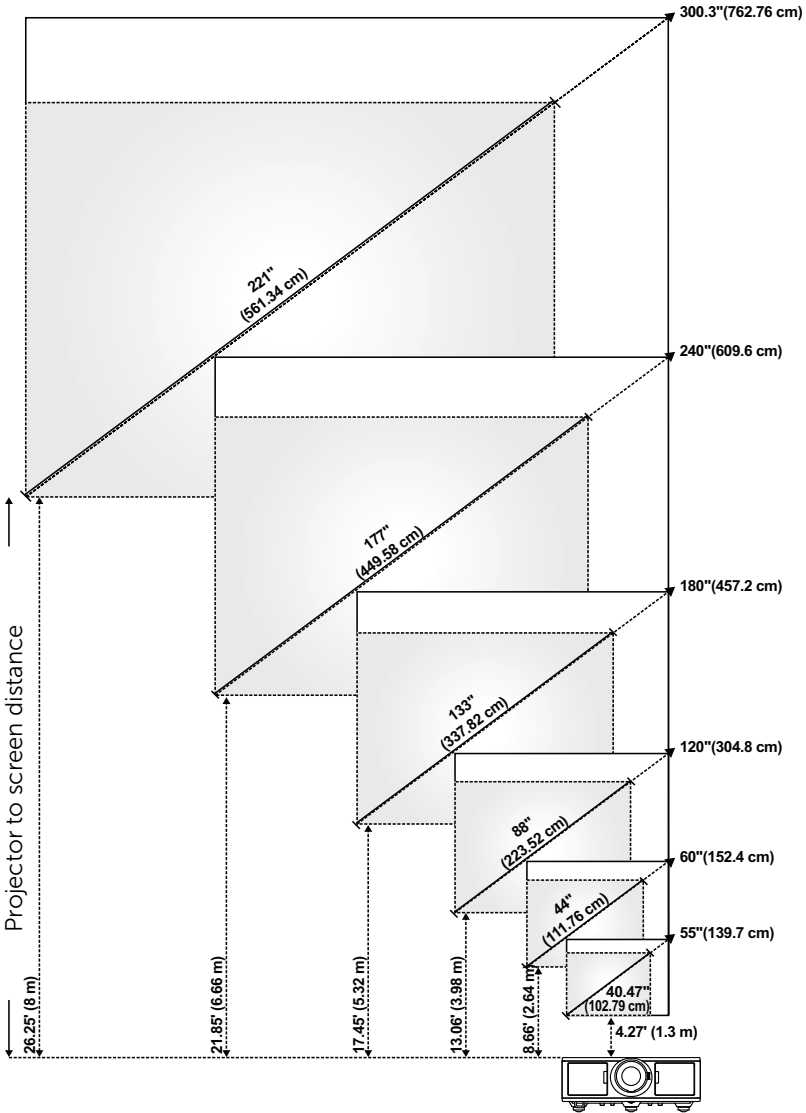

## Adjusting Image Shape

Projection Distance (m) [A]	Min Zoom				
	Image size			Projector base to top of image (cm) [C]	Projector base to bottom of image (cm) [D]
	Diagonal (inch/cm) [B]	Width (cm) [W]	Height (cm) [H]		
1.3	27.2"/69.09 cm	61	34	36	2
2.64	56"/142.24 cm	124	70	73	3
3.98	84"/213.36 cm	187	105	110	5
5.32	113"/287.02 cm	250	140	148	8
6.66	141"/358.14 cm	313	176	185	9
8	169"/429.26 cm	376	211	222	11

Projection Distance (m) [A]	Max Zoom				
	Image size			Projector base to top of image (cm) [C]	Projector base to bottom of image (cm) [D]
	Diagonal (inch/cm) [B]	Width (cm) [W]	Height (cm) [H]		
1.3	49"/124.46 cm	108	61	64	3
2.64	99"/251.46 cm	220	124	130	6
3.98	150"/381 cm	332	187	196	9
5.32	200"/508 cm	443	249	262	13
6.66	251"/637.54 cm	555	312	328	16
8	301.1"/764.79 cm	667	375	394	19

\* This graph is for user reference only.

\* Offset Ratio: 105%~130%

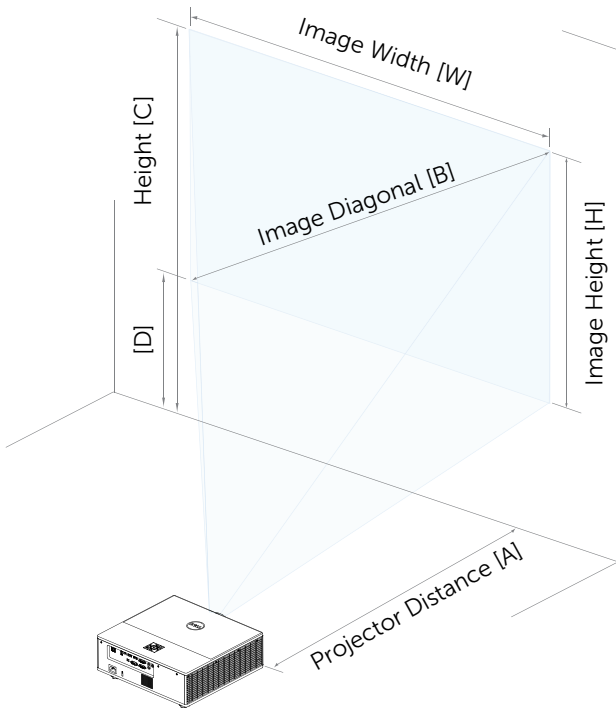

# 3

## Connecting Wireless Display Adapter

### Installing Wireless Display Adapter

Your projector comes with a secured internal compartment for wireless display adapter. The wireless display adapter is not shipped with your 7760 projector. The internal compartment has a HDMI and USB power port.

The installation steps are as below:

- 1 Open the front side door, making sure projector is already powered off.

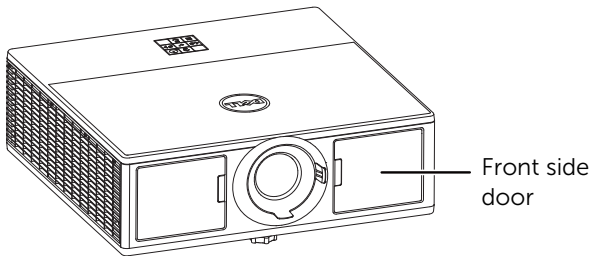

- 2 Attach the power USB cable to the wireless display adapter.

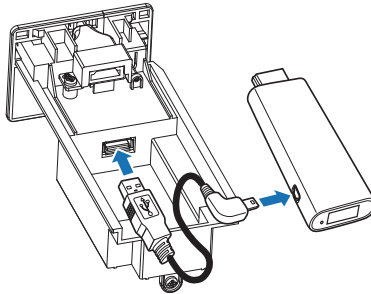

**3** Attach the wireless display adapter.

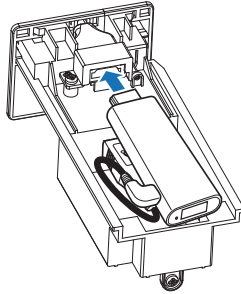

**4** Replace the top cover and tighten the screw.

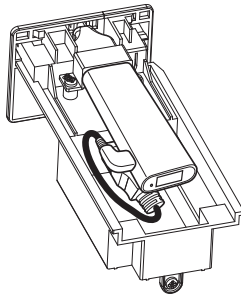

## Setting up the Wireless Display Adapter

1 Power on the projector.

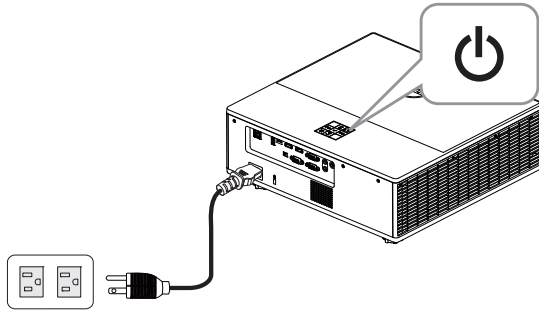

2 Switch to "Wireless Display" source.

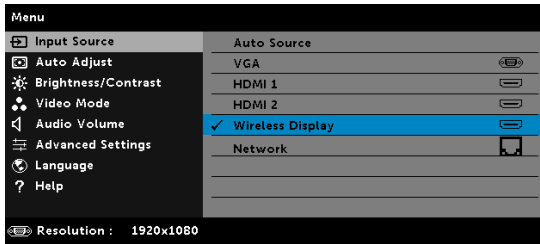

3 Follow the on-screen instructions to proceed with wireless projection.

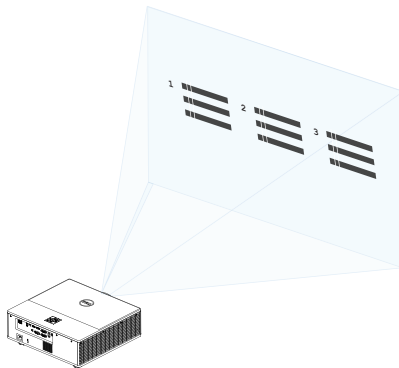

## Setting up the Optional Dell WR517 Wireless Receiver

Dell WR517 wireless receiver enables your Windows laptop computer, Android smartphone or tablet with Miracast capability to display the screen image to Dell 7760 using a Wi-Fi Direct interface.

The Dell WR517 wireless receiver features include:

- Wireless connectivity via IEEE 802.11 ac (Wi-Fi), bluetooth and Screencast.
- The connectivity makes it simple and easy to connect with legacy and new systems.
- Dell Wireless Monitor drivers/app to support additional/enhanced HID sharing features will be included for Windows 10, Windows 8.x and Windows 7.

The Dell wireless module is not shipped with your 7760 projector. You can purchase it on the Dell website at [www.dell.com](http://www.dell.com).

Connecting your Dell WR517 wireless receiver with Dell 7760 projector:

- 1** Use a Philips crosshead screwdriver to fasten the two screws (shipped with the receiver) to the mounting rack on the rear of your projector.
- 2** Align the mounting holes of the Dell WR517 wireless receiver with the two screws that were secured on the rear side of the projector, and then push the receiver downward until it is locked into place.
- 3** Connect the micro USB cable (supplied with the receiver) from the Dell WR517 wireless receiver to the USB port on the projector to get power.
- 4** Connect the HDMI cable (supplied with the receiver) from the Dell WR517 wireless receiver to the projector.
- 5** Connect your USB cable from the Dell WR517 wireless receiver to your USB keyboard and mouse.
- 6** Turn On the projector and the Dell WR517 wireless receiver will be activated at the same time.



Setting up the wireless receiver with a display. Steps 1 & 2.

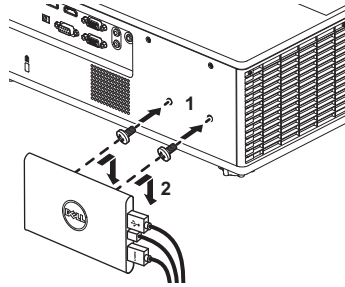

Setting up the wireless receiver with a display. Steps 3, 4 & 5.

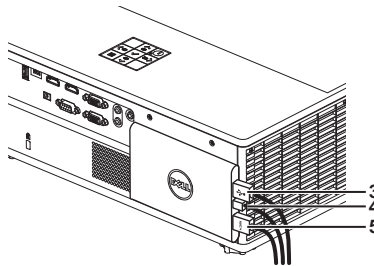

## Using LAN Display

 **NOTE:** LAN display setting steps are the same for Windows and Mac operating system.





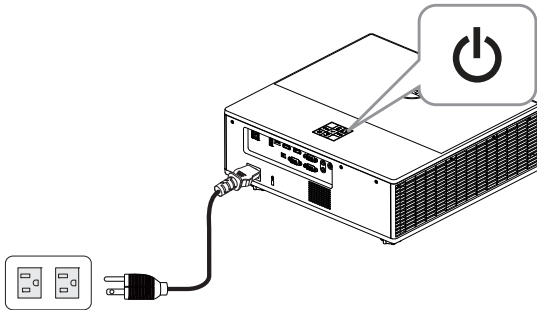

### Enable LAN on Projector

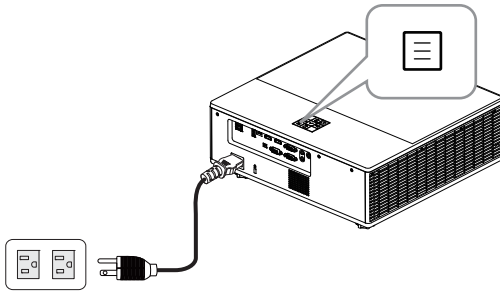
1 Connect the power cable and press the power button.



2 Press the **Menu** button on your projector control panel or remote control.



 **NOTE:** Use , , , and  buttons to navigate and  to select.

3 Ensure DHCP optional is **Off** from LAN settings of Advanced Settings menu.

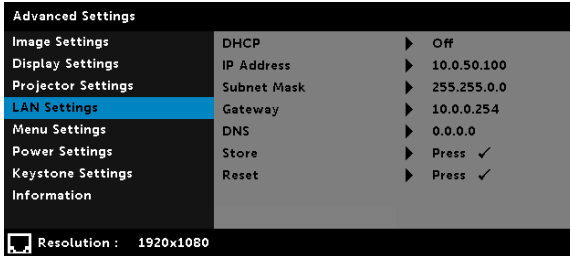

4 Access the **Input Source** menu, and then select **Network** source.

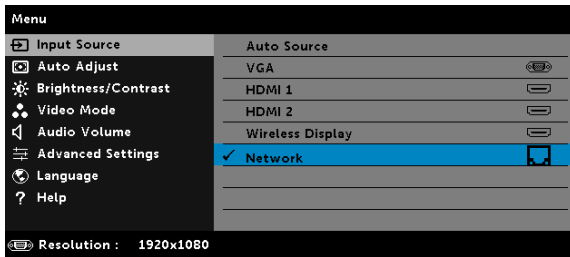

The **LAN Guide Screen** shown below appears:

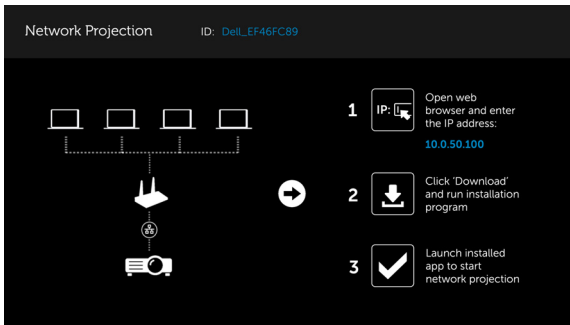

## Install the Dell Network Projection on Your Computer

5 Connect the LAN cable to the projector and the computer.

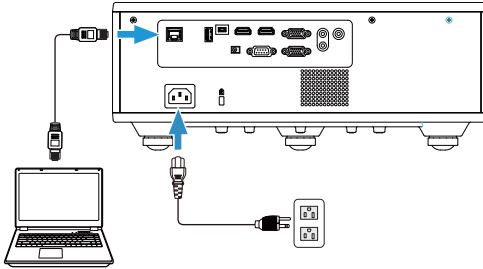

**NOTE:** You can also connect the LAN cable to the projector and the computer via a hub. Follow these steps to settings:

- a DHCP optional change to **On**. Steps: Advanced Settings -> LAN Settings -> DHCP -> On.

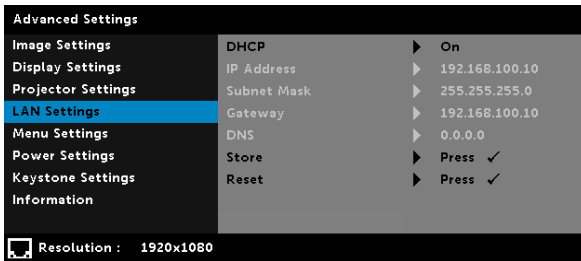

This IP address is generated via the DHCP, it is not the same.

- b Input Source change to **Network** source. Steps: Input Source -> Network (same Step 4).
- c Open the Internet browser on your computer, and enter the **192.168.100.10** (as on-screen) in the browser's address bar.
- d Go to **Step 8**.

6 Open and enter the Internet Protocol (TCP/IP) on your computer, please enter IP address and Subnet mark, then click OK.

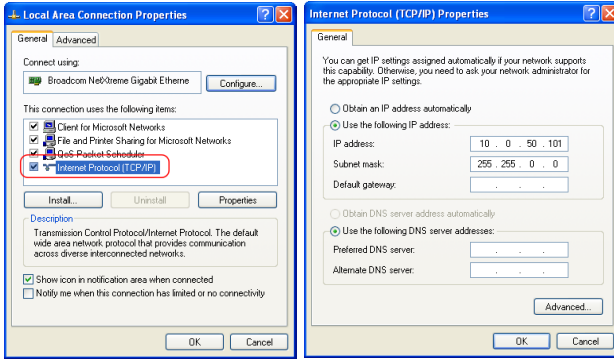

7 Open the Internet browser on your computer, and enter the **10.0.50.100** (default) in the browser's address bar. You will be directed to the **Dell 7760 Web Management page**.

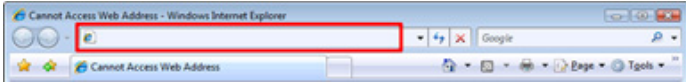

8 The 7760 Web Management page opens. For first-time use, click **Download**.

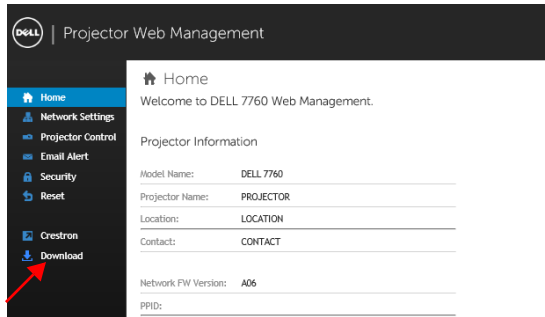

9 At **Download** page, select the appropriate operating system, and click **Download Network Projection App** and install it on your computer.

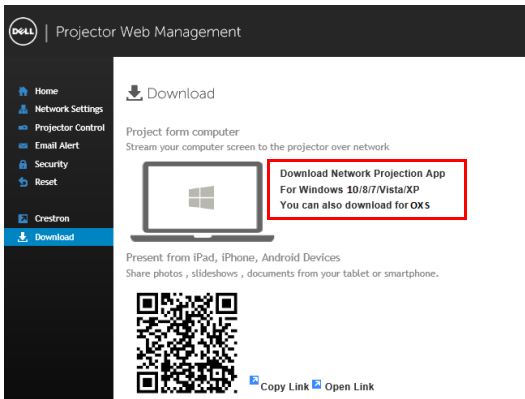

**NOTE:** If you are unable to install the application because of inadequate rights on the computer, please contact your network administrator.

- 10 Click **Run** to proceed with the one-time installation of the software.
- 11 The installation software will launch. Follow the on-screen instructions to complete setup.

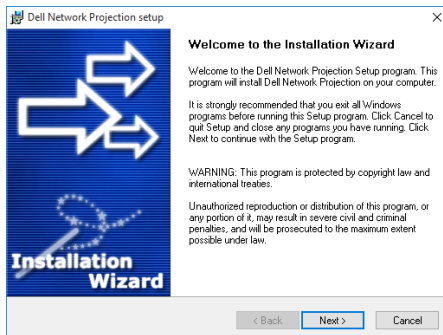

### Launch the Dell Network Projection App

Once the installation is completed, you can double-click  icon on the desktop to start the application.

The **Dell Network Projection Screen** shown below appears:

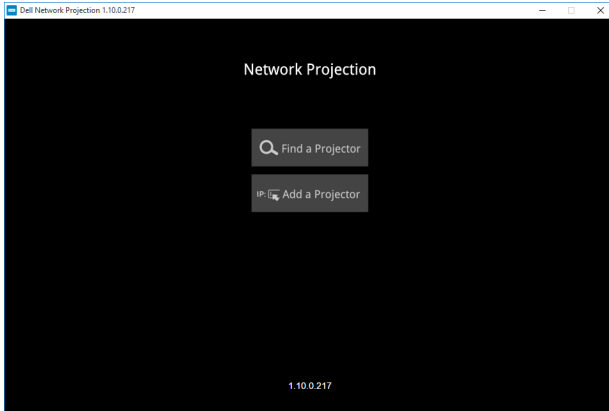

12 At **Dell Network Projection** screen, click **Find a Projector**, and then select **Dell\_42FE21E1** (random code)..

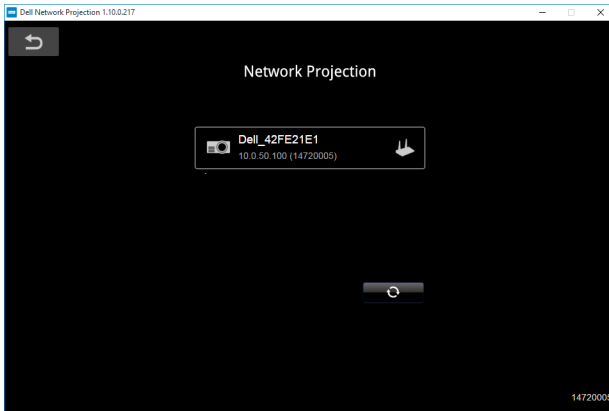



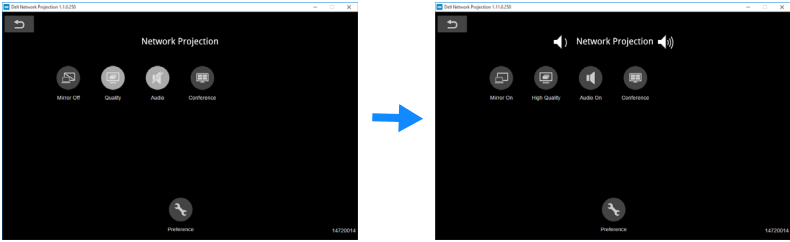



13 Click **Mirror Off** option to start the Dell 7760 network projection.

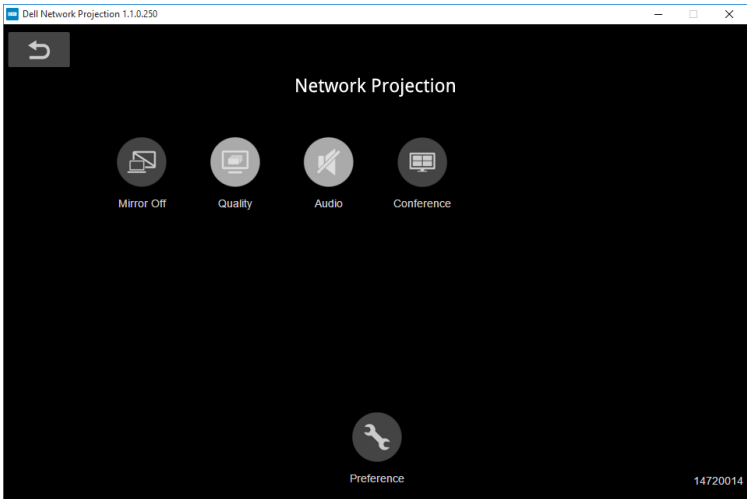



## Understanding the Buttons



Item	Description
<b>Control Toolbar</b>	
 Mirror Off/On	Click to toggle network projection On/Off and screen extension.
 Quality	Click to toggle High/Low quality.
 Audio	Click to toggle audio On/Off.
 Conference	Click to activate the conference control settings.
 Preference	Click to activate the fast connection settings.

# 4

## Troubleshooting

---

### Troubleshooting Tips

If you experience problems with your projector, see the following troubleshooting tips. If the problem persists, contact Dell.



---



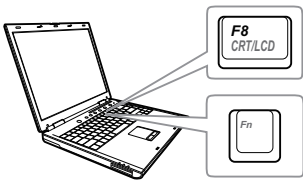

#### Problem

No image appears on the screen



#### Possible Solution

- Ensure that you have chosen the correct input source on the INPUT SOURCE menu.
  - Ensure the external graphics port is enabled. If you are using a Dell laptop computer, press   (Fn+F8). For other computers, see your respective documentation. If images are not displayed properly, please upgrade the video driver of your computer. For Dell computers, see [www.dell.com/support](http://www.dell.com/support).
  - Ensure that all the cables are securely connected. See "Adjusting Projector Image" on page 13.
  - Ensure that the pins of the connectors are not bent or broken.
  - Use the Test Pattern in the Projector Settings of the Advanced Settings menu. Ensure that the colors of the test pattern are correct.
-

Problem (continued)	Possible Solution (continued)
Partial, scrolling, or incorrectly displayed image	<p><b>1</b> Press the Auto Adjust button on the remote control.</p> <p><b>2</b> If you are using a Dell laptop computer, set the resolution of the computer to 1080p (1920 x 1080):</p> <ul style="list-style-type: none"> <li><b>a</b> Right-click the unused portion of your Microsoft® Windows® desktop, click <b>Properties</b>, and then select <b>Settings</b> tab.</li> <li><b>b</b> Verify that the setting is 1920 x 1080 pixels for the external monitor port.</li> <li><b>c</b> Press   (Fn+F8).</li> </ul> <p>If you experience difficulty in changing resolutions, or if your monitor freezes, restart all the equipment and the projector.</p> <p>If you are not using a Dell laptop computer, see your documentation. If images are not displayed properly, please upgrade the video driver of your computer. For a Dell computer, see <a href="http://www.dell.com/support">www.dell.com/support</a>.</p>
The screen does not display your presentation	If you are using a portable computer, press   (Fn+F8).
Image is unstable or flickering	Adjust the tracking in the OSD <b>Display Settings</b> of the <b>Advanced Settings</b> menu (in PC Mode only).
Image has vertical flickering bar	Adjust the frequency in the OSD <b>Display Settings</b> of the <b>Advanced Settings</b> menu (in PC Mode only).

Problem (continued)	Possible Solution (continued)
Image color is incorrect	<ul style="list-style-type: none"> <li>• If the display receives the wrong signal output from the graphics card, please set the signal type to <b>RGB</b> in the OSD <b>Image Settings</b> of the <b>Advanced Settings</b> tab.</li> <li>• Use <b>Test Pattern</b> in the <b>Projector Settings</b> of the <b>Advanced Settings</b> menu. Ensure that the colors of the test pattern are correct.</li> </ul>
Image is out of focus	<ol style="list-style-type: none"> <li>1 Adjust the focus ring on the projector lens.</li> <li>2 Ensure that the projection screen is within the required distance from the projector (4.27 ft [1.3 m] ~ 26.25 ft [8 m]).</li> </ol>
The image is stretched when displaying a 16:9 DVD	<p>The projector automatically detects the input signal format. It will maintain the aspect ratio of the projected image according to the input signal format with an Original setting.</p> <p>If the image is still stretched, adjust the aspect ratio in the Display Settings of the Advanced Settings menu in the OSD.</p>
Image is reversed	<p>Select <b>Projector Settings</b> of the <b>Advanced Settings</b> from the OSD and adjust the projector mode.</p>
TEMP light is solid amber	<p>The projector has overheated. The display automatically shuts down. Turn the display on again after the projector cools down. If the problem persists, contact Dell.</p>
TEMP light is blinking amber	<p>If the projector fan fails, the projector will automatically shut down. Try to clear the projector mode by pressing and holding the <b>Power</b> button for 10 seconds. Please wait for about 5 minutes and try to power up again. If the problem persists, contact Dell.</p>

---

<b>Problem (continued)</b>	<b>Possible Solution (continued)</b>
The remote control is not operating smoothly or works only within a limited range	The battery may be low. If so, replace with two new AAA batteries.
LAN control support	<ul style="list-style-type: none"><li>• Web Control functions were verified on IE9, IE10, and IE11. The other version may have compatibility problem.</li><li>• The Compatibility View setting should be disabled. Otherwise the web control page may have icon or content display abnormal issue.</li></ul>

---

# Guiding Signals

Projector Status	Description	Control Buttons		Indicator	
		Power	TEMP (Amber)	LAMP (Amber)	
Standby mode	Projector in Standby mode. Ready to power on.	White Flashing	OFF	OFF	OFF
Warming up mode	Projector takes some time to warm up and power on.	White	OFF	OFF	OFF
LD on	Projector in Normal mode, ready to display an image.  Note: The OSD menu is not accessed.	White	OFF	OFF	OFF
Cooling mode	Projector is cooling to shutdown.	White	OFF	OFF	OFF
Projector overheated	Air vents might be blocked or ambient temperature may be above 40°C. The projector automatically shuts down. Ensure that the air vents are not blocked and that the ambient temperature is within operational range. If the problem persists, contact Dell.	OFF	AMBER	OFF	OFF
Fan breakdown	One of the fans has failed. The projector automatically shuts down. If the problem persists, contact Dell.	OFF	AMBER Flashing	OFF	OFF
LD driver overheated	Air vents might be blocked or the LD driver has overheated. The projector will automatically shut down. Turn the display on again after the projector cools down. If the problem persists, contact Dell.	AMBER	AMBER	OFF	OFF
Color Wheel breakdown	Color wheel cannot start. The projector has failed and the projector automatically shuts down. Unplug the power cord after three minutes and then turn on the projector. If this problem persists, contact Dell.	White	AMBER Flashing	AMBER Flashing	AMBER Flashing
LD failure	LD is defective.	OFF	OFF	AMBER	AMBER
Fault - DC supply (+12V)	Power supply has been interrupted. The projector automatically shuts down. Unplug the power cord after three minutes and then turn on the projector. If this problem persists, contact Dell.	AMBER Flashing	AMBER	AMBER	AMBER

# 5

## Maintenance

### Replacing Remote Control Batteries

 **NOTE:** Remove the batteries from the remote control when not in use.

1 Press the tab to lift the battery compartment cover.

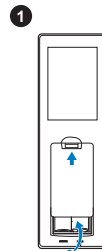

2 Check the polarity (+/-) marking on the batteries.

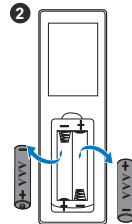

3 Insert the batteries and align their polarity correctly according to the marking in the battery compartment.

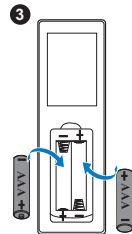

 **NOTE:** Avoid mixing different types of batteries or using new and old batteries together.

4 Slip the battery cover back.

4

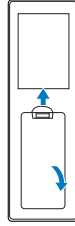



# 6

## Specifications

---

Light Valve	0.65" 1080p S600HB DMD, DarkChip3™
Brightness	5400 ANSI Lumens (Max.)
Contrast Ratio	1800:1 Typical (Full On/Full Off) 100000:1 High Contrast Ratio
Uniformity	85% Typical (Japan Standard - JBMA)
Number of Pixels	1920 x 1080 (1080p)
Aspect Ratio	16:9
Displayable Color	1.07 billion colors
Color Wheel Speed	2 X for Normal 1 X for 3D Display
Projection Lens	F-Stop: F/2.5~3.39 Focal length, f=17.63~31.36 mm 1.78X manual Zoom Lens Throw ratio =1.2~2.13 wide and tele Offset ratio: 105%~130%
Projection Screen Size	27.2 ~ 301.1 inches (diagonal)
Projection Distance	4.27 ~ 26.25 ft (1.3 ~ 8 m)
Video Compatibility	Component Video input via VGA: 1080i (50/60 Hz), 720p (50/60 Hz), 576i/p, 480i/p HDMI input: 1080p, 720p, 576i/p, 480i/p
Power Supply	Universal AC 100-240 V 50-60 Hz with PFC input
Power Consumption	Normal mode: 455 W $\pm$ 15% @ 110 Vac Eco mode: 280 W $\pm$ 15% @ 110 Vac Standby mode: < 0.5 W Network standby: < 3 W



**NOTE:** By default, the projector is set to enter power saving mode after 20 minutes of no activity.

Audio	2 speakers x 10 watt RMS
Noise Level	Normal mode: 36 dB(A) Eco mode: 32 dB(A)
Projector Weight	< 24.47 lbs (11.1 Kg)
Dimensions (W x D x H)	15.94 x 15.24 x 5.08 inches (405 x 387 x 129 mm)

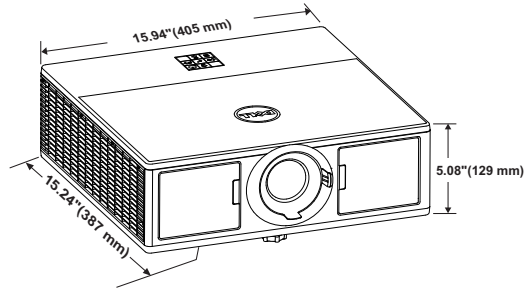

Environmental	<p>Operating temperature: 5 °C - 40 °C (41 °F- 104 °F) Humidity: 80% maximum</p> <p>Storage temperature: 0 °C to 60 °C (32 °F to 140 °F) Humidity: 90% maximum</p> <p>Shipping temperature: -20 °C to 60 °C (-4 °F to 140 °F) Humidity: 90% maximum</p>
I/O Connectors	<p>Power: One AC power socket (3-pin - C14 inlet)</p> <p>VGA input: One 15-pin D-sub connector (Blue), VGA In, for analog RGB/Component input signals.</p> <p>VGA output: One 15-pin D-sub connector (Black) for VGA-A loop through.</p> <p>HDMI input: Three HDMI connectors (one in the internal compartment) for supporting HDMI 1.4a. specification HDCP compliant.</p> <p>Analog Audio input: One 3.5 mm stereo mini phone jack (Blue).</p> <p>Variable audio output: One 3.5 mm stereo mini phone jack (Green).</p>

Light Source

Microphone input: One 3.5 mm stereo mini phone jack (Pink).

USB (type B) port: One mini USB slave for firmware upgrade.

5V/1.8A output: Two USB type A 5V DC / 1.8 A outputs (one in internal compartment) for supporting wireless display dongle.

RS232 port: One 9-pin D-sub for RS232 communication.

RJ-45 port: One RJ-45 connector for build-in for network control and LAN display.

12 V output: One 12V DC / 200 mA max. relay output for driver automatic screen.

Up to 20,000 hours in Normal mode

# 7

## Additional Information

---

For additional information on how to use your projector, please see the **Dell Projectors User Guide** at [www.dell.com/support/manuals](http://www.dell.com/support/manuals).

# 8

## Contacting Dell

---

For customers in the United States, call 800-WWW-DELL (800-999-3355).



**NOTE:** If you do not have an active Internet connection, you can find contact information on your purchase invoice, packing slip, bill, or Dell product catalog.

Dell provides several online and telephone-based support and service options. Availability varies by country and product, and some services may not be available in your area. To contact Dell for sales, technical support, or customer service issues:

- 1 Visit go to [www.dell.com/contactDell](http://www.dell.com/contactDell).
- 2 Select your region on the interactive map.
- 3 Select a Segment for Contact.
- 4 Select the appropriate service or support link based on your need.

# Index

## A

Adjusting Projector Focus 14

Adjusting the Projected Image

Adjusting the Projector

Height 13

lower the projector

Front tilt adjustment  
wheel 13

Tilt adjustment wheel  
13

Adjusting the Projector Zoom  
and Focus

Focus ring 14

Front side door 14

Horizontal lens shift knob 14

Lens shift lock 14

Vertical lens shift knob 14

Zoom ring 14

## C

Connecting the Projector

To Computer 21

Connection Ports

+ 12V DC out connector 6

+ 5V/1.8A DC out connector  
6

Audio input connector 6

Audio output connector 6

HDMI 1 connector 6

HDMI 2 connector 6

Microphone connector 6

Mini USB (mini type B)  
connector for firmware  
upgrade 6

Power cord connector 6

RJ45 connector 6

RS232 connector 6

Security cable slot 6

VGA input connector 6

VGA output (monitor loop  
through) connector 6

Contact Dell 4

## D

Dell

contacting 44, 45

## M

Main Unit 5

20W (2 x 10W) speakers 5

Focus ring 5

IR receivers 5

Lens 5

Mounting holes for ceiling  
mount 5

Power button 5

Status indicators 5

Tilt adjustment wheel 5

Zoom ring 5

## **P**

phone numbers 45

## **R**

Remote Control 9

Replacing 39

## **S**

Specifications

Aspect Ratio 41

Audio 42

Brightness 41

Color Wheel Speed 41

Contrast Ratio 41

Dimensions 42

Displayable Color 41

Environmental 42

I/O Connectors 42

Light Valve 41

Noise Level 42

Number of Pixels 41

Power Consumption 41

Power Supply 41

Projection Distance 41

Projection Lens 41

Projection Screen Size 41

Projector Weight 42

Uniformity 41

Video Compatibility 41

support

contacting Dell 44, 45

## **T**

telephone numbers 45

## Free Manuals Download Website

<http://myh66.com>

<http://usermanuals.us>

<http://www.somanuals.com>

<http://www.4manuals.cc>

<http://www.manual-lib.com>

<http://www.404manual.com>

<http://www.luxmanual.com>

<http://aubethermostatmanual.com>

Golf course search by state

<http://golfingnear.com>

Email search by domain

<http://emailbydomain.com>

Auto manuals search

<http://auto.somanuals.com>

TV manuals search

<http://tv.somanuals.com>