

DE300/300P/400/400P/DH400P/DE500/500P/DE650P

## DEHUMIDIFIER

DEHUMIDIFIER USE AND MAINTENANCE MANUAL  
SAVE THESE INSTRUCTIONS

## DÉSHUMIDIFICATEUR

MODE D'EMPLOI  
CONSERVEZ CE MODE D'EMPLOI

## DESHUMIDIFICADOR

INSTRUCCIONES PARA EL USO  
REPASE Y GUARDE ESTAS INSTRUCCIONES  
LEA CUIDADOSAMENTE ESTE INSTRUCTIVO ANTES DE USAR SU APARATO

## DEUMIDIFICATORE

ISTRUZIONI D'USO  
CONSERVARE LE PRESENTI ISTRUZIONI

Register this product on-line and receive a free trial issue of "Cook's Illustrated". Visit [www.delonghi-registration.com](http://www.delonghi-registration.com). Visit [www.delonghi.com](http://www.delonghi.com) for a list of service centers near you. (U.S. and Canada).

Veillez enregistrer ce produit on-line et Vous recevrez une copie gratuite du magazine "Cook's Illustrated". Visitez [www.delonghi-registration.com](http://www.delonghi-registration.com).

Visitez [www.delonghi.com](http://www.delonghi.com) pour trouver le centre d'assistance le plus proche de chez vous (U.S. et Canada).

Registre su producto en nuestra web y reciba una muestra de prueba de "Cook's Illustrated". visite [www.delonghi-registration.com](http://www.delonghi-registration.com). Visite [www.delonghi.com](http://www.delonghi.com) para consultar la lista de nuestros centros de asistencia más cercanos (ee. uu. y Canada).

Registrate questo prodotto on-line e riceverete una copia gratuita della rivista "Cook's Illustrated". Visitate [www.delonghi-registration.com](http://www.delonghi-registration.com). Visitate il sito [www.delonghi.com](http://www.delonghi.com) per trovare il centro assistenza autorizzato a Voi più vicino (U.S. e Canada).

ELECTRONIC CHARACTERISTICS/CARACTÉRISTIQUES ÉLECTRONIQUES  
CARACTERISTICAS ELECTRICAS/CARATTERISTICHE TECNICHE

115V-60Hz

**DeLonghi**

**T**hank you for choosing this appliance. This Owner's Manual will provide you with valuable information necessary for the proper care and maintenance of your new appliance. If properly maintained, your appliance will give you many years of trouble-free operation. Please take a few moments and read the instructions thoroughly and familiarize yourself with all of the operational aspects of this appliance.

This unit can be conveniently moved from room to room within your home and set-up in just minutes.

## IMPORTANT SAFEGUARDS

Read all instructions before using this dehumidifier. To reduce the risk of fire, electric shock, or injury to persons when using your dehumidifier follow basic safety precautions, including the following:

- 1) **After transporting the appliance, wait 1 hour before using it.**
- 2) Do not store or use gasoline, oil, sulphur or other flammable vapors and liquids in the vicinity of this or any other appliance. Do not install the appliance near source of heat. Read product labels carefully. Common sense and caution must be used when installing, operating and maintaining any appliance.
- 3) This appliance must be used by adults only. Do not allow children to play with the appliance. Do not leave children unattended in an area where the appliance is operating. Do not allow them to sit or stand on the appliance.
- 4) This appliance is designed to dehumidify domestic living areas, and must not be used for other purposes. It must be operated in an enclosed area to be most effective. Close all doors, windows, and other outside openings to the room.
- 5) The appliance must not be modified in any way, as any modifications may be extremely dangerous.
- 6) Do not operate any appliance with a damaged cord or plug or after the appliance malfunctions, or has been damaged in any manner. Return appliance to the nearest authorized service facility for examination, repair or adjustment.
- 7) The use of accessory attachments is not recommended by the appliance manufacturer. It may cause injuries.
- 8) Do not use outdoors.
- 9) For your safety and protection, this dehumidifier is equipped with a three prong grounding plug on the power cord. **Do not, under any circumstances, cut or remove the round grounding prong from the plug.**
- 10) Your dehumidifier must plug directly into a properly grounded and polarized three-prong outlet. If the wall outlet will not accept a three prong plug, or if you are not sure the outlet is adequately grounded or protected by a time delay fuse or circuit breaker, have a qualified electrician install the proper outlet. **Do not use an extension cord or an adapter plug.**
- 11) Never unplug the dehumidifier by pulling on the power cord. Always grip the plug firmly and pull straight out from the outlet. Do not pinch, bend, or knot the power cord.
- 12) Always remove the plug from the socket before performing cleaning or maintenance operations and when not in use.
- 13) Do not place heavy or hot objects on the top of the appliance.
- 14) Clean the air filter at least once a week.
- 15) The appliance must always remain upright or laid on one side during transportation. Remember to drain the tank before transporting the appliance.
- 16) **WARNING:** Handling the cord on this product will expose you to lead, a chemical known to the State of California to cause (cancer, and) birth defects or other reproductive harm. Wash hands after handling.

## SAVE THESE INSTRUCTIONS

### THIS PRODUCT IS FOR HOUSEHOLD ONLY

# Description

## Description of the appliance

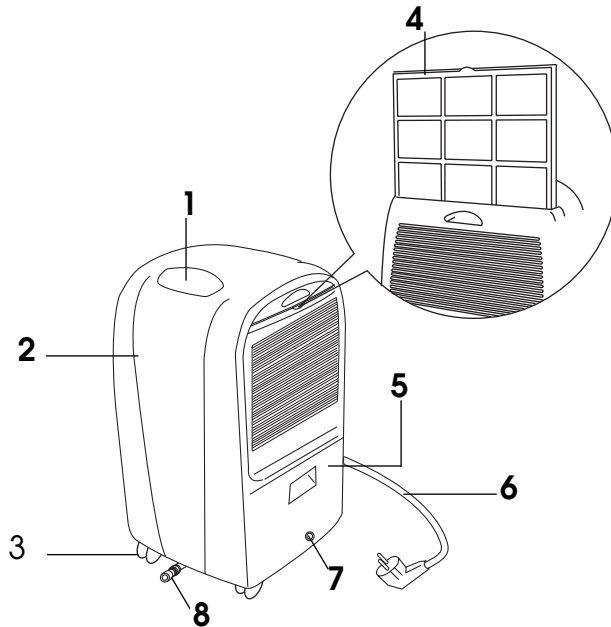

- 1. Control panel
- 2. Cabinet
- 3. Wheels
- 4. Air Filter
- 5. Water Tank
- 6. Power Cord
- 7. Continuous Draining Outlet
- 8. Pump connection (only on some models)

## Description of the control panel

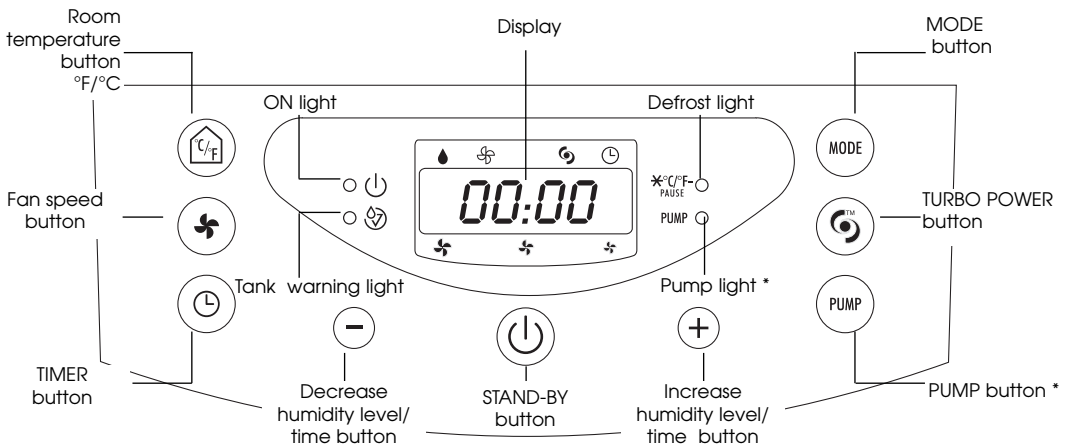

\* (only on some models)

## STAND-BY button

Press this button to start /stop the appliance. To turn the appliance completely off, remove the plug from the outlet.

## Room temperature button

Press this button to display the Temperature on the LCD display. If you press the button once the display will show the °F . If you press the button twice, the display will show the temperature in °C. After few seconds, the display will automatically show the humidity level.

## FAN speed button

Press this button to select the Fan Speed (High, Medium, Low).

## Decrease or increase Humidity Level/ Time buttons

These buttons are used to adjust the desired humidity level, with 5% increments; they are also used to set the timer.

From 0 -10 the hours increase by 30 min. and from 10-24 the hours increase by 1 hour increments.

## TIMER button

With the appliance switched ON, if you press the TIMER button the display will show the hours after which you want the appliance to switch OFF (1-2-3... hours).

With the appliance in the STAND-BY position, if you press the TIMER button the display will show the hours after which you want the appliance to switch ON (1-2-3... hours).

## MODE button

Press this button to select the **Fan only** or **Dehumidifier** modes.

## TURBO POWER button

Use this button to activate the "turbo power" function. In this mode, the appliance will operate at maximum fan speed and in continuous mode. If pressed again, the unit will revert back to previous settings.

## PUMP button (only on pump models)

Use this button to activate the heavy-duty pump system for active drainage.

# Display lights

## **O**N light

When the STAND-BY button is pressed to start the unit, the ON light will come on automatically. The light will go off again when the unit is switched off.

**NOTE:** After a power outage, the unit will not switch itself on again automatically. When the power supply has been reestablished, please press the STAND-BY button to start the unit again.

## **T**ANK Warning light

If the water tank is full, improperly positioned or missing, the tank warning light will start blinking.

An alarm will sound until the tank is either emptied or correctly positioned into place.

## **D**EFROSTING light

With an ambient temperature of less than 15°C, (59°F) the appliance performs defrosting cycles.

While the appliance is defrosting, the defrosting light comes on and remains on until defrosting is completed.

During the defrosting cycle only the following 4 keys are active:

pump button, stand-by button, temperature button, timer button.

## **P**UMP light (only on some models)

Once the pump button is pressed the pump light will switch on.

If the pump light flashes it means that the pump is not functioning properly.

# Installation Instructions

1. Allow at least 12 inches (30cm) of space on all sides of the unit for good air circulation.
2. Install your dehumidifier on a floor, table, or shelf. When installing the unit on a table or shelf, make sure the table or shelf is strong enough to support the weight of the unit with a full bucket.

Note: The dehumidifier needs to be secured when installed on a table or a shelf.  
Do not sit or stand on the dehumidifier.

3. The tank must be properly positioned.
4. Castor wheels let you move the dehumidifier easily.

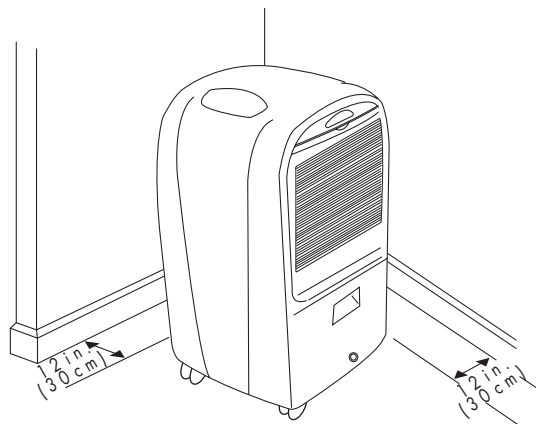
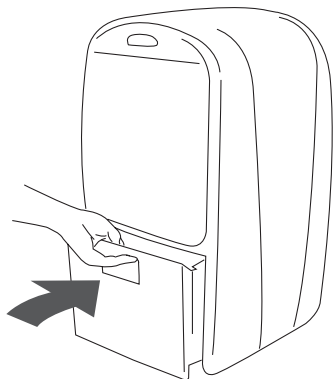

## Choosing the proper location for the unit

1. Use the unit in a basement to help prevent moisture damage.
2. Use the unit in cooking, laundry, bathing, and dishwashing areas that have excessive moisture.
3. Use the unit to prevent moisture damage anywhere books or valuables are stored.
4. Place the unit where you want to have comfortable conditions.

## List of components

For models equipped with pump system:

- 16 ft. (5 m) clear hose with Quick-Connect connection
- 3 ft. (1 m) clear hose

For all other models:

- 3 ft. (1 m) clear hose

## Required tools and assembly time

Collection tank:

No assembly or plumbing necessary.

Continuous draining outlet:

To use the Continuous Draining feature the following tools will be necessary:

- 5 mm (0.2 in.) drill bit (to drill open the draining outlet)
- Drill tool

The estimated assembly time is 1-2 minutes.

Pump system and Quick-Connect 16ft. hose (only on models equipped with pump system):

No tools necessary. The estimated assembly time is 1-2 minutes.

# Disposing of the collected water

## A) Empty the tank manually.

When the tank is full, remove (fig.1) and empty it into a sink.

When finished, replace it properly.

**NOTE:** The tank must be positioned properly. If you hear the intermittent sound of the beep, it means the tank is not in the proper position.

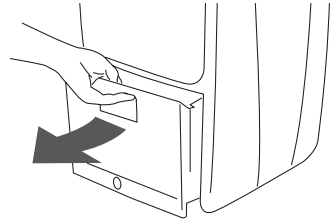

fig. 1

## B) Continuous draining.

Condensed water can be drained via a hose connected to the outlet located in the lower part of the tank proceeding in the following way:

1. remove the water tank.
2. Using a 5 mm drill bit, (0.2 inches) drill a hole in the base of the tank along the torus as shown in figure 2.
3. Connect a hose to the hose connector (fig. 3). Be sure the hose does not kink or bend. Make sure that the hose is not higher than the hose connection (see figure 4).

**NOTE:** When you remove the rubber cap keep it in a safe place in case you want drain into the tank.

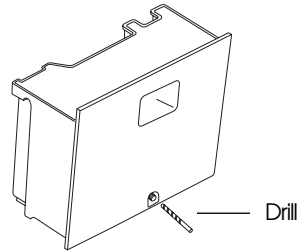

fig. 2

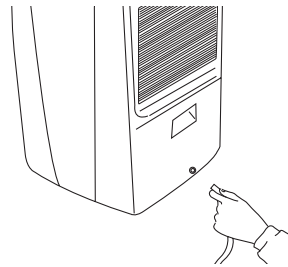

fig. 3

## C) Continuous draining using the pump (only on pump models)

The exclusive heavy-duty pump system allows water removal of up to 13.12 feet (4m) in height. If you want the water to flow directly to a drain, connect the condensation discharge tube supplied to the connection pipe located on the lower part of the unit (Fig. 5).

Select the dehumidifying function and press the PUMP button.

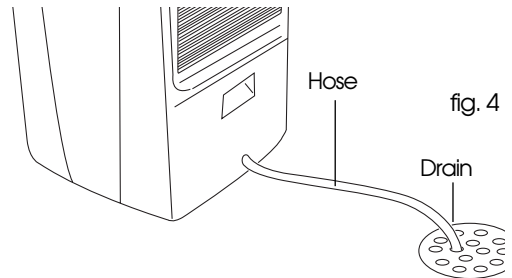

fig. 4

**Note:** With the condensation discharge hose missing and the pump switched ON, the pump light will start blinking. To eliminate this problem:

- Check the hose is correctly positioned;
- Disconnect and reconnect the appliance.

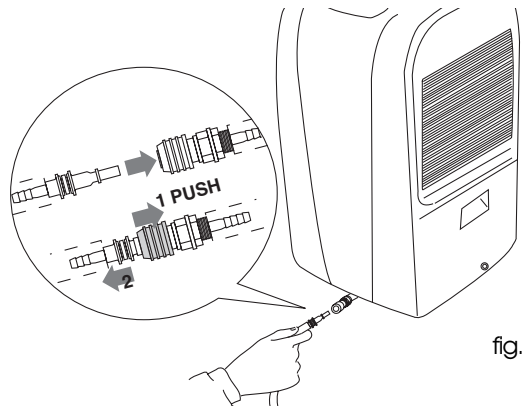





fig. 5

## Stand-by position



Once the power outlet is plugged in, the display will show on the left side the degree of humidity you want to reach (the default data is 60) and on the right side the display will show (for a minute) two dots, followed by the room humidity level.

## How to Select the Desired Humidity Level



- 1) Push the stand-by button.
- 2) Press the   button to set the desired humidity level. (30% means a dry environment, 80% a humid environment).
- 3) Push the MODE button to choose the dehumidifying function; the function is selected when the small dot on the display is under the  symbol).
- 4) When the appliance reaches the humidity set point the appliance will automatically stop working. As soon as the humidity increases above the set point, the appliance will automatically resume dehumidification operation.

**Note: The appliance is equipped with a safety device. The appliance only works after 3 minutes from the last time it was turned off.**





## How to use the FAN function

- 1) Push the stand-by button.
- 2) Push the MODE button to choose the FAN function; the function is selected when the small dot on the display is under the  symbol).
- 3) Press the  button to modify the ventilation speed (min/med/max).

## Turbo power

- 1) Press the  button.
- 2) The turbo power function is an automatic dehumidification function that is used when you wish to operate the appliance at maximum power. When in this mode, the display will show on the left side (two dots) and on the right side the room humidity present. To stop the turbo power function, simply press the  button again.

## How to program the delayed start function: From the OFF Position

- 1) With the unit OFF, press the  button and use the   button to set the number of hours after which the appliance should start functioning.
- 2) On the left side the display will show the number of hours after which the appliance should start the operation (1-24h) and a small dot under the  symbol indicates that the timer function has been selected.
- 3) When the selected time is reached, the appliance will start working.



# Selecting the operations

## **H**ow to Program the delayed stop function: From the ON Position

- 1) Press the ⌚ button and use the (+) (-) button to set the number of hours after which the appliance should stop functioning.
- 2) The left side the display will show the number of hours after which the appliance should stop the operation (1-24h) and a small dot under the ⌚ symbol indicates that the timer function has been selected.
- 3) When the selected time is reached, the appliance will stop working.

## WARNING

### Electrical Shock Hazard

Always disconnect power supply cord from outlet before performing any maintenance. Failure to follow the below precautions could result in the electrical shock or personal injuries.

## Maintenance

Your dehumidifier is designed to serve you year-round. Listed below are the care and maintenance instructions

### Cleaning the Front Panel and Cabinet

- Using a soft cloth, clean the front panel and cabinet with warm water and a mild soap or detergent. **NOTE:** Never sprinkle water into the appliance in order to prevent risk of short-circuit and fire.
- Never use gasoline, thinner or any other similar chemicals for cleaning.
- Do not use bleach or abrasives.

### Cleaning the Air Filter

If the filter is dirty, air circulation is compromised and the efficiency of the dehumidifying decreases. It is therefore good practice to clean the filter at regular intervals. The frequency depends on the duration and conditions of operation.

- To remove the air filter, pull it out (Fig. 6).
- Use a vacuum cleaner to remove dust accumulations from the filter. If the filter is very dirty, wash in warm water and rinse several times.
- After washing the filter, allow it to dry completely before replacing it.

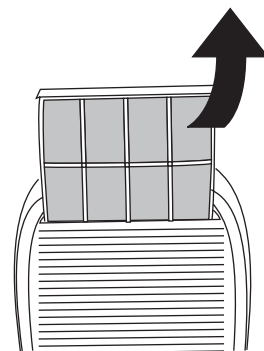

fig. 6

# Troubleshooting tips

Often times, a problem is minor and a service call may not be necessary. Use this troubleshooting guide to identify possible problems you may be experiencing.

Problem	Possible cause	Remedy
Unit does not operate	<ul style="list-style-type: none"> <li>• Check power cord connection.</li> <li>• Check if water tank is full</li> <li>• Check water tank is properly installed.</li> <li>• Check if the unit is not turned on.</li> <li>• The desired humidity may be lower than the room humidity.</li> </ul>	<ul style="list-style-type: none"> <li>• Plug into the power outlet</li> <li>• Empty the tank</li> <li>• Position the tank correctly</li> <li>• Turn the unit on</li> </ul>
Dehumidifying capacity (moisture removal) low	<ul style="list-style-type: none"> <li>• Air filter is dirty and /or blocked.</li> <li>• Ambient room temperature too low.</li> <li>• Poor airflow circulation/obstruction</li> <li>• The desired humidity is lower than the room humidity</li> </ul>	<ul style="list-style-type: none"> <li>• Clean the filter</li> <li>• Increase the room temperature</li> <li>• Improve the airflow</li> </ul>
Relative Humidity setting not reached after long period of operation	<ul style="list-style-type: none"> <li>• There are windows or doors opened</li> <li>• Area/room is too large for the capacity of the dehumidifier</li> </ul>	<ul style="list-style-type: none"> <li>• Check that the doors and the windows are closed.</li> </ul>
The appliance does not work in the 3 minutes since the last switch off	<ul style="list-style-type: none"> <li>• The safety device has been activated</li> </ul>	<ul style="list-style-type: none"> <li>• Wait 3 minutes to pass</li> </ul>
The display shows "E1" / "E2" / "E3"	<ul style="list-style-type: none"> <li>• Contact the Service Center</li> </ul>	
The pump lamp blink	<ul style="list-style-type: none"> <li>• The condensation discharge hose is not positioned correctly or is bent.</li> </ul>	<ul style="list-style-type: none"> <li>• Check the hose is correctly positioned</li> <li>• Disconnect and reconnect the appliance</li> </ul>

# Limited Warranty

This warranty applies to all home appliances with De'Longhi or Kenwood brand names.

FOR CONTIGUOUS UNITED STATES ONLY

## Limited Warranty

We warrant each De'Longhi appliance to be free from defects in material and workmanship. From the purchase date, our obligation under this warranty is to provide one (1) year free parts and labor on the entire appliance, with an additional four (4) years free on any part of the sealed system consisting of the compressor, evaporator, condenser and factory connected refrigerant tubing. Labor and all other parts during the additional four (4) year warranty are to be paid by the owner. All appliances in need of repair are to be shipped to an authorized De'Longhi service center at the owner's expense, and De'Longhi will then incur the return shipping costs. After the first five (5) years of ownership, all expenses (all parts, labor and shipping) are to be paid by the owner of the unit. This warranty shall apply only if the appliance is used in accordance with the factory directions that accompany it, and on an Alternating Current (AC) circuit. This warranty is in lieu of all other warranties and representations, expressed or implied, and all other obligations or liabilities on our part. We do not authorize any other person or company to assume for us any liability in connection with the sale or use of our appliance. This warranty shall not apply to any appliance that has been repaired or altered outside our factory nor shall it apply to any appliance that has been subjected to misuse, negligence or accidents.

If repairs become necessary, see contact information below:

### **U.S. Residents:**

Please contact our toll free hotline at 1-800-322-3848 or log onto our website at [www.delonghi.com](http://www.delonghi.com).

For all accessories, spare parts or replacement parts, please contact our parts division at 1-800-865-6330.

### **Residents of Canada:**

Please contact our toll free hotline at 1-888-335-6644 or log onto our website at [www.delonghi.com](http://www.delonghi.com).

### **Other countries:**

Please visit: [www.delonghi.com](http://www.delonghi.com).

## Free Manuals Download Website

<http://myh66.com>

<http://usermanuals.us>

<http://www.somanuals.com>

<http://www.4manuals.cc>

<http://www.manual-lib.com>

<http://www.404manual.com>

<http://www.luxmanual.com>

<http://aubethermostatmanual.com>

Golf course search by state

<http://golfingnear.com>

Email search by domain

<http://emailbydomain.com>

Auto manuals search

<http://auto.somanuals.com>

TV manuals search

<http://tv.somanuals.com>