

# DENON

AM-FM STEREO RECEIVER

# DRA-37

---

OPERATING INSTRUCTIONS

MODE D'EMPLOI

## SAFETY PRECAUTIONS



**CAUTION**  
**RISK OF ELECTRIC SHOCK**  
**DO NOT OPEN**



### CAUTION:

**TO REDUCE THE RISK OF ELECTRIC SHOCK, DO NOT REMOVE COVER (OR BACK). NO USER-SERVICEABLE PARTS INSIDE. REFER SERVICING TO QUALIFIED SERVICE PERSONNEL.**



The lightning flash with arrowhead symbol, within an equilateral triangle, is intended to alert the user to the presence of uninsulated "dangerous voltage" within the product's enclosure that may be of sufficient magnitude to constitute a risk of electric shock to persons.



The exclamation point within an equilateral triangle is intended to alert the user to the presence of important operating and maintenance (servicing) instructions in the literature accompanying the appliance.

### WARNING:

**TO REDUCE THE RISK OF FIRE OR ELECTRIC SHOCK, DO NOT EXPOSE THIS APPLIANCE TO RAIN OR MOISTURE.**

## SAFETY INSTRUCTIONS

1. Read Instructions – All the safety and operating instructions should be read before the product is operated.
2. Retain Instructions – The safety and operating instructions should be retained for future reference.
3. Heed Warnings – All warnings on the product and in the operating instructions should be adhered to.
4. Follow Instructions – All operating and use instructions should be followed.
5. Cleaning – Unplug this product from the wall outlet before cleaning. Do not use liquid cleaners or aerosol cleaners.
6. Attachments – Do not use attachments not recommended by the product manufacturer as they may cause hazards.
7. Water and Moisture – Do not use this product near water – for example, near a bath tub, wash bowl, kitchen sink, or laundry tub; in a wet basement; or near a swimming pool; and the like.
8. Accessories – Do not place this product on an unstable cart, stand, tripod, bracket, or table. The product may fall, causing serious injury to a child or adult, and serious damage to the product. Use only with a cart, stand, tripod, bracket, or table recommended by the manufacturer, or sold with the product. Any mounting of the product should follow the manufacturer's instructions, and should use a mounting accessory recommended by the manufacturer.
9. A product and cart combination should be moved with care. Quick stops, excessive force, and uneven surfaces may cause the product and cart combination to overturn.
10. Ventilation – Slots and openings in the cabinet are provided for ventilation and to ensure reliable operation of the product and to protect it from overheating, and these openings must not be blocked or covered. The openings should never be blocked by placing the product on a bed, sofa, rug, or other similar surface. This product should not be placed in a built-in installation such as a bookcase or rack unless proper ventilation is provided or the manufacturer's instructions have been adhered to.
11. Power Sources – This product should be operated only from the type of power source indicated on the marking label. If you are not sure of the type of power supply to your home, consult your product dealer or local power company. For products intended to operate from battery power, or other sources, refer to the operating instructions.
12. Grounding or Polarization – This product may be equipped with a polarized alternating-current line plug (a plug having one blade wider than the other). This plug will fit into the power outlet only one way. This is a safety feature. If you are unable to insert the plug fully into the outlet, try reversing the plug. If the plug should still fail to fit, contact your electrician to replace your obsolete outlet. Do not defeat the safety purpose of the polarized plug.
13. Power-Cord Protection – Power-supply cords should be routed so that they are not likely to be walked on or pinched by items placed upon or against them, paying particular attention to cords at plugs, convenience receptacles, and the point where they exit from the product.
15. Outdoor Antenna Grounding – If an outside antenna or cable system is connected to the product, be sure the antenna or cable system is grounded so as to provide some protection against voltage surges and built-up static charges. Article 810 of the National Electrical Code, ANSI/NFPA 70, provides information with regard to proper grounding of the mast and supporting structure, grounding of the lead-in wire to an antenna discharge unit, size of grounding conductors, location of antenna-discharge unit, connection to grounding electrodes, and requirements for the grounding electrode. See Figure A.
16. Lightning – For added protection for this product during a lightning storm, or when it is left unattended and unused for long periods of time, unplug it from the wall outlet and disconnect the antenna or cable system. This will prevent damage to the product due to lightning and power-line surges.
17. Power Lines – An outside antenna system should not be located in the vicinity of overhead power lines or other electric light or power circuits, or where it can fall into such power lines or circuits. When installing an outside antenna system, extreme care should be taken to keep from touching such power lines or circuits as contact with them might be fatal.
18. Overloading – Do not overload wall outlets, extension cords, or integral convenience receptacles as this can result in a risk of fire or electric shock.
19. Object and Liquid Entry – Never push objects of any kind into this product through openings as they may touch dangerous voltage points or short-out parts that could result in a fire or electric shock. Never spill liquid of any kind on the product.
20. Servicing – Do not attempt to service this product yourself as opening or removing covers may expose you to dangerous voltage or other hazards. Refer all servicing to qualified service personnel.
21. Damage Requiring Service – Unplug this product from the wall outlet and refer servicing to qualified service personnel under the following conditions:
  - a) When the power-supply cord or plug is damaged,
  - b) If liquid has been spilled, or objects have fallen into the product,
  - c) If the product has been exposed to rain or water,
  - d) If the product does not operate normally by following the operating instructions. Adjust only those controls that are covered by the operating instructions as an improper adjustment of other controls may result in damage and will often require extensive work by a qualified technician to restore the product to its normal operation,
  - e) If the product has been dropped or damaged in any way, and
  - f) When the product exhibits a distinct change in performance – this indicates a need for service.

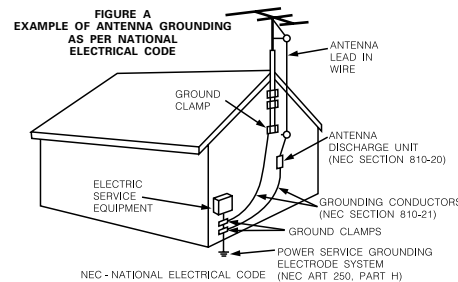

**FCC INFORMATION (For US customers)****1. PRODUCT**

This product complies with Part 15 of the FCC Rules. Operation is subject to the following two conditions: (1) this product may not cause harmful interference, and (2) this product must accept any interference received, including interference that may cause undesired operation.

**2. IMPORTANT NOTICE: DO NOT MODIFY THIS PRODUCT**

This product, when installed as indicated in the instructions contained in this manual, meets FCC requirements. Modification not expressly approved by DENON may void your authority, granted by the FCC, to use the product.

**3. NOTE**

This product has been tested and found to comply with the limits for a Class B digital device, pursuant to Part 15 of the FCC Rules. These limits are designed to provide reasonable protection against harmful interference in a residential installation.

This product generates, uses and can radiate radio frequency energy and, if not installed and used in accordance with the instructions, may cause harmful interference to radio communications. However, there is no guarantee that interference will not occur in a particular installation. If this product does cause harmful interference to radio or television reception, which can be determined by turning the product OFF and ON, the user is encouraged to try to correct the interference by one or more of the following measures:

- Reorient or relocate the receiving antenna.
- Increase the separation between the equipment and receiver.
- Connect the product into an outlet on a circuit different from that to which the receiver is connected.
- Consult the local retailer authorized to distribute this type of product or an experienced radio/TV technician for help.

This Class B digital apparatus complies with Canadian ICES-003.

Cet appareil numérique de la classe B est conforme à la norme NMB-003 du Canada.

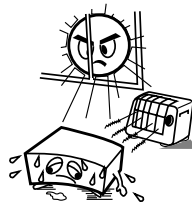
**NOTE ON USE / OBSERVATIONS RELATIVES A L'UTILISATION**

- Avoid high temperatures.  
Allow for sufficient heat dispersion when installed in a rack.
- Eviter des températures élevées  
Tenir compte d'une dispersion de chaleur suffisante lors de l'installation sur une étagère.



- Handle the power cord carefully.  
Hold the plug when unplugging the cord.
- Manipuler le cordon d'alimentation avec précaution.  
Tenir la prise lors du débranchement du cordon.

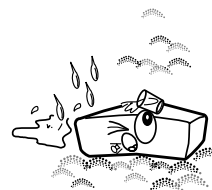

- Keep the apparatus free from moisture, water, and dust.
- Protéger l'appareil contre l'humidité, l'eau et la poussière.

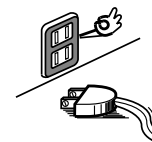

- Unplug the power cord when not using the apparatus for long periods of time.
- Débrancher le cordon d'alimentation lorsque l'appareil n'est pas utilisé pendant de longues périodes.



- \* (For apparatuses with ventilation holes)
- Do not obstruct the ventilation holes.
  - Ne pas obstruer les trous d'aération.



- Do not let foreign objects into the apparatus.
- Ne pas laisser des objets étrangers dans l'appareil.

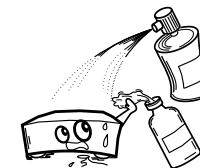

- Do not let insecticides, benzene, and thinner come in contact with the apparatus.
- Ne pas mettre en contact des insecticides, du benzène et un diluant avec l'appareil.

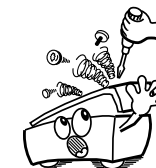

- Never disassemble or modify the apparatus in any way.
- Ne jamais démonter ou modifier l'appareil d'une manière ou d'une autre.

Thank you for choosing the DENON DRA-37 AM-FM Stereo Receiver. This remarkable component has been engineered to provide outstanding high fidelity reproduction of your favorite music sources.

As this product is provided with an immense array of features, we recommend that before you begin hookup and operation that you review the contents of this manual before proceeding.

**Contents**

**Getting Started**

**Accessories** .....1  
**Before using** .....1, 2  
**Cautions on installation** .....2  
 About the remote control unit .....2  
 Inserting the batteries .....2  
**Operating range of the remote control unit** .....2  
**Part names and functions** .....3  
 Front panel .....3  
 Display .....3  
 Rear panel .....4  
 Remote control unit .....4, 5

**Connections**

**Cable indications** .....5  
**Speaker connections** .....6  
**Connecting a DVD player and monitor** .....6  
**Connecting a TV/DBS tuner** .....7  
**Connecting a CD player** .....7  
**Connecting a tape deck, CD recorder or MD recorder** .....7  
**Connecting a VCR** .....7  
**Connecting the antenna terminals** .....7, 8  
**Connecting the XM terminal** .....8  
**Connecting the iPod®** .....9  
**Connecting a room-to-room remote control unit** .....9  
**Connecting the PRE OUT terminals** .....9  
**Connecting the power supply cord** .....9

**Operation**

**Before operating** .....10  
**Playing the input source** .....10  
 Turning the sound off temporarily (MUTING) .....10  
 Listening over headphones .....10  
 Switching the speakers .....10  
 Checking the currently playing program source, etc. ....11  
 Switching the brightness of the display .....11  
 Selecting the play mode (PURE DIRECT) .....11  
 Setting the tone control .....11  
 Adjusting the speaker volume .....11

**Combining the currently playing sound**

**with the desired image (VIDEO SELECT function)** .....11  
**Listening to the radio** .....12  
 Auto preset memory .....12  
 Auto tuning .....12  
 Manual tuning .....12  
 Preset memory .....12  
 Recalling preset stations .....12  
**XM Satellite Radio** .....13  
 Checking the XM signal strength and Radio ID .....13  
 Channel selection .....14  
 Category search .....14  
 Direct access of channels .....14  
**Playing the iPod®** .....14  
 Setting the iPod Assignment .....14  
 Listening to music .....15  
 Listening to music in the Browse mode .....15  
 Viewing still pictures and videos (only for iPods equipped with the slideshow / video function) .....16  
 Disconnecting the iPod .....16  
**Recording the program source (recording the source currently being monitored)** .....16  
**About the memory functions** .....16  
**Initialization of the microprocessor** .....16

**Operating the remote control unit**

**Operating DENON audio components** .....17  
**Setting the preset memory function** .....17  
**Setting the punch through function** .....18  
**Operating a component stored in the preset memory** .....18 ~ 20

**Troubleshooting** .....21

**Specifications** .....22

**Getting Started**

**Accessories**

Check that the following parts are attached in addition to the main unit:

① Operating instructions .....1  
 ② Warranty (for North America model only) .....1  
 ③ Service station list .....1  
 ④ Remote control unit (RC-1053) .....1  
 ⑤ R6P/AA batteries .....2  
 ⑥ AM loop antenna .....1  
 ⑦ FM indoor antenna .....1

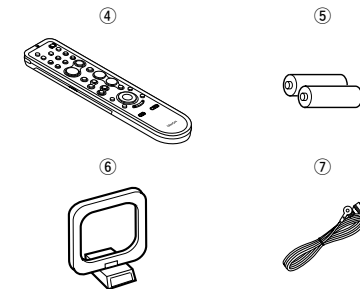

**Before using**

Pay attention to the following before using this unit:

• **Moving the unit.**

To prevent short-circuits or damaged wires in the connection cables, always unplug the power supply cord and disconnect the connection cables between all other audio components when moving the unit.

• **Cautions on using mobile phones.**

Using a mobile phone near this unit may result in noise. If so, move the mobile phone away from this unit when it is in use.

• **Before turning the power operation button on.**

Check once again that all connections are correct and that there are not problems with the connection cables. Always set the power operation button to the standby position before connecting and disconnecting connection cables.

Getting Started

• **Store the operating instructions in a safe place.**

After reading the operating instructions, store them in a safe place as they could come in handy in the future.

• **Whenever the power operation button is in the STANDBY state, the unit is still connected to AC line voltage.**

**Please be sure to turn off the power operation button or unplug the cord when you leave home for, say, a vacation.**

• **Note that the illustrations in these instructions may differ from the actual unit for explanation purposes.**

**Cautions on installation**

**Note:**  
For heat dispersal, do not install this unit in a confined space such as a bookcase or similar enclosure.

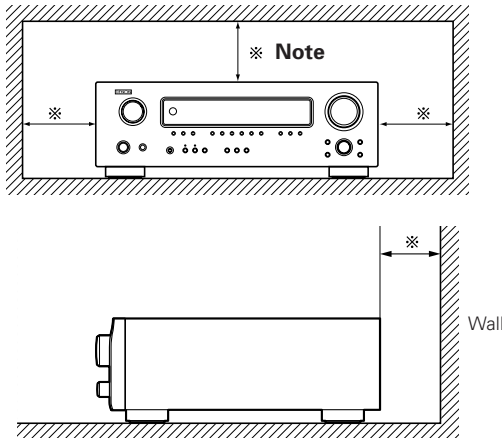

Getting Started

**Operating range of the remote control unit**

- Point the remote control unit at the remote sensor when operating it.
- The remote control unit can be used from a distance of approximately 23 feet/7 meters, at a horizontal angle of up to 30° with respect to the sensor.

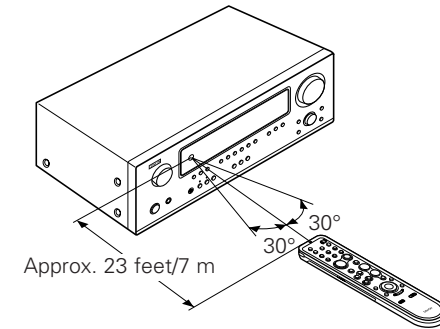

**NOTE:**  
• It may be difficult to operate the remote control unit if the remote sensor is exposed to direct sunlight or strong artificial light.

**About the remote control unit**

In addition to controlling the DRA-37, the attached remote control unit (RC-1053) can also be used to control the following products:

- ① DENON component products
- ② Component products other than DENON:
  - Set using the preset memory function (☞ page 17).

**Inserting the batteries**

- ① Remove the remote control unit's rear cover.
- ② Set two R6P/AA batteries in the battery compartment in the indicated direction.

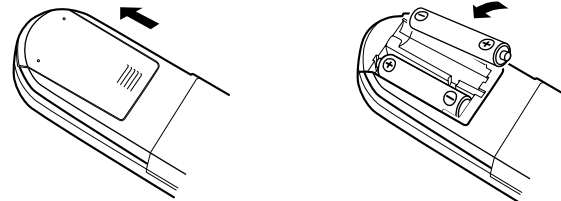

- ③ Put the rear cover back on.

**Notes on batteries:**

- Replace the batteries with new ones if the set does not operate even when the remote control unit is operated nearby the unit. (The attached batteries are only for verifying operation.)
- When inserting the batteries, be sure to do so in the proper direction, following the "⊕" and "⊖" marks in the battery compartment.
- To prevent damage or leakage of battery fluid:
  - Do not use a new battery together with an old one.
  - Do not use two different types of batteries.
  - Do not short-circuit, disassemble, heat or dispose of batteries in flames.
- Remove the batteries from the remote if it will not be in use for long periods.
- If the battery fluid should leak, carefully wipe the fluid off the inside of the battery compartment and insert new batteries.
- When replacing the batteries, have the new batteries ready and insert them as quickly as possible.

Part names and functions

For details on the functions of these parts, refer to the pages given in parentheses ( ).

Front panel

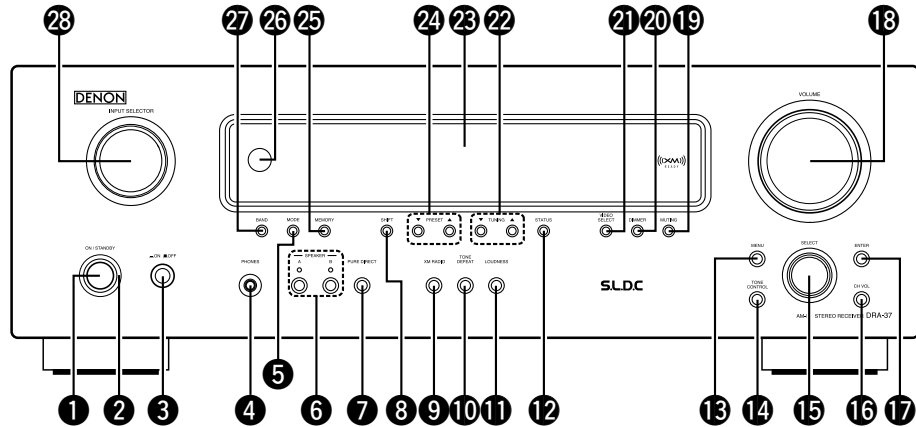

- 1 Power operation button (ON/STANDBY) .....(10)
- 2 Power indicator .....(10)
- 3 Power switch .....(10, 16)
- 4 Headphones jack (PHONES) .....(10)
- 5 MODE button .....(12, 16)
- 6 SPEAKER buttons .....(10)
- 7 PURE DIRECT button .....(11)
- 8 SHIFT button .....(12)
- 9 XM RADIO button .....(14)
- 10 TONE DEFEAT button .....(11)
- 11 LOUDNESS button .....(11)
- 12 STATUS button .....(11)
- 13 MENU button .....(14, 15)
- 14 TONE CONTROL button .....(11)
- 15 SELECT knob .....(11, 15)
- 16 CH VOL button .....(11)
- 17 ENTER button .....(15, 16)
- 18 VOLUME control knob .....(10)
- 19 MUTING button .....(10)
- 20 DIMMER button .....(11)
- 21 VIDEO SELECT button .....(11)
- 22 TUNING buttons (▲, ▼) .....(12)
- 23 Display
- 24 PRESET buttons .....(12)
- 25 MEMORY button .....(12)
- 26 Remote control sensor .....(2)
- 27 BAND button .....(12)
- 28 INPUT SELECTOR knob .....(10)

Display

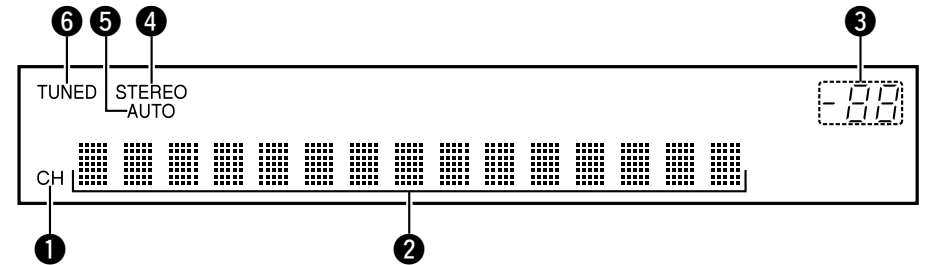

- 1 Signal channel indicator  
Lights when the preset channel is displayed at 2.
- 2 Information display  
This displays the volume level.
- 3 VOLUME indicator  
This lights when an FM/AM broadcast has been received.
- 4 STEREO indicator  
This lights when an FM stereo broadcast has been received.
- 5 AUTO indicator  
This lights when the broadcast station is selected in the AUTO tuning mode.
- 6 TUNED indicator  
This lights when an FM/AM broadcast has been received.

Rear panel

Remote control unit

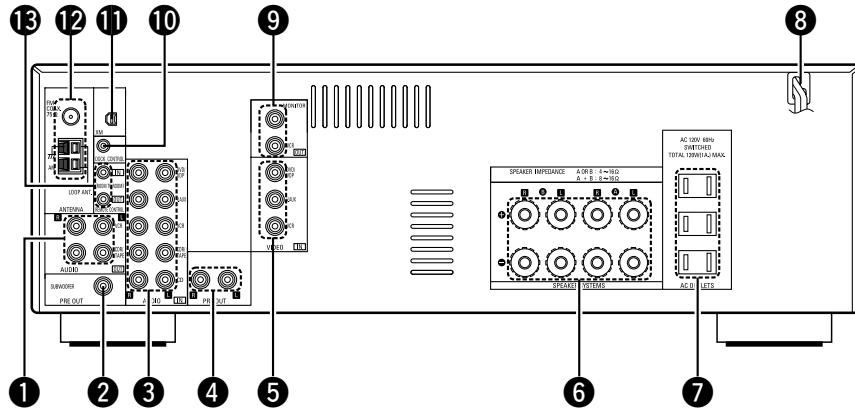

- ❶ AUDIO OUT terminals .....(7)
- ❷ SUBWOOFER PRE OUT terminal .....(6)
- ❸ AUDIO IN terminals .....(6, 7)
- ❹ PRE OUT terminals .....(9)
- ❺ VIDEO IN terminals .....(6, 7)
- ❻ Speaker terminals .....(6)
- ❼ AC outlets .....(9)
- ❽ Power supply cord .....(9)
- ❾ VIDEO OUT terminals .....(6, 7)
- ❿ DOCK CONTROL jack .....(9)
- ⓫ XM terminal .....(8)
- ⓬ ANTENNA terminals .....(7, 8)
- ⓭ REMOTE CONTROL jacks .....(9)

[ Front ]

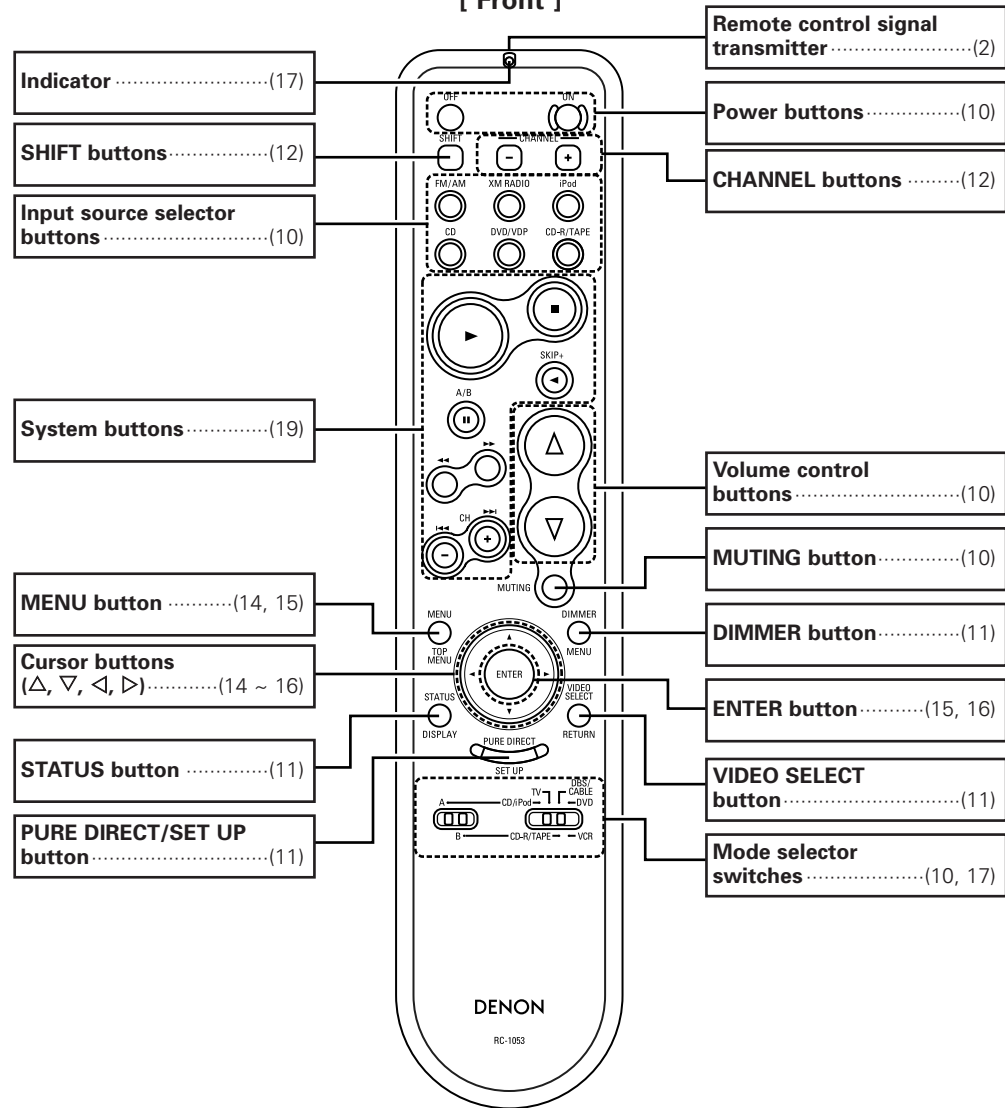

**NOTE:**  
 • If buttons on the front or rear are pressed strongly, the button on the opposite side will be activated too.

Getting Started

[ Rear ]

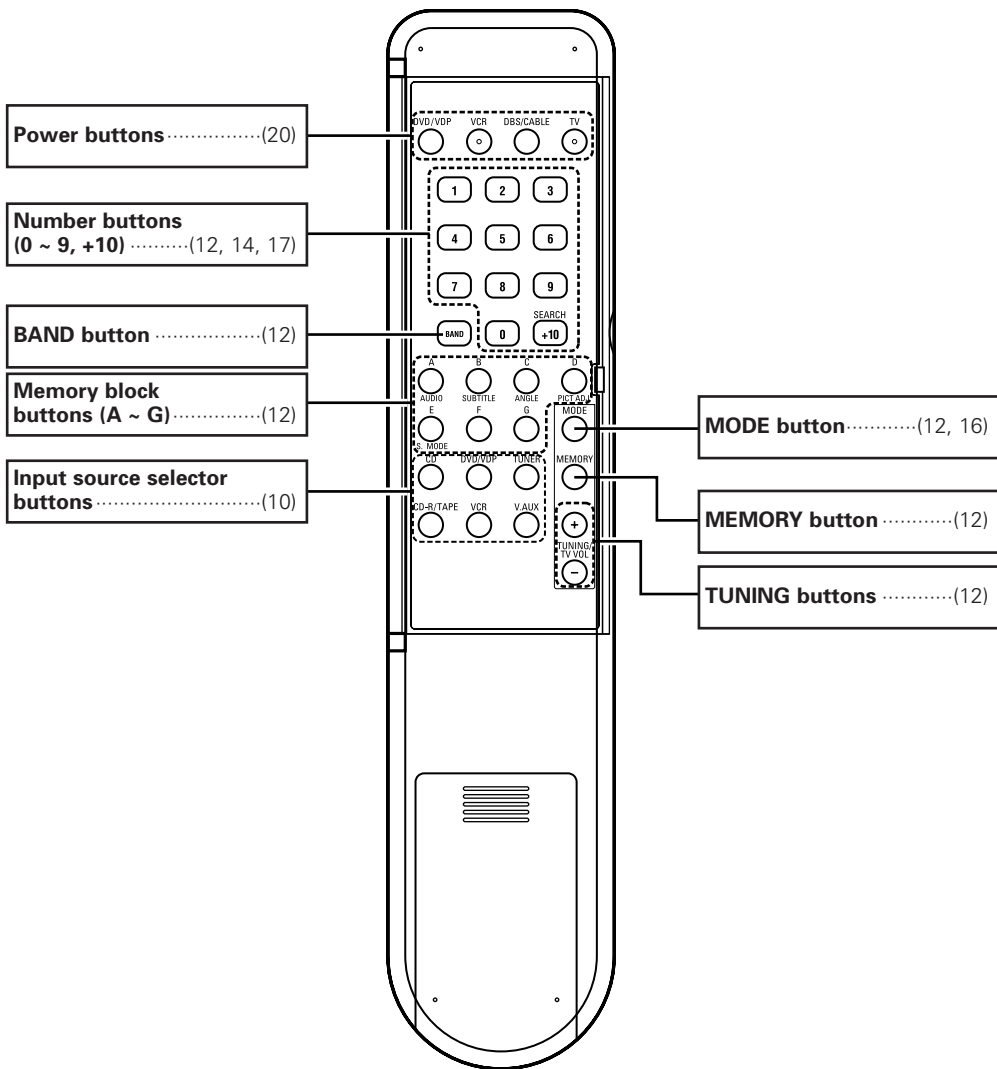

**NOTE:**

- If buttons on the front or rear are pressed strongly, the button on the opposite side will be activated too.

# Connections

## Cable indications

The hookup diagrams on the subsequent pages assume the use of the following optional connection cables (not supplied).

Audio cable	Signal direction
<p><b>A</b> Analog connections (Stereo)</p> <p>(White) (L) (R)</p> <p>(Red) (L) (R)</p> <p>Pin-plug cable</p>	<p>Audio signal</p> <p>IN OUT OUT IN</p>
<p><b>B</b> Analog connections (Monaural, for subwoofer)</p> <p>Pin-plug cable</p>	<p>Video signal</p> <p>IN OUT OUT IN</p>
<p><b>C</b> Speaker connections</p> <p>+ -</p> <p>Speaker cable</p>	
<p><b>D</b> Video connections</p> <p>(Yellow)</p> <p>Video cable (75 Ω/ohms video pin-plug cable)</p>	

**NOTE:**

- Do not plug in the power supply cord until all connections have been completed.
- When making connections, also refer to the operating instructions of the other components.
- Be sure to connect the left and right channels properly (left with left, right with right).
- Do not bundle power cords together with speaker cables. Doing so could result in humming or noise.



Connections

**Speaker connections**

Connect the speaker terminals with the speakers making sure that like polarities are matched (⊕ with ⊕, ⊖ with ⊖).

**NOTE:**  
 When making connections, take care that none of the individual conductors of the speaker cable come in contact with adjacent terminals, with other speaker cable conductors, or with the rear panel and screws.  
**NEVER touch the speaker terminals when the power is on. Doing so could result in electric shocks.**

**Connecting the speaker cables**

1. Loosen by turning counterclockwise.
2. Insert the cable. Either tightly twist or terminate the core wires.
3. Tighten by turning clockwise.

**Connecting banana plugs**

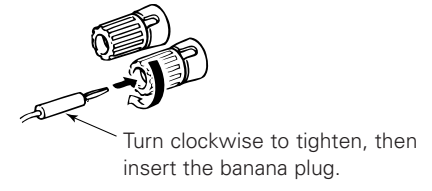

**Speaker impedance**

Speaker	Impedance
A, B	4 ~ 16 Ω/ohms
A+B	8 ~ 16 Ω/ohms

**Note on speaker impedance**

When using speakers with an impedance below the designated value (for example 4 Ω/ohms), playing for long periods of time with the volume high could cause the temperature to rise, activating the protection circuit. When the protection circuit is activated, the output to the speakers is cut off and the power indicator blinks. If this happens, unplug the power cord, wait for the set to cool off and improve ventilation around the unit. Also check the wiring of the input cables and the speaker cables. After doing this, plug the power cord back in and turn the unit's power back on. If the protection circuit is activated again even though there are no problems with the wiring or the ventilation around the unit, switch off the power and contact a DENON service center.

Connections

**Connections**

- When making connections, also refer to the operating instructions of the other components.

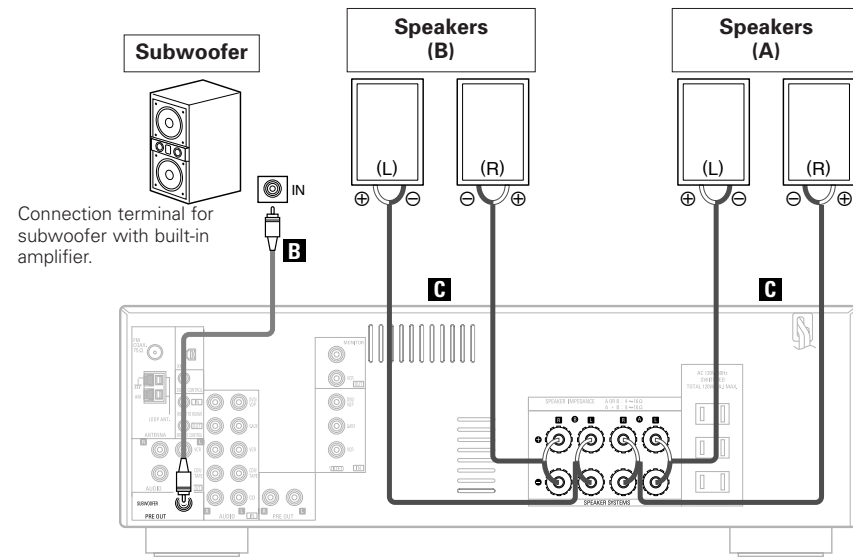

**Connecting a DVD player and monitor**

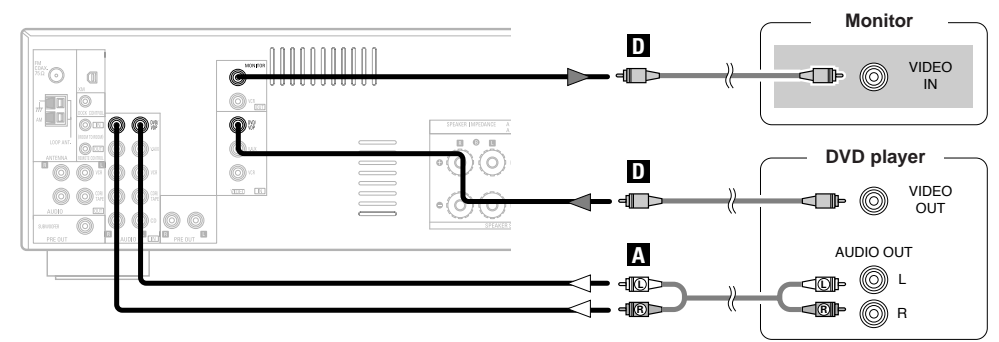

- Connect a non-DVD video disc player (such as a laser disc, VCD/SVCD, or future high definition disc player) to the DVD/VDP terminals in the same way.

Connections

Connecting a TV/DBS tuner

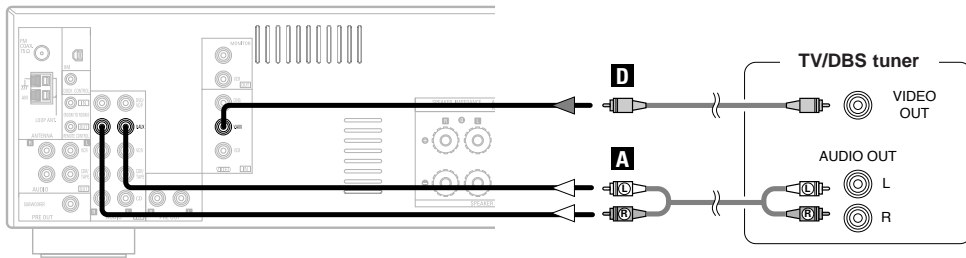

Connecting a CD player

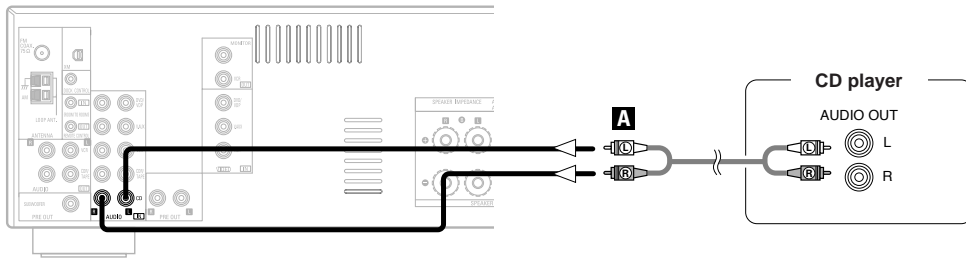

Connecting a tape deck, CD recorder or MD recorder

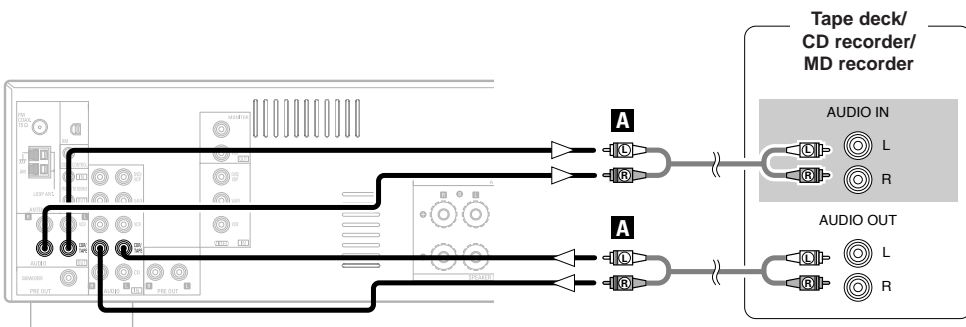

Connections

Connecting a VCR

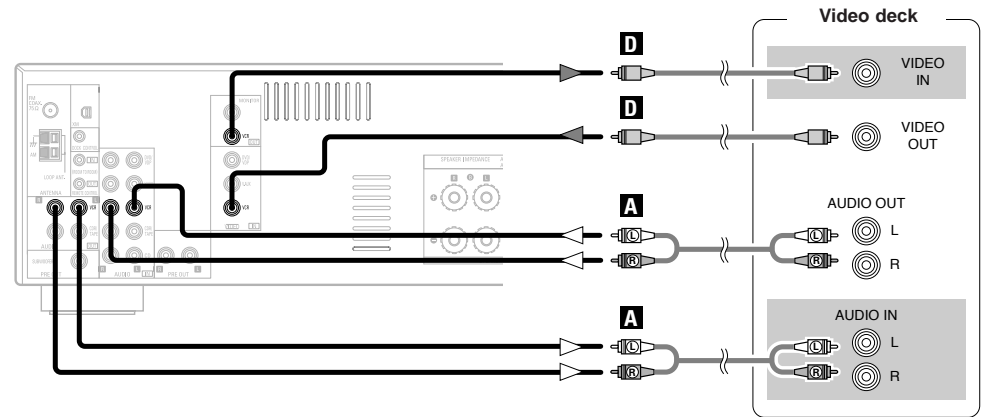

Connecting the antenna terminals

An F-type FM antenna cable plug can be connected directly.

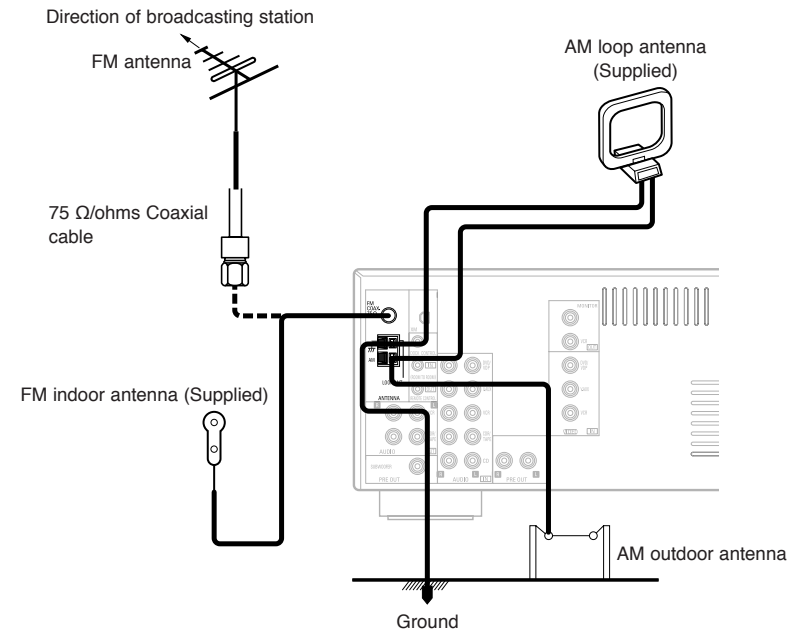

Connections

AM loop antenna assembly

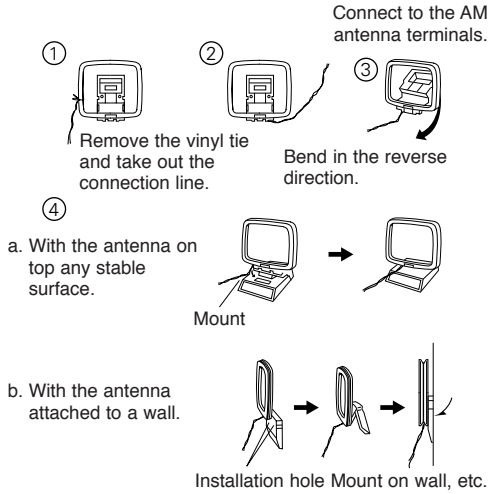

**NOTE:**

- Do not connect two FM antennas simultaneously.
- Even if an external AM antenna is used, do not disconnect the AM loop antenna.
- Make sure the AM loop antenna lead terminals do not touch metal parts of the panel.

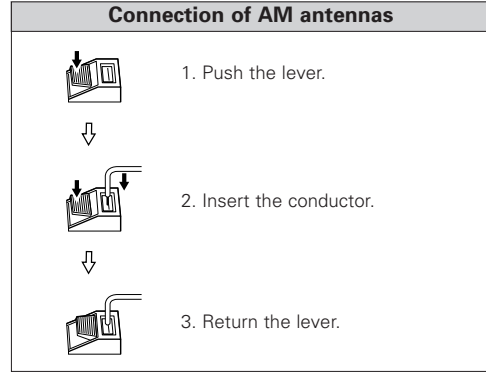

**Note to CATV system installer:**

This reminder is provided to call the CATV system installer's attention to Article 820-40 of the NEC which provides guidelines for proper grounding and, in particular, specifies that the cable ground shall be connected to the grounding system of the building, as close to the point of cable entry as practical.

Connections

Connecting the XM terminal

- DRA-37 is the XM Ready® receiver. You can receive XM® Satellite Radio by connecting to the XM Mini-Tuner and Home Dock (includes home antenna, sold separately) and subscribing to the XM service.
  - Plug the XM Mini-Tuner Home Dock into XM terminal on the rear panel.
  - Position the Home Dock antenna near a south-facing window to receive the best signal. For details, see "XM Satellite Radio" (page 13).
- When making connections, also refer to the operating instructions of the XM Mini-Tuner and Home Dock.

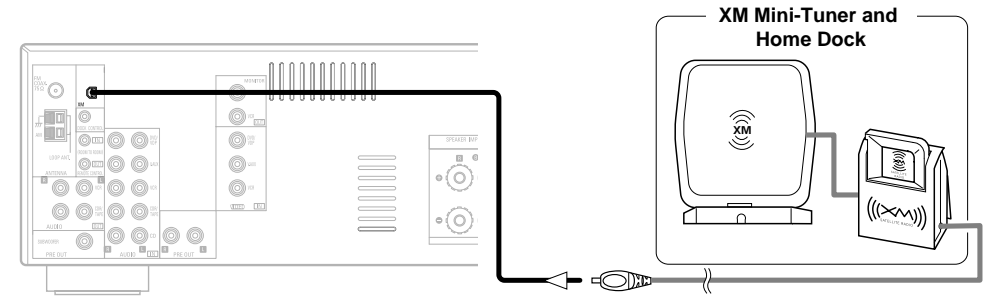

**NOTE:**

- Keep the power supply cord unplugged until the XM Mini-Tuner and Home Dock connection have been completed.

- The XM name and related logo are registered trademarks of XM Satellite Radio Inc. All rights reserved.
- XM Ready is a registered trademark of XM Satellite Radio Inc. All rights reserved.

Connections

Connecting the iPod®

When using an iPod, you must connect the Control Dock for iPod (ASD-1R, sold separately) and the DOCK CONTROL jack on the DRA-37 with a mini-jack and assign the iPod to any AUDIO terminal(s). The diagram below shows an example of connections for when the iPod is assigned to the CD-R/TAPE terminals.

- \* For instructions on assigning the iPod to a specific terminal, see "Setting the iPod Assignment" (page 14).
- \* For instructions on playing the iPod, see "Playing the iPod" (page 14).

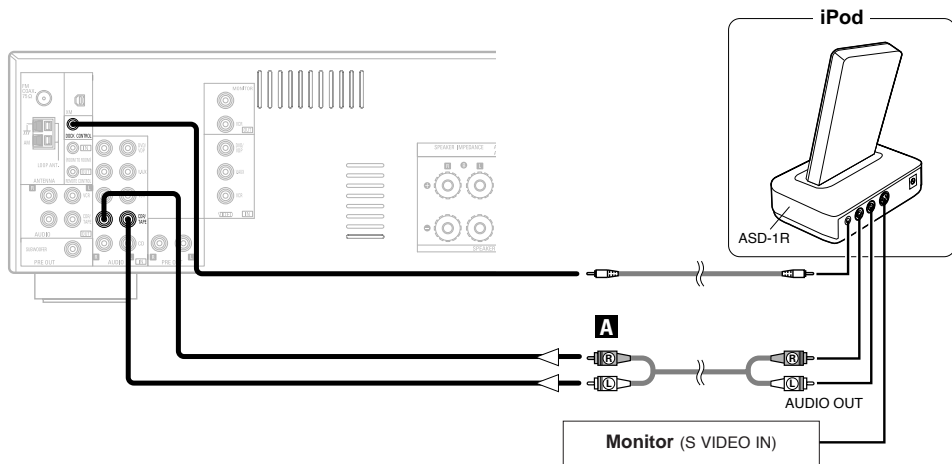

- The optional standard Control Dock for iPod is DENON ASD-1R sold separately.

Connecting a room-to-room remote control unit

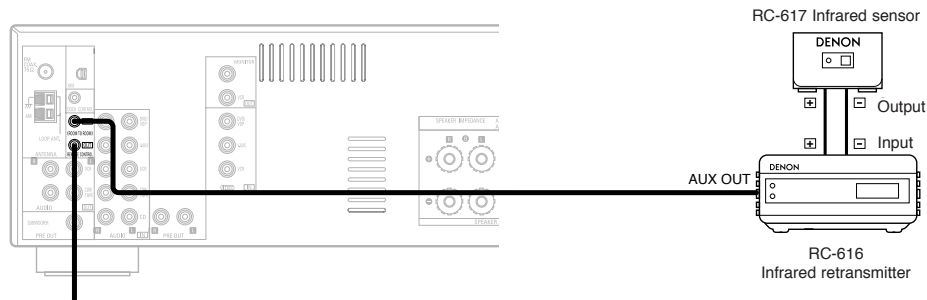

Extension terminals for future use.

Connections

NOTE:

- For instructions on installation and operation of separately sold devices, refer to the devices' operating instructions.

Connecting the PRE OUT terminals

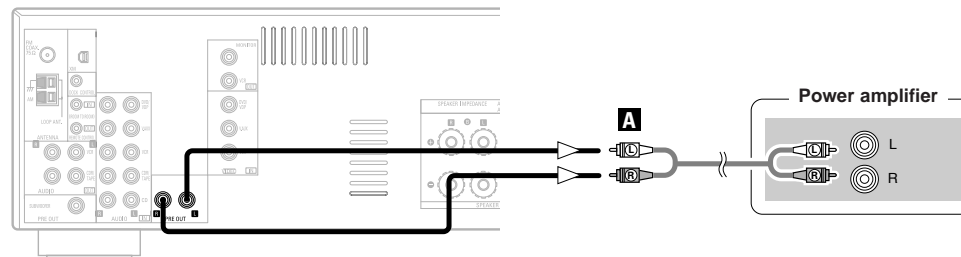

Connecting the power supply cord

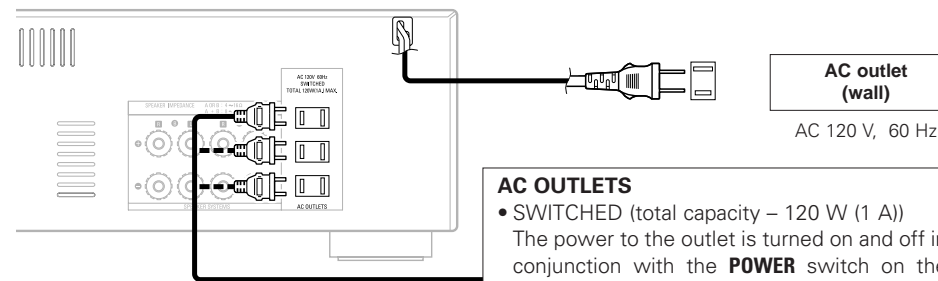

AC outlet (wall)  
AC 120 V, 60 Hz

AC OUTLETS

- SWITCHED (total capacity – 120 W (1 A))  
The power to the outlet is turned on and off in conjunction with the **POWER** switch on the main unit, and when the power is switched between on and standby from the remote control unit.  
No power is supplied from this outlet when this unit's power is at standby. Never connect equipment whose total power consumption exceeds 120 W (1 A).

NOTE:

- Insert the plugs securely. Incomplete connections will result in the generation of noise.
- Only use the AC OUTLETS for audio equipment. Never use it for hair driers, monitors or other electrical appliances.

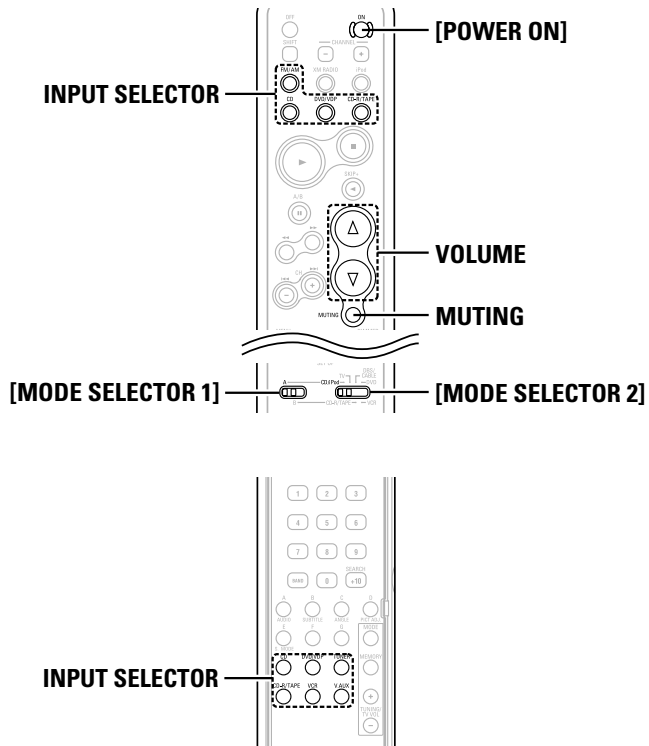
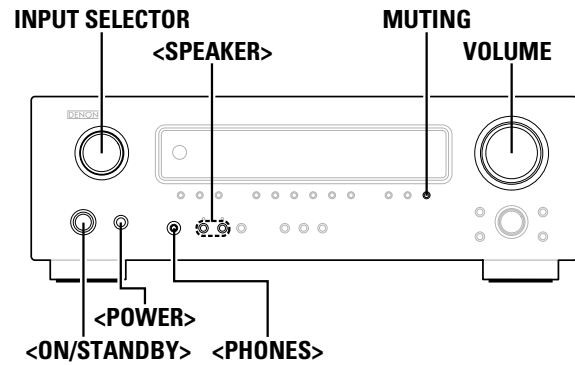

**About the button names in this explanation**  
 < > : Buttons on the main unit  
 [ ] : Buttons on the remote control unit  
**Button name only :**  
 Buttons on the main unit and remote control unit

## Operation

### Before operating

**1** Press **<POWER>**.

**■ ON:**  
 The power indicator lights red.

**■ OFF:**  
 The power turns off and the indicator is off.

**2** Set **[MODE SELECTOR 1]** to “A”.

**3** Set **[MODE SELECTOR 2]** to “CD/iPod”.

**4** Press **<ON/STANDBY>** or **[POWER ON]**.  
 • The power indicator blinks green and the power turns on.

### Playing the input source

**1** Use **INPUT SELECTOR** to select the input source you want to play.

**2** Start playback on the selected component.  
 ※ For operating instructions, refer to the component’s manual.

**3** Use **VOLUME** to adjust the volume.  
 • The volume level is displayed on the volume level display.

### Turning the sound off temporarily (MUTING)

Press **MUTING**.



- Canceling MUTING mode:  
 To cancel the muting mode, either press **MUTING** or adjust the volume.

### Listening over headphones

Connect the headphones to **<PHONES>**.

- No sound is produced from the speakers automatically.

#### NOTE:

- To prevent hearing loss, be careful not to raise the volume level excessively when using headphones.

### Switching the speakers

Press **<SPEAKER>** to turn the corresponding speaker pair on.

Operation

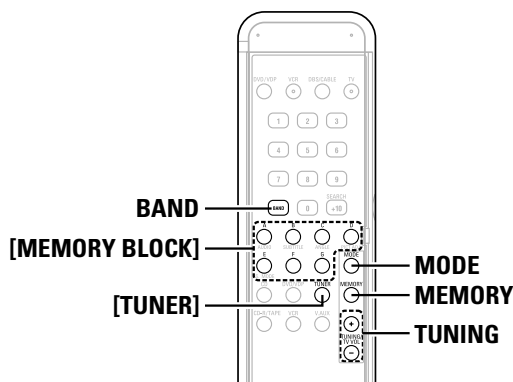
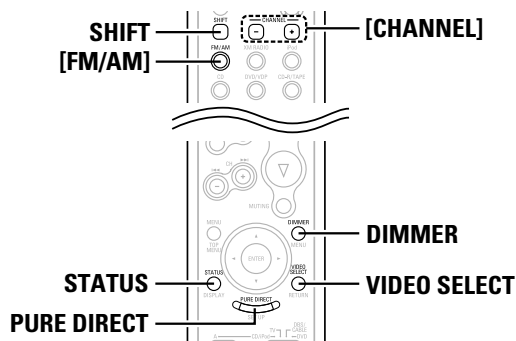
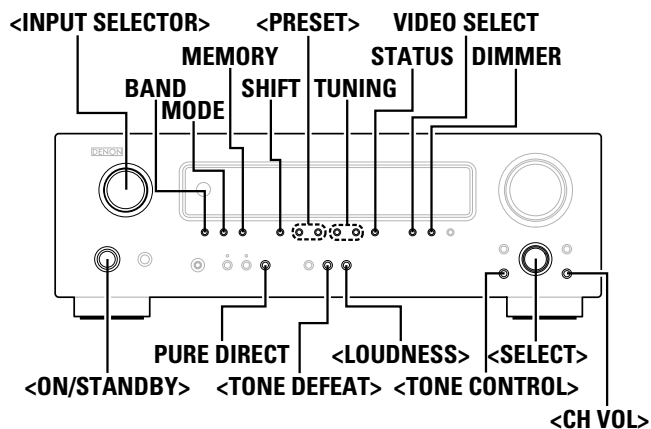

Operation

Checking the currently playing program source, etc.

Press **STATUS**.

- The current program source and various settings are indicated on the display.

Switching the brightness of the display

Press **DIMMER**.

- ※ The brightness of the display can be adjusted in three steps. The display can also be turned off.

Selecting the play mode (PURE DIRECT)

This mode reproduces the sound with extremely high quality. The display that could affect the audio signals are turned "OFF".

Press **PURE DIRECT**.

Setting the tone control

Adjusting the tone

**1** Press **<TONE CONTROL>** to select "BASS" or "TREBLE".

**2** Use **<SELECT>** to set the level.

- ※ Can be adjusted within the range of -10 dB to +10 dB.

When you do not want to adjust the tone

Press **<TONE DEFEAT>** to select "TONE DEFEAT ON".

When listening with the volume turned low

Press **<LOUDNESS>** to select "LOUDNESS ON".

Adjusting the speaker volume

**1** Press **<CH VOL>** to select the speaker.

- ※ The settable speaker switches each time this button is pressed.

**2** Use **<SELECT>** to adjust the volume.

- ※ Can be adjusted within the range of -12 dB to +12 dB.

Combining the currently playing sound with the desired image (VIDEO SELECT function)

Press **VIDEO SELECT** until the desired image appears on the display.



- To cancel, press **VIDEO SELECT** to select "SOURCE".
- The video source selected with the video select function is stored in the memory for the different input sources.

About the button names in this explanation

- < > : Buttons on the main unit
- [ ] : Buttons on the remote control unit

Button name only :

Buttons on the main unit and remote control unit

Operation

**Listening to the radio**

Check that the remote control unit is set to "A".

**Auto preset memory**

This unit is equipped with a function for automatically searching for FM broadcast stations and storing them in the preset memory.

**1** Press **<ON/STANDBY>** and set the DRA-37's power to the standby mode.

**2** Hold **<PRESET ▲>** and press **<ON/STANDBY>**.  
 • The unit automatically begins searching for FM broadcast stations.

- ※ When the first FM broadcast station is found, that station is stored in the preset memory at channel A1. Subsequent stations are automatically stored in order at preset channels A1 to A8, B1 to B8, C1 to C8, D1 to D8, E1 to E8, F1 to F8 and G1 to G8 for a maximum of 56 stations.
- ※ Channel A1 is tuned in after the auto preset memory operation is completed.



- If an FM station cannot be preset automatically due to poor reception, use the "Manual tuning" operation to tune in the station, then preset it using the manual "Preset memory" operation.
- To interrupt this function, press **<ON/STANDBY>**.

**Default settings**

Auto tuner presets	
A1 ~ A8	87.5 / 89.1 / 98.1 / 107.9 / 90.1 / 90.1 / 90.1 / 90.1 MHz
B1 ~ B8	520 / 600 / 1000 / 1400 / 1500 / 1710 kHz, 90.1 / 90.1 MHz
C1 ~ C8	90.1 MHz
D1 ~ D8	90.1 MHz
E1 ~ E8	90.1 MHz
F1 ~ F8	90.1 MHz
G1 ~ G8	90.1 MHz

**Auto tuning**

**1** Use **<INPUT SELECTOR>** to select "TUNER" or press **[TUNER]**.

**2** Press **BAND** to select "AM" or "FM".  
 ※ When listening to the XM Satellite Radio (☞ page 13).

**3** Press **MODE** to set the auto tuning mode.  
 • The "AUTO" indicator lights.

**4** Press **TUNING**.  
 • Automatic searching begins.



- If tuning does not stop at the desired station, use to the "Manual tuning" operation.
- "AM" or "FM" can be selected directly by pressing **[FM/AM]**.

**Manual tuning**

**1** Use **<INPUT SELECTOR>** to select "TUNER" or press **[TUNER]**.

**2** Press **BAND** to select "AM" or "FM".  
 ※ When listening to the XM Satellite Radio (☞ page 13).

**3** Press **MODE** to set the manual tuning mode.  
 ※ Check that the display's "AUTO" indicator turns off.

**4** Press **TUNING**.  
 ※ The frequency changes continuously when the button is held in.



- When the manual tuning mode is set, FM stereo broadcasts are received in monaural and the "STEREO" indicator turns off.
- "AM" or "FM" can be selected directly by pressing **[FM/AM]**.

Operation

**Preset memory**

**1** Use the "Auto tuning" or "Manual tuning" operation to tune in the station to be preset in the memory.

**2** Press **MEMORY**.

**3** Press **[MEMORY BLOCK] (A to G)** or **SHIFT** to select the desired memory block (A to G).

**4** Press **<PRESET>** or **[CHANNEL]** to select the desired preset channel (1 to 8).

**5** Press **MEMORY** again.  
 • Store the station in the preset memory.



- To preset other channels, repeat steps 2 to 4. A total of 56 broadcast stations can be preset — 8 stations (channels 1 to 8) in each of blocks A to G.

**Recalling preset stations**

**1** Press **[MEMORY BLOCK] (A to G)** or **SHIFT** to select the memory block.

**2** Press **<PRESET>** or **[CHANNEL]** to select the desired preset channel.

Operation

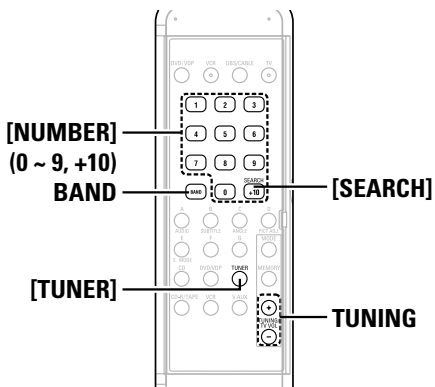
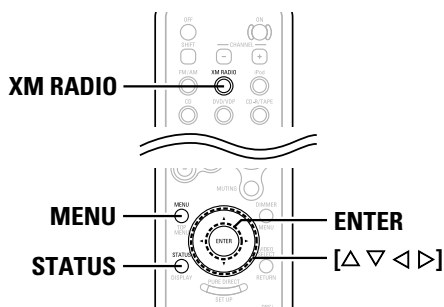
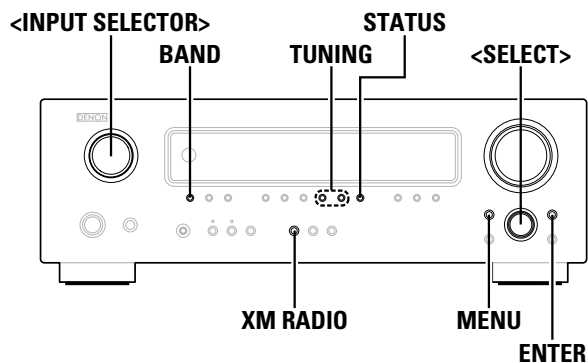

**About the button names in this explanation**  
 < > : Buttons on the main unit  
 [ ] : Buttons on the remote control unit  
**Button name only :**  
 Buttons on the main unit and remote control unit

**XM Satellite Radio**

**ABOUT XM SATELLITE RADIO**

XM Satellite Radio offers an extraordinary variety of commercial-free music, plus the best in sports, news, talk and entertainment. XM is broadcast in superior digital audio from coast to coast. From rock to reggae, from classical to hip hop, XM has something for every music fan. XM's dedication to playing the richest selection of music is matched by its passion for live sporting events, talk radio, up-to-the-minute news, stand-up comedy, children's programming, and much more. For U.S. customers, information about XM Satellite Radio is available online at [www.xmradio.com](http://www.xmradio.com). For Canadian customers, information about XM Canada is online at [www.xmradio.ca](http://www.xmradio.ca).

**XM READY® LEGAL**

Hardware and required monthly subscription sold separately. Other fees and taxes, including a one-time activation fee may apply. Subscription fee is consumer only. All fees and programming subject to change. Channels with frequent explicit language are indicated with an XL. Channel blocking is available for XM radio receivers by calling 1-800-XMRADIO (US residents) and 1-877-GET-XMSR (Canadian residents).

For a full listing of the XM commercial-free channels and advertising-supported channels, visit [lineup.xmradio.com](http://lineup.xmradio.com) (US residents) or [xmradio.ca](http://xmradio.ca) (Canadian residents).

Subscriptions subject to Customer Agreement available at [xmradio.com](http://xmradio.com) (US residents) and [xmradio.ca](http://xmradio.ca) (Canadian residents). Only available in the 48 contiguous United States and Canada. ©2006 XM Satellite Radio Inc. All rights reserved. All other trademarks are the property of their respective owners.

**XM READY® SUBSCRIPTIONS**

Once you have installed the XM Mini-Tuner Dock, inserted the XM Mini-Tuner, connected the XM Dock to your XM Ready® home audio system, and installed the antenna, you are ready to subscribe and begin receiving XM programming. There are three places to find your eight character XM Radio ID: on the XM Mini-Tuner, on the XM Mini-Tuner package, and on XM Channel 0. Record the Radio ID in the following eight squares for reference.



Operation

Note: The XM Radio ID does not use the letters "I", "O", "S" or "F". Activate your XM Satellite Radio service in the U.S. online at <http://activate.xmradio.com> or call 1-800-XM-RADIO (1-800-967-2346). You will need a major credit card. XM will send a signal from the satellites to activate the full channel lineup. Activation normally takes 10 to 15 minutes, but during peak busy periods you may need to keep your XM Ready home audio system on for up to an hour. When you can access the full channel lineup on your XM Ready home audio system you are done. For more information or to subscribe in Canada, visit XM on the Web at [www.xmradio.ca](http://www.xmradio.ca) or call XM's Listener Care at 1-877-GET-XMSR (1-877-438-9677).

**Checking the XM signal strength and Radio ID**

- 1 Use <INPUT SELECTOR> to select "TUNER" or press [TUNER].
- 2 Press BAND to select "XM".
- 3 Press STATUS until "SIGNAL" is displayed.
  - The display changes as shown below according to the receiving condition.

Display	Condition
GOOD	Signal strength is good
MARGINAL	Signal strength is marginal
WEAK	Signal strength is poor
NO	Loss of the signal

- 4 Adjust the antenna location until "SIGNAL:GOOD" is displayed.
- 5 Press STATUS until the XM channel (ex.XM001) is displayed.
- 6 Press TUNING to select channel 0 (XM000).





## Operation

## Channel selection

**1** Use <INPUT SELECTOR> to select “TUNER” or press [TUNER].

**2** Press BAND to select “XM”.

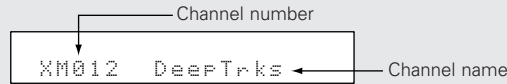

**3** Press TUNING to reach the desired channel.

- ※ The channel changes continuously when you press and hold TUNING.
- ※ When the artist name and song title are received, they are displayed.

## Category search

**1** Press [◀ ▶] in the XM mode.

- The current category name is displayed.

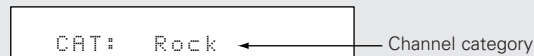

**2** Press [◀ ▶] to select the category, and press [△ ▽] to select the channel within the selected category.



- “LOADING” is displayed while receiving the channel or information.
- “UPDATING” is displayed while updating encryption code.
- When the selected channel is not available, “XM ---” is displayed.
- Information on the artist name, song title, category and signal level can be checked using STATUS.
- The XM Satellite Radio channels can be preset in the same way as AM/FM band (page 12).
- “XM” can be selected directly by pressing XM RADIO.

## Direct access of channels

**1** Press [SEARCH] in the XM mode.

**2** Press [NUMBER] to enter the desired channel.

- ※ For example, if you want to access channel 123 (ex.XM123) press [NUMBER] as shown below.

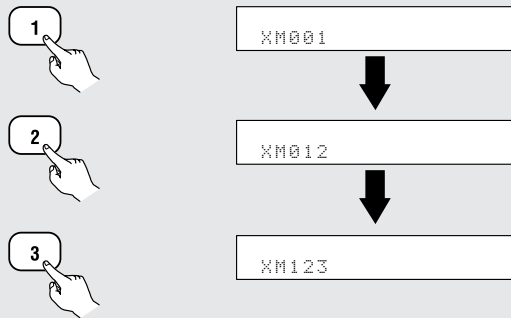

(Remote control unit)

**3** Once all number have been input, press ENTER to change the channel.

- ※ If the next [NUMBER] is not pressed within several seconds, the channel automatically switches to the channel number that was input.

## Playing the iPod®

The music recorded on the iPod can be played when using a Control Dock for iPod (ASD-1R, sold separately). The iPod can be controlled using the buttons on the main unit and the remote control unit.



iPod is a trademark of Apple Computer, Inc., registered in the U.S. and other countries.

- ※ With the iPod, non-copyrighted contents and contents that may be legally reproduced or played may be reproduced and played by individuals for their personal use. Violating copyrights is prohibited by law.

## Operation

## Setting the iPod Assignment

It is possible to assign the Control Dock for iPod's (ASD-1R, sold separately) audio and video signals to any input terminals on the DRA-37 and play them.

**1** Press MENU.

**2** Use <SELECT> or press [◀ ▶] to select the input terminals.

## NONE:

This is the factory default setting.

## DVD, VCR, V.A, CDR, CD:

When using a Control Dock for iPod, it is possible to connect with the audio input terminal of the assigned function.

**3** Press ENTER.



- The optional standard Control Dock for iPod is DENON ASD-1R sold separately.
- To assign to a different function after a function has already been assigned, switch to a function other than the one that is assigned then repeat the procedure.

## NOTE:

- DENON will accept no responsibility whatsoever for loss or damage of data on an iPod occurring when the iPod is used connected to the DRA-37.
- Some of the functions may not operate, depending on the type of iPod and the software version.

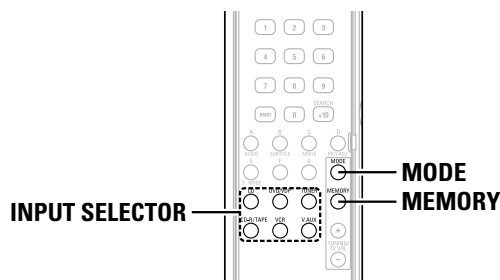
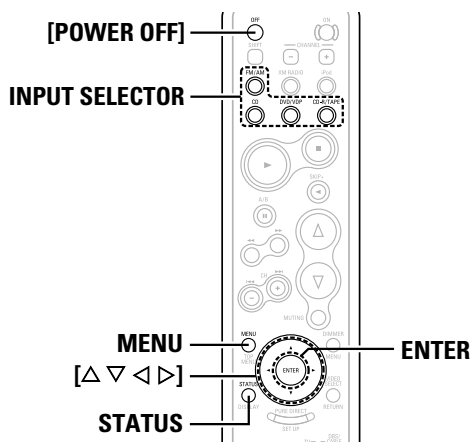
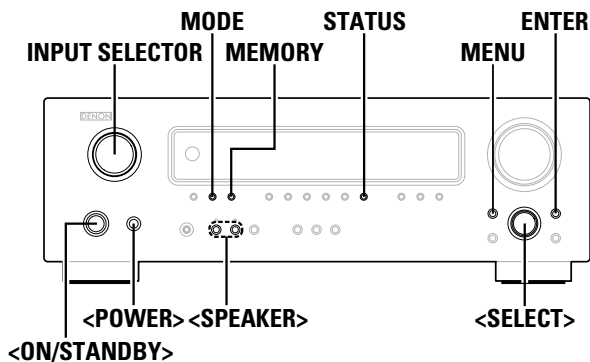

**About the button names in this explanation**  
 < > : Buttons on the main unit  
 [ ] : Buttons on the remote control unit  
**Button name only :**  
 Buttons on the main unit and remote control unit

**Listening to music**

**1** Connect the DRA-37 and iPod using the Control Dock for iPod (ASD-1R) (☞ page 9).

**2** Assign the input terminal at “Setting the iPod Assignment” (☞ page 14).

**3** Use **INPUT SELECTOR** to select the function assigned in step 2.  
 • Display “Remote iPod” on the main unit’s display.

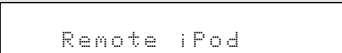

※ If the screens above are not displayed, the iPod may not be properly connected. Check the connections and settings.

**4** Operate using **MENU**, **<SELECT>**, [Δ ∇ ◀ ▶], and **ENTER** while watching the iPod’s screen.



• The optional standard Control Dock for iPod is DENON ASD-1R sold separately.

**Listening to music in the Browse mode**

The mode switches between the Remote mode and the Browse mode if **MODE** is pressed for at least 2 seconds.

**1** Use **<SELECT>** or press [Δ ∇] to select the music file, then press **ENTER** or [▶].

※ Press [◀] to return to the music menu screen.

**2** Press **ENTER** or [▶].  
 • Playback starts.

**Pause:**  
 Press **ENTER** during playback.  
 Press again to resume.

**Manual search:**  
 Press and hold in [Δ ∇] during playback.  
 • Δ: Fast reverse  
 • ∇: Fast forward

**Track search:**  
 Press [Δ ∇] during playback.  
 • Δ: Move to beginning of previous track  
 • ∇: Move to beginning of next track

**Stop:**  
 Press **ENTER** for at least 2 seconds during playback.

**Repeat play:**  
 Press **MODE**.  
 The mode switches as follows each time **MODE** is pressed.  
 • **Repeat One:** Single track repeat  
 • **Repeat All:** All track repeat

**Shuffle play:**  
 Press **MEMORY**.  
 The mode switches as follows each time **MEMORY** is pressed.  
 • **Shuffle Songs:** Single track shuffle  
 • **Shuffle Albums:** Album shuffle

※ In the Remote mode, only **<SELECT>**, [Δ ∇ ◀ ▶], and **ENTER** can be used.



- When **STATUS** is pressed during playback, the front panel display switches between the title name, artist name and album name.
- Depending on the iPod’s software version, it may not be possible to operate the iPod from the DRA-37. Use the latest version of the software. Information on the latest version of the software can be obtained on the Apple Computer website.
- With the DRA-37 it is possible to display folder names and file names on the screen like titles. The DRA-37 can display up to 64 characters, consisting of numbers, capital letters and small letters. A “?” mark is displayed in place of non-compatible characters.

## Operation

### Viewing still pictures and videos (only for iPods equipped with the slideshow / video function)

Use this procedure to view photo and video data stored on the iPod on a monitor.

#### 1 Press **MODE** for at least 2 seconds to switch from the Browse mode to the Remote mode.

- "Remote iPod" is displayed on the DRA-37's display.

#### 2 Watching the iPod's screen, press [ $\Delta$ $\nabla$ ] to select "Photos" or "Video", then press **ENTER** or [ $\triangleright$ ].

- The iPod's photo and video data are displayed on the monitor.



- To output photo or video data recorded on the iPod to the monitor, the iPod's "TV Out" setting (under "Video Settings") must be set to "ON".

For details, refer to the iPod's operating instructions.

### Disconnecting the iPod

Press **<ON/STANDBY>** or **[POWER OFF]** and set the DRA-37's power to the standby mode.

- ※ The iPod can be disconnected after switching to a function other than the one to which the iPod input is assigned.

### Recording the program source (recording the source currently being monitored)

#### 1 Select the input source to be played.

#### 2 Start recording on the tape or video deck.

- ※ For instructions, refer to the component's operating instructions.



- The AUDIO IN's signal selected with **INPUT SELECTOR** are output to the CD-R/TAPE and VCR AUDIO OUT terminals.

#### Simultaneous recording

The signals of the source selected with **INPUT SELECTOR** are output simultaneously to the CD-R/TAPE and VCR REC OUT terminals. If a total of two tape and/or video decks are connected and set to the recording mode, the same source can be recorded simultaneously on every decks.

## Operation

### About the memory functions

#### Last function memory

The various settings set when the DRA-37's power is switched to standby are stored in the memory. When the power is turned back on, the settings made when the power was switched to standby are recalled.

#### Backup memory

The various settings are stored in the memory for about 1 week, even when the power is turned off or the power cord is unplugged.

### Initialization of the microprocessor

If the indication on the display is not normal or if the operation of the unit is not correct, then the microprocessor should be reset by the following procedure.

#### 1 Switch off the unit using **<POWER>**.

#### 2 Keep both **<SPEAKER>** (A and B) depressed and turn on the unit by pressing **<POWER>**.

#### 3 Check that the entire display is flashing at 1-second intervals and release the buttons.

- The microprocessor will be initialized.



- If step 3 does not work, start over from step 1.
- If the microprocessor has been reset, all the button settings are reset to the default values (the values set upon shipment from the factory).

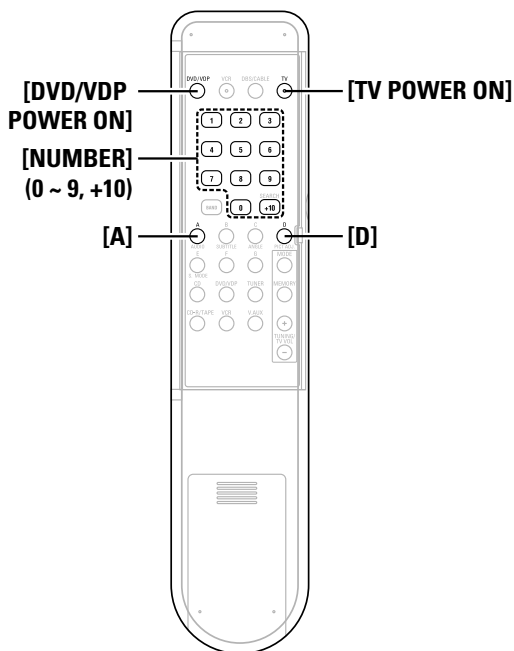
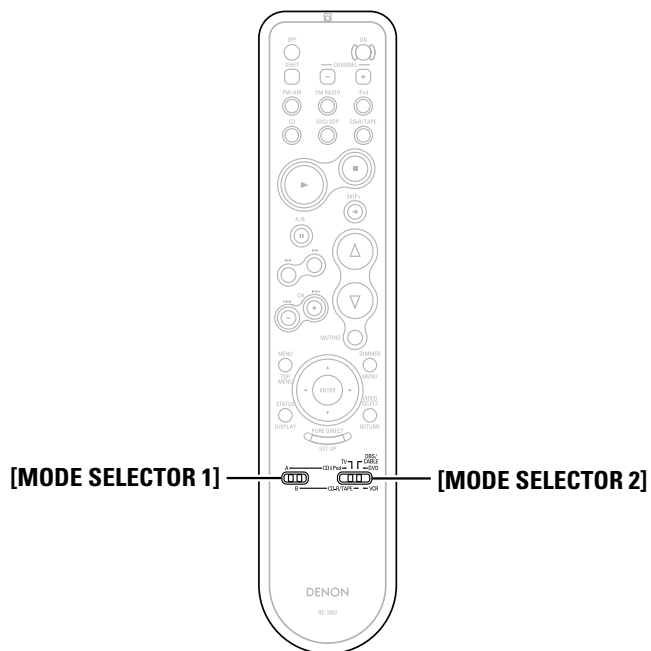

## Operating the remote control unit

### Operating DENON audio components

- 1** Set [MODE SELECTOR 1] to “A” or “B”.
- 2** Set [MODE SELECTOR 2] to the position for the component to be operated.
- 3** Operate the audio component.
  - ※ For details, refer to the component’s operating instructions.
  - ※ While this remote control is compatible with a wide range of infrared controlled components, it may be the case that some component models cannot be operated with this remote control.

### Setting the preset memory function

- DENON and other makes of components can be operated by setting the preset memory.
- This remote control unit can be used to operate components of other manufacturers without using the learning function by registering the manufacturer of the component as shown in the list of preset codes (👉 End of this manual).
- Operation is not possible for some models.

- 1** Set [MODE SELECTOR 1] to “A” or “B”.
  - ※ Set to the A side for the CD/iPod, TV, DBS/CABLE or DVD position, and to the B side for the CD-R/TAPE or VCR position.
- 2** Set [MODE SELECTOR 2] to the component to be registered.
- 3** Press [DVD/VDP POWER ON] and [TV POWER ON] at the same time.
  - The indicator starts flashing.

- 4** Referring to the included list of preset codes, press [NUMBER] to input the preset code (a 3-digit number) for the manufacturer of the component whose signals you want to store in the memory.
- 5** To store the codes of another component in the memory, repeat steps 1 to 4.



- The signals for the pressed buttons are emitted while setting the preset memory. To avoid accidental operation, cover the remote control unit’s transmitting window while setting the preset memory.
- Depending on the model and year of manufacture, this function cannot be used for some models, even if they are of makes listed in the list of preset codes.
- Some manufacturers use more than one type of remote control code. Refer to the included list of preset codes to change the number and verify correct operation.
- The preset memory can be set for one component only among the following: CD/iPod, DBS/CABLE and CD-R/TAPE.

## Operating the remote control unit

## Setting the punch through function

"Punch Through" is a function allowing you to operate ►, ■, ◀, ||, ◀◀, ▶▶, ◀◀◀ and ▶▶▶ on CD, DVD/VDP, TAPE/CD-R/MD or VCR components when in the TV or DBS/CABLE mode. By default, nothing is set.

**1** Set [MODE SELECTOR 1] to "A".

**2** Set [MODE SELECTOR 2] to the component to be registered (TV or DBS/CABLE).

**3** Press [A] and [D] at the same time.  
• The indicator starts flashing.

**4** Input the number of the component you want to set.

	No.
CD	1
DVD/VDP	2
TAPE/CD-R/MD	3
VCR	4
No setting	0

## Operating a component stored in the preset memory

**1** Set [MODE SELECTOR 1] to "A" or "B".

※ Set to the A side for the CD/iPod, TV, DBS/CABLE or DVD position, and to the B side for the CD-R/TAPE or VCR position.

**2** Set [MODE SELECTOR 2] to the component you want to operate.

**3** Operate the component.

※ For details, refer to the component's operating instructions.  
※ Some models cannot be operated with this remote control unit.

## Operating the remote control unit

□ Functions of buttons for the different devices

[Front]

Device operated	CD player or iPod	TV (Monitor)	Satellite tuner	Cable TV	DVD player	CD recorder	Tape deck	MD recorder	Video deck
<b>MODE SELECTOR 1</b>	<b>A</b>				<b>B</b>				
<b>MODE SELECTOR 2</b>	<b>CD/iPod</b>	<b>TV</b>	<b>DBS/CABLE</b>		<b>DVD</b>	<b>CD-R/TAPE</b>			<b>VCR</b>
<b>OFF</b>	Power off	–	–	–	Power off	Power off	Power off	Power off	–
<b>ON</b>	Power on	Power on	Power on	Power on	Power on	Power on	Power on	Power on	Power on
<b>CHANNEL –</b>	Preset –	TV channels –	Channels –	Channels –	Preset –	Preset –	Preset –	Preset –	TV channels –
<b>CHANNEL +</b>	Preset +	TV channels +	Channels +	Channels +	Preset +	Preset +	Preset +	Preset +	TV channels +
<b>▶</b>	Play	Punch through	Punch through	Punch through	Play	Play	Forward play	Play	Play
<b>■</b>	Stop	Punch through	Punch through	Punch through	Stop	Stop	Stop	Stop	Stop
<b>II, A/B</b>	Pause	Punch through	Punch through	Punch through	Pause	Pause	A/B switching	Pause	Pause
<b>◀, SKIP +</b>	Disc skip +	Punch through	Punch through	Punch through	Disc skip +	–	Reverse play	–	–
<b>◀◀</b>	Search (reverse)	Punch through	Punch through	Punch through	Search (reverse)	Search (reverse)	Rewind	Search (reverse)	Search (reverse)
<b>▶▶</b>	Search (forward)	Punch through	Punch through	Punch through	Search (forward)	Search (forward)	Fast forward	Search (forward)	Search (forward)
<b>I◀◀, VCR CH –</b>	Skip (reverse)	Punch through	Punch through	Punch through	Skip (reverse)	Skip (reverse)	–	Skip (reverse)	Channel –
<b>▶▶I, VCR CH +</b>	Skip (forward)	Punch through	Punch through	Punch through	Skip (forward)	Skip (forward)	–	Skip (forward)	Channel +
<b>MENU</b>	Menu	Menu	Menu	Menu	Top menu	Menu	Menu	Menu	–
<b>△ ▽ ◀ ▶</b>	Cursor operation	Cursor operation	Cursor operation	Cursor operation	Cursor operation	Cursor operation	Cursor operation	Cursor operation	–
<b>DIMMER</b>	Dimmer	Dimmer	Dimmer	Dimmer	Menu	Dimmer	Dimmer	Dimmer	Dimmer
<b>ENTER</b>	Enter	Enter	Enter	Enter	Enter	Enter	Enter	Enter	–
<b>STATUS</b>	Status	Display	Display	Display	Display	Status	Status	Status	–
<b>VIDEO SELECT</b>	Video selection	Return	Return	Return	Return	Video selection	Video selection	Video selection	–
<b>PURE DIRECT</b>	Pure direct	Pure direct	Pure direct	Pure direct	Set up	Pure direct	Pure direct	Pure direct	Pure direct

## Operating the remote control unit

## Operating the remote control unit

## [Rear]

Device operated	CD player or iPod	TV (Monitor)	Satellite tuner	Cable TV	DVD player	CD recorder	Tape deck	MD recorder	Video deck
<b>MODE SELECTOR 1</b>	<b>A</b>					<b>B</b>			
<b>MODE SELECTOR 2</b>	<b>CD/iPod</b>	<b>TV</b>	<b>DBS/CABLE</b>		<b>DVD</b>	<b>CD-R/TAPE</b>			<b>VCR</b>
<b>POWER</b>	Power on/off	Power on/off	Power on/off	Power on/off	Power on/off	Power on/off	Power on/off	Power on/off	Power on/off
<b>NUMBER (0 ~ 9, +10)</b>	Channels	Channels	Channels	Channels	Channels	Channels	Channels	Channels	Channels
<b>BAND</b>	FM/AM/XM switching	TV/VCR switching	TV/VCR switching	TV/VCR switching	TV/VCR switching	FM/AM/XM switching	FM/AM/XM switching	FM/AM/XM switching	TV/VCR switching
<b>A, AUDIO</b>	Memory block	–	–	–	Audio	Memory block	Memory block	Memory block	–
<b>B, SUBTITLE</b>	Memory block	–	–	–	Subtitle	Memory block	Memory block	Memory block	–
<b>C, ANGLE</b>	Memory block	–	–	–	Angle	Memory block	Memory block	Memory block	–
<b>D, PICT ADJ.</b>	Memory block	–	–	–	Picture adjust	Memory block	Memory block	Memory block	–
<b>E, S.MODE</b>	Memory block	–	–	–	Search mode	Memory block	Memory block	Memory block	–
<b>TUNING +</b>	Tuning +	TV volume +	Volume +	Volume +	TV volume +	Tuning +	Tuning +	Tuning +	TV volume +
<b>TUNING –</b>	Tuning –	TV volume –	Volume –	Volume –	TV volume –	Tuning –	Tuning –	Tuning –	TV volume –
<b>Default setting (Preset code)</b>	DENON (111)	HITACHI (134)	–	ABC (007)	DENON (111)	–	DENON (114)	–	HITACHI (108)
<b>Special remarks</b>	①	①, ③	①, ③		①, ②	①			①

**Special remarks:**

- ① It is only possible to set the preset memory for one device per mode. When a new code is preset, the previous code is automatically deleted.
- ② Note that the function names of the DVD buttons on the remote control unit may differ for some brands. Check beforehand.
- ③ The CD, TAPE/CD-R/MD, VCR or DVD/VDP buttons can be assigned to a TV or satellite tuner (or cable TV) (  page 18).

# Troubleshooting

If a problem should arise, first check the following.

1. Are the connections correct?

2. Have you operated the receiver according to the Operating Instructions?

3. Are the speakers and other components operating properly?

If this unit is not operating properly, check the items listed in the table below. Should the problem persist, there may be a malfunction. Disconnect the power immediately and contact your store of purchase.

Symptom	Cause	Measures	Page
Display not lit and sound not produced when POWER switch set to on.	<ul style="list-style-type: none"> <li>Power supply cord not plugged in securely.</li> </ul>	<ul style="list-style-type: none"> <li>Check the insertion of the power supply cord plug.</li> </ul>	9
Display lit but sound not produced.	<ul style="list-style-type: none"> <li>Speaker cables not securely connected.</li> <li>INPUT SELECTOR knob position is not appropriate.</li> <li>Volume control set to minimum.</li> <li>MUTING is on.</li> </ul>	<ul style="list-style-type: none"> <li>Connect securely.</li> </ul>	6
		<ul style="list-style-type: none"> <li>Switch to the proper position.</li> </ul>	10
		<ul style="list-style-type: none"> <li>Turn volume up to suitable level.</li> <li>Switch off MUTING.</li> </ul>	10 10
Nothing is displayed on monitor.	<ul style="list-style-type: none"> <li>DRA-37's video output terminals and monitor's input terminals are not properly connected.</li> <li>Monitor's input setting is wrong.</li> </ul>	<ul style="list-style-type: none"> <li>Check that the connections are correct.</li> </ul>	6, 7
		<ul style="list-style-type: none"> <li>Set the monitor's input selector to the terminals to which video signals are connected.</li> </ul>	—
Copying from DVD to VCR is not possible.	<ul style="list-style-type: none"> <li>Copying between a source such as DVD and a VCR is not usually possible, as DVDs are often encoded with copy-protection signals that prevent VCR recording.</li> </ul>	<ul style="list-style-type: none"> <li>Copying is not possible.</li> </ul>	—
No sound is produced from subwoofer.	<ul style="list-style-type: none"> <li>Subwoofer's power is not on.</li> <li>Subwoofer's output is not connected.</li> <li>The subwoofer's channel volume level is set to "−12 dB".</li> </ul>	<ul style="list-style-type: none"> <li>Turn on the power.</li> </ul>	—
		<ul style="list-style-type: none"> <li>Connect properly.</li> </ul>	6
		<ul style="list-style-type: none"> <li>Turn the subwoofer's channel volume level up.</li> </ul>	11

Symptom	Cause	Measures	Page
This unit does not operate properly when remote control unit is used.	<ul style="list-style-type: none"> <li>Batteries dead.</li> <li>Remote control unit too far from this unit.</li> <li>Obstacle between this unit and remote control unit.</li> <li>Different button is being pressed.</li> <li>⊕ and ⊖ ends of batteries inserted in reverse.</li> </ul>	<ul style="list-style-type: none"> <li>Replace with new batteries.</li> <li>Move closer.</li> </ul>	2 2
		<ul style="list-style-type: none"> <li>Remove obstacle.</li> <li>Press the proper button.</li> <li>Insert batteries properly.</li> </ul>	— — 2
Power has turned off and the power indicator is blinking red.	<ul style="list-style-type: none"> <li>The set's internal temperature has risen and the protection circuit has been activated.</li> <li>The core wires of the speaker cables are touching each other or the DRA-37's rear panel, activating the protection circuit.</li> <li>DRA-37 is malfunctioning.</li> </ul>	<ul style="list-style-type: none"> <li>Put the DRA-37 in a well-ventilated place.</li> <li>Turn off the power, then wait for the set to fully cool off before turning the power back on.</li> </ul>	6 6
		<ul style="list-style-type: none"> <li>Check the connections of all the speaker cables.</li> </ul>	6
		<ul style="list-style-type: none"> <li>Turn off the power and contact a DENON customer service center.</li> </ul>	6
"CHECK ANTENNA" is displayed in the XM mode.	<ul style="list-style-type: none"> <li>DRA-37's XM connectors and the XM Mini-Tuner and Home Dock is not properly connected.</li> </ul>	<ul style="list-style-type: none"> <li>Check that the connection are correct.</li> </ul>	8
"NO SIGNAL" is displayed in the XM mode.	<ul style="list-style-type: none"> <li>The signal cannot be received.</li> </ul>	<ul style="list-style-type: none"> <li>Reposition your XM Mini-Tuner and Home Dock.</li> </ul>	13
"OFF AIR" is displayed in the XM mode.	<ul style="list-style-type: none"> <li>The selected channel is not currently broadcasting.</li> </ul>	<ul style="list-style-type: none"> <li>Select the another channel.</li> </ul>	14
Receiving only XM channels 0 and 1.	<ul style="list-style-type: none"> <li>The XM Tuner is not activated.</li> </ul>	<ul style="list-style-type: none"> <li>Contact XM Radio.</li> </ul>	13



# Specifications

## □ Audio section

### • Power amplifier

<b>Rated output:</b>	50 W + 50 W (8 Ω/ohms, 20 Hz ~ 20 kHz with 0.08 % T.H.D.)
<b>Output terminals:</b>	A or B 4 ~ 16 Ω/ohms A + B 8 ~ 16 Ω/ohms

### • Analog

#### (LINE input-PRE OUT)

<b>Input sensitivity / input impedance:</b>	200 mV / 47 kΩ/kohms
<b>Frequency response:</b>	10 Hz ~ 100 kHz: +1, -3 dB (TONE DEFEAT ON)
<b>S/N:</b>	98 dB (IHF-A weighted) (TONE DEFEAT ON)
<b>Total harmonic distortion:</b>	0.009 % (-3 dB at rated output, 8 Ω/ohms) (1 kHz)
<b>Rated output:</b>	1.2 V

## □ Video section

### • Standard video terminals

<b>Input / output level and impedance:</b>	1 Vp-p, 75 Ω/ohms
<b>Frequency response:</b>	5 Hz ~ 10 MHz — +1, -3 dB

## □ Tuner section

	[FM]	[AM]
	(note: μV at 75 Ω/ohms, 0 dBf = 1 x 10 <sup>-15</sup> W)	
<b>Receiving Range:</b>	87.5 MHz ~ 107.9 MHz	520 kHz ~ 1710 kHz
<b>Usable Sensitivity:</b>	1.0 μV (11.2 dBf)	18 μV
<b>50 dB Quieting Sensitivity:</b>	MONO 1.6 μV (15.3 dBf) STEREO 23 μV (38.5 dBf)	
<b>S/N (IHF-A):</b>	MONO 77 dB (IHF-A weighted) STEREO 72 dB (IHF-A weighted)	
<b>Total Harmonic Distortion (at 1 kHz):</b>	MONO 0.15 % STEREO 0.3 %	

## □ General

<b>Power supply:</b>	AC 120 V, 60 Hz
<b>Power consumption:</b>	3.0 A 1 W Max (Standby)
<b>Maximum external dimensions:</b>	434 (W) x 147 (H) x 414 (D) mm (17-3/32" x 5-25/32" x 16-19/64")
<b>Mass:</b>	8.5 kg (18 lbs 11.8 oz)

## □ Remote control unit (RC-1053)

<b>Batteries:</b>	R6P/AA Type (Two batteries)
<b>External dimensions:</b>	52 (W) x 243 (H) x 21 (D) mm (2-3/64" x 9-9/16" x 53/64")
<b>Mass:</b>	175 g (Approx. 6.2 oz) (included batteries)

\* For purposes of improvement, specifications and design are subject to change without notice.

☐ List of preset codes / Liste de codes prééglés

**DVD**

Denon	014, *[111]
Aiwa	009
Hitachi	010
JVC	006, 011
Konka	012, 013
Magnavox	005
Mitsubishi	004
Panasonic	014
Philips	005, 015, 016, 017
Pioneer	003, 008
Sanyo	018
Sony	002, 019, 020
Toshiba	001, 021, 022
Zenith	023

**VDP**

Denon	028, 029, 112
Magnavox	026
Mitsubishi	028
Panasonic	029, 030
Philips	026
Pioneer	028, 031
RCA	032
Sony	033, 034, 035, 036

**VCR**

Admiral	081
Aiko	095
Aiwa	009
Akai	026, 027, 070, 072, 082, 083, 084
Alba	055
Amstrad	009

ASA	042
Asha	087
Audio Dynamic	005, 085
Audiovox	088
Beaumarck	087
Broksonic	086, 093
Calix	088
Candle	006, 087, 088, 089, 090
Canon	049, 057
Capehart	025, 055, 056, 071
Carver	015
CCE	095
Citizen	006, 007, 087, 088, 089, 090, 095
Craig	007, 087, 088, 091, 115
Curtis Mathes	006, 049, 073, 080, 087, 090, 092
Cybernex	087
Daewoo	025, 055, 059, 074, 089, 093, 095, 096
Daytron	025, 055
DBX	005, 085
Dumont	053
Dynatech	009
Electrohome	001, 088, 097
Electroponic	088
Emerson	001, 009, 017, 027, 086, 088, 089, 092, 093, 097, 100, 101, 102, 103, 104, 117
Fisher	009, 028, 031, 053, 054, 091, 099, 115
GE	007, 011, 049, 050, 051, 052, 073, 080, 087

Go Video	047, 048
Goldstar	000, 006, 012, 062, 088
Gradiente	094
Grundig	042
Harley Davidson	094
Harman Kardon	040, 062
Hi-Q	091
Hitachi	009, 013, 023, 026, 058, *[108], 109, 110, 111
JC Penny	004, 005, 007, 023, 028, 049, 062, 085, 087, 088
Jensen	013, 026
JVC	004, 005, 006, 026, 029, 043, 044, 045, 046, 085
Kenwood	004, 005, 006, 026, 029, 033, 045, 085, 090
Kodak	088
Lloyd	009, 094
LXI	088
Magnavox	015, 016, 042, 049, 063, 106
Magnin	087
Marantz	004, 005, 006, 015, 042, 049, 085, 090
Marta	088
MEI	049
Memorex	009, 033, 049, 053, 060, 081, 087, 088, 091, 094, 115
Metz	123, 124, 125, 126, 127, 128
MGA	001, 017, 027, 041, 097
MGN Technology	087
Midland	011

Minolta	013, 023
Mitsubishi	001, 003, 008, 013, 014, 017, 027, 029, 039, 040, 041, 045, 097
Motorola	081
Montgomery Ward	001, 002, 007, 009, 049, 063, 081, 115, 117
MTC	009, 087, 094
Multitech	007, 009, 011, 087, 090, 094
NAD	038
NEC	004, 005, 006, 018, 026, 029, 045, 061, 062, 085
Nikko	088
Noblex	087
Optimus	081, 088
Optonica	021
Panasonic	024, 049, 064, 066, 067, 068, 069, 107
Perdio	009
Pentax	009, 013, 023, 058, 090
Philco	015, 016, 049
Philips	015, 021, 042, 049, 105
Pilot	088
Pioneer	005, 013, 029, 036, 037, 038, 045, 085
Portland	025, 055, 090
Proscan	063, 080
Pulsar	060
Quartz	033
Quasar	034, 035, 049
Radio Shack	001, 002, 021, 081, 087, 088, 091, 094, 097, 098, 115

Radix	088	Technics	024, 049	Bell & Howell	045, 118	Fujitsu	004, 062
Randex	088	Teknika	009, 010, 022, 049, 088, 094	Bradford	061	Funai	004, 062
RCA	007, 013, 019, 023, 058, 063, 064, 065, 073, 080, 082, 087	TMK	087, 092	Brockwood	003, 047	Futuretech	004
Realistic	009, 021, 031, 033, 049, 053, 081, 087, 088, 091, 094, 097, 098	Toshiba	013, 017, 020, 041, 059, 089, 098, 099, 117	Candle	003, 030, 031, 032, 038, 047, 049, 050, 122	GE	020, 036, 037, 040, 044, 058, 066, 088, 119, 120, 125, 147
Ricoh	055	Totevision	007, 087, 088	Capehart	003	Goldstar	000, 015, 029, 031, 039, 048, 051, 056, 057, 067, 068, 069, 116
Salora	033, 041	Unirech	087	Celebrity	046	Grundy	062
Samsung	007, 011, 051, 059, 070, 083, 087, 089, 113	Vectror Research	005, 062, 085, 089, 090	Circuit City	003	Hitachi	029, 031, 051, 052, 070, 111, 112, 113, 124, <b>*[134]</b>
Sanky	081	Victor	005, 045, 046, 085	Citizen	029, 030, 031, 032, 034, 038, 047, 049, 050, 054, 061, 095, 122, 123	Hitachi Pay TV	151
Sansui	005, 026, 029, 045, 061, 085, 114	Video Concepts	005, 027, 085, 089, 090	Concerto	031, 047, 049	Infinity	017, 071
Sanyo	032, 033, 053, 087, 091, 115, 116	Videosonic	007, 087	Colortyme	003, 047, 049, 135	Janeil	122
SBR	042	Wards	013, 021, 023, 087, 088, 089, 091, 094, 097, 118, 119, 120	Contec	013, 051, 052, 061	JBL	017, 071
Scott	017, 020, 086, 089, 093, 117	XR-1000	094	Cony	051, 052, 061	JC Penny	020, 034, 039, 040, 041, 044, 048, 050, 058, 066, 069, 076, 088, 090, 095, 125, 136, 159
Sears	013, 023, 028, 031, 033, 053, 054, 088, 091, 098, 099, 115	Yamaha	004, 005, 006, 026, 062, 085	Craig	004, 061	JCB	046
Sentra	055	Zenith	060, 078, 079	Crown	029	JVC	019, 051, 052, 072, 073, 091, 117, 126
Sharp	001, 002, 021, 097	<b>TV</b>		Curtis Mathes	029, 034, 038, 044, 047, 049, 053, 095, 118	Kawasho	018, 046
Shogun	087	Admiral	045, 121	Daewoo	027, 029, 039, 048, 049, 054, 055, 106, 107, 137	Kenwood	038, 056, 057
Sony	075, 076, 077, 078, 079, 121, 122	Adventura	122	Daytron	003, 049	Kloss	010, 032
STS	023	Aiko	054	Dimensia	044	Kloss Novabeam	005, 122, 127, 131
Sylvania	009, 015, 016, 017, 041, 049, 094	Akai	016, 027, 046	Dixi	007, 015, 027	KTV	074, 123
Symphonic	009, 094	Alleron	062	Electroband	046	Loewe	071
Tandy	009	A-Mark	007	Electrohome	029, 056, 057, 058, 147	Logik	144
Tashiko	009, 088	Amtron	061	Elta	027	Luxman	031
Tatung	004, 026, 030	Anam	006, 007, 036	Emerson	029, 051, 059, 060, 061, 062, 118, 123, 124, 139, 148	LXI	008, 014, 017, 024, 040, 044, 063, 071, 075, 076, 077, 118, 125
Teac	004, 009, 026, 094	Anam National	061, 147	Envision	038		
		AOC	003, 007, 033, 038, 039, 047, 048, 049, 133	Etron	027		
		Archer	007	Fisher	014, 021, 063, 064, 065, 118		
		Audiovox	007, 061	Formenti	155		
		Bauer	155	Fortress	012		
		Belcor	047				

Magnavox	005, 010, 017, 030, 033, 038, 050, 056, 071, 078, 079, 085, 089, 108, 109, 110, 127, 131, 132, 145
Marantz	015, 017, 071, 080
Matsui	027
Memorex	014, 027, 045, 083, 118, 144
Metz	160, 161, 162, 163
MGA	001, 039, 048, 056, 057, 058, 065, 081, 083
Midland	125
Minutz	066
Mitsubishi	001, 016, 039, 048, 056, 057, 058, 065, 081, 082, 083, 105
Montgomery Ward	011, 020, 144, 145, 146
Motorola	121, 147
MTC	031, 034, 039, 048, 095
NAD	008, 075, 076, 128
National	002, 036, 061, 147
National Quenties	002
NEC	031, 038, 039, 048, 057, 084, 086, 135, 147
Nikko	054
NTC	054
Optimus	128
Optonica	011, 012, 093, 121
Orion	004, 139
Panasonic	002, 009, 017, 036, 037, 071, 141, 143, 147
Philco	005, 010, 030, 050, 051, 056, 079, 085, 127, 131, 132, 145, 147

Philips	005, 015, 017, 050, 051, 056, 078, 087, 088, 089, 131, 132, 147
Pioneer	124, 128, 142
Portland	054
Price Club	095
Proscan	040, 044, 125
Proton	035, 051, 092, 129
Pulsar	042
Quasar	036, 037, 074, 141
Radio Shack	011, 044, 063, 093, 118
RCA	040, 044, 125, 130, 137, 151, 152
Realistic	014, 063, 093, 118
Saisho	027
Samsung	003, 015, 034, 053, 055, 057, 094, 095, 136, 153
Sansui	139
Sanyo	013, 014, 021, 022, 063, 064, 081, 096
SBR	015
Schneider	015
Scott	062
Sears	008, 014, 021, 022, 023, 024, 025, 040, 052, 057, 062, 063, 064, 065, 073, 075, 076, 097, 098, 125, 159
Sharp	011, 012, 013, 026, 093, 099, 100, 104, 121
Siemens	013
Signature	045, 144
Simpson	050
Sony	043, 046, 138, 146, 150
Soundesign	030, 050, 062
Spectricon	007, 033

Squareview	004
Supre-Macy	032, 122
Supreme	046
Sylvania	005, 010, 017, 030, 078, 079, 085, 089, 101, 127, 131, 132, 145, 155
Symphonic	004, 148
Tandy	012, 121
Tatung	036, 124
Technics	037
Teknika	001, 030, 032, 034, 052, 054, 078, 083, 095, 144, 156, 157
Tera	035, 129
THOMSON	165, 166
Toshiba	008, 014, 034, 063, 075, 076, 095, 097, 136, 158, 159
Universal	020, 066, 088
Victor	019, 073, 126
Video Concepts	016
Viking	032, 122
Wards	005, 045, 066, 078, 085, 088, 089, 093, 102, 103, 131, 132, 148
Zenith	042, 114, 115, 140, 144, 149
Zonda	007

### CABLE

ABC	006, *[007], 008, 009
Archer	010, 011
Century	011
Citizen	011
Colour Voice	012, 013
Comtronic	014

Eastern	015
Garrard	011
Gemini	030, 033, 034
General Instrument	030, 031, 032
Hytex	006
Jasco	011
Jerrold	009, 016, 017, 026, 032
Magnavox	018
Movie Time	019
NSC	019
Oak	000, 006, 020
Panasonic	001, 005
Philips	011, 012, 013, 018, 021
Pioneer	002, 003, 022
RCA	029
Regency	015
Samsung	014, 023
Scientific Atlanta	004, 024, 025
Signal	014
SL Marx	014
Starcom	009
Stargate	014
Teleview	014
Tocom	007, 016
TV86	019
Unika	011
United Artists	006
Universal	010, 011
Viewstar	018, 019
Zenith	027, 028

### DBS (SATELLITE)

Alphastar	054
Chaparral	035, 036
Dishnet	053
Drake	037, 038

Echostar Dish	062, 066
GE	048, 055, 056
General Instruments	039, 040, 041
Grundig	070, 071, 072, 073
Hitachi	058, 059
Hughes Network	063, 064, 065, 069
JVC	057
Kathrein	074, 075, 076, 083
Magnavox	060
Nokia	070, 080, 084, 085, 086
Philips	060
Primestar	051
Proscan	048, 055, 056
RCA	048, 055, 056, 068
Realistic	042
Sierra I	036
Sierra II	036
Sierra III	036
Sony	049, 067
STS1	043
STS2	044
STS3	045
SRS4	046
Technisat	077, 078, 079, 081, 082
Toshiba	047, 050
Uniden	061

**CD**

Denon	<b>*[111]</b> , 044
Aiwa	001, 035, 043
Burmster	002
Carver	003, 035
Emerson	004, 005, 006, 007
Fisher	003, 008, 009, 010
JVC	018, 019
Kenwood	011, 012, 013, 014, 017

Magnavox	006, 015, 035
Marantz	016, 028, 035
MCS	016, 024
Onkyo	025, 027
Optimus	017, 020, 021, 022, 023
Philips	014, 032, 033, 035
Pioneer	006, 022, 030
Sears	006
Sony	023, 031
Teac	002, 009, 028
Technics	016, 029, 036
Wards	035, 037
Yamaha	038, 039, 040, 041
Zenith	042

**CDR**

Denon	<b>*[111]</b> , 112
Philips	112

**MD**

Denon	113
Kenwood	003, 004
Onkyo	007
Sharp	005
Sony	006

**TAPE**

Denon	<b>*[114]</b>
Aiwa	010, 011
Carver	011
Harman/Kardon	011, 012
JVC	013, 014
Kenwood	015
Magnavox	011
Marantz	011
Onkyo	025, 027

Optimus	016, 017
Panasonic	021
Philips	011
Pioneer	016, 017, 018
Sony	022, 023, 024
Technics	021
Victor	013
Wards	016
Yamaha	019, 020

\*[ ] : Preset codes set upon shipment from the factory.

\*[ ] : Les codes pré-réglés diffèrent en fonction des livraisons de l'usine.

DVD preset codes / Codes pré-réglés DVD			
	111 (default / défaut)	014	
DENON Model No. / Modèle numéro	DVD-555	DVD-2900	DVD-800
	DVD-755	DVD-2910	DVD-1600
	DVD-900	DVD-3800	DVD-2000
	DVD-910	DVD-3910	DVD-2500
	DVD-955	DVD-5900	DVD-3000
	DVD-1000	DVD-5910	DVD-3300
	DVD-1200	DVD-9000	
	DVD-1500	DVM-715	
	DVD-1710	DVM-1800	
	DVD-1910	DVM-1805	
	DVD-2200	DVM-1815	
	DVD-2800	DVM-2815	
DVD-2800II	DVM-4800		

**DENON**

TOKYO, JAPAN  
[www.denon.com](http://www.denon.com)

Denon Brand Company, D&M Holdings Inc.  
Printed in China 00D 511 4541 104

## Free Manuals Download Website

<http://myh66.com>

<http://usermanuals.us>

<http://www.somanuals.com>

<http://www.4manuals.cc>

<http://www.manual-lib.com>

<http://www.404manual.com>

<http://www.luxmanual.com>

<http://aubethermostatmanual.com>

Golf course search by state

<http://golfingnear.com>

Email search by domain

<http://emailbydomain.com>

Auto manuals search

<http://auto.somanuals.com>

TV manuals search

<http://tv.somanuals.com>