

# 1080p DLP Front Projector

# User's Manual

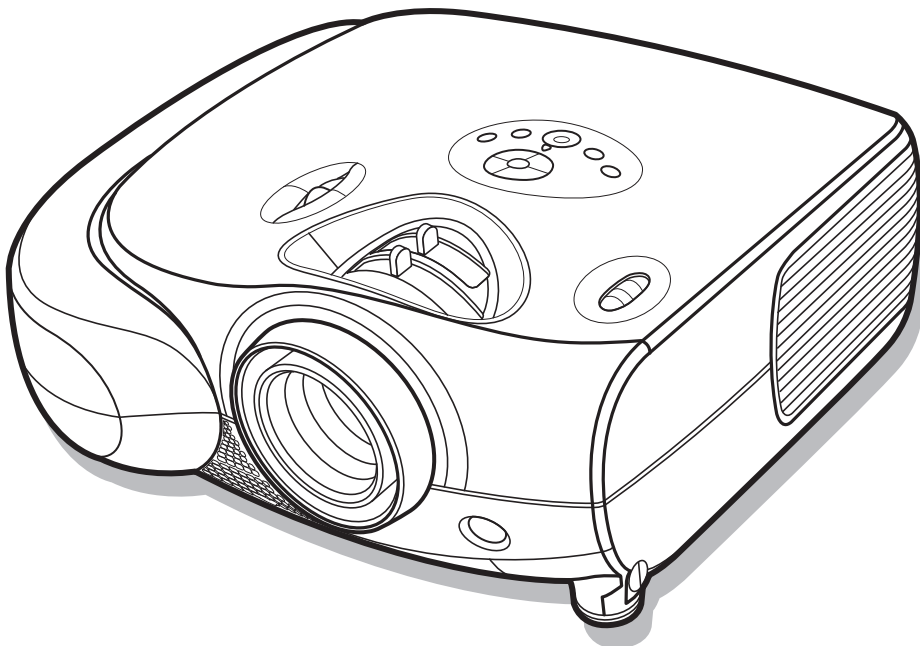

1080p DLP Front Projector

# Preface

ENGLISH

## ABOUT THIS MANUAL

This manual is designed for use with the 1080p DLP Front Projector. Information in this document has been carefully checked for accuracy; however, no guarantee is given to the correctness of the contents. The information in this document is subject to change without notice.

## COPYRIGHT

© Copyright 2009

This document contains proprietary information protected by copyright. All rights are reserved. No part of this manual may be reproduced by any mechanical, electronic or other means, in any form, without prior written permission of the manufacturer.

## TRADEMARKS

All trademarks and registered trademarks are the property of their respective owners.

## FCC COMPLIANCE

This device complies with Part 15 of the FCC Rules. Operation is subject to the following two conditions:

- (1) This device may not cause harmful interference, and
- (2) This device must accept any interference received, including interference that may cause undesired operation.

## FEDERAL COMMUNICATIONS COMMISSION (FCC) STATEMENT

This equipment has been tested and found to comply with the limits for a Class B digital device, pursuant to part 15 of the FCC Rules. These limits are designed to provide reasonable protection against harmful interference in a residential installation. This equipment generates, uses and can radiate radio frequency energy and, if not installed and used in accordance with the instructions, may cause harmful interference to radio communications. However, there is no guarantee that interference will not occur in a particular installation. If this equipment does cause harmful interference to radio or television reception, which can be determined by turning the equipment off and on, the user is encouraged to try to correct the interference by one or more of the following measures:

Reorient or relocate the receiving antenna.

Increase the separation between the equipment and the receiver.

Connect the equipment to an outlet on a circuit different from that to which the receiver is connected.

Consult the dealer or an experienced radio/TV technician for help.

# Notices



**WARNING!** To meet FCC requirements, a shielded power cord is required in order to prevent interference. It is essential that only the supplied power cord is to be used. Use only shielded cables to connect I/O devices to this equipment. You are cautioned that changes or modifications not approved by the party responsible for compliance could void your authority to operate the equipment.



**WARNING!** The projector cooling fan continues to run for approximately 90 seconds after the projector is turned off using the Power button on the control panel or remote control. Never unplug the power cable to power off the projector; damage to the lamp may result.



**WARNING!** High brightness light source. Do not stare into the beam of light, or view directly.

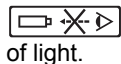

Be especially careful and ensure that children do not stare directly into the beam of light.



**WARNING!** To reduce the risk of fire or electric shock, do not expose this product to rain or moisture.



**CAUTION!** For minimal servicing and to maintain high image quality, we recommend that you use the projector in an environment that is smoke and dust free. When used in areas where there is a lot of smoke or dust, the filter and lens should be cleaned often to lengthen the service life of the projector.



**WARNING!** Some IC chips in this product include confidential and/or trade secret property belonging to Texas Instruments. Therefore you may not copy, modify, adapt, translate, distribute, reverse engineer, reverse assemble or decompile the contents thereof.



**WARNING!** The ventilation slots, lamp, and objects next to them may get extremely hot during operation. Do not touch these areas until they have sufficiently cooled down.

## PRODUCT DISPOSAL

This projector utilizes a tin-lead solder, P-VIP Lamp containing a small amount of mercury. Disposal of these materials may be regulated due to environmental considerations.

## IMPORTANT RECYCLING INSTRUCTIONS

	<p>Lamp(s) inside this product contain mercury. This product may contain other electronic waste that can be hazardous if not disposed of properly. Recycle or dispose in accordance with local, state, or federal Laws. For more information, contact the Electronic Industries Alliance at <a href="http://WWW.EIAE.ORG">WWW.EIAE.ORG</a>. For lamp specific disposal information check <a href="http://WWW.LAMPRECYCLE.ORG">WWW.LAMPRECYCLE.ORG</a>.</p>
---	--

### Caution regarding the exhaust of the projector.

Do not place the projector in space that is poorly ventilated or confined. Allow at least 50 cm clearance from walls and free air flow around the projector.

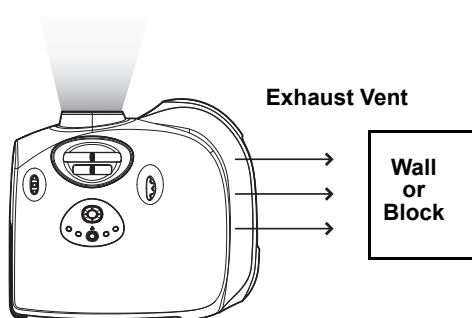

Before using the projector, please read this operation manual carefully.

To facilitate reporting the loss or theft of your Projector, record the Serial Number located on the bottom of the projector and retain this information. Before recycling the packaging, be sure that you have checked the contents of the carton thoroughly against the list of "Package Contents" on page 7.

## WARRANTY

Promptly register the Projector's Warranty using the REGISTRATION CARD packed with the projector. The Warranty assures that you immediately receive the full benefit of the parts, service and labor warranty applicable to your purchase.

## SYMBOL EXPLANATIONS

	<p><b>DISPOSAL:</b> Do not use household or municipal waste collection services for disposal of electrical and electronic equipment. EU countries require the use of separate recycling collection services.</p>
---	--

# Contents

Preface .....	1
Notices .....	2

## Introduction

Package Contents .....	7
Features .....	8
Components .....	9
Projector (Front and Top View) .....	9
Projector (Rear View) .....	10
Remote Control .....	11
Using the Remote Control .....	12
Available Range of the Remote Control .....	12
Inserting the Batteries .....	12

## Connections and Setup

Connecting the Projector to Other Devices .....	14
Before Setting Up .....	14
Connecting the Power Cord .....	14
Connecting to Video Equipment .....	15
Connecting to Video Equipment .....	15
Connecting to Component Video Equipment .....	16
Connecting by Using a HDMI to HDMI Cable .....	16
Connecting the Projector to a Computer .....	17
Connecting to a Computer .....	17
Connecting the Thumbscrew Cables .....	18
“Plug and Play” Function .....	18
Using the Adjustment Feet .....	19
Adjusting the Lens .....	20
Using the Lens Shift .....	20
Setting up the Screen .....	21
Screen Size and Projection Distance (Short throw lens) .....	22
Screen Size and Projection Distance (Long throw lens) .....	23
Projection from behind the screen .....	24

## Basic Operation

Image Projection .....	26
Basic Procedure .....	26
Selecting the On-screen Display Language .....	28
Menu Bar Items .....	29
Using the Menu Screen .....	30
Menu Selections (Adjustments) .....	30
Adjusting the Picture .....	31
Adjusting Image Preferences .....	31
Adjusting Computer Images .....	35

## Easy to Use Functions

Selecting the Picture Display Mode .....	37
Overscan Type .....	40
Overscan Adjust .....	40

H-V Position Function.....	41
H-V Keystone Function .....	42
Selecting the Economy Mode.....	43
Setting the Power Save.....	43
Sync Threshold .....	44
Automatic Power OFF Function .....	44
Source Select .....	45
OSD Time Out.....	45
OSD Blending.....	46
Film Mode.....	46
STI.....	47
Noise Reduction .....	48
Blank Screen .....	48
Reset .....	49
Reversing/Inverting Projected Images.....	49
Setting the PRJ Mode .....	49
Lamp Timer Reset.....	50
Status .....	50
Input Source .....	51
Factory reset .....	51





## Appendix

Maintenance.....	53
Cleaning the Ventilative Holes .....	54
Cleaning the Ventilative Holes .....	54
About the Lamp .....	55
Caution Concerning the Lamp .....	55
Replacing the Lamp .....	55
Temperature LED (Over Temperature).....	56
Removing and Installing the Lamp Unit.....	57
Resetting the Lamp Timer .....	58
Connecting Pin Assignments .....	59
Computer Compatibility Chart .....	60
Video Compatibility Chart.....	61
Troubleshooting.....	62
Product Specifications .....	64
Short Throw Lens Dimension .....	65
Long Throw Lens Dimension.....	66

# Introduction

# Package Contents

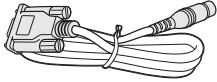
Open the package and ensure that you have the following items:

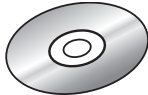
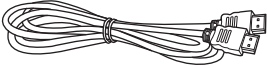
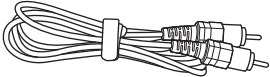
		
Remote control	Two "AAA" size batteries	Power cord (By country)
		
RS232 cable	Quick Guide	CD with User's Manual
		
HDMI to HDMI cable (3M)	Composite cable (3.6M)	

## Optional accessories

VGA to VGA cable  
Ceiling mount package  
Component cable  
S-Video cable



### Note

- Some of the cables may not be available depending on the region. Please check with your nearest Authorized Dealer.

If anything is missing or appears damaged, contact your dealer immediately.



# Features

- Newly developed 0.65-inch 1080p DMD™ chip provides significantly improved optical efficiency and excellent contrast ratio.
- Newly developed LVDS (Low voltage differential signal) chip eliminates Color Breaking phenomena common with previous generation DLP™ projectors.
- Use of high-output lamp realizes both high color purity and high brightness. Natural images made possible by high color reproducibility can be created with high-brightness, powerful expression capabilities.
- New i/p conversion algorithm enhances the performance of the motion detect i/p conversion.
- Extensive improvements on the jagged edges or slanted lines in moving images.
- New Edge Up-Scaling.
- As a result of reducing jagged edges and flickering when up-scaling edges of slanted lines, even signals not reaching a panel resolution of 480i/p can be projected by converting them to 1920X1080 resolution images.
- New Film Mode Function.
- 3:2 pull down enhancement for 480i and 2:2 for 576i signals, but HDTV 1080i signals as well.
- Use of a HDMI/HDCP terminal enables all processes from input to signal processing and projection to be performed digitally, resulting in the realization of all-digital projection without any data loss due to analog conversion. This also supports the building of home theaters using HTPC.
- Provides the new Brilliant Color™ algorithm which provides enhancement to the functions of gamma, and Spoke light recapture.

# Components

## Projector (Front and Top View)

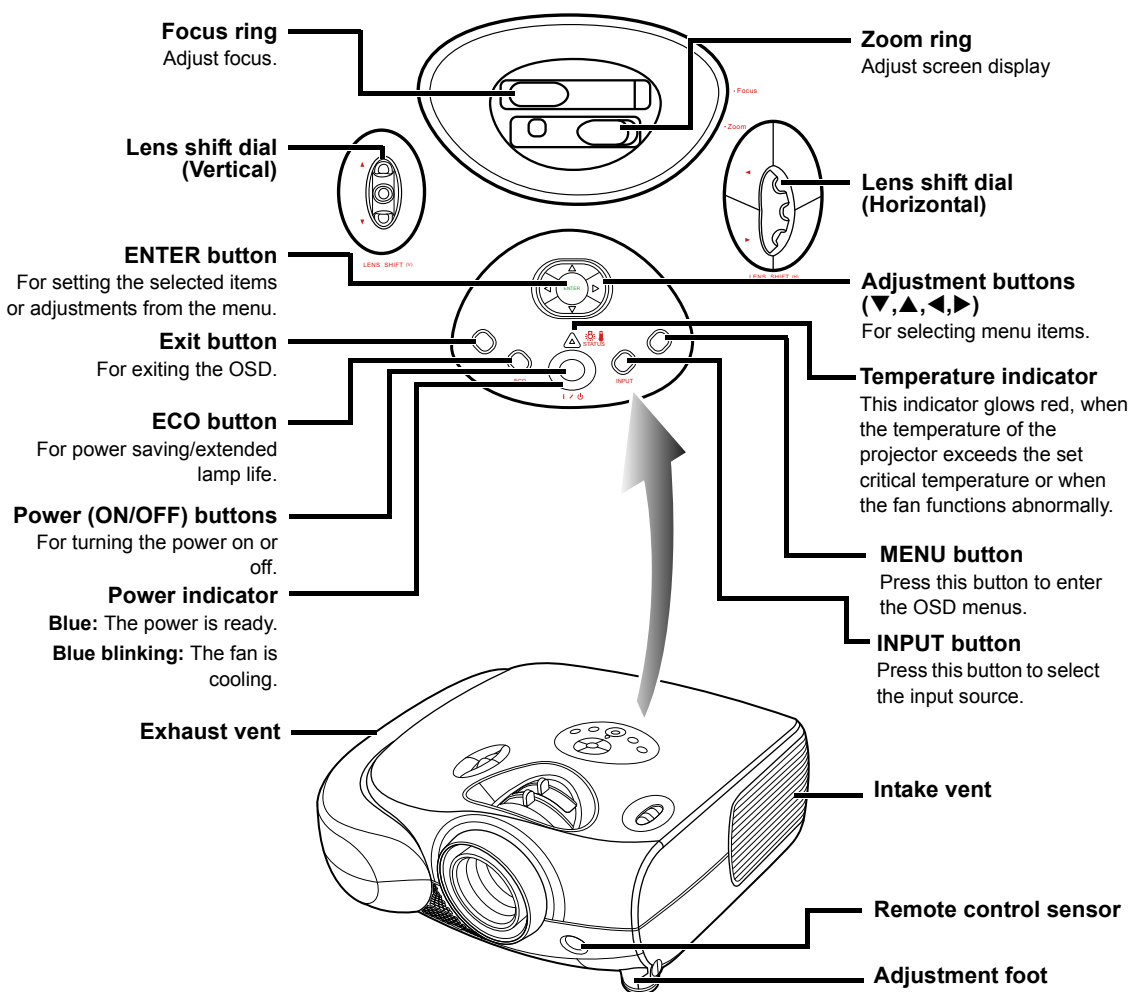

### Temperature indicator

The projector has an over temperature warning LED on the control panel. If the projector overheats because of a dirty filter or another problem, the LED will light up, and the projector lamp will turn off, after which a 90-second cooling off period occurs. After restarting the projector, if the unit doesn't operate normally, take the projector in for servicing.

# Projector (Rear View)

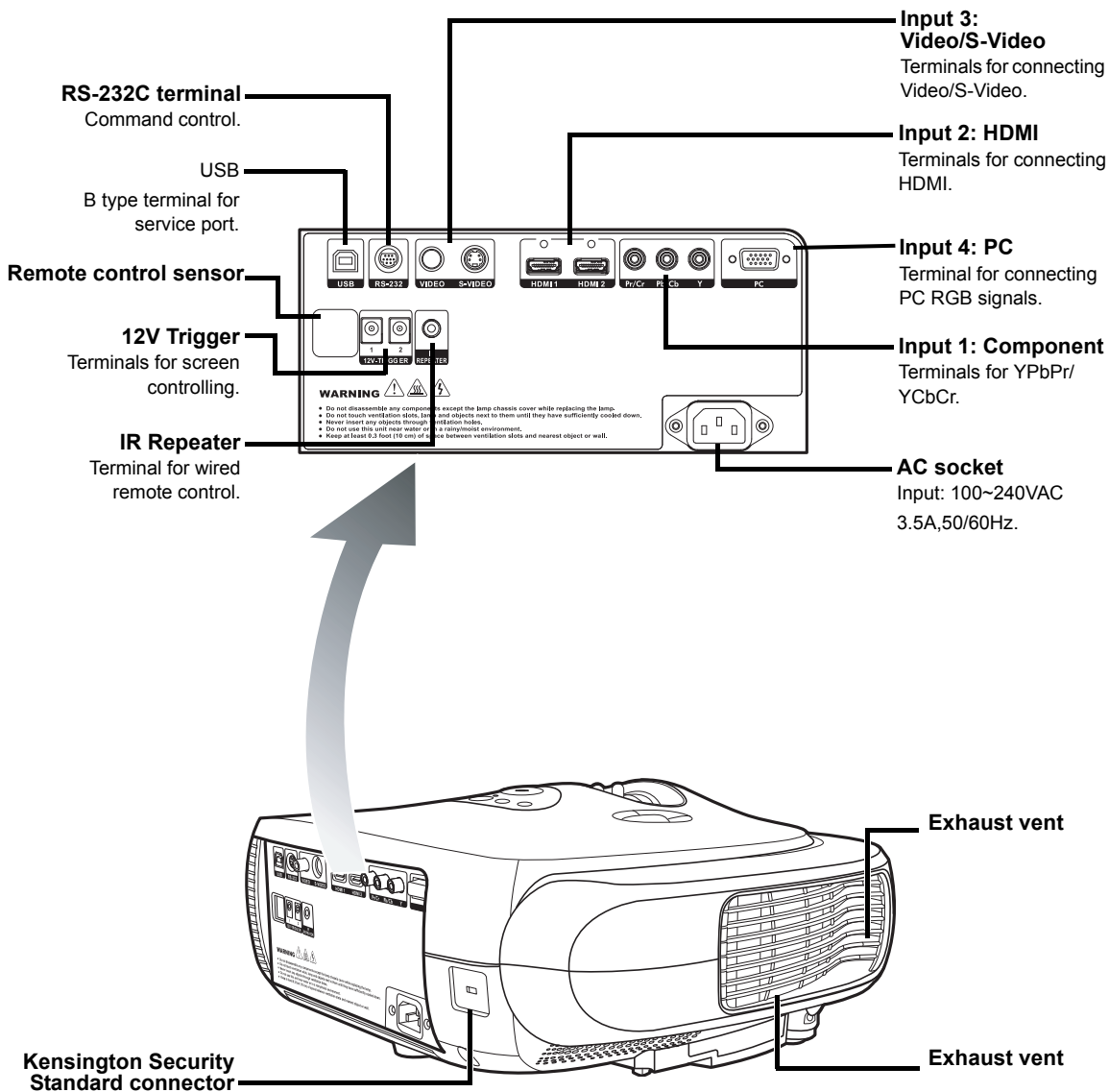

**WARNING!** As the projector lamp becomes extremely hot, air blowing out from the ventilation slots can be uncomfortably hot.

## Using the Kensington Lock

This projector has a Kensington Security Standard connector for use with a Kensington MicroSaver Security System. Refer to the information that came with the system for instructions on how to use it to secure the projector.

# Remote Control

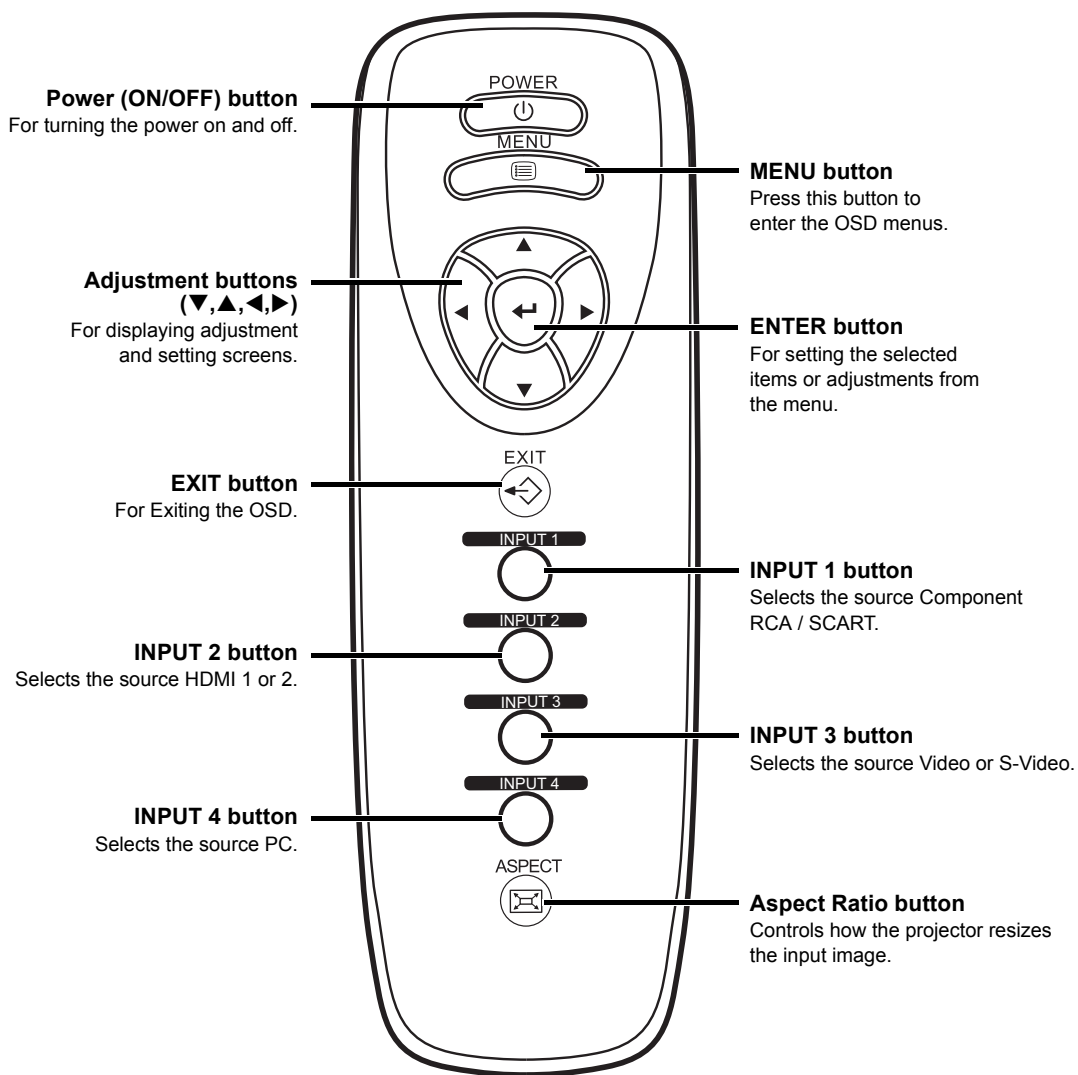

# Using the Remote Control

## Available Range of the Remote Control

- The remote control can be used to control the projector within the ranges shown in the illustration.

### Note

- The signal from the remote control can be reflected by the screen.

### When using the remote control:

- Be sure not to drop it, or expose it to moisture or high temperature.
- The remote control may malfunction under a fluorescent lamp. If that occurs, move the projector away from the fluorescent lamp.

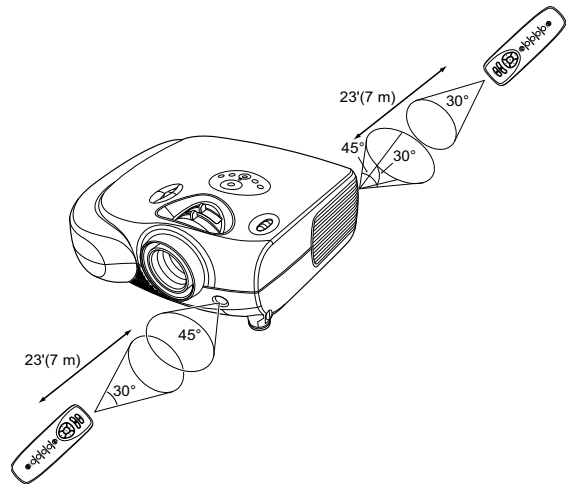

## Inserting the Batteries

The batteries (two "AAA" size) are included in the package.

- 1 Press down the tab on the cover and pull the cover towards the direction of the arrow.**
- 2 Insert the included batteries.**  
Insert the batteries making sure the polarities correctly match the  $\oplus$  and  $\ominus$  marks inside the battery compartment.
- 3 Insert the lower tab of the cover into the opening, and press down the cover until it clicks in place.**

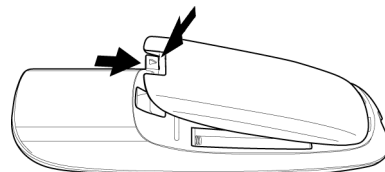
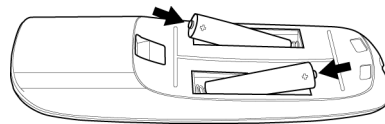
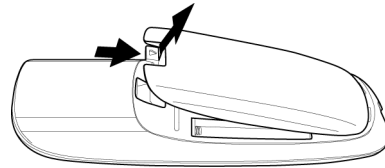

# Connections and Setup

# Connecting the Projector to Other Devices

## Before Setting Up

### Note

- Before connecting, be sure to turn off both the projector and the devices to be connected. After making all connections, turn on the projector and then the other devices.  
When connecting a computer, be sure that it is the last device to be turned on after all the connections are made.
- Be sure to read the operation manuals of the devices to be connected before making connections.

## This projector can be connected to

### Video equipment:

- A VCR, Laser disc player or other video equipment.
- A DVD player or DTV\* decoder.

\*DTV is the umbrella term used to describe the new digital television system in the United States.

### A computer using:

- HD 15-pin VGA to VGA cable (optional item, sold separately).

## Connecting the Power Cord

Plug in the supplied power cord into the AC socket on the rear of the projector.

Supplied  
accessory



Power cord

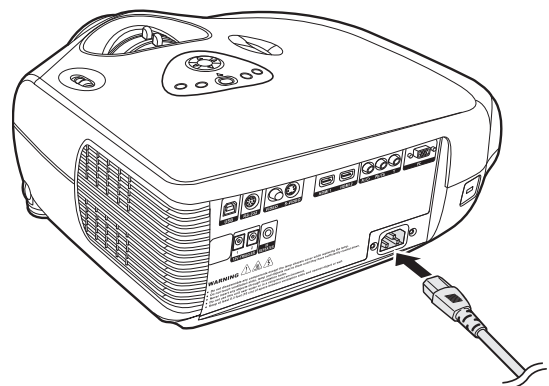

# Connecting to Video Equipment

## Connecting to Video Equipment

### Using an S-Video or a Composite Video Cable

Using an S-Video or a Composite video cable, a VCR, laser disc player or other video equipment can be connected to INPUT 3 input terminals.

#### Note

- The INPUT 3 (S-VIDEO) terminal uses a video signal system in which the picture is separated into color and luminance signals to realize a higher-quality image. To view a higher-quality image, use a commercially available S-Video cable to connect the INPUT 3 terminal on the projector and the S-Video output terminal on the video equipment.

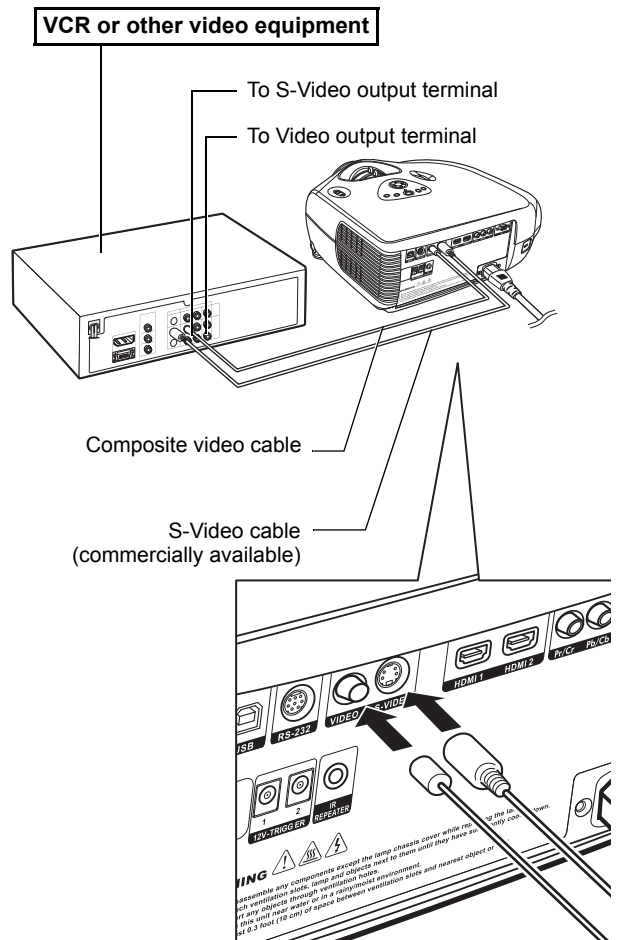



## Connecting to Component Video Equipment

### Using a Component Cable (INPUT 1)

Use a component cable when connecting to the INPUT 1 terminal and component video equipment such as DVD players and DTV\* decoders.

\*DTV is an umbrella term used to describe the new digital television system in the United States.

 **Note**

- When connecting the projector to the video equipment in this way, select "Component" for "Input Source" in the "Main" menu.

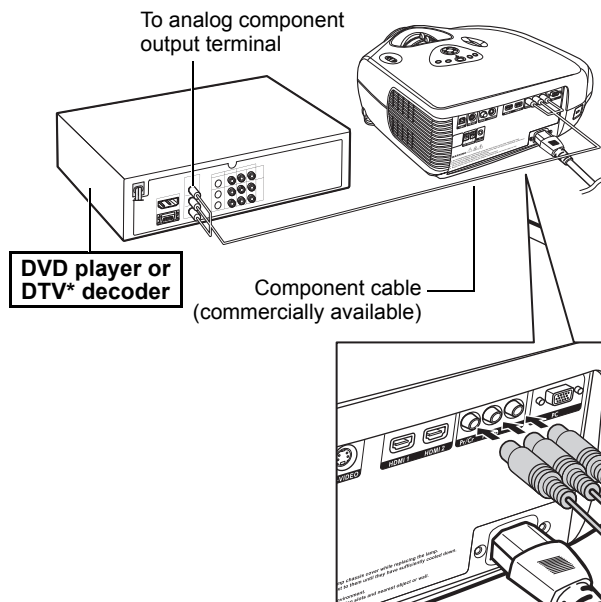

The component jack for a DVD and so forth may be indicated with Y, CB or CR. Connect each jack as shown below.

Projector	Y	PB	PR
	↓	↑	↑
DVD player or DTV decoder	Y	CB	CR

## Connecting by Using a HDMI to HDMI Cable

Use an HDMI to HDMI cable when connecting HDMI video equipment such as DVD players to INPUT 2 terminal.

- 1 Connect an HDMI to HDMI cable to the projector.
- 2 Connect the above cable to the video equipment.

 **Note**

- Select the input signal type of the video equipment.

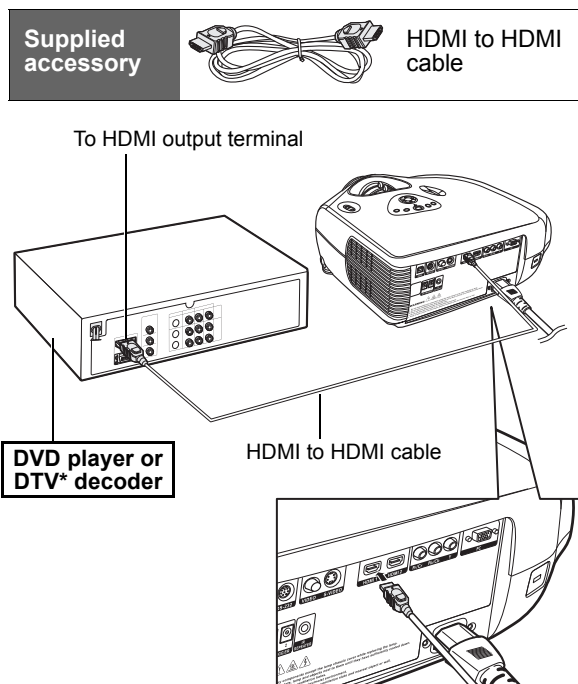

# Connecting the Projector to a Computer

## Connecting to a Computer

Connect the projector to the computer using the HD 15-pin VGA to VGA cable.

- Secure the connectors by tightening the thumbscrews.

Optional  
accessory



HD 15-pin  
VGA to VGA  
cable

### Note

- See page 60 "Computer Compatibility Chart" for a list of computer signals compatible with the projector. Use with computer signals other than those listed may cause some of the functions not to work.
- A Macintosh adaptor may be required for use with some Macintosh computers. Contact your nearest Authorized Service Center or Dealer.
- Depending on the computer you are using, an image may not be projected unless the signal output setting of the computer is switched to the external output. Refer to the computer operation manual for switching the computer signal output settings.

Notebook Computer

HD 15-pin VGA to VGA cable  
(sold separately)

To VGA output terminal

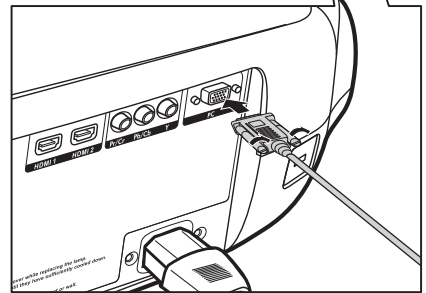
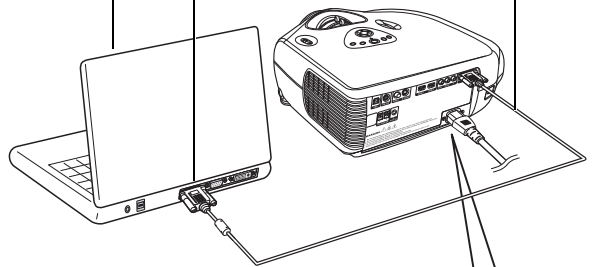

## Connecting the Thumbscrew Cables

- Connect the thumbscrew cable making sure that it fits correctly into the terminal. Then, firmly secure the connectors by tightening the screws on both sides of the plug.
- Do not remove the ferrite core attached to the HD 15-pin VGA cable.

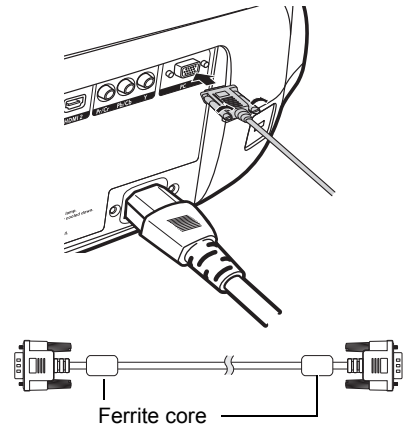

## “Plug and Play” Function

- This projector is compatible with VESA-standard DDC 1/DDC 2B. The projector and a VESA DDC compatible computer will communicate their setting requirements, allowing for quick and easy setup.
- Before using the “Plug and Play” function, be sure to turn on the projector first and the connected computer last.

### Note

- The DDC “Plug and Play” function of this projector operates only when used in conjunction with a VESA DDC compatible computer.

# Using the Adjustment Feet

The height of the projector can be adjusted using the adjustment feet when the surface the projector is placed on is uneven or when the screen is slanted.

The projection of the image can be made higher by adjusting the projector when it is in a location lower than the screen.

- 1 Press the foot releases and lift the projector to the desired angle.**
- 2 Remove your hands from the foot releases. Once the adjustment feet have locked in position, place the projector down.**
  - If the screen is at an angle, the adjustment feet can be used to adjust the angle of the image.

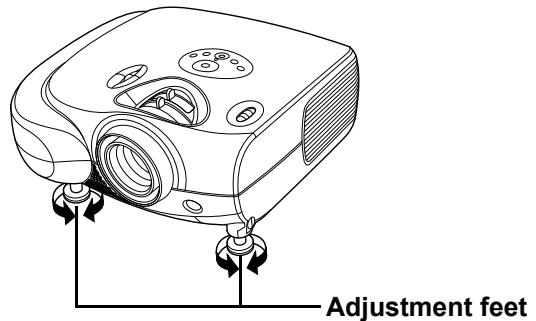
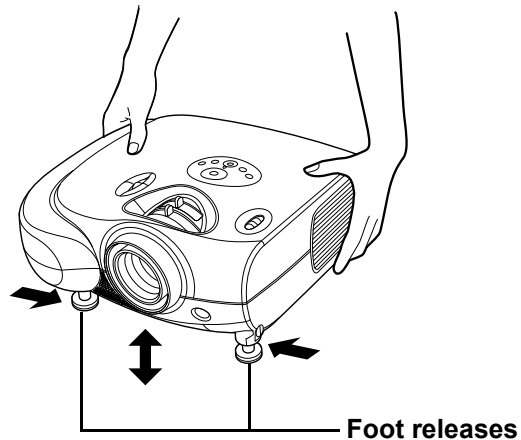

## Note

- The projector is adjustable up to approximately 11 degrees from the standard position.
- When the height of the projector is adjusted, the image may become distorted (keystoned), depending on the relative positions of the projector and the screen. See page 42 for details on keystone correction.

## Info

- When lowering the projector, be careful not to get your finger caught in the area between the adjustment foot and the projector.

# Adjusting the Lens

The image is focused and adjusted to the desired size using the focus ring or zoom ring on the projector.

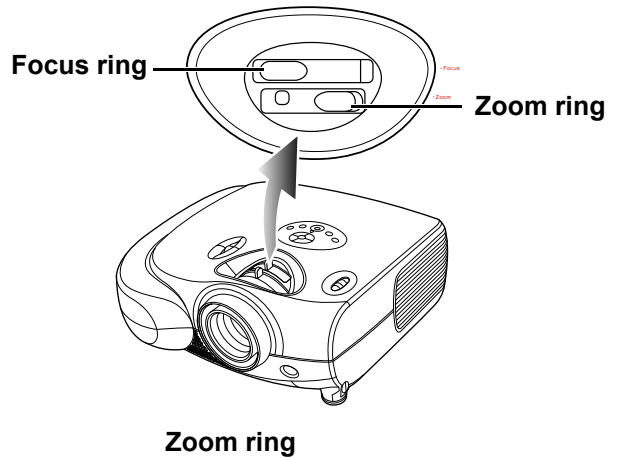

- 1 Zoom is adjusted by rotating the zoom ring.

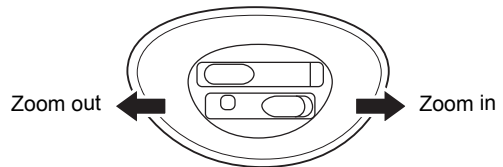

- 2 Focus is adjusted by moving the focus ring.

Focus ring

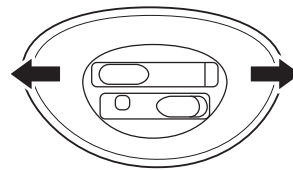

# Using the Lens Shift

The height and width of the projected image can be adjusted to be within the shift range of the lens by rotating the lens shift dial at the top of the projector.

## Note

- Do not forcibly turn the lens shift dial beyond the range of the upper left and lower right positions. This may cause the projector to malfunction.

Lens shift dial  
(Vertical)

Lens shift dial  
(Horizontal)

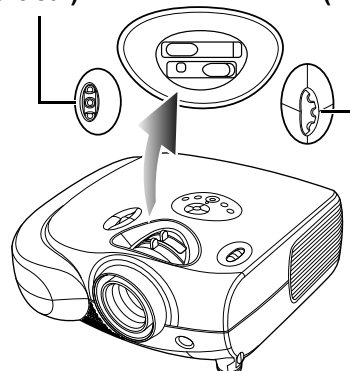

# Setting up the Screen

Position the projector perpendicular to the screen with all feet flat and level to achieve an optimal image.

## Note

- The projector lens should be centered in the middle of the screen. If the horizontal line passing through the lens center is not perpendicular to the screen, the image will be distorted, making viewing difficult.
- For an optimal image, position the screen so that it is not in direct sunlight or room light. Light falling directly on the screen washes out the colors, making viewing difficult. Close the curtains and dim the lights when setting up the screen in a sunny or bright room.
- A polarizing screen cannot be used with this projector.

## Standard Setup (Front Projection)

- Place the projector at the required distance from the screen according to the desired picture size. (See page 22)

## An Example of Standard Setup

### Side View

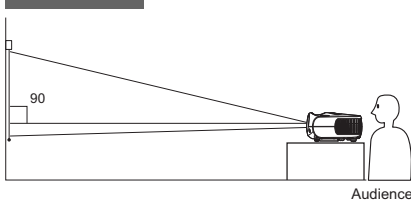

- The distance from the screen to the projector may vary depending on the size of the screen.
- The default setting can be used, when placing the projector in front of the screen. If the projected image is reversed or inverted, readjust the setting to "Front" for "PRJ Mode" in the "Options" menu.

### Top View

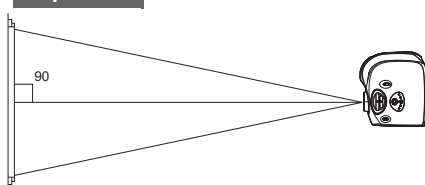

- Place the projector so that an imaginary horizontal line that passes through the center of the lens is perpendicular to the screen.

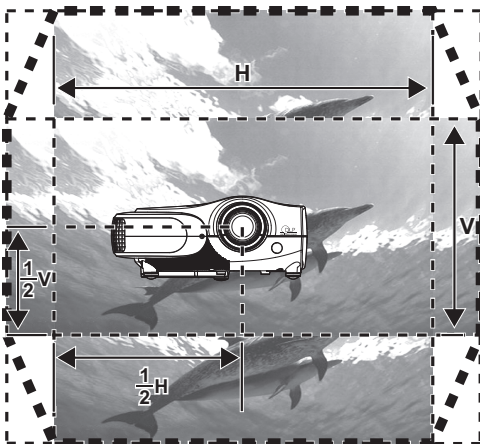

## Note

### 2D Lens Shift Ability:

- Short throw lens shift:
  - 1/2 of screen height: Up 100%, Down 60%
  - 1/2 of screen height: Left 15%, Right 15%
- Long throw lens shift:
  - 1/2 of screen height: Up 140%, Down 60%
  - 1/2 of screen height: Left 15%, Right 15%
- It is recommended that images be projected onto the dashed line octagonal area for fine image quality.
- There is a tolerance of 5% in the formula above.

# Screen Size and Projection Distance (Short throw lens)

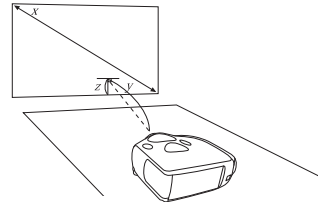

## When using a wide screen (16:9)

In case of displaying the 16:9 picture on the whole area of the 16:9 screen.

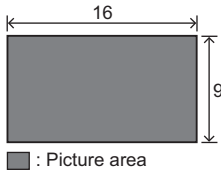

Wide Screen 16:9													
Screen Size						Throw Distance				Center of lens to edge of screen bottom			
Diagonal		Wide		High		Max		Min		Up		down	
in	cm	in	cm	in	cm	ft	m	ft	m	ft	cm	ft	cm
300.0	762.0	261.5	664.1	147.1	373.6	36.2	11.0	29.0	8.8	0.0	0.0	-9.8	-298.9
250.0	635.0	217.9	553.5	122.6	311.3	30.1	9.2	24.1	7.4	0.0	0.0	-8.2	-249.1
200.0	508.0	174.3	442.8	98.1	249.1	24.1	7.3	19.3	5.9	0.0	0.0	-6.5	-199.2
150.0	381.0	130.7	332.1	73.5	186.8	18.1	5.5	14.5	4.4	0.0	0.0	-4.9	-149.4
133.0	337.8	115.9	294.4	65.2	165.6	16.0	4.9	12.8	3.9	0.0	0.0	-4.3	-132.5
106.0	269.2	92.4	234.7	52.0	132.0	12.8	3.9	10.2	3.1	0.0	0.0	-3.5	-105.6
100.0	254.0	87.2	221.4	49.0	124.5	12.1	3.7	9.7	2.9	0.0	0.0	-3.3	-99.6
92.0	233.7	80.2	203.7	45.1	114.6	11.1	3.4	8.9	2.7	0.0	0.0	-3.0	-91.7
84.0	213.4	73.2	186.0	41.2	104.6	10.1	3.1	8.1	2.5	0.0	0.0	-2.7	-83.7
72.0	182.9	62.8	159.4	35.3	89.7	8.7	2.6	7.0	2.1	0.0	0.0	-2.4	-71.7
60.0	152.4	52.3	132.8	29.4	74.7	7.2	2.2	5.8	1.8	0.0	0.0	-2.0	-59.8
50.0	127.0	43.6	110.7	24.5	62.3	6.0	1.8	4.8	1.5	0.0	0.0	-1.6	-49.8

The formula for screen size and projection distance

$$Y1 (\text{Max.}) = 0.12057x$$

$$Y2 (\text{Min.}) = 0.09660x$$

$$Z1 (\text{Upper}) = 0.00000x$$

$$Z2 (\text{Lower}) = -0.03268x$$

x : Screen size (diag.)

y : Projection distance

z : Distance from the lens center to the lower edge of the image

### Note

- There is a tolerance of  $\pm 3\%$  in the formula above.
- Values with a minus (-) sign indicate the distance of the lens center below the bottom of the image.

## When using a normal screen (4:3)

In case of setting the 16:9 picture to the full horizontal width of the 4:3 screen.

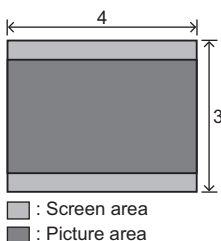

Standard Screen 4:3													
Screen Size						Throw Distance				Center of lens to edge of screen bottom			
Diagonal		Wide		High		Max		Min		Up		down	
in	cm	in	cm	in	cm	ft	m	ft	m	ft	cm	ft	cm
300.0	762.0	240.0	609.6	180.0	457.2	33.2	10.1	26.6	8.1	0.0	0.0	-12.0	-365.8
250.0	635.0	200.0	508.0	150.0	381.0	27.7	8.4	22.2	6.8	0.0	0.0	-10.0	-304.8
200.0	508.0	160.0	406.4	120.0	304.8	22.1	6.7	17.7	5.4	0.0	0.0	-8.0	-243.8
150.0	381.0	120.0	304.8	90.0	228.6	16.6	5.1	13.3	4.1	0.0	0.0	-6.0	-182.9
133.0	337.8	106.4	270.3	79.8	202.7	14.7	4.5	11.8	3.6	0.0	0.0	-5.3	-162.2
106.0	269.2	84.8	215.4	63.6	161.5	11.7	3.6	9.4	2.9	0.0	0.0	-4.2	-129.2
100.0	254.0	80.0	203.2	60.0	152.4	11.1	3.4	8.9	2.7	0.0	0.0	-4.0	-121.9
92.0	233.7	73.6	186.9	55.2	140.2	10.2	3.1	8.2	2.5	0.0	0.0	-3.7	-112.2
84.0	213.4	67.2	170.7	50.4	128.0	9.3	2.8	7.4	2.3	0.0	0.0	-3.4	-102.4
72.0	182.9	57.6	146.3	43.2	109.7	8.0	2.4	6.4	1.9	0.0	0.0	-2.9	-87.8
60.0	152.4	48.0	121.9	36.0	91.4	6.6	2.0	5.3	1.6	0.0	0.0	-2.4	-73.2
50.0	127.0	40.0	101.6	30.0	76.2	5.5	1.7	4.4	1.4	0.0	0.0	-2.0	-61.0

The formula for screen size and projection distance

$$Y1 (\text{Max.}) = 0.11067x$$

$$Y2 (\text{Min.}) = 0.08867x$$

$$Z1 (\text{Upper}) = 0.00000x$$

$$Z2 (\text{Lower}) = -0.03268x$$

x : Screen size (in)

y : Projection distance (ft)

z : Distance from the lens center to the lower edge of the image(in)

### Note

- There is a tolerance of  $\pm 3\%$  in the formula above.
- Values with a minus (-) sign indicate the distance of the lens center below the bottom of the image.

# Screen Size and Projection Distance (Long throw lens)

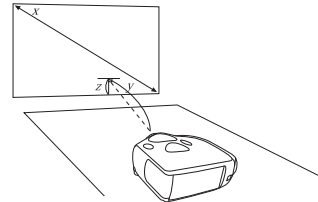

## When using a wide screen (16:9)

In case of displaying the 16:9 picture on the whole area of the 16:9 screen.

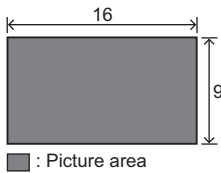

■ : Picture area

Wide Screen 16:9													
Screen Size						Throw Distance				Center of lens to edge of screen bottom			
Diagonal		Wide		High		Max		Min		Up		down	
in	cm	in	cm	in	cm	ft	m	ft	m	ft	cm	ft	cm
300.0	762.0	261.5	664.1	147.1	373.6	45.5	13.9	36.2	11.0	2.5	74.7	-9.8	-298.9
250.0	635.0	217.9	553.5	122.6	311.3	37.9	11.6	30.1	9.2	2.0	62.3	-8.2	-249.1
200.0	508.0	174.3	442.8	98.1	249.1	30.4	9.3	24.1	7.3	1.6	49.8	-6.5	-199.2
150.0	381.0	130.7	332.1	73.5	186.8	22.8	6.9	18.1	5.5	1.2	37.4	-4.9	-149.4
133.0	337.8	115.9	294.4	65.2	165.6	20.2	6.2	16.0	4.9	1.1	33.1	-4.3	-132.5
106.0	269.2	92.4	234.7	52.0	132.0	16.1	4.9	12.8	3.9	0.9	26.4	-3.5	-105.6
100.0	254.0	87.2	221.4	49.0	124.5	15.2	4.6	12.1	3.7	0.8	24.9	-3.3	-99.6
92.0	233.7	80.2	203.7	45.1	114.6	14.0	4.3	11.1	3.4	0.8	22.9	-3.0	-91.7
84.0	213.4	73.2	186.0	41.2	104.6	12.8	3.9	10.1	3.1	0.7	20.9	-2.7	-83.7
72.0	182.9	62.8	159.4	35.3	89.7	10.9	3.3	8.7	2.6	0.6	17.9	-2.4	-71.7
60.0	152.4	52.3	132.8	29.4	74.7	9.1	2.8	7.2	2.2	0.5	14.9	-2.0	-59.8
40.0	101.6	34.9	88.6	19.6	49.8	6.1	1.9	4.8	1.5	0.3	10.0	-1.3	-39.8

The formula for screen size and projection distance

$$Y1 \text{ (Max.)} = 0.15180x$$

$$Y2 \text{ (Min.)} = 0.12057x$$

$$Z1 \text{ (Upper)} = 0.00817x$$

$$Z2 \text{ (Lower)} = -0.03268x$$

x : Screen size (in)

y : Projection distance (ft)

z : Distance from the lens center to the lower edge of the image (in)

### Note

- There is a tolerance of  $\pm 3\%$  in the formula above.
- Values with a minus (-) sign indicate the distance of the lens center below the bottom of the image.

## When using a normal screen (4:3)

In case of setting the 16:9 picture to the full horizontal width of the 4:3 screen.

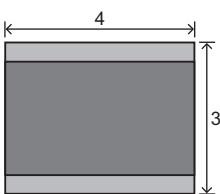

■ : Screen area

■ : Picture area

Standard Screen 4:3													
Screen Size						Throw Distance				Center of lens to edge of screen bottom			
Diagonal		Wide		High		Max		Min		Up		down	
in	cm	in	cm	in	cm	ft	m	ft	m	ft	cm	ft	cm
300.0	762.0	240.0	609.6	180.0	457.2	41.8	12.7	33.2	10.1	3.0	91.4	-12.0	-365.8
250.0	635.0	200.0	508.0	150.0	381.0	34.8	10.6	27.7	8.4	2.5	76.2	-10.0	-304.8
200.0	508.0	160.0	406.4	120.0	304.8	27.9	8.5	22.1	6.7	2.0	61.0	-8.0	-243.8
150.0	381.0	120.0	304.8	90.0	228.6	20.9	6.4	16.6	5.1	1.5	45.7	-6.0	-182.9
133.0	337.8	106.4	270.3	79.8	202.7	18.5	5.6	14.7	4.5	1.3	40.5	-5.3	-162.2
106.0	269.2	84.8	215.4	63.6	161.5	14.8	4.5	11.7	3.6	1.1	32.3	-4.2	-129.2
100.0	254.0	80.0	203.2	60.0	152.4	13.9	4.2	11.1	3.4	1.0	30.5	-4.0	-121.9
92.0	233.7	73.6	186.9	55.2	140.2	12.8	3.9	10.2	3.1	0.9	28.0	-3.7	-112.2
84.0	213.4	67.2	170.7	50.4	128.0	11.7	3.6	9.3	2.8	0.8	25.6	-3.4	-102.4
72.0	182.9	57.6	146.3	43.2	109.7	10.0	3.1	8.0	2.4	0.7	21.9	-2.9	-87.8
60.0	152.4	48.0	121.9	36.0	91.4	8.4	2.5	6.6	2.0	0.6	18.3	-2.4	-73.2
40.0	101.6	32.0	81.3	24.0	61.0	5.6	1.7	4.4	1.3	0.4	12.2	-1.6	-48.8

The formula for screen size and projection distance

$$Y1 \text{ (Max.)} = 0.13933x$$

$$Y2 \text{ (Min.)} = 0.11067x$$

$$Z1 \text{ (Upper)} = 0.00817x$$

$$Z2 \text{ (Lower)} = -0.03268x$$

x : Screen size (in)

y : Projection distance (ft)

z : Distance from the lens center to the lower edge of the image (in)

### Note

- There is a tolerance of  $\pm 3\%$  in the formula above.
- Values with a minus (-) sign indicate the distance of the lens center below the bottom of the image.



## Projection from behind the screen

### Projecting a Reversed/Inverted Image

- Place a translucent screen between the projector and the audience.
- Reverse the image by setting “Rear” for “PRJ Mode” in the “Options” menu.

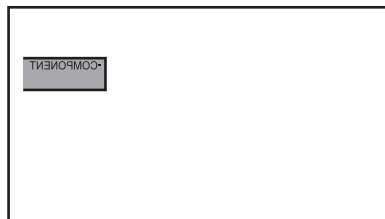
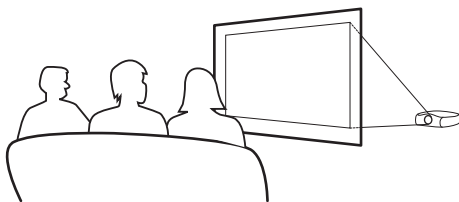

The image is reversed.

### Projection using a mirror

- Place a mirror (normal flat type) in front of the lens.
- Reverse the image by setting “Rear” for “PRJ Mode” in the “Options” menu, when the mirror is placed on the side where the audience is.

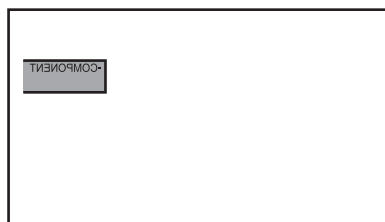
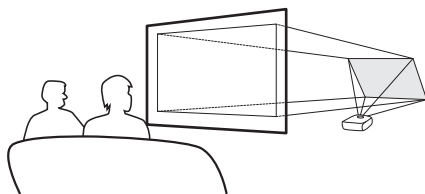

The image is reversed.

#### Info

- When using a mirror, be sure to carefully position both the projector and the mirror so that the light does not shine into the eyes of the audience.

### Ceiling-mount setup

- It is recommended that you use the optional ceiling-mount bracket for this installation.
- Before mounting the projector, contact your nearest Authorized Service Center or Dealer to obtain the recommended ceiling-mount bracket (sold separately).
- Be sure to adjust the position of the projector to match the distance (Z) from the lens center position to the lower edge of the image, when mounting the projector on the ceiling.
- Invert the image by setting “Ceiling + Front” for “PRJ Mode” in the “Options” menu.

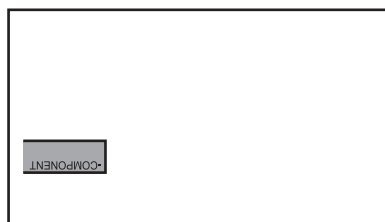

The image is reversed.

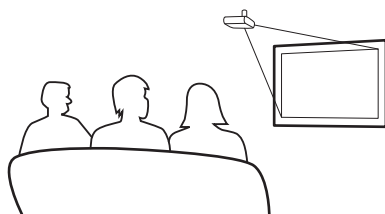

# Basic Operation

# Image Projection

## Basic Procedure

Connect the required external equipment to the projector before operating the following procedures.

### Info

- The language preset at the factory is English. If you want to change the on-screen display to another language, reset the language according to the procedure on page 28.

### 1 Plug the power cord into the wall outlet.

- The power indicator illuminates blue, and the projector enters standby mode.

### 2 Press on the remote control or on the projector.

- The power indicator turns off.

### Note

- The power indicator illuminates, indicating the status of the lamp.  
**Blue:** The power is ready.  
**Blue blinking:** The fan is cooling.

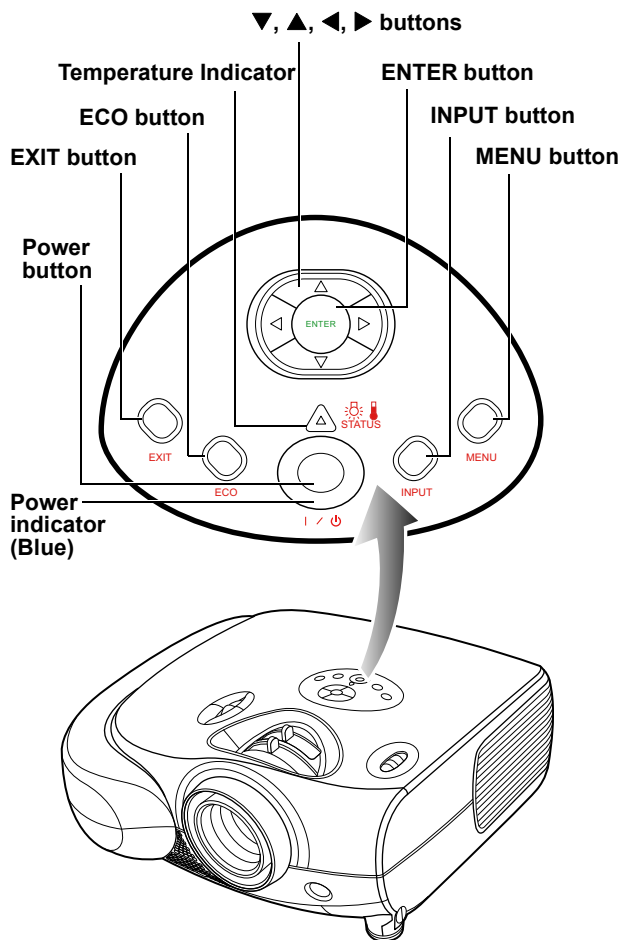

**3** Press  on the projector to select the INPUT mode.

 **Note**

- When a signal is not received, "Searching for Source" will be displayed.



**About the INPUT modes**

INPUT 1	Selects the source Component RCA / SCART.
INPUT 2	Selects the source HDMI 1 or 2.
INPUT 3	Selects the source Video or S-Video.
INPUT 4	Selects the source PC.

 **Note**

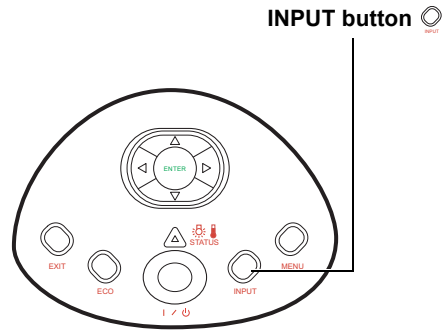
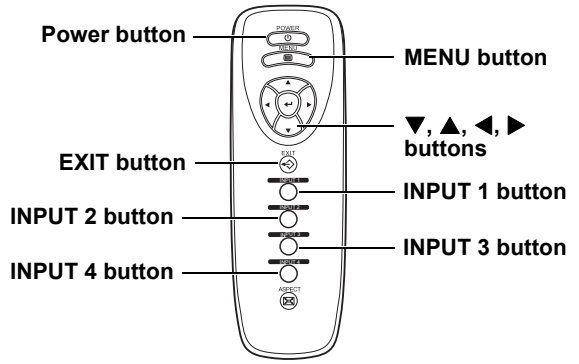
- If you select "Auto" as the input source, then the correct input source is selected automatically.



**4** Press  on the remote control or  on the projector, then press  Enter to turn off the projector, when the confirmation message is displayed.



 **Note**

- If you accidentally press power  and do not want to turn off the projector, press Exit button or select Cancel to turn off the confirmation message.

 **Info**

- Do not unplug the power cord during projection or cooling fan operation. This can cause damage due to the rise in internal temperature, as the cooling fan also stops.

## Selecting the On-screen Display Language

- The on-screen display language of the projector can be set to English, Francis, Italiano, Deutsch, Spanish, 中文, 日本語, 한국어.

### 1 Press "MENU".

- The menu will be displayed.



### 2 Press ← or → to select "Language".

### 3 Press ▲ or ▼ to select desired language, and then press ←.

The desired language will be set as the on-screen display.

### 4 Press "EXIT".



# Menu Bar Items

This list shows the items that can be set in the projector.

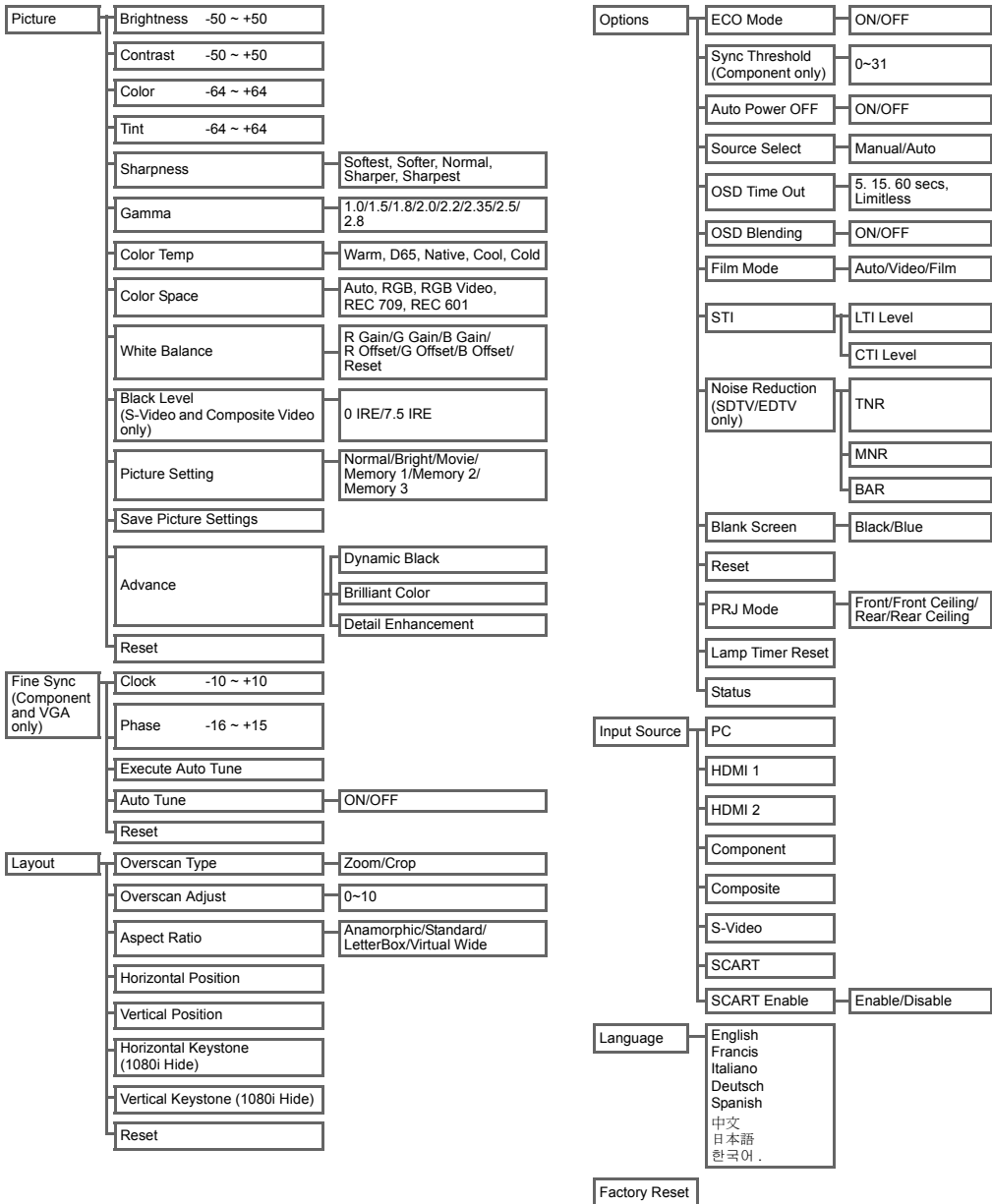

# Using the Menu Screen

This projector has one set of menu screens that allow you to adjust the image and various projector settings. You can operate the menus from the projector or remote control using the following procedure.



## Menu Selections (Adjustments)





- 1 Press  on remote or  on keypad.

- The menu screen is displayed.

### Note

- The "Picture" menu screen for the selected input mode is displayed.

- 2 Press  or  to select the menu you want to adjust.

- 3 Press  or  to reach the Sub-menu and then press  or  to select the item you want to adjust.

### Note

- The selected item will be highlighted.

- 4 Press  or  to adjust the item selected.

- The adjustment is stored.

- 5 Press  to return to "Main MENU".

- 6 Press , the menu screen will disappear.

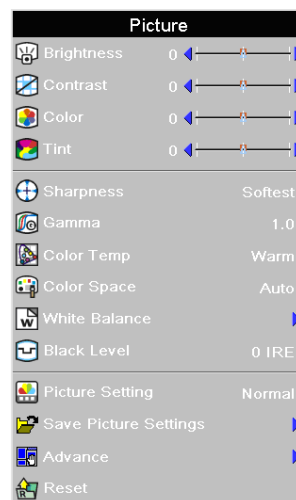
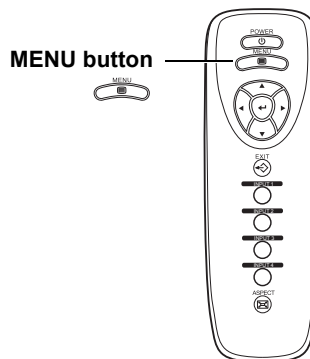
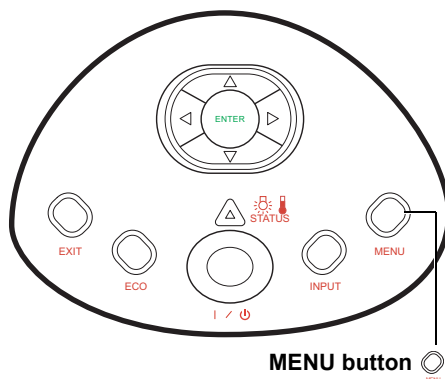

# Adjusting the Picture

You can adjust the projector's picture to your preferences with the following picture settings.

## Adjusting Image Preferences

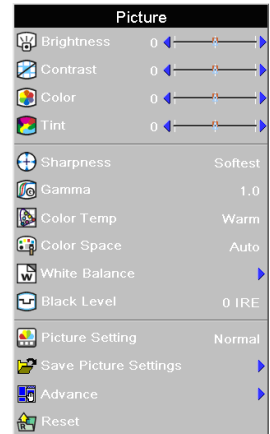

Selected item	Description		
Brightness	For adjusting the brightness of an image	For lower brightness	For higher brightness
Contrast	For adjusting the contrast level	For lower contrast	For higher contrast
Color	For adjusting the color intensity of an image	For lower color intensity	For higher color intensity
Tint	For adjusting the tones of an image	Skin tones become purplish	Skin tones become greenish

### Brightness

Use this option to adjust the overall brightness of the image. Use this control in conjunction with contrast to fine-tune the display. The scale is from -50 to 50.



### Contrast

Use this option to adjust the contrast of the image. Use this control in conjunction with contrast to fine-tune the display. The scale is from -50 to 50.



### Color

Use this option to adjust the color intensity of the image.





## Tint

Use this option to adjust the tint of your image. Press ► to make the image more green. Press ◀ to make the image more purple.



## Sharpness

Use this option to adjust the clarity and focus of the image.



## Gamma

Use this option to adjust the gamma correction of the image. Default setting is 2.2. Gamma correction provides eight sets of gamma corrections 1.0, 1.5, 1.8, 2.0, 2.2, 2.35, 2.5, and 2.8.



## Color Temp

Use this option to set the color temperature of the image. There are five settings in the Color Temperature. They are Warm, D65, Native, Cool, and Cold. The Cold color temperature makes the image look colder with bluish hue, and the Warm color Temperature makes the image look warmer with reddish hue. When sets to "Native", the image has the maximum brightness.



## Color Space

Use this option to determine how the color components of an input signal are decoded for accurate color on the display. In most situations, the Auto setting produces the most accurate colors. If it does not, try the other settings and select the one that does.



## White Balance

To remove any trace of color from the white areas of the projected image, choose White Balance from the Picture menu and press ENTER.

**Gain:** Use the Gain controls to correct color imbalances in the bright areas of the image.

**Offset:** Use the Offset controls in the White Balance sub-menu to correct color imbalance in the dark areas of the image.

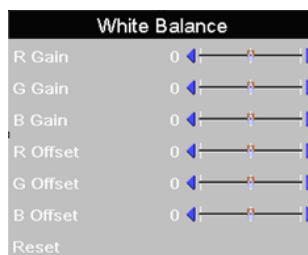

## Black Level

This control compensates for incoming elevated black levels present in certain video signals. For some types of video, you may want to override the setting. Set it to 0 IRE if blacks appear elevated (dark gray). If blacks appear “crushed” (too dark), set it to 7.5 IRE.



## Picture Setting

This function stores Brightness, Contrast, Color, Tint, Sharpness, Gamma, Color Temperature, Color Space, Brilliant Color, and Black Level set in “Picture”. Each stored setting is reassigned to each input and resolution mode.



Select “Picture Setting” from the “Picture” menu on the menu screen.  
→For operating the menu screen, see page 30.

### Note

- **When Recalling Saved Contents:**  
When a saved memory number is selected, the contents of the “Picture” menu change to the adjustment values of the saved memory number.
- **When Editing Saved Contents:**  
Edit the contents of the “Picture” menu after selecting the Memory number for which adjustment values are to be edited.
- The default three modes Normal/Bright/Movie cannot be saved in the memory.

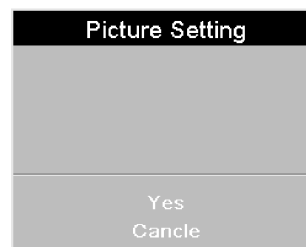

## Save Picture Settings

Use this option to save changes you made in “Picture setting” to Memory 1, Memory 2, or Memory 3.



## Advance

Select this menu to access Dynamic Black, Brilliant Color and Detail Enhancement functions.

<p><b>Dynamic Black:</b> This function utilizes the contrast of colors to enable black colors to appear blacker on screen while significantly enhancing the performance of black scenes.</p> <ul style="list-style-type: none"> <li>To enable the function, set it to "ON".</li> </ul>	 <p>The screenshot shows the 'Advance' menu with three options: 'Dynamic Black' (selected with a blue bar and a radio button), 'Brilliant Color' (radio button), and 'Detail Enhancement' (radio button, labeled 'Off').</p>
<p><b>Brilliant Color:</b> This function utilizes a new color-processing algorithm and system level enhancements to enable higher brightness while providing truer and more vibrant colors in picture.</p> <ul style="list-style-type: none"> <li>To enable the function, set it to "ON".</li> </ul>	 <p>The screenshot shows the 'Advance' menu with three options: 'Dynamic Black' (radio button), 'Brilliant Color' (selected with a blue bar and a radio button), and 'Detail Enhancement' (radio button, labeled 'Off').</p>
<p><b>Detail Enhancement:</b> This function sharpens the details of the picture.</p> <p>The following options are available: Off, Low, Middle, High.</p>	 <p>The screenshot shows the 'Advance' menu with three options: 'Dynamic Black' (radio button), 'Brilliant Color' (radio button), and 'Detail Enhancement' (selected with a blue bar and a radio button, labeled 'Off').</p>

## Reset

Select this option to set to all items in the "Picture" menu to the factory default values.



# Adjusting Computer Images

## (Component / PC only)

Use the Fine Sync function in case of irregularities such as vertical stripes or flickering in portions of the screen.

Select “Clock”, “Phase”, “Execute Auto Tune”, and “Auto Tune” in the “Fine Sync” menu on the menu screen.

→For operating the menu screen, see page 30.

Selected item	Description
Clock	Adjusts vertical noise.
Phase	Adjusts horizontal noise (similar to tracking on your VCR).
Execute Auto Tune (PC only)	To run auto tune.
Auto Tune (PC only)	Automatically adjusts a computer image. Select “Execute Auto Tune”.

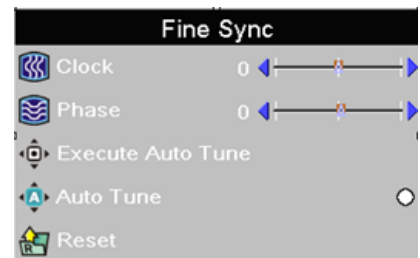

### Note



- Auto Tune may take some time to complete, depending on the image stored in the computer connected to the projector.

# Easy to Use Functions

# Selecting the Picture Display Mode

This function allows you to modify or customize the picture display mode to enhance the input image. Depending on the input signal, you can choose “Anamorphic”, “Standard”, “LetterBox”, or “Virtual Wide”.

## Switching the Picture Display Using Different input signals

Press  on remote or  on keypad and select layout.

- Each time  is pressed, the display changes as shown on page 38 and 39.

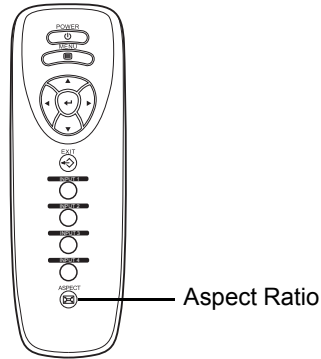

## Aspect Ratio Function

The layout menu enables you to control how the projector resizes the input image.

The following options are available:

### Anamorphic

- Resolution 1920x1080
- 4:3 input is stretched to fit 16:9 display
- Stretches entire image.

### Standard

- Resolution depends on the Input Signal
- 4:3 input scaled to fit display height
- Width scaled to maintain 4:3 aspect ratio
- Black bars on left and right (taking up 25% of the whole display)

### LetterBox

- Resolution 1920x1080
- 4:3 input scaled to fit display width
- Height scaled to maintain 4:3 aspect ratio: 1440x1080
- 25% of the entire image on the top and bottom is cropped.



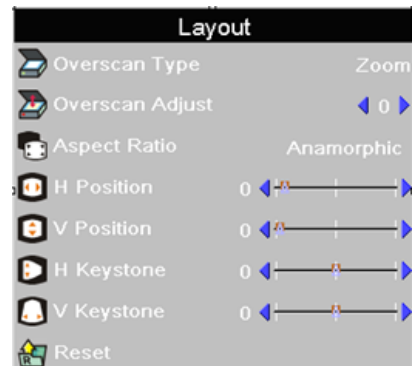

### Virtual Wide

- Resolution 1920x1080
- 4:3 input is stretched to fit 16:9 display
- With 4:3 input, the central ratio remains true to scale, but the image is stretched to fit display width.
- 16:9 input image is identical to the one displayed in Anamorphic mode.

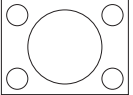
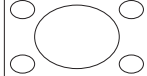

# VIDEO

		Anamorphic	Standard	LetterBox	Virtual Wide
For 4:3 aspect ratio	480i 480p 576i 576p NTSC PAL SECAM	1920x1080	1440x1080	1920x1080	1920x1080
For 16:9 aspect ratio	480p 576p	1920x1080	1440x1080	1920x1080	1920x1080
	720p	1920x1080	1440x1080	1920x1080	1920x1080
	1080i/p	1920x1080	1440x1080	1920x1080	1920x1080

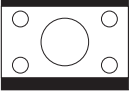
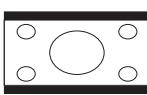
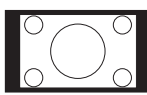
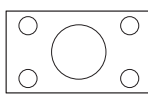
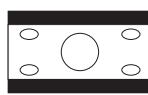
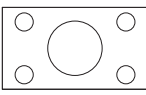
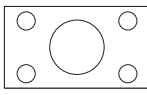
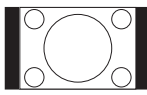
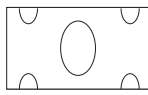
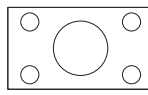
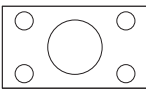
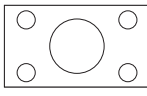
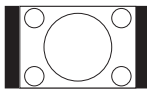
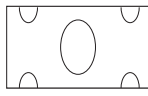
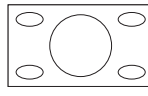
	Input Signal	Output screen image			
		Anamorphic	Standard	LetterBox	Virtual Wide
480i 480p 576i 576p NTSC PAL SECAM	 For 4:3 aspect ratio				
	 LetterBox image				
1080i/p	 For 16:9 aspect ratio				
720p					

# COMPUTER

		Anamorphic	Standard	LetterBox	Virtual Wide
For 4:3 aspect ratio	VGA(640X480)	1920X1080	1440X1080	N.A.	1920X1080
	SVGA(800X600)	1920X1080	1440X1080	N.A.	1920X1080
	XGA(1024X768)	1920X1080	1440X1080	N.A.	1920X1080
	SXGA(1280X1024)	1920X1080	1440X1080	N.A.	1920X1080
	UXGA(1600X1200)	1920X1080	1440X1080	N.A.	1920X1080

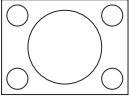
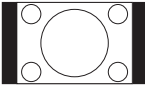
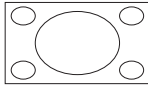
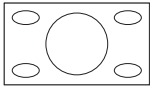
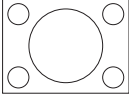
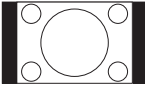
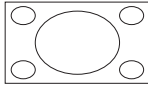
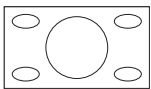
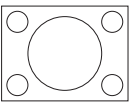
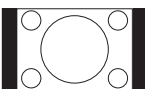
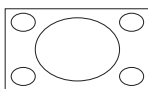
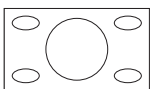
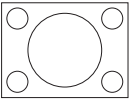
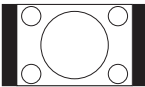
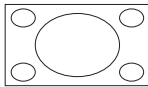
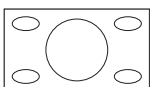
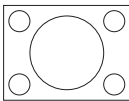
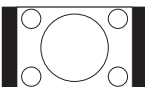
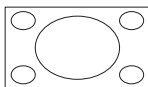
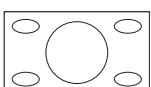
	Input Signal	Output screen image			
		Standard	Anamorphic	Letter Box	Virtual Wide
VGA	 For 4:3 aspect ratio (640x480)			N.A.	
SVGA	 For 4:3 aspect ratio (800x600)			N.A.	
XGA	 For 4:3 aspect ratio (1024x768)			N.A.	
SXGA	 For 5:4 aspect ratio (1280x1024)			N.A.	
UXGA	 For 4:3 aspect ratio (1600x1200)			N.A.	



## Overscan Type

This function enables you to remove some edges of the image.

Select “Overscan Type” from the “Layout” menu on the menu screen.

→For operating the menu screen, see page 30.

The following options are available:

Selected item	Description
Zoom	Scales or zooms the image.
Crop	Cuts a portion of the image.

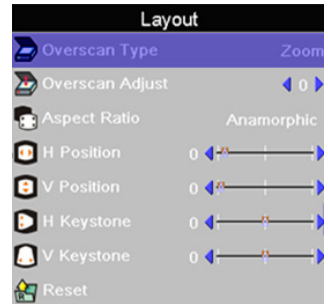

## Overscan Adjust

This function enables you to adjust the image display on screen. Available options are from 0-10. The default value is 1 which is suitable for S-Video/Composite and Component input sources.

Select “Overscan Type” from the “Layout” menu on the menu screen.

→For operating the menu screen, see page 30.

- Press “◀” or “▶” to select value.

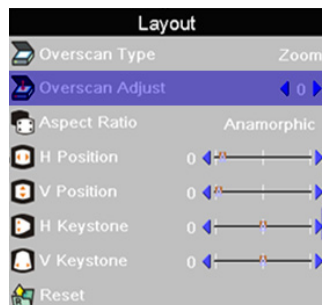

# H-V Position Function

This function enables you to center the display vertically and horizontally.

- 1 Press “◀” or “▶” of the Horizontal Position, the display will move to the left or the right.

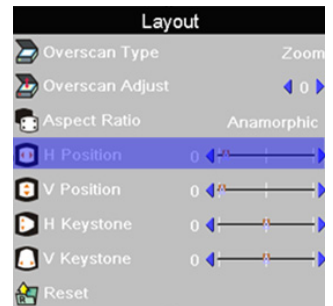

- 2 Press “◀” or “▶” of the Vertical Position, the display will move upward or downward.

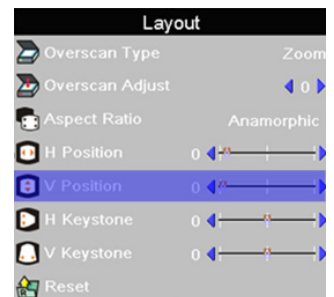

# H-V Keystone Function

## Correcting Trapezoidal Distortion and Adjusting Vertical Size of the picture.

This function allows for Keystone correction.

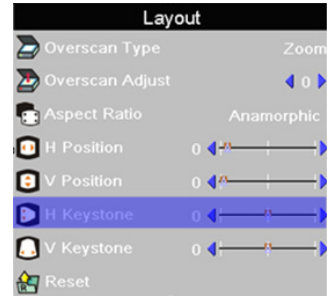

### Note

- When the image is projected either from top or from bottom toward the screen at an angle, the image becomes distorted trapezoidally. The function for correcting trapezoidal distortion is called Keystone Correction.
- The Keystone Correction can be adjusted.

(On-screen Trapezoidal Distortion)

Correction and the adjustment of the vertical size of the picture.

## 1 Select "Vertical Keystone" or "Horizontal Keystone" in the layout.

Selected item	Description
Horizontal Keystone	Horizontally adjusts the keystone settings.
Vertical Keystone	Vertically adjusts the keystone settings.

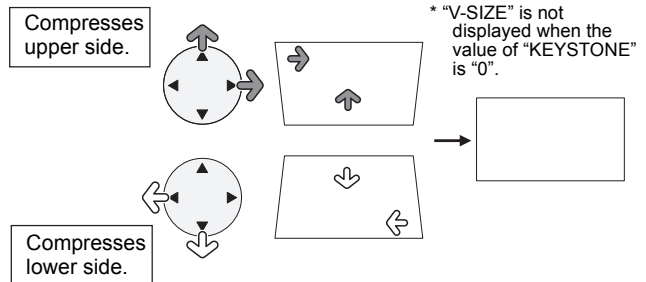

## 2 Press "◀" or "▶" to adjust the keystone correction.

### Note

- Since the trapezoidal distortion of the image can be corrected up to various angles, the actual screen can be diagonally set up to that angle as well.
- Straight lines or the edges of images may appear jagged while adjusting the image.

### Horizontal Keystone Correction

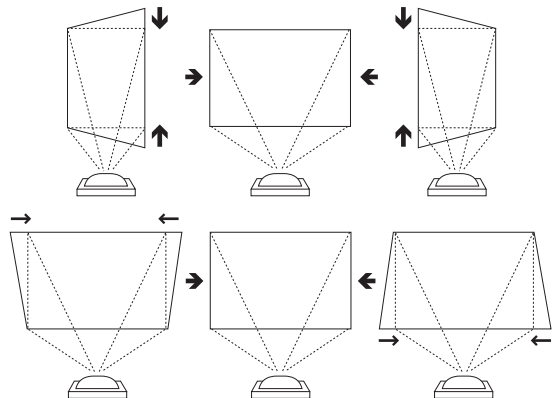

### Vertical Keystone Correction

# Selecting the Economy Mode

These functions allow you to reduce the power consumption of the projector.

## Setting the Power Save

Select "ON" from the "Economy Mode" under the "Options" menu on the menu screen.

→For operating the menu screen, see page 30.

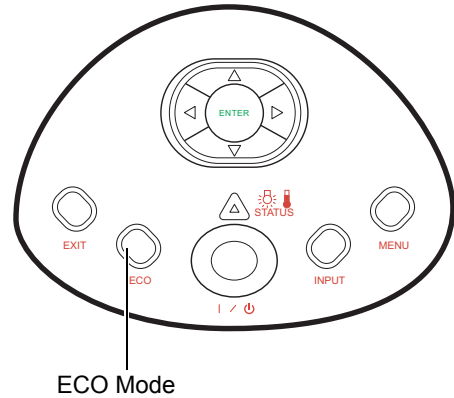

### Note

- Although noise is reduced when "ECO" is set to "ON", brightness decreases by 20%.
- "ECO" mode is factory preset to "ON".

Status	Brightness	Power consumption
ON (Low power mode)	80%	325W@110V
OFF (Standard mode)	100%	365W@110V

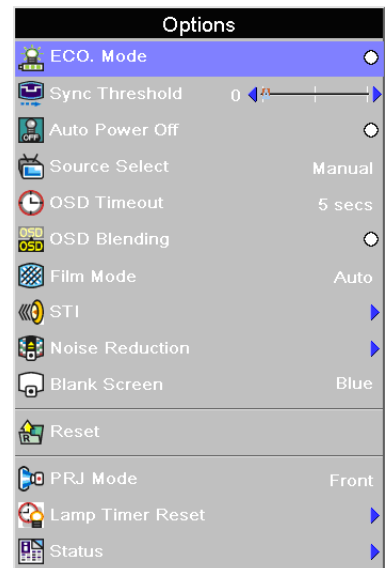

# Sync Threshold

This function is only available on Component input.

The projector is compatible with EDTV(480p and 576p) and HDTV(720p, 1080i and 1080p) video signals. If a hardware device, such as a DVD player, is not syncing properly with the projector, adjust this option to help it to sync when connected to the projector.

Select **“Sync Threshold”** from the **“Options”** menu on the menu screen.  
→For operating the menu screen, see page 30.



# Automatic Power Off Function

When an input signal is not detected or you don't press any input button on Keypad or remote for more than 15 minutes, the projector will automatically turn off if set to **“ON”**.

Auto Power OFF function will be disabled when it is set to **“OFF”**.

Select **“Auto Power OFF”** from the **“Options”** menu on the menu screen.  
→For operating the menu screen, see page 30.

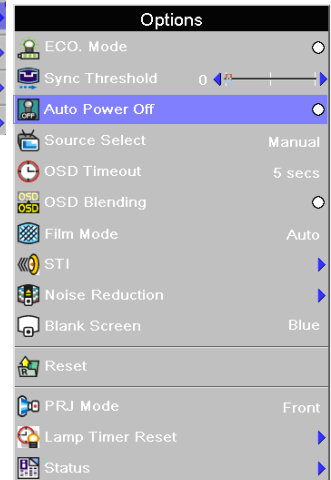

## Note

- When the Auto Power OFF function is set to **“ON”**, 5 minutes before the power turns off, the message **“Power OFF in 5 min.”** will appear on the screen to indicate the remaining minutes.

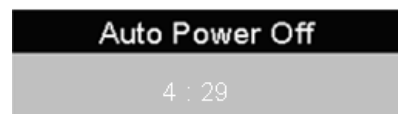

# Source Select

Used to select the input source automatically when there is no signal in the current input.

Source Select	Auto Manual
---------------	----------------

→Select “source select” from the “Options” menu on the menu screen. For operating the menu screen, see page 30.

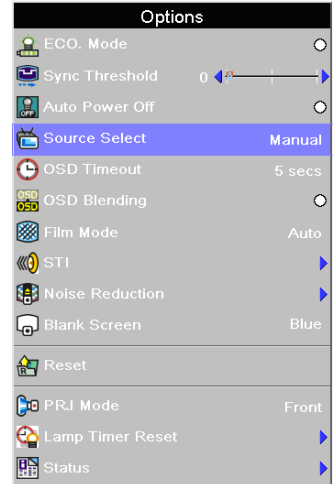

# OSD Time Out

OSD Time Out is used to set how long the OSD will stay open if no buttons are pressed.

OSD Time Out	5 15 60 Limitless
--------------	----------------------------

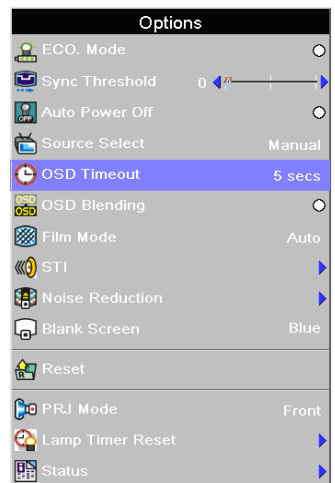

# OSD Blending

When this function is enabled, the OSD is transparently displayed on the screen to blend with the image.

Select “ON” from the “OSD Blending” under the “Options” menu on the menu screen.

→For operating the menu screen, see page 30.

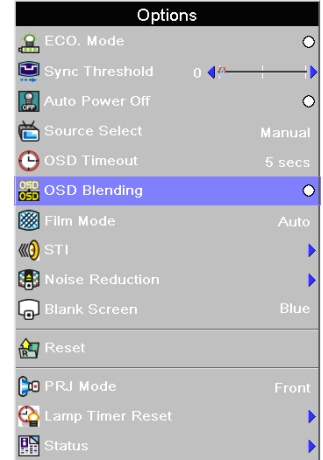

# Film Mode

This function allows you to determine the type of incoming video content-film. Different algorithms are applied for each of the content types.

Select “Film Mode” from the “Options” menu on the menu screen.

→For operating the menu screen, see page 30.

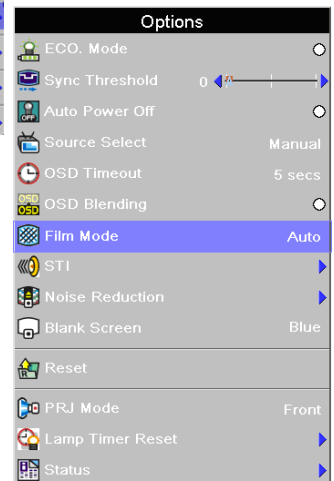

Film Mode	Reproduces the image of the film source clearly. Displays the optimized image of film transformed with 3:2 pull down (NTSC and PAL60Hz) or 2:2 pull down (PAL 50Hz and SECAM) enhancement to progressive mode images.
-----------	---

## Note

- In PAL50Hz or SECAM, the 2:2 pull down enhancement will be enabled only in film mode, after the film source has been entered.

# STI

This function allows you to set the LTI and CTI level.

Selected Item	Description
LTI (Luminance Transient Image)	Adjusts the LTI level to enhance luminance, filter fuzzy edges and remove smear.
CTI (Colour Transient Image)	Adjusts the CTI level to enhance colour, filter fuzzy edges, and remove smear.



Select "STI" from the "Options" menu on the menu screen.

→For operating the menu screen, see page 30.

STI	
LTI	Low
CTI	Low



# Noise Reduction

This function is only available for SDTV (480i/576i) and EDTV (480p/576p) signals.

Noise Reduction is useful for clearing up noisy images. Turn it On to keep in mind that reducing noise (which reduces high frequencies) may also “soften” the image.

Select “Noise Reduction” from the “Options” menu on the menu screen.  
→For operating the menu screen, see page 30.

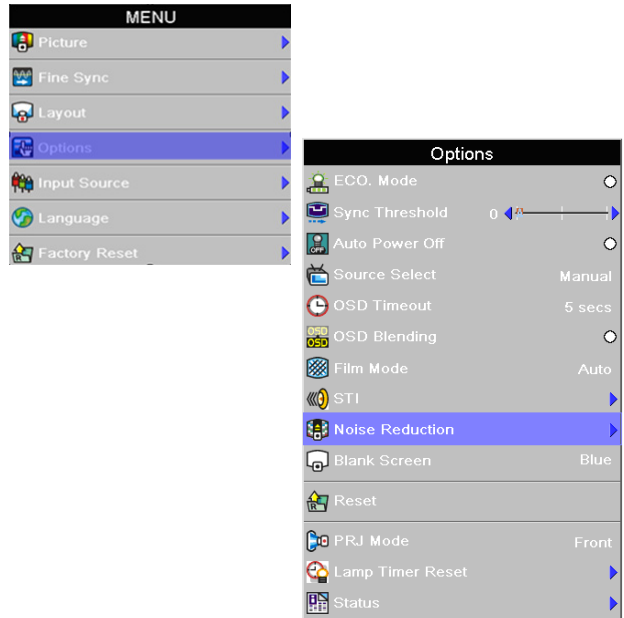

# Blank Screen

This function is used to apply the background color when there is no input source.

Select “Blank Screen” from the “Options” menu on the menu screen.  
→For operating the menu screen, see page 30.

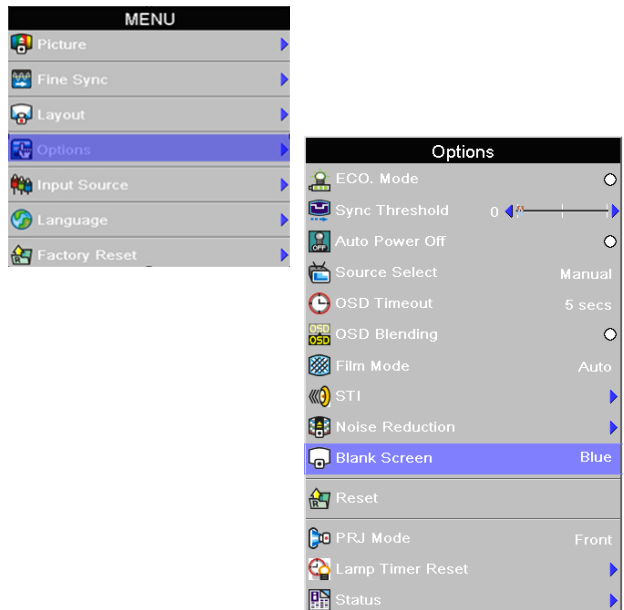

# Reset

Select this option to set all items in the “Options” menu to the factory default values except PRJ Mode and Lamp Reset.

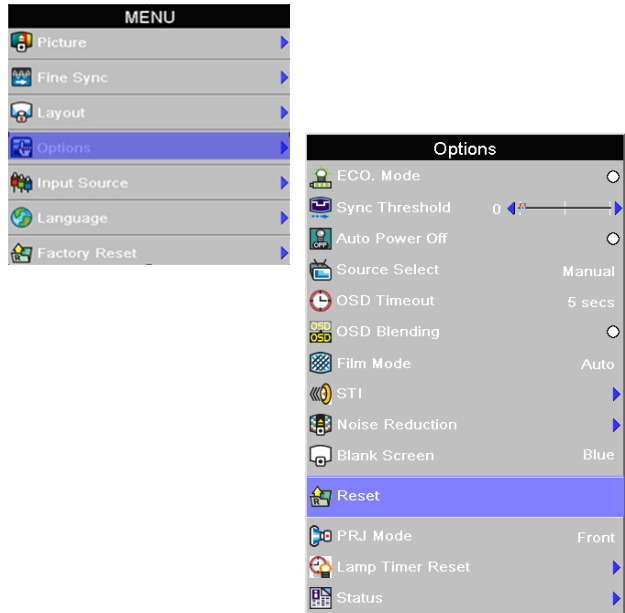

# Reversing/Inverting Projected Images

This projector is equipped with a reverse/invert image function that allows you to reverse or invert the projected image for various applications.

## Setting the PRJ Mode

Select “PRJ Mode” from the “Options” menu on the menu screen.

→For operating the menu screen, see page 30.

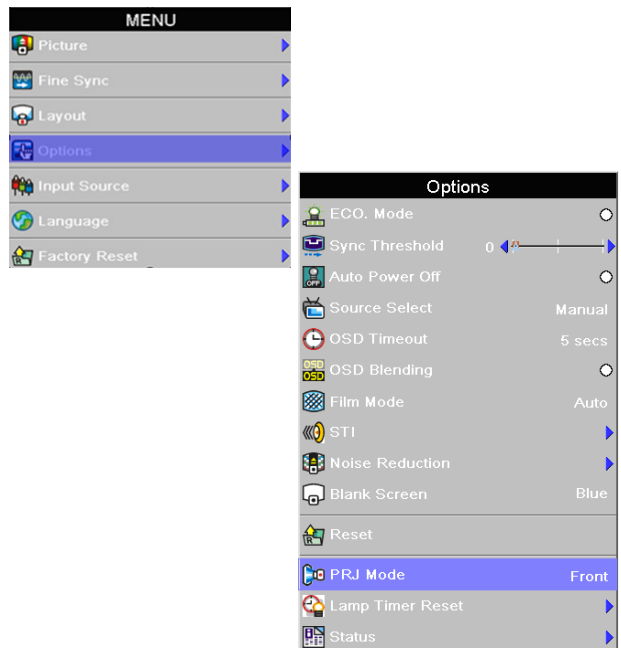

Selected item	Description
Front	Normal image
Front + Ceiling	Inverted image
Rear	Reversed image
Rear + Ceiling	Reversed and inverted image

### Note

- This function is used for the reversed image and ceiling-mount setups.

# Lamp Timer Reset

Lamp Timer Reset is used to reset the lamp counter. You should reset the Timer after you install a new lamp. The cumulative lamp usage time is shown in the Status Screen.

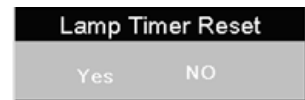

# Status

The Status screen displays information about the current input signal, Lamp Timer, and Firmware Information.



Status	
Input Source	HDMI1
Resolution	1920X1080
Horz Freq	67.4KHz
Vert Freq	60.0Hz
Lamp Timer	9 H
F/W Information	0.001.080908

# Input Source

In the Main menu, press the ▲ or ▼ button to select Input Source, and press the Enter button to confirm.



## Note

- If you select “Auto” as the Input source, then the correct input source is automatically selected.

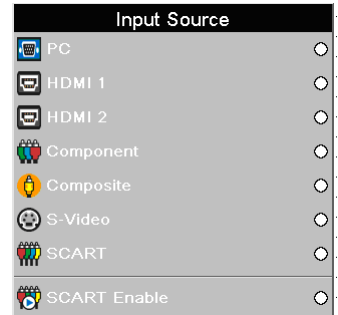

# Factory Reset

This process will set all the items to Factory default settings except PRJ Mode and Lamp Reset.



## Note

- If you accidentally press enter and do not want to perform the factory reset function, press Exit button or select No to turn off the confirmation message.

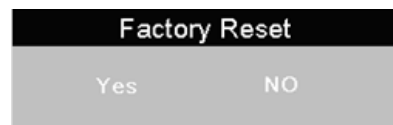

# Appendix

# Maintenance

## Cleaning the projector

- Unplug the power cord before cleaning the projector.
- Avoid using benzene or thinner, as these can damage the finish on the cabinet and operation panel.
- Do not use volatile agents such as insecticides on the projector.
- Do not leave rubber or plastic objects in contact with the projector for long periods as they may damage the finish of the projector.

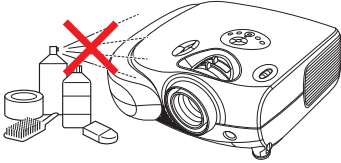

- Wipe off dirt gently with a soft flannel cloth.
- For hard-to-remove dirt, soak a cloth in a neutral detergent diluted with water, wring the cloth well and then wipe the projector.  
Strong cleaning detergents may discolor, warp or damage the coating on the projector. Make sure to test on a small, inconspicuous area on the projector before using.

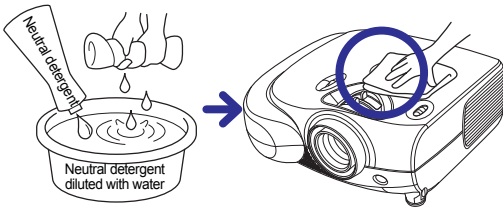

## Cleaning the lens

- Use a commercially available blower or lens cleaning paper (for glasses and camera lenses) for cleaning the lens. Do not use any liquid cleaning agents, as they may wear off the coating film on the surface of the lens.

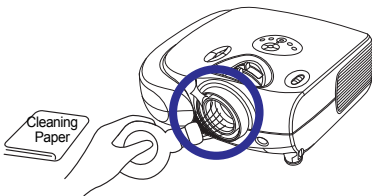

- The surface of the lens is easily damaged, do not to scrape or hit the lens.

## Cleaning the exhaust and intake vents

- Use a vacuum cleaner to clean dust from the exhaust vent and the intake vent.

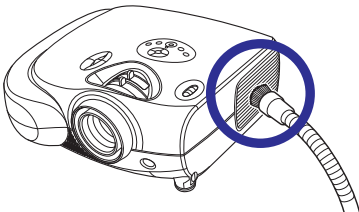

# Cleaning the Ventilative Holes

- This projector is equipped with ventilative holes to ensure the optimal operating condition of the projector.
- Periodically clean the ventilative hole by vacuuming it off with a vacuum cleaner.
- The ventilative holes should be cleaned every 100 hours of use. Clean the ventilative holes more often when the projector is used in a dirty or smoky location.

Side and Rear view

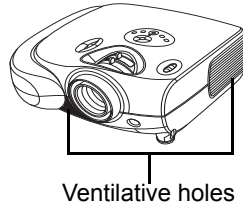

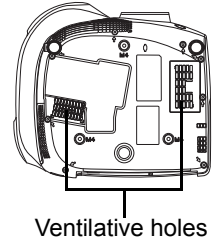

Bottom view



## Cleaning the Ventilative Holes

### 1 Turn off the power and disconnect the power cord.

Press  on the projector or  on the remote control to turn off the power. Wait until the cooling fan stops.

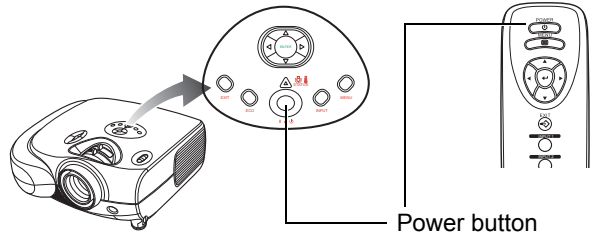

### 2 Unplug the Power Cord.

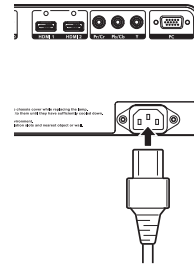

### 3 Clean the dust off by placing the cleaner hose on the intake and exhaust ventilative holes.

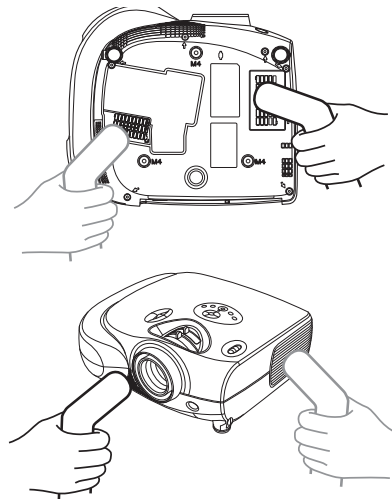

# About the Lamp

The projector lamp has a life of 2000 hours. Maintain proper ventilation to keep the lamp operating throughout its lifetime. Do not subject the projector to unnecessary vibration to ensure that the lamp does not break.

- It is recommended that the lamp (sold separately) be replaced after approximately 2,000 cumulative hours of use or when you notice a significant deterioration in the picture and color quality. The number of hours the lamp has been used can be checked with "Lamp Timer" in the "Options" menu on the menu screen.
- For lamp replacement, please consult your nearest Authorized Service Center or Dealer.
- The actual lamp service life may be less than 2000 hours depending on the environment in which the projector is used.

## Caution Concerning the Lamp

- This projector uses a pressurized mercury lamp. A loud sound may indicate lamp failure. Lamp failure is caused by excessive shock, improper cooling, surface scratches or deterioration of the lamp due to usage. The period of time up to failure largely varies depending on the individual lamp and/or the condition and the frequency of use. It is important to note that failure can often result in the bulb cracking.
- When the lamp replacement indicator and on-screen display icon are illuminated or are flashing, it is recommended that the lamp be replaced with a new one immediately, even if the lamp appears to be operating normally.
- If the lamp breaks glass particles may spread inside the lamp cage or gas contained in the lamp may be vented into the room from the exhaust vent. As the gas in this lamp contains mercury, ventilate the room well if the lamp breaks and avoid all exposure to the released gas. In case of exposure to the gas, consult with a doctor as soon as possible.
- If the lamp breaks, there is also a possibility that glass particles may spread inside the projector. If this happens, it is recommended you contact your nearest Authorized Dealer to remove the damaged lamp and assure safe operation.

## Replacing the Lamp



**CAUTION!** Do not remove the lamp unit immediately after operation of the projector. The lamp will be hot and touching it can lead to burn or injury. Wait at least one hour after the power cord is disconnected to allow the surface of the lamp unit to fully cool before removing the lamp unit.



## Temperature LED (Over Temperature)

The over temperature alarm LED on the control panel alerts you when the projector lamp becomes too hot or the peripheral is sultry.

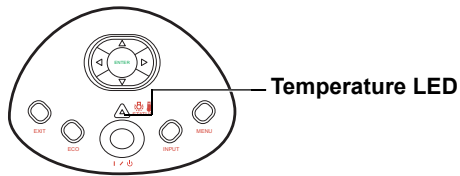

If the LED illuminates during operation, the lamp will shut off and the cooling fans will continue to run for approximately 1.5 minutes. You should ensure that the airflow around the projector is sufficient, and that the air filters are not clogged to ensure that the projector has proper ventilation.

**System Over Temperature !**

**Ambient Over Temperature !**



When the temperature LED lights up, a warning also appears on the screen.

# Removing and Installing the Lamp Unit

Follow these instructions to replace the lamp.

- Be sure to remove the lamp unit by the handle. Be sure not to touch the glass surface of the lamp unit or the inside of the projector.
- To avoid injuring yourself and damage to the lamp, be sure to carefully follow the steps below.
- Do not loosen other screws except for the lamp unit cover and lamp unit.

(Only the silver screws are loosened).

- 1. If the projector is running, press  on the projector or  on the remote control to turn off the power. Wait until the cooling fan stops.**

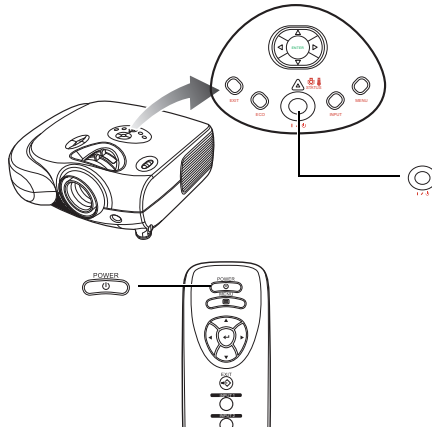

## Warning!

Do not remove the lamp unit from the projector right after use. The lamp will be very hot and may cause burn or injury.

- 2. Disconnect the power cord and wait at least an hour for the lamp to cool.**

- 3. Remove the lamp unit cover.**

- Loosen the user service screw that secures the lamp unit cover. Then open the cover in the direction of the arrow.

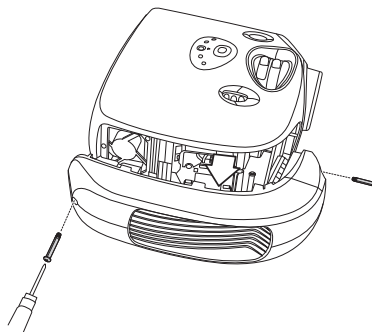

M4\* 8.9 screws

#### 4. Remove the lamp unit.

- Loosen the securing screws from the lamp unit. Hold the lamp unit by the handle and pull it in the direction of the arrow.

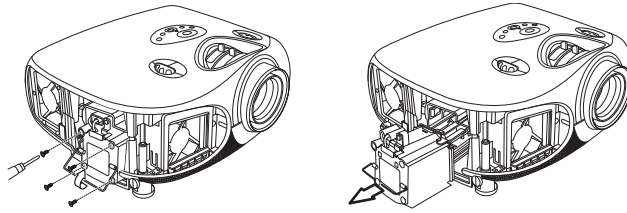

#### 5. Insert the new lamp unit.

- Press the lamp unit firmly into the lamp unit compartment. Fasten the securing screws.
- Attach the lamp unit cover.
- Close the lamp unit cover in the direction of the arrow (to the close mark) on the side of the projector. Then tighten the user service screw.

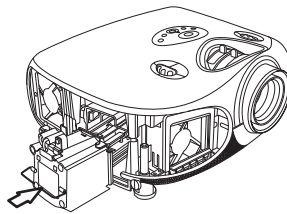

#### Info

- If the lamp unit and lamp cover are not correctly installed, the power will not turn on, even if the power cord is connected to the projector.

## Resetting the Lamp Timer

Reset the lamp timer after replacing the lamp.

#### 1. Connect the power cord.

- Plug the power cord into the AC socket of the projector.

#### 2. Reset the lamp timer.

- Select the “Lamp Timer Reset” from the “Options” menu from the menu screen. Press . Select “OK” to reset the timer or “Cancel” to abort. (See page 50)
- “LAMP OH” is displayed, indicating that the lamp timer is reset.

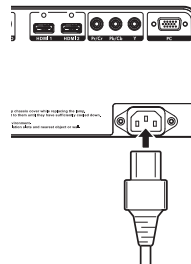

#### Info

Make sure to reset the lamp timer only when replacing the lamp. If you reset the lamp timer and continue to use the same lamp, this may cause the lamp to become damaged or explode.

# Connecting Pin Assignments

**RS-232C Port:** 9 pin Mini pin plug connector to D-Sub Female connector

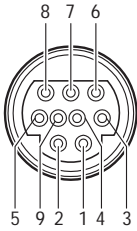

Pin No.	Signal	Name	I/O	Reference
1				Not connected
2	SD	Send Data	Input	Connected to internal circuit
3	RD	Receive Data	Output	Connected to internal circuit
4				Not connected
5	SG	Signal Ground		Connected to internal circuit
6				Not connected
7				Not connected
8				Not connected
9				Not connected

**HDMI Port:** 19 pin male connector of the High Definition Multimedia Interface

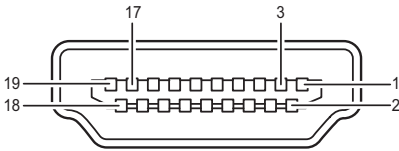

Pin No.	Signal	Pin No.	Signal
1	T.M.D.S data 2+	11	T.M.D.S clock shield
2	T.M.D.S data 2 shield	12	T.M.D.S clock-
3	T.M.D.S data 2-	13	Not connected
4	T.M.D.S data 1+	14	Reserved (N.C. on device)
5	T.M.D.S data 1 shield	15	DDC clock
6	T.M.D.S data 1-	16	DDC data
7	T.M.D.S data 0+	17	DDC ground
8	T.M.D.S data 0 shield	18	+5V power
9	T.M.D.S data 0-	19	Hot plug detection
10	T.M.D.S clock+		

# Computer Compatibility Chart

## Computer

- Multiple signal support

Horizontal Frequency: 25-91 kHz, Vertical Frequency: 24-85 Hz, Pixel Clock: 25-162 MHz

- XGA, SXGA, UXGA compatible with advanced intelligent compression

The following is a list of modes that conform to VESA. However, this projector supports other signals that are not VESA standards.

PC/MAC/WS	Resolution	Horizontal Frequency (kHz)	Vertical Frequency (Hz)	VESA Standard	DVI-D/HDMI Support	
PC	DOS	720 x 400	31.5	70		✓
	VGA	640 x 480	31.5	60		✓
			37.9	72	✓	
			37.5	75	✓	
			43.3	85	✓	

Resolution	Horizontal Frequency (kHz)	Vertical Frequency (Hz)	VESA Standard	DVI Support
720 x 480	31.5	60		✓
720 x 576	31.3	50		
1280 x 720	45	60		
	37.5	50		
1920 x 1080i	33.8	60		
	28.1	50		
1920 x 1080p	27	24		
	56.3	50		
	67.5	60		

PC/MAC/WS	Resolution	Horizontal Frequency (kHz)	Vertical Frequency (Hz)	VESA Standard	DVI-D/HDMI Support	
PC	SVGA	800 x 600	35.1	56	✓	✓
			37.9	60		
			48.1	72		
			46.9	75		
			53.7	85		
	XGA	1024 x 768	48.4	60	✓	✓
			56.5	70		
			60.0	75		
			68.7	85		
			64.0	60		
	SXGA	1280 x 1024	80.0	75	✓	✓
			91.1	85		
	WSXGA	1680 x 1050	65.2	60	✓	✓
	UXGA	1600 x 1200	75.0	60	✓	✓
	MAC 13"	VGA	640 x 480	34.9	67	
MAC 16"	SVGA	832 x 624	49.6	75		
MAC 19"	XGA	1024 x 768	48.4	60	✓	



## Note

- This projector may not be able to display images from notebook computers in simultaneous (CRT/LCD) mode. Should this occur, turn off the LCD display on the notebook computer and output the display data in "CRT only" mode. Details on how to change display modes can be found in your notebook computer's operation manual.
- When projecting video images of an interlace video signal with the projector, the intended image may not be projected depending on the video signal when using the RGB input. In such cases, use the component input, S-Video input or video input.

# Video Compatibility Chart

	Resolution		H-Freq (kHz)	V-Freq (Hz)	Component Support	S-Video Support	Composite Support	HDMI Support
SD Video	NTSC	640x480i	15.7	59.94/60	✓	✓	✓	
	PAL	768x576i	15.6	50	✓	✓	✓	
	SECAM	768x576i	15.6	50	✓	✓	✓	
	NTSC-4.43				✓	✓	✓	
	PAL-M				✓	✓	✓	
	PAL-N				✓	✓	✓	
	NTSC-J				✓	✓	✓	
	PAL-60				✓	✓	✓	
	NTSC-50							
				60	✓	✓	✓	
				50				
ED TV	480p	720x480p	31.5	59.94/60	✓			✓
	576p	720x576p	31.3	50	✓			✓
	1035i/60	1920x1035i	33.8	60	✓			✓
HD TV	1080i/50	1920x1080i	28.1	50	✓			✓
	1080i/60	1920x1080i	33.8	59.94/60	✓			✓
	720p/50	1280x720p	37.5	50	✓			✓
	720p/60	1280x720p	45.0	59.94/60	✓			✓
	1080p/24	1920x1080p	27.0	24	✓			✓
	1080p/25	1920x1080p	28.1	25	✓			✓
	1080p/30	1920x1080p	33.8	30	✓			✓
	1080p/50	1920x1080p	56.3	50	✓			✓
	1080p/60	1920x1080p	67.5	60	✓			✓
HTPC	720p/48	1280x720p	36	48				✓

1. Component supports signal formats are Y/Pb/Pr, Y/Cb/Cr.
2. VGA port support signal formats are RGBHV, RGsB, and RGBCs.







## DTV

Signal	Horizontal Frequency (kHz)	Vertical Frequency (Hz)	HDMI Support
480i	15.7	60	
480p	31.5	60	✓
576i	15.6	50	
576p	31.3	50	✓
720p	45.0	60	✓
720p	37.5	50	✓
1080i	33.8	60	✓
1080i	28.1	50	✓
1080p	27	24	✓
1080p	28.1	25	✓
1080p	33.8	30	✓
1080p	56.3	50	✓
1080p	67.5	60	✓

## IR Remote Key Discrete Codes

Key	Code	Key	Code
IR POWER	0x00		
IR MENU	0x01	IR_PowerOff	0x0d
IR UP	0x02	IR_Standard	0x0e
IR DOWN	0x03	IR_Letterbox	0x0f
IR LEFT	0x04	IR_Anamorphic	0x10
IR RIGHT	0x05		
IR ENTER	0x06	IR_S_Video	0x12
IR_Exit	0x07	IR_Composite	0x13
IR_Source1	0x08	IR_Component	0x14
IR_Source2	0x09	IR_PC	0x15
IR_Source3	0x0a	IR_HDMI1	0x16
IR_Source4	0x0b	IR_HDMI2	0x17
IR_ASPECT	0x0c		

# Troubleshooting

Problem	Check
 <p>Projector does not start</p>	<p>Projector power cord is not plugged into the wall outlet.</p> <p>Remote control batteries have run out.</p>
 <p>No picture</p>	<p>The selected input mode is wrong.</p> <p>Cables may be incorrectly connected to the rear panel of the projector.</p> <p>Power to the external connected device is off.</p> <p>The video signal format of the video equipment is not set correctly.</p>
 <p>Color is faded</p>	<p>Picture adjustments are incorrectly set.</p>
 <p>Picture is blurred</p>	<p>Adjust the focus</p> <p>The projection distance exceeds the focus range.</p>
 <p>Picture noise appears.</p>	<p>(Component/VGA input only)</p> <p>Perform "Fine Sync" adjustments ("Clock" adjustment) also in component</p> <p>Perform "Fine Sync" adjustments ("Phase adjustment) also in component</p>
 <p>Picture is green on INPUT1 COMPONENT</p>	<p>Change the input signal type of the video equipment.</p>



Picture is dark or bright and whitish

Picture adjustments are incorrectly set.



Picture is too bright and whitish

Picture adjustments are incorrectly set.



# Product Specifications

<b>Item</b>	<b>Description</b>
Model No.	1080p DLP Front Projector
DLP Panel	Panel size: 0.65" Display method: DMD by Texas Instruments Device method: Digital Light Processing (DLP™)
Display Type	DLP™ Chip, RGB optical shutter method
Resolution	1920 x 1080 pixels
Short Throw Lens	1-1.25 x zoom lens, F2.4~2.6, f= 18.65~23.32 mm
Long Throw Lens	1-1.25 x zoom lens, F2.4~2.6, f= 23.1~29 mm
Projection Lamp	Lamp type 280W P-VIP lamp
Input Sources	Video HDMI x 2 YCbCr, YPbPr (Component Video) x 1 CVBS (Composite Video) x 1 S-Video x 1 PC x 1 Control RS-232 (For computer) x1 IR Receiver (For remote) x 2 12V trigger output x2 USB x 1
Computer Compatibility	VGA,SVGA, XGA, SXGA, UXGA
2D Lens Shift Ability (Short Throw Lens)	1/2 of screen height: Up 100%, Down 60% 1/2 of screen height: Left 15%, Right 15%
2D Lens Shift Ability (Long Throw Lens)	1/2 of screen height: Up 140%, Down 60% 1/2 of screen height: Left 15%, Right 15%
Digital Keystone Correction	2D correction
Projection Lens	Zoom lens with manual focus and manual zoom adjustment
Screen Size (Short Throw Lens)	50 ~ 300 inches
Screen Size (Long Throw Lens)	40 ~ 300 inches
Short Throw Ratio (16:9)	1.33 ~ 1.66
Long Throw Ratio (16:9)	1.66 ~ 2.09
Projection Distance in 100" (Short Throw Lens)	2.9m ~ 3.7m
Projection Distance in 100" (Long Throw Lens)	3.7m ~ 4.6m
Video Enhance	3D Y/C separation in Composite Video
Projection Method	Front / Rear Desktop, Front / Rear Ceiling
OSD Control	Projector keypad IR remote control
Video System	NTSC 3.58/NTSC 4.43/PAL/PAL-M/PAL-N/PAL 60/SECAM/ EDTV480p/EDTV 576p/HDTV 720p/HDTV 1080i/HDTV 1080p
Dimensions (Short Throw Lens)	380 mm x 336 mm x 164 mm (L x W x H)
Dimensions (Long Throw Lens)	380 mm x 336 mm x 164 mm (L x W x H)
Weight (Short Throw Lens)	15.4 lbs (7.0 kg)
Weight (Long Throw Lens)	15.9 lbs (7.2 kg)
Power Supply	100 ~ 240 V at 50/60 Hz
Power Consumption	365W
Operating Temperature	5°C to 35°C
Lamp Warranty	90 days or 500 hours

Specifications are subjected to change without notice.



# Long Throw Lens Dimension

Unit: mm (inch)

Rear View

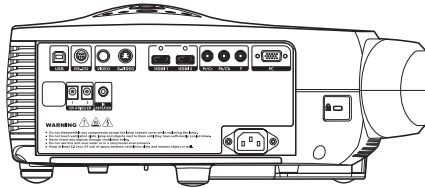

Side View

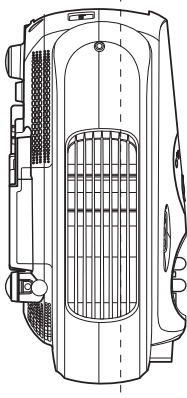

Side View

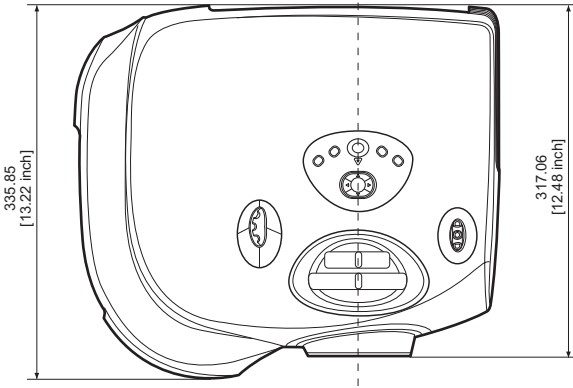
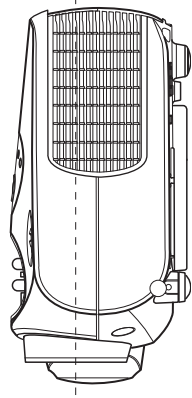

Front View

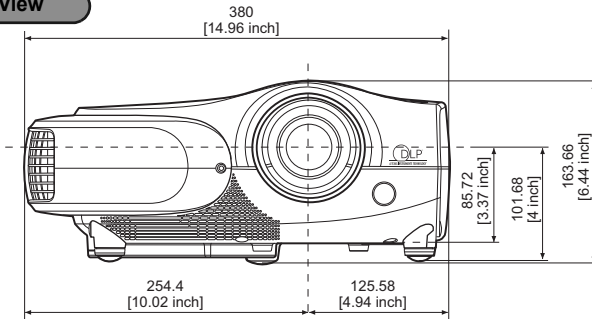

Bottom View

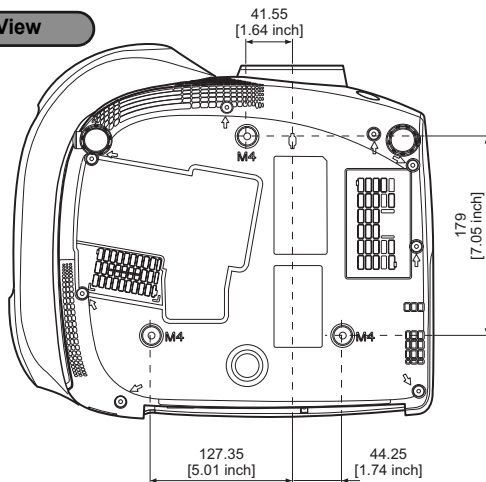



## Free Manuals Download Website

<http://myh66.com>

<http://usermanuals.us>

<http://www.somanuals.com>

<http://www.4manuals.cc>

<http://www.manual-lib.com>

<http://www.404manual.com>

<http://www.luxmanual.com>

<http://aubethermostatmanual.com>

Golf course search by state

<http://golfingnear.com>

Email search by domain

<http://emailbydomain.com>

Auto manuals search

<http://auto.somanuals.com>

TV manuals search

<http://tv.somanuals.com>