



**Amphion MediaWorks**

# **DVD PLAYER P460 USER'S MANUAL**



# Table of Contents

<b>Important Safety Instructions</b> .....	01
<b>Notes on Discs</b> .....	02
<b>Introduction</b>	
Front Panel .....	03
Rear Panel .....	03
Remote Control Functions .....	04
Prepare the remote Control.....	04
<b>Getting Started</b>	
Video Connection .....	05
Audio Connection .....	05
Operating DVD player with the remote control.....	06
<b>Basic Operation</b>	
Playing a DVD .....	07
Front Panel Operation .....	07
Remote Control Operation.....	08
<b>Special Operation</b>	
What is MP3.....	12
What is JPEG.....	12
MP3/JPEG Operation.....	12
Kodak Picture & CD Discs Compatible.....	12
<b>System Configuration</b>	
System Setup Page .....	13
Language Setup Page .....	14
Audio Setup Page .....	15
Video Setup Page .....	16
Speaker Setup Page.....	17
Digital Setup Page.....	18
Exit Setup Menu.....	18
<b>Appendix (Definition of Keywords)</b> .....	19

# WARNING

**Warning!** - This symbol is intended to alert you to the presence of dangerous voltage with the product's enclosure that may be of sufficient magnitude, to reduce a risk of electrical shock or fire. Do not expose the unit to rain or moisture. Refer to the warning label or tag included, and exercise with extreme caution.



**Caution!** - This symbol is intended to alert you to the presence of important operating and maintenance instructions in the literature accompanying the appliance. Refer to the User's Manual or Operator's Manual for precautionary instructions.

## Caution!

To reduce the risk of electric shock, do not remove cover (front or back). No user-serviceable parts inside. Refer servicing to qualified service professional.

**THIS PRODUCT APPLIES U.S. PATENT NOS. 4,631,603, 4,577,216, 4,819,098, AND 4,907,093 LICENSED FOR LIMITED VIEWING USES ONLY.**



This product is class 1 laser product,

## Warnings

Use only shielded cables to connect I / O devices to this equipment.

## Copyright

This product incorporates copyright protection technology that is protected by method claims of certain U.S. patents and other intellectual property rights owned by Macrovision Corporation and other rights owners. Use of this copyright protection technology must be authorized by Macrovision Corporation, and is intended for home and other limited viewing uses only unless otherwise authorized by Macrovision Corporation. Reverse engineering or disassembly is prohibited.

Manufactured under license from Dolby Laboratories.

"Dolby" and the double-D symbol are trademarks of Dolby Laboratories.

## Statement

This device complies with Part 15 of the FCC Rules. Operation is subject to the following two conditions:

- (1) This device may not cause harmful interference, and
- (2) This device must accept any interference received; including interference that may cause undesired operation.

This Equipment has been tested and found to comply with the limits for a Class B digital device, pursuant to Part 15 of the FCC rules. These limits are designed to provide reasonable protection against harmful interference in a residential installation. This equipment generates, uses and can radiate radio frequency energy and, if not installed and used in accordance with the instructions, may cause harmful interference to radio communications. However, there is no guarantee that interference will not occur in a particular installation. If this equipment does cause harmful interference to radio or television reception, which can be determined by turning the equipment off and on, the user is encouraged to try to correct the interference by one or more of the following measures:

- Reorient or relocate the receiving antenna.  
Increase the separation between the equipment and receiver.
- Connect the equipment into an outlet on a circuit different from that to which the receiver is connected.
- Consult the dealer or an experienced radio/TV technician for help.

## Important Safety Instructions

01. Read these instructions.
02. Keep these instructions.
03. Heed all warnings.
04. Follow all instructions.
05. Do not use this apparatus near water.
06. Clean only with a damp cloth.
07. Do not block any of the ventilation openings. Install in accordance with the manufacturer's instructions.
08. Do not install it near any heat sources such as radiators, heat registers, stoves, or other apparatus (including amplifiers) that produce heat.
09. Do not defeat the safety purpose of the polarized-type plug: A polarized plug has two blades with one wider than the other. The wider blade is provided for your safety. When the provided plug does not fit into your outlet, consult an electrician for replacement of the obsolete outlet.
10. Protect the power cord from being walked on or pinched (particularly the plug, convenience receptacles, and the point where they exit from the apparatus).
11. Only use attachments/accessories specified by the manufacturer.
12. Use only with a cart, stand, tripod, bracket, or table specified by the manufacturer, or sold with the apparatus. When a cart is used, use with caution.
13. Unplug this apparatus during lightning, storms, or when unused for a long period of time.
14. Refer all servicing to qualified service personnel. Servicing is required when the apparatus has been damaged in any way: ex. power-supply cord or plug is damaged, liquid has been spilled or objects have fallen into the apparatus, the apparatus has been exposed to rain or moisture, does not operate normally, or has been dropped.



### Please read all of these instructions thoroughly before operating the DVD Player.

- Unplug the connector from DVD-Player to the system unit before cleaning. Do not use liquid or aerosol cleaners.
- Use a damp cloth for cleaning.
- Use only attachments recommended by the manufacturer; un-approved attachments may be hazardous.
- Do not place the DVD-Player near water, for example near a bathtub, washbowl, kitchen sink, or laundry tub, in a wet basement, or near a swimming pool.
- Do not place the DVD-Player on an unstable cart, stand or table. If the DVD-Player falls, it could injure a person or cause serious damage to the appliance. Use only a cart or stand recommended by the manufacturer or sold with the mounting kit approved by the manufacturer and follow the kit instructions.
- The DVD-Player is equipped with a three-wire grounded plug, a plug with a third (grounding) pin.
- This is a safety feature. If your outlet does not accommodate the three-wire plug, have an electrician install the correct outlet, or use an adapter to ground the appliance safely. Do not defeat the safety purpose of the grounded plug.
- Do not allow anything to rest on the power cord. Do not locate the DVD-Player where people may walk on the cord.
- In order to avoid the damage of the DVD-Player from lightning and power surges, please unplug all the connectors from the system unit when the DVD Player is under a spare time or lightning storm.
- Do not overload power outlet and extension cords. Electric power overload will cause fire or electric shock.
- Never push any objects into the slot in the DVD-Player cabinet. It could touch dangerous voltage points or short out parts resulting in a fire or electric shock. Never spill liquid on the DVD-Player.
- If your DVD-Player does not operate normally, unplug it immediately and contact an authorized technician.
- To avoid electric shock, do not attempt to open the cabinet and repair any damaged parts. Unplug the DVD-Player from the system unit and refer servicing to qualified service personnel under the following conditions:

- When the power cord or plug is damaged or frayed.
- If liquid has been spilled onto the DVD-Player.
- If the DVD-Player has been exposed to rain or moisture.
- If the DVD-Player does not operate normally after you have followed the operating instructions. Adjust only those controls covered by the operating instructions; improper adjustments to other controls may result in damage and may require extensive work by a qualified technician to restore the DVD-Player to normal operation.
- If the DVD-Player has been dropped or the cabinet has been damaged.
- When the video and audio of DVD-Player exhibits a distinct change in performance.
- To reduce the risk of electric shock, do not remove the cover (front or back). No user-serviceable parts inside. Refer servicing to qualified service professional.
- This product applies to U.S. Patent Nos. 4,631,603, 4,577,216, 4,819,098 and 4,907,093 Licensed for limited viewing uses only.
- DVD-Player is a high quality laser product. This player uses a visible laser beam that could cause hazardous radiation exposure if directed to the eyes.

### Handling precautions

- Hold the disc by the edges so the surface will not be soiled with fingerprints. Fingerprints, dirt and scratches can cause skipping and distortion.
- Do not write on the label side with a ball-point pen or other writing tools.
- Do not use record cleaning sprays, benzene, thinner, static electricity prevention liquids or any other solvent.
- Be careful not to drop or bend the disc.
- Do not install more than 1 disc on the disc tray.
- Do not try to close the disc tray when the disc is not installed properly.
- Be sure to store the disc in its exclusive case.

### If the Surface is soiled

- Wipe gently with a soft, damp (water only) cloth.
- When wiping discs, always move the cloth from the center hole toward the outer edge.
- If you wipe the discs using a circular motion, circular scratches are likely to occur, which will cause noise while playing.
- If the disc is brought from cold to warm environment, moisture may form on the disc.
- Wipe this moisture off with a soft, dry, lint-free cloth before using the disc.

### Improper disc storage

**You can damage discs if you store them in the following places:**

- Areas exposed to direct sunlight.
- Humid or dusty areas.
- Areas directly exposed to a heat outlet or heating appliance.

### The player cannot play discs

- DVD region code is not suitable for your player.

### Maintenance

- Be sure to turn the power button OFF and disconnect the power plug before maintaining the unit.
- Wipe this unit with a dry soft cloth.
- If the surface is extremely dirty, wipe clean with a cloth that has been dipped in water and then wipe again with a dry cloth.
- Never use alcohol, benzene, thinner, cleaning fluid or other chemicals. And do not use compressed air to remove dust.

# Introduction

This section describes a full-fuction high performance DVD Player that is microprocessor-controlled and also allows users to place their own settings into memory via external setting. The setting status is indicated on the screen.

## Front Panel

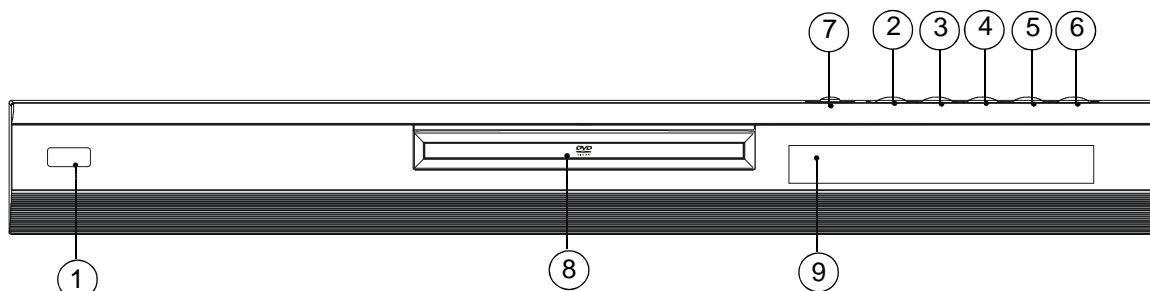

- (1) POWER
- (4) STOP
- (7) OPEN/CLOSE

- (2) PLAY
- (5) PREV.
- (8) DOOR TRAY

- (3) PAUSE
- (6) NEXT
- (9) IR REMOTE SENSOR

## Rear Panel

### 2 Channel

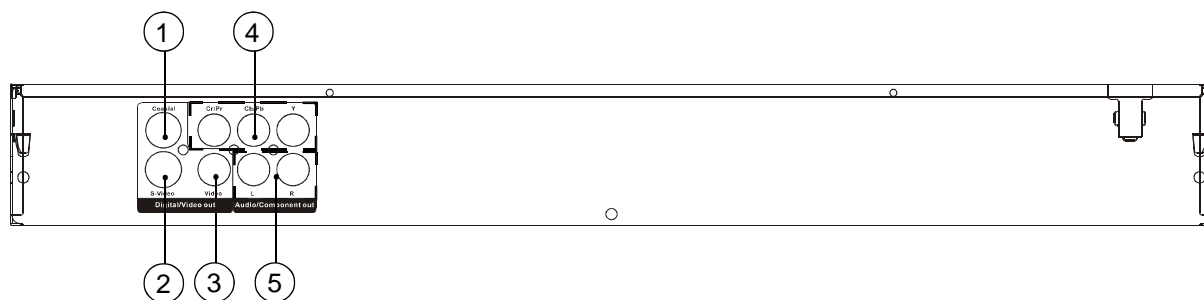

- (1) COAXIAL OUTPUT JACK
- (3) COMPOSITE VIDEO OUTPUT JACK
- (5) STEREO AUDIO OUTPUT JACKS

- (2) S-VIDEO OUTPUT JACK
- (4) COMPONENT OUTPUT JACKS

# Introduction

## Remote Control Functions

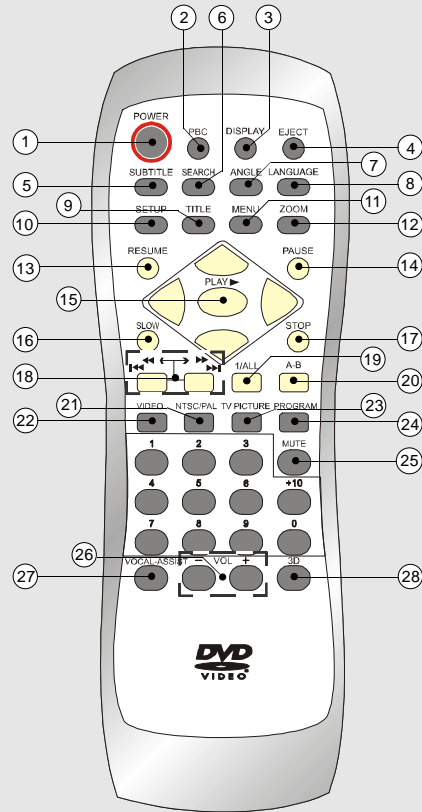

- |                 |                      |                        |                   |                   |
|-----------------|----------------------|------------------------|-------------------|-------------------|
| ( 1 ) POWER     | ( 2 ) PBC            | ( 3 ) DISPLAY          | ( 4 ) EJECT       | ( 5 ) SUBTITLE    |
| ( 6 ) SEARCH    | ( 7 ) ANGLE          | ( 8 ) LANGUAGE         | ( 9 ) TITLE       | ( 10 ) SETUP      |
| ( 11 ) MENU     | ( 12 ) ZOOM          | ( 13 ) RESUME          | ( 14 ) PAUSE      | ( 15 ) PLAY/ENTER |
| ( 16 ) SLOW     | ( 17 ) STOP          | ( 18 ) PREVIOUS, F.R./ | ( 19 ) 1/ALL      | ( 20 ) A-B        |
| ( 21 ) NTSC/PAL | ( 22 ) VIDEO(OPTION) | NEXT, F.F.             | ( 23 ) TV PICTURE | ( 24 ) PROGRAM    |
| ( 25 ) MUTE     | ( 26 ) VOL- / VOL+   | ( 27 ) VOCAL-ASSIST    | ( 28 ) 3D         |                   |

## Prepare the Remote Control

To operate the DVD player , you must place the batteries in the remote control first.

**1**

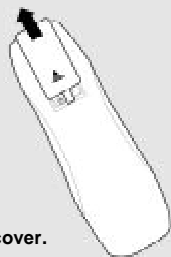

1. Open the cover.

**2**



2. Insert two "AAA" batteries. Make sure the position of + and - on the batteries match the marks inside the battery compartment.

**3**

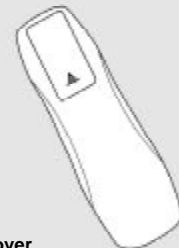

3. Close the cover.

# Getting Started

## Video Connection

### Video Output

Connect the DVD player's video output (RCA connector or S-Video) on the rear panel to the TV's video input (or other devices) using AV, S-Video or Component.

#### Note:

Certain output formats may not be available on all models. Please check product outer box for available.

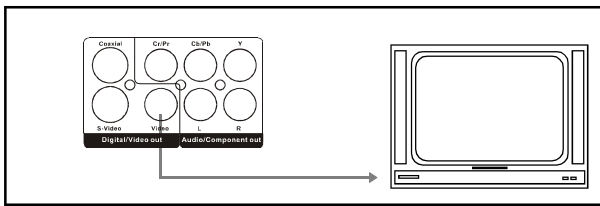

YELLOW

### S-Video Output

- If your display device supports S-Video terminal, you can also connect your display device to DVD player's S-Video Output connector on the rear panel.

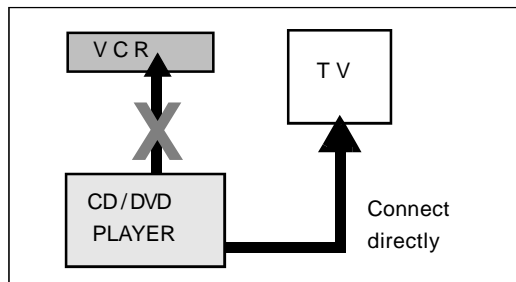
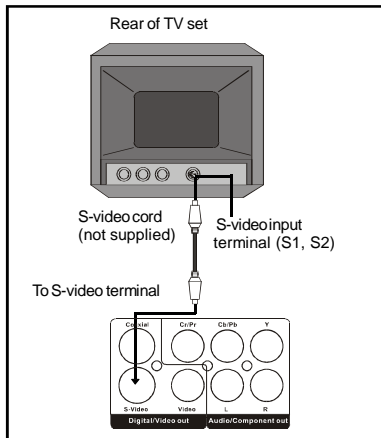

#### Notes:

1. Refer to the instructions supplied with the component to be connected.
2. Do not connect this player to a video deck. If you do, noise may appear in the picture.

## Audio Connection

### Stereo Configuration

Connect your TV stereo audio inputs (L for left channel and R for right channel) to the DVD player's stereo audio output L and R respectively.

### Analog 2 Channel Output

For your convenience and cost concern, DVD-Player supports Dolby 2 Channel audio output directly. However, you still need to connect the 2 Channel audio output to your audio amplifier relatively as following.

#### Note:

When you connect the DVD player to another device, be sure to turn off the power and unplug all of the equipment from the wall outlet before making any connections. The output sound of the DVD player has a wide dynamic range. Be sure to adjust the receiver's volume to a moderate listening level. Otherwise, the speakers may be damaged by a sudden high volume sound. Turn off the receiver before you connect or disconnect the DVD player's power cord. If you leave the receiver power on, the speakers may be damaged.

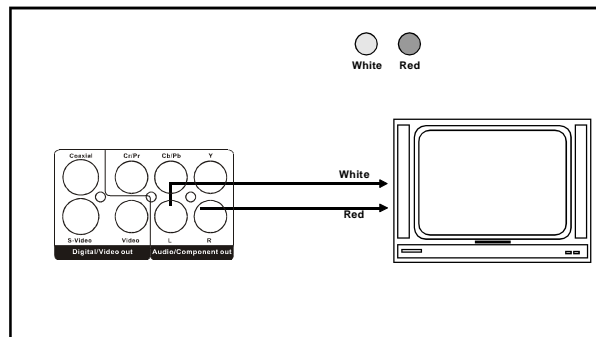



# Getting Started

## Operating DVD player with the remote control

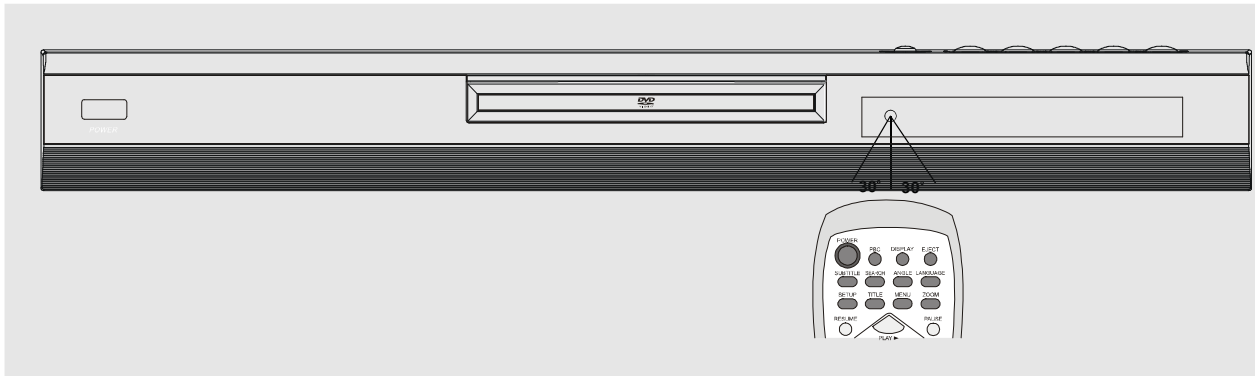

**When using the remote control, point to the remote sensor on the DVD player.**

**Distance:**

Maximum of 7m

**Angle:**

Approximately 30° from each direction.

*\*Do not expose the remote sensor directly to direct sunlight or lighting apparatus. The DVD player will malfunction if you do so.*

# Basic Operation

## Playing a DVD

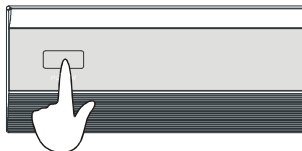

1. Press the Power button to turn on the player.



3. Insert a disc.



2. Press the Eject button (▲) to open the tray door.



4. Press the Eject button (▲) to close the tray door.

## Front Panel Operation

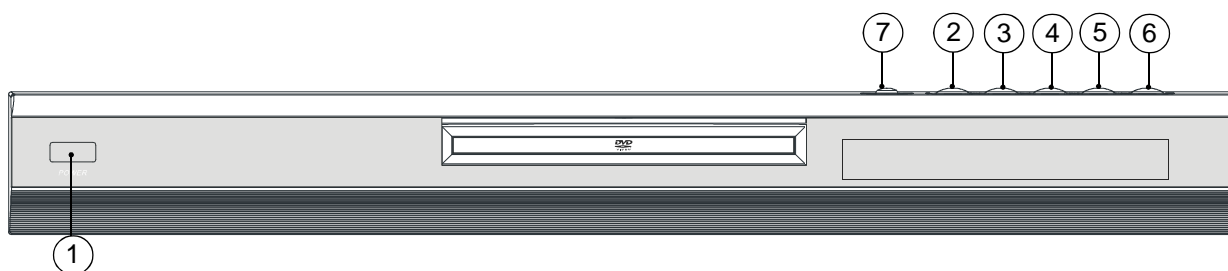

### 1. POWER

Turn on or turn off the player.

### 3. PAUSE

Momentarily stop the program on the disc.

Press "PLAY" to return to normal play.

### 5. PREV.

Go back to the preceding chapter or track

### 7. OPEN/CLOSE

Open or close the tray.

### 2. PLAY

Play the program on the disc.

### 4. STOP

Stop playing.

### 6. NEXT

Go to the next chapter or track.

# Basic Operation

## Remote Control Operation

### 1.POWER

Turn on or turn off the player.

### 2.PBC

Playback control. Press “PBC” (on) to program selected chapter. The root menu will appear. Press PBC(off) to play movie uninterrupted.

### 3.DISPLAY

Each time you press the “DISPLAY” button, the following information will appear on the TV screen:

- a). When you are playing a DVD
  - Disc format, Title, Chapter, Chapter Elapsed time
  - Language, Subtitle, Angle
  - Chapter remain time
  - Title time
  - Title remain time
  - Display off
- b). When you are playing a CD , VCD or MP3
  - Disc format, Chapter, Mute icon, Dts/PBC, Chapter Elapsed time
  - Chapter remain time
  - Title time
  - Title remain time
  - Display off

### 4.EJECT

Press “EJECT” to open the disc tray. Place a Disc on the tray dish. Hold the disc without touching the surface, position it with the printed title side facing up, align it with the guides, and place it in its proper position.

Press “EJECT” to start playing. The disc tray will automatically close and start playing . If the disc has one or more titles recorded on it, the menu screen will appear on the TV monitor.

### 5.SUBTITLE

If the disc has two or more subtitles recorded on it, they can either be displayed or cleared on the screen.

1. Press “SUBTITLE” during play. It will show as many subtitles as the disc has.
2. Keep on pressing, selected subtitle (including subtitle off) will appear in turn.
3. Stop pressing the button after the selected subtitle appears.

**Note:** In some cases, the subtitle language is not changed immediately to the selected one. When the selected language is not working, even after pressing the button several times, it means that the language is not available on the disc. This function is only for DVD discs.

### 6.SEARCH

Use this button you can search TITLE, CHAPTER & PLAYING TIME.

- 1.Press “SEARCH” to show on-screen display.
- 2.Use “◀▶” to select the different modes.
- 3.Press “PLAY” to select the details.

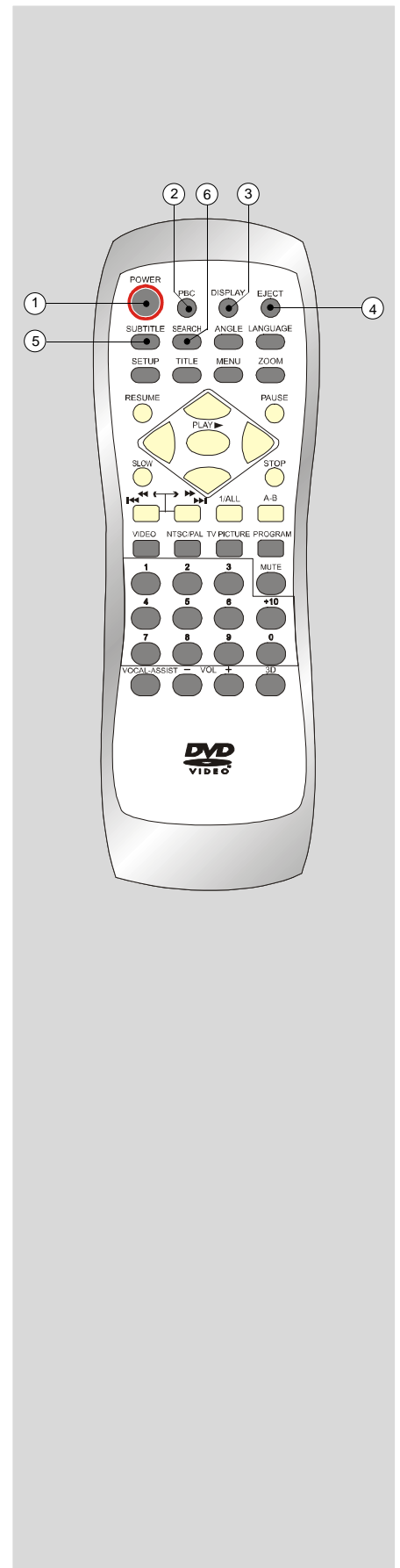

# Basic Operation

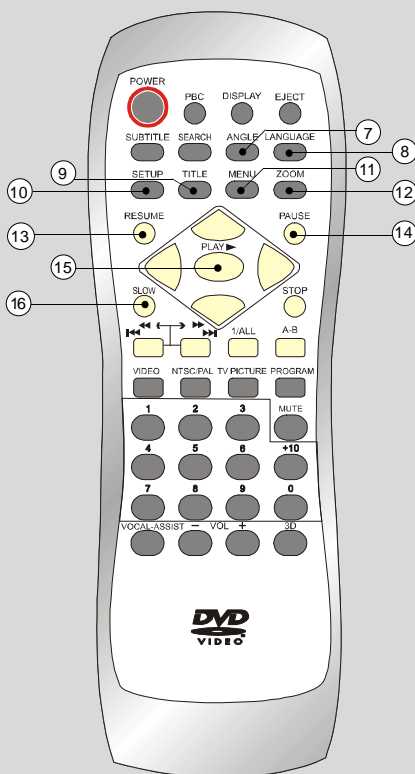

## 7.ANGLE

Some DVD discs may contain scenes that have been filmed simultaneously from a number of different angles. For these discs, the same scene can be viewed from various angles using the “**ANGLE**” button. (The recorded angles varies depending on the disc.)

This function is only for DVD discs.

## 8.LANGUAGE

It is possible to change the audio soundtrack language from the one selected at the initial setting to a different language, if available. (This operation works only with discs on which multiple audio soundtrack languages are recorded.)

Press “**LANGUAGE**” during play. The options will appear on the screen. Continue pressing the “**LANGUAGE**” button until your desired language is displayed.

## 9.TITLE

Press “**TITLE**” to select preferred options. Use direction keys to select. Press “**PLAY**” to enter the selection.

## 10.SETUP

Access the System Setup Menu.

## 11.MENU

Some discs with movies, for example, come with two or more titles. If the disc has a title menu recorded on it, the “**MENU**” button can be used to select the movie title. (The details of this operation differ depending on the disc used.) This function is only used for DVD disc.

1. Press “**MENU**” during play. A list of the titles on the disc will be displayed.
2. Press direction key to select the preferred title.
3. Press “**PLAY**”. The selected title now starts to play.

## 12.ZOOM

Each time this button is pressed, the enlarged image changes as followed:

2x→3x→4x→1/2x→1/3x→1/4x→restore image's normal size

You can move the scene with direction key.

## 13.RESUME

Press “**RESUME**” to exit the menu system of the DVD returning to normal playback mode.

## 14.PAUSE

Press “**PAUSE**” during play to get a still picture. Press “**PLAY**” again to return to normal play.

## 15.PLAY/ENTER

Start playing the program on the disc.

## 16.SLOW

Press “**SLOW**” in the play mode. The slow motion changes each time this button is pressed as followed,

▶ :1/2x →1/4x →1/6x →1/8x →restore normal play mode.

# Basic Operation

## 17.STOP

Press this button to stop playing a disc.

## 18.PREVIOUS, F.R. / NEXT, F.F.

Press these buttons all the time (about 2 seconds) to change the chapter or track during play. And press them once to change the speed.

## 19.1/ALL

### Repeat Chapter

Press "1/ALL" during play, the repeat options will be changed as following:

<b>Repeat Chapter(Track)</b>	<b>Repeat all</b>
<b>Repeat Title</b>	<b>Cancel repeat mode</b>

**Note:** Repeat play works only with discs for which the elapsed playing time appears in the unit's display during playback. Repeat play may not work correctly with some DVDs. For MP3 disc, there are three modes to repeat the contents: Folder (default value), Rep-one and Folder Rep.

## 20.A-B

### Repeat A-B

1. Press "A-B" to repeat play between two intervals. Press "A-B" (1), to set the beginning of the repeat cycle. Press "A-B" again (2), to set the end of the repeat cycle. This process will enable constant repeat playing between (1) and (2).
2. Press "A-B" again to end the process and return to normal play mode.

**Note:** A-B repeat play works only with discs for which the elapsed playing time appears on the unit's display during playback. This function is not available for MP3 discs. Some subtitles recorded around point A or B may fail to appear.

## 21.NTSC / PAL

Choosing TV mode from "NTSC", "PAL", "PAL-60" and "Auto".

## 22.VIDEO(optional)

Each time you press the button during play, the video output mode will be changed as followed:

**AV (or S-video or Y-Cb-Cr) →TVRGB → P-SCAN → PCVGA → restore normal output mode.**

- Note:** 1.If your TV doesn't support P-SCAN mode, the screen will disappear, press it again to solve the problem.  
2.You can't select some specific functions if the product doesn't support it.

## 23.TV PICTURE

Press the button each time, the TV picture will be changed as followed:

**MILD →MEMORY → STANDARD → DYNAMIC → restore normal mode.**

## 24.PROGRAM

You can arrange the orders of the titles, chapters, or tracks on the disc and create your own program. This function is only active in PBC (Play Back Control) OFF mode.

**Program: DVD, MP3 / JPEG disc program menu**

PROG			
T	C	T	C
---	---	---	---
---	---	---	---
---	---	---	---
---	---	---	---
<PLAY>		<CLEAR>	
		+	

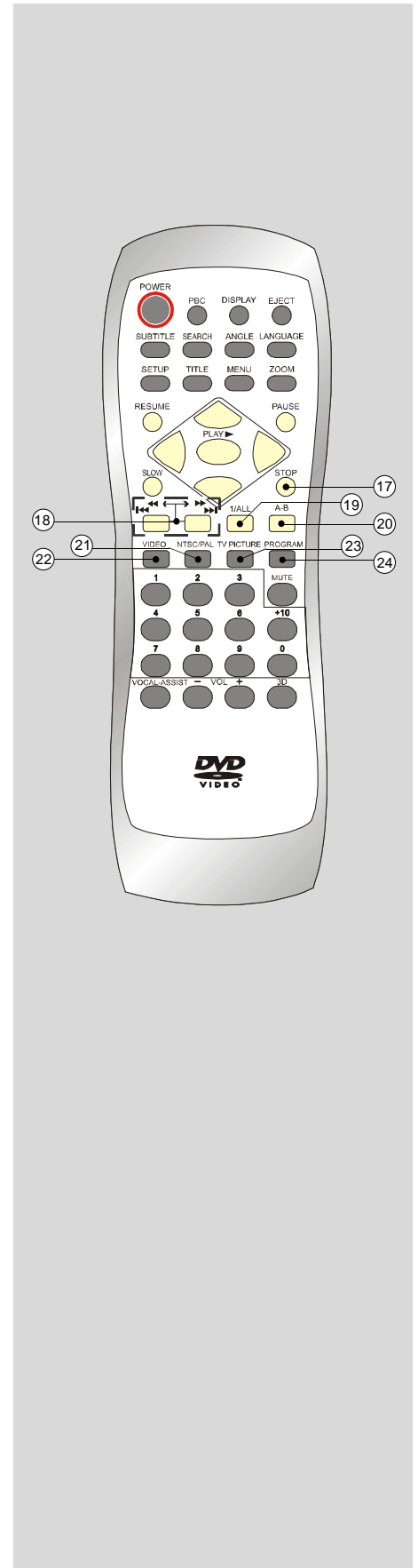

# Basic Operation

## 25.MUTE

Press this button to mute sound. Press it again to restore sound.

## 26.VOLUME

Use "VOL-" or "VOL+" button to adjust the output volume.

## 27.VOCAL-ASSIST

You can select Left channel output only or Right channel output only or Stereo output.

## 28.3D

Press this button to show the music profile icon. Use "◀/▶" to choose SURROUND, EQUALIZATION, BAND or KEY. Then press "▲/▼" to select the details.

- (1). Surround: **OFF**→**CONCERT**→**CHURCH**→**PASSIVE**→**WIDE**→**LIVE**
- (2). Equalization: **STANDARD**→**CLASSIC**→**ROCK**→**JAZZ**→**POP**→**USER**
- (3). Band: to show the music profile.
- (4). Key: Use "▲/▼" to adjust the tone of the music.

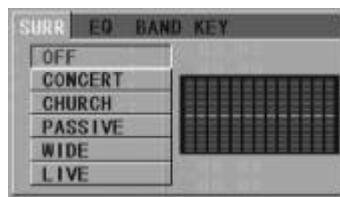
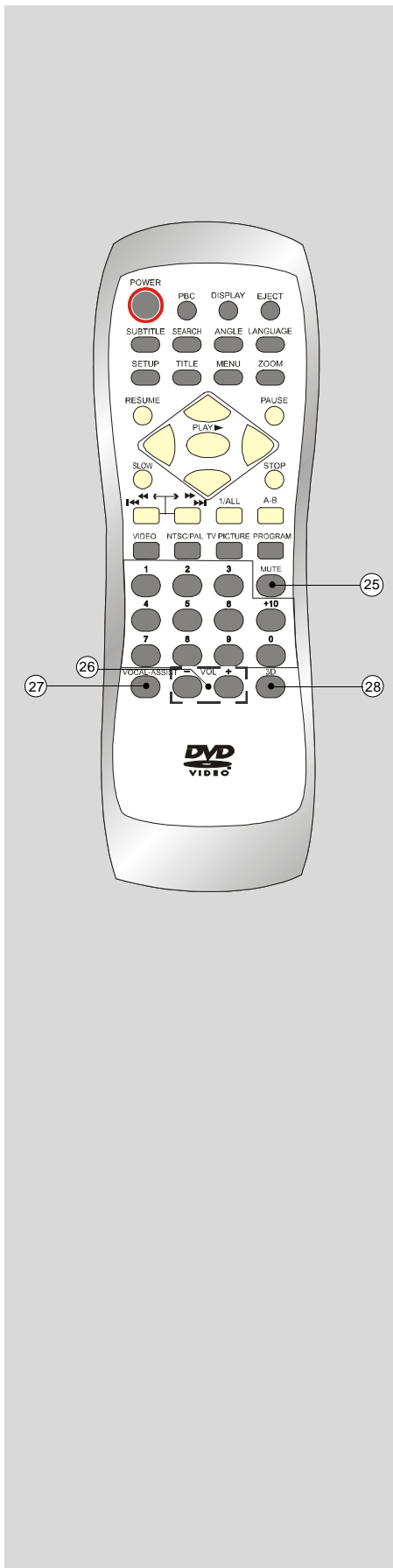

(1)



(2)

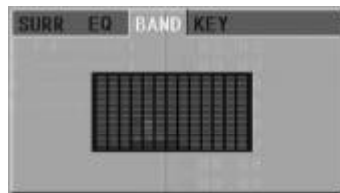

(3)

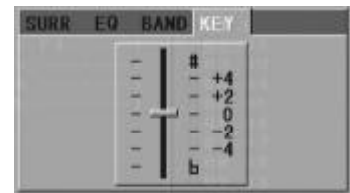

(4)

## Special Operation

### What is MP3

**MP3** is a new music format which is capable of playing the music on the internet.

### What is JPEG

**JPEG** is short for the "Joint Photographic Experts Group", a group of experts nominated to produce standards for continuous tone image coding.

The best known standard from JPEG is IS 10918-1 (ITU-T T.81), which is the first of a multi-part set of standards for still image compression. This allows you to create files (such as photographs, drawings, and most clip-art) that can be archived on a CD-R for viewing on the RDV650, computer, or the web.

### MP3/JPEG Operation

After inserting MP3/JPEG discs, the player will automatically search different menu of the discs. After searching, the player will automatically enter the first menu of MP3 disc, and play the first track in the first menu. OSD shows the followings:

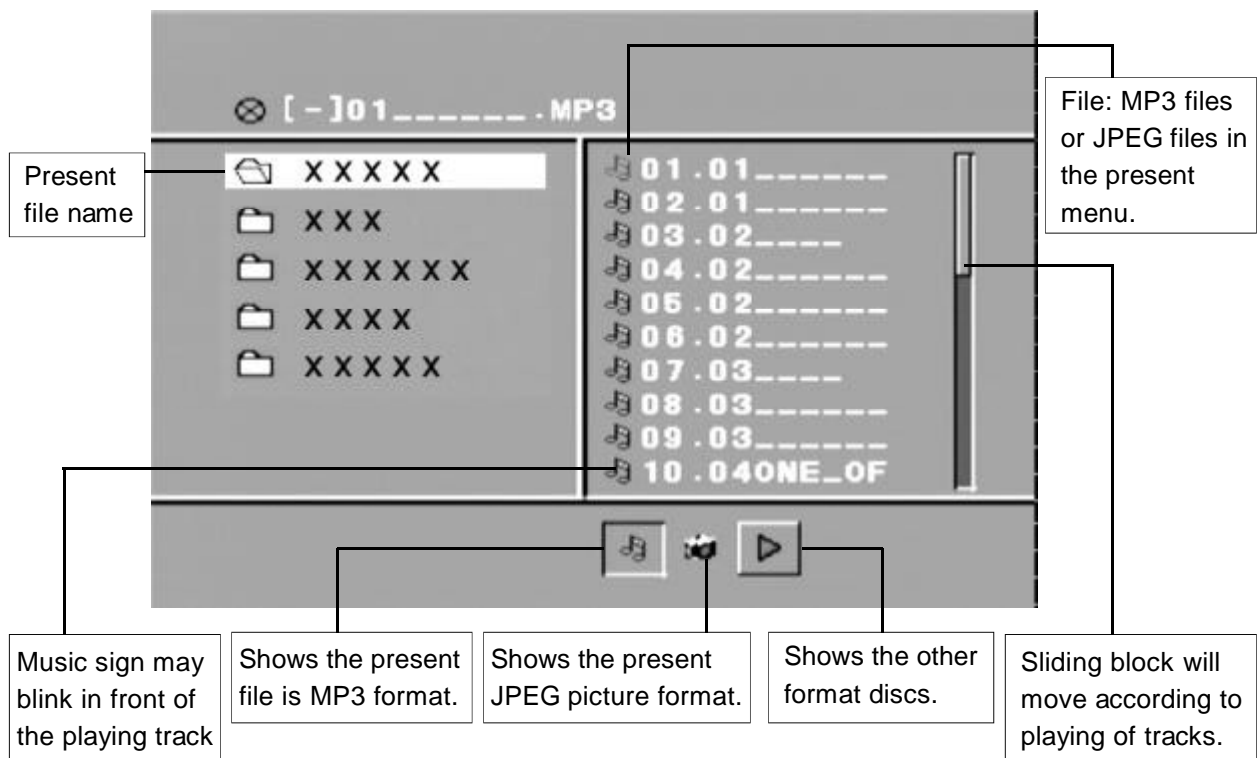

### Kodak Picture & CD Discs Compatible

When play picture CD discs, OSD will show you the operating menu, make your choice by pressing the directional buttons on the remote control and then press "**PAUSE**" button. Now press "**ZOOM**" button to enlarge the picture, press "**PLAY**" button to automatically search pictures.

# System Configuration

Use the Setup Menu display to change the system configuration. In this section, each item on the Setup Menu display will be described. Use "▲/▼/◀/▶" buttons to select the item that you want and press "PLAY" or "ENTER" button to confirm.

## System Setup Page



Setup different function of DVD player and the TV set.

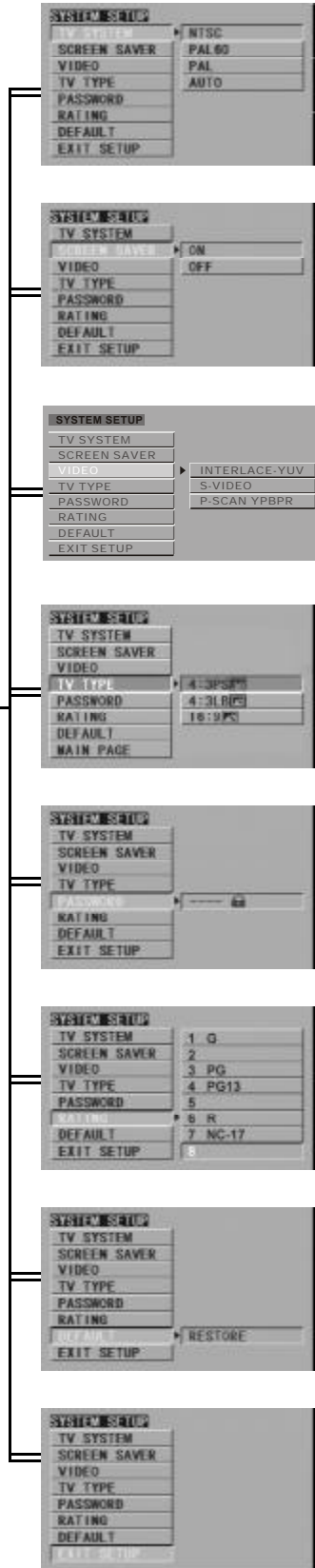

### TV SYSTEM

TV system: Select the appropriate setting depending on your TV type. It's recommended that you leave this setting on AUTO mode. You may choose from AUTO, NTSC, PAL, PAL60.

### SCREEN SAVER

Screen saver have two mode: ON, OFF. When in "ON" mode, if you do not make any operation or in stop mode for one minute, the screen saver picture will appear.

### VIDEO

Video output: refer to chapter four and setup the Video Output mode according to the connection mode. If common video, just choose S-Video, if use YUV input TV, use YUV output mode.

### TV TYPE

Preference pictures:

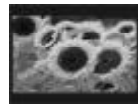

4:3 subtitle block to view the full width of the broad mode.

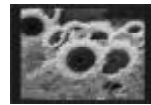

To view the standard 4:3 picture or the cutted standard 4:3 picture.

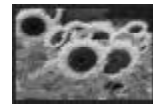

To view broad mode picture with the broad screen TV set.

**NORMAL/PS**

**NORMAL/LB**

**WIDE**

### NOTE:

- No matter what kind of picture mode is chosen, picture recorded in the standard 4:3 format will be displayed in the 4:3 picture mode.
- Dependent upon the present discs, the recording format will be different.
- If choose 16:9 broad mode on the standard 4:3 picture mode TV set, the 16:9 mode picture will be compressed in the horizontal direction.
- Some disc are recorded in certain format. If so, no matter what kind of picture mode you are choosing, the picture will be displayed in their original recording mode.

### PASSWORD

Select "CHANGE" to change the original password. The original password is 0000.

### RATING

Three grades of laws: NO ADULT, KID SAFE, VIEW ALL. The factory default to VIEW ALL.

### DEFAULT

Change your setup state to the factory default setup.

### EXIT SETUP

Return to the main setup page.



# System Configuration

## Language Setup Page



**NOTE:** Subtitle language menu language are only valid to the setup of DVD discs.



### OSD LANGUAGE

OSD has seven different languages: ENGLISH, GERMAN, SPANISH, FRENCH, PORTUGUESE, ITALIAN and DUTCH. If you choose a language, the menu will be all in the language.



### AUDIO LANGUAGE

AUDIO LANG setup has eight different languages: CHINESE, ENGLISH, JAPAN, FRENCH, SPANISH, PORTUGUESE, LATIN and GERMAN. If you choose a language, the disc must be equipped with the language.



### SUBTITLE LANGUAGE

SUBTITLE LANG setup has eight different languages: CHINESE, ENGLISH, JAPAN, FRENCH, SPANISH, PORTUGUESE, GERMAN. If you choose the subtitle language, the disc must first be equipped with different language subtitles.



### MENU LANGUAGE

MENU LANG setup has eight different languages: CHINESE, ENGLISH, JAPAN, FRENCH, SPANISH, PORTUGUESE, GERMAN and LATIN. If you choose menu language, the disc must first be equipped with multilanguage menus.



### EXIT SETUP

Return to the main setup page.

# System Configuration

## Audio Setup Page

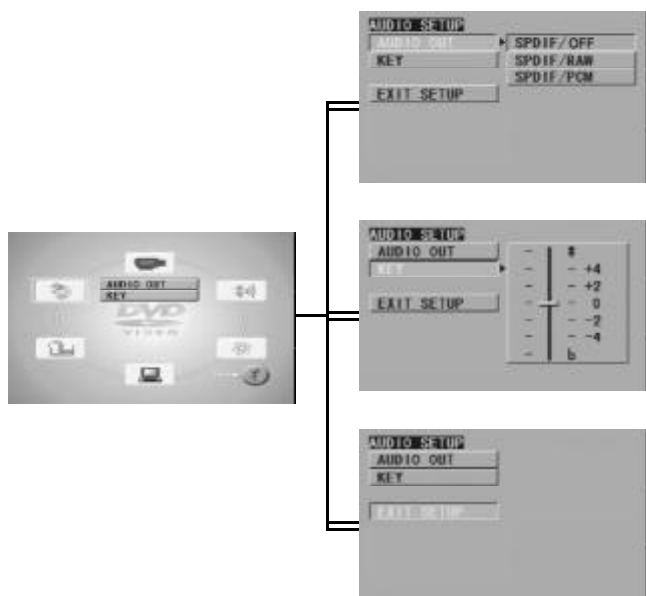

### AUDIO OUT

AUDIO OUT has three different types: for common AV output, please choose "SPDIF/OFF"; for optical or coaxial output, please choose "SPDIF/RAW" or "SPDIF/PCM".

### KEY (for KARAOKE function)

Use "▲/▼" directional buttons to adjust the tone of the music. Choose "b" to have a lower tone. Choose "# " to have a higher tone.

### EXIT SETUP

Return to the main setup page.

# System Configuration

## Video Setup Page

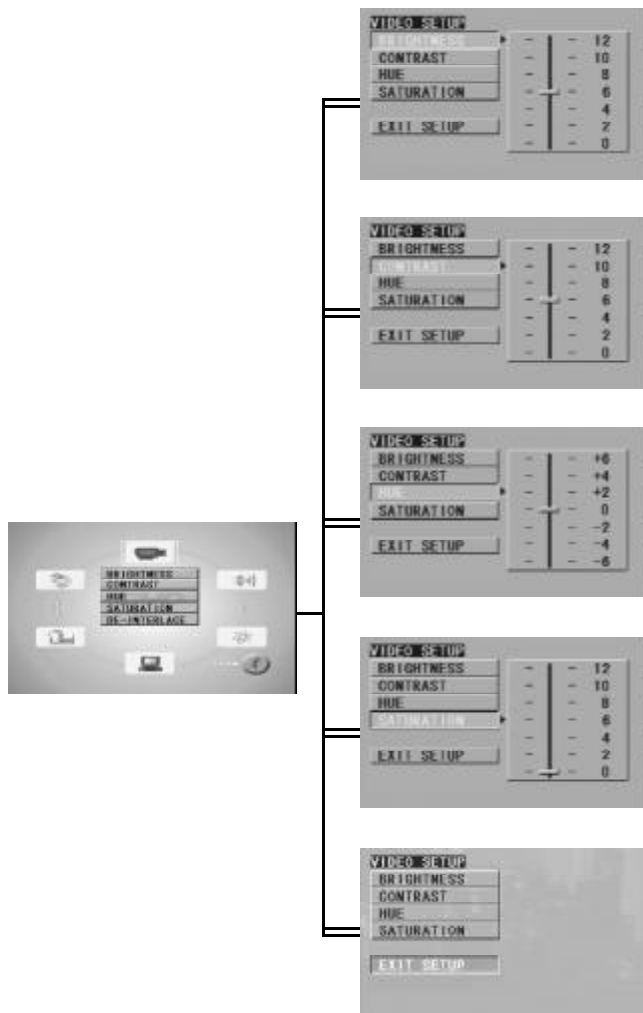

### BRIGHTNESS

Press "▲/▼" to adjust brightness.

### CONTRAST

Press "▲/▼" to adjust contrast.

### HUE

Press "▲/▼" to adjust hue.

### SATURATION

Press "▲/▼" to adjust saturation.

### EXIT SETUP

Return to the main setup page.

# System Configuration

## Speaker Setup Page(for 2ch output)

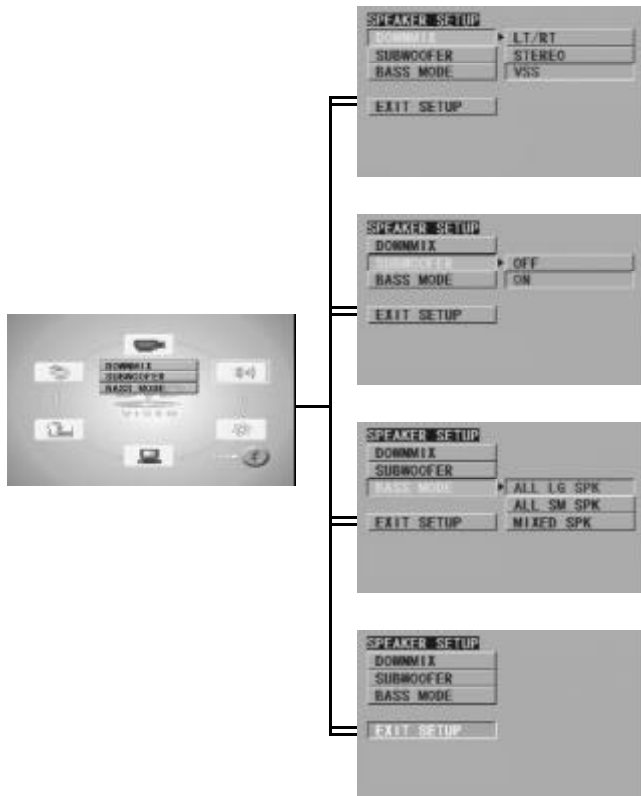

### DOWNMIX

Switches the mixing down methods when you play a DVD with rear signal components. This function can be set to "LT/RT", "STEREO", "VSS", "OFF".

### SUBWOOFER

The function lets you turn your subwoofer "ON" or "OFF".

### BASS MODE

Use "▲/▼" directional buttons to select the "ALL LG SPK", "ALL SM SPK" or "MIXED SPK".

### EXIT SETUP

Return to the main setup page.

# System Configuration

## Digital Setup Page

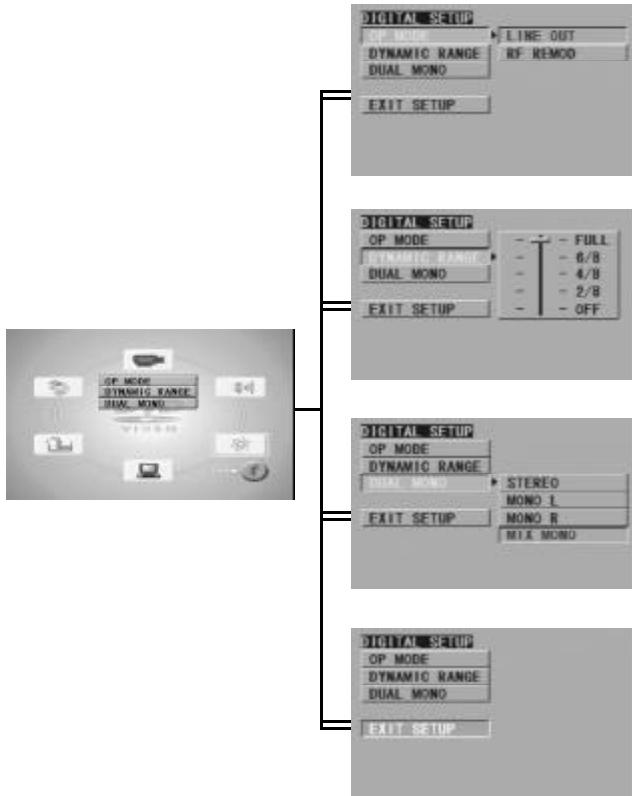

### OP MODE

Use "▲/▼" to select "LINE OUT" or "RF REMOD".

### DYNAMIC RANGE

Press "▲/▼" to adjust the linear compression rate of the signal.

### DUAL MONO

This is the output mode of the L and R signals of the set audio output. If it is set "MIX MONO", this function only works when the DVD is being played in 2 channel.

### EXIT SETUP

Return to the main setup page.

## Exit Setup Page



### EXIT SETUP MENU

Press "PLAY" to exit the Setup Menu.

## Appendix (Definition of Keywords)

### Angle

Recorded onto some DVD discs are scenes which have been simultaneously shot from a number of different angles (the same scene is shot from the front, from the left side, from the right side, etc.) With such discs, the ANGLE button can be used to view the scene from different angles.

### Chapter number

These numbers are recorded on DVD discs. A title is subdivided into many sections, each of which is numbered, and specific parts of video presentations can be searched quickly by using these numbers.

### DVD

This refers to a high-density optical disc on which high-quality pictures and sound have been recorded by means of digital signals. Incorporating a new video compression technology (MPEG II) and high-density recording technology, DVD enables aesthetically pleasing full-motion video to be recorded over long periods of time (for instance, a whole movie can be recorded.) DVD has a structure consisting of two 0.6mm thin discs that are adhered to each other. Since the thinner the disc, the higher the density at which the information can be recorded, a DVD disc has a greater capacity than a single 1.2mm thick disc. Since the two thin discs are adhered to each other, there is the potential to achieve double-sided play sometime in the future for even longer duration play.

### Subtitle

These are the printed lines appearing at the bottom of the screen that translate or transcribe the dialogue. They are recorded on DVD discs.

### Time number

This indicates the playing time that has elapsed from the start of a disc or a title. It can be used to find a specific scene quickly. (It may not work with some discs.)

### Title number

These numbers are recorded on DVD discs. When a disc contains two or more movies, these movies are numbered as title1, title2, etc.

### CSS

CSS stands for "Content Scramble System". It is the data scrambling method used to garble the content of a DVD disc. According to most sources, CSS was put into use for the purpose of ensuring that copyrighted material placed in this format would only be usable with licensed DVD playback mechanisms.

### Dolby Digital

Dolby Digital is an advanced form of digital audio coding that makes it possible to store and transmit high-quality digital sound far more efficiently than was previously possible. First used in movie theaters in 1992, it is the result of decades spent by Dolby Laboratories developing signal-processing systems that exploit the characteristics of human hearing.

### Dolby Digital 2 Channel

At the option of their producers, Dolby Digital programs can deliver surround sound with two discrete range channels-left and right .

## Free Manuals Download Website

<http://myh66.com>

<http://usermanuals.us>

<http://www.somanuals.com>

<http://www.4manuals.cc>

<http://www.manual-lib.com>

<http://www.404manual.com>

<http://www.luxmanual.com>

<http://aubethermostatmanual.com>

Golf course search by state

<http://golfingnear.com>

Email search by domain

<http://emailbydomain.com>

Auto manuals search

<http://auto.somanuals.com>

TV manuals search

<http://tv.somanuals.com>