

Kodak EasyShare CX7310 digital camera

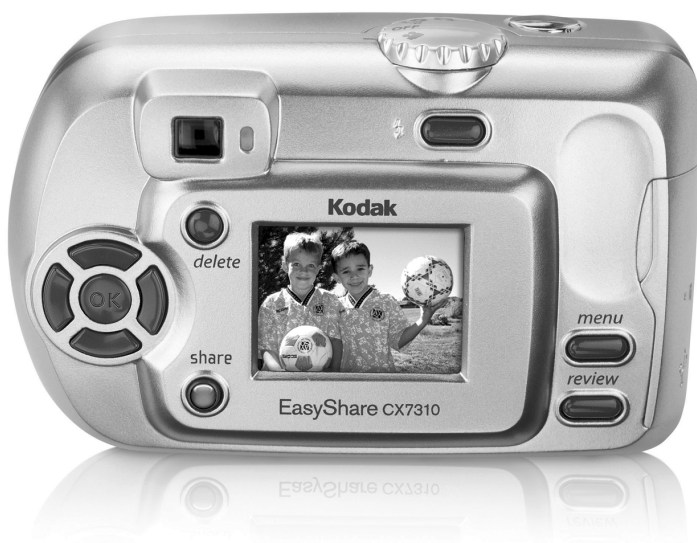

User's Guide

www.kodak.com

For interactive tutorials, www.kodak.com/go/howto

For help with your camera, www.kodak.com/go/cx7310support



Eastman Kodak Company

343 State Street

Rochester, New York 14650

© Eastman Kodak Company, 2004

All screen images are simulated.

Kodak and EasyShare are trademarks of Eastman Kodak Company.

P/N 4J1142

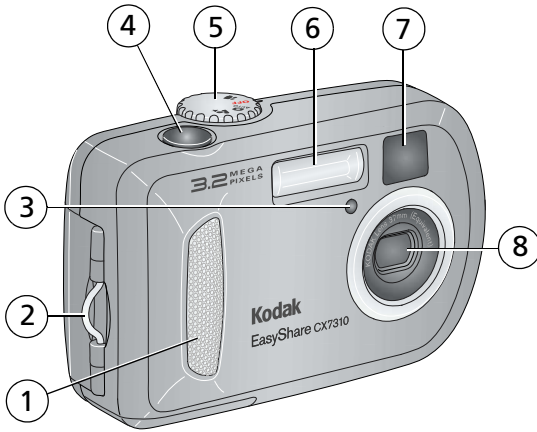

Front view

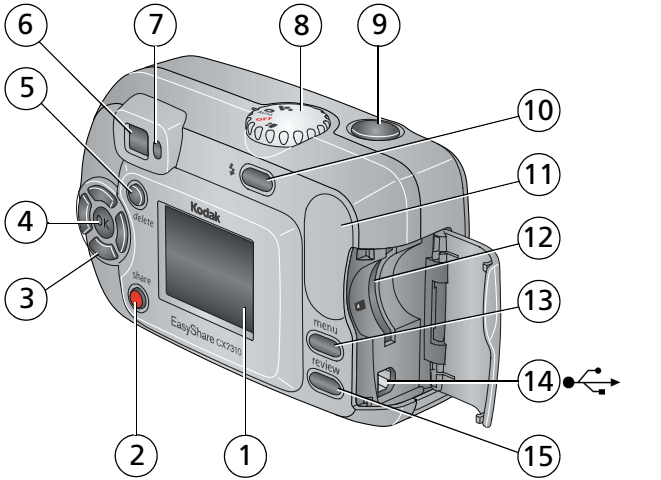

- | | |
|--------------------------|-------------------|
| 1 Grip | 5 Mode dial/Power |
| 2 Wrist strap post | 6 Flash unit |
| 3 Self Timer/Video light | 7 Viewfinder lens |
| 4 Shutter button | 8 Lens |

Back view



- | | | | |
|---|--|----|---|
| 1 | Camera screen
(LCD: liquid crystal display) | 8 | Mode dial/Power |
| 2 | Share button | 9 | Shutter button |
| 3 | Controller buttons (4)  | 10 | Flash/Status button |
| 4 | OK button | 11 | Grip |
| 5 | Delete button | 12 | Slot for optional SD/MMC card |
| 6 | Viewfinder | 13 | Menu button |
| 7 | Ready light | 14 | USB (Universal Serial Bus) port  |
| | | 15 | Review button |

Top and bottom views

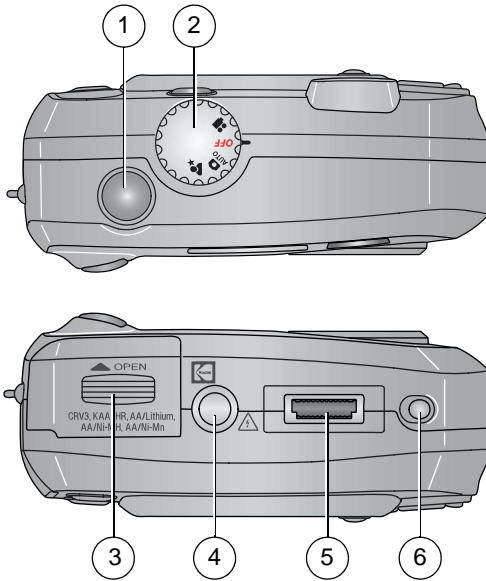

Top

- 1 Shutter button
- 2 Mode dial/Power

Bottom

- 3 Battery door
- 4 Tripod socket/locator for dock
- 5 Dock connector
- 6 Locator for dock

Table of contents

1 Getting started	1
Package contents	1
Installing the software first	1
Loading the batteries	2
Important battery information	3
Turning the camera on and off	4
Selecting a language	5
Setting the date and time	5
Checking camera and picture status	6
Storing pictures and videos on an SD/MMC card	7
2 Taking pictures and videos	8
Taking a picture	8
Taking a video	8
Using the camera screen as a viewfinder	9
Reviewing the picture or video just taken	9
Using digital zoom	10
Using the flash	11
Changing picture-taking settings	12
Putting yourself in the picture or video	13
Pre-tagging for album names	14
Customizing your camera	15
3 Reviewing pictures and videos	17
Viewing single pictures and videos	17
Viewing multiple pictures and videos	17
Playing a video	17
Deleting pictures and videos	18
Changing optional review settings	18
Magnifying pictures	19
Tagging pictures and videos for albums	19
Protecting pictures and videos from deletion	20
Running a slide show	20
Displaying pictures and videos on a television	21
Copying pictures and videos	22
Viewing picture and video information	22

4	Installing the software	23
	Minimum system requirements	23
	Install the software	23
5	Sharing pictures and videos	25
	Tagging pictures for printing.....	25
	Tagging pictures and videos for emailing	26
	Tagging pictures and videos as favorites	27
	Need help?	27
6	Transferring and printing pictures	28
	Transferring pictures and videos with the USB cable.....	28
	Printing pictures from your computer	28
	Ordering prints online	29
	Printing from an optional SD/MMC card	29
	Printing without a computer	29
7	Troubleshooting	30
	Camera problems.....	30
	Camera/computer communications.....	33
	Camera screen messages	34
	Camera ready light status.....	36
8	Getting help	37
	Helpful Web links	37
	Software help.....	37
	Telephone customer support	37
9	Appendix	39
	Camera specifications	39
	Tips, safety, maintenance	40
	Image storage capacities	41
	Power-saving features.....	42
	Upgrading your software and firmware.....	42
	Regulatory compliance	42

1 Getting started

Package contents

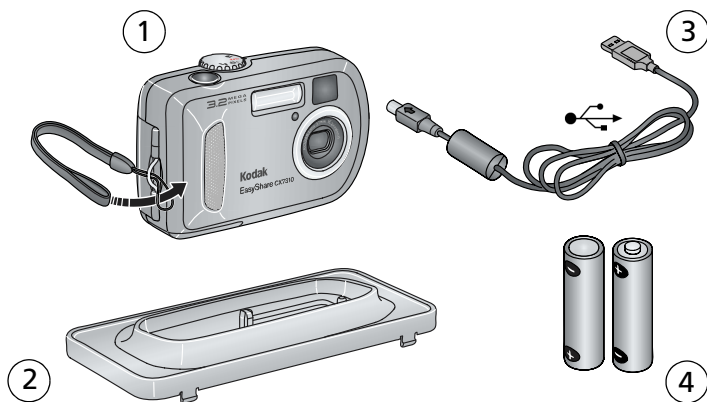

- 1 Camera and wrist strap
- 2 Custom dock insert (for compatible Kodak EasyShare camera dock or printer dock)
- 3 USB cable
- 4 2-AA non-rechargeable starter batteries

Not shown: Getting Started kit that includes User's Guide, Start Here! guide, Kodak EasyShare software CD. (In some countries, the User's Guide is provided on a CD. Contents may change without notice.)

Installing the software first

IMPORTANT: *Install the software from the Kodak EasyShare software CD before connecting the camera to the computer. Failure to do so may cause the software to load incorrectly. See [Installing the software, page 23](#) or the Start Here! guide included with the camera.*

Loading the batteries

Two AA non-rechargeable starter batteries are included with your camera. For information on approved battery types and extending battery life, see [page 3](#).

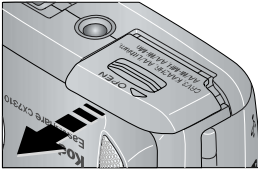

- 1 Make sure the Mode dial is set to Off (see [page 4](#)).
- 2 On the bottom of the camera, slide the battery door and lift to open.

AA

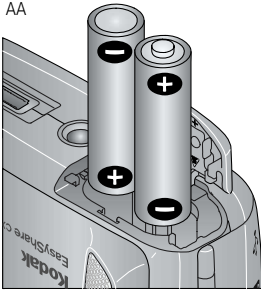

- 3 Insert the batteries, as shown.
- 4 Close the battery door.

Ni-MH Rechargeable Battery Pack (optional)

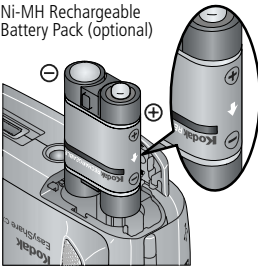

If you purchased an optional Kodak EasyShare Ni-MH rechargeable battery pack (also included with the Kodak EasyShare camera dock or printer dock), insert it as shown.

CRV3 (optional)

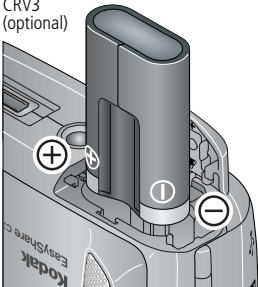

If you purchased an optional Kodak CRV3 lithium battery, insert it as shown.

Important battery information

Battery safety and handling

- Do not allow batteries to touch metal objects, including coins. Otherwise, a battery may short circuit, discharge energy, become hot, or leak.
- For rechargeable battery disposal information, visit the Rechargeable Battery Recycling Corporation Web site at www.rbrcc.com.

Kodak battery replacement types/battery life

Your camera can use the following types of batteries. Actual battery life may vary based on usage.

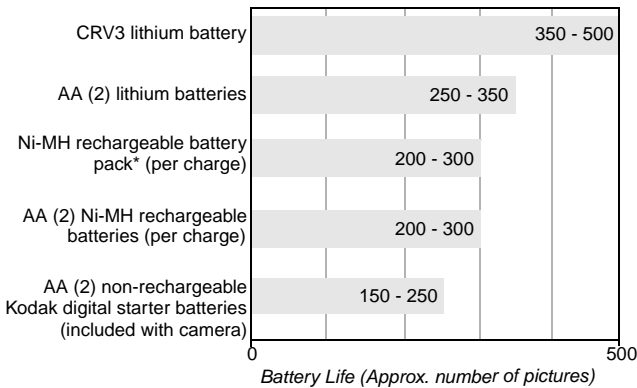

* Included with the Kodak EasyShare camera dock and printer dock

We do not recommend or support alkaline batteries. For acceptable battery life, and to make sure your camera operates dependably, use the replacement batteries listed above.

Extending battery life

- Limit the following activities that quickly deplete battery power:
 - Reviewing your pictures on the camera screen (see [page 17](#))
 - Using the camera screen as a viewfinder (see [page 9](#))
 - Excessive use of the flash

- Visit www.kodak.com/go/cx7310accessories for:

Kodak EasyShare camera dock—powers your camera, transfers pictures to your computer, and charges the included Kodak EasyShare Ni-MH rechargeable battery pack.

Kodak EasyShare printer dock—powers your camera, makes 4 x 6 prints with or without a computer, transfers pictures, and charges the included Kodak EasyShare Ni-MH rechargeable battery pack.

- Dirt on the battery contacts can affect battery life. Wipe the contacts with a clean, dry cloth before loading batteries in the camera.
- Battery performance is reduced at temperatures below 41° F (5° C). Carry spare batteries when using your camera in cold weather, and keep them warm. Do not discard cold batteries that do not work; when they return to room temperature, they may be usable.

For more information on batteries, visit

www.kodak.com/global/en/service/batteries/batteryUsage.jhtml.

Turning the camera on and off

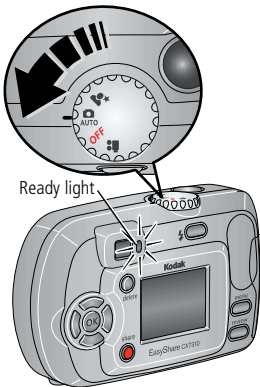

- Turn the Mode dial from Off to any other position.

The ready light blinks green while the camera performs a self-check, then glows green when the camera is ready.

- To turn off the camera, turn the Mode dial to Off.

The camera completes operations that are in process.

Changing the display

If you want to	Then do this
Turn the camera screen on or off.	Press the OK button.
Change the camera screen setting so that it is on whenever the camera is on.	See Liveview , page 15.
Show/Hide the status icons.	Press ▲.

Selecting a language

Selecting a language, first time

The Language screen is displayed the first time you turn on the camera.

- Press ▲/▼ to highlight a language, then press the OK button.

The Set Date & Time screen is displayed in the current language (see [Setting the date & time, first time](#)).

Selecting a language, anytime

- 1 In any mode, press the Menu button.
- 2 Press ▲/▼ to highlight Setup Menu ☰, then press the OK button.
- 3 Highlight Language ABC, then press the OK button.
- 4 Highlight a language, then press the OK button.
- 5 Press the Menu button to exit.

The text is displayed in the selected language.

Setting the date and time

Setting the date & time, first time

The *Date & Time have been reset* message appears after the Language screen the first time you turn on the camera. It may also appear if the batteries are removed for an extended time.

- 1 SET DATE & TIME is highlighted. Press the OK button.
(Select CANCEL to set the date and time at a later time.)
- 2 Go to Step 4 below, [Setting the date & time, anytime](#).

Setting the date & time, anytime

- 1 In any mode, press the Menu button.
- 2 Press ▲/▼ to highlight Setup Menu ☰, then press the OK button.
- 3 Highlight Date & Time, then press the OK button.
- 4 Press ▲/▼ to adjust the date and time. Press ◀/▶ to advance to the next setting.

5 When finished, press the OK button.

6 Press the Menu button to exit.

NOTE: Depending on your computer operating system, Kodak EasyShare software may update the camera clock when you connect the camera. See the Kodak EasyShare software Help for details.

Checking camera and picture status

The icons that appear on the camera screen indicate the active camera and picture settings.

If **i** is displayed in the status area, press the Flash/Status button to display additional settings.

Picture/video capture screens

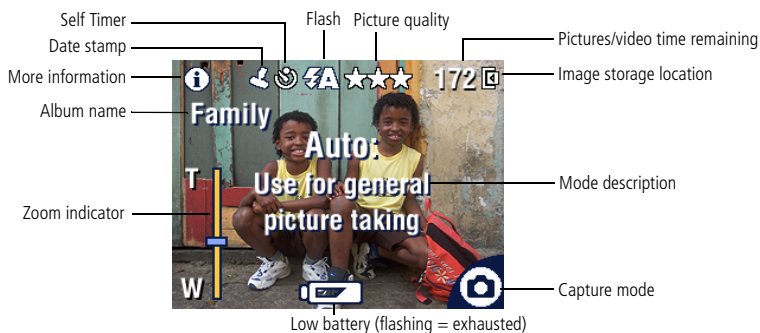

Review screen

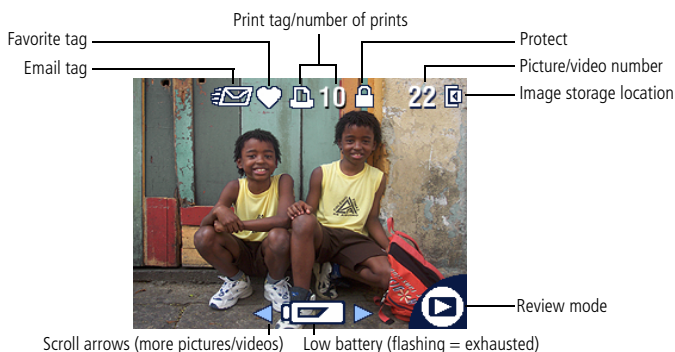

Storing pictures and videos on an SD/MMC card

Your camera has 16 MB of internal memory. You can purchase optional SD/MMC cards for removable, reusable image storage for pictures and videos. Purchase this and other accessories at a dealer of Kodak products. Visit www.kodak.com/go/cx7310accessories.



CAUTION:

Cards should only be inserted as explained below. If inserted incorrectly, the door won't close, and forcing it may damage the camera or card.

Do not insert or remove a card when the green ready light is blinking; doing so may damage your pictures, card, or camera.

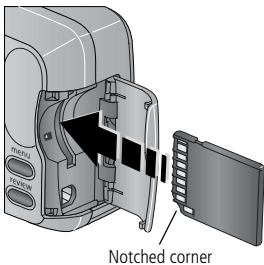

To insert an SD/MMC card:

- 1 Turn off the camera.
- 2 Open the card door.
- 3 Orient the card as shown.
- 4 Push the card into the slot to seat the connector.
- 5 Close the door.

To remove the card, turn off the camera, open the door, then pull the card out.

To set the image storage location, see [page 13](#). For SD/MMC card storage capacities, see [Image storage capacities, page 41](#).

2

Taking pictures and videos

The camera is ready to take pictures or videos when you turn it on—even if you are in Review, Share, or Setup.

Taking a picture

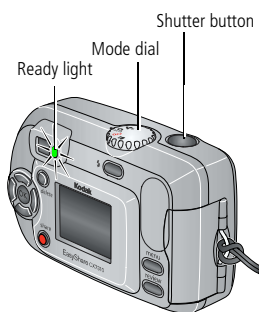

- 1 Turn the Mode dial to the Still mode you want to use:

 **Auto**—for general picture-taking.
AUTO Automatically sets exposure and flash.

 **Night**—for night scenes or low-light conditions. Place the camera on a flat, steady surface or use a tripod. Due to slow shutter speeds, advise people to stay still for a few seconds after flash fires.

- 2 Use the viewfinder or camera screen to frame your subject. (Press the OK button to turn the camera screen on. See [page 9](#).)
- 3 Press the Shutter button to take the picture.

When the ready light blinks green, the picture is being saved; you can still take pictures. If the ready light is red, wait until it turns green.

Taking a video

- 1 Turn the Mode dial to Video .
- 2 Use the viewfinder or camera screen to frame your subject.
- 3 Press the Shutter button and release. To stop recording, press the Shutter button again.

NOTE:

- You can also press the Shutter button **and hold it** for more than 2 seconds to begin recording. To stop recording, release the Shutter button.
- The camera does not record audio.
- Recording stops if image storage is full (see [Video storage capacity, page 42](#)).

Using the camera screen as a viewfinder

IMPORTANT: *The Liveview feature significantly depletes battery power; use it sparingly.*



OK button

- 1 Turn the Mode dial to any Still mode.
- 2 Press the OK button to turn on the camera screen.
- 3 Frame your subject in the camera screen.
- 4 Press the Shutter button to take the picture.
- 5 To turn off the camera screen, press the OK button.

To make the camera screen turn on whenever the camera is on, see [Liveview](#), page 15.

Reviewing the picture or video just taken

After you take a picture or video, the camera screen displays a Quickview for approximately 5 seconds. While the picture or video is displayed, you can:

- **Review:** If you take no action, the picture/video is saved.
- **Play (video):** Press the OK button to play the video.
- **Share:** Press the Share button to tag a picture/video for email, or as a Favorite, or to tag a picture for print (see [page 25](#)).
- **Delete:** Press the Delete button while the picture/video and  are displayed. Follow the prompts to delete the picture.

Using digital zoom

Use digital zoom in any Still mode to get up to 5X closer to your subject.

IMPORTANT: *You may notice a decrease in printed image quality when using digital zoom. The blue slider on the zoom indicator pauses, then turns red when the picture quality is less than 1 MP. For an acceptable 4 x 6 in. (10 x 15 cm) print, ensure that the slider remains blue.*



Zoom indicator

- 1 Press the OK button to turn on the camera screen, then press **▶** to activate digital zoom. *The camera screen displays the zoomed image and the zoom indicator.*
- 2 Press **◀ ▶** to zoom in or out (T - Telephoto or W - Wide).
- 3 Press the Shutter button to take the picture. To turn off digital zoom, from the lowest setting, press **◀**.

NOTE: You cannot use digital zoom for video recording.

Using the flash

Use the flash when you take pictures at night, indoors, or outdoors in heavy shadows. Flash is effective between 2.6 - 7.9 ft (0.8 - 2.4 m). You can only change the flash setting in Still modes.

Choosing a flash option

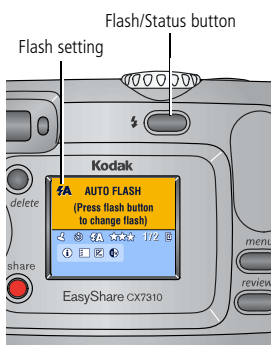

Press the  button repeatedly to scroll through the flash options.

The active flash icon is displayed in the camera screen status area (see [page 6](#)).

-  **Auto**—flash fires when the lighting conditions require it.
-  **Fill**—flash fires every time you take a picture, regardless of the lighting conditions. Use when the subject is in shadow or is "backlit" (when the sun is behind the subject).
-  **Red-eye**—flash fires so the subject's eyes become accustomed to the flash, then fires again when the picture is taken.
-  **Off**—flash never fires.



NOTE:

- Off and Fill flash options revert to Auto when the camera is turned off.
- When the picture is taken with Auto or Fill flash selected, the camera flashes twice: once to set the exposure and once to take the picture. When the picture is taken with Red-eye flash selected, the camera flashes three times: once to set the exposure, once to reduce red-eye, and once to take the picture.

Changing picture-taking settings

You can change settings to get the best results from your camera:

- 1 In any mode, press the Menu button.
- 2 Press $\blacktriangle/\blacktriangledown$ to highlight the setting you wish to change, then press the OK button.
- 3 Choose an option, then press the OK button.
- 4 Press the Menu button to exit.

Setting	Icon	Options
Self Timer Put yourself in the picture or video.		See page 13 .
Exposure Compensation (Still modes) Choose how much light enters the camera. <i>This setting remains until you change the Mode dial or turn off the camera.</i>		If pictures are too dark, increase the value. If pictures are too light, decrease the value.
Picture Quality (Still modes) Set picture resolution. <i>This setting remains until you change it.</i>		Best ★★★ (default) — (3.2 MP, low compression) for printing up to 11 x 14 in. (28 x 36 cm); produces highest picture resolution, more detail, and largest file sizes Best (3:2) ★★★ —(3.2 MP) ideal for printing 4 x 6 in. (10 x 15 cm) prints without cropping. Also for printing up to 11 x 14 in. (28 x 36 cm); some cropping may result. Better ★★ —(3.2 MP, high compression) for printing up to 8 x 10 in. (20 x 25 cm); pictures are high resolution with smaller file size. Good ★ —(0.8 MP) for emailing or screen display; pictures are lowest resolution with smallest file size.

Setting	Icon	Options
<p>Color Mode (Still modes) Choose color tones. <i>This setting remains until you change the Mode dial or turn off the camera.</i></p>		<p>Color (default)—for color pictures. Black & White—for black and white pictures. Sepia—for pictures with a reddish-brown, antique look.</p>
<p>Set Album Choose Album names.</p>		See page 14 .
<p>Video Length (Video mode) Choose the amount of recording time for videos. <i>This setting remains until you change it.</i></p>		<p>Maximum (default)—records up to 30 seconds or until image storage is full. Seconds—records for the specified time or until image storage is full. NOTE: If the current image storage location does not have adequate space, some video length options are not displayed. See page 42 for storage capacities.</p>
<p>Image Storage Choose an image storage location. <i>This setting remains until you change it.</i></p>		<p>Auto (default)—the camera uses the card if one is in the camera. If not, the camera uses internal memory. Internal Memory—the camera always uses internal memory, even if a card is installed.</p>
<p>Setup Menu Choose additional settings.</p>		See page 15 .

Putting yourself in the picture or video

The Self Timer creates a 10-second delay between the time you press the Shutter button and the time the picture or video is taken.

- 1 Turn the Mode dial to any Still mode for pictures, or to Video for videos, then press the Menu button.
- 2 Press / to highlight Self Timer , then press the OK button.
- 3 Highlight On, then press the OK button.
- 4 Press the Menu button to turn off the menu screen.

The Self Timer icon appears in the status area.

5 Place the camera on a flat surface or use a tripod.

6 Compose the scene.

Press the Shutter button, then move so that you are in the scene.

The Self Timer light blinks slowly for 8 seconds (then quickly for 2 seconds) before the picture is taken.

The Self Timer turns off after you take the picture or turn off the camera.

Pre-tagging for album names

Use the Set Album (Still or Video) feature to pre-select album names before you take pictures. Then, all the pictures or videos you take are tagged with those album names.

First—on your computer

Use Kodak EasyShare software, V 3.0 or higher (see [Installing the software, page 23](#)), to create album names on your computer, then copy up to 32 album names to the camera's internal memory. See the Kodak EasyShare software Help for details.

Second—on your camera

1 In any mode, press the Menu button.

2 Press ▲/▼ to highlight Set Album (Still or Video) , then press the OK button.

3 Highlight an album name, then press the OK button. Repeat to add pictures or videos to more than one album.

Selected albums are noted with a check mark.

4 To remove a selection, highlight the album name then press the OK button. To remove all album selections, select Clear All.

5 Highlight Exit, then press the OK button.

Your selections are saved. If you turn on the camera screen, your album selection is displayed on the screen. A plus (+) after the album name means more than one album is selected.

6 Press the Menu button to exit.

This setting remains until you change it.

Third—transfer to your computer







When you transfer the tagged pictures and videos to your computer, the Kodak EasyShare software opens and categorizes your pictures and videos in the appropriate album folder. See the Kodak EasyShare software Help for details.

Customizing your camera

Use the Setup Menu to customize your camera settings.

- 1 In any mode, press the Menu button.
- 2 Press / to highlight Setup Menu , then press the OK button.
- 3 Highlight the setting you wish to change, then press the OK button.
- 4 Choose an option, then press the OK button.
- 5 Press the Menu button to exit.

Setting	Icon	Options
Return Return to previous menu.		
Liveview Change camera screen setting so that it is always on or always off (see page 9). <i>This setting remains until you change it.</i>		On or Off.
Date & Time Set the date and time. <i>This setting remains until you change it.</i>		See page 5 .
Video Out Choose the regional setting that lets you connect the camera to a television or other external device. <i>This setting remains until you change it.</i>		NTSC (default) —used in most countries except those in Europe and China. North America and Japan use NTSC. PAL —used in Europe and China.

Setting	Icon	Options
Date Stamp (Still modes) Imprint the date on pictures. <i>This setting remains until you change it.</i>		Turn the Date Stamp on or off, or change the date stamp format.
Video Date Display (Video mode) Display capture date and time before the video starts. <i>This setting remains until you change it.</i>		Choose None, or choose a date and time format.
Language Display the camera screen text in different languages. <i>This setting remains until you change it.</i>		See page 5 .
Format Format camera memory.  CAUTION: Formatting deletes all pictures and videos, including those that are protected. Removing a card during formatting may damage the card.		Memory Card —deletes everything on the card; formats the card. Cancel —exits without making a change. Internal Memory —deletes everything in internal memory including email addresses, album names, and Favorites; formats the internal memory.
About Display camera model and firmware information.		





3

Reviewing pictures and videos

Press the Review button to view and work with your pictures and videos. To save battery power, place your camera in a compatible Kodak EasyShare camera dock or Kodak EasyShare printer dock (sold separately) to review pictures and videos.

Remember, press the Shutter button to take a picture anytime—even in Review.

Viewing single pictures and videos





- 1 Press the Review button.
- 2 Press /  to scroll backward or forward through pictures and videos. (For fast scrolling, press and hold / .
- 3 Press the Review button to exit.

NOTE: Pictures taken at the Best (3:2) quality setting are displayed at a 3:2 aspect ratio with a black bar at the top of the screen.



Viewing multiple pictures and videos

- 1 Press the Review button.
- 2 Press .

NOTE: You can also press the Menu button, highlight Multi-up , then press the OK button. *Thumbnails of nine pictures and videos are displayed at once.*

- Press /  to display the previous or next row of thumbnails.
 - Press /  to scroll through the thumbnails one at a time.
 - Press the OK button to display a single view of the selected picture.
- 3 Press the Review button to exit.

Playing a video

- 1 Press the Review button.
- 2 Press /  to locate a video (or highlight one in multiple view).

3 To play or pause a video, press the OK button.

NOTE: You can also press the Menu button, highlight Play Video , then press the OK button.

To rewind a video, press ◀ during playback. To replay the video, press the OK button.

To go to the previous or next picture or video, press ◀/▶.

4 Press the Review button to exit.

NOTE: The camera does not record audio; there is no sound during playback.

Deleting pictures and videos

1 Press the Review button.

2 Press ◀/▶ to locate a picture or video (or highlight one in multiple view), then press the Delete button.

3 Press ▲/▼ to highlight an option, then press the OK button:

PICTURE or VIDEO—deletes the displayed picture or video.

EXIT—exits the Delete screen.

ALL—deletes all pictures and videos from your current image storage location.











To view and delete other pictures and videos, press ◀/▶.

4 To exit, highlight Exit then press the OK button; or just press the Delete button again.

NOTE: You cannot delete protected pictures and videos in this manner. Remove protection before deleting (see [page 20](#)).

Changing optional review settings

In Review mode, press the Menu button to access optional review settings.



	Magnify (pictures) (page 19)		Slide Show (page 20)
	Play Video (page 17)		Copy (page 22)
	Album (page 19)		Multi-up (page 17)
	Protect (page 20)		Picture/Video Information (page 22)
	Image Storage (page 13)		Setup Menu (page 15)

Magnifying pictures

- 1 Press the Review button, then locate a picture.
- 2 To magnify at 2X, press the OK button. To magnify at 4X, press the OK button again.

NOTE: You can also press the Menu button, highlight Magnify , then press the OK button.

The picture is magnified. The magnification value is displayed.

- Press   to see different parts of the picture.
- Press the OK button to redisplay the picture at the 1X (original) size.
- Press  to locate a different picture.

- 3 Press the Review button to exit.



Tagging pictures and videos for albums

Use the Album feature in Review mode to tag the pictures and videos in your camera with album names.

First—on your computer

Use Kodak EasyShare software (V 3.0 or higher) to create album names on your computer, then copy up to 32 album names to the camera's internal memory. See the Kodak EasyShare software Help for details.

Second—on your camera

- 1 Press the Review button.
- 2 Press  to locate a picture, then press the Menu button.
- 3 Press  to highlight Album , then press the OK button.
- 4 Highlight an album, then press the OK button.

The album name appears with the picture. A plus (+) after the album name means the picture was added to more than one album.

To add other pictures to the same album, press  to scroll through the pictures. When the picture you want is displayed, press the OK button.

To add the pictures to more than one album, repeat step 4 for each album.

- 5 To remove a selection, highlight an album name, then press the OK button. To remove all album selections, select Clear All.

- 6 Highlight Exit, then press the OK button.

Your selections are saved.

- 7 Press the Menu button to return to Review mode.

Third—transfer to your computer

When you transfer the tagged pictures and videos to your computer, the Kodak EasyShare software opens and categorizes your pictures and videos in the appropriate album folder. See the Kodak EasyShare software Help for details.

Protecting pictures and videos from deletion

- 1 Press the Review button, then locate the picture or video to protect.

- 2 Press the Menu button.

- 3 Press / to highlight Protect , then press the OK button.

The picture or video is protected and cannot be deleted. The Protect icon appears with the protected picture or video.

- 4 To remove protection, press the OK button again.

- 5 Press the Menu button to exit.



CAUTION:

Formatting internal memory or SD/MMC card deletes all (including protected) pictures and videos. Formatting internal memory also deletes email addresses, album names, and Favorites. To restore them, see Kodak EasyShare software Help.

Running a slide show

Use the Slide Show to display your pictures and videos on the camera screen. To run a slide show on a television or on any external device, see [page 21](#).

Starting the slide show

- 1 Press the Review button, then press the Menu button.

- 2 Press / to highlight Slide Show , then press the OK button.

- 3 Highlight Begin Show, then press the OK button.

Each picture and video is displayed once, in the order in which you took them.

- 4 To cancel the Slide Show, press the OK button.

Changing the slide show display interval

The default interval setting displays each picture for 5 seconds. You can increase the display interval to up to 60 seconds.

- 1 On the Slide Show menu, press ▲/▼ to highlight Interval, then press the OK button.
- 2 Select a display interval. To scroll through the seconds quickly, press and hold ▲/▼.
- 3 Press the OK button.

The interval setting remains until you change it.

Running a continuous slide show loop

When you turn on Loop, the slide show is continuously repeated.

- 1 On the Slide Show menu, press ▲/▼ to highlight Loop, then press the OK button.
- 2 Highlight On, then press the OK button.

The slide show repeats until you press the OK button or until battery power is exhausted. This setting remains until you change it.

Displaying pictures and videos on a television

You can display pictures and videos on a television or any device equipped with a video input using a compatible Kodak EasyShare printer dock and an optional video cable (see the printer dock user's guide).

Purchase these and other accessories at a dealer of Kodak products.

Visit www.kodak.com/go/cx7310accessories.

Copying pictures and videos

You can copy pictures and videos from a card to internal memory or from internal memory to a card.

Before you copy, make sure that:

- A card is inserted in the camera.
- The camera's image storage location is set to the location **from** which you are copying. See [page 13](#).

Copy pictures or videos:

- 1 Press the Review button, then press the Menu button.
- 2 Press $\blacktriangle/\blacktriangledown$ to highlight Copy \blacktriangleright , then press the OK button.
- 3 Highlight an option, then press the OK button:
 - PICTURE or VIDEO**—copies the current picture or video.
 - EXIT**—returns to the Review menu.
 - ALL**—copies all pictures and videos from your selected image storage location to the other location.

NOTE:

- Pictures and videos are copied, not moved. To remove pictures and videos from the original location after they are copied, delete them (see [page 18](#)).
- Tags that you applied for print, email, and Favorites are not copied. Protection settings are not copied. To apply protection to a picture or video, see [page 20](#).

Viewing picture and video information

- 1 Press the Review button, then press the Menu button.
- 2 Press $\blacktriangle/\blacktriangledown$ to highlight Picture or Video Info, then press the OK button.
- 3 To view information on the next or previous picture or video, press $\blacktriangleleft/\blacktriangleright$.
- 4 Press the Menu button to exit.

4

Installing the software

Minimum system requirements

Windows OS-based computers

- Windows 98, 98SE, ME, 2000 SP1, or XP OS
- Internet Explorer 5.01 or higher
- 233 MHz processor or greater
- 64 MB RAM (128 MB RAM for Windows XP OS)
- 200 MB hard drive disc space available
- CD-ROM drive
- Available USB port
- Color monitor, 800 x 600 pixels (16-bit or 24-bit recommended)

Macintosh computers

- Power Mac G3, G4, G4 Cube, iMac; PowerBook G3, G4; or iBook computers
- Mac OS X 10.2.x
- 128 MB RAM
- 200 MB hard drive disc space available
- CD-ROM drive
- Available USB port
- Color monitor, 1024 x 768 pixels (thousands or millions of colors recommended)

NOTE: Mac OS 8.6 and 9.x do not support the Share button functions.
Mac OS X is recommended for full functionality.

Install the software

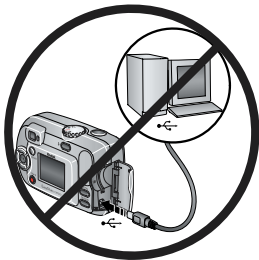

CAUTION:

Install Kodak EasyShare software before connecting the camera or optional camera dock to the computer. Failure to do so may cause the software to load incorrectly.

- 1 Close all software applications that are open on your computer (including anti-virus software).
- 2 Place the Kodak EasyShare software CD into the CD-ROM drive.

3 Load the software:

Windows OS-based computer—if the install window does not appear, choose Run from the Start menu and type **d:\setup.exe** where **d** is the drive letter that contains the CD.

Mac OS X—double-click the CD icon on the desktop, then click the Install icon.

Mac OS 8.6 or 9.x—on the install window, click Continue.

4 Follow the on-screen instructions to install the software.

Windows OS-based computer—select Complete to automatically install the most commonly used applications. Select Custom to choose the applications you wish to install.

Mac OS X—follow the on-screen instructions.

Mac OS 8.6 or 9.x—select Easy to automatically install the most commonly used applications.

NOTE: When prompted, take a few minutes to electronically register your camera and software.

This lets you receive information regarding software updates and registers some of the products included with the camera. You must be connected to your Internet service provider to register electronically. To register later, see www.kodak.com/go/register.



5 If prompted, restart the computer. If you turned off anti-virus software, turn it back on. See the anti-virus software manual for details.

For information on the software applications included on the Kodak EasyShare software CD, click the Help button in the Kodak EasyShare software.

5 Sharing pictures and videos







Press the Share button to "tag" your pictures and videos. When they are transferred to your computer, you can share using:



	Pictures	Videos
 Print (page 25)	✓	
 Email (page 26)	✓	✓
 Favorites (page 27), for easy organization on your computer and for sharing on your camera	✓	✓

NOTE: Tags remain until removed. If a tagged picture or video is copied, the tag is **not** copied.

Tagging pictures for printing

- 1 Press the Share button.
- 2 Press   to locate a picture.
- 3 Press   to highlight Print , then press the OK button.*
- 4 Press   to select the number of copies (0 - 99). The default is one. Zero removes the tag for that picture.**

The Print icon  appears in the status area.

5 Press the OK button.

6 Press the Share button to exit.

* To tag all pictures in the image storage location, highlight Print All , press the OK button, then select the number of copies as described above. Print All is not available in Quickview.

**To remove the print tagging for all pictures in the image storage location, highlight Cancel Prts , then press the OK button. You cannot cancel prints in Quickview.

Printing tagged pictures

When you transfer the tagged pictures to your computer, the Kodak EasyShare software print screen opens. For details, click the Help button in the Kodak EasyShare software.

For more information on printing from your computer or card, see [page 28](#).

NOTE: For the best 4 x 6 in. (10 x 15 cm) prints, set the camera to Best (3:2) picture quality (see [page 12](#)).

Tagging pictures and videos for emailing

First—on your computer

Use Kodak EasyShare software to create an email address book on your computer. Then, copy up to 32 email addresses to the camera's internal memory.

Second—tag on your camera

1 Press the Share button. Press  to locate a picture.

2 Highlight Email , then press the OK button.

3 Highlight an email address, then press the OK button.

To tag other pictures and videos with the same address, press  to scroll through the pictures. When the picture or video you want is displayed, press the OK button.

To send the pictures and videos to more than one address, repeat step 3 for each address.



Selected addresses are checked.

- 4 To remove a selection, highlight a checked address, then press the OK button. To remove all email selections, highlight Clear All.
- 5 Highlight Exit, then press the OK button.
Your selections are saved. The email icon  appears in the status area.
- 6 Press the Share button to exit.

Third—transfer and email

When you transfer the tagged pictures and videos to your computer, the Kodak EasyShare software email screen opens and lets you send the pictures and videos to the addresses you specified. For details, click the Help button in the Kodak EasyShare software.

Tagging pictures and videos as favorites

- 1 Press the Share button.
- 2 Press /▶ to locate a picture or video.
- 3 Press ▲/▼ to highlight Favorite , then press the OK button.
The Favorite icon  appears in the status area.
- 4 To remove the tag, press the OK button again.
- 5 Press the Share button to exit.

Using favorites on your computer

When you transfer Favorite pictures and videos to your computer, you can use Kodak EasyShare software to retrieve, organize, and label them by subject, date, event, or any category you choose. For details, click the Help button in the Kodak EasyShare software.

Need help?

Click the Help button in the Kodak EasyShare software for details on creating address books, and printing, emailing, and organizing tagged pictures on your computer.

6 Transferring and printing pictures



CAUTION:

Install Kodak EasyShare software before connecting the camera or optional camera dock or printer dock to the computer. Failure to do so may cause the software to load incorrectly.

Transferring pictures and videos with the USB cable

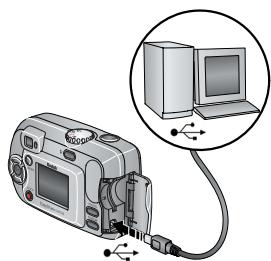

- 1 Turn off the camera.
- 2 Plug the labeled  end of the USB cable into the labeled USB port on your computer. See your computer user's guide for details.
- 3 Plug the other end of the USB cable into the labeled USB port on the camera.
- 4 Turn on the camera.

Kodak EasyShare software opens on your computer. The software prompts you through the transfer process.

NOTE:

- For a tutorial on connecting, see the Kodak EasyShare software CD, or visit www.kodak.com/go/howto.
- You can also use a Kodak multi-card reader or Kodak SD multimedia card reader-writer to transfer your pictures.

Printing pictures from your computer

For details on printing pictures from your computer, click the Help button in the Kodak EasyShare software.

Ordering prints online

Kodak EasyShare print service (provided by Ofoto at www.ofoto.com) is one of the many online print services offered in the Kodak EasyShare software. You can easily:

- Upload your pictures.
- Edit, enhance, and add borders to your pictures.
- Store pictures, and share them with family and friends.
- Order high-quality prints, photo greeting cards, frames, and albums—and have them delivered to your door.

Printing from an optional SD/MMC card

- Automatically print tagged pictures when you insert your card into a printer with an SD/MMC slot. See your printer user's guide for details.
- Make prints at an SD/MMC-capable Kodak picture maker. (Contact a location prior to visiting. Visit www.kodak.com/go/picturemaker.)
- Take the card to your local photo retailer for professional printing.

Printing without a computer

Dock your camera to a compatible Kodak EasyShare printer dock and print directly—without using a computer. Purchase this and other accessories at a dealer of Kodak products. Visit www.kodak.com/go/cx7310accessories.

7

Troubleshooting

When you have questions about your camera, start here. Additional technical information is available in the ReadMe file located on the Kodak EasyShare software CD. For updates to Troubleshooting information, visit www.kodak.com/go/cx7310support.

Camera problems

Problem	Cause	Solution
Camera does not turn on.	Batteries are not installed correctly.	Install new batteries (page 2) or charge rechargeable batteries.
Camera does not turn off.	Camera has locked up.	Remove the battery, then reinsert or replace it. If the camera still does not function, contact Customer Support (page 37).
Pictures remaining number does not decrease after taking a picture.	Picture does not take up enough space to decrease the number.	The camera is operating normally. Continue taking pictures.
Short battery life with Kodak EasyShare Ni-MH rechargeable batteries.	Dirt or oxidation on the battery contacts.	Wipe the contacts with a clean, dry cloth (page 3) before loading batteries in the camera.
Stored pictures are corrupted.	Card was removed or the batteries expired while the ready light was blinking.	Retake picture. Do not remove card while the ready light is blinking. Keep rechargeable batteries charged.
In Review mode, you do not see a picture (or the expected picture) on the camera screen.	Camera may not be accessing the correct image storage location.	Check the image storage location setting (page 13).

Problem	Cause	Solution
In Review mode, a blue or black screen is displayed instead of a picture.	File format is unrecognized.	Transfer the picture to the computer (page 28).
Shutter button does not work.	Camera is not turned on.	Turn on the camera (page 4).
	Camera is processing a picture; the ready light (near the viewfinder) is blinking red.	Wait until the ready light stops blinking red before attempting to take another picture.
	Card or internal memory is full.	Transfer pictures to the computer (page 28), delete pictures from the camera (page 18), switch image storage locations (page 13), or insert a card with available memory (page 7).
	Shutter button was not pressed.	For best pictures, see page 8.
Slide show does not run on external video device.	Video Out setting is incorrect.	Adjust the camera Video Out setting (NTSC or PAL, page 15).
	External device is set incorrectly.	See the external device's user's guide.
Picture is too light.	Subject was too close for flash.	Move so there is at least 2.6 ft (0.8 m) between camera and subject.
	Too much light.	Decrease Exposure Compensation (page 12).
Picture is not clear.	Lens is dirty.	Clean the lens (page 40).
	Subject too close when taking picture.	Move so there is at least 2.6 ft (0.8 m) between the camera and the subject.
	Subject or the camera moved while the picture was taken.	Place the camera on a flat, steady surface or use a tripod.

Problem	Cause	Solution
Picture is too dark or underexposed.	Flash is not on.	Turn on the flash (page 11).
	Subject is too far away for the flash to be effective.	Move so there is no more than 7.9 ft (2.4 m) between the camera and the subject.
	Subject is in front of a bright light (backlit).	Use Fill flash (page 11) or change your position so light is not behind the subject.
	Not enough light.	Increase Exposure Compensation (page 12).
Camera does not recognize SD/MMC card.	Card may not be SD/MMC certified.	Purchase a certified SD/MMC card.
	Card may be corrupt.	Reformat the card (page 16). Caution: Formatting a card deletes all pictures and videos, including protected files.
	Card is not properly inserted in camera.	Insert a card into the slot, then push to seat (page 7).
Camera freezes up when a card is inserted or removed.	Camera detected an error when the card was inserted or removed.	Turn the camera off, then back on. Make sure the camera is turned off before inserting or removing a card.
Memory card full	Storage is full.	Insert a new card (page 7), transfer pictures to the computer (page 28), or delete pictures (page 18).
	Maximum number of files or folders is reached (or other directory concern).	Transfer pictures to the computer (page 28), then format the card or internal memory (page 16). Caution: Formatting a card deletes all pictures and videos, including protected files.

Camera/computer communications

Problem	Cause	Solution
The computer cannot communicate with the camera.	There is a problem with the configuration of the USB port on the computer.	See this file on the EasyShare software CD: USB.html Or, visit www.kodak.com/go/camerasupport
	Camera power is off.	Turn on the camera (page 4).
	Batteries are exhausted or are not charged.	Install new batteries (page 2) or charge rechargeable batteries.
	Some Advanced Power Management utilities on laptops turn off ports to save battery life.	See the Power Management section of the laptop user's guide to disable this feature.
	USB cable is not securely connected.	Connect cable to camera and computer port (page 28).
	Software is not installed.	Install the software (page 23).
	Software is installed incorrectly.	Disconnect the USB cable. Close all open applications. Re-install the software (page 23).
	Too many applications are running on the computer.	Disconnect camera from the computer. Close all software applications, reconnect camera.
	The Battery Monitor or similar software runs constantly.	Close that software before starting the Kodak software.
Cannot transfer pictures. (The Add New Hardware Wizard cannot locate drivers.)	Software is not installed.	Disconnect USB cable. (If using camera dock or printer dock, disconnect cable and remove camera from dock). Close all open applications. Re-install the software (page 23).
	Software is installed incorrectly.	Disconnect the USB cable. Close all open applications. Re-install the software (page 23).

Camera screen messages

Message	Cause	Solution
No images to display	There are no pictures in the current image storage location.	Change image storage location setting (page 13).
Memory card requires formatting	Card is corrupted or formatted for another digital camera.	Insert a new card (page 7) or format the card (page 16). Caution: Formatting a card deletes all pictures and videos, including protected files.
Memory card cannot be read (Please format memory card or insert another card)		
Remove USB cable in camera Restart computer if needed	USB cable is connected to camera while docked.	Unplug the USB cable from the camera.
Internal memory requires formatting	Camera internal memory is corrupted.	Format the internal memory (page 16). Caution: Formatting deletes all pictures and videos, including protected files. (Formatting internal memory also deletes email addresses, album names, and Favorites. To restore them, see the Kodak EasyShare software Help.)
Internal memory cannot be read (Please format internal memory)		
No memory card (Files not copied)	There is no card in the camera. Pictures were not copied.	Insert a card (page 7).
Not enough space to copy files (Files not copied)	There is not enough space in the image storage location you are copying to (internal memory or the card).	Delete pictures from the image storage location you are copying to (page 18), or insert a new card (page 7).
Memory card is locked (Insert new memory card)	Card is write-protected.	Insert a new card (page 7) or change the image storage location to internal memory (page 13).
Read-only memory card, change to internal memory to capture		

Message	Cause	Solution
Memory card is unusable (Insert new memory card)	Card is slow, corrupted, or unreadable.	Insert a new card (page 7) or format the card (page 16). Caution: Formatting a card deletes all pictures and videos, including protected files.
Date and time have been reset	This is the first time you turned on the camera; or the batteries have been removed for an extended period of time; or the batteries are exhausted.	Reset the clock (page 5).
No address book on camera (Connect with computer to import address book)	No Email addresses appear because there is no address book.	Create and copy address book from computer. See the Kodak EasyShare software Help.
No album names on camera (Connect with computer to import album names)	Album names have not been copied to the camera from the computer.	Create and copy album names from computer. See the Kodak EasyShare software Help.
Can only mark image with 32 album names. Only the first 32 album names will be saved	The maximum number of album names (32) have been associated with an image. NOTE: Albums previously associated with an image persist even though they may not be contained in current album file on camera.	Delete one or more album names associated with the image (page 19).
High camera temperature. (Camera will be turned off.)	Internal temperature of the camera is too high for the camera to operate. The viewfinder light glows red and the camera turns off.	Leave the camera off until it's cool to the touch, then turn it back on. If the message reappears, contact Customer Support (page 37).
Unrecognized file format	Camera cannot read the picture format.	Transfer the picture to the computer (page 28), or delete it (page 18).

Message	Cause	Solution
Camera error #XXXX. See user's guide.	An error is detected.	Turn the Mode dial off, then back on. If the message reappears, contact Customer Support (page 37).

Camera ready light status

Status	Cause	Solution
Ready light does not turn on and the camera does not work.	Camera is not turned on.	Turn on the camera (page 4).
	Batteries are exhausted or are not charged.	Install new batteries (page 2) or charge rechargeable batteries.
	Mode dial was on when batteries were reloaded.	Turn Mode dial off, then back on.
Ready light blinks green.	Picture is being processed and saved to the camera.	Camera is operating normally.
Ready light blinks amber.	Flash is not charged.	Wait. Resume picture taking when the light stops blinking and turns green.
	Camera is initializing.	
Ready light blinks red and camera turns off.	Batteries are low or exhausted.	Install new batteries (page 2) or charge rechargeable batteries.
Ready light glows steady red.	Camera's internal memory or card is full.	Transfer pictures to the computer (page 28), delete pictures from the camera (page 18), switch image storage locations (page 13), or insert a card with available memory (page 7).
	Camera processing memory is full.	Wait. Resume picture taking when the light turns green.
	Card is read-only.	Change the image storage location to internal memory (page 13), or use a different card.
Ready light glows steady green.	Camera is on; ready to take a picture or video.	Camera is operating normally.

8

Getting help

Helpful Web links

Help with your camera	www.kodak.com/go/cx7310support
Help with Windows operating system and working with digital pictures	www.kodak.com/go/pcbasics
Download the latest camera software and firmware	www.kodak.com/go/cx7310downloads
Optimize your printer for truer, more vibrant colors	www.kodak.com/go/onetouch
Get support for cameras, software, accessories, more	www.kodak.com/go/support
Purchase camera accessories	www.kodak.com/go/cx7310accessories
Register your camera	www.kodak.com/go/register
View online tutorials	www.kodak.com/go/howto

Software help

Click the Help button in the Kodak EasyShare software. Also, see the tutorial on the CD for help with connecting your camera to a computer.

Telephone customer support

If you have questions concerning the operation of the software or camera, you may speak with a customer support representative.

Before you call

Have the camera, camera dock, or printer dock connected to your computer. Be at your computer, and have the following information available:

- Operating system
- Processor speed (MHz)
- Computer model
- Amount of memory (MB)
- Exact error message you received
- Version of Kodak EasyShare software CD
- Camera serial number

Australia	1800 147 701	Netherlands	020 346 9372
Austria	0179 567 357	New Zealand	0800 440 786
Belgium	02 713 14 45	Norway/Norge	23 16 21 33
Brazil	0800 150000	Philippines	1 800 1 888 9600
Canada	1 800 465 6325	Portugal	021 415 4125
China	800 820 6027	Singapore	800 6363 036
Denmark	3 848 71 30	Spain	91 749 76 53
Ireland	01 407 3054	Sweden	08 587 704 21
Finland	0800 1 17056	Switzerland	01 838 53 51
France	01 55 1740 77	Taiwan	0800 096 868
Germany	069 5007 0035	Thailand	001 800 631 0017
Greece	00800 441 25605	UK	0870 243 0270
Hong Kong	800 901 514	United States	1 800 235 6325
India	91 22 617 5823	Outside the United States	585 726 7260
Italy	02 696 33452	International Toll Line	+44 131 458 6714
Japan	03 5540 9002	International Toll Fax	+44 131 458 6962
Korea	00798 631 0024		

For the most up-to-date listings, visit:

<http://www.kodak.com/US/en/digital/contacts/DAllInternationalContacts.shtml>

9

Appendix

Camera specifications

Kodak EasyShare CX7310 digital camera		
Color	24-bit, millions of colors	
Color modes	Color, black & white, sepia	
Communication with computer	USB, via: USB cable; compatible EasyShare camera dock or printer dock	
Dimensions	Width	4.1 in. (103.5 mm)
	Depth	1.6 in. (40.2 mm)
	Height	2.6 in. (65 mm)
	Weight	5.2 oz (147 g) excluding batteries or card
File format	Still	JPEG/EXIF v2.2 Exif Print
	Video	QuickTime (CODEC: motion JPEG)
Flash	Modes	Auto, Fill, Red-eye, Off
	Range	2.6 - 7.9 ft (0.8 - 2.4 m) at ISO 140
	Charging Time	Less than 7 seconds with charged battery
Image Sensor	1/2.7 in. interline transfer CCD, 4:3 aspect ratio, 2.6 μ m square pixel, RGB Bayer CFA, 3.3 MP including optical black pixels	
ISO speed	Automatic: 100 - 200 (Still modes; 140 with flash); 100 - 800 (Video mode)	
Lens	Type	Combination glass/plastic with cover glass lens protection
	Aperture	f/4.5
	Focal Length	37 mm (35 mm equivalent)
	Focus Distance	Standard Wide: 2.6 ft (0.8 m) to infinity
Liquid Crystal Display, LCD (Camera screen)	1.5 in. (37 mm), color, 280 x 220 pixels Preview rate: 20 fps	
Operating Temperature	32 to 104 ^o F (0 to 40 ^o C)	

Kodak EasyShare CX7310 digital camera		
Picture/Video storage		16 MB internal; optional MMC or SD Card  (The SD logo is a trademark of the SD Card Association.)
Pixel resolution (by Quality setting)	Best - 3.2 MP, low compression	2080 x 1544, 1/8 JPEG compressed
	Best (3:2) - 2.8 MP, print optimized	2080 x 1368, 1/8 JPEG compressed
	Better - 3.2 MP, high compression	2080 x 1544, 1/10 JPEG compressed
	Good - 0.8 MP	1024 x 768, 1/8 JPEG compressed
Power	Battery	2-AA non-rechargeable starter batteries, 2-AA lithium, 2-AA Ni-MH, CRV3, Ni-MH rechargeable battery pack
Self Timer		10 seconds
Tripod socket		Yes
Video Out		NTSC or PAL selectable
Video resolution		320 x 240 pixels, 15 fps
Viewfinder		Reverse Galilean
White balance		Auto
Zoom (Still mode only)		5X digital

Tips, safety, maintenance

- Always follow basic safety precautions. Refer to the "Important Safety Instructions" booklet packed with your camera.
- Do not allow chemicals, such as suntan lotion, to come into contact with the painted surface of the camera.
- If the camera has been subjected to inclement weather or you suspect water has gotten inside the camera, turn off the camera and remove the batteries and card. Allow all components to air-dry for at least 24 hours before using the camera again. If this does not resolve the problem, contact customer support (see [page 37](#)).

- Clean the lens and camera screen:
 - 1 Blow gently on the lens or camera screen to remove dust and dirt.
 - 2 Wipe the lens or camera screen gently with a soft, lint-free cloth or an untreated lens-cleaning tissue.

Do not use cleaning solutions unless they are designed specifically for camera lenses. **Do not wipe the camera lens or camera screen with chemically treated eyeglass lens tissue. It may scratch the lens.**

- Wipe the outside of the camera with a clean, dry cloth. Never use harsh or abrasive cleaners or organic solvents on the camera or any of its parts.
- Connect a tripod directly to the camera; do not connect a tripod to the camera dock or printer dock.
- Service agreements are available in some countries. Contact a dealer of Kodak products for more information.
- For digital camera disposal or recycling information, contact your local authorities. In the US, visit the Electronics Industry Alliance Web site at www.eiae.org or visit Kodak at www.kodak.com/go/cx7310support.

Image storage capacities

Image file sizes can vary. You may be able to store more or fewer pictures and videos. Purchase SD/MMC cards and other accessories at a dealer of Kodak products. Visit www.kodak.com/go/cx7310accessories.

Picture storage capacity

	Approximate number of pictures			
	Best	Best (3:2)	Better	Good
	★★★	★★★	★★	★
16 MB internal memory	17	19	21	67
16 MB SD/MMC	20	23	25	76
32 MB SD/MMC	40	46	50	152
64 MB SD/MMC	80	92	100	304
128 MB SD/MMC	160	184	200	608

Video storage capacity

	Minutes/seconds of video
16 MB internal memory	46 sec.
16 MB SD/MMC	53 sec.
32 MB SD/MMC	1 min., 50 sec.
64 MB SD/MMC	3 min., 44 sec.
128 MB SD/MMC	7 min., 31 sec.

Power-saving features

If no activity for	The camera	To turn it back on
1 minute	screen turns off.	Press the OK button.
8 minutes	enters auto power off.	Press any button (or insert or remove a card).
3 hours	turns off.	Turn Mode dial Off, then back on.

Upgrading your software and firmware

Download the latest versions of the software included on the Kodak EasyShare software CD and the camera firmware (the software that runs on the camera). Visit www.kodak.com/go/cx7310downloads.

Regulatory compliance

FCC compliance and advisory



Kodak EasyShare CX7310 digital camera

This equipment has been tested and found to comply with the limits for a Class B digital device, pursuant to Part 15 of the FCC Rules. These limits are designed to provide reasonable protection against harmful interference in a residential installation.

This equipment generates, uses, and can radiate radio frequency energy and, if not installed or used in accordance with the instructions, may cause harmful interference to radio communications. However, there is no guarantee that interference will not occur in a particular installation.

If this equipment does cause harmful interference to radio or television reception, which can be determined by turning the equipment off and on, the user is encouraged to try to correct the interference by one or more of the following measures: 1) reorient or relocate the receiving antenna; 2) increase the separation between the equipment and the receiver; 3) connect the equipment to an outlet on a circuit different from that to which the receiver is connected; 4) consult the dealer or an experienced radio/TV technician for additional suggestions.

Any changes or modifications not expressly approved by the party responsible for compliance could void the user's authority to operate the equipment. Where shielded interface cables have been provided with the product or specified additional components or accessories elsewhere defined to be used with the installation of the product, they must be used in order to ensure compliance with FCC regulation.

Canadian DOC statement

DOC Class B compliance—This Class B digital apparatus complies with Canadian ICES-003.

Observation des normes-Class B—Cet appareil numérique de la classe B est conforme à la norme NMB-003 du Canada.

Index

A

- AA batteries
 - expected life, 3
 - installing, 2
- About, 16
- accessories
 - batteries, 2, 3
 - buying, 37
 - SD/MMC card, 7
- Album, 19
 - pre-tagging pictures/videos for, 14
- alkaline batteries, warning, 3
- auto
 - flash, 11
 - power-down, 42
- Auto mode, 8

B

- batteries
 - alkaline warning, 3
 - door, iii
 - expected life, 3
 - extending life, 3
 - installing, 2
 - safety and handling, 3
 - types, 3
- button
 - controller, ii
 - Delete, ii, 9
 - Flash/Status, ii, 6, 11
 - Menu, ii, 12
 - OK, ii, 4
 - Review, ii, 9, 17
 - Share, ii, 9, 25
 - shutter, i, 8

C

- cable
 - USB, 1, 28
 - video, 21
- camera screen
 - error messages, 34
 - Liveview, 9
 - Quickview, 9
 - reviewing pictures/videos, 17
 - status area, 6
 - status icons, 6
 - turning Liveview default on/off, 15
 - using as viewfinder, 9
- Canadian compliance, 43
- caring for your camera, 40
- clock, setting, 5, 15
- Color Mode, 13
- computer
 - connecting camera, 28
 - installing software, 23
 - system requirements, 23
 - transferring pictures to, 28
- contents, package, 1
- controller buttons, ii
- Copy, 22
- copying pictures/videos
 - card to memory, 22
 - memory to card, 22
 - to computer, 28
- CRV3 battery
 - expected life, 3
 - installing, 2
- customer support, 37

D

- date
 - displaying on video, 16
 - imprinting on pictures, 16
 - setting, 5, 15
- Date and Time, 15
- Date Stamp, 16
- Delete button, ii, 9
- deleting
 - during Quickview, 9
 - formatting precaution, 16
 - from internal memory, 18
 - from SD/MMC Card, 18
 - protected pictures/videos, 20
- digital zoom, 10
- disposal and recycling
 - of batteries, 3
 - of camera, 41
- dock
 - connector on camera, iii
 - locator holes for, iii
 - printer, 29
- downloading pictures, 28

E

- EasyShare software *See also* Kodak EasyShare software, 23
- emailing pictures/videos, 26
- error messages, 34
- Exposure Compensation, 12
- external video device
 - setting video out, 15
 - viewing pictures, videos, 21

F

- favorites, tagging, 27
- FCC compliance, 42
- fill flash, 11
- firmware
 - finding version on camera, 16
 - upgrading, 42

flash, i

- range, 11, 39
 - settings, 11
 - turning off, 11
 - using, 11
- Flash/Status button, ii, 6, 11
- focus distance, 39
- Format, 16
- formatting internal memory/card, 16

G

- grip, i, ii

H

- help
 - camera, 30
 - EasyShare software, 37
 - support, 37
 - troubleshooting, 30
 - web links, 37

I

- icons
 - camera screen, 6
 - Review menu, 18
 - Setup Menu, 15
 - Share menu, 25
- Image Storage, 13
 - capacities, 41
 - on SD/MMC card, 7
 - setting storage location, 13
- information
 - about camera, 16
 - about pictures/videos, 22
- installing
 - batteries, 2
 - SD/MMC card, 7
 - software, 23
- internal memory
 - formatting, 16
 - setting image storage location, 13
 - storage capacity, 41

K

- Kodak EasyShare software
 - getting help, 37
 - installing, 23
 - upgrading, 42
- Kodak web sites, 37

L

- Language, 16
 - setting, 5
- LCD (liquid crystal display). *See* camera screen
- lens, i
 - cleaning, 41
- light
 - ready, ii, 36
 - Self Timer, i, 13
 - video, i
- lithium batteries, expected life, 3
- Liveview, 15
 - turning default on/off, 15
 - using, 9
- loading
 - batteries, 2
 - SD/MMC card, 7
 - software, 23

M

- Macintosh OS
 - installing software on, 23
 - system requirements, 23
- Magnify, 19
- maintenance, camera, 40
- memory
 - inserting card, 7
 - internal, 13
 - removable card, 13
 - setting image storage
 - location, 13
 - storage capacities, 41

Menu

- button, ii, 12
- review mode, 18
- Setup Menu, 15
- Share, 25

MMC card

- formatting, 16
- inserting, 7
- printing from, 29
- setting image storage
 - location, 13
- slot, ii
- storage capacities, 41

mode dial, i

- using, 8

modes

- Auto, 8
- Night, 8
- Video, 8

movies. *See* videos**multiple pictures/videos, viewing, 17****Multi-up, 17****N**

- Night mode, 8
- Ni-MH rechargeable batteries
 - expected life, 3
 - installing (battery pack), 2
- NTSC, video out setting, 15, 21

O

- OK button, ii, 4
- online prints, ordering, 29

P

- package contents, 1
- PAL, video out setting, 15, 21
- Picture Quality, 12

- pictures
 - changing picture-taking settings, 12
 - checking settings, 6
 - copying, 22
 - deleting, 18
 - emailing tagged, 26
 - magnifying, 19
 - printing from computer, 28
 - printing tagged, 25
 - protecting, 20
 - reviewing, 17
 - storage capacity, 41
 - tagging, 14, 19
 - taking, 8
 - transferring to computer, 28
 - viewing multi-up, 17
 - viewing on television, 21
- Play Video, 17
- power
 - auto off, 42
 - camera, 4
 - switch, i
- printer dock, 29
- printing
 - from a card, 29
 - from computer, 28
 - optimizing printer, 37
 - order online, 29
 - tagged pictures, 25, 29
 - without computer, 29
- protecting pictures/videos, 20
- Q**
- Quickview, 9
- R**
- ReadMe file, 30
- ready light, ii, 36
- recycling and disposal
 - of batteries, 3
 - of camera, 41
- red-eye flash, 11
- regulatory information, 42
- requirements, system, 23
- Return, 15
- Review button, ii, 9, 17
- reviewing pictures/videos
 - as a slide show, 20
 - as you take them, 9
 - deleting, 18
 - in multiples (Multi-up), 17
 - magnifying, 19
 - menu options, 18
 - on camera screen, 17
 - protecting, 20
- S**
- safety, 40
- screen, camera. See camera screen
- SD/MMC card
 - formatting, 16
 - inserting, 7
 - printing from, 29
 - setting image storage location, 13
 - slot, ii
 - storage capacities, 41
- Self Timer, 12
 - light, i
 - using, 13
- service and support, telephone numbers, 37
- Set Album, 13
- setting
 - album, 13, 14
 - color mode, 13
 - date stamp, 16
 - date/time, 5, 15
 - exposure compensation, 12
 - flash, 11
 - image storage location, 13
 - language, 5, 16
 - Liveview, 15

- picture quality, 12
- review menu options, 18
- Self Timer, 13
- video length, 13
- video out, 15
- Setup Menu, 15
- Share
 - button, ii, 9, 25
 - menu, 25
- shutoff, auto, 42
- shutter button, i
 - Self Timer delay, 13
 - using, 8
- shutter, problems, 31
- sleep mode, 42
- Slide Show, 20
 - changing display time, 21
 - continuous loop, 21
 - problems, 31
 - viewing on camera, 20
 - viewing on television, 21
- software
 - getting help, 37
 - installing, 23
 - upgrading, 42
- specifications, camera, 39
- status
 - camera ready light, 36
 - checking on screen, 6
 - screen icons, 6
- storage capacities
 - battery, 3
 - internal memory/card, 41
- support, technical, 37
- system requirements, computer, 23
- T**
 - tagging
 - favorites, 27
 - for albums, 14, 19
 - for email, 26
 - for print, 25
 - when to tag, 25
 - taking pictures, 8
 - taking videos, 8
 - television, displaying pictures/videos
 - on, 21
 - time, setting, 5, 15
 - timer, self (shutter delay), 13
 - tips
 - battery, 3
 - maintenance, 40
 - ReadMe file, 30
 - safety, 40
 - transferring pictures, 28
 - trash can, deleting, 9
 - tripod socket, iii
 - troubleshooting
 - camera, 30
 - camera/computer
 - communications, 33
 - error messages, 34
 - ready light status, 36
 - turning camera on/off, 4
- U**
 - upgrading software, firmware, 42
 - URLs, Kodak web sites, 37
 - USB cable
 - camera port, ii
 - connecting camera and
 - computer, 28
 - transferring pictures, 28
- V**
 - Video Date Display, 16
 - Video Length, 13
 - Video mode, 8
 - Video Out, 15
 - videos
 - checking settings, 6
 - copying, 22
 - deleting, 18

- display date on, 16
- emailing tagged, 26
- protecting, 20
- record light, i
- reviewing, 17
- setting recording time, 13
- storage capacities, 41
- tagging, 14
- taking, 8
- transferring to computer, 28
- viewing on television, 21
- viewfinder, ii
 - lens, i
 - using camera screen as, 9
- viewing
 - camera information, 16
 - magnified picture, 19
 - picture/video information, 22
 - picture/video just taken, 9
 - pictures/videos, 17
 - pictures/videos on television, 21
 - slide show, 20

W

- Windows OS
 - installing software on, 23
 - system requirements, 23
- wrist strap post, i

Z

- zoom, digital, 10

Free Manuals Download Website

<http://myh66.com>

<http://usermanuals.us>

<http://www.somanuals.com>

<http://www.4manuals.cc>

<http://www.manual-lib.com>

<http://www.404manual.com>

<http://www.luxmanual.com>

<http://aubethermostatmanual.com>

Golf course search by state

<http://golfingnear.com>

Email search by domain

<http://emailbydomain.com>

Auto manuals search

<http://auto.somanuals.com>

TV manuals search

<http://tv.somanuals.com>