

# JVC

## MEMORY CAMERA

---

# GZ-MS110 Detailed User Guide



## Everio

LYT2228-001A

## Contents

### Beginner's Guide ..... 4

Charging .....	4
Recording .....	4
Playback .....	4
Shooting Tips .....	4

### Useful Shooting Techniques

Holiday Season/Christmas .....	5
Wedding .....	6
Travel .....	7
Amusement Park .....	9

### Getting Started

Verifying the Accessories .....	10
Charging the Battery Pack .....	11
Grip Adjustment .....	12
Using the Hand Strap .....	12
Inserting an SD Card .....	12
Types of Usable SD Card .....	13
Clock Setting .....	13
Resetting the Clock .....	14
Changing the Display Language .....	15
Holding this Unit .....	15
Tripod Mounting .....	15
Using this Unit Overseas .....	16
Charging the Battery Pack Overseas .....	16
Setting the Clock to Local Time when Traveling .....	16
Setting Daylight Saving Time .....	17
Optional Accessories .....	17

### Recording

Taking Videos in Auto Mode .....	18
Zooming .....	19
Manual Recording .....	19
Scene Selection .....	20
Adjusting Focus Manually .....	21
Adjusting Brightness .....	22
Setting Shutter Speed .....	23
Setting White Balance .....	24
Setting Backlight Compensation .....	24
Setting Metering Area .....	25
Taking Close-up Shots .....	25
Recording at Intervals (TIME-LAPSE RECORDING) .....	26
Recording Automatically by Sensing Movements (AUTO REC) .....	28
Remaining Recording Time/Battery Power .....	29

### Playback

Playing Back Videos .....	30
Playing a Video with Defective Management Information .....	31
Searching for a Specific Video Image .....	31
Connecting to and Viewing on TV .....	32

### Editing

Deleting Unwanted Files .....	33
Deleting the Currently Displayed File .....	33
Deleting Selected Files .....	33
Deleting All Files .....	34
Protecting Files .....	35
Protecting the Currently Displayed File .....	35
Protecting Selected Files .....	36
Protecting All Files .....	36
Releasing Protection of All Files .....	37

### Copying

Dubbing Files to a DVD Recorder or VCR .....	37
Copying to Windows PC .....	38
Verifying System Requirements (Guideline) .....	38
Installing the Provided Software .....	38
Backing Up All Files .....	39
Organizing Files .....	40
Recording Videos to Discs .....	40
JVC Software Licence Agreement .....	41
Backing Up Files Without Using Provided Software .....	42
List of Files and Folders .....	43
Copying to Mac Computer .....	43

### Menu Settings

Operating the Menu .....	45
Recording Menu .....	46
VIDEO QUALITY .....	47
ZOOM .....	47
DIS .....	48
GAIN UP .....	48
TIME-LAPSE RECORDING .....	49
AUTO REC .....	49
SELECT ASPECT RATIO .....	49
WIND CUT .....	49
Manual Settings Menu .....	50
SCENE SELECT .....	50
FOCUS .....	50
BRIGHTNESS ADJUST .....	50
SHUTTER SPEED .....	50
WHITE BALANCE .....	50
BACKLIGHT COMP. .....	50
METERING AREA/TYPE .....	50
TELE MACRO .....	50
Playback Menu .....	51
DELETE .....	51
SEARCH .....	51
PLAYBACK MPG FILE .....	51
PROTECT/CANCEL .....	51
ON-SCREEN DISPLAY .....	51
Display Settings Menu .....	52
LANGUAGE .....	52
DATE DISPLAY STYLE .....	52
MONITOR BRIGHTNESS .....	53
LCD BACKLIGHT .....	53
CLOCK ADJUST .....	53
Basic Settings Menu .....	54
DEMO MODE .....	55
AUTO POWER OFF .....	55
OPERATION SOUND .....	56
QUICK RESTART .....	56
UPDATE .....	57
FACTORY PRESET .....	57
Connection Settings Menu .....	58
DISPLAY ON TV .....	58
VIDEO OUTPUT .....	58
FORMAT SD CARD .....	59

### Name of Parts

Front .....	60
Rear .....	60
Bottom .....	61
Interior .....	61

### Indications on the LCD Monitor

Recording .....	62
Playback .....	62

### Troubleshooting

Battery Pack .....	63
--------------------	----

---

Recording .....	63
Card .....	63
Playback .....	63
PC .....	63
Screen/Image .....	64
Other Problems .....	64
Error Message? .....	65

---

**Maintenance .....** 66

---

**Specifications .....** 67

### Charging

- Refer to the operating instructions found in the animation on the Detailed User Guide.

### Recording

- Refer to the operating instructions found in the animation on the Detailed User Guide.

### Playback

- Refer to the operating instructions found in the animation on the Detailed User Guide.

### Shooting Tips

#### Basic Way to Hold a Camcorder ~ Recording Stable Images ~



This is the standard way of shooting while standing up. Be sure to master this basic technique in order to achieve stable images.

#### ■ [Getting Ready]

- ① Open your feet to the width of your shoulders.
- ② Keep the elbow of your right arm, which is holding the camcorder, close to your side.
- ③ Hold the LCD monitor with your left hand and adjust the angle accordingly.

#### Extending Your Hands to Shoot ~ High-Angle Shooting ~



Extend your hand when your subject is being hidden behind a crowd of people.

#### ■ [Getting Ready]

- ① Open your feet to the width of your shoulders.
- ② Extend your right hand and hold the camcorder over your head.
- ③ Hold the LCD monitor with your left hand and adjust the angle accordingly.

#### CAUTION:

- Use this way of shooting only as a last resort as it is difficult to achieve stable images.
- Set to the wide angle as much as possible as the image will be prone to camera shake.
- Be considerate. Do not inconvenience the people around you.

#### Squatting and Shooting at Eye Level



Staying low is a common position to take when shooting small children. By recording from the eye level of the child, you can capture all his cute expressions clearly.

#### ■ [Getting Ready]

- ① Kneel down with your left knee while keeping your right foot on the ground.
- ② Place the elbow of your right arm, which is holding the camcorder, on your right knee.
- ③ Hold the LCD monitor with your left hand and adjust the angle accordingly.

#### Panning

- Refer to the operating instructions found in the animation on the Detailed User Guide.  
Use this method to shoot a wide angle of view.

#### ■ [Getting Ready]

Shoot by rotating your body instead of moving your arms while keeping the basic way of holding a camcorder as stated above.

- ① Stand facing the direction where the rotation will stop.
- ② Twist your upper body to the direction where recording will start.
- ③ Press the start button and record for 2 seconds, then slowly twist back your body to face the front.  
Record for another 2 seconds while facing the front, then press the stop button.  
(The 90 degrees rotation should take about 5 seconds, giving the feeling of a slow motion.)

## Holiday Season/Christmas

Record the happy Christmas celebration with your family!



### Decorating the Tree and Preparing the Dinner

The decoration of tree and preparation of dinner are part of the joy of Christmas. Be sure to record these happy family times!

#### ■ Decorating the tree



A tree is the most important thing to bring out the mood of Christmas. Simply the scene of all family members engaging in the decorating of a fir tree with various colorful ornaments is full of the feeling of happiness.

#### ■ Preparing the Dinner



Record the scenes as everyone helps to prepare the feast of the night. You can film the mother who is cooking, the children who are helping, and of course, the process of making a cake!

### Recording the Christmas Party

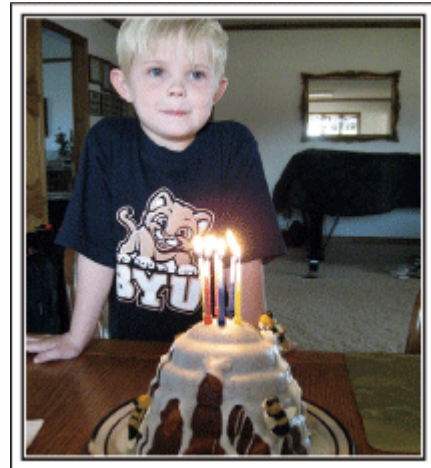

After all preparations, it is finally the Christmas party itself. Not only should you record the candle-blowing scene, but also the smiles of the family while being surrounded by good food, or even the father who is slightly drunk from champagne!

### Finding the Presents



For children, the greatest joy of Christmas is receiving presents the next morning.

Their expression of delight when finding a present next to their pillow is a recording opportunity not to be missed. Get ready to shoot before the children wake up!

### Wedding

Create an awesome wedding video for the bride and groom!



#### Discussing and Planning Before the Event

Before the day of the wedding reception, it is important to discuss with the bride and groom about various details such as the order of the ceremony and whether there are any entertainment programs or change of clothes.

By understanding the preferences of the bride and groom, you will be able to shoot more appropriately.

#### Finding the Right Angle to Capture Both Bride and Groom

The main characters of a wedding are of course the bride and groom. Record their expressions clearly during the toast, speech, entertainment programs, and other scenes.

Another recommendation is to capture the face shots of the guests, then pan towards the groom. Picture composition containing the crowd of guests only lacks fun, so be sure to pay attention to the shooting angle and size.

- **Composing the picture with the guests in front and the bride and groom at the back**



#### Recording the Expressions and Comments of Guests

You can record comments from the guest by going around asking, "Please say a few words for the bride and groom".

This can be done at the guests' waiting room, when the bride and groom are changing, or during the entertainment programs.

- **Setting the shot from eye level to chest level**



#### Closing Up on the Bride's Face During the Thank You Speech

The climax of the event finally comes during the bride and groom's thank you speech and presentation of flowers. The touching words of apprecia-

tion from the bride and tears of joy from the parents are scenes that must not be missed.

Start by closing up on the bride's face using zoom. As the tears start to form in the bride's eyes, continue shooting for a little longer. Then, slowly zoom out to the wide angle to show the parents who are moved by the speech.

#### Advanced Operation with Two Camcorders

If video-editing is to be done, record using two camcorders so that a video with varying scenes can be created. You can try asking a close friend who has a camcorder at home.

Set the borrowed camcorder on a tripod to focus on taking close-up shots of the bride and groom. In this way, the other camcorder can be moved around to record other scenes, enabling an interesting video with changing scenes to be created through editing and compilation.

As most people own at least a digital camera nowadays, even if you are really unable to find an extra camcorder, inserting still pictures to the video at various points is also a good way to add variety. Do give it a try!

- **<Camcorder 1>**  
**Closing up on the bride and groom all the time**

- **<Camcorder 2>**  
**Recording the congratulatory messages from friends at the same time**



## Travel

Capture all the good times of your domestic or overseas trips!



### Bringing the Necessary Equipment

The necessary things to bring on a trip depends on your traveling purpose and the destination. For overseas trips in particular, you have to think about what to bring in accordance to the local conditions. Here are some suggestions for your consideration.

#### ■ Camcorder

Think about how many hours of shooting you will usually perform in a day. Be sure to prepare enough recording medium especially for long overseas trips. If you are recording in SD cards, get ready the sufficient number of cards, including some for backup.

#### ■ Battery Pack

Prepare a battery pack that is ready for double the expected recording time in a day. For example, if you plan to record for 2 hours a day, prepare a battery pack that is ready for 4 hours (actual recording time). For a day trip, you can prepare a battery with low capacity but for a long trip, do prepare a few batteries with high capacities.

#### ■ AC Adapter

The JVC AC adapter supports voltages from 100 V to 240 V, and hence can be used anywhere in the world. Bring along the adapter if you are traveling for a long time. Charge the battery pack while sleeping so that you can record with full battery power the next day.

#### ■ Power Plug Adapter



The shape of the power plug varies according to countries. Be sure to check the shape of the power plug beforehand, and bring the appropriate power plug adapter.

"Charging the Battery Pack Overseas" (P.16)

#### ■ Battery Charger



Recording cannot be performed when an AC adapter is connected to the camcorder for battery charging. You can bring an additional battery charger to charge battery packs if you plan to use the camcorder for recording at night. You can also charge multiple battery packs by using both the battery charger and this camcorder at the same time.

#### ■ Tripod



A tripod is an essential item to take stable images. Select an appropriate tripod in accordance to your purpose and style of traveling, such as a compact one to be used on a table or one that is at least 1 m tall.

### Recording the Excitement Before Departure

It may be a little abrupt to start your travel video at the destination suddenly.

Record also the preparations prior to departure if it is a family trip, or the time when everyone is gathered at the meeting place if you are traveling with your friends.

For overseas trips, taking a shot of the signs and displays at the airport of the flight you are taking may be useful for future reference.



### Using Pan at the Places of Interest

Tourists spots with beautiful scenery or historical sites are places that you would certainly want to record.

To capture the magnificence of a scene which cannot be fitted into a single frame, try the panning technique.

Refer to the "Shooting Tips" found in this website on how to use panning effectively.

In addition, you may also like to take a shot of the signs or monuments that can often be found at the tourist spots.



### Showing Everyone Having a Good Time

When taking a video, it is rather dull to shoot only the scenery or historical sites.

Talk about your feelings while recording the breath-taking scenery of an attraction so that it will be an interesting scene to view later.



## Amusement Park

Take more shots of the smiling faces of everyone in the family!



## Taking Videos of Moving Subjects



Scenarios with changes in body movement are suitable for taking videos. This includes situations where there are rapid changes in facial expressions or voices of surprise and delight.

\*Some amusement parks do not allow passengers to perform any recording. Be sure to check beforehand.

[Examples]

Merry-go-round, go kart, coffee cup, etc.

## Inducing Responses by Calling Out



Videos with no waving of hands nor laughter are not only dull when you view them later, but also put the capability of the audio-recording function of the camcorder to a waste.

When recording, induce more reactions by enthusiastically waving your hands or shouting out "Is it fun?" and the like.

## Advanced Operation with Backlight Compensation

It is useful to make use of backlight compensation when the subject's face is in backlight or when the expression cannot be seen clearly. Increase the brightness of the whole image by setting "BACKLIGHT COMP." if the faces appear too dark. Even the expressions of faces under shadows can be captured brightly and clearly.

"Setting Details" (P.24)

### ■ <Without backlight compensation>







### ■ <With backlight compensation>

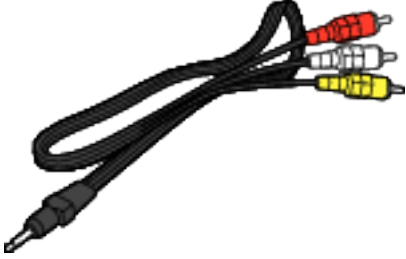

## Verifying the Accessories

If any of the items are missing or defective, consult your JVC dealer or the nearest JVC service center.

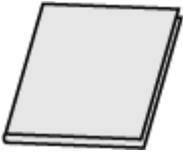
Illustration	Description
	<p>AC Adapter AP-V30U</p> <ul style="list-style-type: none"> <li>Connects to this unit to charge the battery pack. It can also be used when recording or playing back videos indoors.</li> </ul>
	<p>Battery Pack BN-VG107U</p> <ul style="list-style-type: none"> <li>Attaches to this unit to supply power.</li> </ul>
	<p>AV Cable</p> <ul style="list-style-type: none"> <li>Connects this unit to a TV to play back recorded images on the TV.</li> </ul>
	<p>USB Cable (Type A - Mini Type B)</p> <ul style="list-style-type: none"> <li>Connects this unit to a PC.</li> </ul>
	<p>CD-ROM</p> <ul style="list-style-type: none"> <li>For installing the provided software "Everio MediaBrowser" on a PC.</li> </ul>
	<p>Basic User Guide</p> <ul style="list-style-type: none"> <li>Read well and keep in a safe place where it can be accessed easily when necessary.</li> </ul>

### NOTE:

SD cards are sold separately.

"Types of Usable SD Card" (P.13)

When using the AC adapter overseas, please prepare a commercially available converter plug for the country or region of visit.

"Charging the Battery Pack Overseas" (P.16)

## Charging the Battery Pack

Charge the battery pack immediately after purchase and when the remaining battery power is low.

The battery pack is not charged at the time of purchase.

1 Attach the battery pack.

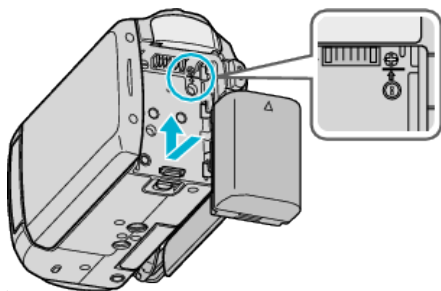

- Align the top of the battery with this unit, and slide in until the battery clicks into place.

2 Connect the AC adapter to the DC terminal.

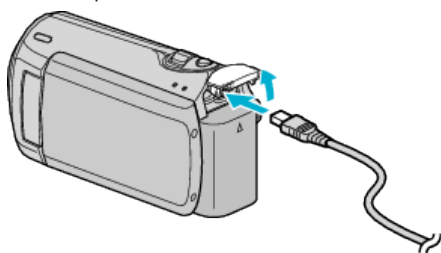

3 Plug in the power.

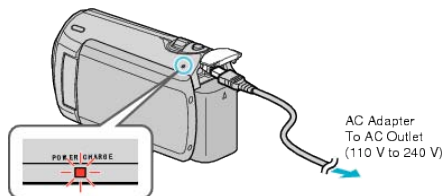

- The charging lamp blinks when charging is in progress. It goes out when charging is finished.

### CAUTION:

Be sure to use JVC battery packs.

- If you use any other battery packs besides JVC battery packs, safety and performance can not be guaranteed.
- Charging time: Approx. 1 h 50 m (using supplied battery pack)  
The charging time is when the unit is used at 25°C (77°F).  
If the battery pack is charged outside the room temperature range of 10°C to 35°C (50°F to 95°F), charging may take a longer time or it may not start. The recordable and playable time may also be shortened under some usage conditions such as at low temperature.

Rechargeable Batteries :

- When using the battery in a low temperature environment (10°C (50°F) or below), the operating time may be shortened, or it may not function properly. When using this unit outdoors in the winter weather, warm the battery, such as by placing it in the pocket, before attaching it. (Keep away from direct contact with a warm pack.)
- Do not expose the battery to excessive heat, such as direct sunlight or fire.
- After removing the battery, store it in a dry place between 15°C to 25°C (59°F to 77°F).
- If the battery pack is not to be used for a long time, use up the charge completely and detach it from this unit to prevent deterioration.

### NOTE:

- You can connect this unit to the AC adapter to record for long hours indoors. (Battery charging begins when the LCD monitor is closed.)

## Detaching the Battery Pack

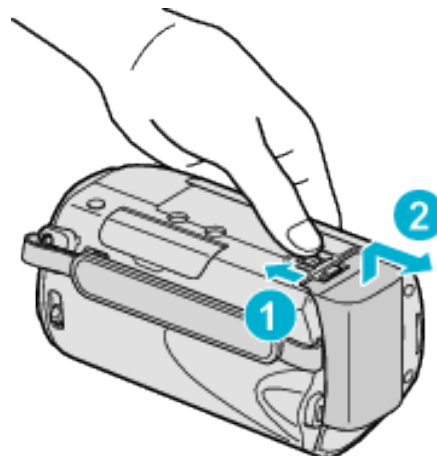

Slide the battery release lever to detach the battery from this unit.

## Approximate Battery Charging Time

Battery Pack	Charging Time
<b>BN-VG107U (Supplied)</b>	1 h 50 m
<b>BN-VG114U</b>	2 h 30 m
<b>BN-VG121U</b>	3 h 30 m

- When the battery life is reached, the recording time becomes shorter even if the battery pack is fully charged. (Replace the battery pack with a new one.)

\*The charging time is when the unit is used at 25°C (77°F).

If the battery pack is charged outside the room temperature range of 10°C to 35°C (50°F to 95°F), charging may take a longer time or it may not start. The recordable and playable time may also be shortened under some usage conditions such as at low temperature.

"Approximate Recording Time (Using Battery)" (P.17)

## Grip Adjustment

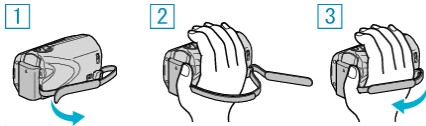

- ① Flip the grip belt over.
- ② Adjust the length of the belt.
- ③ Fasten the grip belt.

### CAUTION:

- Be sure to fasten the grip belt properly.  
If the belt is loose, this unit may drop and result in injuries or damages.

## Using the Hand Strap

When using the hand strap, loop it around your wrist.

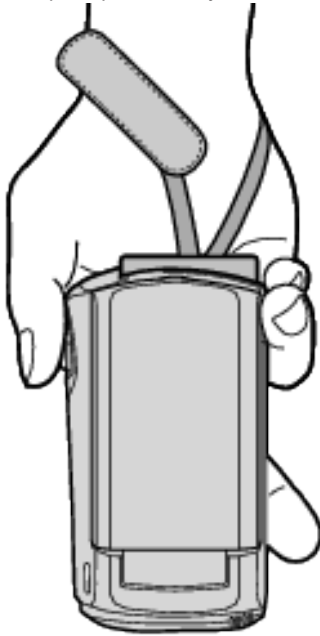

## Removing the Strap

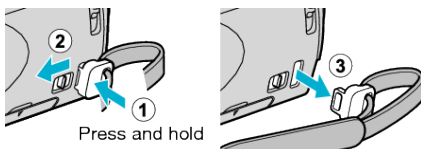

- While pressing ①, pull ② and remove the strap.

## Attaching the Strap

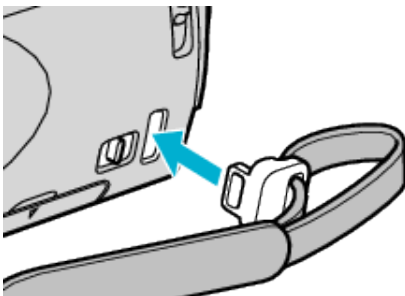

Push in firmly until it clicks into place.

## Inserting an SD Card

Insert a commercially available SD card before recording.  
"Types of Usable SD Card" (P.13)  
"Approximate Video Recording Time" (P.29)

- 1 Close the LCD monitor.

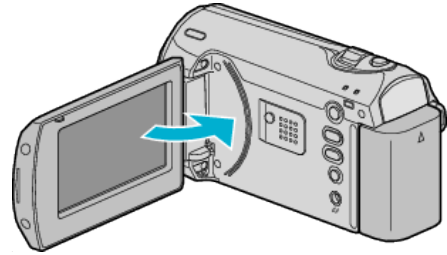

- 2 Open the slot cover.

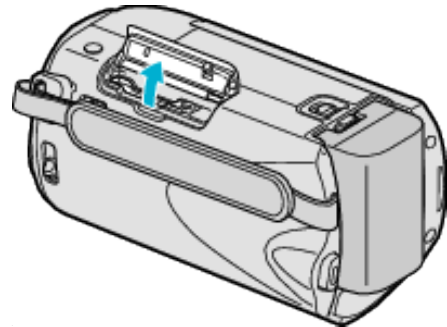

- 3 Insert an SD card.

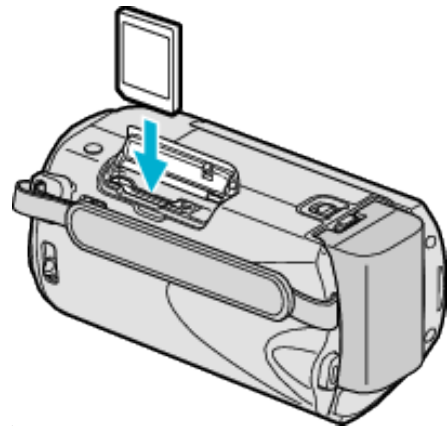

- Insert with the label facing outward.

### Warning

- Make sure not to insert the card in the wrong direction. It may cause damage to the unit and card.
- Turn off the power of this unit before inserting or removing a card.
- Make sure that an SD card is inserted.  
Recordings cannot be performed without any SD card inserted.
- Do not touch the metal contact area when inserting the SD card.

### NOTE:

- To use cards that have been used on other devices, it is necessary to format (initialize) the card using "FORMAT SD CARD".  
"FORMAT SD CARD" (P.59)

## Removing the Card

Push the SD card inward once, then pull it out straight.

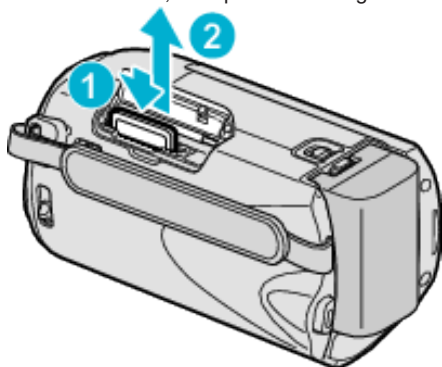

## Types of Usable SD Card

The following SD cards can be used on this unit.

Operations are confirmed on the SD cards from the following manufacturers.

- Panasonic
- TOSHIBA
- SanDisk
- ATP

## SDHC Card



- Use a Class 4 or higher compatible SDHC card (4 GB to 32 GB).

## SD Card



- Use a Class 4 or higher compatible SD card (2 GB).

### NOTE:

- Using SD cards (including SDHC cards) other than those specified above may result in recording failure or data loss.
- Class 4 and Class 6 are guaranteed to have a minimum transfer rate of 4 MB/s and 6 MB/s respectively during reading or writing of data.

## Clock Setting

The "SET DATE/TIME!" screen appears when you turn on this unit for the first time after purchase, when it has not been used for a long time, or when the clock is not set yet.

Set the clock before recording.

- 1 Open the LCD monitor.

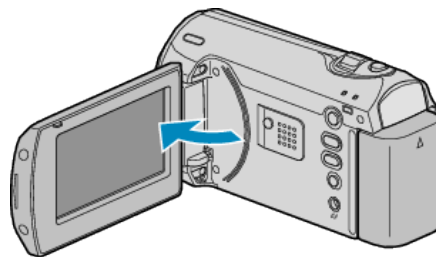

- This unit turns on.
- When the LCD monitor is closed, this unit turns off.

- 2 Select "YES" with the ZOOM/SELECT lever and press OK.

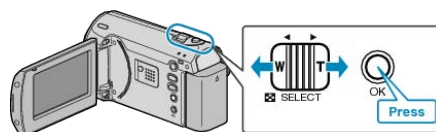

- 3 Set the date and time.



- Use the +/- button to adjust the year, month, day, hour, and minute in order.
  - +: Increases the number.
  - -: Decreases the number.

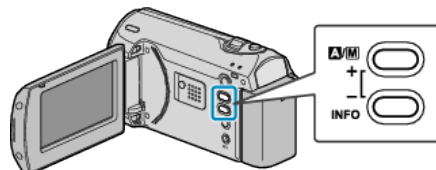

- Use the ZOOM/SELECT lever to move the cursor.
- After setting the date and time, press OK.

## Getting Started

4 Select the region where you live with the +/- button and press OK.



- The city name and time difference are displayed.
- Press OK after the color of the selected region changes.

### NOTE:

- The clock can be reset again later.
- "Resetting the Clock" (P.14)
- When using this unit overseas, you can set it to the local time for recording.
- "Setting the Clock to Local Time when Traveling" (P.16)
- You can turn on or off the clock display during playback mode.
- "ON-SCREEN DISPLAY" (P.51)

## Resetting the Clock

Set the clock with "CLOCK ADJUST" from the menu.

1 Press MENU to display the menu.

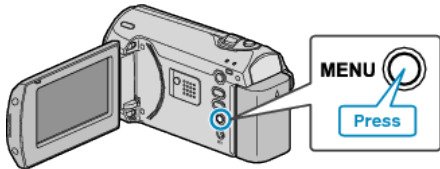

2 Select "CLOCK ADJUST" with the ZOOM/SELECT lever and press OK.

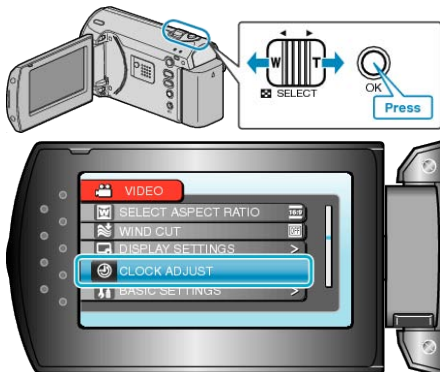

3 Select "CLOCK SETTING" and press OK.



4 Set the date and time.



- Use the +/- button to adjust the year, month, day, hour, and minute in order.
  - +: Increases the number.
  - -: Decreases the number.

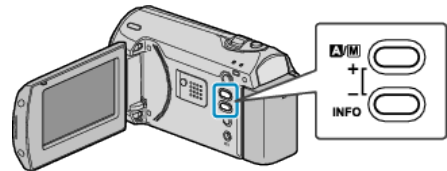

- Use the ZOOM/SELECT lever to move the cursor.
- After setting the date and time, press OK.

5 Select the region where you live with the +/- button and press OK.



- The city name and time difference are displayed.
- Press OK after the color of the selected region changes.

## Changing the Display Language

The language on the display can be changed.

1 Press MENU to display the menu.

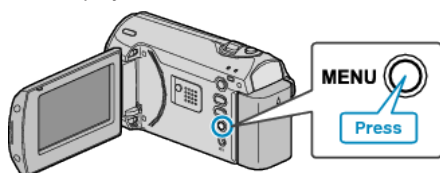

2 Select "DISPLAY SETTINGS" with the ZOOM/SELECT lever and press OK.

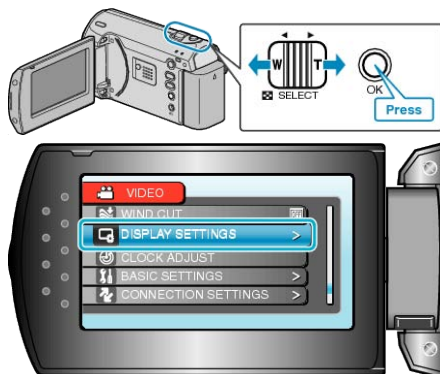

3 Select "LANGUAGE" and press OK.



4 Select the desired language and press OK.

## Holding this Unit

When holding this unit, keep your elbows close to your sides to prevent camera shake.



**CAUTION:** \_\_\_\_\_

- Be careful not to drop this unit during transportation.
- Guardians should pay close attention when this unit is being used by children.

**NOTE:** \_\_\_\_\_

- If camera shake is excessive, use the digital image stabilizer. "DIS" (P.48)

## Tripod Mounting

This unit can be mounted on a tripod. This is useful for preventing camera shake and recording from the same position.

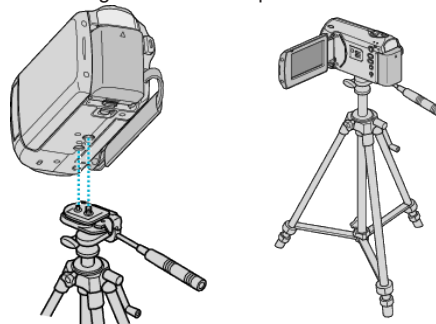

- To prevent this unit from falling off, check the tripod mounting screw holes and positioning holes on the unit carefully before mounting, and turn the screws until they are fastened firmly.

**CAUTION:** \_\_\_\_\_

- To prevent injuries or damages which may result if this unit falls off, read the instruction manual of the tripod to be used and make sure that it is securely attached.

**NOTE:** \_\_\_\_\_

- It is recommended to use the tripod when recording in conditions prone to camera shake (such as in dark places or when zoomed to the telephoto end).
- Set "DIS" to "OFF" when using a tripod for recording. "DIS" (P.48)

## Using this Unit Overseas

The shape of the power outlet varies according to countries and regions. To charge the battery pack, you need a converter plug that matches the shape of the outlet.

"Charging the Battery Pack Overseas" (P.16)

Change the date and time display to the local time by selecting your travel destination in "AREA SETTING" of "CLOCK ADJUST".

"Setting the Clock to Local Time when Traveling" (P.16)

When "ON" is selected in "SET FOR DAYLIGHT SAVING TIME" of "CLOCK ADJUST", the time is set 1 hour ahead.

"Setting Daylight Saving Time" (P.17)

## Charging the Battery Pack Overseas

The shape of the power outlet varies according to countries and regions. To charge the battery pack, you need a converter plug that matches the shape of the outlet.

A	B	BF	C	O

North America	Europe	Oceania	Tyukintou
United States A	Iceland C	Australia O	Israel C
Canada A	Ireland C	Guam A	Iran C
Mexico A	United Kingdom B,BF	Tahiti C	Kuwait B,C
Asia	Italy C	Tonga O	Jordan B,BF
India B,C,BF	Austria C	New Zealand O	
Indonesia C	Netherlands C	Fiji O	
Singapore B,BF	Canary Islands C		
Sri Lanka B,C,BF	Greece C	Latin	
Thailand A,BF,C	Switzerland C	Argentina B,F,C,O	
South Korea A,C	Sweden C	Colombia A	
China A,B,BF,C,O	Spain A,C	Jamaica A	
Nepal C	Denmark C	Chile B,C	
Pakistan B,C	Germany C	Haiti A	
Bangladesh C	Norway C	Panama A	
Philippines A,BF,O	Hungary C	Bahamas A	
Vietnam A,C	Finland C	Puerto Rico A	
Hong Kong Special	France C	Brazil A,C	
Administrative Region B,BF	Belgium C	Venezuela A	
Macau Special	Poland B,C	Peru A,C	
Administrative Region B,C	Portugal B,C		
Malaysia B,BF,C	Romania C		

## Setting the Clock to Local Time when Traveling

Change the date and time display to the local time by selecting your travel destination in "AREA SETTING" of "CLOCK ADJUST". Restore the region settings after you returned from the trip.

1 Press MENU to display the menu.

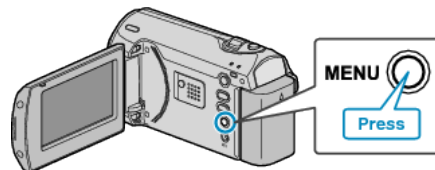

2 Select "CLOCK ADJUST" with the ZOOM/SELECT lever and press OK.

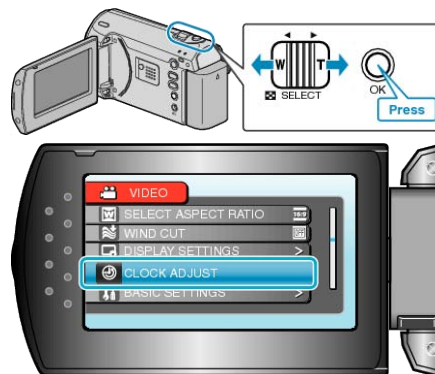

3 Select "AREA SETTING" and press OK.



4 Select the region where you live with the +/- button and press OK.

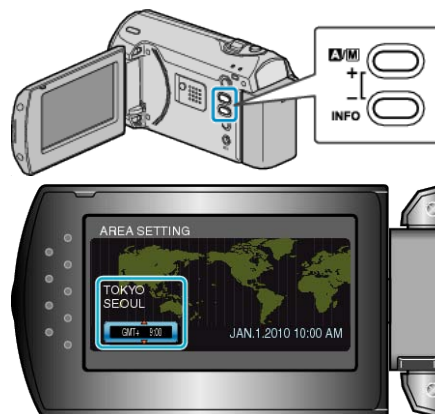

• The city name and time difference are displayed.

**NOTE:**

• Setting "AREA SETTING" changes the clock time such that time difference is accounted for. After returning to your country, re-select the region that was set initially to restore the original clock settings.



## Setting Daylight Saving Time

When "ON" is selected in "SET FOR DAYLIGHT SAVING TIME" of "CLOCK ADJUST", the time is set 1 hour ahead.

1 Press MENU to display the menu.

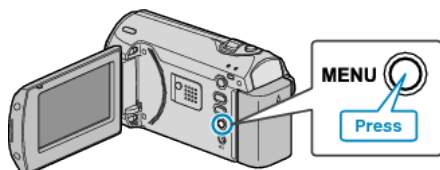

2 Select "CLOCK ADJUST" with the ZOOM/SELECT lever and press OK.

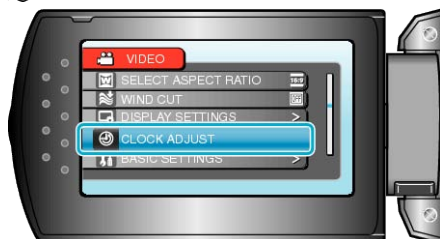
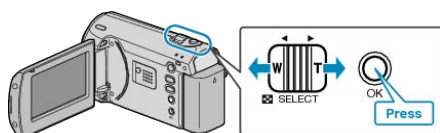

3 Select "SET FOR DAYLIGHT SAVING TIME" and press OK.



4 Set daylight saving time with the +/- button and press OK.

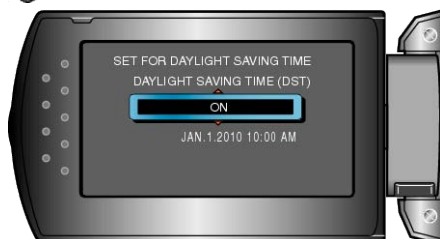
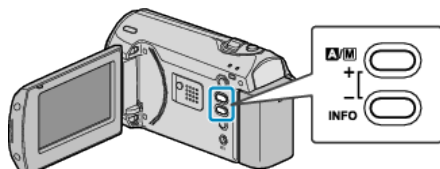

### NOTE:

- What is daylight saving time?  
Daylight saving time is the system of setting the clock 1 hour ahead for a fixed period in summer.  
It is used mainly in the Western countries.
- Restore the daylight saving time settings after you returned from the trip.

## Optional Accessories

You can record for a longer time by using the optional battery pack.

Product Name	Description
Battery Pack <ul style="list-style-type: none"> <li>• BN-VG107U</li> <li>• BN-VG114U</li> <li>• BN-VG121U</li> </ul>	<ul style="list-style-type: none"> <li>• Provides a longer recording time than the battery pack that comes with this unit. It can also be used as a spare battery pack.</li> </ul>
Battery Charger <ul style="list-style-type: none"> <li>• AA-VG1U</li> </ul>	<ul style="list-style-type: none"> <li>• Enables the battery pack to be charged without using this unit.</li> </ul>

### NOTE:

- For more information, refer to the catalog.
- BN-VG107U is the same battery pack that comes with this unit.
- File copying by connecting this unit to a DVD writer is not supported.

## Approximate Recording Time (Using Battery)

Battery Pack	Actual Recording Time	Continuous Recording Time
<b>BN-VG107U (Supplied)</b>	50 m	1 h 30 m
<b>BN-VG114U</b>	1 h 40 m	3 h 5 m
<b>BN-VG121U</b>	2 h 35 m	4 h 40 m

- The above are values when "LCD BACKLIGHT" is set to "STANDARD".
- The actual recording time may be shorter if zooming is used or if recording is stopped repeatedly.  
(It is recommended to prepare battery packs ready for three times the expected recording time.)
- When the battery life is reached, the recording time becomes shorter even if the battery pack is fully charged.  
(Replace the battery pack with a new one.)

## Taking Videos in Auto Mode

You can record without worrying about the setting details by using the auto mode.

1 Open the LCD monitor.

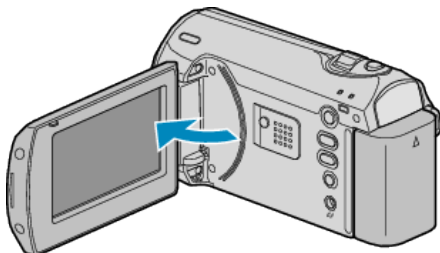

- This unit turns on.
- Open the lens cover if it is closed.

2 Check if the recording mode is Auto.

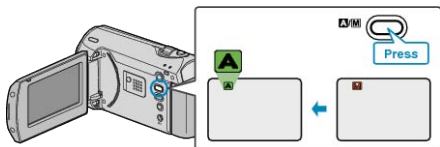

- If the mode is Manual, press the **A/M** button. The mode changes between Auto and Manual with every press.

3 Start recording.

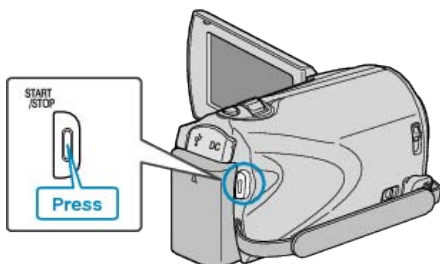

- Press again to stop.

## Indications During Video Recording

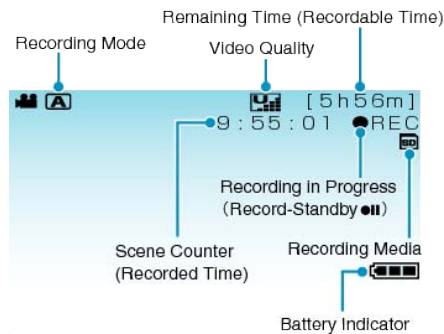

Display Icon	Description
<b>Recording Mode</b>	Press the <b>A/M</b> button to switch the recording mode between <b>A</b> (Auto) and <b>M</b> (Manual).
<b>Video Quality</b>	Displays the icon of the "VIDEO QUALITY" setting selected in the recording menu. "VIDEO QUALITY" (P.47)
<b>Remaining Time (Recordable Time)</b>	Displays the remaining time for video recording.
<b>Recording in Progress</b>	Appears when video recording is in progress.
<b>Record-Standby</b>	Appears when video recording is paused.
<b>Scene Counter (Recorded Time)</b>	Displays the elapsed time of the video that is currently being recorded.
<b>Recording Media</b>	Displays the icon of the media where videos are recorded to.
<b>Battery Indicator</b>	Displays the approximate remaining battery power. Details of the battery power can be displayed by pressing the INFO button. "Remaining Recording Time/Battery Power" (P.29)

## Useful Settings for Recording

- The aspect ratio for recording can be switched between 16:9 and 4:3. "SELECT ASPECT RATIO" (P.49)
- When "QUICK RESTART" is set to "ON", this unit turns on immediately if you open the LCD monitor within 5 minutes after the power is turned off by closing the monitor.
- "QUICK RESTART" (P.56)
- When "AUTO POWER OFF" is set to "ON", this unit turns itself off automatically to conserve power when it is not operated for 5 minutes. (only when using the battery pack)
- "AUTO POWER OFF" (P.55)

### CAUTION:

- Do not expose the lens to direct sunlight.
- Do not use this unit in the rain, snow, or places with high humidity like the bathroom.
- Do not use this unit in places subject to excessive humidity or dust, as well as places exposed to steam or smoke directly.
- The access lamp lights up when video recording is in progress. Do not remove the battery pack, AC adapter, or SD card when the lamp is lighted.
- Make a backup of important recorded data  
It is recommended to copy your important recorded data to a DVD or other recording media for storage. JVC will not be responsible for any lost data.

### NOTE:

- Before recording an important scene, it is recommended to conduct a trial recording.
- Check the remaining recording time in the media before you start shooting. If there is not enough space, move (copy) the data to a PC or disc.
- Do not forget to make copies after recording!
- Recording stops automatically as it cannot be performed for 12 or more consecutive hours according to specifications. (It may take some time to resume recording.)
- For long recordings, the file is split into two or more files if the size exceeds 4 GB.
- You can connect this unit to the AC adapter to record for long hours indoors.

## Zooming

The angle of view can be adjusted using zoom.

- Use the W end (wide angle end) to shoot a wider field of view.
- Use the T end (telephoto end) to magnify the subject for shooting.

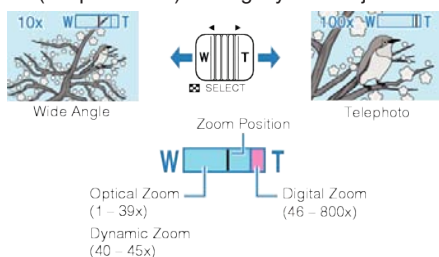

### NOTE:

- You can expand the zoom area without degrading the image quality by using dynamic zoom.
  - When digital zoom is used, the image becomes grainy as it is digitally enlarged.
  - The zoom ratio range can be changed.
- "ZOOM" (P.47)

## Manual Recording

You can adjust settings, such as brightness and shutter speed, by using the manual mode.

- 1 Select the Manual recording mode.

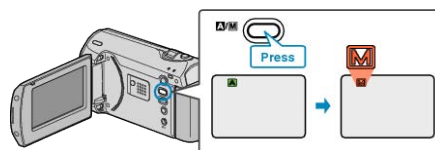

- The mode changes between Auto and Manual with every press.

- 2 Start recording.

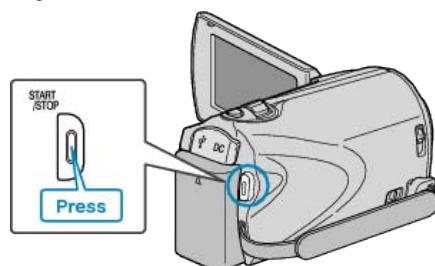

- Press again to stop.

### NOTE:

- The manual settings are displayed only in the manual mode.

## Manual Recording Menu

The following items can be set.

Name	Description
SCENE SELECT	<ul style="list-style-type: none"> <li>• Recordings that suit the shooting conditions can be performed easily.</li> </ul> "Scene Selection" (P.20)
FOCUS	<ul style="list-style-type: none"> <li>• Use manual focus if the subject is not focused automatically.</li> </ul> "Adjusting Focus Manually" (P.21)
BRIGHTNESS ADJUST	<ul style="list-style-type: none"> <li>• Overall brightness on the screen can be adjusted.</li> <li>• Use this when recording in a dark or bright location.</li> </ul> "Adjusting Brightness" (P.22)
SHUTTER SPEED	<ul style="list-style-type: none"> <li>• Shutter speed can be adjusted.</li> <li>• Use this when shooting a fast-moving subject or to emphasize the subject's movement.</li> </ul> "Setting Shutter Speed" (P.23)
WHITE BALANCE	<ul style="list-style-type: none"> <li>• Overall color on the screen can be adjusted.</li> <li>• Use this when the color on the screen appears differently from the actual color.</li> </ul> "Setting White Balance" (P.24)
BACKLIGHT COMP.	<ul style="list-style-type: none"> <li>• Corrects the image when the subject appears dark due to backlight.</li> <li>• Use this when shooting against the light.</li> </ul> "Setting Backlight Compensation" (P.24)
METERING AREA/TYPE	<ul style="list-style-type: none"> <li>• Brightness of a specified area can be set as the standard.</li> </ul> "Setting Metering Area" (P.25)
TELE MACRO	<ul style="list-style-type: none"> <li>• Use this to take close-up (macro) shots of the subject.</li> </ul> "Taking Close-up Shots" (P.25)

## Scene Selection

Common scenes that are often encountered can be recorded with the most suitable settings.

1 Press MENU to display the menu.

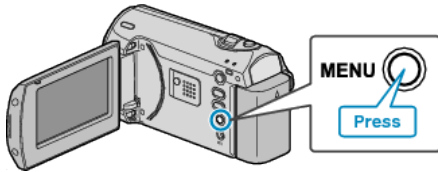

2 Select "MANUAL SETTING" with the ZOOM/SELECT lever and press OK.

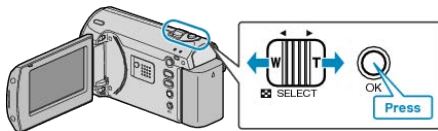

3 Select "SCENE SELECT" and press OK.

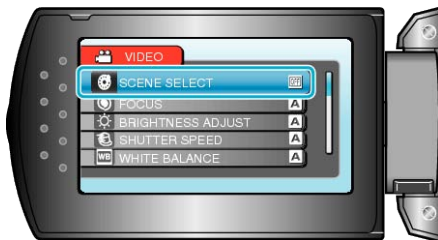

4 Select the scene and press OK.



• After setting, press MENU.

\*The image is only an impression.

Setting	Effect
NIGHT EYE	Increases gain and brightens the scene automatically when the surrounding is dark. To prevent camera shake, use a tripod. <b>OFF</b> <b>ON</b>
NIGHT	Captures night scenes naturally. <b>OFF</b> <b>ON</b>
PORTRAIT	Blurs the background to bring out the people in the picture. <b>OFF</b> <b>ON</b>
SPORTS	Captures fast-moving subjects clearly in every single frame. <b>OFF</b> <b>ON</b>
SNOW	Prevents the subject from appearing too dark when recording snow scenes on a sunny day. <b>OFF</b> <b>ON</b>
SPOTLIGHT	Prevents the human subject from appearing too bright under light. <b>OFF</b> <b>ON</b>

## Adjusting Focus Manually

Set this when the focus is not clear in "AUTO" or when manual focusing is desired.

1 Press MENU to display the menu.

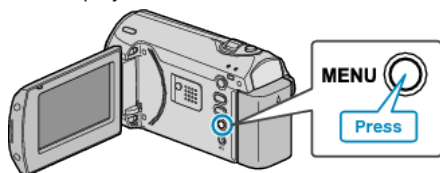

2 Select "MANUAL SETTING" with the ZOOM/SELECT lever and press OK.

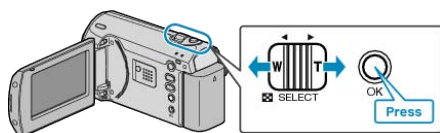

3 Select "FOCUS" and press OK.

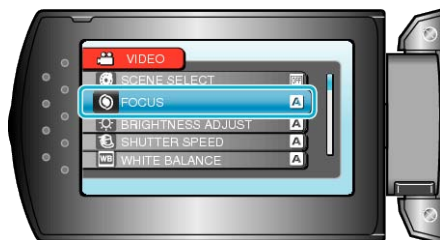

4 Select "MANUAL" and press OK.



5 Adjust the focus with the +/- button.

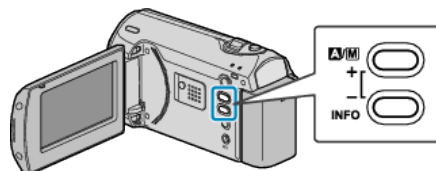

- Press + to focus on a distant subject.
- Press - to focus on a near subject.

6 Press OK to confirm.



### NOTE:

- A subject that is focused at the telephoto (T) end remains in focus when it is zoomed out to the wide angle (W) end.

## Adjusting Brightness

You can adjust the brightness to your preferred level.

1 Press MENU to display the menu.

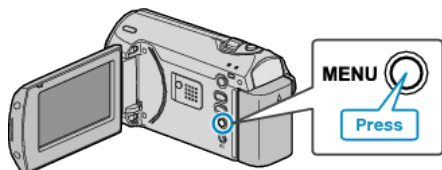

2 Select "MANUAL SETTING" with the ZOOM/SELECT lever and press OK.

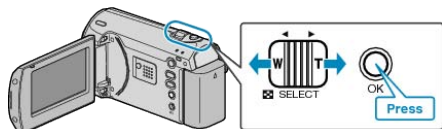

3 Select "BRIGHTNESS ADJUST" and press OK.



4 Select "MANUAL" and press OK.



5 Select the brightness value with the +/- button.

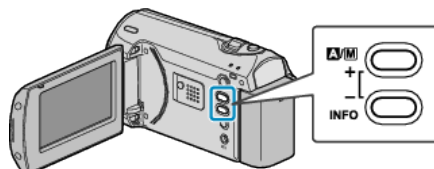

- Compensation range during video recording: -6 to +6
- Press + to increase the brightness.
- Press - to decrease the brightness.

6 Press OK to confirm.



## Setting Shutter Speed

You can set the shutter speed to suit the type of subject.

1 Press MENU to display the menu.

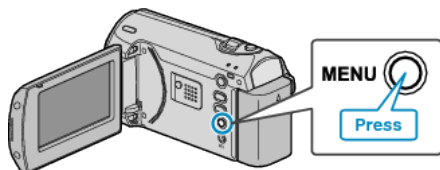

2 Select "MANUAL SETTING" with the ZOOM/SELECT lever and press OK.

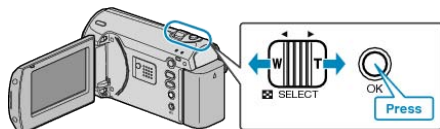

3 Select "SHUTTER SPEED" and press OK.



4 Select "MANUAL" and press OK.



5 Select the shutter speed with the +/- button.

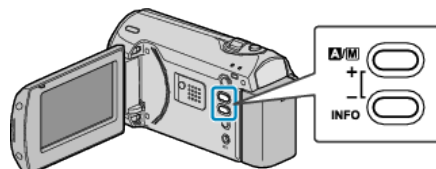

- Shutter speed can be set from 1/2 to 1/4000.
- Press + to increase the shutter speed.
- Press - to decrease the shutter speed.

6 Press OK to confirm.



## Setting White Balance

You can set the color tone to suit the light source.

1 Press MENU to display the menu.

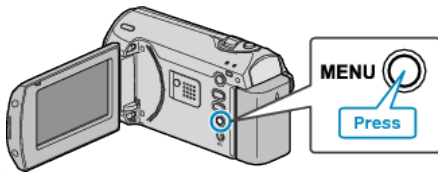

2 Select "MANUAL SETTING" with the ZOOM/SELECT lever and press OK.

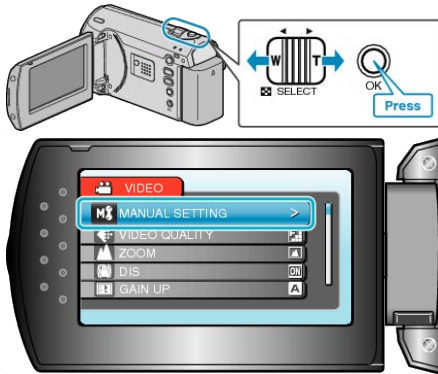

3 Select "WHITE BALANCE" and press OK.



4 Select the white balance setting and press OK.



Setting	Details
AUTO	Adjusts automatically to the natural colors.
MWB	Use this when the problem of unnatural colors is not resolved.
FINE	Set this when shooting outdoors on a sunny day.
CLOUD	Set this when shooting on a cloudy day or inside a shade.
HALOGEN	Set this when shooting under illumination such as a video light.

## Using MWB

1 Hold a sheet of plain white paper in front of the lens so that the white paper fills the screen.

2 Select "MWB" and keep pressing OK.

- The cursor blinks.

3 Release OK after the menu disappears.

## Setting Backlight Compensation

You can correct the image when the subject appears too dark due to backlight.

1 Press MENU to display the menu.

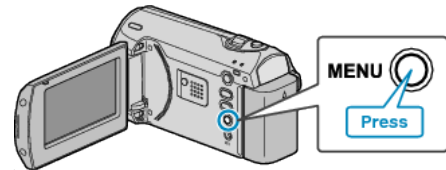

2 Select "MANUAL SETTING" with the ZOOM/SELECT lever and press OK.

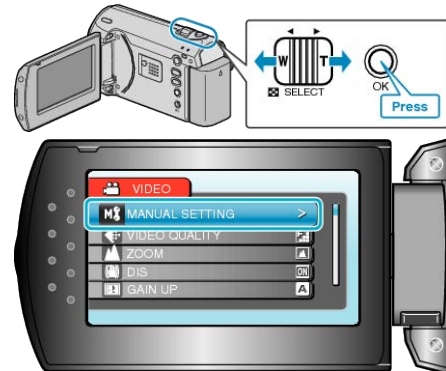

3 Select "BACKLIGHT COMP." and press OK.



4 Select "ON" and press OK.





## Setting Metering Area

You can set the brightness of a specified area as the standard.

1 Press MENU to display the menu.

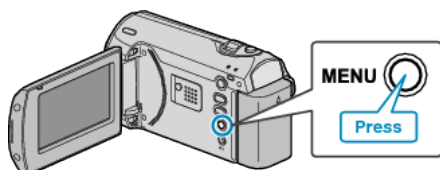

2 Select "MANUAL SETTING" with the ZOOM/SELECT lever and press OK.

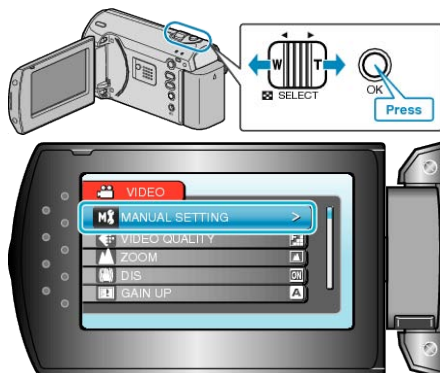

3 Select "METERING AREA/ TYPE" and press OK.

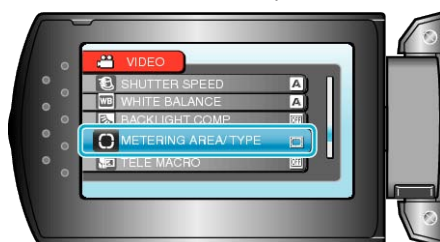

4 Select "SPOT" and press OK.



- When "SPOT" is selected, select the position of the spot frame by pressing the +/- buttons. After selecting, press OK to confirm.

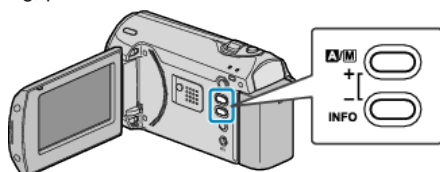

## Taking Close-up Shots

You can take close-up shots of an object using the tele macro function.



\*The image is only an impression.

1 Press MENU to display the menu.

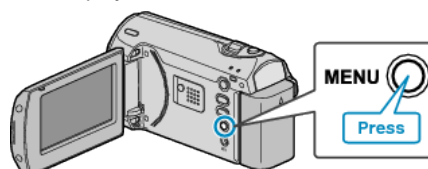

2 Select "MANUAL SETTING" with the ZOOM/SELECT lever and press OK.

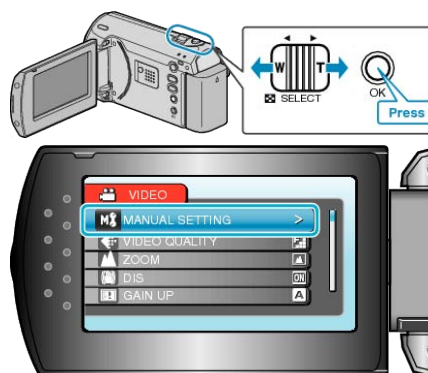

3 Select "TELE MACRO" and press OK.



4 Select "ON" and press OK.



Setting	Details
OFF	Enables close-up shots up to 1 m at the telephoto (T) end. Enables close-up shots up to 5 cm at the wide angle (W) end.
ON	Enables close-up shots up to 50 cm at the telephoto (T) end. Enables close-up shots up to 5 cm at the wide angle (W) end.

### CAUTION:

- When you are not taking close-up shots, set TELE MACRO to "OFF". Otherwise, the image may be blur.

## Recording at Intervals (TIME-LAPSE RECORDING)

This function enables the changes of a scene that occur slowly over a long period to be shown within a short time by taking frames of it at a certain interval.

This is useful for making observations such as the opening of a flower bud.

1 Press MENU to display the menu.

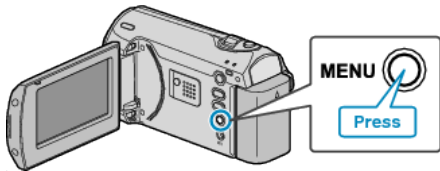

2 Select "TIME-LAPSE RECORDING" with the ZOOM/SELECT lever and press OK.

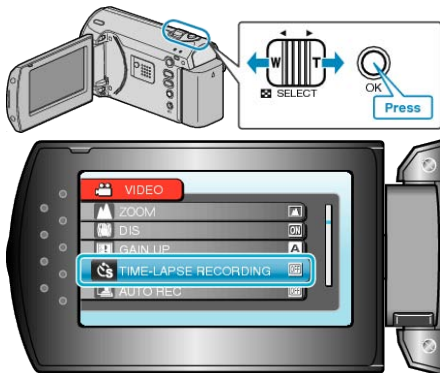

3 Select a recording interval (1 to 80 seconds) and press OK.



- The greater the number of seconds, the longer the recording interval.

4 Start recording.

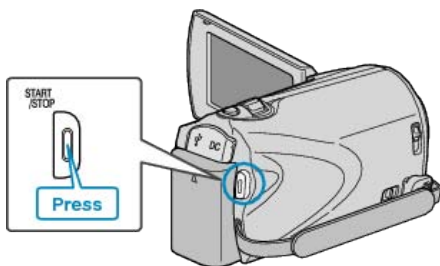

- A frame is taken at intervals of the selected period.
- When the recording interval is set to "20SEC INTERVAL" or higher, this unit switches to the power-saving mode between recordings. At the next point to record, the power-saving mode will be turned off and recording will start automatically.
- Press the START/STOP button again to stop recording.

## Indications During Time-Lapse Recording

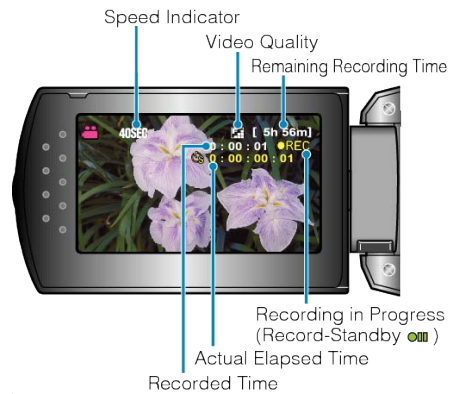

Display	Description
<b>Speed Indicator</b>	Displays the recording interval that is set.
<b>Video Quality</b>	Displays the icon of the video quality that is set.
<b>Remaining Recording Time</b>	Remaining time left to record with the currently selected video quality.
<b>Recording in Progress</b>	Appears when video recording is in progress. When in the power-saving mode, it blinks.
<b>Record-Standby</b>	Appears when video recording is paused.
<b>Actual Elapsed Time</b>	Displays the actual elapsed time after recording starts.
<b>Recorded Time</b>	Displays the actual recorded time of the video. Recorded time increases in units of frames.

## Time-Lapse Setting

The greater the number of seconds, the longer the recording interval.

Setting	Details
<b>OFF</b>	Deactivates the function.
<b>1SEC INTERVAL</b>	Takes a frame at 1-second intervals. Recorded videos will be played back at 30 times speed.
<b>2SEC INTERVAL</b>	Takes a frame at 2-second intervals. Recorded videos will be played back at 60 times speed.
<b>5SEC INTERVAL</b>	Takes a frame at 5-second intervals. Recorded videos will be played back at 150 times speed.
<b>10SEC INTERVAL</b>	Takes a frame at 10-second intervals. Recorded videos will be played back at 300 times speed.
<b>20SEC INTERVAL</b>	Takes a frame at 20-second intervals. Recorded videos will be played back at 600 times speed.
<b>40SEC INTERVAL</b>	Takes a frame at 40-second intervals. Recorded videos will be played back at 1 200 times speed.
<b>80SEC INTERVAL</b>	Takes a frame at 80-second intervals. Recorded videos will be played back at 2 400 times speed.

**CAUTION:** 

---

- Audio cannot be recorded during time-lapse recording.
- Zooming and image stabilizer are not available in time-lapse recording.
- When recording is stopped with the recorded time less than "0:00:00:17", the video will not be saved.

**NOTE:** 

---

- Settings of time-lapse recording are saved even when the power is turned off.  
When the power is turned on, "TIME LAPSE" appears on the screen.
- Recording stops automatically 99 hours after it is started.
- Make use of a tripod and AC adapter for time-lapse recordings with long intervals.  
It is also recommended to fix the focus and white balance manually.

"Tripod Mounting" (☞ P.15)

"Adjusting Focus Manually" (☞ P.21)

"Setting White Balance" (☞ P.24)

---

## Recording Automatically by Sensing Movements (AUTO REC)

This function enables the unit to record automatically by sensing the changes in subject's movement (brightness) within the red frame displayed on the LCD monitor. (AUTO REC)

- 1 Compose the picture according to the subject.
  - Adjust the angle of view with the zoom, etc.
- 2 Press MENU to display the menu.

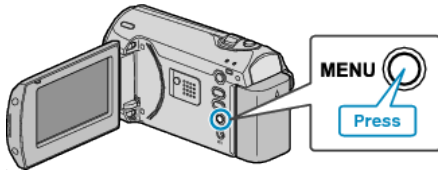

- 3 Select "AUTO REC" with the ZOOM/SELECT lever and press OK.

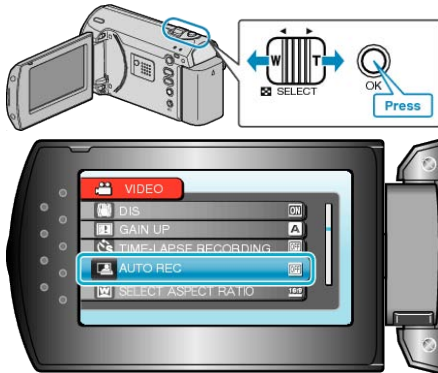

- 4 Select "ON" and press OK.



- 5 Recording starts automatically when the subject within the red frame moves.



- A red frame appears 2 seconds after the menu display disappears.
- For video recording, recording continues while there are still movements of the subject (changes in brightness) within the red frame. When there are no more movements of the subject (changes in brightness) within the red frame, recording will stop in 5 seconds.
- To stop video recording manually, press the START/STOP button. However, as the AUTO REC setting remains at ON even after the video recording is stopped, recording starts again when movements of the subject (changes in brightness) are detected within the red frame. To cancel AUTO REC, set it to "OFF".

### CAUTION:

- The only manual recording setting available is "TELE MACRO". The rest are all set to "AUTO".
- Digital zoom and image stabilizer are not available after AUTO REC is set.
- AUTO REC cannot be used together with TIME-LAPSE RECORDING. When both are set, priority is given to TIME-LAPSE RECORDING.
- "VIDEO QUALITY" and "SELECT ASPECT RATIO" cannot be changed after AUTO REC is selected. Set them before selecting AUTO REC.
- The auto power off and power-saving modes are not available after AUTO REC is set.

### NOTE:

- Recording stops when there are no changes for 5 seconds during video recording.
- Recording may not start when the movements of the subject within the red frame are too fast or the changes in brightness are too small.
- Recording may start due to changes in brightness even if there is no movement within the red frame.
- While zooming, recording cannot be started.

## Remaining Recording Time/Battery Power

You can check the remaining video recording time on the SD card as well as the remaining battery power.

1 Display the remaining recording time.

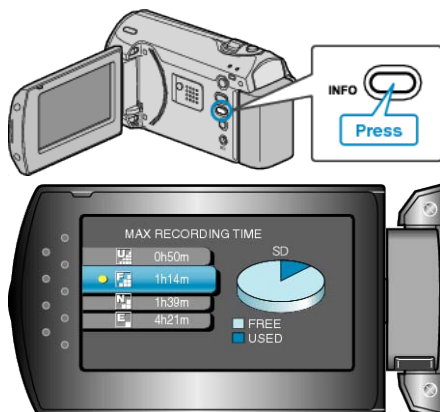

- While the remaining recording time is being displayed, press INFO to display the remaining battery power.
- To exit the display, press the MENU button.

2 Display the remaining battery power.

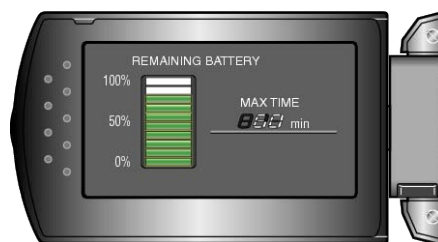

- To exit the display, press the INFO button.
- To display the remaining recording time again, press the MENU button.
- Remaining battery power will not be displayed when the AC adapter is connected.

### NOTE:

- You can also change the video quality from the remaining recording time display. Select the video quality with the ZOOM/SELECT lever and press OK.

## Approximate Video Recording Time

Quality	SD Card 2 GB	SDHC Card 4 GB	SDHC Card 8 GB	SDHC Card 16 GB	SDHC Card 32 GB
ULTRA FINE	28 m	56 m	1 h 50 m	3 h 45 m	7 h 30 m
FINE	42 m	1 h 20 m	2 h 50 m	5 h 40 m	11 h 20 m
NORMAL	55 m	1 h 45 m	3 h 45 m	7 h 30 m	15 h
ECONOMY	2 h 25 m	4 h 57 m	10 h	20 h	40 h

- The actual recording time may shorten depending on the shooting environment.

## Approximate Recording Time (Using Battery)

Battery Pack	Actual Recording Time	Continuous Recording Time
BN-VG107U (Supplied)	50 m	1 h 30 m
BN-VG114U	1 h 40 m	3 h 5 m
BN-VG121U	2 h 35 m	4 h 40 m

- The above are values when "LCD BACKLIGHT" is set to "STANDARD".
- The actual recording time may be shorter if zooming is used or if recording is stopped repeatedly. (It is recommended to prepare battery packs ready for three times the expected recording time.)

## Playing Back Videos

You can select and play back the recorded videos from an index screen (thumbnail display).

1 Select the playback mode.

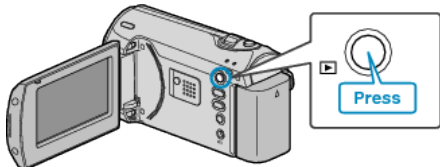

2 Select the desired video with the ZOOM/SELECT lever and press OK to start playback.



- You can also press the START/STOP button to start playback.
- Press the OK or START/STOP button to stop (pause) playback.
- To return to the index screen, slide along the ZOOM/SELECT lever while paused.

## Operations During Video Playback

Operation Button	Operation
	Playback/pause
	Forward search/reverse search
	Volume adjustment

**NOTE:**

- You can search for a specific file by the recording date. This is useful when searching from a large number of files. "Searching for a Specific Video Image" (P.31)

**CAUTION:**

- Make a backup of important recorded data. It is recommended to copy your important recorded data to a DVD or other recording media for storage. JVC will not be responsible for any lost data.

## Checking the Recording Date and Other Information

Press the INFO button when the index screen is displayed or while paused.

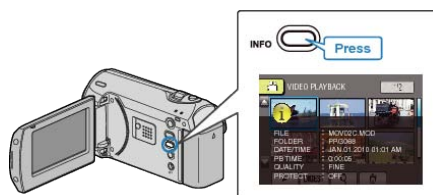

### Playing a Video with Defective Management Information

Plays videos with defective management information.

- 1 Select the playback mode.

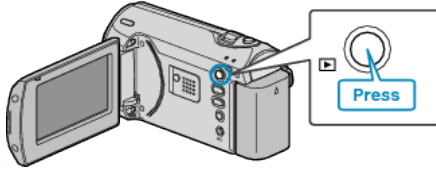

- 2 Press MENU to display the menu.

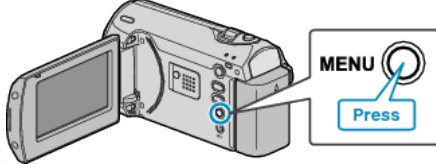

- 3 Select "PLAYBACK MPG FILE" with the ZOOM/SELECT lever and press OK.

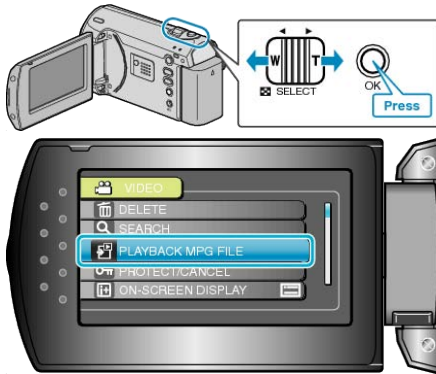

- 4 Select the desired video and press OK.



"Playing Back Videos" (P.30)

### Searching for a Specific Video Image

When there is a large number of recorded videos, it is difficult to look for the desired file from the index screen. Use the search function to find the file you want.

- 1 Select the playback mode.

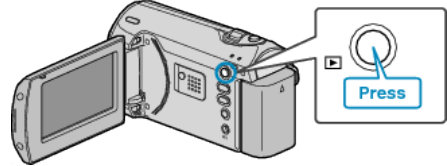

- 2 Press MENU to display the menu.

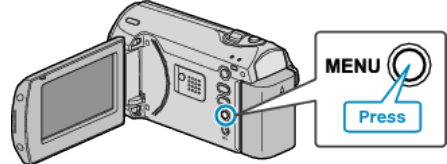

- 3 Select "SEARCH" with the ZOOM/SELECT lever and press OK.

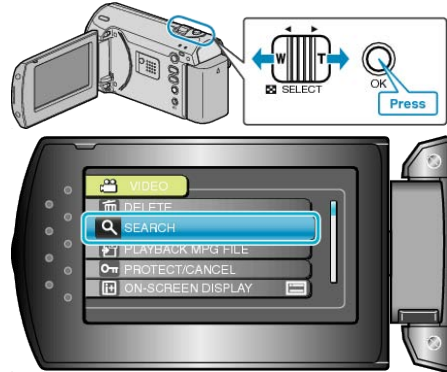

- 4 Select a recording date and press OK.



- 5 Select the desired video and press OK to start playback.



- Only the videos recorded on the selected date are displayed.

Deleting Files of a Selected Date : \_\_\_\_\_  
 Select "DELETE" from the playback menu to delete unwanted files.  
 "Deleting Unwanted Files" (P.33)

## Connecting to and Viewing on TV

By connecting the supplied AC cable to the video terminal, videos can be played back on a TV.

- Refer also to the instruction manual of the TV in use.

1 Connect the AC adapter to this unit.

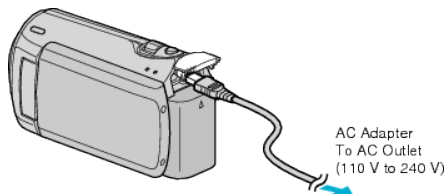

2 Open the LCD monitor and select the playback mode.

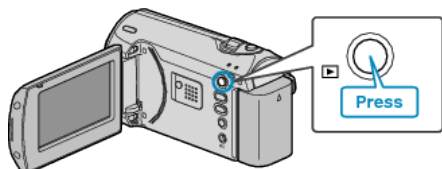

3 Connect to the TV.

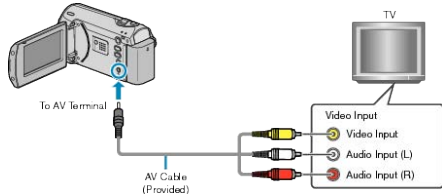

4 Press the external input button on the TV to switch to the input from this unit via the connected terminal.

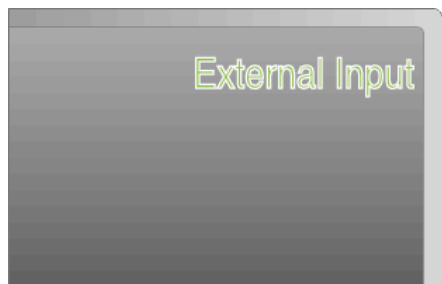

5 Play back a file.



"Playing Back Videos" (P.30)

**NOTE:**

- To play back with date/time display, set "DISPLAY ON TV" in the connection settings menu to "ON". Set "ON-SCREEN DISPLAY" in the playback menu to "DISPLAY ALL" or "DISPLAY DATE ONLY".

"DISPLAY ON TV" (P.58)

"ON-SCREEN DISPLAY" (P.51)

- For questions about the TV or method of connection, contact your TV's manufacturer.

## Unnatural Displays on TV

Trouble	Action
Images do not appear on the TV properly.	<ul style="list-style-type: none"> <li>• Disconnect the cable and connect again.</li> <li>• Turn off and on this unit again.</li> </ul>
Images are projected vertically on the TV.	<ul style="list-style-type: none"> <li>• Set "VIDEO OUTPUT" in the connection settings menu to "4:3".</li> </ul> "VIDEO OUTPUT" (P.58)
Images are projected horizontally on the TV.	<ul style="list-style-type: none"> <li>• Adjust the TV's screen accordingly.</li> </ul>



## Deleting Unwanted Files

Delete unwanted videos when the space in the recording media is running out.

The capacity of the recording media can be restored after deleting the files.

"Deleting the Currently Displayed File" (P.33)

"Deleting Selected Files" (P.33)

"Deleting All Files" (P.34)

### NOTE:

- Deleted files cannot be restored.
- Files that are protected cannot be deleted.  
Release protection before deleting the file.

"Protecting Files" (P.35)

- Be sure to back up important files on a PC.

"Backing Up All Files" (P.39)

### Deleting the Currently Displayed File

Deletes the currently displayed file.

### CAUTION:

- Deleted files cannot be restored.

1 Select the playback mode.

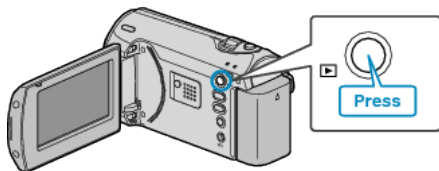

2 Press MENU to display the menu.

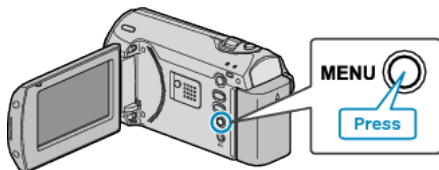

3 Select "DELETE" with the ZOOM/SELECT lever and press OK.

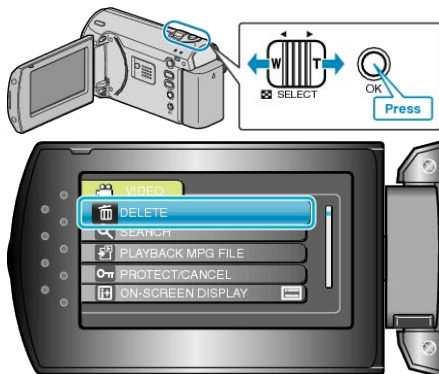

4 Select "CURRENT" and press OK.

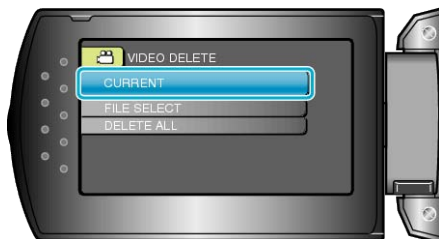

5 Check that it is the file to delete, select "YES" and press OK.



- The file to delete appears on this screen.
- Press the +/- buttons to select the previous or next file.
- After deleting, press MENU.

### NOTE:

- Files that are protected cannot be deleted.  
Release protection before deleting the file.

"Protecting Files" (P.35)

### Deleting Selected Files

Deletes the selected files.

### CAUTION:

- Deleted files cannot be restored.

1 Select the playback mode.

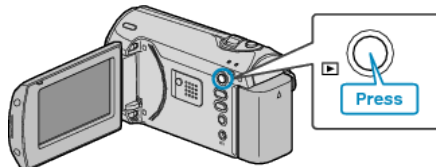

2 Press MENU to display the menu.

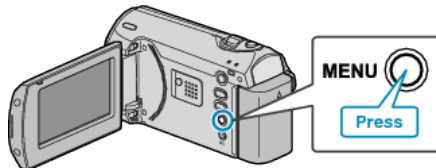

3 Select "DELETE" with the ZOOM/SELECT lever and press OK.

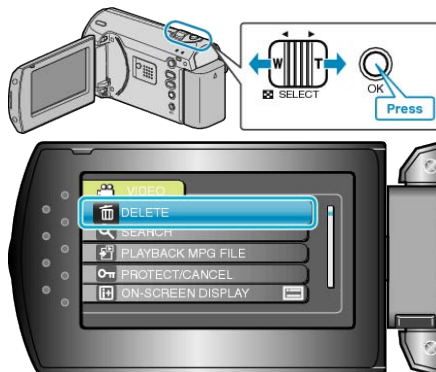

4 Select "FILE SELECT" and press OK.



5 Select the desired file and press OK.



- A delete mark appears on the selected file. To remove the delete mark, press OK again.
- After selecting all the files to delete, press MENU.

6 Select "EXECUTE AND QUIT" and press OK.



- After deleting, press OK.

**NOTE:**

- Files that are protected cannot be deleted. Release protection before deleting the file.

"Protecting Files" (P.35)

**Deleting All Files**

Deletes all files.

**CAUTION:**

- Deleted files cannot be restored.

1 Select the playback mode.

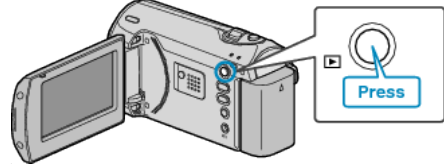

2 Press MENU to display the menu.

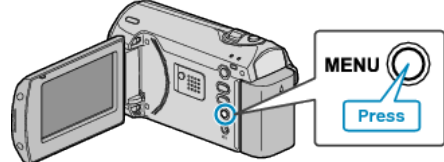

3 Select "DELETE" with the ZOOM/SELECT lever and press OK.

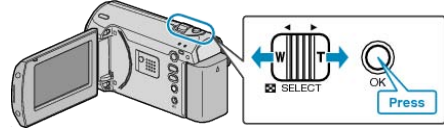

4 Select "DELETE ALL" and press OK.

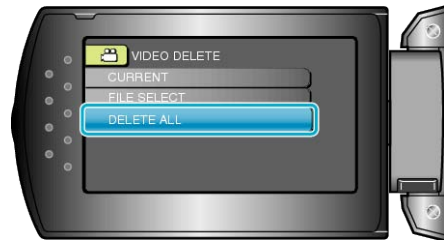

5 Select "YES" and press OK.



- After deleting, press OK.

**NOTE:**

- Files that are protected cannot be deleted. Release protection before deleting the file.

"Protecting Files" (P.35)

## Protecting Files

Prevent important videos from being deleted accidentally by protecting them.

"Protecting the Currently Displayed File" (P.35)

"Protecting Selected Files" (P.36)

"Protecting All Files" (P.36)

"Releasing Protection of All Files" (P.37)

### CAUTION:

- When the recording media is formatted, even the protected files will be deleted.

## Protecting the Currently Displayed File

Protects or releases protection of the currently displayed file.

1 Select the playback mode.

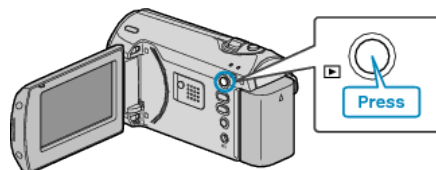

2 Press MENU to display the menu.

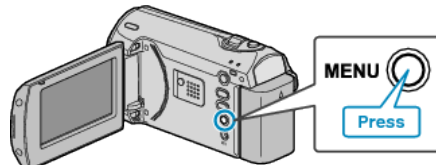

3 Select "PROTECT/CANCEL" with the ZOOM/SELECT lever and press OK.

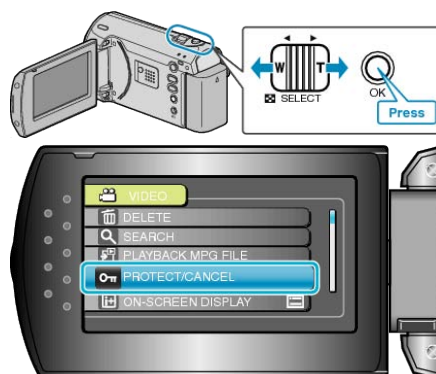

4 Select "CURRENT" and press OK.



5 Check that it is the file to protect, select "YES" and press OK.



- The file to protect appears on this screen.
- Press the +/- buttons to select the previous or next file.
- After setting, press OK.
- To exit the screen, press MENU.

### Protecting Selected Files

Protects or releases protection of the selected files.

1 Select the playback mode.

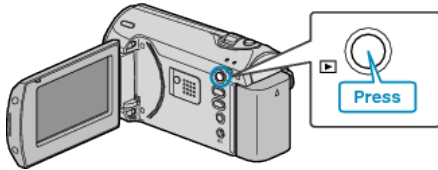

2 Press MENU to display the menu.

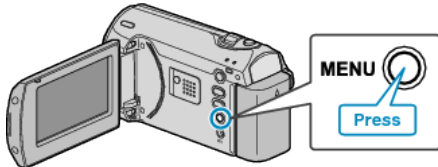

3 Select "PROTECT/CANCEL" with the ZOOM/SELECT lever and press OK.

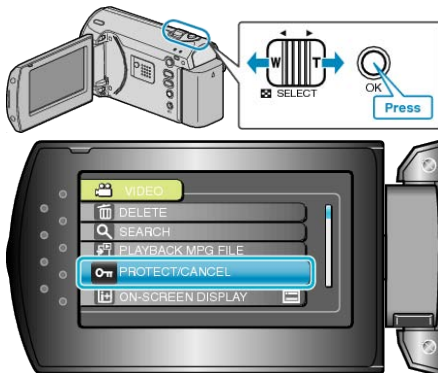

4 Select "FILE SELECT" and press OK.



5 Select the desired file and press OK.



- A protect mark appears on the selected file. To remove the protect mark, press OK again.
- After selecting all the files to protect or release protection of, press MENU.

6 Select "YES" and press OK.



### Protecting All Files

Protects all files.

1 Select the playback mode.

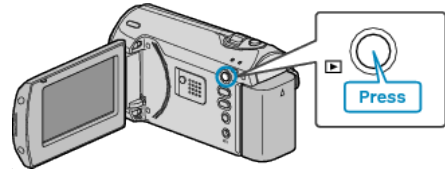

2 Press MENU to display the menu.

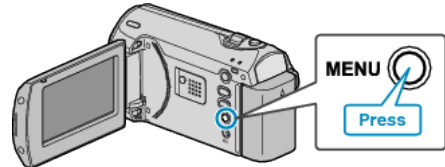

3 Select "PROTECT/CANCEL" with the ZOOM/SELECT lever and press OK.

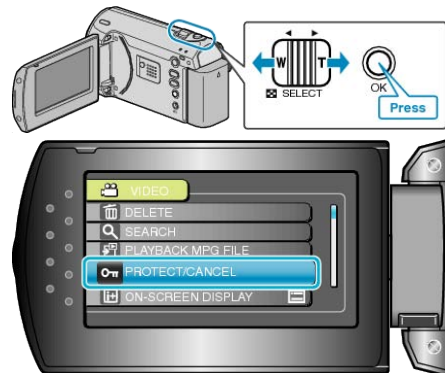

4 Select "PROTECT ALL" and press OK.



5 Select "YES" and press OK.



- After setting, press OK.

## Releasing Protection of All Files

Releases protection of all files.

- 1 Select the playback mode.

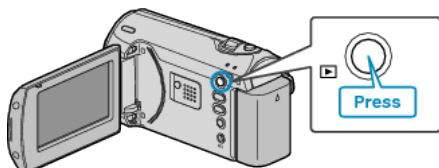

- 2 Press MENU to display the menu.

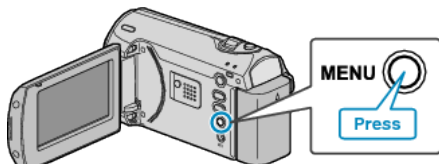

- 3 Select "PROTECT/CANCEL" with the ZOOM/SELECT lever and press OK.

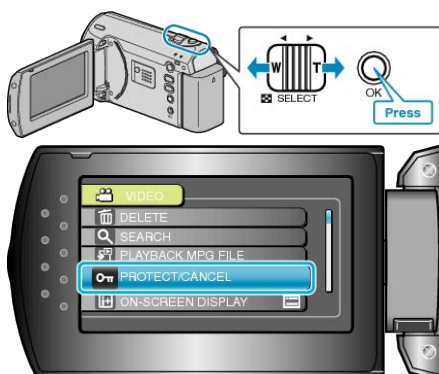

- 4 Select "CANCEL ALL" and press OK.



- 5 Select "YES" and press OK.

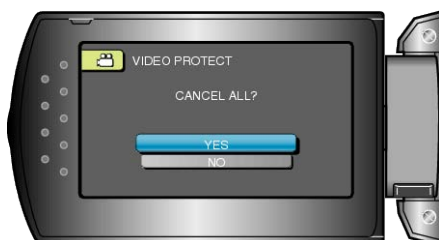

- After setting, press OK.

## Dubbing Files to a DVD Recorder or VCR

You can dub videos by connecting to a DVD recorder or VCR.

- Refer also to the instruction manuals of the TV, DVD recorder, VCR, etc.

- 1 Connect the AC adapter to this unit.

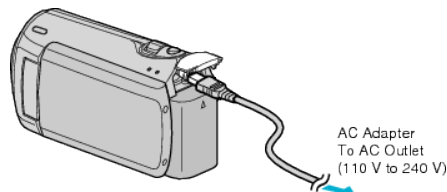

- 2 Open the LCD monitor and select the playback mode.

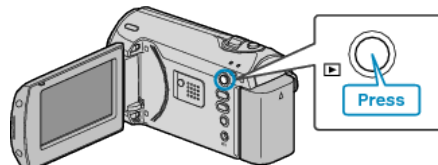

- 3 Connect to a VCR/DVD recorder.

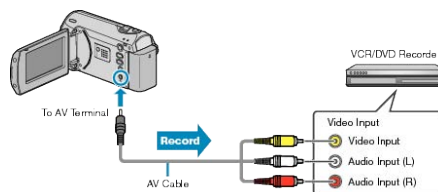

- 4 Prepare the TV/VCR for recording.

- Switch to a compatible external input.
- Insert a DVD-R or video tape.

- 5 Prepare this unit for playback.

- Set "VIDEO OUTPUT" in the connection settings menu to the aspect ratio (4:3 or 16:9) of the connecting TV.

"VIDEO OUTPUT" (P.58)

- To include the date during dubbing, set "DISPLAY ON TV" in the connection settings menu to "ON".  
Set "ON-SCREEN DISPLAY" in the playback menu to "DISPLAY DATE ONLY".

"DISPLAY ON TV" (P.58)

- 6 Start recording.

- Start playback on this unit and press the record button on the VCR/ DVD recorder.

"Playing Back Videos" (P.30)

- After playback is complete, stop the recording.

### CAUTION:

- Dubbing cannot be performed by connecting this unit to a Blu-ray recorder with a USB cable.  
Connect and dub using the supplied AV cable.

## Copying to Windows PC

You can copy files to a PC using the provided software.

DVDs can also be created using the PC's DVD drive.

If the provided software is not installed, this unit will be recognized as an external storage when connected.

**NOTE:**

- To record to discs, a recordable DVD drive is required for the PC in use.

### Trouble with Using the Provided Software Everio MediaBrowser

Consult the customer service center below.

- Pixela User Support Center

<b>Telephone</b>	USA and Canada (English): +1-800-458-4029 (toll-free) Europe (UK, Germany, France, and Spain) (English/German/French/Spanish): +800-1532-4865 (toll-free) Other Countries in Europe (English/German/French/Spanish): +44-1489-564-764 Asia (Philippines) (English): +63-2-438-0090 China (Chinese): 10800-163-0014 (toll-free)
<b>Homepage</b>	<a href="http://www.pixela.co.jp/oem/jvc/mediabrowser/e/">http://www.pixela.co.jp/oem/jvc/mediabrowser/e/</a>

- For details on how to upload to YouTube, refer to "MediaBrowser Help" in the "Help" menu of Everio MediaBrowser.

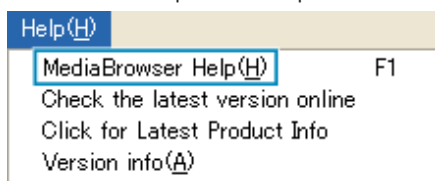

### Verifying System Requirements (Guideline)

Right-click on "Computer" (or "My Computer") in the "Start" menu and select "Properties" to check the following items.

#### Windows Vista/Windows 7

- Refer to the operating instructions found in the animation on the Detailed User Guide.

#### Windows XP

- Refer to the operating instructions found in the animation on the Detailed User Guide.

	Windows Vista/Windows 7	Windows XP
OS	Windows Vista 32/64-bit Home Basic or Home Premium (Pre-installed versions only)Service Pack 2 Windows 7 32/64-bit Home Premium (Pre-installed versions only)	Windows XP Home Edition or Professional (Pre-installed versions only)Service Pack 3
CPU	Intel Core Duo CPU 1.5 GHz or higher Intel Pentium 4 CPU 1.6 GHz or higher Intel Pentium M CPU 1.4 GHz or higher	Intel Core Duo CPU 1.5 GHz or higher Intel Pentium 4 CPU 1.6 GHz or higher Intel Pentium M CPU 1.4 GHz or higher
RAM	At least 1 GB (1024 MB)	At least 512 MB

**NOTE:**

- If your PC does not meet the above system requirements, operations of the provided software cannot be guaranteed.
- For more information, contact your PC's manufacturer.

### Installing the Provided Software

You can display the recorded images in calendar format and perform simple editing using the provided software.

#### Windows Vista / Windows 7

- Refer to the operating instructions found in the animation on the Detailed User Guide.

#### Windows XP

- Refer to the operating instructions found in the animation on the Detailed User Guide.

### Backing Up All Files

Before making backup, make sure that enough free space is left in the PC's hard disk (HDD).

1 Connect the USB cable and the AC adapter.

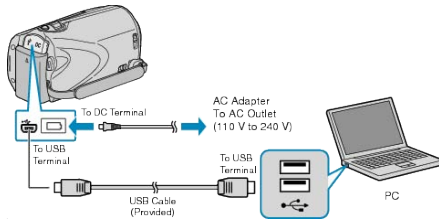

- ① Connect the AC adapter to this unit.
- ② Connect using the provided USB cable.

2 Open the LCD monitor.

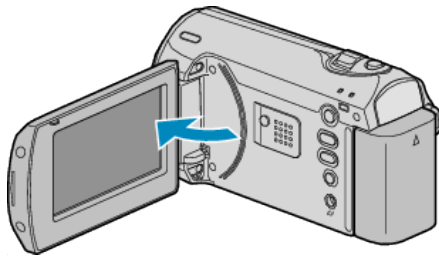

- The USB MENU appears.

3 Select "BACK UP" and press OK.



- The provided software Everio MediaBrowser starts up on the PC. The subsequent operations are to be performed on the PC.

4 Select the volume.



5 Start backup.

#### Saving Destination (PC)

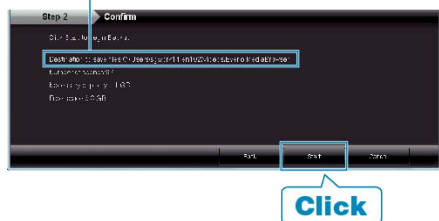

- Backup starts.

6 After backup is complete, click "OK".



#### NOTE:

- Before making backup, load the SD card in which the videos are stored on this unit.
- If you encounter any problems with the provided software Everio MediaBrowser, please consult the "Pixela User Support Center".

<b>Tele- phone</b>	USA and Canada (English): +1-800-458-4029 (toll-free) Europe (UK, Germany, France, and Spain) (English/German/French/Spanish): +800-1532-4865 (toll-free) Other Countries in Europe (English/German/French/Spanish): +44-1489-564-764 Asia (Philippines) (English): +63-2-438-0090 China (Chinese): 10800-163-0014 (toll-free)
<b>Home- page</b>	<a href="http://www.pixela.co.jp/oem/jvc/mediabrowser/e/">http://www.pixela.co.jp/oem/jvc/mediabrowser/e/</a>

- Delete unwanted videos before making backup. It takes time to back up many videos.

"Deleting Unwanted Files" (P.33)

### Disconnecting this Unit from PC

1 Click "Safely Remove Hardware".

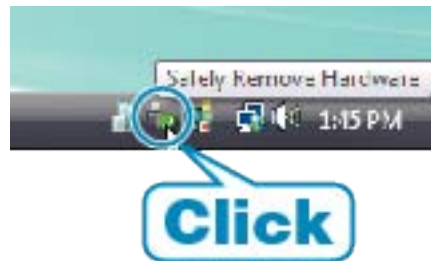

2 Click "Safely Remove USB Mass Storage Device".

3 (For Windows Vista) Click "OK".

4 Disconnect the USB cable and close the LCD monitor.

**Organizing Files**

After backing up your files, organize them by adding labels such as "Family Trip" or "Athletic Meet". This is useful not only for creating discs, but for viewing the files too.

1 Display the month of the files to organize.



2 Create a user list.



- A new user list is added to the user list library.
- 3 Click on the recording day.
- The thumbnails of the files recorded on the day are displayed.
- 4 Register files to the created user list.

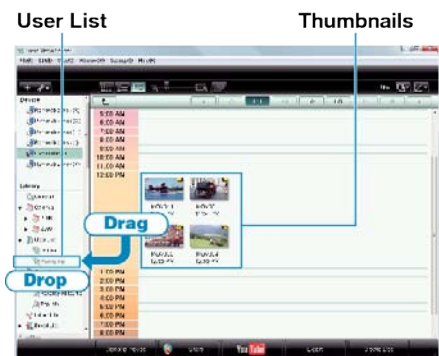

**NOTE:**

- If you encounter any problems with the provided software Everio MediaBrowser, please consult the "Pixela User Support Center".

<p><b>Tele- phone</b></p>	<p>USA and Canada (English): +1-800-458-4029 (toll-free)                  Europe (UK, Germany, France, and Spain)                  (English/German/French/Spanish): +800-1532-4865 (toll-free)                  Other Countries in Europe                  (English/German/French/Spanish): +44-1489-564-764                  Asia (Philippines) (English): +63-2-438-0090                  China (Chinese): 10800-163-0014 (toll-free)</p>
<p><b>Home- page</b></p>	<p><a href="http://www.pixela.co.jp/oem/jvc/mediabrowser/e/">http://www.pixela.co.jp/oem/jvc/mediabrowser/e/</a></p>

**Recording Videos to Discs**

Copy the files that are arranged using the user list to DVDs.

- 1 Insert a new disc into the PC's recordable DVD drive.
- 2 Select the desired user list.

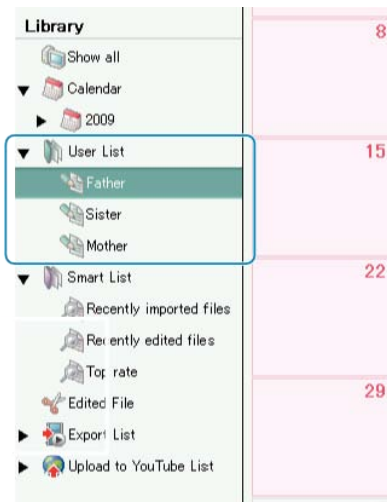

3 Select the method of file selection.



- If you select "Select all files displayed", only the displayed videos are copied to the DVD. Proceed to step 5.
  - If you select "Select files individually", proceed to step 4.
- 4 (When "Select files individually" is selected) Select the files to copy to DVD in order.



- After selecting, click "NEXT".
- 5 Set the top menu of the disc.



- Set the title and menu background.



6 Copying to disc starts.



- After copying, click “OK”.

**NOTE:**

- The following types of discs can be used on the provided software Everio MediaBrowser.
  - DVD-R
  - DVD-R DL
  - DVD-RW
  - DVD+R
  - DVD+R DL
  - DVD+RW
- To view the help file of Everio MediaBrowser, select “Help” from the Everio MediaBrowser’s menu bar or press F1 on the keyboard.
- If you encounter any problems with the provided software Everio MediaBrowser, please consult the “Pixela User Support Center”.

<b>Tele- phone</b>	USA and Canada (English): +1-800-458-4029 (toll-free) Europe (UK, Germany, France, and Spain) (English/German/French/Spanish): +800-1532-4865 (toll-free) Other Countries in Europe (English/German/French/Spanish): +44-1489-564-764 Asia (Philippines) (English): +63-2-438-0090 China (Chinese): 10800-163-0014 (toll-free)
<b>Home- page</b>	<a href="http://www.pixela.co.jp/oem/jvc/mediabrowser/e/">http://www.pixela.co.jp/oem/jvc/mediabrowser/e/</a>

**JVC Software Licence Agreement**

**IMPORTANT**

TO CUSTOMERS: PLEASE MAKE SURE TO READ THIS CAREFULLY BEFORE INSTALLING OR USING THE SOFTWARE PROGRAM NAMED "DIGITAL PHOTO NAVIGATOR" ("Program") ON YOUR PC. The right to use the Program is granted by Victor Company of Japan, Limited ("JVC") to You only on the condition that You agree to the following. Should You not agree to the terms hereof, You may not install or use the Program. HOWEVER, INSTALLING OR USING THE PROGRAM INDICATES YOUR ACCEPTANCE OF THESE TERMS AND CONDITIONS.

**1 COPYRIGHT; OWNERSHIP**

You acknowledge that all copyrights and other intellectual property rights in the Program are owned by JVC and its licensor, and remain vested in JVC and such licensor. The Program is protected under the copyright law of Japan and other countries, and related Conventions.

**2 GRANT OF LICENCE**

- ① Subject to the conditions of this Agreement, JVC grants to You a non-exclusive right to use the Program. You may install and use the Program on a HDD or other storage devices incorporated in Your PC.
- ② You may make one (1) copy of the Program solely for your personal backup or archival purposes.

**3 RESTRICTION ON THE PROGRAM**

- ① You may not reverse engineer, decompile, disassemble, revise or modify the Program, except to the extent that expressly permitted by applicable law.
- ② You may not copy or use the Program, in whole or in part, other than as expressly specified in this Agreement.
- ③ You have no right to grant a licence to use the Program, and may not distribute, rent, lease or transfer the Program to any third party or otherwise let them use the Program.

**4 LIMITED WARRANTY**

JVC warrants that any media in which the Program is embodied are free from any defects in materials and workmanship for a period of thirty (30) days from the date of Your purchasing any our products accompanying the Program. JVC’s entire liability and your exclusive remedy in connection with the Program shall be replacement of such defective media. EXCEPT FOR THE EXPRESS WARRANTIES STATED HEREIN AND TO THE EXTENT PERMITTED BY APPLICABLE LAW, JVC AND ITS LICENSORS DISCLAIM ANY OTHER WARRANTIES, EITHER EXPRESS OR IMPLIED, INCLUDING BUT NOT LIMITED TO IMPLIED WARRANTIES OF MERCHANTABILITY AND FITNESS FOR A PARTICULAR PURPOSE IN REGARD TO THE PROGRAM AND THE ACCOMPANYING PRINTED MATERIALS. SHOULD THERE BE ANY PROBLEM ARISING FROM OR CAUSED BY THE PROGRAM, YOU SHOULD SETTLE ALL SUCH PROBLEM AT YOUR OWN COST AND EXPENSE.

**5 LIMITED LIABILITY**

TO THE EXTENT PERMITTED BY APPLICABLE LAW, IN NO EVENT SHALL JVC AND ITS LICENSORS BE LIABLE FOR ANY INDIRECT, SPECIAL, INCIDENTAL OR CONSEQUENTIAL DAMAGES WHATSOEVER, REGARDLESS OF THE FORM OF ACTION WHETHER IN CONTRACT, TORT OR OTHERWISE ARISING OUT OF OR IN CONNECTION WITH THE USE OF OR INABILITY TO USE THE PROGRAM, EVEN IF JVC HAS BEEN ADVISED OF THE POSSIBILITY OF SUCH DAMAGES. YOU WILL INDEMNIFY AND HOLD HARMLESS JVC FROM ANY LOSS, LIABILITY OR COST ARISING OUT OF OR IN ANY WAY CONNECTED TO CLAIMS FROM ANY THIRD PARTY RELATING TO THE USE OF THE PROGRAM.

**6 TERM**

This Agreement will become effective on the date when You install and use the Program on Your machine, and continue to be in effect until the termination under the following provision. Should You breach any provision of this Agreement, JVC may terminate this Agreement without giving any notice to You. In this event, JVC may claim against You for any damages caused by Your breach. Should this Agreement be terminated, You must immediately destroy the Program stored in Your machine (including the erasing from any memory in Your PC), and no longer own such Program.

## Copying

### 7 EXPORT CONTROL

You agree that You will not ship, transfer or export the Program or underlying information and technology to any countries to which Japan and other relevant countries have initiated an embargo on such goods.

### 8 U.S. GOVERNMENT USER

If You are an agency of the United States of America (the "Government"), You acknowledge JVC's representation that the Program is a "Commercial Item" as defined in Federal Acquisition Regulation (FAR) part 2.101 (g) consisting unpublished "Commercial Computer Software" as those items are used at FAR part 12.212 and is only licenced to You with the same use rights JVC grants all commercial end users pursuant to the terms of this Agreement.

### 9 GENERAL

- ① No modification, change, addition, deletion or other alternation of or to this Agreement will be valid unless reduced to writing and signed by an authorized representative of JVC.
- ② If any part of this Agreement is held invalid by or in conflict with any law having jurisdiction over this Agreement, the remaining provisions will remain in full force and effect.
- ③ This Agreement shall be governed by and interpreted under the laws of Japan. The Tokyo District Court has jurisdiction over all disputes which may arise with respect to the execution, interpretation and performance of this Agreement.

Victor Company of Japan, Limited

#### NOTE:

- If You acquired the Program in Germany, the provisions of Sections 4 (Limited Warranty) and 5 (Limited Liability) provided above will be replaced with those of the German version of this Agreement.

#### CAUTION:

- Operate this equipment according to the operating procedures described in this manual.
- Use only the provided CD-ROM. Never use any other CD-ROM to run this software.
- Do not attempt to modify this software.
- Changes or modifications not approved by JVC could void user's authority to operate the equipment.

#### How to handle a CD-ROM :

- Take care not to soil or scratch the mirror surface (opposite to the printed surface). Do not write anything or put a sticker on either the front or back surface. If the CD-ROM gets dirty, gently wipe it with a soft cloth outward from the center hole.
- Do not use conventional disc cleaners or cleaning spray.
- Do not bend the CD-ROM or touch its mirror surface.
- Do not store your CD-ROM in a dusty, hot or humid environment. Keep it away from direct sunlight.

You can find the latest information (in English) on the provided software program at our world wide web server at <http://www.jvc-victor.co.jp/english/global-e.html>

## Backing Up Files Without Using Provided Software

Copy the files to a PC using the following method.

- 1 Connect the USB cable and AC adapter.

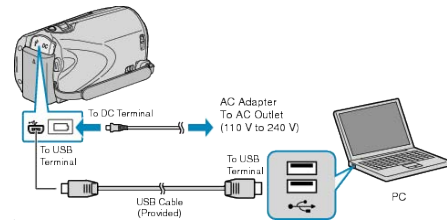

- ① Connect the AC adapter to this unit.
- ② Connect using the provided USB cable.

- 2 Open the LCD monitor.

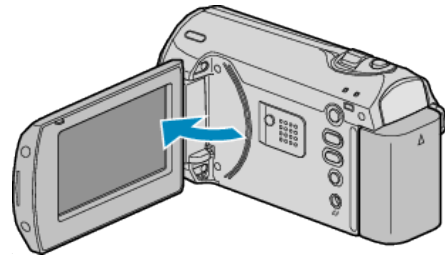

- The USB MENU appears.

- 3 Select "PLAYBACK ON PC" and touch  $\odot$ .



- Close the Everio MediaBrowser program, if it starts.
- The subsequent operations are to be performed on the PC.

- 4 Select "Computer" (Windows Vista) / "My Computer" (Windows XP) from the start menu, then click on the EVERIO\_HDD or EVERIO\_SD icon.

- The folder opens.

- 5 Copy the files to any folder in the PC (desktop, etc).

#### CAUTION:

- When the folders or files are deleted/moved/renamed in the computer, they cannot be played back on this unit anymore.

#### NOTE:

- To edit the files, use a software that supports MOD/JPEG files.
- The above operations on PC may vary with the system used.

## Disconnecting this Unit from PC

- 1 Click "Safely Remove Hardware".



- 2 Click "Safely Remove USB Mass Storage Device".

- 3 (For Windows Vista) Click "OK".

- 4 Disconnect the USB cable and close the LCD monitor.

### List of Files and Folders

Folders and files are created in the SD card as shown below. They are created only when necessary.

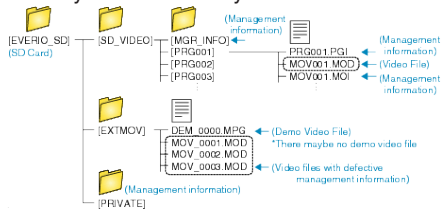

**CAUTION:**

- When the folders or files are deleted/moved/renamed in the computer, they cannot be played back on this unit anymore.

### Copying to Mac Computer

Copy the files to a Mac computer using the following method.

1 Connect the USB cable and the AC adapter.

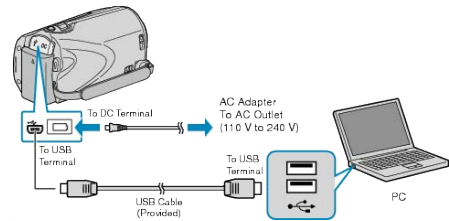

- 1 Connect the AC adapter to this unit.
  - 2 Connect using the provided USB cable.
- The provided software is not required for this process.

2 Open the LCD monitor.

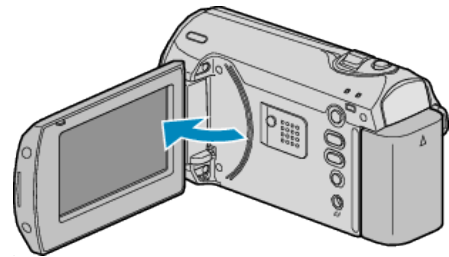

- The USB MENU appears.

3 Select "PLAYBACK ON PC" and press OK.

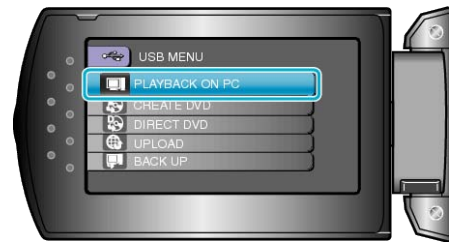

- The subsequent operations are to be performed on the PC.

4 Click on the "EVERIO\_SD" icon on the desktop.

- The folder opens.

5 Click on the column display icon.

Column Display Icon

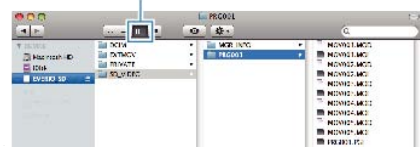

- Search the folder with the desired files.

"List of Files and Folders" (P.43)

6 Copy the files to any folder in the PC (desktop, etc).

Files to Copy



### CAUTION:

---

- When the folders or files are deleted/moved/renamed in the computer, they cannot be played back on this unit anymore.
- MOD files that are copied to a Mac computer cannot be imported to iMovie.  
To use MOD files with iMovie, import the files using iMovie.

### NOTE:

---

- To edit the files, use a software that supports MOD files.
  - When removing this unit from the PC, drag&drop the "EVERIO\_SD" icon on the desktop to the trash bin.
- 

### iMovie

You can import files from this unit to a PC using Apple's iMovie'08 or '09. To verify the system requirements, select "About This Mac" from the Apple menu. You can determine the operating system version, processor and amount of memory.

- For the latest information on iMovie, refer to the Apple website.
- For details on how to use iMovie, refer to the help file of the software.
- There is no guarantee that the operations will work with all computer environments.

## Operating the Menu

Use the ZOOM/SELECT lever and OK button to set the menu.

- The menu differs according to the mode in use.

1 Press MENU to display the menu.

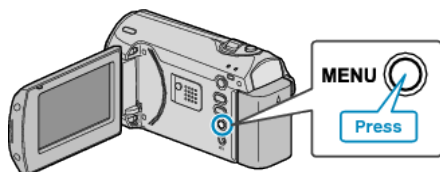

2 Select the desired menu with the ZOOM/SELECT lever and press OK.

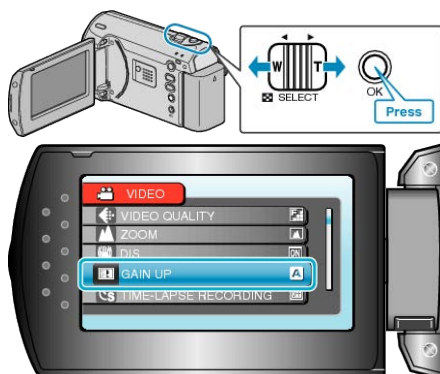

3 Select the desired setting and press OK.



### NOTE:

- To return to the previous screen, press MENU.
- To close the menu, press MENU a few times.

Returning All Settings to Default :

- Set using "FACTORY PRESET" in the camera settings menu.
- "FACTORY PRESET" (P.57)

## Recording Menu

You can adjust various settings, such as brightness and white balance, to suit the subject or purpose. You can also change settings such as picture quality and gain.

Setting	Details
MANUAL SETTING	Recording settings can be adjusted manually. <ul style="list-style-type: none"> <li>• They are displayed only when recording in the manual mode.</li> </ul> "Manual Recording" (P.19)
VIDEO QUALITY	Sets the video quality. "VIDEO QUALITY" (P.47)
ZOOM	Sets the maximum zoom ratio. "ZOOM" (P.47)
DIS	Camera shake during recording can be effectively reduced. "DIS" (P.48)
GAIN UP	Makes the subject appear bright automatically when recording in dark places. "GAIN UP" (P.48)
TIME-LAPSE RECORDING	Enables the changes of a scene that occur slowly over a long period to be shown within a short time by taking frames of it at a certain interval. "Recording at Intervals (TIME-LAPSE RECORDING)" (P.26)
AUTO REC	Enables the unit to start or stop recording automatically by sensing the changes in brightness within the red frame displayed on the LCD monitor. "Recording Automatically by Sensing Movements (AUTO REC)" (P.28)
SELECT ASPECT RATIO	Recording with aspect ratio 16:9 or 4:3 can be performed. "SELECT ASPECT RATIO" (P.49)
WIND CUT	Reduces the noise caused by wind. "WIND CUT" (P.49)

## VIDEO QUALITY

Sets the video quality.

Setting	Details
ULTRA FINE	Enables recording in the best picture quality.
FINE	Enables recording in high picture quality.
NORMAL	Enables recording in standard quality.
ECONOMY	Enables long recordings.

### Displaying the Item

1 Press MENU to display the menu.

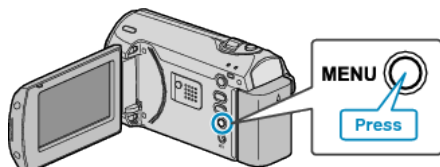

2 Select "VIDEO QUALITY" with the ZOOM/SELECT lever and press OK.

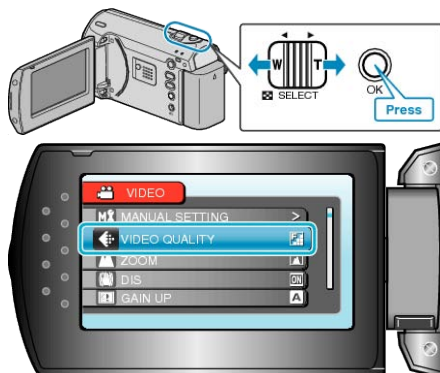

### NOTE:

- You can also change the video quality from the remaining recording time display. Select the video quality with the slider and press OK.

## ZOOM

Sets the maximum zoom ratio.

Setting	Details
39x/OPTICAL	Enables zooming up to 39x.
45x/DYNAMIC	Enables zooming up to 45x.
90x/DIGITAL	Enables zooming up to 90x.
800x/DIGITAL	Enables zooming up to 800x.

### NOTE:

- You can expand the zoom area without degrading the image quality by using dynamic zoom.
- When digital zoom is used, the image becomes grainy as it is digitally enlarged.

### Displaying the Item

1 Press MENU to display the menu.

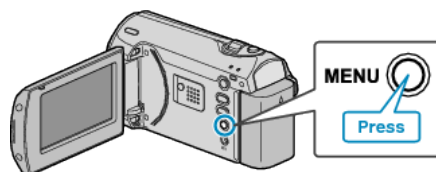

2 Select "ZOOM" with the ZOOM/SELECT lever and press OK.

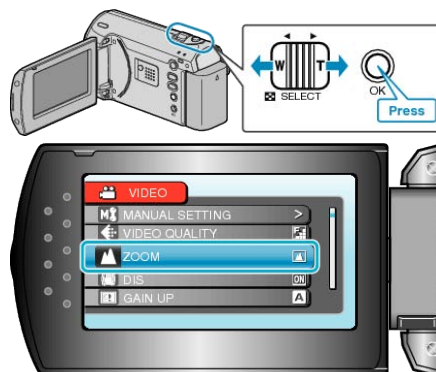

## DIS

Camera shake during recording can be effectively reduced.

Setting	Details
OFF	Deactivates image stabilizer.
ON	Activates image stabilizer.
ON(A.I.S.)	Reduces camera shake more effectively when shooting bright scenes on the wide angle end. *Only on the wide angle end (approx. 5x)

### NOTE:

- It is recommended to set this mode to "OFF" when using a tripod and recording a subject with little movement.
- Complete stabilization may not be possible if camera shake is excessive.

### Displaying the Item

1 Press MENU to display the menu.

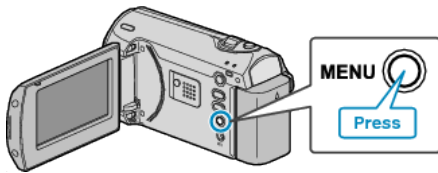

2 Select "DIS" with the ZOOM/SELECT lever and press OK.

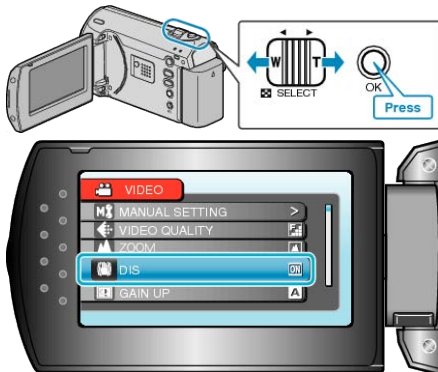

## GAIN UP

Makes the subject appear bright automatically when recording in dark places.

Setting	Details
OFF	Deactivates the function.
AGC	Electrically brightens the scene when it is dark.
AUTO	Automatically brightens the scene when it is dark.

### NOTE:

- Although "AUTO" brightens the scene more than "AGC", movements of the subject may become unnatural.

### Displaying the Item

1 Press MENU to display the menu.

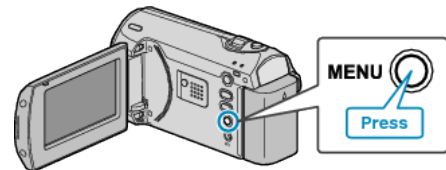

2 Select "GAIN UP" with the ZOOM/SELECT lever and press OK.

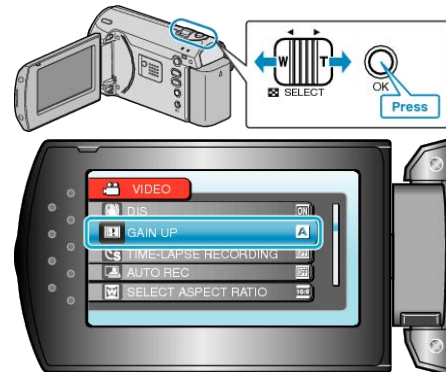



### TIME-LAPSE RECORDING

This function enables the changes of a scene that occur slowly over a long period to be shown within a short time by taking frames of it at a certain interval.

This is useful for making observations such as the opening of a flower bud.

Operating Details

"Recording at Intervals (TIME-LAPSE RECORDING)" (P.26)

### AUTO REC

Records automatically by sensing the changes in brightness.

Operating Details

"Recording Automatically by Sensing Movements (AUTO REC)" (P.28)

### SELECT ASPECT RATIO

Recording with aspect ratio 16:9 or 4:3 can be performed.

Setting	Details
16:9	Sets the aspect ratio to 16:9.
4:3	Sets the aspect ratio to 4:3.

#### Displaying the Item

1 Press MENU to display the menu.

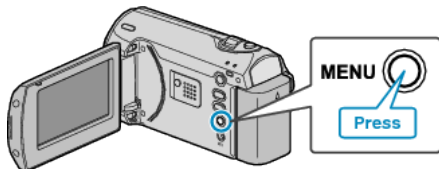

2 Select "SELECT ASPECT RATIO" with the ZOOM/SELECT lever and press OK.

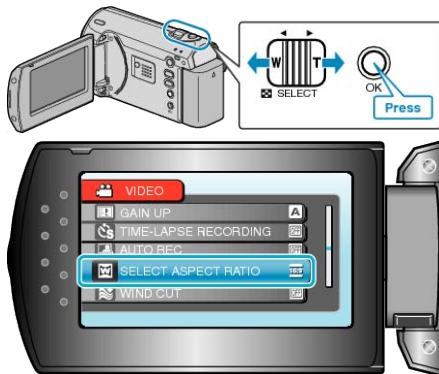

### WIND CUT

Reduces the noise caused by wind.

Setting	Details
OFF	Deactivates the function.
ON	Activates the function.

#### Displaying the Item

1 Press MENU to display the menu.

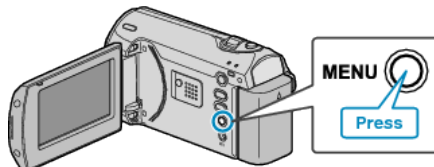

2 Select "WIND CUT" with the ZOOM/SELECT lever and press OK.

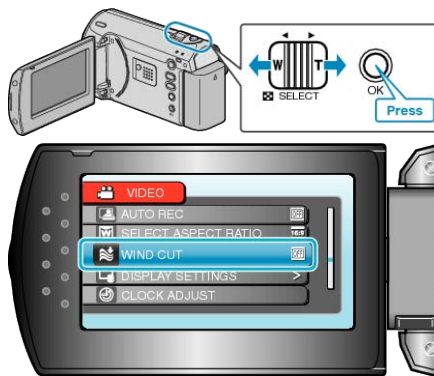

## Manual Settings Menu

Recording settings can be adjusted manually.

**NOTE:**

- They are displayed only when recording in the manual mode.

Setting	Details
SCENE SELECT	Settings to suit the shooting condition can be selected. "Scene Selection" (P.20)
FOCUS	Focus can be adjusted manually. "Adjusting Focus Manually" (P.21)
BRIGHTNESS ADJUST	Adjusts the overall brightness of the screen. "Adjusting Brightness" (P.22)
SHUTTER SPEED	Shutter speed can be adjusted. "Setting Shutter Speed" (P.23)
WHITE BALANCE	Adjusts the color according to the light source. "Setting White Balance" (P.24)
BACKLIGHT COMP.	Corrects the image when the subject appears dark due to backlight. "Setting Backlight Compensation" (P.24)
METERING AREA/ TYPE	Enables you to adjust the brightness in the desired area. "Setting Metering Area" (P.25)
TELE MACRO	Enables close-up shots when using the telephoto (T) end of the zoom. "Taking Close-up Shots" (P.25)

### SCENE SELECT

Settings to suit the shooting condition can be selected.

Operating Details

"Scene Selection" (P.20)

### FOCUS

Focus can be adjusted automatically or manually.

Operating Details

"Adjusting Focus Manually" (P.21)

### BRIGHTNESS ADJUST

Adjusts the overall brightness of the screen.

Operating Details

"Adjusting Brightness" (P.22)

### SHUTTER SPEED

Shutter speed can be adjusted.

Operating Details

"Setting Shutter Speed" (P.23)

### WHITE BALANCE

Adjusts the color according to the light source.

Operating Details

"Setting White Balance" (P.24)

### BACKLIGHT COMP.

Corrects the image when the subject appears dark due to backlight.

Operating Details

"Setting Backlight Compensation" (P.24)

### METERING AREA/TYPE

Enables you to adjust the brightness in the desired area.

Operating Details

"Setting Metering Area" (P.25)

### TELE MACRO

Enables close-up shots when using the telephoto (T) end of the zoom.

Operating Details

"Taking Close-up Shots" (P.25)

## Playback Menu

You can delete or look for specific videos.

Setting	Details
DELETE	Deletes unwanted videos. "Deleting the Currently Displayed File" (P.33) "Deleting Selected Files" (P.33) "Deleting All Files" (P.34)
SEARCH	You can search and play videos according to recording dates. "Searching for a Specific Video Image" (P.31)
PLAYBACK MPG FILE	Plays videos with defective management information. "Playing a Video with Defective Management Information" (P.31)
PROTECT/CANCEL	Protects files from being deleted accidentally. "Protecting the Currently Displayed File" (P.35) "Protecting Selected Files" (P.36) "Protecting All Files" (P.36) "Releasing Protection of All Files" (P.37)
ON-SCREEN DISPLAY	Sets whether to show on-screen displays such as icons during playback. "ON-SCREEN DISPLAY" (P.51)

### DELETE

Deletes unwanted videos.

Operating Details

"Deleting the Currently Displayed File" (P.33)

"Deleting Selected Files" (P.33)

"Deleting All Files" (P.34)

### SEARCH

You can search and play videos according to recording dates.

Operating Details

"Searching for a Specific Video Image" (P.31)

### PLAYBACK MPG FILE

Plays videos with defective management information.

Operating Details

"Playing a Video with Defective Management Information" (P.31)

### PROTECT/CANCEL

Protects files from being deleted accidentally.

Operating Details

"Protecting the Currently Displayed File" (P.35)

"Protecting Selected Files" (P.36)

"Protecting All Files" (P.36)

"Releasing Protection of All Files" (P.37)

### ON-SCREEN DISPLAY

Sets whether to show on-screen displays such as icons during playback.

Setting	Details
OFF	No display at all.
DISPLAY ALL	Displays everything.
DISPLAY DATE ONLY	Displays the date only.

#### Displaying the Item

1 Select the playback mode.

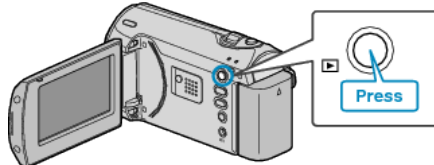

2 Press MENU to display the menu.

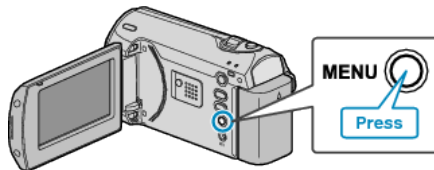

3 Select "ON-SCREEN DISPLAY" with the ZOOM/SELECT lever and press OK.

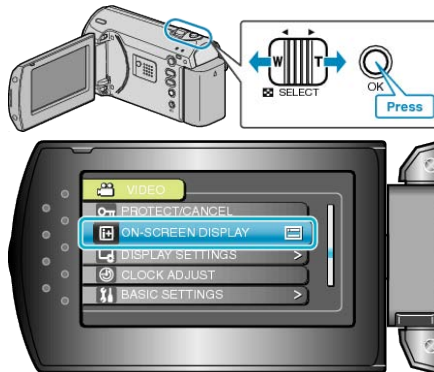

## Display Settings Menu

You can adjust various display settings such as the LCD monitor's brightness, etc.

Setting	Details
LANGUAGE	The language on the display can be changed. "Changing the Display Language" (P.15)
DATE DISPLAY STYLE	Sets the order of year, month, day and the time display format (24H/12H). "DATE DISPLAY STYLE" (P.52)
MONITOR BRIGHTNESS	Sets the brightness of the LCD monitor. "MONITOR BRIGHTNESS" (P.53)
LCD BACKLIGHT	Sets the brightness of the backlight of the monitor. "LCD BACKLIGHT" (P.53)

### LANGUAGE

The language on the display can be changed.  
Operating Details  
"Changing the Display Language" (P.15)

### DATE DISPLAY STYLE

Sets the order of year, month, day and the time display format (24H/12H).

1 Press MENU to display the menu.

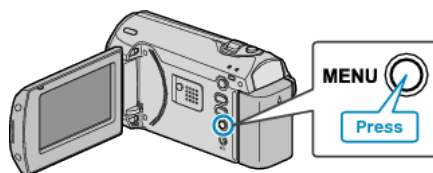

2 Select "DISPLAY SETTINGS" with the ZOOM/SELECT lever and press OK.

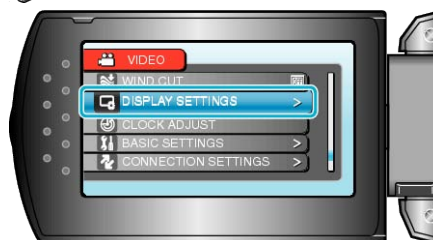
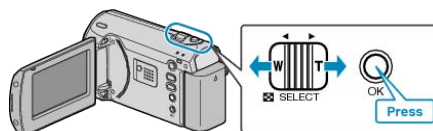

3 Select "DATE DISPLAY STYLE" and press OK.

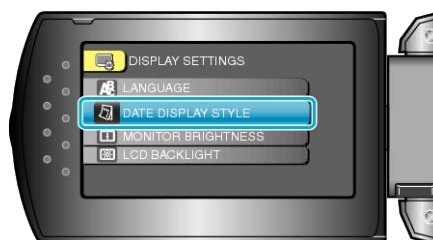

4 Set the style of date and time display.



- For date display, set to any format from "month.day.year", "year.month.day", and "day.month.year".
- For time display, set to any format from "12h" and "24h".
- Use the ZOOM/SELECT lever to move the cursor and press the +/- buttons to make changes.
- After setting, press OK.

## MONITOR BRIGHTNESS

Sets the brightness of the LCD monitor.

- 1 Press MENU to display the menu.

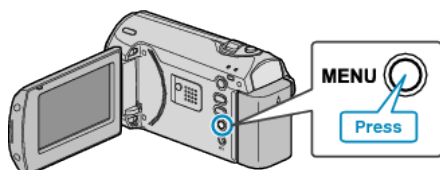

- 2 Select "DISPLAY SETTINGS" with the ZOOM/SELECT lever and press OK.

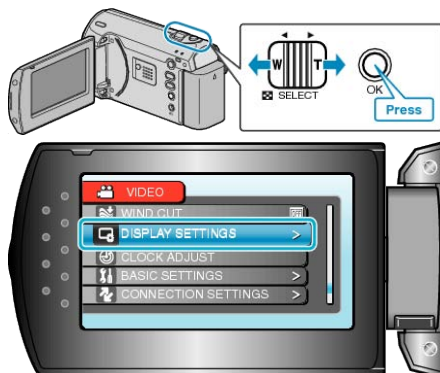

- 3 Select "MONITOR BRIGHTNESS" and press OK.



- 4 Adjust the brightness of the monitor.

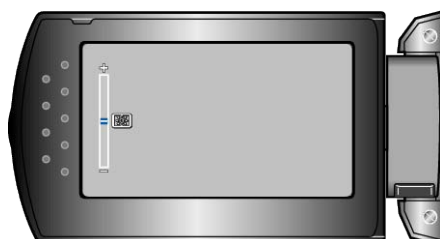

- Press + to increase the brightness.
- Press - to decrease the brightness.
- After setting, press OK.

## LCD BACKLIGHT

Sets the brightness of the backlight of the monitor.

Setting	Details
BRIGHTER	Brightens the backlight of the monitor regardless of the surrounding conditions.
STANDARD	Helps to save battery life when selected.
AUTO	Sets the brightness automatically to "BRIGHTER" when using outdoors and to "STANDARD" when using indoors.

### Displaying the Item

- 1 Press MENU to display the menu.

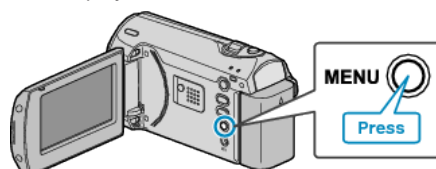

- 2 Select "DISPLAY SETTINGS" with the ZOOM/SELECT lever and press OK.

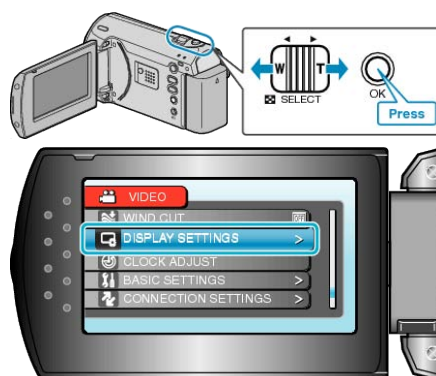

- 3 Select "LCD BACKLIGHT" and press OK.



## CLOCK ADJUST

Resets the current time or sets to the local time when using this unit overseas.

Operating Details

"Clock Setting" (P.13)

"Setting the Clock to Local Time when Traveling" (P.16)

"Setting Daylight Saving Time" (P.17)

### Basic Settings Menu

You can adjust various camera settings such as operation sound, etc.

Setting	Details
DEMO MODE	Introduces the special features of this unit in digest form. "DEMO MODE" (P.55)
AUTO POWER OFF	Prevents the situation of forgetting to turn off the power when this is set. "AUTO POWER OFF" (P.55)
OPERATION SOUND	Turns on or off the operation sound. "OPERATION SOUND" (P.56)
QUICK RESTART	Reduces the power consumption within 5 minutes after the LCD monitor is closed to 1/3 of that used during recording. "QUICK RESTART" (P.56)
UPDATE	Updates the functions of this unit to the latest version. "UPDATE" (P.57)
FACTORY PRESET	Returns all the settings to their default values. "FACTORY PRESET" (P.57)

**DEMO MODE**

Starts playback of the demo mode which introduces the features of this unit.

Setting	Details
OFF	Deactivates the function.
ON	Plays a demonstration of the special features of this unit.

**Displaying Demo Mode**

- ① Remove the battery pack and SD card.
- ② Connect the AC adapter.
- ③ Open the LCD monitor and turn on the power.
  - Demonstration starts playing after 3 minutes.
  - To stop playback, press OK.

**NOTE:**

- This mode is not available in the playback mode.

**Displaying the Item**

1 Press MENU to display the menu.

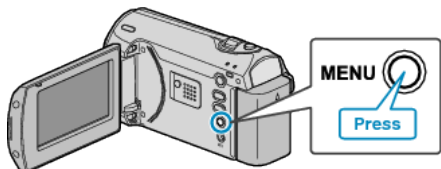

2 Select "BASIC SETTINGS" with the ZOOM/SELECT lever and press OK.



3 Select "DEMO MODE" and press OK.

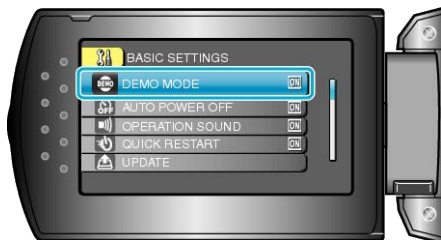

**AUTO POWER OFF**

Prevents the situation of forgetting to turn off the power when this is set.

Setting	Details
OFF	Power is not turned off even if this unit is not operated for 5 minutes.
ON	Turns off the power automatically if this unit is not operated for 5 minutes.

**NOTE:**

- When using battery, power is turned off automatically if this unit is not operated for 5 minutes.
- When using the AC adapter, this unit goes into standby mode.

**Displaying the Item**

1 Press MENU to display the menu.

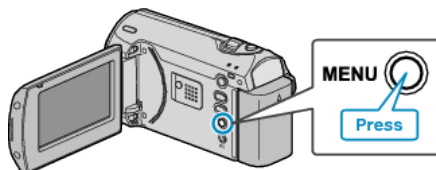

2 Select "BASIC SETTINGS" with the ZOOM/SELECT lever and press OK.

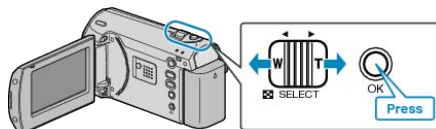

3 Select "AUTO POWER OFF" and press OK.

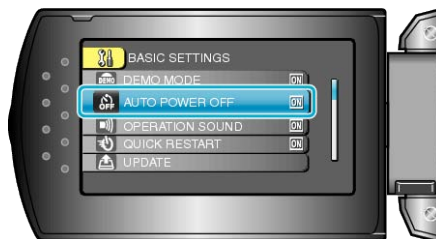

## OPERATION SOUND

Turns on or off the operation sound.

Setting	Details
OFF	Turns off the operation sound.
ON	Turns on the operation sound.

### Displaying the Item

1 Press MENU to display the menu.

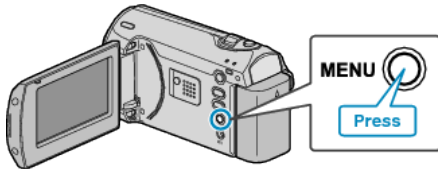

2 Select "BASIC SETTINGS" with the ZOOM/SELECT lever and press OK.

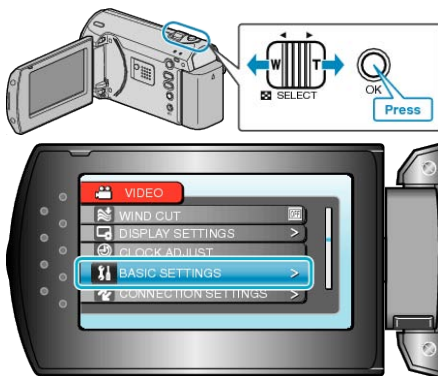

3 Select "OPERATION SOUND" and press OK.



## QUICK RESTART

Enables recording to be performed immediately when the LCD monitor is opened.

Setting	Details
OFF	Deactivates the function.
ON	Enables the power to turn on quickly when the LCD monitor is opened again within 5 minutes.

### NOTE:-

- The power consumption within 5 minutes after the LCD monitor is closed is reduced to 1/3 of that used during recording.

### Displaying the Item

1 Press MENU to display the menu.

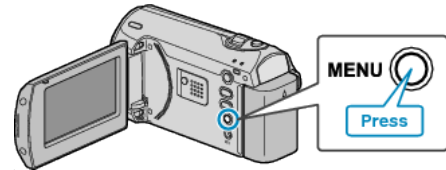

2 Select "BASIC SETTINGS" with the ZOOM/SELECT lever and press OK.

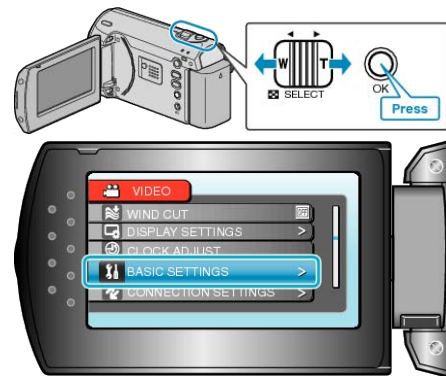

3 Select "QUICK RESTART" and press OK.

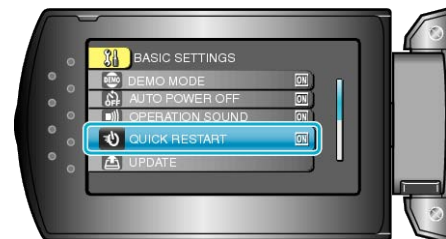



## UPDATE

Updates the functions of this unit to the latest version.

For details, refer to the JVC homepage.

(When no program to update the software of this unit is available, nothing will be provided on the homepage.)

## FACTORY PRESET

Returns all the settings to their default values.

1 Press MENU to display the menu.

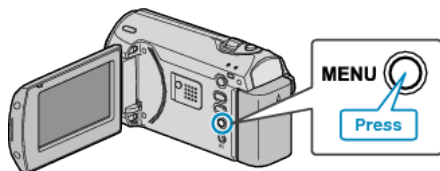

2 Select "BASIC SETTINGS" with the ZOOM/SELECT lever and press OK.

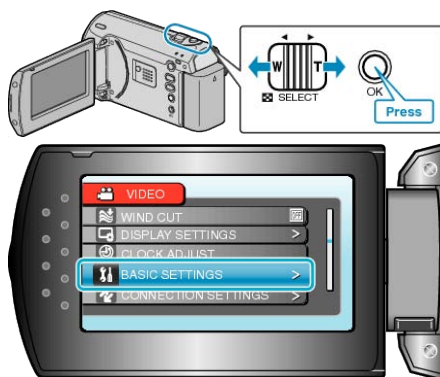

3 Select "FACTORY PRESET" and press OK.



4 Select "YES" and press OK.



- All settings return to their default values.

## Connection Settings Menu

You can adjust various settings for connecting to a TV or DVD recorder.

Setting	Details
DISPLAY ON TV	Displays icons and date/time on a TV screen. "DISPLAY ON TV" (P.58)
VIDEO OUTPUT	Sets the aspect ratio (16:9 or 4:3) according to the connecting TV. "VIDEO OUTPUT" (P.58)

### DISPLAY ON TV

Displays icons and date/time on a TV screen.

Setting	Details
OFF	Does not display icons and date/time on TV.
ON	Displays icons and date/time on TV.

#### Displaying the Item

1 Press MENU to display the menu.

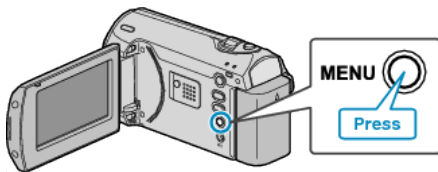

2 Select "CONNECTION SETTINGS" with the ZOOM/SELECT lever and press OK.

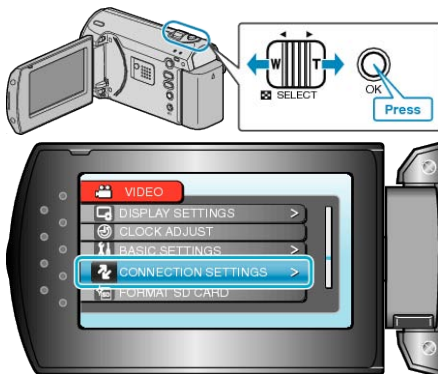

3 Select "DISPLAY ON TV" and press OK.



### VIDEO OUTPUT

Sets the aspect ratio (16:9 or 4:3) according to the connecting TV.

Setting	Details
16:9	Select this when connecting to a widescreen TV (16:9).
4:3	Select this when connecting to a conventional TV (4:3).

#### Displaying the Item

1 Press MENU to display the menu.

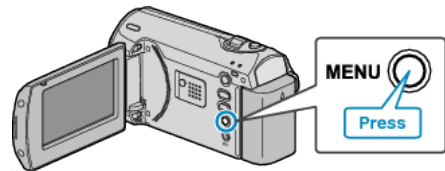

2 Select "CONNECTION SETTINGS" with the ZOOM/SELECT lever and press OK.

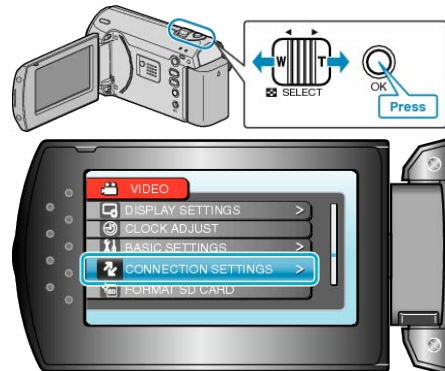

3 Select "VIDEO OUTPUT" and press OK.



## FORMAT SD CARD

Deletes all files on the SD card.

Setting	Details
FILE	Deletes all files on the SD card.
FILE + MANAGEMENT NO	Deletes all files on the SD card and resets the folder and file numbers to "1".

### CAUTION:

- Not available for selection when no SD card is inserted.
- All data on the card will be deleted when it is formatted. Copy all files on the card to a PC before formatting.
- Make sure that the battery pack is fully charged or connect the AC adapter as the formatting process may take some time.

### Displaying the Item

1 Press MENU to display the menu.

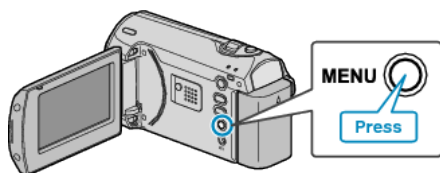

2 Select "FORMAT SD CARD" with the ZOOM/SELECT lever and press OK.

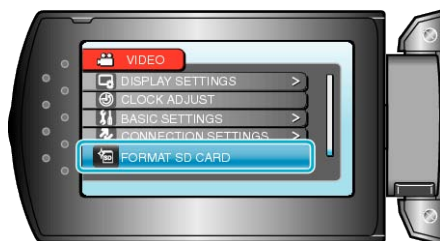

Front

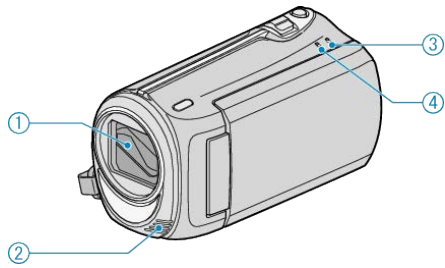

**1** Lens/Lens Cover

- Do not touch the lens and lens cover.

**2** Monaural Microphone

- Do not cover the microphone with your fingers during video recording.

**3** POWER/CHARGE Lamp

- Lights up: Power "ON"
- Blinks: Charging in progress
- Goes out: Charging finished

**4** ACCESS Lamp

- Recording or playback is in progress when the lamp lights up or blinks. Do not remove the battery pack, AC adapter, or SD card.

Rear

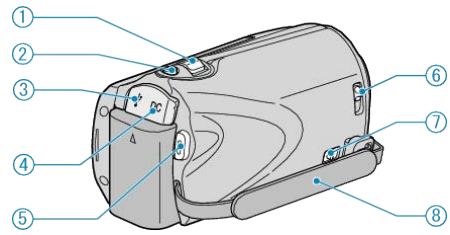

**1** ZOOM/SELECT Lever

- During shooting: Adjusts the shooting range.
- During playback: Performs forward search/reverse search.
- Selects item or file from the menu or index screen.

**2** OK Button

- During playback: Starts/pauses the playback of videos.
- Confirms the selected item or file from the menu or index screen.

**3** USB Terminal

- Connects to PC using a USB cable.

**4** DC Terminal

- Connects to an AC adapter to charge the battery.

**5** START/STOP (Video recording) Button

- During recording: Starts/stops video recording.
- During playback: Starts/pauses the playback of videos.

**6** Lens Cover Switch

- Opens and closes the lens cover.

**7** Grip Belt Release Lever

- Allows the grip belt to be removed and used as a hand strap.

**8** Grip Belt

- Pass your hand through the grip belt to hold this unit firmly. "Grip Adjustment" (P.12)

## Bottom

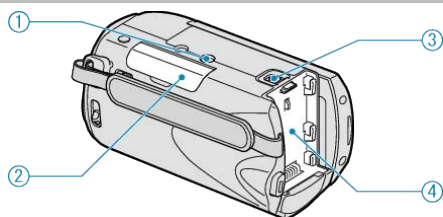
**1** Tripod Mounting Hole

"Tripod Mounting" (P.15)

**2** SD Card Slot

- Insert an optional SD card.

"Inserting an SD Card" (P.12)

"Types of Usable SD Card" (P.13)

**3** Battery Release Lever

"Charging the Battery Pack" (P.11)

**4** Battery Mount

## Interior

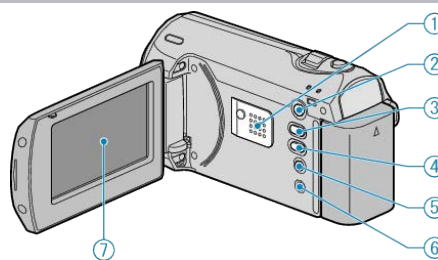
**1** Speaker

- Outputs audio sound during video playback.

**2**  (Play) Button

- Switches between the recording and playback modes.

**3**  (Recording Mode) / + Button

- During recording: Switches the recording mode (Auto/Manual).
- During playback: Increases the volume.

**4** INFO (Information) / - Button

- During recording: Displays the remaining time and battery power.
- During playback: Decreases the volume.
- During playback: Displays file information such as recording date.

**5** MENU Button

- Displays the settings menu.

**6** AV Terminal

- Connects to a TV.

**7** LCD Monitor

- Turns the power on/off by opening and closing.
- Enables self-portraits to be taken by rotating the monitor.

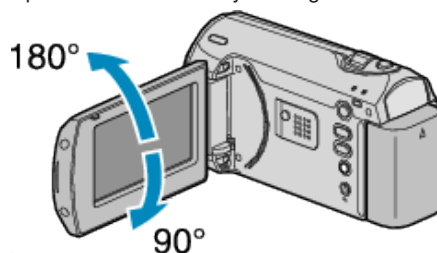
**CAUTION:**

- Do not press against the surface with force or subject it to strong impact.  
Doing so may damage or break the screen.

## Recording

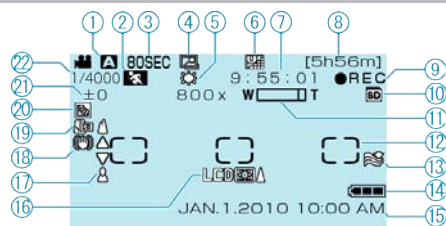

### 1 Recording Mode

"Taking Videos in Auto Mode" ( P.18)

"Manual Recording" ( P.19)

### 2 Scene Select

"Scene Selection" ( P.20)

### 3 Time-Lapse Recording

"Recording at Intervals (TIME-LAPSE RECORDING)" ( P.26)

### 4 Auto REC

"Recording Automatically by Sensing Movements (AUTO REC)" ( P.28)

### 5 White Balance

"Setting White Balance" ( P.24)

### 6 Video Quality

"VIDEO QUALITY" ( P.47)

### 7 Scene Counter

### 8 Remaining Recording Time

### 9 Recording in Progress

"Taking Videos in Auto Mode" ( P.18)

### 10 Media

### 11 Zoom

"ZOOM" ( P.47)

### 12 Metering Area "SPOT"

"Setting Metering Area" ( P.25)

### 13 Wind Cut

"WIND CUT" ( P.49)

### 14 Battery Indicator

"Remaining Recording Time/Battery Power" ( P.29)

### 15 Date/Time

"Clock Setting" ( P.13)

### 16 Monitor Backlight

"LCD BACKLIGHT" ( P.53)

### 17 Focus

"Adjusting Focus Manually" ( P.21)

### 18 DIS

"DIS" ( P.48)

### 19 Tele Macro

"Taking Close-up Shots" ( P.25)

### 20 Backlight Compensation

"Setting Backlight Compensation" ( P.24)

### 21 Brightness

"Adjusting Brightness" ( P.22)

### 22 Shutter Speed

"Setting Shutter Speed" ( P.23)

## Playback

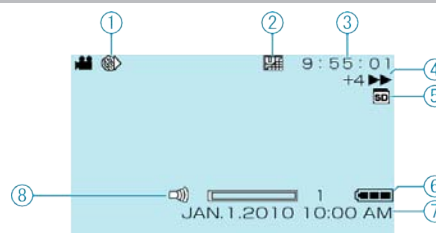

### 1 Time-Lapse Recording

"Recording at Intervals (TIME-LAPSE RECORDING)" ( P.26)

### 2 Video Quality

"VIDEO QUALITY" ( P.47)

### 3 Scene Counter

### 4 Operation Indicator

"Playing Back Videos" ( P.30)

### 5 Media

### 6 Battery Indicator

"Remaining Recording Time/Battery Power" ( P.29)

### 7 Date/Time

"Clock Setting" ( P.13)

### 8 Speaker Volume Adjustment

## Battery Pack

### Unable to turn on the power when using the battery pack.

Recharge the battery pack.  
"Charging the Battery Pack" (P.11)

If the terminal of this unit or the battery pack is dirty, wipe it with a cotton swab or something similar.

If you use any other battery packs besides JVC battery packs, safety and performance can not be guaranteed. Be sure to use JVC battery packs.

### Short usage time even after charging.

Battery deterioration occurs when a battery pack is charged repeatedly. Replace the battery pack with a new one.  
"Optional Accessories" (P.17)

### Unable to charge the battery pack.

If the terminal of this unit or the battery pack is dirty, wipe it with a cotton swab or something similar.

Using a non-original battery pack may result in damage to this unit. Be sure to use an original battery pack.

### The remaining battery display is not correct.

Remaining battery power is not displayed when the AC adapter is connected.

If this unit is used for long periods of time in high or low temperatures, or if the battery pack is repeatedly charged, the amount of remaining battery may not be displayed correctly.

## Recording

### Recording cannot be performed.

Set to the recording mode with the  (Play) Button.  
"Interior" (P.61)

### The focus is not adjusted automatically.

If you are recording in a dark place or a subject that has no contrast between dark and light, adjust the focus manually.

"Adjusting Focus Manually" (P.21)

Wipe the lens with a lens cleaning cloth.

Cancel manual focus on the manual recording menu.

"Adjusting Focus Manually" (P.21)

### The zoom does not work.

Zoom operation is not available in time-lapse recording.  
(Image stabilizer is also not available.)

To use digital zoom, set "ZOOM" in the menu to "90x/DIGITAL" or "800x/DIGITAL".

"ZOOM" (P.47)

## Card

### Cannot insert the SD card.

Make sure not to insert the card in the wrong direction.  
"Inserting an SD Card" (P.12)

### Unable to copy to SD card.

To use cards that have been used on other devices, it is necessary to format (initialize) the card using "FORMAT SD CARD".

"FORMAT SD CARD" (P.59)

## Playback

### Sound or video is interrupted.

Sometimes playback is interrupted at the connecting section between two scenes. This is not a malfunction.

### The same image is displayed for a long time.

Replace the SD card. (When the SD card is damaged, difficulty in reading the data occurs. This unit will try to play back as much as possible, but it will stop eventually if the condition persists.)

Execute "FORMAT SD CARD". (All data will be deleted.)

"FORMAT SD CARD" (P.59)

### The motion is choppy.

Replace the SD card. (When the SD card is damaged, difficulty in reading the data occurs. This unit will try to play back as much as possible, but it will stop eventually if the condition persists.)

Execute "FORMAT SD CARD". (All data will be deleted.)

"FORMAT SD CARD" (P.59)

### Cannot find a recorded file.

Cancel date search functions.

"Searching for a Specific Video Image" (P.31)

Select "PLAYBACK MPG FILE" then search the video on the index screen. (Video files that have damaged management information can be played back.)

"Playing a Video with Defective Management Information" (P.31)

### No date/time display.

Set "ON-SCREEN DISPLAY" in the menu accordingly.

"ON-SCREEN DISPLAY" (P.51)

Set "DISPLAY ON TV" in the menu to "ON".

"DISPLAY ON TV" (P.58)

### Images are projected vertically on the TV.

Set "VIDEO OUTPUT" in the connection settings menu to "4:3".

"VIDEO OUTPUT" (P.58)

Adjust the TV's screen accordingly.

### The image displayed on TV is too small.

Set "VIDEO OUTPUT" in the connection settings menu to "16:9".

"VIDEO OUTPUT" (P.58)

### Unable to delete file.

Files that are protected cannot be deleted. Release protection before deleting the file.

"Protecting Files" (P.35)

## PC

### Unable to copy files to the PC's HDD.

Connect the USB cable correctly.

"Backing Up All Files" (P.39)

## Troubleshooting

If the provided software "Everio MediaBrowser" is not installed, some functions may not work properly.

"Installing the Provided Software" (P.38)

Before making backup, make sure that enough free space is left in the PC's hard disk (HDD).

### Unable to copy files to DVD with a PC.

To record to discs, a recordable DVD drive is required for the PC in use.

### Cannot upload the file to YouTube.

Check if you have created an account with YouTube. (You need a YouTube account to upload files to YouTube.)

Refer to "Q&A", "Latest Information", "Download Information", etc. in "Click for Latest Product Info" in the help file of the provided Everio MediaBrowser software.

## Screen/Image

### The LCD monitor is difficult to see.

The LCD monitor may be difficult to see if used in bright areas such as under direct sunlight.

### A band or a ball of bright light appears on the LCD monitor.

Change the direction of this unit to prevent the light source from coming into view. (A band or a ball of bright light may appear when there is a bright light source near this unit, but this is not a malfunction.)

### The recorded subject is too dark.

Use backlight compensation when the background is bright and the subject is dark.

"Setting Backlight Compensation" (P.24)

Use "NIGHT EYE" in SCENE SELECT.

"Scene Selection" (P.20)

Use "GAIN UP" in the menu.

"GAIN UP" (P.48)

Set "BRIGHTNESS ADJUST" in the manual settings menu to the "+" side.

"Adjusting Brightness" (P.22)

### The recorded subject is too bright.

Set the backlight compensation to "OFF" if it is being used.

"Setting Backlight Compensation" (P.24)

Set "BRIGHTNESS ADJUST" in the manual settings menu to the "-" side.

"Adjusting Brightness" (P.22)

### The color looks strange. (Too bluish, too reddish, etc.)

Wait for a while until natural colors are achieved. (It may take some time for white balance to be adjusted.)

Set "WHITE BALANCE" in the manual settings menu to "MANUAL". Select from "FINE"/"CLOUD"/"HALOGEN" according to the light source. Select "MWB" and adjust accordingly.

"Setting White Balance" (P.24)

## Other Problems

### The unit operates slowly when switching the power on or off.

It is recommended that you copy all videos onto your PC, and erase the files from this unit.

(If there are many recorded files on this unit, it takes time for the unit to respond.)

### The image is grainy.

When digital zoom is used, the image becomes grainy as it is digitally enlarged.

### The unit heats up.

This is not a malfunction. (This unit may become warm when used for a long time.)

### Make a backup of important recorded data.

It is recommended to copy your important recorded data to a DVD or other recording media for storage. JVC will not be responsible for any lost data.



## Error Message?

### CHECK LENS COVER

Open the lens cover.

### COMMUNICATION ERROR

Reconnect the USB cable.  
Turn off this unit and the devices connected to it, and turn them on again.  
Reattach the battery pack.

### FORMAT ERROR!

Check the operating procedure, and perform once again.  
"FORMAT SD CARD" (P.59)  
Turn off this unit, and turn it on again.

### MEMORY CARD ERROR!

Turn off this unit, and turn it on again.  
Remove and re-insert the SD card after detaching the AC adapter and battery pack.  
Remove any dirt from the SD card terminals.  
If the above does not solve the problem, back up your files and execute "FORMAT SD CARD". (All data will be deleted.)  
"FORMAT SD CARD" (P.59)

### NOT FORMATTED

Select "OK", then select "YES" on the "DO YOU WANT TO FORMAT?" screen.

### RECORDING FAILURE

Turn off this unit, and turn it on again.

### VIDEO MANAGEMENT FILE IS DAMAGED, RECOVERY IS REQUIRED TO RECORD/PLAYBACK, RECOVER?

Select "OK" to restore. (Videos that cannot be restored will not be displayed on the index screen, but you may be able to play them back using "PLAYBACK MPG FILE" in the menu.)  
"Playing a Video with Defective Management Information" (P.31)

### UNSUPPORTED SCENE!

Use files recorded with this unit. (Files recorded with other devices may not be playable.)

### THIS FILE IS PROTECTED

Switch off the protect function in "PROTECT/CANCEL".  
"Protecting Files" (P.35)

### CHECK CARD'S WRITE PROTECTION SWITCH

Set the write protect switch of the SD card to off.

### INSUFFICIENT AVAILABLE SPACE

Delete files, or move files to a PC or other devices.  
Replace the SD card with a new one.

### MAXIMUM QUANTITY RECORDING FOLDERS/FILES HAS BEEN REACHED

① Move the files or folders to a PC or other device. (Back up your files.)  
② Select "FILE + MANAGEMENT NO" in "FORMAT SD CARD". (All data on the SD card will be deleted.)

### NUMBER OF FOLDERS OVERFLOW

① Move the files or folders to a PC or other device. (Back up your files.)  
② Select "FILE + MANAGEMENT NO" in "FORMAT SD CARD". (All data on the SD card will be deleted.)

### FILE QUANTITY LIMIT EXCEEDED

① Move the files or folders to a PC or other device. (Back up your files.)  
② Select "FILE + MANAGEMENT NO" in "FORMAT SD CARD". (All data on the SD card will be deleted.)

## Maintenance

---

Perform regular maintenance of this unit to enable it to be used for a long time.

### CAUTION:

- Be sure to detach the battery pack, AC adapter, and power plug before performing any maintenance.
- 

## Camcorder

- Wipe this unit with a dry, soft cloth to remove any dirt.
- When it is extremely dirty, soak the cloth in a solution of neutral detergent, wipe the body with it, and then use a clean cloth to remove the detergent.

### CAUTION:

- Do not use benzene or thinner. Doing so may cause damage to the unit.
  - When using a chemical cloth or cleaner, be sure to observe the warning labels and instructions of the product.
  - Do not leave the device in contact with rubber or plastic products for a long time.
- 

## Lens/LCD Monitor

- Use a lens blower (commercially available) to remove any dust, and a cleaning cloth (commercially available) to wipe off any dirt.  
Mold may form if the lens is left dirty.

## Camera

Item	Details
Power supply	Using AC adapter: DC 5.2 V Using battery pack: DC 3.6 V
Power consumption	1.5 W (when "LCD BACKLIGHT" is set to "STANDARD")
Dimensions (mm)	52 x 62 x 110 (2-1/8" x 2-1/2" x 4-3/8") (W x H x D: excluding grip belt)
Mass	Approx. 195 g (0.43 lbs) (camera only), Approx. 220 g (0.49 lbs) (including supplied battery pack)
Operating environment	Allowable operating temperature: 0°C to 40°C (32°F to 104°F) Allowable storage temperature: -20°C to 50°C (-4°F to 122°F) Allowable operating humidity: 35 % to 80 %
Image pickup device	1/6" 800.000 pixels
Recording area	410.000 pixels (optical zoom) 410.000 to 550.000 pixels (dynamic zoom)
Lens	F1.8 to F4.3, f= 2.2 mm to 85.8 mm (35 mm conversion: 41.5 mm to 1,619 mm)
Lowest illumination	3 lux (Shutter speed: AUTO + AGC) 1 lux (NIGHT EYE mode)
Zoom	Optical zoom: Up to 39x Dynamic zoom: Up to 45x Digital zoom: Up to 800x
LCD monitor	2.7" wide, 12.3 megapixels, polysilicon color LCD
Recording media	SD/SDHC card (commercially available) "Types of Usable SD Card" (P.13)
Clock battery	Disposable battery

## Video

Item	Details
Recording/Playback format	SD-VIDEO standard, Video: MPEG-2, Audio: Dolby Digital(2ch)
Extension	.MOD
Signal system	NTSC standard
Image quality/ Sound quality	ULTRA FINE : 720 pixels x 480 pixels, 8.5 Mbps VBR (Video), 48 kHz, 384 kbps (Audio) FINE : 720 pixels x 480 pixels, 5.5 Mbps VBR (Video), 48 kHz, 384 kbps (Audio) NORMAL : 720 pixels x 480 pixels, 4.2 Mbps VBR (Video), 48 kHz, 256 kbps (Audio) ECONOMY : 352 pixels x 240 pixels, 1.5 Mbps VBR (Video), 48 kHz, 128 kbps (Audio)

## AC Adapter (AP-V30U)

Item	Details
Power supply	AC 110 V to 240 V, 50 Hz/60 Hz
OUTPUT	DC 5.2 V, 1.8 A
Allowable operating temperature	0°C to 40°C (32°F to 104°F) (10°C to 35°C (50°F to 95°F) during charging)
Dimensions (mm)	78 x 34 x 46 (3-1/8" x 1-3/8" x 1-13/16") (W x H x D: excluding cord and AC plug)
Mass	Approx. 107 g (0.24 lbs)

## Battery Pack (BN-VG107U)

Item	Details
Power voltage	3.6 V
Capacity	700 mAh
Dimensions (mm)	31 x 21.5 x 43 (1-1/4" x 7/8" x 1-3/4") (W x H x D)
Mass	Approx. 26 g (0.06 lbs)

"Optional Accessories" (P.17)

# JVC

## Free Manuals Download Website

<http://myh66.com>

<http://usermanuals.us>

<http://www.somanuals.com>

<http://www.4manuals.cc>

<http://www.manual-lib.com>

<http://www.404manual.com>

<http://www.luxmanual.com>

<http://aubethermostatmanual.com>

Golf course search by state

<http://golfingnear.com>

Email search by domain

<http://emailbydomain.com>

Auto manuals search

<http://auto.somanuals.com>

TV manuals search

<http://tv.somanuals.com>