

1777 Series Folding Door Hardware

For 1 1/8" or 1 3/8" thick doors weighing up to 35 pounds per panel

SEE REVERSE SIDE FOR ADDITIONAL INSTRUCTIONS

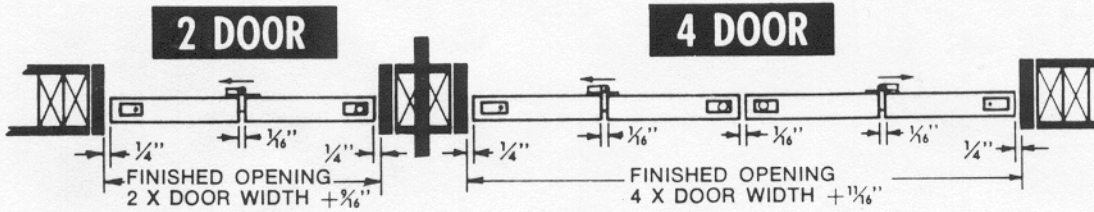

Johnson 1777 Series features track built into a replacement header for walls up to 5 1/4" deep. If used with 4 9/16" jambs, rip wide part of header to narrower width. Track length is factory cut for use with standard width doors. If other door widths are encountered, figure finished width from formula, add 1/2" for dadoes, and cut to proper length at end opposite pivot socket (2 door), or equally at both ends (4 door), moving pivot sockets accordingly.

With narrow 1" depth of header facing front, assemble frame by slipping header into jamb dadoes and nail in place. Place frame into rough opening, shim for perfect squareness (plumb and level) and nail into place.

Lay doors GOOD SIDE DOWN, flat and even. Fasten 1703 Hinges as shown, 7" from top and 11" from bottom, sliding "fingers" of hinge between doors. Long leg of nylon block on hinge should face pivot jamb. Use 5/8" screws. Place center hinge midway between top and bottom hinges.

Using template, fasten top pivot to top edge of 1st and/or 4th doors as stamped on pivot plate. (NOTE: Both top and bottom pivot pins are positioned furthest from door edge. Guide, with nylon roller, is closest to door edge.)

Fasten bottom pivot directly below top pivot on bottom edge of door.

Secure top guide to top edge of 2nd and/or 3rd door with guide nearest edge.

Fasten aligners, on 4 door units only, to BACK side of doors

6" from bottom so that fingers intermesh.

Attach knob. On flush doors, drill 3/16" hole 36" from bottom and 1 1/2" from hinge edge of #2 and/or #3 doors. On louvered doors, place knob to fit design of door. Fasten to front of panels.

HANG DOORS. Make sure track pivot lock is in OPEN position. Fold door pairs and insert Guide into track. Place door pivot pin into seat of track pivot lock until positioned firmly. Slide tab of pivot lock in, locking top pivot into place. Close doors. Fold template as shown for jamb bracket installation. Check to make sure there is a 7/8" clearance between bottom of door and floor. Let doors hang free. Place template on edge of door jamb and raise until template line is even with bottom edge of door. Hold template in place and swing doors aside. Using a punch, mark position of three screw holes on jamb. Remove template and fasten Jamb Bracket to jamb using these three holes. Depress spring loaded pivot socket on jamb bracket and position bottom door pivot pin over socket. Release socket, holding pin in place. Check for proper operation of doors. Doors should glide easily and quiet. If adjustments are necessary to achieve 1/4" clearance between door edge and jamb, or to have 1/16" clearance between center doors on 4 door installation, adjust either track pivot lock or jamb bracket.

Close doors, slide snubber until it touches top guide. Open doors, move snubber 1/8" closer to pivot jamb and tighten to track. Doors should "snap" shut and stay closed, yet open firmly when pulling knob. Always open or close doors with knob.

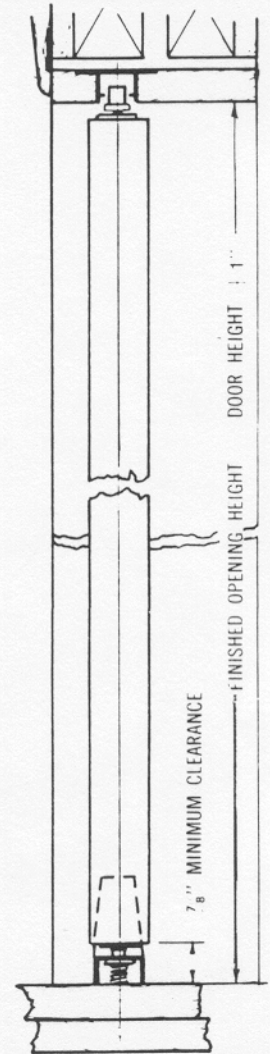

IN1777FD

CUT OFF ON THIS LINE FOR TEMPLATE

Rev. 7/93

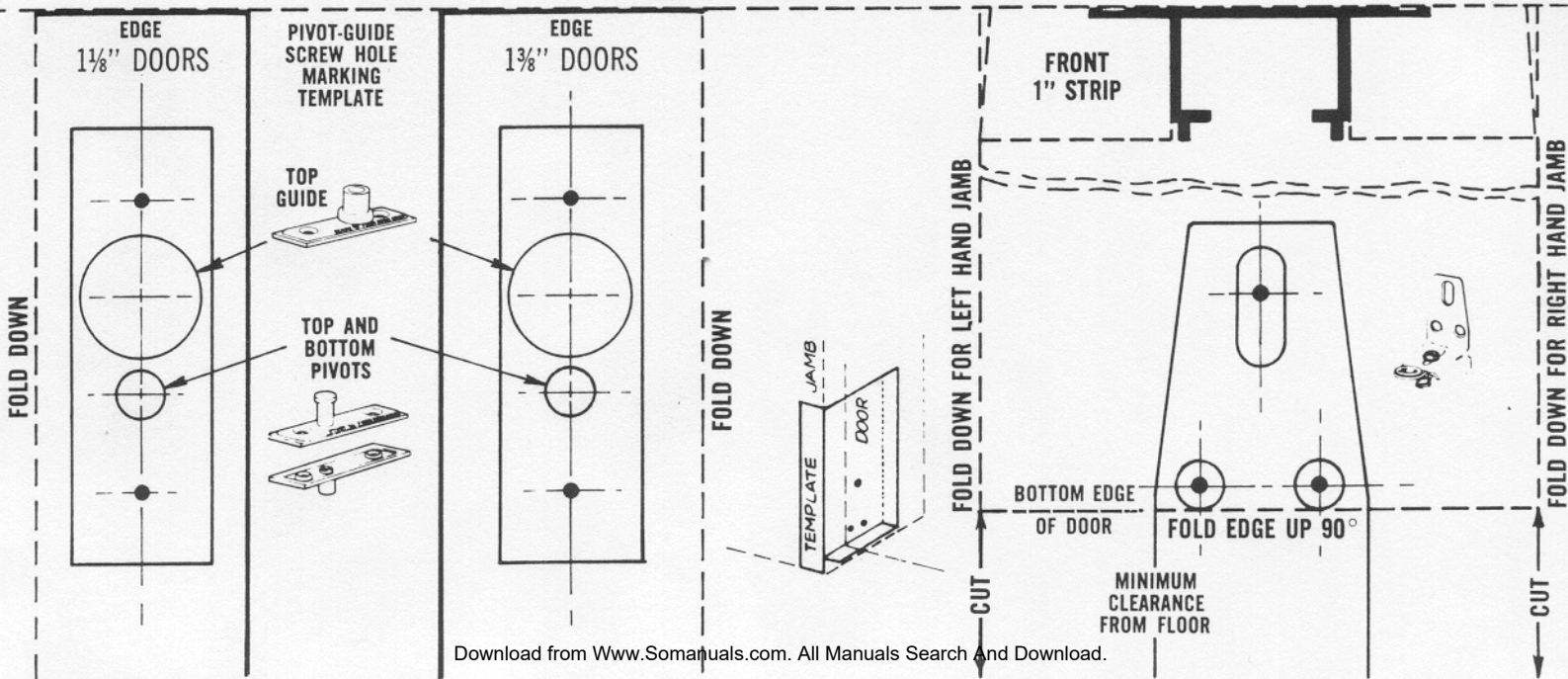

TOP GUIDE

TOP PIVOT

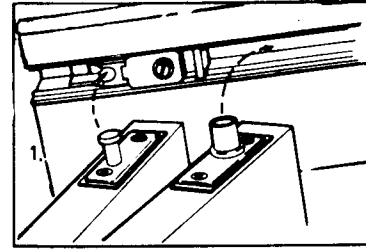
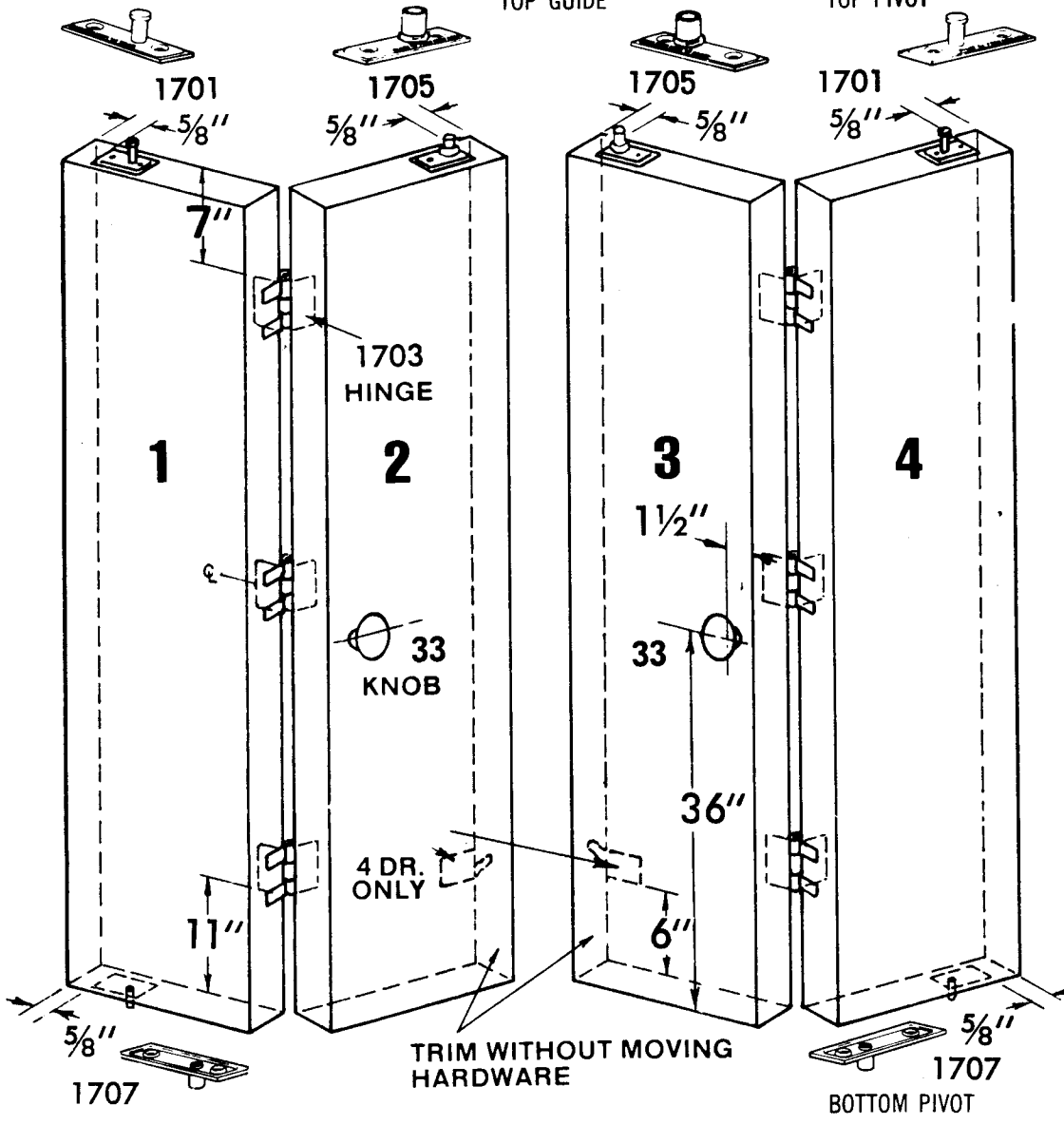

With doors hinged together and all pivots/guides attached, lift doors and insert nylon roller guide into track. Lift other panel (with top pivot) into receptacle in track pivot lock

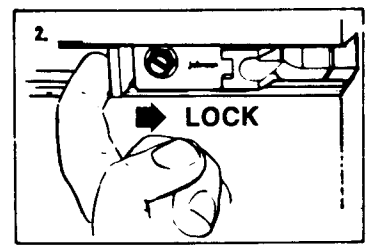

When pivot pin is securely seated, snap lock tab on pivot lock towards pin. This holds pivot pin in place.

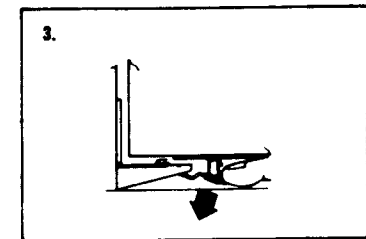

Depress spring pivot socket arm on jamb bracket as shown. Release to lock bottom pivot pin in place.

OPTIONAL ACCESSORIES

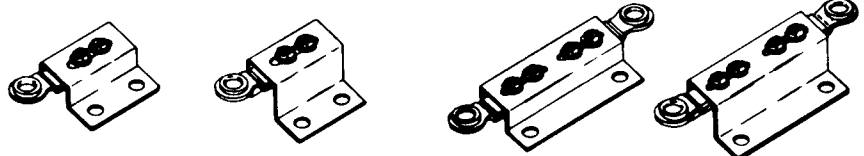

1704
3/4" High

1714
1 1/4" High

SINGLE FLOOR MOUNT BRACKETS. Reversible for either right or left hand operation. Replaces jamb mounted bracket.

1744
3/4" High

1754
1 1/4" High

DOUBLE FLOOR MOUNT BRACKETS. For more than four door installations

COMPLETE SET CONTENTS		
	2 Door Set	4 Door Set
#1777 TRACK	1	1
#1710 PIVOT LOCK	1	2
#1713 SNUBBER	1	2
#1701 PIVOT, TOP	1	2
#1702 GUIDE	1	2
#1703 HINGE	3	6
#33 KNOB	1	2
#1707 PIVOT, BOT.	1	2
#1711 JAMB BRKT.	1	2
#1808 ALIGNER	-	1
#1712 WRENCH	1	1

SIDE MOUNT PIVOTS ARE ALSO AVAILABLE FOR USE WITH DOOR PANEL MATERIALS THAT WILL NOT SUPPORT TOP EDGE MOUNTING. (Particle board, plywood, etc.)

Free Manuals Download Website

<http://myh66.com>

<http://usermanuals.us>

<http://www.somanuals.com>

<http://www.4manuals.cc>

<http://www.manual-lib.com>

<http://www.404manual.com>

<http://www.luxmanual.com>

<http://aubethermostatmanual.com>

Golf course search by state

<http://golfingnear.com>

Email search by domain

<http://emailbydomain.com>

Auto manuals search

<http://auto.somanuals.com>

TV manuals search

<http://tv.somanuals.com>