

JVC



LYT2077-003A

GUIDEBOOK

EN

HD MEMORY CAMERA

GZ-X900 **U**



Dear Customers

Thank you for purchasing this HD MEMORY CAMERA. Before use, please read the safety information and precautions contained in pages 2 and 3 to ensure safe use of this product.

For Future Reference:

Enter the Model No. (located on the bottom of the HD MEMORY CAMERA) and Serial No. (located on the battery pack mount of the HD MEMORY CAMERA) below.

Model No. _____

Serial No. _____



ENGLISH

Safety Precautions



The lightning flash with arrowhead symbol, within an equilateral triangle, is intended to alert the user to the presence of uninsulated "dangerous voltage" within the product's enclosure that may be of sufficient magnitude to constitute a risk of electric shock to persons.



The exclamation point within an equilateral triangle is intended to alert the user to the presence of important operating and maintenance (servicing) instructions in the literature accompanying the appliance.

WARNING: TO PREVENT FIRE OR SHOCK HAZARD, DO NOT EXPOSE THIS UNIT TO RAIN OR MOISTURE.

NOTES:

- The rating plate and safety caution are on the bottom and/or the back of the main unit.
- The serial number plate is on the battery pack mount.
- The rating information and safety caution of the AC adapter are on its upper and lower sides.

Caution on Replaceable lithium battery

The battery used in this device may present a fire or chemical burn hazard if mistreated.

Do not recharge, disassemble, heat above 100°C or incinerate.

Replace battery with Panasonic, Sanyo, Sony or Maxell CR2025.

Danger of explosion or Risk of fire if the battery is incorrectly replaced.

- Dispose of used battery promptly.
- Keep away from children.
- Do not disassemble and do not dispose of in fire.

For USA-California Only

This product contains a CR Coin Cell Lithium Battery which contains Perchlorate Material – special handling may apply.

See www.dtsc.ca.gov/hazardouswaste/perchlorate

When the equipment is installed in a cabinet or on a shelf, make sure that it has sufficient space on all sides to allow for ventilation (10 cm (3-15/16") or more on both sides, on top and at the rear). Do not block the ventilation holes.

(If the ventilation holes are blocked by a newspaper, or cloth etc. the heat may not be able to get out.)

No naked flame sources, such as lighted candles, should be placed on the apparatus.

When discarding batteries, environmental problems must be considered and the local rules or laws governing the disposal of these batteries must be followed strictly.

The apparatus shall not be exposed to dripping or splashing.

Do not use this equipment in a bathroom or places with water.

Also do not place any containers filled with water or liquids (such as cosmetics or medicines, flower vases, potted plants, cups etc.) on top of this unit. (If water or liquid is allowed to enter this equipment, fire or electric shock may be caused.)

Do not point the lens directly into the sun. This can cause eye injuries, as well as lead to the malfunctioning of internal circuitry. There is also a risk of fire or electric shock.

CAUTION!

The following notes concern possible physical damage to the camera and to the user.

Carrying or holding the camera by the LCD monitor can result in dropping the unit, or in a malfunction.

Do not use a tripod on unsteady or unlevel surfaces. It could tip over, causing serious damage to the camera.

CAUTION!

Connecting cables (Audio/Video, etc.) to the camera and leaving it on top of the TV is not recommended, as tripping on the cables will cause the camera to fall, resulting in damage.

CAUTION:

The mains plug shall remain readily operable.

WARNING:

The battery pack, the camera with battery installed, and the remote control with battery installed should not be exposed to excessive heat such as direct sunshine, fire or the like.

IMPORTANT SAFETY INSTRUCTIONS

1. Read these instructions.
2. Keep these instructions.
3. Heed all warnings.
4. Follow all instructions.
5. Do not use this apparatus near water.
6. Clean only with dry cloth.
7. Do not block any ventilation openings. Install in accordance with the manufacturer's instructions.
8. Do not install near any heat sources such as radiators, heat registers, stoves, or other apparatus (including amplifiers) that produce heat.
9. Protect the power cord from being walked on or pinched particularly at plugs, convenience receptacles, and the point where they exit from the apparatus.
10. Only use attachments/accessories specified by the manufacturer.
11. Use only with the cart, stand, tripod, bracket, or table specified by the manufacturer, or sold with the apparatus. When a cart is used, use caution when moving the cart/apparatus combination to avoid injury from tip-over.
12. Unplug this apparatus during lightning storms or when unused for long periods of time.
13. Refer all servicing to qualified service personnel. Servicing is required when the apparatus has been damaged in any way, such as power-supply cord or plug is damaged, liquid has been spilled or objects have fallen into the apparatus, the apparatus has been exposed to rain or moisture, does not operate normally, or has been dropped.



Remember that this camera is intended for private consumer use only.

Any commercial use without proper permission is prohibited. (Even if you record an event such as a show, performance or exhibition for personal enjoyment, it is strongly recommended that you obtain permission beforehand.)

Trademarks

- "AVCHD" and the "AVCHD" logo are trademarks of Panasonic Corporation and Sony Corporation.
- Manufactured under license from Dolby Laboratories. Dolby and the double-D symbol are trademarks of Dolby Laboratories.
- x.v.Color™ is a trademark of Sony Corporation.
- HDMI is a trademark of HDMI Licensing, LLC.
- Windows® is either registered trademark or trademark of Microsoft Corporation in the United States and/or other countries.
- Macintosh is a registered trademark of Apple Inc.
- We recommend using the Category 2 HDMI cable (High Speed cable) for viewing in higher image quality.
- iTunes, iMovie, iPhoto are trademarks of Apple Inc., registered in the U.S. and other countries.
- YouTube and the YouTube logo are trademarks and/or registered trademarks of YouTube LLC.
- Other product and company names included in this instruction manual are trademarks and/or registered trademarks of their respective holders.

x.v.Color
HDMI™
HIGH-DEFINITION MULTIMEDIA INTERFACE



If this symbol is shown, it is only valid in the European Union.

Easy Start Guide

Inserting an SD card

Prepare an SD card (commercially available).
Turn off the camera and insert an SD card.

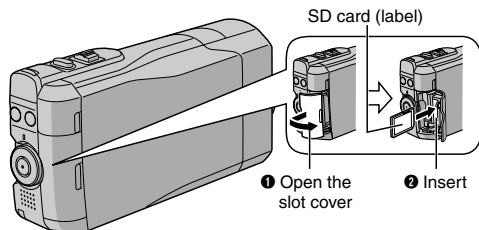

■ Compatible SD/SDHC cards
(p. 21)

Charge the battery before recording

Turn off the camera and attach the battery pack.

Access lamp

Blinks: Accessing files

Do not remove the AC adapter, the battery pack or the SD card when the lamp is blinking.

Power/charge lamp

Blinks: Charging or quick start-up
Goes out: Charging finished

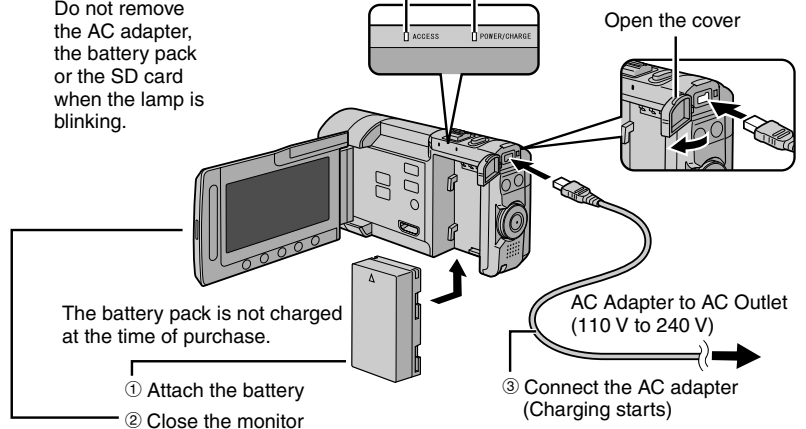

Before removing the battery pack, be sure to turn off the power by pressing **DISPLAY/⏻** for 2 seconds or more.

CAUTION

- Be sure to use JVC battery packs. If you use any other battery packs besides JVC battery packs, safety and performance can not be guaranteed.

Date/Time Setting

- 1** Open the LCD monitor to turn on the camera

DISPLAY/⏻
button

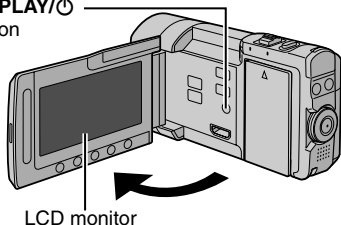

- 2** Select [YES] within 10 seconds

Slide your finger up and down on the sensor. Then touch OK.

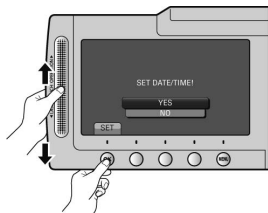

- When the message disappears, press the **DISPLAY/⏻** button for at least 2 seconds to turn off the power, and then press it again for at least 2 seconds.
- Touch the sensors with your finger. The sensors do not function if you touch them with your finger nail or with gloves on.

- 3** Select [CLOCK SETTING]

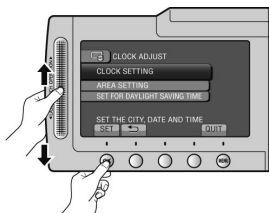

- 4** Select the city closest to the area where you use the camera

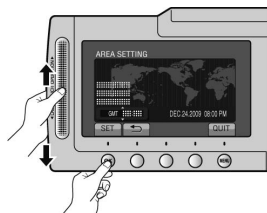

- 5** Select [ON] if daylight saving time is observed



- 6** Set the date and time

Touch sensor: Sets the date and time
→: Moves the cursor to the right
OK: Clock starts

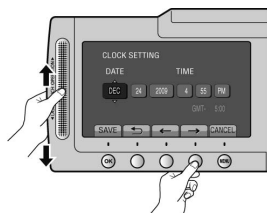

Video recording

CAUTION

Before recording an important scene, it is recommended to conduct a trial recording.

1 Select recording mode (REC)

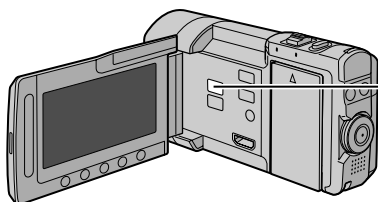

PLAY/REC

The mode changes when you press the button.

Recording Mode Indicator



2 Set the recording dial to (AUTO) mode

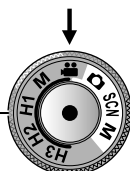
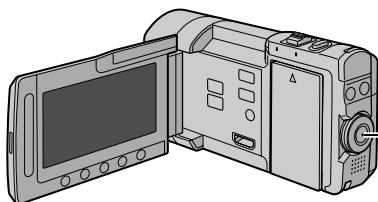

3 Start recording

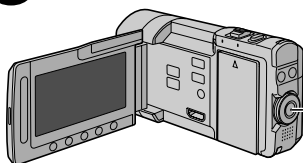

Press the **START/STOP** button to start recording, and press it again to stop.

Remaining space on the SD card

Video Quality

Record-standby

XP [3 h 36 m]
0 : 04 : 01

REC

Recording

Still Image Recording

1 Select recording mode (REC)

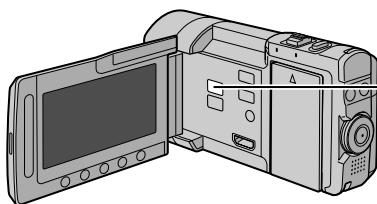

PLAY/REC

The mode changes when you press the button.

2 Set the recording dial to (AUTO) mode

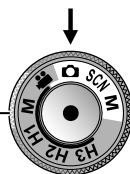
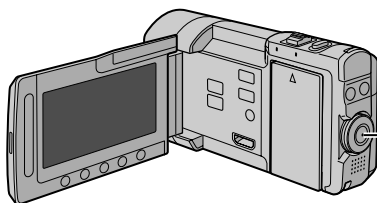

3 Set the focus

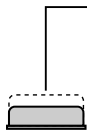

Press and hold **SNAPSHOT** halfway.

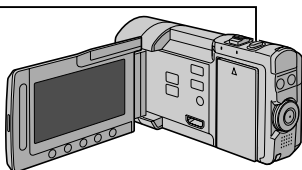

The  indicator becomes green when the captured image is focused.

4 Take a still image



Press **SNAPSHOT** fully to take a still image.



Playing back

1 Select playback mode (PLAY)

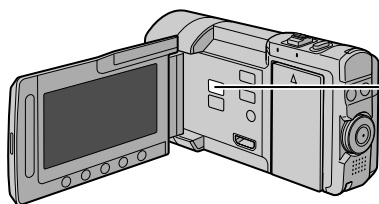

PLAY/REC

The mode changes when you press the button.

2 Select video or still image mode

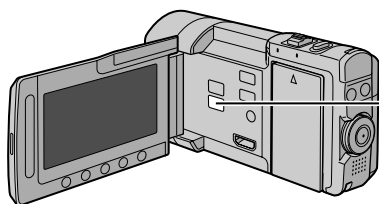

The mode changes when you press the button.

3 Select a file and touch OK

Index screen



Playback screen

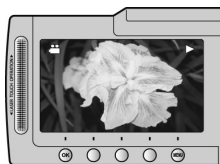

- To perform operations such as forward search or reverse search (↗ p. 28)
- To view files on TV (↗ p. 38)

CAUTION

Do not forget to make copies after recording!

- To copy files onto discs (↗ p. 53)
- To dub files to a VCR/DVD recorder (↗ p. 59)
- To play back a created disc (↗ p. 56)
- To edit files on your computer (↗ p. 60)

Accessories

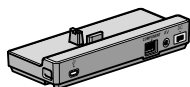

CU-VC10

Everio Dock

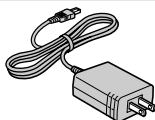

AP-V21U

AC Adapter

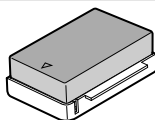

BN-VF908U

Battery Pack

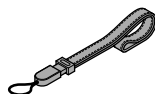

Hand Strap



Component Cable

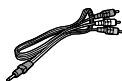

AV Cable



USB Cable



RM-V751U

Remote Control



CR2025

Lithium Battery
Pre-installed in the
remote control.



CD-ROM



Core Filter
([p. 13](#))

NOTE

- Make sure to use the provided cables for connections. Do not use any other cables.

Everio Dock

You can connect cables to the connectors of the Everio dock. The connection is completed when you place the camera on the dock.

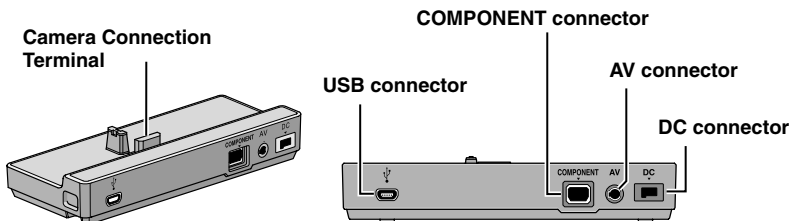

NOTE

- Do not connect the USB cable to both the camera and the Everio dock to prevent malfunctions.
- Before connecting or removing any external devices and cables, turn off all power, including this camera.
Turn on the power only when you are done.

Contents

GETTING STARTED

Preparing the Remote Control.....	13
Attaching the Core Filter to the DC cord.....	13
Index	14
Indications on LCD Monitor.....	16
Necessary Settings before Use.....	18
Charging the Battery Pack.....	18
Date/Time Setting.....	18
Language Setting	19
Other Settings.....	20
Attaching the Camera to the Dock.....	20
Grip Adjustment.....	20
Tripod Mounting.....	20
Using an SD Card.....	21

RECORDING/PLAYBACK

Recording Files.....	22
Video Recording	22
Still Image Recording	23
Zooming.....	24
Flash.....	24
Checking the Remaining Battery Power	24
Checking the Remaining Space on the Recording Media.....	24
Registering Files to Events.....	25
Capturing Still Images in a Movie.....	25
Still Image Continuous Shooting and Bracketing	26
Turning on the Face Detection Mode.....	27
Playing Back Files	28
Video Playback	28
Still Image Playback	29
Setting the Opening Still Image	30
Playback with Special Effects	30
File Search Function.....	31
Playing Back MTS Files.....	32
Manual Recording	33
Changing to Manual Recording Mode	33
Manual Setting in Menu.....	33
High Speed Recording	36
Scene Select	37

USING WITH TV

Viewing Files on TV	38
Connection with TV.....	38
Playback Operation	39
Operating in Conjunction with TV via HDMI	40

EDITING

Managing Files.....	41
Capturing a Still Image from a Video	41
Deleting Files	41
Protecting Files.....	43
Viewing File Information	44
Changing the Event Registration	45
Dividing Files	46
Trimming Files	47
Face Detection Zoom	48
Playlists	49
Creating Playlists	49
Playing Back Playlists	50
Other Operations of Playlists	50
Print Setting	51
DPOF Print Setting.....	51
Direct Printing with PictBridge Printer	52

COPYING

Copying Files	53
Using a BD/DVD Burner	53
Using a USB External Hard Disk Drive.....	57
Dubbing Files to a VCR/DVD Recorder	59

PC OPERATION

Creating a Disc using a PC.....	60
Using with a Portable Media Player	65
Turning on the Export Mode	65
Changing the Export Setting	65
Transferring the Files to PC	66
Uploading Files to Websites	67
Turning on the Upload Mode	67
Upload Trimming.....	67
Uploading Files.....	68

FURTHER INFORMATION

Changing the Menu Settings	69
Troubleshooting.....	74
Warning Indications	78
Cleaning	80
Specifications	81
Cautions	84
JVC Software License Agreement	86
Terms	88

How to use the Touch Sensor

After the menu is displayed on the LCD monitor:

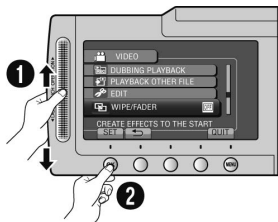

- 1 Slide your finger up and down on the sensor.
- 2 Select [SET]. (Touch OK.)

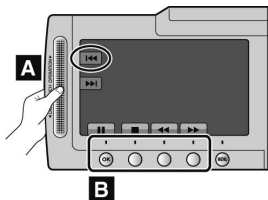

- A To select an on-screen button appearing on the left side, touch the portion of the sensor next to the on-screen button.
- B To select an on-screen button appearing at the bottom of the screen, touch the buttons underneath them.

Read This First!

Make a backup of important recorded data

It is recommended to copy your important recorded data to a DVD or other recording media for storage. JVC will not be responsible for any lost data.

Make a trial recording

Before the actual recording of important data, make a trial recording and play back the recorded data to check that the video and sound have been recorded correctly.

Reset the camera if it does not operate correctly

Open the LCD monitor and remove the power supply (battery pack or AC adapter) from the camera, then reattach it.

Precautions on handling batteries

- Be sure to use the JVC BN-VF908U/ VF808U battery packs. This product includes patented and proprietary technology and is made to be used with the JVC battery only. JVC cannot guarantee safety or performance of this product when it is operated by other batteries.
- If the camera is subjected to electrostatic discharge, turn off the power before using it again.

If a malfunction occurs, stop using the camera immediately and contact www.jvc.com or by phone at 1-800-252-5722

- Recorded data may be erased while the camera is being repaired or inspected. Back up all data before requesting repairs or inspections.

Because cameras may be used for demonstration in a shop, the demonstration mode is set to on by default
To deactivate the demonstration mode, set [DEMO MODE] to [OFF]. (☞ p. 72)

Preparing the Remote Control

A battery is included inside the remote control at the time of purchase.
Remove the insulation sheet before use.

Beam Effective Area

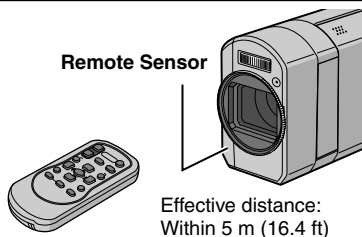

NOTE

The transmitted beam may not be effective or may cause incorrect operation when the remote sensor is directly exposed to sunlight or powerful lighting.

To Reinsert the Battery

Pull out the battery holder by pressing the lock tab.

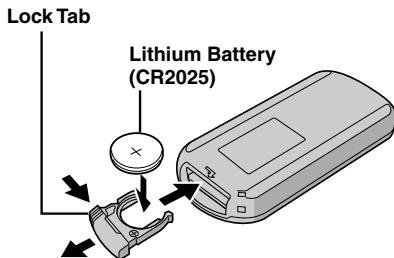

Attaching the Core Filter to the DC cord

The core filter reduces interference. Connect the end of the cable with the core filter to the camera.

Release the stopper.

3 cm (1-3/16")

Wind twice

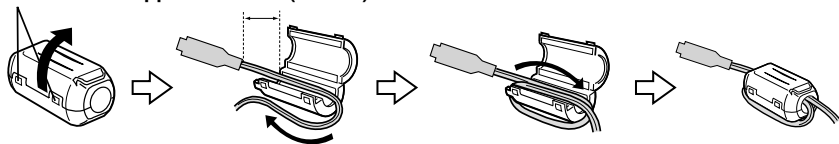

Index

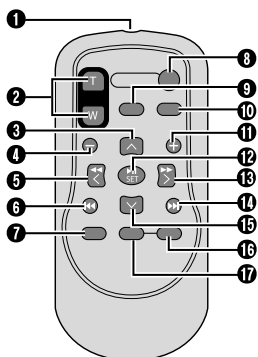
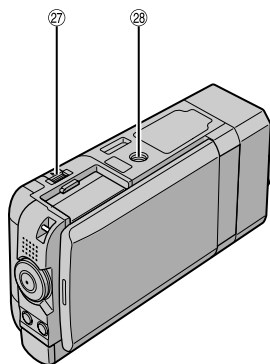
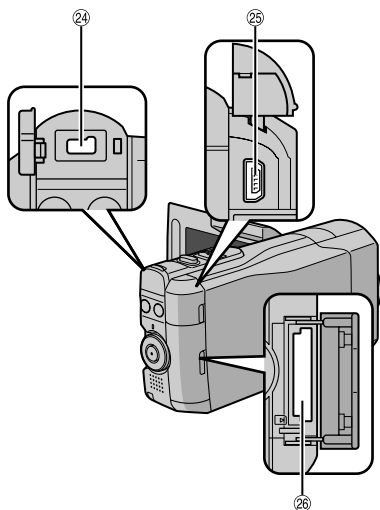
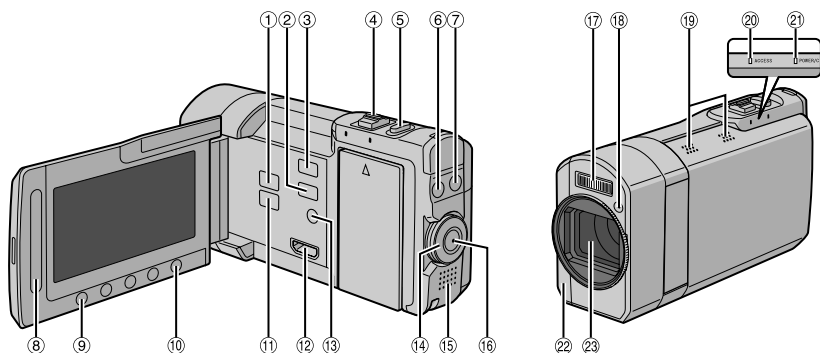

NOTE

- Be careful not to cover 17, 18, 22 and 23 during shooting.
- The LCD monitor can rotate 270°.

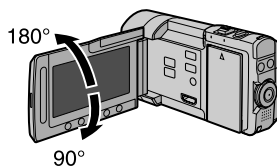

Camera

- ① **PLAY/REC** Button (⇨ p. 22, 23, 28, 29)
- ② **EXPORT** Button (⇨ p. 65)
- ③ **UPLOAD** Button (⇨ p. 67)
- ④ **Zoom Lever** (⇨ p. 24)
Speaker Volume Control (⇨ p. 28)
- ⑤ **SNAPSHOT** (📷) Button (⇨ p. 23)
- ⑥ **INFO** (i) Button (⇨ p. 24, 44)
- ⑦ **FLASH** (🔦) Button (⇨ p. 24)
- ⑧ **Touch Sensor**

- ⑨ **OK** Button
- ⑩ **MENU** Button
- ⑪ **👤 / 📷** Button (⇨ p. 28, 29)

- ⑬ **HDMI Mini Connector** (⇨ p. 38)
- ⑬ **DISPLAY** (🔌) (Power) Button (⇨ p. 17)
- ⑭ **Recording dial** (⇨ p. 22, 23, 33, 36, 37)
- ⑮ **Speaker**
- ⑯ **START/STOP** Button (⇨ p. 22)

- ⑰ **Flash**
- ⑱ **Flash Sensor**
- ⑲ **Stereo Microphone***
- ⑳ **Access lamp** (⇨ p. 4)

- ㉑ **Power/charge lamp** (⇨ p. 4)
- ㉒ **Remote Sensor** (⇨ p. 13)
- ㉓ **Lens**
- ㉔ **DC Connector**

- ㉕ **USB Connector** (⇨ p. 54, 57, 61)
- ㉖ **SD Card Slot**
- ㉗ **BATT.** (Battery Release) Button (⇨ p. 18)
- ㉘ **Tripod Mounting Socket** (⇨ p. 20)

*Do not touch or cover the microphone during recording.

Remote Control

- ❶ **Infrared Beam Transmitting Window**
- ❷ **ZOOM (T/W)** Buttons (Zoom in/out)
- ❸ **UP** Button
- ❹ **SKIP BACKWARD** Button

- ❺ **LEFT** Button
- ❻ **BACK** Button
- ❼ **PLAYLIST** Button
- ❽ **START/STOP** Button

- ❾ **S.SHOT** (Snapshot) Button
- ❿ **INFO** Button
- ⓫ **SKIP FORWARD** Button
- ⓬ **PLAY/PAUSE/SET** Button

- ⓭ **RIGHT** Button
- ⓮ **NEXT** Button
- ⓯ **DOWN** Button
- ⓰ **INDEX** Button*
- ⓱ **DISP** Button

* Each time you press **INDEX**, the screen switches as shown below:

👤 mode:
Index Screen ↔ Group Index Screen
📷 mode:
Index Screen ↔ Date Index Screen

Indications on LCD Monitor

During both Video and Still Image Recording

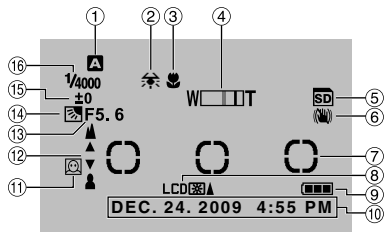

- ① Selected Recording Mode Indicator (↗ p. 33)
A: Auto Mode
M: Manual Mode
- ② White Balance Indicator (↗ p. 35)
- ③ Macro Mode Indicator (↗ p. 35)
- ④ Zoom Indicator (↗ p. 24)
- ⑤ SD card Indicator*
- ⑥ OIS Indicator (Appears when [OIS] is set to [OFF].) (↗ p. 70)
- ⑦ Photometry Area
- ⑧ Monitor Backlight Indicator (↗ p. 71)
- ⑨ Battery Indicator
- ⑩ Date/Time (↗ p. 18)
- ⑪ Face Detection Indicator (↗ p. 27)
- ⑫ Manual Focus Adjustment Indicator (↗ p. 34)
- ⑬ Aperture Value (F-number) (↗ p. 34)
- ⑭ : Backlight Compensation Indicator (↗ p. 35)
- ⑮ : Face Detection Mode Indicator (↗ p. 27)
- ⑯ Brightness Control Indicator (↗ p. 34)
- ⑰ : Photometry Area Control Indicator (↗ p. 35)
- ⑱ Shutter Speed (↗ p. 34)

*Blinks when an SD card is not inserted.

During Video Recording Only

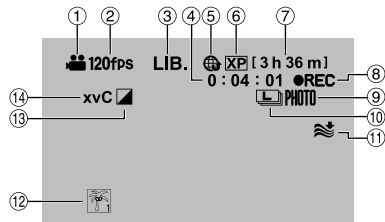

- ① Mode Indicator
- ② High Speed Recording Indicator (↗ p. 36)
- ③ Export Mode Indicator (↗ p. 65)
- ④ Counter
- ⑤ Upload Mode Indicator (↗ p. 67)
- ⑥ Video Quality (↗ p. 69)
- ⑦ Remaining Time (↗ p. 22)
- ⑧ ● REC: (Appears during recording.)
 ● : (Appears during record-standby mode.)
- ⑨ Shooting Indicator (↗ p. 22)
- ⑩ Continuous Shooting Indicator (↗ p. 25)
- ⑪ Wind Cut Indicator (↗ p. 70)
- ⑫ Event Indicator (↗ p. 25)
- ⑬ Effect Mode Indicator (↗ p. 35)
- ⑭ x.v.Color™ (↗ p. 70)

During Still Image Recording Only

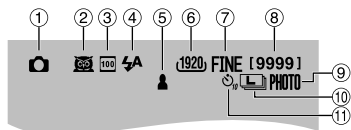

- ① Mode Indicator
- ② Scene Select Indicator (↗ p. 37)
- ③ ISO Sensitivity Indicator
 (When set to [AUTO], there is no indication.) (↗ p. 70)
- ④ Flash Indicator (↗ p. 24)
- ⑤ Focus Indicator (↗ p. 23)
- ⑥ Image Size (↗ p. 70)
- ⑦ Image Quality: FINE (fine) or STD (standard) (↗ p. 70)
- ⑧ Remaining Number of Shots
- ⑨ Shooting Indicator (↗ p. 23)
- ⑩ Continuous Shooting Indicator (↗ p. 26)
- ⑪ Self-Timer Indicator (↗ p. 69)

During Video Playback

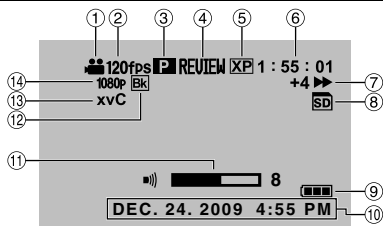

- ① Mode Indicator
- ② High Speed Recording Indicator
- ③ Playlist Playback Indicator
(Appears when playing back a playlist.)
(↗ p. 50)
- ④ Quick Review Indicator (↗ p. 22)
- ⑤ Video Quality (↗ p. 69)
- ⑥ Counter
- ⑦ Playback Mode
 - ▶ : Playback
 - ⏸ : Pause
 - ▶▶ : Forward Search
 - ◀◀ : Reverse Search
 - ▶▶▶ : Forward Slow-Motion
 - ◀◀◀ : Reverse Slow-Motion
 (The number on the left shows speed.)
- ⑧ Recording Medium Indicator
- ⑨ Battery Indicator
- ⑩ Date/Time (↗ p. 18)
- ⑪ Volume Level Indicator
- ⑫ Wipe/Fader Effect Indicator (↗ p. 30)
- ⑬ x.v.Color™ (↗ p. 70)
- ⑭ Output with 1080p (↗ p. 73)

During Still Image Playback

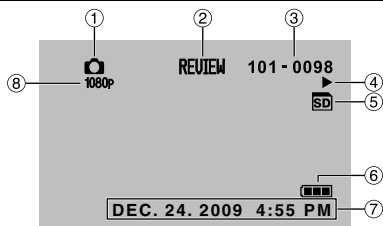

- ① Mode Indicator
- ② Quick Review Indicator (↗ p. 23)
- ③ Folder/File Number
- ④ Slide Show Playback Indicator
- ⑤ Recording Medium Indicator
- ⑥ Battery Indicator
- ⑦ Date/Time (↗ p. 18)
- ⑧ Output with 1080p (↗ p. 73)

Switching indication modes on LCD monitor

Each time you touch **DISPLAY/☺**, indications on LCD monitor switch as shown below:

In recording mode:

All indications/Indications for selected functions

In playback mode:

All indications/Only date and time/No indications

NOTE

The **DISPLAY/☺** button is used to turn the power ON/OFF as well as to switch the indications on the screen.

To switch the indications, press and release the button. To turn the power ON/OFF, press and hold (2 seconds or more) the button.

Necessary Settings before Use

Charging the Battery Pack

- 1 Open the LCD monitor.
- 2 Attach the battery pack.

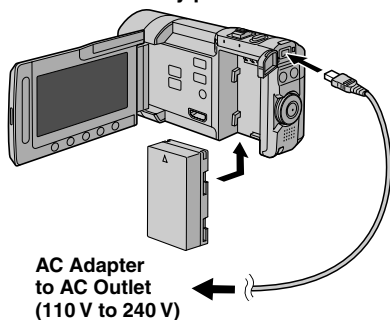

- 3 Close the LCD monitor and connect the AC adapter.

- You can also connect the AC adapter using the Everio dock connector. (p. 9)
- The power/charge lamp blinks to indicate charging has started.
- When the lamp goes out, charging is finished.
- Unplug the AC adapter from the AC outlet and disconnect the AC adapter from the camera.

- To check the remaining battery power See page 24.

Battery pack	Charging time	Recording time
BN-VF908U (Provided) / BN-VF808U	1 h 50 m	1 h 15 m

- To detach the battery pack Open the LCD monitor and turn off the camera using the **DISPLAY/** button before detaching the battery pack.

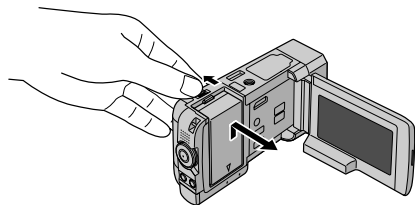

NOTE

- You can also use the camera with just the AC adapter. (p. 4)
- Please do not pull or bend the AC adapter plug and cable. This may damage the AC adapter.

Date/Time Setting

- 1 Open the LCD monitor to turn on the camera.
- 2 Touch MENU.
- 3 Select [DISPLAY SETTINGS].



- 4 Select [CLOCK ADJUST].

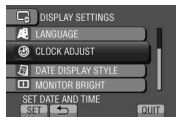

5 Select [CLOCK SETTING].

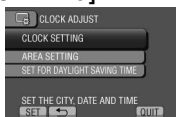

6 Select the city closest to the area where you use the camera.

Selected area is highlighted

Principal city of the selected area

Time difference to GMT



7 Select [ON] if daylight saving time is observed.

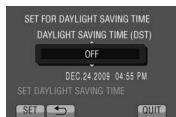

8 Set the date and time.

Change the setting by using the touch sensor and select [→] to set.



9 Select [SAVE].

To reset the setting, select [CANCEL].

Setting the clock to local time when traveling

After performing steps 1-4 (p. 18)

5 Select [AREA SETTING].



6 Select the city closest to the area you are traveling.



■ To return to the previous screen
Select ↩.

■ To quit the screen
Select [QUIT].

Language Setting

The language on the display can be changed.

1 Open the LCD monitor to turn on the camera.

2 Touch MENU.

3 Select [DISPLAY SETTINGS].



4 Select [LANGUAGE].



5 Select the desired language.

■ To return to the previous screen
Select ↩.

■ To quit the screen
Select [QUIT].

Other Settings

Attaching the Camera to the Dock

- 1 Close the LCD monitor.
- 2 Align the camera with the dock as indicated by the dotted line in the figure below and attach firmly.

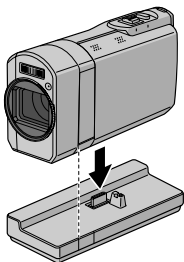

Grip Adjustment

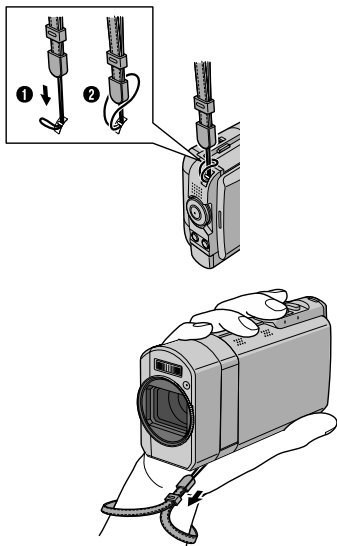

NOTE

- Fasten the strap when you grip the camera.
- When carrying the camera, please be careful not to drop it.

Tripod Mounting

Align the camera stud hole with the tripod stud, and the mounting socket with the screw, and then rotate the camera clockwise to mount it to the tripod.

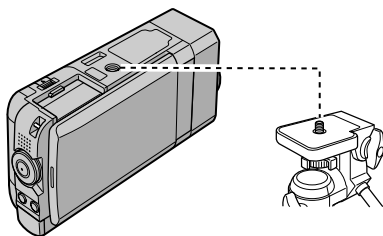

NOTE

- Do not use a tripod on unsteady or unlevel surfaces. It could tip over, causing serious damage to the camera.
- Use a tripod that does not have a locking pin.
- The LCD monitor may scratch against the tripod in some cases. When this occurs, tilt the LCD monitor slightly before closing.

When it is difficult to close the LCD monitor

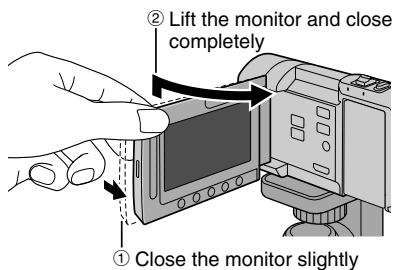

Using an SD Card

- Operations are confirmed on the SD cards from the following manufacturers.

- Panasonic
- TOSHIBA
- SanDisk
- ATP

Video recording:

Class 4 or higher compatible SDHC card (4 GB to 32 GB)

- For UXP mode, use Class 6 or higher.

Still image recording:

SD card (256 MB to 2 GB) or SDHC card (4 GB to 32 GB)

- If other media are used, they may fail to record data correctly, or they may lose data that had already been recorded.
- MultiMediaCards are not supported.
- Video data may not be recorded onto the SD cards on which video data have already been recorded using the devices from other manufacturers.

Insert an SD card

Preparation:

Close the LCD monitor to turn off the camera.

- 1 Open the SD card cover.
- 2 Firmly insert the card with its clipped edge first.

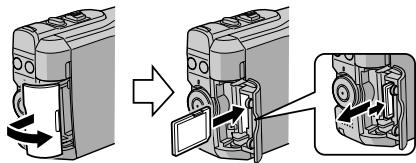

- 3 Close the SD card cover.

To remove an SD card

Push the SD card once.

After the card comes out a little, pull it out.

NOTE

- Insert and remove the SD card only while the power is turned off. Otherwise, data on the card may be corrupted.
- Do not touch the terminal on the reverse side of the label.

Format an SD card when using it for the first time

Select [FORMAT SD CARD] to format the card. (ⓘ p. 72)



Recording Files

Video Recording

- 1** Press **PLAY/REC** to select the recording mode.



The lens cover opens automatically.

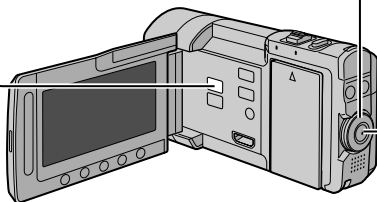

- 2** Set the recording dial to mode.

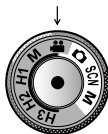

XP [3 h 36 m]
0 : 00 : 00 ●|| SD

- 3** Press **START/STOP** to start recording.



XP [3 h 36 m]
0 : 00 : 01 ●REC SD

Approximate remaining time for recording

You can also start/stop recording by selecting [REC] on the LCD monitor. (On-screen recording control)

■ To stop recording

Press **START/STOP** again.

■ To view the last recorded scene

Select while recording is paused.

Selecting during playback deletes that scene.

■ To record a still image during video recording

Press **SNAPSHOT**.

■ Continuous shooting may be performed by switching the shutter mode. (☞ p. 25)

■ To change the video quality

Change the settings in [VIDEO QUALITY]. (☞ p. 69)

■ To perform high speed recording

Select from H1 to H3 on the recording dial. (☞ p. 36)

NOTE

- The video recording mode is automatically selected when you turn off the camera and then turn on again.
- If [AUTO POWER OFF] in the menu is set to [ON], the camera turns itself off automatically to conserve power when it is not operated for 5 minutes while running on battery.
- After recording video for 12 consecutive hours, recording stops automatically.
- A new file will be created for every 4 GB of continuous shooting.

Still Image Recording

- 1** Press **PLAY/REC** to select the recording mode.

PLAY/REC

The lens cover opens automatically.

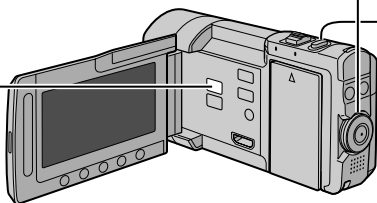

- 2** Set the recording dial to **mode**.



FINE [9999]

- 3** Press and hold **SNAPSHOT** halfway.



FINE

The  indicator becomes green when the captured image is focused.

- 4** Press **SNAPSHOT** fully to take a still image.



FINE [9999]

PHOTO

■ **To view the last recorded image**

Select  after shooting.

Selecting  during playback deletes that image.

■ **To change the image quality**

Change the settings in [IMAGE QUALITY].

( p. 70)

■ **To change the image size**

Change the settings in [IMAGE SIZE].

( p. 70)

■ **To record still images continuously**

Set to [CONTINUOUS SHOOTING] in

[SHUTTER MODE]. ( p. 26)

NOTE

- If [AUTO POWER OFF] in the menu is set to [ON], the camera turns itself off automatically to conserve power when it is not operated for 5 minutes while running on battery.
- The sides of still images recorded in 16:9 size may be cut off when printed. Check whether 16:9 size prints can be printed at your local print store.

Recording Files (Continued)

Zooming

Preparation:

- Select the recording mode.
- Select or mode.

Zoom out

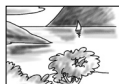

W: Wide angle

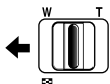

Zoom in

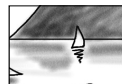

T: Telephoto

You can also zoom out/zoom in by selecting [W] or [T] on the LCD monitor. (On-screen zoom control)

Zoom ratio (factory-preset)

mode	mode
[8X/DYNAMIC]	[5X/OPTICAL]

- To change the maximum zoom ratio (mode only)

Change the settings in [ZOOM]. (p. 70)

Flash

Preparation:

- Select the recording mode.
- Select or M mode.

1 Press FLASH.



2 Select the desired setting.

	Disables this function.
	The flash fires automatically.
	The flash fires automatically but reduces the red-eye phenomenon of the subject's eyes.
	The flash fires regardless of the shooting condition.
	The flash fires. The shutter speed becomes slower, so the background can also be brightened.

- The flash is set to (auto) by default.

- When Scene Select (p. 37) is selected, the flash is automatically set to auto and fires automatically according to the Scene Select setting

- Recommended shooting distance
Within 2 m (6.6 ft).

NOTE

The flash does not work during CONTINUOUS SHOOTING and BRACKETING.

Checking the Remaining Battery Power

mode:

Press INFO twice or INFO and then select .

mode:

Press INFO.



- To quit the screen

Select [QUIT] or press INFO.

NOTE

The recordable time display should only be used as a guide. It is displayed in 10 minute units.

Checking the Remaining Space on the Recording Media

Preparation:

- Select the recording mode.
- Select mode.

Press INFO.



The maximum recording time is displayed for each video quality mode.

- To change the video quality

1) Select the video quality.
2) Select [SET].

- To quit the screen

Select [QUIT].

Registering Files to Events

If you select an event to register the file to before starting recording, you can find the file easily at playback.

Preparation:

- Select the recording mode.
- Select  mode.

1 Touch **MENU**.

2 Select **[REGISTER EVENT]**.



3 Select the event.



The selected event is displayed on the screen.

To quit the screen

Select **[QUIT]**.

To search by event

See page 32.

NOTE

Once you select a certain event to register a file, the setting will remain even if you turn off the camera.

Capturing Still Images in a Movie

You can capture still images while recording a video.

Preparation:

- Select the recording mode.

1 Set the recording dial to  mode.

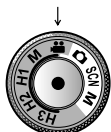

2 Touch the shutter mode and select **RECORD ONE SHOT** or **CONTINUOUS SHOOTING**.

- **RECORD ONE SHOT**: Records one still image.
(There will be no indicator display on the LCD monitor when recording one image.)
- **CONTINUOUS SHOOTING**: Records still images continuously.

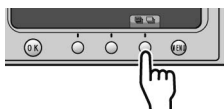

RECORD ONE SHOT

After performing steps 1-2

3 Press **SNAPSHOT**.

CONTINUOUS SHOOTING

After performing steps 1-2

3 Select the continuous shooting mode from the menu.

- Select from **HIGH SPEED** / **MEDIUM SPEED** / **LOW SPEED**.

4 Press and hold **SNAPSHOT**.

- Recording ends when **SNAPSHOT** is released.
- When capturing still images during video recording, the continuous shooting mode is fixed at **[LOW SPEED]** regardless of the setting.
- When capturing still images in the recording standby mode, you can select from all the modes (**[LOW SPEED]** / **[MEDIUM SPEED]** / **[HIGH SPEED]**).
- The display during medium and high speed recording is as follows.
Red: Number of recorded images
Green: Saving in progress

XP [3 h 36 m]
■■■■■■■■■■■●■■

Recording Files (Continued)

- Although still images can be taken continuously while **SNAPSHOT** is being pressed, recording stops once the recordable time is exceeded.
- At this time, **SNAPSHOT** will not work until the writing to the media is completed.

■ **The photo indicator lights up immediately on the LCD monitor when SNAPSHOT is pressed.**

NOTE

- Recording cannot be performed when the menu is displayed. Close the menu.
- Functions that are only available in still image mode cannot be used. (Example: flash, GAIN, etc.)
- The number of recordable still images depends on the remaining space on the recording media.
- The size of recorded still images is 3072 x 1728, regardless of the image size that is set.
- The still images recorded in the video mode contains a little more noise than the still images recorded in the still image mode.
- Simultaneous recording (still image recording) may be performed even when the dial is set to [M].

Still Image Continuous Shooting and Bracketing

You can record still images continuously.

Preparation:

- Select the recording mode.

1 **Turn the recording dial and set to the mode (A, SCN, M) that best suits the subject to be recorded.**



2 **Touch the shutter mode and select RECORD ONE SHOT, CONTINUOUS SHOOTING, or BRACKETING.**

- **RECORD ONE SHOT:** Records one still image.

(There will be no indicator display on the LCD monitor when recording one image.)

- **CONTINUOUS SHOOTING:** Records still images continuously.
- **BRACKETING:** Records 5 still images of different brightness continuously.

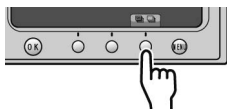

RECORD ONE SHOT

Records one still image at a time.

After performing steps 1-2

3 **Press SNAPSHOT.**

CONTINUOUS SHOOTING

Records still images continuously while **SNAPSHOT** is pressed.

You can set the continuous shooting speed from the menu. (p. 71)

After performing steps 1-2

3 **Press and hold SNAPSHOT.**

- Recording ends when **SNAPSHOT** is released.
- The display during medium and high speed recording is as follows.
Red: Number of recorded images
Green: Saving in progress

- Although still images can be taken continuously while **SNAPSHOT** is being pressed, recording stops once the recordable time is exceeded.
- At this time, **SNAPSHOT** will not work until the writing to the media is completed.

NOTE

- Recording cannot be performed when the menu is displayed. Close the menu.
- The number of recordable still images depends on the remaining space on the recording media.

BRACKETING

Records 5 continuous images from dark (-0.6EV) to bright (+0.6EV) based on the brightness of still images set in AUTO or MANUAL.

After performing steps 1-2

3 Press SNAPSHOT.



NOTE

- When there is no SD, or when there is no remaining space on the SD card, it is not possible to save still images.
- When the continuous shooting or bracketing indicator is blinking, do not set Scene Select to [PORTRAIT], [NIGHT & PORTRAIT], or [SPORTS]. (☞ p. 37)
- When Scene Select (☞ p. 37) is set to [TWILIGHT], [SLEEPING FACE], or [FIREWORKS], the continuous shooting speed is slow.

Turning on the Face Detection Mode

If you set this mode on, the camera detects the faces and adjust brightness and focus so that the faces are recorded clearly.

Preparation:

- Select the recording mode.
- Select  or  mode.

Select .



- To turn off the face detection mode Select  again.

Recording still images with the face detection mode turned on

1 Press and hold SNAPSHOT halfway.



2 Press SNAPSHOT.

Using the self-timer in the face detection mode

Preparation:

Set [SELF-TIMER] to [FACE DETECTION].

1 Press SNAPSHOT.

Faces are detected.





2 The still image is recorded 3 seconds after the face of the photographer is detected.

Photographer



NOTE

- If the LCD monitor is turned upside down,  is not displayed. Change the setting when the LCD monitor is in the normal position.
- You cannot turn on the face detection mode if [SELF-TIMER] is set to [FACE DETECTION]. (This is indicated by blinking .)
- Depending on the condition, faces may not be detected.
- If the face detection does not work correctly, turn off the mode before recording.

Playing Back Files

Video Playback

- 1** Press **PLAY/REC** to select the playback mode.

PLAY/REC

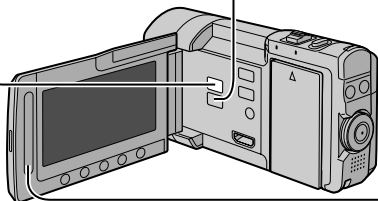

- 2** Press **👤/📷** and set to **👤** mode.

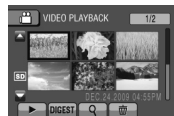

The index screen appears.
The lens cover closes automatically.

- 3** Select the desired file.



■ The **👤/📷** button is used for switching between video and still image in the playback mode. It does not work in the recording mode.

■ To move to the previous or next page
Touch **▲** or **▼** for over a second.

■ To play back a few seconds from the beginning of each video

Touch **DIGEST**.

- For digest playback, parts of the video other than the beginning may be played back in some cases.
- Or, some videos may not be played back at all.

■ To delete a video

Select **🗑️** when playback is stopped.

■ To change the number of thumbnails
(6 thumbnails/12 thumbnails)

Move the zoom lever to **[W]** or **[T]**.

■ To zoom in the video during pause
(remote control only)

Press **T** on the remote control.

- Press **▲**, **▼**, **◀**, **▶** on the remote control to move the zoom area.
- Press and hold **W** on the remote control to cancel zoom in.

■ Operations during Video Playback On-screen buttons

- ◀◀ : Return to the first scene of the file
- ▶▶ : Go to the first scene of the next file
- : Return to the index screen
- ◀◀ : Reverse search (during playback)
- ◀◀ : Frame-by-frame playback in reverse direction (during pause)*
- ▶ : Playback
- || : Pause
- ▶▶ : Forward search (during playback)
- ▶▶ : Frame-by-frame playback in forward direction (during pause)*

* Slow playback starts when you keep touching the sensor button under **◀◀/▶▶** for a while.

■ Speaker volume

— : Turn down the volume

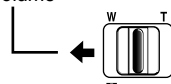

+ : Turn up the volume

Still Image Playback

1 Press **PLAY/REC** to select the playback mode.

PLAY / REC

2 Press **👤/📷** and set to **📷** mode.



The index screen appears.
The lens cover closes automatically.

3 Select the desired file.



■ The **👤/📷** button is used for switching between video and still image in the playback mode. It does not work in the recording mode.

■ **To move to the previous or next page**
Touch **▲** or **▼** for over a second.

■ **To delete a still image**
Select **🗑️**.

■ **To change the number of thumbnails**
(6 thumbnails/12 thumbnails)
Move the zoom lever to **[W]**.

■ **To zoom in the image during playback (remote control only)**

Press **T** on the remote control.

- Press **^**, **v**, **<**, **>** on the remote control to move the zoom area.
- Press and hold **W** on the remote control to cancel zoom in.

■ Operations during Still Image Playback On-screen buttons

- ◀ : Change playback order of slide show in reverse direction
- ▶ : Change playback order of slide show in forward direction
- : Return to the index screen
- ⏪ : Display the previous file
- ▶ : Start the slide show
- ⏸ : End the slide show
- ⏩ : Display the next file
- ↶ : Rotate 90 degrees counterclockwise (during playback)
- ↷ : Rotate 90 degrees clockwise (during playback)

Playing Back Files (Continued)

Setting the Opening Still Image

You can set a recorded still image as the opening image.

Preparation:

- Select the playback mode.
- Select  mode.

- 1 Touch **MENU**.
- 2 Select **[OPENING SCREEN]**.
- 3 Select **[CUSTOMIZE]**.
- 4 Select the desired file and select **[SET]**.



- To check the content of the file, select **[CHECK]**.

- **To quit the screen**
Select **[QUIT]**.

Playback with Special Effects

Wipe or fader effects

Add effects at the beginning and end of videos. These effects cannot be set for still images.

Preparation:

- Select the playback mode.
- Select  mode.

- 1 Touch **MENU**.
- 2 Select **[WIPE/FADER]**.



3 Select a desired effect.

For details on each effect, see the right column.









4 Select the file you want to play back.

- **To quit the screen**
Touch **MENU**.

- **To turn off the effect**
Select **[OFF]** in step 3.

■ Items for WIPE/FADER setting



-  **FADER-WHITE:**
Fades in or out with a white screen.
-  **FADER-BLACK:**
Fades in or out with a black screen.
-  **WIPE-SLIDE:**
Wipes in from right to left, or wipes out in the opposite way.
-  **WIPE-DOOR:**
Wipes in as the two halves of a black screen which open to the left and right revealing the scene, or wipes out in the opposite way.
-  **WIPE-SCROLL:**
Wipes in from the bottom to the top of a black screen, or wipes out in the opposite way.
-  **WIPE-SHUTTER:**
Wipes in from the center of a black screen toward the top and bottom, or wipes out in the opposite way.

NOTE

No effect will be applied on files with a play time shorter than 7 seconds.

File Search Function

Preparation:

- Select the playback mode.
- Select  or  mode.

Group Index Screen

You can search the desired file by the group. The group is created automatically based on recording date and time. And the contents of the group are changed when adding/deleting or editing scenes.

1 Select .

2 Select [GROUP].

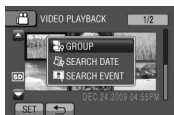

3 Select the file you want to play back.



The number of files in the group is displayed in the thumbnails.

■ To return to the index screen

Select .

■ To quit the screen

Select [QUIT].

NOTE

- The contents of the group may be changed depending on the interval of the recording time. To change the contents, register the event. (☞ p. 25)
- The number of files in the group is displayed only when there are 6 thumbnails. It is not displayed when there are 12 thumbnails.

Date Index Screen

You can search the desired file by the recording date.

1 Select .

In case of  mode, go to step 3.

2 Select [SEARCH DATE].

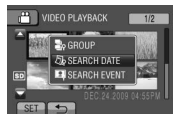

3 Select the recording date.



4 Select the file you want to play back.



■ To return to the index screen

Select .

■ To quit the screen

Select [QUIT].

Playing Back Files (Continued)

Event Screen



You can search the desired file by the event that you registered the file to when recording. (p. 25) After searching by the event, you can search by the recording date to narrow down the search.

1 Select **Q**.

2 Select [SEARCH EVENT].

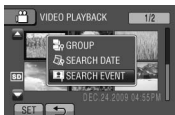

3 Select the event.

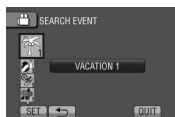

4 Select the recording date.

To display all the files, select [ALL].



5 Select the file you want to play back.



Playing Back MTS Files

MTS files are stored in the EXTMOV folder. Follow the procedure below to play back the MTS files in the EXTMOV folder.

Preparation:

- Select the playback mode.
- Select **mode**.

1 Touch MENU.

2 Select [PLAYBACK OTHER FILE].



3 Select the file you want to play back.

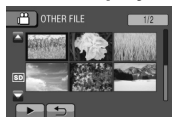

■ To return to the normal file playback mode

Select **↩**.

NOTE

An MTS file is created in the EXTMOV folder when management information is corrupted.

■ To return to the index screen

Select **↩**.

■ To quit the screen

Select [QUIT].

■ To change the event registration of a file

See page 45.

Manual Recording

Manual recording mode enables you to set the focus and screen brightness, etc. manually.

Changing to Manual Recording Mode

Preparation:

- Select the recording mode.

Set the recording dial to manual video **[M]** or manual still image **[M]**.

manual video



manual still image

■ To return to the auto recording mode

Set the recording dial to **[A]** or **[S]**.

Manual Setting in Menu

Preparation:

- Select the manual recording mode.

1 Touch **MENU**.

2 Select **[MANUAL SETTING]**.

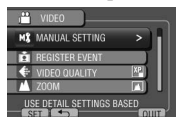

3 Select the desired menu.



4 Select the desired setting.



Depending on the kind of settings you select, you can set the value by using the touch sensor.





























■ To return to the previous screen

Select **[←]**.

■ To quit the screen

Select **[QUIT]**.

Manual Recording (Continued)

Menus	Settings: [] = Factory-preset
<p> FOCUS Adjusts the focus.</p>	<p>A [AUTO]: The focus is adjusted automatically. M MANUAL:                             </p>

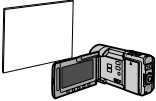
Menus	Settings: [] = Factory-preset
<p>[WB] WB Adjusts the white balance to achieve the optimum colors for the amount of light in your surroundings during recording.</p>	<p>[A] [AUTO]: White balance is adjusted automatically. [M] MANUAL: <input checked="" type="checkbox"/> MWB: Adjusts the white balance manually depending on the light source.</p> <ol style="list-style-type: none"> 1) Hold a sheet of plain white paper in front of the camera so that the white paper fills the screen. 2) Keep touching OK until the <input checked="" type="checkbox"/> indicator appears.  <p><input checked="" type="checkbox"/> FINE: When shooting outdoors on a sunny day. <input checked="" type="checkbox"/> CLOUD: When shooting outdoors on a cloudy day. <input checked="" type="checkbox"/> HALOGEN: When a video light or similar type of lighting is used.</p>
<p>[BACK] BACKLIGHT COMP. Backlight compensation brightens the subject by increasing the exposure.</p>	<p><input checked="" type="checkbox"/> [OFF]: Deactivates the function. <input checked="" type="checkbox"/> [ON]: Activates the function.</p>
<p>[PHOT] PHOTOMETRY AREA Enables you to adjust the brightness in the desired spot when backlight compensation does not work well.</p>	<p><input checked="" type="checkbox"/> [WHOLE SCREEN]: Brightness is adjusted automatically for whole screen. <input checked="" type="checkbox"/> [SPOT]: Brightness for the specified spot is adjusted automatically. Move the spot frame left and right by touching → or ←, then touch OK.</p>
<p>[CAM] mode only) [EFFECT] EFFECT Enables you to record videos or still images with special effects.</p>	<p><input checked="" type="checkbox"/> [OFF]: No effect is used. <input checked="" type="checkbox"/> SEPIA: The image has a brownish tint like old still images. B/W MONOTONE: The image becomes black and white like old movies. <input checked="" type="checkbox"/> CLASSIC FILM: This effect skips frames to give images of an old movie atmosphere. <input checked="" type="checkbox"/> STROBE: The image looks like a series of consecutive snapshots.</p>
<p>[MACRO] MACRO Enables you to shoot a subject as large as possible at a distance of approx. 4 cm (1.58 in).</p>	<p><input checked="" type="checkbox"/> [OFF]: Normal shooting (Enables close-up shots up to the distance stated below) Tele (T) side: Approx. 50 cm (1.64 ft) Wide (W) side: Approx. 50 cm (1.64 ft) <input checked="" type="checkbox"/> [ON]: Macro shooting (Enables close-up shots up to the distance stated below) Tele (T) side: Approx. 30 cm (0.98 ft) Wide (W) side: Approx. 4 cm (1.58 in)</p> <p>NOTE Set [MACRO] to [OFF] if you will not take close-up still images. Non-close-up still images will be blurred if [MACRO] is set to [ON].</p>

NOTE

Depending on the operation mode, some menu settings may be fixed and are unavailable for selection. In this case, it will be displayed in gray.

Manual Recording (Continued)

High Speed Recording

You can record high speed videos.

Preparation:

- Select the recording mode.

- 1 Turn the recording dial and set to the mode (H1-H3) that best suits the subject to be recorded.



Mode	H1	H2	H3
Recording speed (Frame rate)	120 fps	300 fps	600 fps
Recording time (sec)	4	4	2.4
Playback time	2 times of the recording time	5 times of the recording time	10 times of the recording time

- 2 Press **START/STOP** to start recording.

- Recording ends when the button is pressed again or when the time limit is up.

NOTE

- Image quality is fixed to XP mode.
- Sound cannot be recorded.
- Face detection cannot be set.
- Only optical zoom is available.
- The higher the speed, the smaller the image size and the grainier the image becomes.
- When using a tripod or shooting in a bright place during high speed recording, it is recommended to zoom in as much as possible.
- A black frame appears around the image.
- The recorded object appears dark. Choose a sufficiently bright object especially for H3.

Scene Select

Adjusts the exposure and shutter speed to suit your surroundings or the subject.

Preparation:

- Select the recording mode.

1 Turn the recording dial and set to SCN.

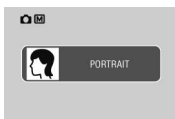

- The current scene mode will be displayed only when SCN is set using the recording dial.
(It does not appear when turning on the power or switching from the playback mode.)
- The next screen appears 5 seconds later or when some operation is performed.

2 Select [SCN].



3 Select the desired scene.

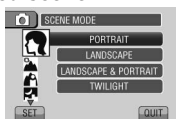

■ To quit the screen

Select [QUIT].

NOTE

Most of the items in the manual setting menu are automatically adjusted in Scene Select. Therefore, they cannot be set in the menu.

■ Items for Scene Select setting

- **👤 PORTRAIT:**
Controls the exposure and color tone to bring out the people in the picture.
- **🏞️ LANDSCAPE:**
Focuses in the distance and makes the entire scene appear sharp.
- **🏞️ LANDSCAPE & PORTRAIT:**
Makes it easier to focus on both people and scenery by using a wide angle.
- **🌆 TWILIGHT:**
Captures night scenes clearly by using a slower shutter speed.
- **🌃 NIGHT & PORTRAIT:**
Captures evening or night scenes in the background vividly while people appear sharp with the use of flash.
- **👤 SLEEPING FACE:**
Records sleeping faces beautifully even in dimly lit places without using flash.
- **❄️ SNOW:**
Controls the color tone such that snow scenes appear all white.
- **🏖️ BEACH:**
Captures vividly the blue sky and sea on a sunny beach without making the people appear dark.
- **🏃 SPORTS:**
Suitable for shooting fast moving objects.
- **🍴 FOOD:**
Captures food in its natural color tone without being affected by the surrounding lights.
- **🎆 FIREWORKS:**
Suitable for shooting fireworks in the night sky.
- **📄 DOCUMENT:**
Switches to macro mode with hard sharpness and high contrast.
- **🔍 CLOSE-UP:**
Switches to macro mode with high saturation.
- **🌲 FOREST:**
Saturation is increased and the color green is emphasized in this mode.
- **🌅 SUNSET:**
Enables the beautiful colors of sunsets to be captured.

Viewing Files on TV

This camera is designed to be used with high-definition or NTSC-type color television signals. It cannot be used with a television of a different standard.

Connection with TV

You can output videos from the HDMI connector, COMPONENT connector, or AV connector. Select the connector that best suits your television.

Preparation:

Turn off all units.

■ To connect using the HDMI mini connector

We recommend using the Category 2 HDMI cable (High Speed cable).

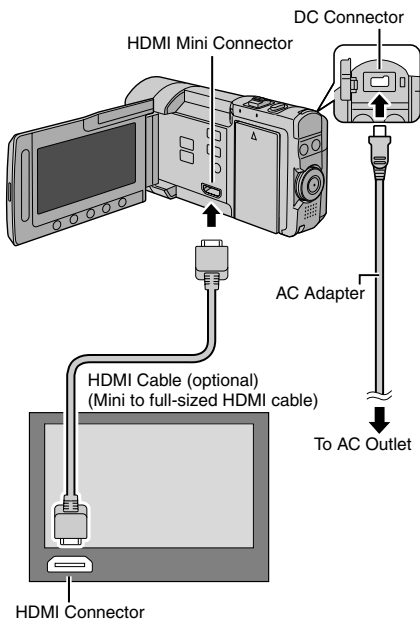

NOTE

- When connecting to the HDMI cable, the image or sound may not appear on the TV properly depending on the TV connected. In such cases, perform the following operations.
 - 1) Disconnect the HDMI cable and connect it again.
 - 2) Turn off and on the camera again.

■ To connect using the COMPONENT connector

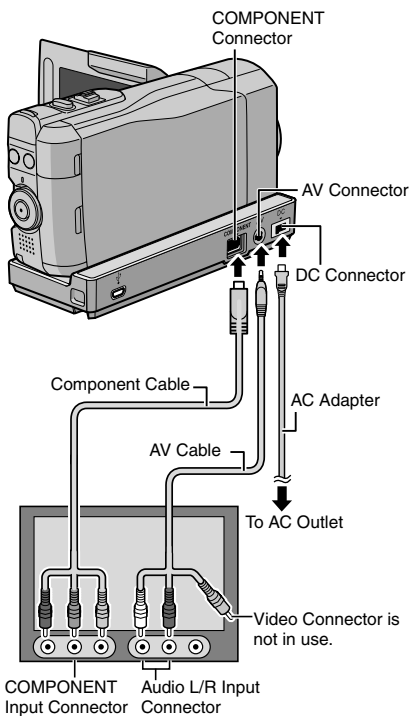

NOTE

Change the settings in [COMPONENT OUTPUT] according to the connection. (☞ p. 73)

■ To connect using the AV connector

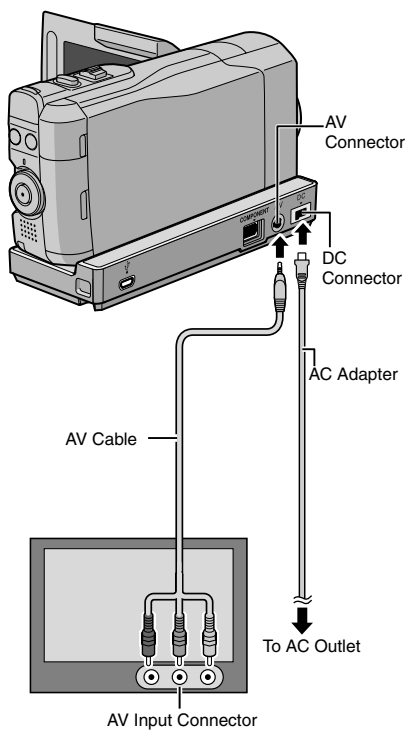

NOTE

Change the settings in [VIDEO OUTPUT] to suit the screen size of your television. (☞ p. 73)

Playback Operation

After the connection with TV is completed

- 1 Turn on the camera and the TV.
- 2 Set the TV to its VIDEO mode.
- 3 (Only when connecting the camera to the VCR/DVD recorder)
Turn on the VCR/DVD recorder, and set the VCR/DVD recorder to its AUX input mode.
- 4 Start playback on the camera. (☞ p. 28, 29)

-
- To display camera's on-screen display on TV
Set [DISPLAY ON TV] to [ON]. (☞ p. 73)

NOTE

When the video was recorded with x.v.Color™ set to [ON], change the x.v.Color™ setting on TV. (☞ p. 70) For details, refer to the TV's instruction manual.

Operating in Conjunction with TV via HDMI

Connecting the camera to an HDMI-CEC-enabled TV using the HDMI cable allows you to utilize the following convenient functions.

- HDMI-CEC (Consumer Electronics Control) is an industry standard that enables interoperability between HDMI-CEC compliant devices that are connected via HDMI cables.

NOTE

- Not all HDMI-control devices comply with the HDMI-CEC standard. The HDMI control function of the camera will not work when connected to these devices.
- The camera is not guaranteed to operate with all HDMI-CEC-enabled devices.
- Depending on the specifications of each HDMI-CEC-enabled device, some functions may not work with the camera. (For details, refer to the instruction manual of your TV.)
- Unintended operations may occur with some connected devices. In these cases, set [HDMI CONTROL] to [OFF].

Preparation:

- Connect an HDMI cable between the camera and the TV. (☞ p. 38)
- Turn on the TV and set the HDMI-CEC related setting to on. (For details, refer to the instruction manual of the TV.)
- Turn on the camera and set [HDMI CONTROL] to [ON]. (☞ p. 73)

■ Operation method 1

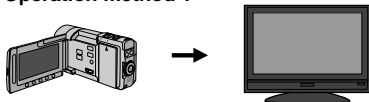

- ① Turn on the camera.
- ② Select the playback mode.
- ③ Connect the HDMI cable.

TV turns on automatically and switches to HDMI input mode when the camera is turned on.

■ Operation method 2

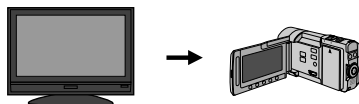

Turn off the TV.

The camera turns off automatically.

■ Operation method 3

- Depending on the TV connected, the display language of the camera will automatically switch to the language that is used selected for the TV when the camera is turned on. (This is applicable only if the camera supports the language selected for the TV.) To use the camera with a language that differs from the display language of the TV, set [HDMI CONTROL] to [OFF].

NOTE

- The display language of the TV will not switch automatically, even if the display language of the camera is changed.
- These functions may not work correctly when devices such as amplifier and selector are connected. Set [HDMI CONTROL] to [OFF].
- If HDMI-CEC does not work properly, turn off and on the camera again.

Managing Files

CAUTION

Do not remove the recording medium or perform any other operation (such as turning off the power) while accessing files. Also, be sure to use the provided AC adapter, as the data on the recording medium may be corrupted if the battery becomes exhausted during operation. If the data on the recording medium becomes corrupted, format the recording medium to use the medium again. (p. 72)

Capturing a Still Image from a Video

You can capture the desired scene from a recorded video, and store it as a still image.

Preparation:

- Select the playback mode.
- Select  mode.

Press **SNAPSHOT** when playback is paused.

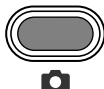



NOTE

- Captured still images are stored at a resolution of 1920 x 1080.
- The continuous shooting function cannot be used to capture images.
- You cannot capture video during playback.

Deleting Files

- Protected files cannot be deleted. To delete them, release the protection first. (p. 43)
- Once files are deleted, they cannot be restored. Check files before deleting.

Preparation:

- Select the playback mode.
- Select  or  mode.

1 Touch **MENU**.

2 Select **[DELETE]**.

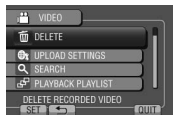

Deleting the Currently Displayed File

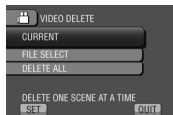

After performing steps 1-2

3 Select **[CURRENT]**.



4 Select **[YES]**.



You can select the previous or next file by selecting  or .

To quit the screen

Select **[QUIT]**.

Managing Files (Continued)

Deleting Selected Files

After performing steps 1-2 (p. 41)

3 Select [FILE SELECT].

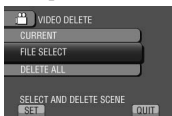

4 Select the desired file and select .

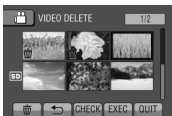

- The  mark appears on the file. To select other files, repeat this step.
- To check the content of the file, select [CHECK].

5 Select [EXEC].

6 Select [YES].



■ To quit the screen

Select [QUIT].

Deleting All Files

After performing steps 1-2 (p. 41)

3 Select [DELETE ALL].

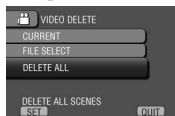

4 Select [YES].



■ To quit the screen

Select [QUIT].

Protecting Files

Preparation:

- Select the playback mode.
- Select or mode.

1 Touch MENU.

2 Select [EDIT].



3 Select [PROTECT/CANCEL].



Protecting the Currently Displayed File

After performing steps 1-3

4 Select [CURRENT].



5 Select [YES].



You can select the previous or next file by selecting or .

■ To quit the screen

Select [QUIT].

Protecting Selected Files

After performing steps 1-3

4 Select [FILE SELECT].



5 Select the desired file and select .



- The (protection) mark appears on the file. To select other files, repeat this step.
- To check the content of the file, select [CHECK].

6 Select [QUIT].

7 Select [YES].



■ To release protection

Select the protected file in step 5.

The (protection) mark disappears.

Managing Files (Continued)

Protecting All Files

After performing steps 1-3 (☞ p. 43)

4 Select [PROTECT ALL].



5 Select [YES].



To quit the screen

Select [QUIT].

To release protection of all files

- 1) In step 4, select [CANCEL ALL].
- 2) Select [YES].

Viewing File Information

Preparation:

👤 mode:

Pause the playback. Otherwise, select the file on the index screen.

📷 mode:

Play back the still image. Otherwise, select the file on the index screen.

Press **INFO**.



- **FILE** (📷 mode): File name
- **FOLDER** (📷 mode): Folder name
- **DATE/TIME**: Date and time of the recording
- **PB TIME** (👤 mode): Playback time (length of the file)
- **SIZE** (📷 mode): Image size (☞ p. 70)
- **QUALITY**: Video quality (☞ p. 69)/Image quality (☞ p. 70)
- **PROTECT**: File protection status (☞ p. 43)

To turn off the file information display

Press **INFO** again.

Histogram



A histogram is a graph indicating the image's brightness. By checking the image and its histogram, you can see the exposure level pattern and the overall tone reproduction.

Preparation:

Play back the still image.

Press **INFO** twice.



- The shutter speed, F-number and ISO sensitivity (GAIN) when recorded are also displayed.
- A larger number of pixels in the center position indicates correct exposure and well-balanced brightness.

To turn off the file information display

Press **INFO** again.

NOTE

The shutter speed displayed during shooting in auto mode is an approximation. It may not match the one displayed with the histogram.

Changing the Event Registration

Preparation:

- Select the playback mode.
- Select  mode.

1 Touch MENU.

2 Select [EDIT].



3 Select [CHANGE EVENT REG.].



Changing the Event of the Currently Displayed File

After performing steps 1-3

4 Select [CURRENT].



5 Select [YES].



You can select the previous or next file by selecting ← or →.

6 Select a new event.

To cancel the event registration, select [CANCEL].



Changing the Event of the Selected Files

After performing steps 1-3

4 Select [SET RANGE AND CHANGE].



5 Select the first file of the range.

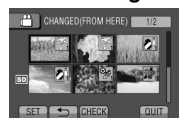

To preview scenes, select the file and select [CHECK].

6 Select the last file of the range.

7 Select a new event.

To cancel the event registration, select [CANCEL].



■ To quit the screen

Select [QUIT].

Managing Files (Continued)

Dividing Files

You can divide a selected video into two.

Preparation:

- Select the playback mode.
- Select  mode.

1 Touch MENU.

2 Select [EDIT].



3 Select [DIVIDE].



4 Select the desired file.

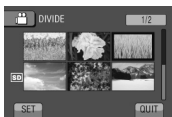

Playback starts.

5 Select [SET] at the point you want to divide the file.

It is recommended to select [SET] after the pause button is pressed.



Use these controls to locate the division point.

The actual division point may differ slightly from the point that is set.

6 Select [DIVIDE HERE].



To set the division point again, select [CANCEL].

To quit the screen

Select [QUIT].

NOTE

- When playing back the divided file, the recording date of the division point is displayed.
- You cannot divide the files with the export setting or the upload setting turned on.

Trimming Files

You can select the necessary part of the video and save it as a new video file.

Preparation:

- Select the playback mode.
- Select  mode.

1 Touch MENU.

2 Select [EDIT].



3 Select [TRIMMING].



4 Select the desired file.

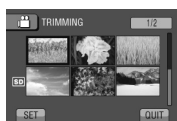

5 Select [SET] at the start point.

It is recommended to select [SET] after the pause button is pressed.



Use these controls to locate the starting point.

6 Select [SET] at the end point.

It is recommended to select [SET] after the pause button is pressed.



To cancel the start point setting, select [CANCEL].

7 Select [CAPTURE TRIMMED FILE].

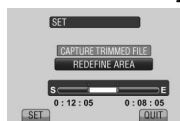

To set the start/end point again, select [REDEFINE AREA].

8 Select [YES].

When copying is finished, the copied file is added to the index screen.

9 Touch OK.

■ To quit the screen

Select [QUIT].

NOTE

Original file is kept untouched.

Managing Files (Continued)

Face Detection Zoom

You can enlarge the part including a face in a still image and save it as a new file.

Preparation:

- Select the playback mode.
- Select  mode.

1 Select the desired still image.

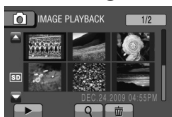

2 Select .



3 Touch the touch sensor to select the face to zoom.



4 Select .



5 Adjust the zoom area.



- Touch the touch sensor to move the area forward or backward.
- Select  to change the zoom ratio.

6 Select [SAVE].



Zoomed images are saved in 16:9 aspect regardless of the original aspect.

7 Select [YES].

8 Touch OK.

NOTE

- Face detection zoom does not work if the faces are not in an upright position.
- Ensure that the faces are upright by rotating the image 90° before using the face detection zoom.

Playlists

It is a list that enables you to organize recorded videos in order of preference.

Preparation:

- Select the playback mode.
- Select  mode.

Creating Playlists

1 Touch MENU.

2 Select [EDIT PLAYLIST].

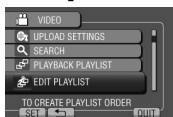

3 Select [NEW LIST].



4 Select an item and display files.



- **[CREATE FROM SCENE]:**
Display all files individually.
- **[CREATE BY GROUP]:**
Display all files listed by group.
- **[CREATE BY DATE]:**
Display all the files listed by recording date.
- **[CREATE BY EVENT]:**
Search for an event and display the corresponding files listed by recording date.

5 Select the file to add to playlist.



To preview scenes, select the file and select [CHECK].

6 Select the insertion point.



- To add other files, repeat steps 5 and 6.
- To delete a registered scene, select the registered file, then select [CANCEL].

7 Select [SAVE].

8 Select [SAVE AND QUIT].



■ To quit the screen

Select [QUIT].

NOTE

- A maximum of 99 playlists can be created.
- If you delete the original files, the corresponding files are also deleted from the playlist.

Playlists (Continued)

Playing Back Playlists

- 1 Touch **MENU**.
- 2 Select **[PLAYBACK PLAYLIST]**.



- 3 Select the playlist.

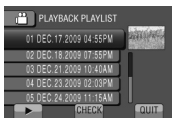

■ To stop playback

Select **■**.

■ To quit the screen

Select **[QUIT]**.

■ To play back from the desired scene

- 1) In step **3**, select **[CHECK]**. (The index screen for playlist appears.)
- 2) Select the desired scene.

Other Operations of Playlists

You can perform additional editing and delete files in a created playlist.

Adding/Deleting Files in Playlist

After performing steps **1-2** (☞ p. 49)

- 3 Select **[EDIT]**.
- 4 Select the playlist you want to edit.
To add or delete files, follow the steps **5** to **8**. (☞ p. 49)

Deleting Playlist

Original files are not deleted even if you delete the playlist.

After performing steps **1-2** (☞ p. 49)

- 3 Select **[DELETE]**.
- 4 Select a playlist you want to delete.
To delete all playlists at once, select **[DELETE ALL]**.
- 5 When **[DELETE ALL PLAYLISTS?]** appears, select **[YES]**.

Print Setting

DPOF Print Setting

This camera is compatible with DPOF (Digital Print Order Format). You can set which images to be printed and the number of prints with this camera. This feature is useful to print with a DPOF-compatible printer or take the SD card to a photo lab for printing.

Preparation:

- Select the playback mode.
- Select mode.

1 Touch **MENU**.

2 Select **[DPOF]**.



Setting Files Individually

After performing steps 1-2

3 Select **[SET PRINT QUANTITY]**.



4 Select the desired file.



- To check the content of the file, select **[CHECK]**.

5 Select the number of prints. (max. 15 prints)

- Slide your finger up and down on the sensor. You can set the value by using the touch sensor.
- To set print information for other images, repeat steps 4 and 5. (You can set up to 999 files.)
- To cancel the selection
Set the number of prints to "00" in step 5.

Setting All Files Together (One Print for Each File)

After performing steps 1-2 (→ left column)

3 Select **[SET ALL 1]**.



4 When **[SET ALL TO 1?]** appears, select **[YES]**.

■ To quit the screen
Select **[QUIT]**.

■ To confirm DPOF settings

In step 3, select **[CHECK QUANTITY]**.

- If necessary, change the number of prints for the desired file by following steps 4 and 5. ("Setting Files Individually", left column)

■ To reset DPOF settings

- 1) In step 3, select **[RESET]**.
- 2) When **[RESET PRINT QUANTITY?]** appears, select **[YES]**.

Print Setting (Continued)

Direct Printing with PictBridge Printer

If your printer is compatible with PictBridge, still images can be printed easily by connecting the camera directly to the printer with the USB cable.

Preparation:

Close the LCD monitor to turn off the camera.

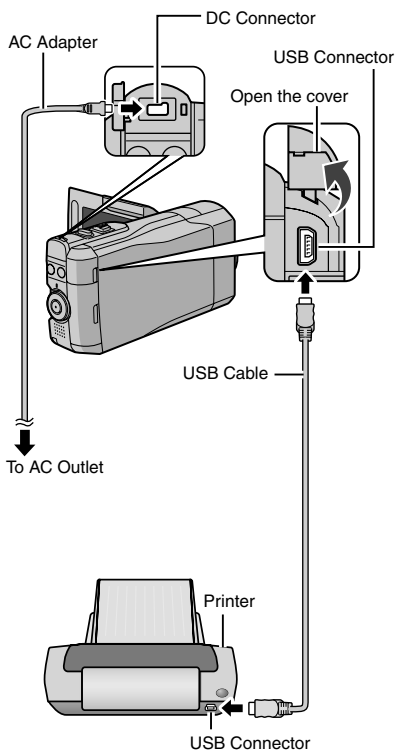

- You can also connect the AC adapter using the Everio dock connector.

1 Open the LCD monitor to turn on the camera.

2 Select **[DIRECT PRINT]**.

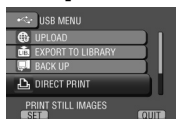

3 Select the desired image.

- Select a still image using **[←]** and **[→]**, then touch **[SET]**.



4 Select the desired setting.



- **[NUMBER OF PRINTS]:**
The number of prints can be set from 1 to 99.
- **[DATE]:**
Set whether to print the date and time.

5 Select **[PRINT]**.

■ To stop printing after printing starts

- 1) Select **[STOP]**.
- 2) When **[QUIT PRINTING?]** appears, select **[YES]**.

Copying Files

Types of Copying and Connectable Device



The Camera

DVD Burner CU-VD50/CU-VD3

You can copy files recorded on this camera onto discs.

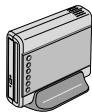

BD Burner LaCie Model No. 301828

You can copy files recorded on this camera onto discs.

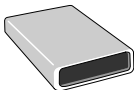

USB External Hard Disk Drive

You can copy files recorded on this camera onto a USB external hard disk drive.



PC

You can copy files from the camera to a disc using a PC.



VCR/DVD Recorder

You can dub video recorded on this camera onto VCR/DVD recorder.



Using a BD/DVD Burner

The files in the camera can be backed up to a disc using a BD/DVD burner.

- Use one of the following methods to view the disc. (If you try to play back the disc with incompatible player, the disc may not be ejected.)
 - Playback the disc using the camera. (p. 56)
 - Playback the disc using a BD/DVD burner.*
 - Playback on a PC.*
 - Playback the disc using a BD/DVD player that supports BD-MV and AVCHD.*
- * The DVD must first be finalized on the camera.
- Other than the created BD/DVD using a BD/DVD burner cannot be played.
- When connecting a DVD burner (CU-VD50) to a TV, you can play back the created disc without using the camera. When playing back disconnect the USB cable.
- The created Blu-ray discs are not guaranteed to be playable on all BD players or recorders.

NOTE

- Recommended USB external hard disk drive

Seagate	FreeAgent™ Desk series
LaCie	Design by Neil Poulton series

- USB external hard disk drive with the capacity over 2 TB cannot be used.

Copying Files (Continued)

Connection with a BD/DVD Burner

Preparation:

Turn on the camera first, then turn on the BD/DVD burner.

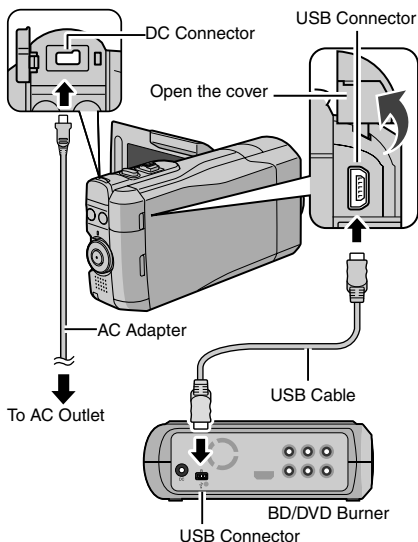

- You can also connect the cables using the Everio dock connectors.

NOTE

- Refer also to the optional BD/DVD burner's instruction manual.
- When connecting to a DVD burner, use the USB cable that came with the DVD burner.
- When connecting to a BD burner, use a USB cable with Mini-A(Male) to B(Male) connectors. JVC's QAM0852-001 (optional) is recommended. Refer to page 64 for details.

Backup All Files

Preparation:

- Select or mode.
- Connect the camera to the BD/DVD burner.
- When using a BD burner, select [CHANGE REC. MEDIA] and select the disc type.

- 1 Select [CREATE FROM ALL] (mode) or [SAVE ALL] (mode).

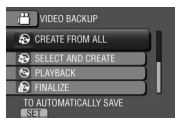

- 2 Select the desired menu.

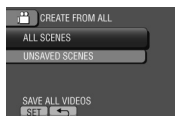

- mode: [ALL SCENES]
 mode: [ALL IMAGES]
All files in the recording medium are copied.
- mode: [UNSAVED SCENES]
 mode: [UNSAVED IMAGES]
Files that have never been copied are automatically selected and copied.

- 3 Select [EXECUTE].



- 4 Select [YES] or [NO].

- [YES]: Displays the thumbnails by group.
- [NO]: Displays the thumbnails by date or by playlist.



- 5 Select [EXECUTE].

- The files are copied on the disc. When [COMPLETED] appears, touch **OK**.
- When [INSERT NEXT DISC PRESS [STOP] TO EXIT CREATE] appears, change the disc. Remaining files are copied on the second disc.
- To cancel copying, select [STOP].

- To switch between video and still image playback after connecting to a burner, press the / button.

Selecting Files for Backup

Preparation:

- Select  or  mode.
- Connect the camera to the BD/DVD burner.
- When using a BD burner, select [CHANGE REC. MEDIA] and select the disc type.

1 Select [SELECT AND CREATE] (mode) or [SELECT AND SAVE] (mode).

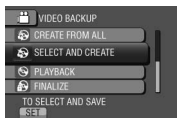

2 Select the desired menu.



mode:

• [CREATE BY DATE]:

Files are sorted according to the date on which they were recorded. Relevant files are displayed in a list. Select the recording date.

• [CREATE BY EVENT]:

Files are sorted according to event. Relevant files are displayed in a list. Select the event.

• [CREATE BY PLAYLIST]:

Select the desired playlist from the list of playlists. The selected playlists are displayed in a list.

- 1) Select the desired list.
- 2) Select the insertion point. To select other lists, repeat this process.
- 3) Select [SAVE].

• [SELECT FROM SCENES]:

Select files individually.

- 1) Select the desired file. To select other files, repeat this process.
- 2) Select [SAVE].

mode:

• [SAVE BY DATE]:

Files are sorted according to the date on which they were recorded. Relevant files are displayed in a list. Select the recording date.

• [SELECT FROM IMAGES]:

Select files individually.

- 1) Select the desired file. To select other files, repeat this process.
- 2) Select [SAVE].

3 Select [YES] or [NO]. (mode only)

- [YES]: Displays the thumbnails by group.
- [NO]: Displays the thumbnails by date or by playlist.

4 Select [EXECUTE].

- The files are copied on the disc. When [COMPLETED] appears, touch **OK**.
- When [INSERT NEXT DISC PRESS [STOP] TO EXIT CREATE] appears, change the disc. Remaining files are copied on the second disc.
- To cancel copying, select [STOP].

■ To quit the screen

- 1) Select [QUIT].
- 2) When [QUIT?] appears, select [YES].

■ To switch between video and still image playback after connecting to a burner, press the / button.

■ To finalize the disc after copy is finished

- 1) Connect the camera to the BD/DVD burner.
- 2) Turn on the camera.
- 3) Select [FINALIZE].
- 4) Select [EXECUTE].
- 5) When [COMPLETED] appears, select [OK].

Copying Files (Continued)

■ To check whether the disc was created properly

In step 1, select [PLAYBACK].

■ To play back the created disc using the camera

- 1) Connect the camera to the BD/DVD burner.
- 2) Turn on the camera first, then turn on the BD/DVD burner.
- 3) Select [PLAYBACK].
- 4) Select the desired folder. (📷 mode)
- 5) Select the desired file. To return to the previous screen, select ⏪.

Digest Playback

You can view a few seconds from the beginning of each video (digest) in the created DVD.

Create a DVD using a BD/DVD burner.

1 Load the created DVD on the DVD player.

As the DVD where videos are saved to supports the AVCHD standard, it may be played back on AVCHD compliant Blu-Ray recorders, etc.

2 On the TV, select [DIGEST PLAYBACK].*



You can view the previous or next page by selecting </>.

* The screen does not appear on the camera.

3 The digest is played back continuously.

■ To normal playback / To the index menu

- 1) Press the top menu button on the remote control of the DVD device during the digest playback.
- 2) Select the desired item.

NOTE

- “Digest Playback” menu is not available when DVD is burned using the provided MediaBrowser software.
- In some cases, parts of video other than the beginning may be played back.
- Some video may not be played back at all.

Using a USB External Hard Disk Drive

You can copy video and still image files to a USB external hard disk drive from the camera. You can also play the files in the USB external hard disk drive on the camera.

Connection with a USB External Hard Disk Drive

Preparation:

Turn on the camera first, then turn on the USB external hard disk drive.

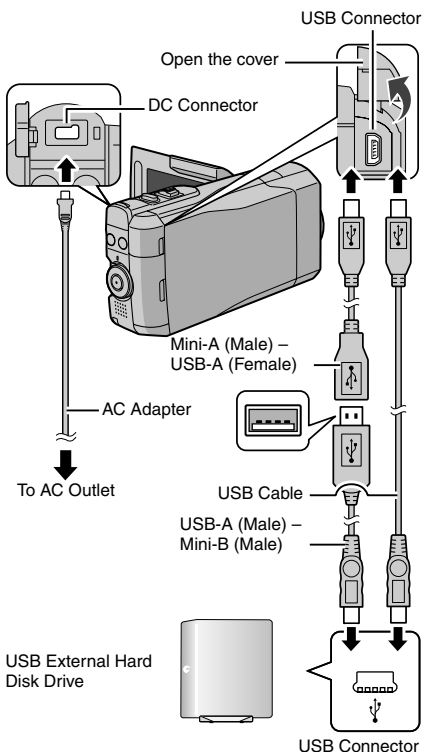

NOTE

- Refer also to the optional USB external hard disk drive's instruction manual.
- When connecting to a Seagate's FreeAgent™ Desk series product, use a USB cable with Mini-A(Male) to Mini-B(Male) connectors. JVC's QAM0852-001 (optional) is recommended. Refer to page 64 for details.
- When connecting to a Design by Neil Poulton series product, use a USB cable with Mini-A(Male) to B(Male) connectors. JVC's QAM0852-001 (optional) is recommended. Refer to page 64 for details.

Backup All Files

Preparation:

- Select or mode.
- Connect the camera to the USB external hard disk drive.

1 Select the desired menu.

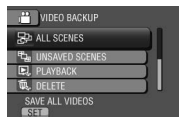

- mode: [ALL SCENES]
- mode: [ALL IMAGES]
- All files in the recording medium are copied.
- mode: [UNSAVED SCENES]
- mode: [UNSAVED IMAGES]
- Files that have never been copied are automatically selected and copied.

2 Select [OK].

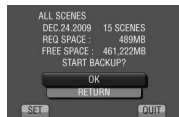

- The files are copied on the disc. When [COMPLETED] appears, touch **OK**.
- To cancel copying, select [STOP].

■ To delete each folder in the USB external hard disk drive

In step 1, select [DELETE].

Copying Files (Continued)

■ To play back the files in the USB external hard disk drive

- 1) In step 1, select [PLAYBACK].
- 2) Select the desired folder.
- 3) Select the desired file. To return to the previous screen, select .

■ To format the USB external hard disk drive

In step 1, select [FORMAT].

■ When connecting a USB external hard disk drive to the camera

- Do not connect a USB hub between the camera and the USB external hard disk drive.
- Disconnect the USB external hard disk drive when using other USB devices such as BD/DVD burner or another USB external hard disk drive.
- Format the USB external hard disk drive when connecting it to the camera for the first time. (All data is deleted.)

■ When copying or playing back

- Copying may take time. (For example, saving 1 hour video in XP mode takes about 20 minutes.)
- Avoid the following operations during copying and playing back.
 - Turning off the camera or the USB external hard disk drive.
 - Disconnecting the USB cable.
- Files in the USB external hard disk drive cannot be copied back to the camera.
- Files deleted from the camera cannot be written to a disc using a BD/DVD burner, even if they have been copied in the USB external hard disk drive.
- Sound or video may be interrupted during playback.

■ When connecting a USB external hard disk drive to a PC

- Do not format the USB external hard disk drive using the PC. If you did, format again using the camera. (All the data in the USB external hard disk drive will be erased.)
- Avoid the following operations using the PC.
 - Deleting files or folders in the USB external hard disk drive.
 - Moving files or folders in the USB external hard disk drive.
 - Changing the name of files or folders in the USB external hard disk drive.These operations make the data impossible to be played back on the camera.
- When you use the PC to edit the data in the USB external hard disk drive, copy the data to the PC before editing. Editing the data in the USB external hard disk drive directly from the PC makes the data impossible to be played back on the camera.

NOTE

Refer to the help of the provided Everio MediaBrowser software when you use the PC to operate the data in the USB external hard disk drive directly copied from the camera.

Dubbing Files to a VCR/DVD Recorder

Preparation:

- Create a playlist.
- Turn off all units.

■ To connect using the AV connectors (analog dubbing)

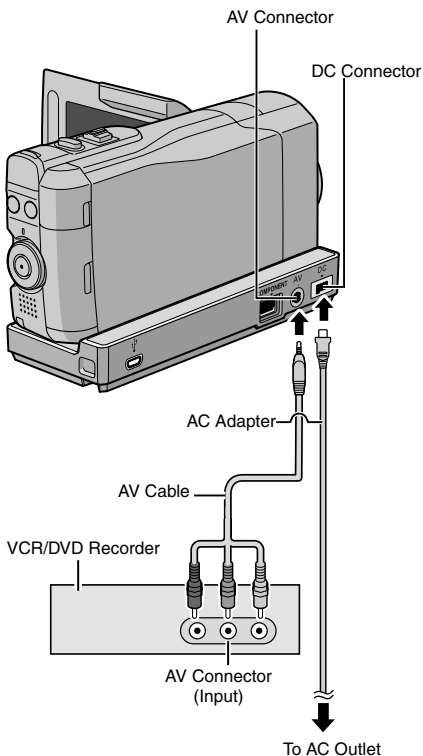

- When other devices such as a DVD burner are connected to the Everio dock, turn the power of these devices off.

1 Open the LCD monitor to turn on the camera.

2 Set the VCR/DVD recorder to its **AUX input mode**.

Check that the images from the camera are input correctly to the VCR/DVD recorder.

3 Play back playlists on the camera.

- 1) Touch **MENU**.
- 2) Select [DUBBING PLAYBACK].
- 3) Select the desired playlist.
- 4) Select [YES]. (A black screen is displayed for 5 seconds at the first and the last scene.)

4 At the point you want to start dubbing, start recording on the VCR/DVD recorder.

Refer to the VCR/DVD recorder's instruction manual.

■ To stop dubbing

Stop recording on the VCR/DVD recorder.

■ To hide the date or icons on the screen

Change the settings in [DISPLAY ON TV].
(p. 73)

Switching indication modes on LCD monitor

Each time you touch **DISPLAY**, indications on LCD monitor switch as shown below:

In recording mode:

All indications/Indications for selected functions

In playback mode:

All indications/Only date and time/No indications

Creating a Disc using a PC

You can copy the data from the camera and create a disc using a PC.

1 Installing the software to the PC

System Requirements

Windows Vista

OS: Windows Vista®
Home Basic (SP1)
Home Premium (SP1)
(32-bit, pre-installed)

CPU: Intel® Core™ Duo, 1.66 GHz or higher
(Intel® Core™ 2 Duo 2.13 GHz or higher
recommended.)

RAM: At least 2 GB

Windows XP

OS: Windows® XP
Home Edition (SP2/SP3)
Professional (SP2/SP3)
(pre-installed)

CPU: Intel® Core™ Duo, 1.66 GHz or higher
(Intel® Core™ 2 Duo 2.13 GHz or higher
recommended.)

RAM: At least 1 GB

To check the PC specification

Right-click on [Computer] (or [My Computer]) in the [Start] menu and select [Properties].

NOTE

- Make sure your PC has a recordable BD/DVD drive.
- If your system does not meet the requirements, it is recommended to copy files using the BD/DVD burner. (p. 53)
- Macintosh users may use the software included with their Macintosh (iMovie '08/09, iPhoto) to import files to their computer.

Preparation:

Load the provided CD-ROM into the PC. In Windows Vista, the auto play dialog box appears.

1 Click [Easy Installation].



Follow the on-screen instructions.

2 Click [Next].



3 Click [Finish].

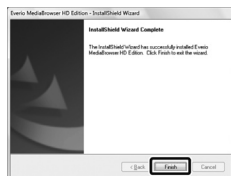

Everio MediaBrowser icons are created on the desktop.



Everio MediaBrowser Player is a software that plays AVCHD discs on the PC. (DVD discs cannot be played.)

To see the Instruction Guide for Everio MediaBrowser

- 1) Double-click the icon of Everio MediaBrowser.
- 2) Click [Help], and click [MediaBrowser Help].

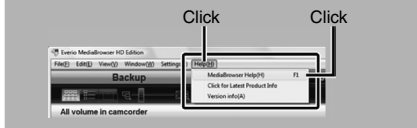

2 Making Backup on the PC

Preparation:

- Install the software to the PC.
- Make sure that enough free space is left in the PC's HDD.
- Close the LCD monitor to turn off the camera.

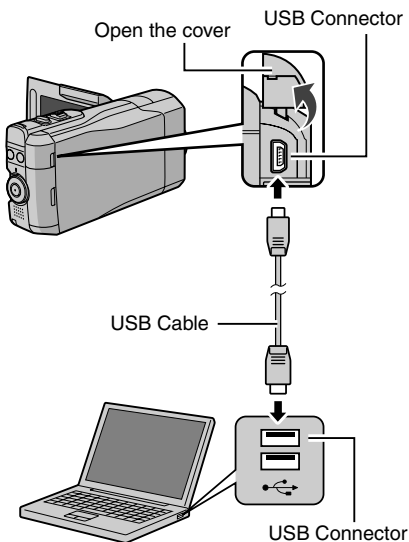

1 Open the LCD monitor to turn on the camera.

2 Select [BACK UP].

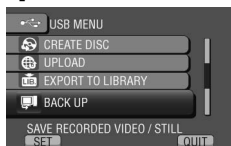

Everio MediaBrowser starts on the PC.

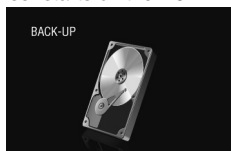

3 Click [All volume in camcorder] and click [Next].



4 Click [Start].



Backup starts.

■ To disconnect the camera from the PC

- 1) Right-click the icon (Safely Remove Hardware) on the task bar and select [Safely remove USB Mass Storage Device].
- 2) Follow the on-screen instructions and make sure that the device can be safely removed.
- 3) Disconnect the USB cable and close the LCD monitor.

NOTE

It takes time to back up many videos.

Creating a Disc using a PC (Continued)

3 Making User Lists to Arrange the Files

You can make a user list of a certain subject (such as Travel, Athletic meet) and put the files related to the subject into the user list.

Preparation:

Make backup on the PC.

1 Double-click the icon to open the calendar.



2 Select [Movies only].



3 Click [+].



4 Input the name of the new user list and click [OK].

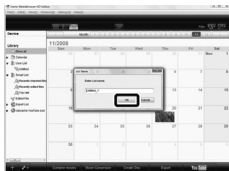

5 Click the recording date.



The files recorded on the day are displayed.

6 Drag the file and drop into the user list.



To add other files into the user list, repeat steps 5 and 6.

1 Copying Files to a disc

Everio MediaBrowser supports 3 disc formats. Select the one that suits your purpose.

DVD-Video disc: Suitable if you will give the disc to your friends and relatives.

AVCHD disc: Suitable for high quality video.

BD: Suitable for high quality video with long recording time.

1 Select the user list and click [Create Disc].



2 Select the disc type and click [Next].



3 Click [Select files individually] and click [Next].

To add all the files onto discs, click [Select all files displayed], then go to step 5.



4 Drag the file, and drop into the part at the bottom and click [Next].



5 Input the disc name, select the top menu style and click [Next].



6 Click [Start].



NOTE

- When copying video recorded in UXP recording mode to create an AVCHD disc, the video needs to be converted to XP recording mode before copying. Therefore, it may take longer time than copying video recorded in other modes.
- Use Everio MediaBrowser Player to playback the disc. Refer to the help of the provided Everio MediaBrowser software to operate.
- For detail on operating Everio MediaBrowser, click [Help] and refer to [MediaBrowser Help].
- Adobe® Reader® must be installed to read [MediaBrowser Help]. Adobe® Reader® can be loaded from Adobe's web site: <http://www.adobe.com>
- For assistance in operating the provided software, refer to the support information. (p. 64)

Creating a Disc Using a PC (Continued)

Folder Structure and Extensions

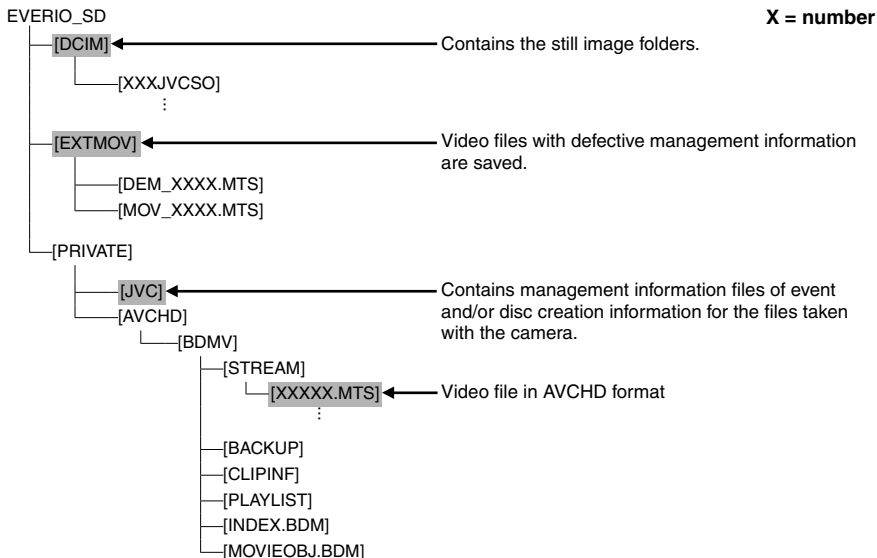

Customer Support Information

Use of this software is authorized according to the terms of the software license.

JVC

When contacting the nearest JVC office or agency in your country (refer to the JVC Worldwide Service Network at <http://www.jvc-victor.co.jp/english/worldmap/index-e.html>) about this software, please have the following information ready.

- Product Name, Model, Problem, Error Message
- PC (Manufacturer, Model (Desktop/Laptop), CPU, OS, Memory (MB), Available Hard Disk Space (GB))

Please note that it may take some time to respond to your questions, depending on their subject matter. JVC cannot answer questions regarding basic operation of your PC, or questions regarding specifications or performance of the OS, other applications or drivers.

Pixela

Region	Language	Phone #
USA and Canada	English	+1-800-458-4029 (toll-free)
Europe (UK, Germany, France, and Spain)	English/German/French/Spanish	+800-1532-4865 (toll-free)
Other Countries in Europe	English/German/French/Spanish/Italian/Dutch	+44-1489-564-764
Asia (Philippines)	English	+63-2-438-0090
China	Chinese	+86-21-5385-3786

Homepage: <http://www.pixela.co.jp/oem/jvc/mediabrowser/e/>

Please check our website for latest information and downloading.

Using with a Portable Media Player

Turning on the Export Mode

You can easily transfer videos recorded in export mode to iTunes®. All the files with the export setting turned on are transferred to PC. For details on transferring, refer to the operation guide of MediaBrowser in the CD-ROM.

Preparation:

- Select the recording mode.
- Select  mode.

Press **EXPORT** twice.



- When the export mode is set on, the [LIB.] indicator lights up on the LCD monitor.



■ To turn off the export mode

Press **EXPORT** twice.

Changing the Export Setting

You can set the recorded videos to the export setting.

Preparation:

- Select the playback mode.
- Select  mode.

1 Press **EXPORT**.



2 Select the file and set **[LIB.]**.



To check the content of the file, select **[CHECK]**.

3 Select **[DONE]**.

■ To cancel the export setting

Select the file and select **[LIB.]** again.

■ To quit the screen

- 1) Select **[DONE]**.
- 2) Select **[YES]**.

■ To confirm the export setting

Press **EXPORT** on the index screen.

Transferring the Files to PC

Preparation:

Install iTunes® on a PC.

<http://www.apple.com/itunes/>

- 1 Connect the camera to the PC with the USB cable.
- 2 Select [EXPORT TO LIBRARY].



All the files with the export setting turned on are transferred to PC.

- **If you cannot export the file to iTunes®**
Refer to "Q&A", "Latest Information", "Download Information", etc. in [Click for Latest Product Info] in the help of the provided Everio MediaBrowser software.

Turning on the Upload Mode

You can upload the file to video sharing websites (YouTube™) quickly after recording.

Preparation:

- Select the recording mode.
- Select mode.

Press **UPLOAD** twice.



If you record a file with the upload mode set on, the recording stops automatically 10 minutes after the recording is started. The remaining time is displayed on the LCD monitor.

- When the upload mode is set on, the indicator lights up on the LCD monitor.



NOTE

The upload mode turns off each time recording is finished.

Upload Trimming

You can select the necessary part of the video and save it as a new video file ready for uploading.

Preparation:

- Select the playback mode.
- Select mode.

1 Touch **MENU**.

2 Select [**UPLOAD SETTINGS**].

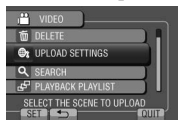

3 Select the desired file.

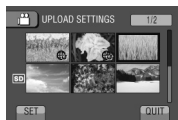

4 Select [**SET**] at the start point.

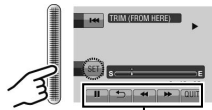

Use these controls to locate the starting point.

5 Select [**SET**] at the end point.

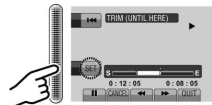

- The duration between the start point and the end point cannot be longer than 10 minutes.
- To cancel the start point setting, select [**CANCEL**].

6 Select [CAPTURE TRIMMED FILE].



To set the start/end point again, select [REDEFINE AREA].

7 Select [YES].

When copying is finished, the copied file is added to the index screen.

- **To quit the screen**
Select [QUIT].

NOTE

Original file is kept untouched.

Uploading Files

For details on uploading files, refer to the operation guide of MediaBrowser in the CD-ROM.

1 Connect the camera to the PC with the USB cable.

2 Select [UPLOAD].

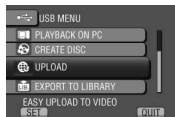

■ If you cannot upload the file to YouTube™

- You need your YouTube™ account to upload files to YouTube™. Create your account.
- Refer to “Q&A”, “Latest Information”, “Download Information”, etc. in [Click for Latest Product Info] in the help of the provided Everio MediaBrowser software.

Changing the Menu Settings

E.g.) Set [OIS] to [ON] or [OFF].

1 Touch MENU.

2 Select the desired menu.

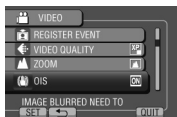

3 Select the desired setting.

For details on each menu, see below.



■ To return to the previous screen

Select [BACK].

■ To quit the screen





















Select [QUIT].















NOTE

Depending on the operation mode, some menu settings may be fixed and are unavailable for selection. In this case, it will be displayed in gray.









Mode	Menus	Settings: [] = Factory-preset
	MANUAL SETTING	See page 33. (In the manual recording mode only)
	REGISTER EVENT	See page 25.
	SELF-TIMER Photo will be taken after the set time elapses when SNAPSHOT is pressed.	[OFF] / 2SEC / 10SEC / FACE DETECTION FACE DETECTION The camera checks the number of faces in the monitor and starts countdown when another face is detected. NOTE <ul style="list-style-type: none"> You can confirm the countdown on the camera screen. It is recommended to attach the camera to a tripod and use this function to prevent the vibration after SNAPSHOT is pressed.
	VIDEO QUALITY Sets the video quality.	UXP: Extra High quality It is recommended to use UXP mode when you will copy the video to a BD. Video recorded in UXP mode cannot be copied to an AVCHD disc. [XP]: High quality SP: Standard quality EP: For recording for a long time You can record in full high-definition (1920 x 1080i) videos with any of the video qualities. NOTE <ul style="list-style-type: none"> It is recommended to set UXP or XP mode when recording scenes with fast moving or with extreme changing in brightness to avoid noise. Video data recorded in UXP mode cannot be saved by a DVD burner. Use a BD burner to save them.









Changing the Menu Settings (Continued)

Mode	Menus	Settings: [] = Factory-preset
	 IMAGE SIZE Selects the image size for still images.	4:3mode:[3456 x 2592] / 3072 x 2304 2592 x 1944 / 1600 x 1200 / 640 x 480 16:9mode:3456 x 1944 / 3072 x 1728 2592 x 1456 / 1920 x 1080 / 1280 x 720
	 IMAGE QUALITY Sets the image quality.	[FINE] / STANDARD
	 ZOOM Sets the maximum zoom ratio.	5X/OPTICAL / [8X/DYNAMIC]* 32X/DIGITAL / 200X/DIGITAL *Dynamic zoom The combination of optical and digital zoom technology offers higher zoom ratio than optical zoom without reducing the quality. NOTE Optical zoom is used up to [5X/OPTICAL]. Digital zoom is used from more than [8X/DYNAMIC] up to the selected zoom ratio.
 	 OIS Compensates for hand shake.	OFF : Deactivates the function. [ON] : Activates the function. NOTE <ul style="list-style-type: none"> • Complete stabilization may not be possible if hand shake is excessive, or depending on the shooting conditions. • Switch off this mode when recording with the camera on a tripod. • The setting is the same for both video and still image recording.
	 GAIN UP Makes the subject appear bright automatically when you record in dark places. However, the overall color tones appear grayish.	OFF : Deactivates the function. AGC : Electrically brightens the scene in dark place. [AUTO]* : Automatically brightens the scene when it is dark. (Becomes brighter than [AGC] recorded in some condition.) Corrects the brightness automatically when used with a slow shutter speed of 1/30 second.
	 x.v.Color Records video in the color range suitable for viewing in an x.v.Color™ compliant TV.	[OFF] : Deactivates the function. ON : Activates the function.
	 WIND CUT Reduces noise caused by wind.	[OFF] : Deactivates the function. ON : Activates the function.
	 GAIN Sets the ISO setting to increase the sensitivity in dark conditions.	[AUTO] / ISO100 / ISO200 / ISO400 / ISO800 / ISO1600 / ISO3200
 	 GRID Displays grid lines on the monitor to help compose the subject accurately.	[OFF] : Deactivates the function. ON : Activates the function.

Menus	Settings: [] = Factory-preset
 DISPLAY SETTINGS	Select [DISPLAY SETTINGS], then select sub-menus.
 LANGUAGE Sets the display language.	[ENGLISH] See page 19.
 CLOCK ADJUST Sets the time.	See page 18.
 DATE DISPLAY STYLE Sets the date and time display format.	DATE STYLE: year.month.day / [month.day.year] / day.month.year TIME: 24h / [12h]
 MONITOR BRIGHT Sets the brightness of the LCD monitor.	Adjusts the brightness of the display by using the touch sensor.
 MONITOR BACKLIGHT Enables you to adjust the brightness of backlight on the monitor.	BRIGHTER : Brightens the backlight on the monitor regardless of the surrounding conditions. STANDARD : Select this when saving the battery life. [AUTO] : The brightness will automatically be set to [BRIGHTER] when using outdoors and to [STANDARD] when using indoors (when using the battery pack).
 FOCUS ASSIST CAMERA When this function is used, the outline of the focused object is displayed in the selected color.	RED / GREEN / [BLUE]
 BASIC SETTINGS	Select [BASIC SETTINGS], then select sub-menus.
 CONT. SHOOTING SPEED Sets the speed of recording intervals.	<p> mode HIGH SPEED : When the dial is set to (M - ), up to 11 still images may be taken continuously in intervals of approx. 0.2 seconds. MEDIUM SPEED : When the dial is set to (M - ), up to 11 still images may be taken continuously in intervals of approx. 1.1 seconds. [LOW SPEED] : Continuous shooting may be performed until the SD card is full. The initial shooting speed is 1 images/second. However, the speed will drop if continuous shooting is used repeatedly.</p> <p> mode HIGH SPEED : When the dial is set to ( - M), up to 6 still images may be taken continuously in intervals of approx. 0.4 seconds. MEDIUM SPEED : When the dial is set to ( - M), up to 6 still images may be taken continuously in intervals of approx. 0.9 seconds. [LOW SPEED] : Continuous shooting may be performed until the SD card is full. The initial shooting speed is 2 images/second. However, the speed will drop if continuous shooting is used repeatedly.</p> <p>NOTE When continuous shooting is used during video recording, the speed changes to [LOW SPEED] temporarily.</p>

Changing the Menu Settings (Continued)

Menus	Settings: [] = Factory-preset
 DEMO MODE Introduces special features of the camera when there is no operation for about 3 minutes during recording mode.	OFF : Deactivates the function. [ON] : Activates the function. NOTE <ul style="list-style-type: none"> ● The demonstration only works when the AC adapter is connected, not with the battery pack. ● If an SD card is in the camera, demonstration will not take place even if this mode is set to [ON].
 AUTO POWER OFF If the camera is not operated for 5 minutes while the power is on, it turns itself off automatically to conserve power.	OFF : Disables the function. [ON] : Activates the function. To turn the camera on again, close the LCD monitor and open it again when using the battery pack. When using the AC adapter, perform any operation such as zooming.
 OPERATION SOUND Turns on/off the operation sound.	OFF : Turns off the operation sound. [ON] : The melody sounds when operations are performed.
 RECORD BUTTON Enables the recording button [REC] on the LCD monitor.	OFF : Deactivates the function. [ON] : Activates the function.
 QUICK RESTART Enables the camera to start up quickly when you turn off the camera and then on again within 3 minutes by closing and opening the LCD monitor.	OFF : Deactivates the function. [ON] : If the LCD monitor is opened again within 3 minutes, the camera starts quickly. The power consumption used for the 3 minute period after the LCD monitor is closed is approximately 1/3 that used during recording. This enables you to save more power than leaving the power on.
 REMOTE Turns on/off reception of the operation signal from the remote control.	OFF : Does not receive the signal from the remote control. [ON] : Enables operation with the remote control.
 AUTO FINALIZE Sets the DVD to a readable state.	OFF : Makes created DVDs recordable (not playable on device other than the camera). [ON] : Finalizes created DVDs so that they can be played back on DVD burner. NOTE <ul style="list-style-type: none"> ● When you play back a DVD created when [OFF] is set on DVD burner, select [FINALIZE] on the DVD creation screen. ● When you create two or more DVDs at the same time, other than the last DVD is finalized automatically even if the setting is [OFF].
 FORMAT SD CARD You have to format newly purchased SD cards with this camera before using them. This will also ensure stable speeds and operation when accessing the SD card.	[FILE] : Initializes all files in the SD card. FILE + MANAGEMENT NO: Initializes all files and management numbers in the SD card. NOTE Be aware that all files and data including protected files will be erased by the formatting process.

Menus	Settings: [] = Factory-preset
 UPDATE Updates and improves the system software.	YES : Performs this function. [NO] : Cancels this function. NOTE Information about obtaining system update will be made available on the JVC's web site.
 FACTORY PRESET Returns all the camera settings to their default values.	YES : Performs this function. [NO] : Returns to the menu screen without executing reset.
 CONNECTION SETTINGS	Select [CONNECTION SETTINGS], then select sub-menus.
 DISPLAY ON TV Displays camera's on-screen display on a TV screen.	[OFF] : Does not display on TV. ON : Displays on TV.
 VIDEO OUTPUT Sets the aspect (16:9/4:3) to the screen of the connected television when outputting videos from the AV connector.	4:3 / [16:9]
 COMPONENT OUTPUT Sets the definition of the video output from the COMPONENT connector.	[480i] : Outputs at 480i. 1080i : Outputs at 1080i.
 HDMI OUTPUT Sets the definition of the video output from the HDMI mini connector.	[AUTO 1] : It is recommended to select [AUTO 1] usually. AUTO 2 : Select when the video is not projected in [AUTO 1] correctly. 480p : Select when the video is not projected in [AUTO 2] correctly. NOTE <ul style="list-style-type: none"> When connecting to a 1080p compatible TV, set [HDMI OUTPUT] to [AUTO 1]. When this is set, "1080P"* appears at the top of the LCD monitor. * Playback mode only
 HDMI CONTROL Selects whether you use the linked operations with the TV, when you connect the TV using the HDMI mini connector.	OFF : Turns off the linked operations. [ON] : Turns on the linked operations.

Troubleshooting

Before requesting service, consult the following chart. If the solutions indicated in the chart do not solve the problem, consult your nearest JVC dealer or JVC service center for instructions.

Refer also to the FAQ of new products on JVC's website.

The following phenomena are not malfunctions.

- The camera heats up when it is used for a long time.
- The battery heats up during charging.
- When playing back a video, the image stops momentarily or the sound is interrupted at junctions between scenes.
- LCD monitor momentarily become red or black when sunlight is recorded.
- Black spots, or red, green, or blue spots appear on the LCD monitor.
(The LCD monitor contains 99.99 % effective pixels, but 0.01 % of fewer pixels may be ineffective.)

Trouble		Action
Card	Cannot insert the SD card.	<ul style="list-style-type: none"> ● Check that the SD card is facing the right direction.
Power	No power is supplied.	<ul style="list-style-type: none"> ● Connect the AC adapter correctly. ● Recharge the battery pack.
	There is a sound when turning on/off the power.	<ul style="list-style-type: none"> ● When you turn on/off the power, the lens cover opens/closes automatically and this causes a sound. This is not a malfunction.
	The power was turned off accidentally.	<ul style="list-style-type: none"> ● If you connect to a TV compatible with HDMI-CEC with an HDMI cable (optional) and turn off the power on the TV, the power on the camera also turns off. If you are not using HDMI-CEC, set [HDMI CONTROL] to [OFF].
Display	The remaining battery display is not correct.	<ul style="list-style-type: none"> ● Fully charge the battery pack, run it down, and then recharge it again. ● If the camera is used for long periods of time in high or low temperatures, or if the battery pack is repeatedly charged, the amount of remaining battery may not be displayed correctly.
	The LCD monitor is difficult to see.	<ul style="list-style-type: none"> ● The LCD monitor may be difficult to see if used in bright areas such as under direct sunlight.

Trouble	Action
Recording cannot be performed.	<ul style="list-style-type: none"> ● SD card is full. Delete unnecessary files or replace the SD card.
Vertical lines appear on recorded images.	<ul style="list-style-type: none"> ● Such a phenomenon occurs when shooting a subject illuminated by bright light. This is not a malfunction.
Recording stops by itself.	<ul style="list-style-type: none"> ● Turn off the camera, wait for a while, and start recording again. ● Recording stops automatically after 12 hours of continuous recording. ● The recording media is full. ● Unable to write to the media due to some factors. ● Unable to keep up with the speed of writing to the media.
The recorded subject is too dark.	<ul style="list-style-type: none"> ● Use backlight compensation. ● Set [GAIN UP] to [AGC] or [AUTO]. (👤 mode only) ● Set [GAIN] or use a flash. (📷 mode only) ● Use [TWILIGHT], [NIGHT & PORTRAIT] and [SLEEPING FACE] in scene mode menu. ● Set the brightness to the [+] side.
The recorded subject is too bright.	<ul style="list-style-type: none"> ● Set the backlight compensation to [OFF] if it is being used. ● Set the brightness to the [-] side.
Digital zoom does not work.	<ul style="list-style-type: none"> ● Change [ZOOM] to [32X/DIGITAL] or [200X/DIGITAL]. ● Digital zoom is not available in the still image recording mode.
The focus is not adjusted automatically.	<ul style="list-style-type: none"> ● Wipe the lens with lens cleaning cloth. ● If you are recording in a dark place or a subject that has no contrast between dark and light, adjust the focus manually.
The color looks strange. (Too bluish, too reddish, etc.)	<ul style="list-style-type: none"> ● Set [WB] in [MANUAL SETTING] appropriately to the light source. ● Select [MWB] in [WB] while holding a sheet of plain white paper in front of the camera so that the white paper fills the screen. Keep touching OK until the 📄 indicator appears.
White balance setting cannot be activated.	<ul style="list-style-type: none"> ● This cannot be used if [SEPIA] or [MONOTONE] are selected as effects. ● Do not use [TWILIGHT], [NIGHT & PORTRAIT], [FIREWORKS], and [SUNSET] in scene mode menu.
The continuous shooting speed is slow.	<ul style="list-style-type: none"> ● The continuous shooting speed will drop after continuous shots. ● Continuous shooting speed may drop depending on the SD card or under certain recording conditions.
A band or a ball of bright light appears on the LCD monitor.	<ul style="list-style-type: none"> ● Change the direction of the camera to prevent the light source from coming into view. (A band or a ball of bright light may appear when there is a bright light source near the camera, but this is not a malfunction.)
Mosaic-type noise occurs when recording scenes with fast moving or with extreme changing in brightness.	<ul style="list-style-type: none"> ● Record videos with high quality mode, such as UXP or XP mode.

Troubleshooting (Continued)

	Trouble	Action
Playback	Sound or video are interrupted.	<ul style="list-style-type: none"> • Sometimes playback is interrupted at the connecting section between two scenes. This is not a malfunction.
	Cannot find a recorded video.	<ul style="list-style-type: none"> • Select [PLAYBACK OTHER FILE] then search the video on the index screen. (Video files that have damaged management information can be played back.) • Cancel group display and date search functions.
	Some functions cannot be used when playing back a backup BD/DVD through a BD/DVD burner connected to the camera.	<ul style="list-style-type: none"> • The following functions cannot be used for a backup BD/DVD. <ul style="list-style-type: none"> When playing back video <ul style="list-style-type: none"> - Search index by date - Playback effects When playing back still image <ul style="list-style-type: none"> - Playback effects
	The color of images looks strange.	<ul style="list-style-type: none"> • When recording the white balance was not correctly adjusted. • When the video was recorded with x.v.Color™ set to [ON], change the setting as desired on TV. • Set [EFFECT] to [OFF].
	The same image is displayed for a long time during video playback, or motion is choppy.	<ul style="list-style-type: none"> • Replace the SD card. (When the SD card terminal is damaged, difficulty in reading the data occurs.) • Format the SD card.
	The image taken in high speed recording is grainy and there is no sound.	<ul style="list-style-type: none"> • The higher the speed, the grainier the image becomes. Also, sound cannot be recorded in high speed recording.
Other problems	The camera operates slowly when switching between video mode and still image mode, or when switching the power on or off.	<ul style="list-style-type: none"> • If there are many files (such as video) in the SD card, it takes time for the camera to respond. It is recommended that you copy all files from the SD card onto your computer, and erase the files from the SD card.
	The SD card cannot be removed from the camera.	<ul style="list-style-type: none"> • Push the SD card in a few more times.
	The lamp does not flash during battery pack charging.	<ul style="list-style-type: none"> • Check the remaining battery pack charge. (When the battery pack is fully charged, the lamp does not flash.) • When recharging in either a hot or cold environment, ensure that battery is being charged within the permitted temperature range. (If the battery pack is being recharged outside the permitted temperature range, recharging may stop to protect the battery pack.)
	Something appears to be shaking at the lens.	<ul style="list-style-type: none"> • When OIS is turned on, shaking may be observed at the lens. This is not a malfunction.
	The remote control does not work.	<ul style="list-style-type: none"> • Replace the battery. • Set [REMOTE] to [ON]. • The remote control may not operate outdoors or in places exposed to strong light.

Trouble		Action
Other problems	When connecting to the HDMI cable, the image or sound does not appear on the TV properly.	<ul style="list-style-type: none"> When connecting to the HDMI cable, the image or sound may not appear on the TV properly depending on the TV connected. In such cases, perform the following operations. <ol style="list-style-type: none"> 1) Disconnect the HDMI cable and connect it again. 2) Turn off and on the camera again.
	HDMI-CEC functions do not work properly, and the TV does not work in conjunction with the camera.	<ul style="list-style-type: none"> TVs may operate differently depending on the specifications, even if they are HDMI-CEC compliant. Therefore, the HDMI-CEC functions of the camera cannot be guaranteed to operate in combination with all the TVs. In such cases, set [HDMI CONTROL] to [OFF].
	The language on the display changed.	<ul style="list-style-type: none"> It may occur when you connect the camera to a TV with different language setting using an HDMI cable.
	Cannot upload the file to YouTube™	<ul style="list-style-type: none"> You need your YouTube™ account to upload files to YouTube™. Create your account. Refer to “Q&A”, “Latest Information”, “Download Information”, etc. in [Click for Latest Product Info] in the help of the provided Everio MediaBrowser software.
	Cannot export the file to iTunes®	<ul style="list-style-type: none"> Refer to “Q&A”, “Latest Information”, “Download Information”, etc. in [Click for Latest Product Info] in the help of the provided Everio MediaBrowser software.

■ **To reset the camera when it does not operate normally**





- ① Open the LCD monitor and turn off the camera using the POWER/DISP button before detaching the battery pack.
- ② And remove the power supply (battery pack or AC adapter) from the camera, then reattach it.
- ③ Execute [FACTORY PRESET]. (☞ p. 73)

Warning Indications

Indication	Action
SET DATE/TIME!	<ul style="list-style-type: none">● Set the clock. After that, charge the internal battery for more than 24 hours by connecting to the AC adapter. If the message still appears, consult your nearest JVC dealer.
COMMUNICATING ERROR	<ul style="list-style-type: none">● Be sure to use JVC battery packs. (Files recorded with other devices that support AVCHD cannot be played back on this camera.)
CANNOT USE IN VIDEO MODE	<ul style="list-style-type: none">● Replace the SD card. (Files recorded with other devices that support AVCHD cannot be played back on this camera.)
NOT FORMATTED	<ul style="list-style-type: none">● Select [OK] and select [YES] to perform formatting.
FORMAT ERROR!	<ul style="list-style-type: none">● Check the operating procedure, and perform once again.● Turn off the camera, and turn it on again.
DATA DELETION ERROR	
MEMORY CARD ERROR!	<ul style="list-style-type: none">● Perform formatting. (All data is deleted.)● Remove and re-insert the SD card. (MultiMediaCard cannot be used.)● Remove any dirt from the SD card terminals.● Insert the SD card before switching the power on.● Turn off the camera, and turn it on again.
RECORDING FAILURE	<ul style="list-style-type: none">● Remove and re-insert the SD card. (MultiMediaCard cannot be used.)● Remove any dirt from the SD card terminals.● Insert the SD card before switching the power on.
PLAYBACK FAILED	
INSUFFICIENT SPACE	<ul style="list-style-type: none">● Delete files. Move files to a PC or other device.● Replace the SD card with a new one.
THIS CARD CANNOT BE USED FOR RECORDING OR EDITING ON THIS CAMERA	<ul style="list-style-type: none">● When you attempt to perform editing on the inserted SD card that has been used for recording on cameras from other manufacturers.

Indication	Action
VIDEO MANAGEMENT FILE IS DAMAGED, RECOVERY IS REQUIRED TO RECORD/PLAYBACK, RECOVER?	<ul style="list-style-type: none"> ● Select [OK] to restore.
UNSUPPORTED FILE!	<ul style="list-style-type: none"> ● Use files recorded with the camera. (Files recorded with other device may not be played back.)
THIS FILE IS PROTECTED	<ul style="list-style-type: none"> ● Switch off the [PROTECT/CANCEL] function in the MENU.
NUMBER OF FOLDERS OVERFLOW	<ul style="list-style-type: none"> ● Replace the backup destination with another disc.
UPPER LIMIT OF RECORDABLE NUMBER OF FOLDERS/ FILES HAS BEEN REACHED	<ul style="list-style-type: none"> ● Move the files or folder to a PC or other device, and then format the SD card. ● Select [FILE + MANAGEMENT NO] in [FORMAT SD CARD].
SCENE QUANTITY LIMIT EXCEEDED	
PLAYLIST QUANTITY EXCEEDS LIMIT	<ul style="list-style-type: none"> ● When creating a disc, reduce the number of playlists to be saved. ● Reduce the number of the playlist to 99 files or less.
NO REGISTERED SCENES IN PLAYLIST SOME OF SCENES MAY NOT BE PLAYED BACK	<ul style="list-style-type: none"> ● Delete the playlist, and then create a new one.
POWER IS OFF, OR USB DEVICE IS UNSUPPORTED	<ul style="list-style-type: none"> ● Turn on the power of the connected USB device. ● Connect the AC adapter to the BD/DVD burner.

Warning Indications (Continued)

Indication	Action
DVD-R DISC HAS BEEN ALREADY USED	<ul style="list-style-type: none">• Replace the disc of the BD/DVD burner with another disc.
FINALIZATION FAILED	<ul style="list-style-type: none">• Replace the disc of the BD/DVD burner with another disc.
NO FILES	<ul style="list-style-type: none">• Press  /  to select the desired mode ( or ).

Cleaning

Before cleaning, turn off the camera and remove the battery pack and AC adapter.

■ To clean the camera

Wipe the camera gently with a soft cloth. If the camera is particularly dirty, dip the cloth into diluted mild soap and wring it out well. After wiping with the wet cloth, wipe again with a dry cloth.

■ To clean the LCD monitor

Wipe the LCD monitor gently with a soft cloth. Be careful not to damage the LCD monitor.

■ To clean the lens

Wipe the lens gently with lens cleaning cloth.

NOTE

- Avoid using strong cleaning agents such as benzine or alcohol.
- Mold may form if the lens is left dirty.
- When using a cleaner or chemically treated cloth, refer to the cautions for each product.

Specifications

■ General

Power supply

- DC 11 V (Using AC adapter)
- DC 7.2 V (Using battery pack)

Power consumption

- Approx. 3.7 W*
- * When the monitor backlight is set to [STANDARD] mode.
- Rated Current Consumption: 1 A

Dimensions (W x H x D)

- 37 mm x 66 mm x 124 mm
- (1-1/2" x 2-5/8" x 4-15/16")

Weight

- Approx. 246 g (0.6 lbs)
- Approx. 298 g (0.7 lbs) (incl. battery pack)

Operating temperature

- 0°C to 40°C (32°F to 104°F)

Storage temperature

- 20°C to 50°C (-4°F to 122°F)

Operating humidity

- 35 % to 80 %

■ Camera/LCD monitor

Pickup

- 10,290,000 pixels (gross)
- 1/2.33" progressive CMOS

Lens

- F 3.4 to 5.6, f = 6.7 mm to 33.5 mm, 5:1 power zoom lens

LCD monitor

- 2.8" diagonally measured,
- LCD panel/TFT active matrix system

Flash

- Within 2 m (6.6 ft)
- (recommended shooting distance)

■ Connectors

AV output

- Video output: 1.0 V (p-p), 75 Ω
- Audio output: 300 mV (rms), 1 kΩ

HDMI

- HDMI™ (V.1.3 with x.v.Color™)

Component output

- Y, Pb, Pr component output
- Y: 1.0 V (p-p), 75 Ω
- Pb/Pr: 700 mV (p-p), 75 Ω

USB

- Mini USB type A and type B,
- USB 2.0 compliant

■ AC Adapter

Power requirement

- AC 110 V to 240 V ~, 50 Hz/60 Hz

Output

- DC 11 V $\overline{\text{---}}$, 1 A

■ Remote Control

Power supply

- DC 3 V

Battery life

- Approx. 1 year
- (depending on the frequency of use)

Operating distance

- Within 5 m (16.4 ft)

Operating temperature

- 0°C to 40°C (32°F to 104°F)

Dimensions (W x H x D)

- 42 mm x 14.5 mm x 91 mm
- (1-11/16" x 5/8" x 3-5/8")

Weight

- Approx. 30 g (0.07 lbs)
- (incl. battery)

■ Still image

Format

- JPEG

Image size

- | | |
|-----------|--|
| 4:3mode: | 3456 x 2592 / 3072 x 2304 / 2592 x 1944 / 1600 x 1200 / 640 x 480 |
| 16:9mode: | 3456 x 1944 / 3072 x 1728 / 2592 x 1456 / 1920 x 1080 / 1280 x 720 |

Image quality

- FINE / STANDARD

■ Video

Signal format

- 1080/60i

Recording/Playback format

- | | |
|--------|---------------------|
| Video: | MPEG-4 AVC/H.264 |
| Audio: | Dolby Digital (2ch) |

Resolution

- 1920x1080

Recording mode (video)

- | | |
|------|--------------|
| UXP: | VBR, 24 Mbps |
| XP: | VBR, 17 Mbps |
| SP: | VBR, 12 Mbps |
| EP: | VBR, 5 Mbps |

Recording mode (audio)

- 48 kHz, 256 kbps

Design and specifications subject to change without notice.

Specifications (Continued)

h: hour/m: minute

Approximate recordable time (for video)

Recording medium \ Quality	SD Card			
	4 GB	8 GB	16 GB	32 GB
UXP	20 m	40 m	1 h 20 m	2 h 40 m
XP	30 m	1 h 00 m	2 h 00 m	4 h 00 m
SP	44 m	1 h 28 m	2 h 56 m	5 h 52 m
EP	1 h 50 m	3 h 40 m	7 h 20 m	14 h 40 m

h: hour/m: minute

Required charging/recording time (approx.)

Battery pack	Charging time	Recording time
BN-VF908U (Provided) / BN-VF808U	1 h 50 m	1 h 15 m*

* When the monitor backlight is set to [STANDARD] mode.

* The actual recording time may be shorter if zooming is used or if recording is stopped repeatedly. (It is recommended to prepare battery packs ready for 3 times the expected recording time.)

* When the battery life is reached, the recording time becomes shorter even if the battery pack is fully charged. (Replace the battery pack with a new one.)

Approximate number of images (for still image)

Recording medium		SD Card						
		512 MB	1 GB	2 GB	4 GB	8 GB	16 GB	32 GB
16:9	3456 x 1944 / FINE	160	320	640	1270	2570	5180	9999
	3456 x 1944 / STANDARD	250	500	1030	2030	4090	8260	9999
	3072 x 1728 / FINE	200	400	820	1620	3260	6590	9999
	3072 x 1728 / STANDARD	320	640	1290	2550	5140	9999	9999
	2592 x 1456 / FINE	280	570	1150	2260	4560	9200	9999
	2592 x 1456 / STANDARD	440	890	1790	3530	7100	9999	9999
	1920 x 1080 / FINE	510	1030	2100	4140	8330	9999	9999
	1920 x 1080 / STANDARD	810	1620	3210	6310	9999	9999	9999
	1280 x 720 / FINE	1190	2400	4690	9230	9999	9999	9999
	1280 x 720 / STANDARD	1760	3530	6780	9999	9999	9999	9999
4:3	3456 x 2592 / FINE	120	240	480	960	1930	3900	7810
	3456 x 2592 / STANDARD	190	380	770	1510	3050	6170	9999
	3072 x 2304 / FINE	150	300	610	1210	2440	4920	9860
	3072 x 2304 / STANDARD	240	480	980	1930	3890	7860	9999
	2592 x 1944 / FINE	210	420	870	1710	3450	6960	9999
	2592 x 1944 / STANDARD	340	680	1380	2720	5490	9999	9999
	1600 x 1200 / FINE	550	1110	2260	4440	8950	9999	9999
	1600 x 1200 / STANDARD	880	1760	3590	7060	9999	9999	9999
	640 x 480 / FINE	3330	6670	9999	9999	9999	9999	9999
	640 x 480 / STANDARD	5990	9999	9999	9999	9999	9999	9999

The recordable time and the number of still images are approximate and may differ depending on the recording environment, the condition of the SD card, or the remaining battery power.

Cautions

AC Adapter

When using the AC adapter in areas other than the USA

The provided AC adapter features automatic voltage selection in the AC range from 110 V to 240 V.

USING HOUSEHOLD AC PLUG ADAPTER

In case of connecting the unit's power cord to an AC wall outlet other than American National Standard C73 series type use an AC plug adapter, called a "Siemens Plug", as shown.

For this AC plug adapter, consult your nearest JVC dealer.

Plug Adapter

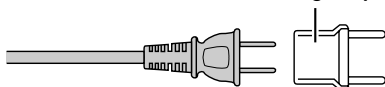

Battery Pack

The supplied battery pack is a lithium-ion battery. Before using the supplied battery pack or an optional battery pack, be sure to read the following cautions:

Terminals

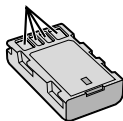

● To avoid hazards

... do not burn.

... do not short-circuit the terminals. Keep it away from metallic objects when not in use. When transporting, make sure the provided battery cap is attached to the battery. If the battery cap is misplaced, carry the battery in a plastic bag.

... do not modify or disassemble.

... do not expose the battery to temperatures exceeding 60°C (140°F), as this may cause the battery to overheat, explode or catch fire.

... use only specified chargers.

● To prevent damage and prolong service life

... do not subject to unnecessary shock.

... charge within the temperature range of 10°C to 35°C (50°F to 95°F). Cooler temperatures require longer charging time, or in some cases stop charging at all.

Warmer temperatures prevent complete charging, or in some cases stop charging at all.

... store in a cool, dry place. Extended exposure to high temperatures will increase natural discharge and shorten service life.

... fully charge and then fully discharge the battery every 6 months when storing the battery pack over a long period of time.

... remove from charger or powered unit when not in use, as some machines use current even when switched off.

ATTENTION:



The product you have purchased is powered by a rechargeable battery that is recyclable.

Please call 1-800-8-BATTERY for information on how to recycle this battery.

Recording Medium (SD Card)

- **Be sure to follow the guidelines below to prevent corruption or damage to your recorded data.**
 - Do not bend or drop the recording medium, or subject it to strong pressure, jolts or vibrations.
 - Do not splash the recording medium with water.
 - Do not use, replace, or store the recording medium in locations that are exposed to strong static electricity or electrical noise.
 - Do not turn off the camera power or remove the battery or AC adapter during shooting, playback, or when otherwise accessing the recording medium.
 - Do not bring the recording medium near objects that have a strong magnetic field or that emit strong electromagnetic waves.
 - Do not store the recording medium in locations with high temperature or high humidity.
 - Do not touch the metal parts.

LCD Monitor

- **To prevent damage to the LCD monitor, DO NOT**
 - ... push it strongly or apply any shocks.
 - ... place the camera with LCD monitor on the bottom.
- **To prolong service life**
 - ... avoid rubbing it with coarse cloth.

Main Unit

- **For safety, DO NOT**
 - ... open the camera's chassis.
 - ... disassemble or modify the unit.
 - ... allow inflammables, water or metallic objects to enter the unit.
 - ... remove the battery pack or disconnect the power supply while the power is on.
 - ... leave the battery pack attached when the camera is not in use.
 - ... place naked flame sources, such as lighted candles, on the apparatus.
 - ... expose the apparatus to dripping or splashing.
 - ... leave dust or metal objects adhered to the power plug or an AC wall outlet.

... insert any objects in the camera.

● **Avoid using the unit**

... in places subject to excessive humidity or dust.
... in places subject to soot or steam such as near a cooking stove.

... in places subject to excessive shock or vibration.

... near a television set.

... near appliances generating strong magnetic or electric fields (speakers, broadcasting antennas, etc.).

... in places subject to extremely high (over 40°C or 104°F) or extremely low (under 0°C or 32°F) temperatures.

... in places where air pressure is low (more than 3000 m (9843 ft) above the sea level).

● **DO NOT leave the unit**

... in places of over 50°C (122°F).

... in places where humidity is extremely low (below 35 %) or extremely high (above 80 %)

... in direct sunlight.

... in a closed car in summer.

... near a heater.

... in high places such as on a TV. Leaving the unit in high places while a cable is connected may result in a malfunction if the cable is caught and the unit falls onto the floor.

● **To protect the unit, DO NOT**

... allow it to become wet.

... drop the unit or strike it against hard objects.

... subject it to shock or excessive vibration during transportation.

... keep the lens directed at extremely bright objects for long periods.

... expose the lens to direct sunlight.

... swing it excessively when using the hand strap.

... swing the soft camera case excessively when the camera is inside it.

... place the camera in dusty or sandy areas, such as on a beach.

● **To prevent the unit from dropping,**

● Fasten the grip belt securely.

● When using the camera with a tripod, attach the camera to the tripod securely.

If the camera drops, you may be injured and the camera may be damaged.

When a child uses the unit, there must be parental guidance.

Declaration of Conformity

Model Number : GZ-X900U

Trade Name : JVC

Responsible party : JVC AMERICAS CORP.

Address : 1700 Valley Road Wayne, N. J. 07470

Telephone Number : 973-317-5000

This device complies with Part 15 of FCC Rules. Operation is subject to the following two conditions: (1) This device may not cause harmful interference, and (2) this device must accept any interference received, including interference that may cause undesired operation.

Changes or modifications not approved by JVC could void the user's authority to operate the equipment. This equipment has been tested and found to comply with the limits for a Class B digital device, pursuant to Part 15 of the FCC Rules. These limits are designed to provide reasonable protection against harmful interference in a residential installation. This equipment generates, uses, and can radiate radio frequency energy and, if not installed and used in accordance with the instructions, may cause harmful interference to radio communications. However, there is no guarantee that interference will not occur in a particular installation. If this equipment does cause harmful interference to radio or television reception, which can be determined by turning the equipment off and on, the user is encouraged to try to correct the interference by one or more of the following measures: Reorient or relocate the receiving antenna. Increase the separation between the equipment and receiver. Connect the equipment into an outlet on a circuit different from that to which the receiver is connected. Consult the dealer or an experienced radio/TV technician for help.

This Class B digital apparatus complies with Canadian ICES-003.

Cet appareil numérique de la classe B est conforme à la norme NMB-003 du Canada.

JVC Software License Agreement

JVC SOFTWARE LICENSE AGREEMENT IMPORTANT

TO CUSTOMERS: PLEASE MAKE SURE TO READ THIS CAREFULLY BEFORE INSTALLING OR USING THE SOFTWARE PROGRAM NAMED "DIGITAL PHOTO NAVIGATOR" ("Program") ON YOUR PC. The right to use the Program is granted by Victor Company of Japan, Limited ("JVC") to You only on the condition that You agree to the following.

Should You not agree to the terms hereof, You may not install or use the Program. HOWEVER, INSTALLING OR USING THE PROGRAM INDICATES YOUR ACCEPTANCE OF THESE TERMS AND CONDITIONS.

1 COPYRIGHT; OWNERSHIP

You acknowledge that all copyrights and other intellectual property rights in the Program are owned by JVC and its licensor, and remain vested in JVC and such licensor. The Program is protected under the copyright law of Japan and other countries, and related Conventions.

2 GRANT OF LICENSE

- (1) Subject to the conditions of this Agreement, JVC grants to You a non-exclusive right to use the Program. You may install and use the Program on a HDD or other storage devices incorporated in Your PC.
- (2) You may make one (1) copy of the Program solely for your personal backup or archival purposes.

3 RESTRICTION ON THE PROGRAM

- (1) You may not reverse engineer, decompile, disassemble, revise or modify the Program, except to the extent that expressly permitted by applicable law.
- (2) You may not copy or use the Program, in whole or in part, other than as expressly specified in this Agreement.
- (3) You have no right to grant a license to use the Program, and may not distribute, rent, lease or transfer the Program to any third party or otherwise let them use the Program.

4 LIMITED WARRANTY

JVC warrants that any media in which the Program is embodied are free from any defects in materials and workmanship for a period of thirty (30) days from the date of Your purchasing any our products accompanying the Program. JVC's entire liability and your exclusive remedy in connection with the Program shall be replacement of such defective media. EXCEPT FOR THE EXPRESS WARRANTIES STATED HEREIN AND TO THE EXTENT PERMITTED BY APPLICABLE LAW, JVC AND ITS LICENSORS DISCLAIM ANY OTHER WARRANTIES, EITHER EXPRESS OR IMPLIED, INCLUDING BUT NOT LIMITED TO IMPLIED WARRANTIES OF MERCHANTABILITY AND FITNESS FOR A PARTICULAR PURPOSE IN REGARD TO THE PROGRAM AND THE ACCOMPANYING PRINTED MATERIALS. SHOULD THERE BE ANY PROBLEM ARISING FROM OR CAUSED BY THE PROGRAM, YOU SHOULD SETTLE ALL SUCH PROBLEM AT YOUR OWN COST AND EXPENSE.

5 LIMITED LIABILITY

TO THE EXTENT PERMITTED BY APPLICABLE LAW, IN NO EVENT SHALL JVC AND ITS LICENSORS BE LIABLE FOR ANY INDIRECT, SPECIAL, INCIDENTAL OR CONSEQUENTIAL DAMAGES WHATSOEVER, REGARDLESS OF THE FORM OF ACTION WHETHER IN CONTRACT, TORT OR OTHERWISE ARISING OUT OF OR IN CONNECTION WITH THE USE OF OR INABILITY TO USE THE PROGRAM, EVEN IF JVC HAS BEEN ADVISED OF THE POSSIBILITY OF SUCH DAMAGES. YOU WILL INDEMNIFY AND HOLD HARMLESS JVC FROM ANY LOSS, LIABILITY OR COST ARISING OUT OF OR IN ANY WAY CONNECTED TO CLAIMS FROM ANY THIRD PARTY RELATING TO THE USE OF THE PROGRAM.

6 TERM

This Agreement will become effective on the date when You install and use the Program on Your machine, and continue to be in effect until the termination under the following provision. Should You breach any provision of this Agreement, JVC may terminate this Agreement without giving any notice to You. In this event, JVC may claim against You for any damages caused by Your breach. Should this Agreement be terminated, You must immediately destroy the Program stored in Your machine (including the erasing from any memory in Your PC), and no longer own such Program.

7 EXPORT CONTROL

You agree that You will not ship, transfer or export the Program or underlying information and technology to any countries to which Japan and other relevant countries have initiated an embargo on such goods.

8 U.S. GOVERNMENT USER

If You are an agency of the United States of America (the "Government"), You acknowledge JVC's representation that the Program is a "Commercial Item" as defined in Federal Acquisition Regulation (FAR) part 2.101 (g) consisting unpublished "Commercial Computer Software" as those items are used at FAR part 12.212 and is only licensed to You with the same use rights JVC grants all commercial end users pursuant to the terms of this Agreement.

9 GENERAL

- (1) No modification, change, addition, deletion or other alternation of or to this Agreement will be valid unless reduced to writing and signed by an authorized representative of JVC.
- (2) If any part of this Agreement is held invalid by or in conflict with any law having jurisdiction over this Agreement, the remaining provisions will remain in full force and effect.
- (3) This Agreement shall be governed by and interpreted under the laws of Japan. The Tokyo District Court has jurisdiction over all disputes which may arise with respect to the execution, interpretation and performance of this Agreement.

Victor Company of Japan, Limited

NOTE

If You acquired the Program in Germany, the provisions of Sections 4 (Limited Warranty) and 5 (Limited Liability) provided above will be replaced with those of the German version of this Agreement.

CAUTION:

- Operate this equipment according to the operating procedures described in this manual.
- Use only the provided CD-ROM. Never use any other CD-ROM to run this software.
- Do not attempt to modify this software.
- Changes or modifications not approved by JVC could void user's authority to operate the equipment.

How to handle a CD-ROM

- Take care not to soil or scratch the mirror surface (opposite to the printed surface). Do not write anything or put a sticker on either the front or back surface. If the CD-ROM gets dirty, gently wipe it with a soft cloth outward from the center hole.
- Do not use conventional disc cleaners or cleaning spray.
- Do not bend the CD-ROM or touch its mirror surface.
- Do not store your CD-ROM in a dusty, hot or humid environment. Keep it away from direct sunlight.

You can find the latest information (in English) on the provided software program at our world wide web server at <http://www.jvc-victor.co.jp/english/global-e.html>

Terms

A	AC Adapter	18, 84	L	Language Setting	19
	Adjust Brightness	34		LCD Monitor	16, 84
	Aperture Priority	34	M	Macro	35
	Auto Finalize	72		Manual Recording	33
	Auto Power Off	72		Menu Settings	69
	AV Cable	38, 39, 59		Monitor Backlight	71
B	Backlight Compensation	35		Monitor Bright	71
	Battery Pack	18, 84		MTS Files	32
	BD/DVD Backup	54	N	Number of Images	83
	BD/DVD Burner	54	O	OIS	70
	Bracketing	26		On-screen Recording Control	22
C	CD-ROM	9, 60		On-screen Zoom Control	24
	Clock Adjust	18		Opening Image	30
	Component Cable	38		Operation Sound	72
	Component Output	73	P	Photometry Area	35
	Continuous Shooting Speed	71		PictBridge	52
	Copying Files	53		Playback Zoom	28, 29
	Core Filter	9, 13		Playlists	49
D	Date/Time Setting	5, 18		Portable Media Player	65
	Date Display Style	71		Protecting Files	43
	Deleting Files	41	Q	Quick Restart	72
	Demo Mode	72		Quick Review	22, 23
	Digest Playback	28, 56	R	Recordable Time	82
	Direct Printing	52		Record Button	72
	Display on TV	73		Recording Medium	84
	Dividing Files	46		Register Event	25
	DPOF	51		Remaining Battery Power	24
	Dubbing Playback	59		Remaining Recording Time	24
E	Effect	35		Remote Control	13, 15, 72
	Event Registration	45	S	Scene Select	37
	Everio Dock	9, 20		SD Card	21
	Export to Library Mode	65		Self-Timer	69
F	Face Detection	27, 48, 69		Shutter Mode	25, 26
	Factory Preset	73		Shutter Speed	34
	File Information	44		Shutter Speed	34
	File Search	31, 32		Speaker Volume	28
	Date Index Screen		T	Trimming Files	47
	Event Screen			Tripod Mounting	20
	Group Index Screen		U	Updating Software	73
	Flash	24		Uploading Files	68
	Focus	34		USB Cable	54, 57, 61
	Focus Assist	34		USB External Hard Disk Drive	57
	Focus Assist Camera	71	V	Video Output	73
	Format SD Card	72		Video Quality	69
G	Gain	70		Viewing Files on TV	38
	Gain Up	70	W	White Balance (WB)	35
	Grid	70		Wind Cut	70
	Grip Adjustment	20		Wipe or Fader Effects	30
H	HDMI	38, 40, 73	X	x.v.Color	70
	High Speed Videos	36	Y	You Tube	67
	Histogram	44	Z	Zoom	24, 70
I	Image Quality	70			
	Image Rotation	29			
	Image Size	70			
	iTunes	65			

JVC

Free Manuals Download Website

<http://myh66.com>

<http://usermanuals.us>

<http://www.somanuals.com>

<http://www.4manuals.cc>

<http://www.manual-lib.com>

<http://www.404manual.com>

<http://www.luxmanual.com>

<http://aubethermostatmanual.com>

Golf course search by state

<http://golfingnear.com>

Email search by domain

<http://emailbydomain.com>

Auto manuals search

<http://auto.somanuals.com>

TV manuals search

<http://tv.somanuals.com>