

# KENWOOD

AUDIO RECEIVER

## KRF-A4020

---

## INSTRUCTION MANUAL

KENWOOD CORPORATION

***About the supplied remote control (RC-R0708) . . .***

Compared to standard remote controls, the remote control supplied with this receiver has several operation modes. These modes enable the remote control to control other audio components. In order to effectively use the remote control it is important to read the operating instructions and obtain a proper understanding of the remote control and how to switch its operation modes (etc.).

Using the remote control without completely understanding its design and how to switch the operation modes may result in incorrect operations.

# Getting started

 **Caution : Read this page carefully to ensure safe operation.**

KRF-A4020 (En/E2T)

2

## Before applying the power





Units are designed for operation as follows.

Europe and U.K. .... AC 230 V only  
Russia ..... AC 220 V only

## Safety precautions

### WARNING :

TO PREVENT FIRE OR ELECTRIC SHOCK, DO NOT EXPOSE THIS APPLIANCE TO RAIN OR MOISTURE.

	<b>CAUTION</b> RISK OF ELECTRIC SHOCK DO NOT OPEN	
CAUTION: TO REDUCE THE RISK OF ELECTRIC SHOCK, DO NOT REMOVE COVER (OR BACK). NO USER-SERVICEABLE PARTS INSIDE, REFER SERVICING TO QUALIFIED SERVICE PERSONNEL.		
	THE LIGHTNING FLASH WITH ARROWHEAD SYMBOL, WITHIN AN EQUILATERAL TRIANGLE, IS INTENDED TO ALERT THE USER TO THE PRESENCE OF UNINSULATED "DANGEROUS VOLTAGE" WITHIN THE PRODUCT'S ENCLOSURE THAT MAY BE OF SUFFICIENT MAGNITUDE TO CONSTITUTE A RISK OF ELECTRIC SHOCK TO PERSONS.	
	THE EXCLAMATION POINT WITHIN AN EQUILATERAL TRIANGLE IS INTENDED TO ALERT THE USER TO THE PRESENCE OF IMPORTANT OPERATING AND MAINTENANCE (SERVICING) INSTRUCTIONS IN THE LITERATURE ACCOMPANYING THE APPLIANCE.	

## For the United Kingdom

### Factory fitted moulded mains plug

1. The mains plug contains a fuse. For replacement, use only a 13-Amp ASTA-approved (BS1362) fuse.
2. The fuse cover must be refitted when replacing the fuse in the moulded plug.
3. Do not cut off the mains plug from this equipment. If the plug fitted is not suitable for the power points in your home or the cable is too short to reach a power point, then obtain an appropriate safety approved extension lead or adapter, or consult your dealer.  
If nonetheless the mains plug is cut off, remove the fuse and dispose of the plug immediately, to avoid a possible shock hazard by inadvertent connection to the mains supply.

IMPORTANT: The wires in the mains lead are coloured in accordance with the following code:

Blue : Neutral  
Brown : Live

Do not connect those leads to the earth terminal of a three-pin plug.

### Maintenance of the set

When the front panel or case becomes dirty, wipe with a soft, dry cloth. Do not use thinner, benzine, alcohol, etc. for these agents may cause discoloration.

### In regard to contact cleaner

Do not use contact cleaners because it could cause a malfunction. Be specially careful not to use contact cleaners containing oil, for they may deform the plastic component.

## Unpacking

Unpack the unit carefully and make sure that all accessories are put aside so they will not be lost. Examine the unit for any possibility of shipping damage. If your unit is damaged or fails to operate, notify your dealer immediately. If your unit was shipped to you directly, notify the shipping company without delay. Only the consignee (the person or company receiving the unit) can file a claim against the carrier for shipping damage. We recommend that you retain the original carton and packing materials for use should you transport or ship the unit in the future.

Keep this manual handy for future reference.

### Accessories

FM indoor antenna (1)

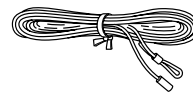

AM loop antenna (1)

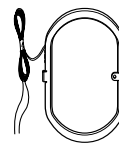

Loop antenna stand (1)

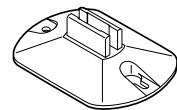

Remote control unit (1)

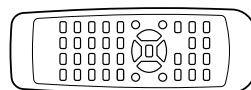

Batteries (R06/AA) (2)

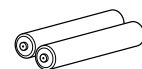

## How to use this manual

This manual is divided into three sections, Preparations, Operations, and Other.

### Preparations

Shows you how to connect your audio components to the receiver.

We've tried to make setting up your system as easy as possible. However, since this receiver works with all of your audio components, connecting the system can be fairly complex.

### Operations

Shows you how to operate the various functions available from the receiver.

### Other

Shows you additional information such as "In case of difficulty" (troubleshooting) and "Specifications."

## Special features

### MONITOR

The **TAPE2/MONITOR** jacks of this unit accept the connection of a cassette deck, graphic equalizer, surround processor, etc. When a 3-head cassette deck is connected to the **TAPE2/MONITOR** jacks, it is possible to monitor the sound which has just been recorded during recording. → 

### Station preset

This unit incorporates a function for storing received stations in preset memory with a simple operation. It is very convenient to preset the stations you like. The preset stations can be recalled also very easily. → 

### RDS (Radio Data System) tuner

The receiver is equipped with a RDS tuner that provides several convenient tuning functions: RDS Auto Memory to automatically preset up to 30 stations including RDS broadcasting different programs and ordinary FM stations; station name display to show you the name of the current broadcast station; and PTY Search to let you tune stations by program type. → 

### PTY (Program TYPe) search

Lets you tune stations by specifying the type of program you want to hear.

### EON (Enhanced Other Networks) reservation

The EON function lets you monitor information on other stations so you can receive traffic or news programs as soon as they are broadcast, even they are broadcast on a station different from the one you are currently listening to. When the broadcast ends, the receiver returns to the original station. When listening to **KENWOOD** source components connected with system control cords, the input selector on the receiver automatically switches to the tuner when a program you desire is broadcast.

### Remote controllable audio function

By connecting **KENWOOD** source components such as a cassette deck and CD player through system control connection, the basic operations of these components can be controlled from the remote control unit provided with this unit. A single remote control unit can control the entire audio system easily.



### New "TRAIT" transistor

The new developed "TRAIT" transistor with extremely superior temperature characteristics is used in this amplifier's amplification circuit. Through the use of this transistor, distortion generated because of temperature change is kept to a minimum resulting in "pure" sound reproduction.

## Contents

**Caution** : Read the pages marked  carefully to ensure safe operation.

### Preparations

<b>Getting started</b> .....	<b>2</b>
 Before applying the power .....	2
 Safety precautions .....	2
Unpacking .....	2
How to use this manual .....	2
Special features .....	3
<b>Setting up the system</b> .....	<b>4</b>
Connecting audio components .....	4
Connecting the antennas .....	5
Connecting the speakers .....	5
Connecting the system control .....	6
<b>Names and functions of parts</b> .....	<b>7</b>
Main unit .....	7
Remote control unit .....	8
Preparing the remote control .....	9

### Operations

<b>Normal playback</b> .....	<b>10</b>
Preparing for playback .....	10
Listening to a source component .....	10
Adjusting the sound .....	11
<b>Recording</b> .....	<b>12</b>
Recording audio .....	12
<b>Listening to radio broadcasts</b> .....	<b>13</b>
Tuning (non-RDS) radio stations .....	13
Using RDS (Radio Data System) .....	13
Using the DISPLAY key .....	14
Presetting RDS stations (RDS AUTO MEMORY) .....	14
Presetting radio stations manually .....	15
Receiving preset stations .....	15
Receiving preset stations in order (P.CALL) .....	15
Tuning by program type (PTY search) .....	16
Reserving the desired information .....	16

### Other

<b>In case of difficulty</b> .....	<b>18</b>
 <b>Specifications</b> .....	<b>20</b>

# Setting up the system

**Caution :** Read this page carefully to ensure safe operation.

KRF-A4020 (En/E2T)

4

Make connections as shown below. When connecting the related system components, be sure to also refer to the instruction manuals supplied with the components you are connecting. Do not connect the power cord to a wall outlet until all connections are completed.

## Microcomputer malfunction

If operation is not possible or an erroneous display appears, even though all connections have been made properly, reset the microcomputer referring to "In case of difficulty".

→ 18

## CAUTION

Be sure to adhere followings. Or proper ventilation will be blocked causing damage or fire hazard.

- Do not place any objects impairing heat radiation onto the top of unit.
- Leave a space around the unit (from the largest outside dimension including projection) equal or greater than, shown below.

Top panel : 50 cm  
Side panel : 10 cm  
Back panel : 10 cm

Preparations

## Connecting audio components

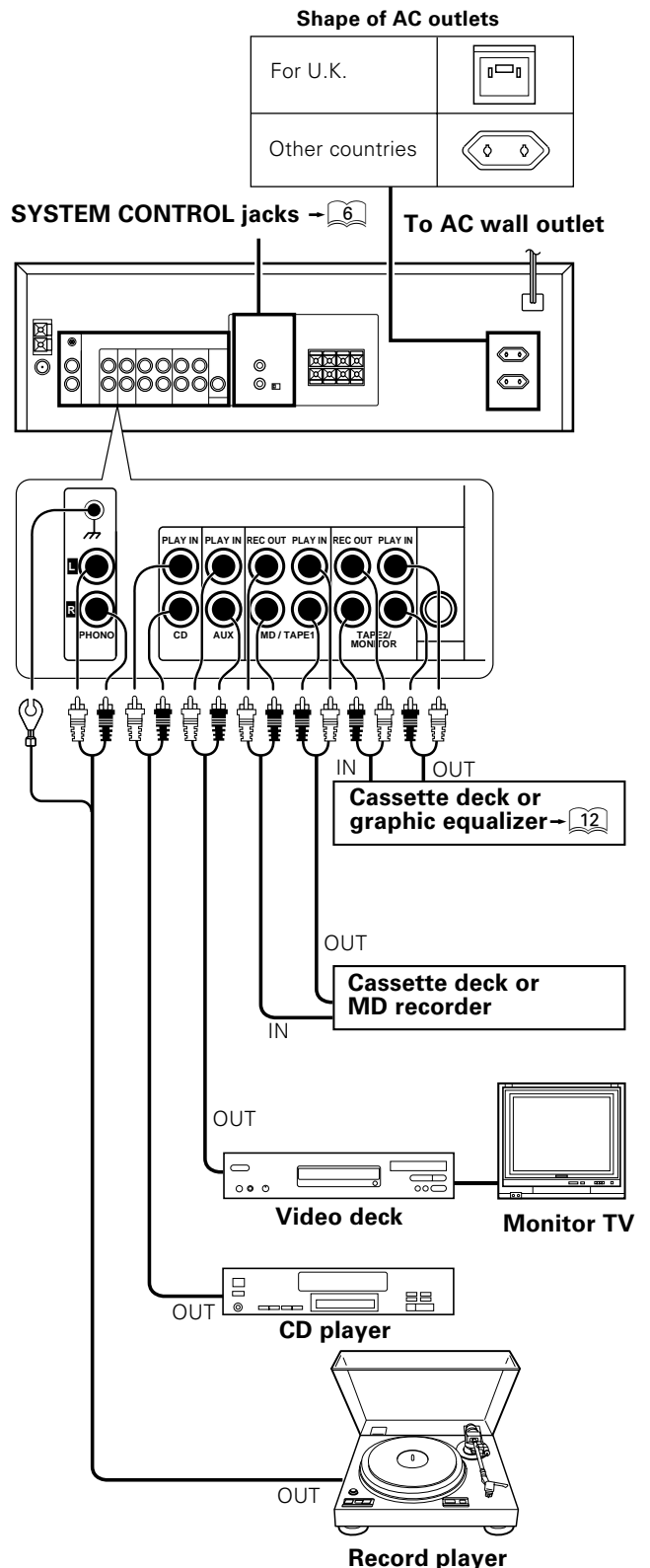

### Notes:

1. Be sure to insert all connection cords securely. If their connections are imperfect, the sound may not be produced or noise may interfere.
2. Be sure to remove the power cord from the AC outlet before plugging or unplugging any connection cords. Plugging / unplugging connection cords without disconnecting the power cord can cause malfunctions and may damage the unit.
3. Do not connect power cords from components whose power consumption is larger than what is indicated on the AC outlet at the rear of this unit.

## Connecting the antennas

### Antenna terminal connections

- 1 Push lever.
- 2 Insert cord.
- 3 Return lever.

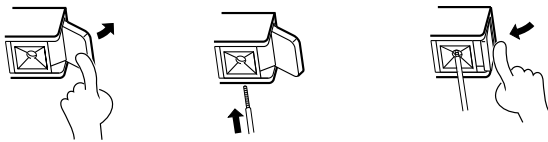

### AM loop antenna

The supplied loop antenna is for use indoors. Place it as far as possible from the receiver, TV set, speaker cords and power cord, and adjust the direction for best reception.

### FM indoor antenna

The supplied indoor antenna is for temporary use only. For stable signal reception we recommend using an outdoor antenna. Disconnect the indoor antenna when you connect one outdoors.

### FM outdoor antenna

Lead the 75Ω coaxial cable connected to the FM outdoor antenna into the room and connect it to the FM 75Ω terminal.

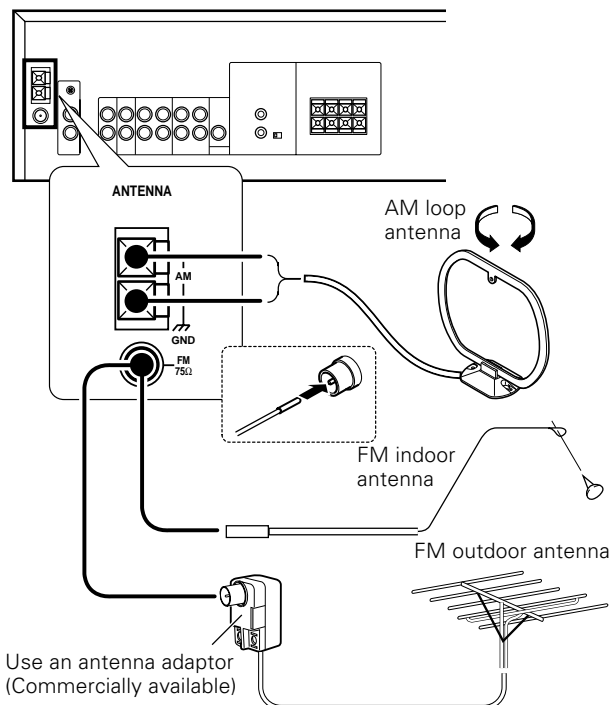

## Connecting the speakers

- 1 Strip coating.



- 2 Push lever.

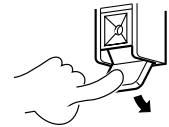

- 3 Insert cord.

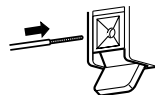

- 4 Return lever.

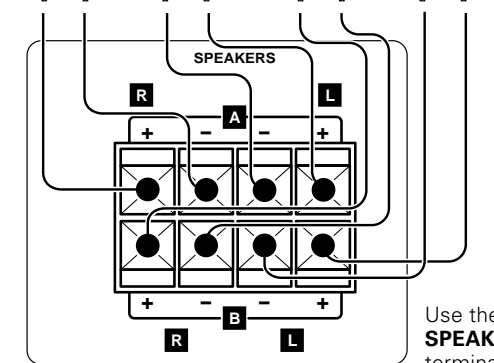
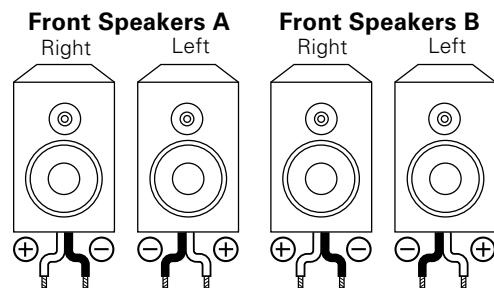
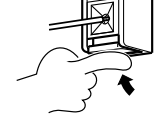

Use the **FRONT SPEAKERS B** terminals if you want to connect a second front speaker system.

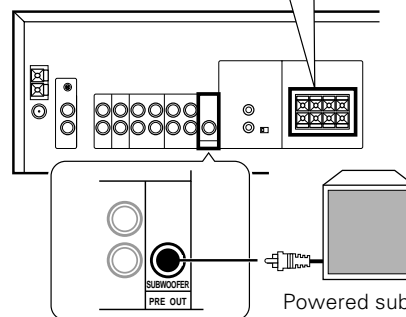

To produce sound from the powered subwoofer, turn the **SPEAKERS A** key on. No sound will be produced if only the **SPEAKERS B** key is on.

- Never short circuit the + and – speaker cords.
- If the left and right speakers are connected inversely or the speaker cords are connected with reversed polarity, the sound will be unnatural with ambiguous acoustic imaging. Be sure to connect the speakers correctly.

### Speaker impedance

After confirming the speaker impedance indications printed on the rear panel of the receiver, connect speakers with matching impedance ratings. Using speakers with a rated impedance other than that indicated on the rear panel of the receiver could result in malfunctions or damage to the speakers or receiver.

## Connecting the system control

Connecting system control cords after connecting a KENWOOD audio component system lets you take advantage of convenient system control operations. There are two KENWOOD system control modes. Make connections according to the groups of terminal symbols shown below.

- [XS8]** Mode : lets you combine **[XS]**, **[XS8]**, and **[XR]** terminals
- [SL16]** Mode : for **[SL16]** terminals only

This unit is compatible with both **[XS8]** and **[SL16]** modes. It comes from the factory set to the **[SL16]** mode. To switch to the **[XS8]** mode, follow the instructions in "Switching from **[SL16]** to **[XS8]**" below.

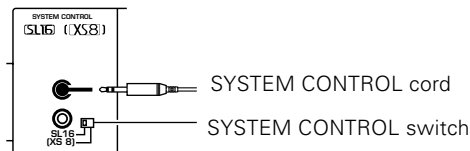

### Example: **[XS8]** mode connections

The underlined portion represents the setting of the system control mode.

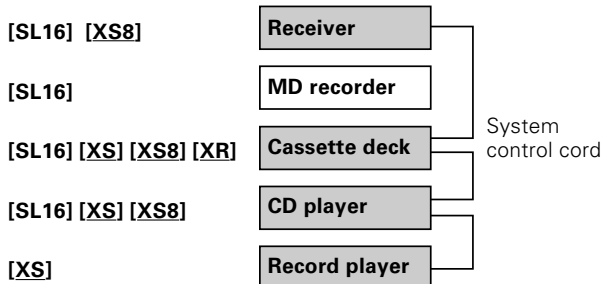

### Example: **[SL16]** mode connections

The underlined portion represents the setting of the system control mode.

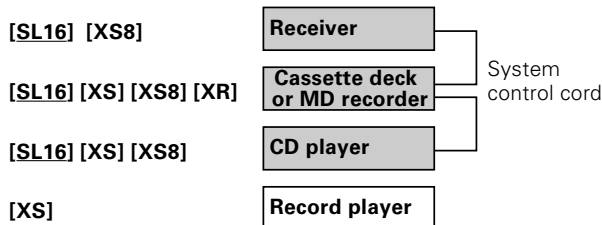

- In order to take advantage of the system control operations, the components must be connected to the correct jacks. To use a CD player it must be connected to the CD jacks. To use a cassette deck (or MD recorder) it must be connected to the **MD/TAPE1** jacks. When using more than one CD player (etc.) only the one connected to the specified jacks may be connected for system control.
- Some CD players and cassette decks are not compatible with the **[SL16]** system control mode. Be sure to use the **[XS8]** system control mode when making system connections with equipment that is not **[SL16]** compatible.

- Some MD players are not system control compatible. You cannot make system control connections to this kind of equipment.

Notes:

1. **[SL16]** equipment cannot be combined with **[XR]**, **[XS]**, and **[XS8]** equipment for system operations. If your equipment consists of this kind of combination, please do not connect any system control cords. Even without system control cords, normal operations can be carried out without effecting performance.
2. Do not connect system control cords to any components other than those specified by **KENWOOD**. It may cause a malfunction and damage your equipment.
3. Be sure the system control plugs are inserted all the way in to the system control terminals.

**Do not connect a system control cord to a cassette deck connected to the TAPE2/MONITOR jacks.**

## SYSTEM CONTROL operations

### Remote Control

Lets you operate this unit with the system remote supplied with the receiver.

### Automatic Operation (except **[XR]** equipment)

When you start playback from a source component, the input selector on this unit switches to that component automatically.

### Synchronized Recording (except **[XR]** equipment)

Lets you synchronize recording with the start of playback when recording from CD, MD or analog discs.

## Switching from **[SL16]** to **[XS8]**

You can easily change the system control mode by adjusting the position of the **SYSTEM CONTROL** switch on the rear panel.

Do this operation after completing all connections.

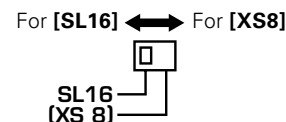

- This operation will not effect items stored in the memory.
- After switching the system control mode, turn the power off and unplug the power cord from the wall outlet, then plug it back.

# Names and functions of parts

KRF-A4020 (En/E2T)

## Main unit

7

Preparations

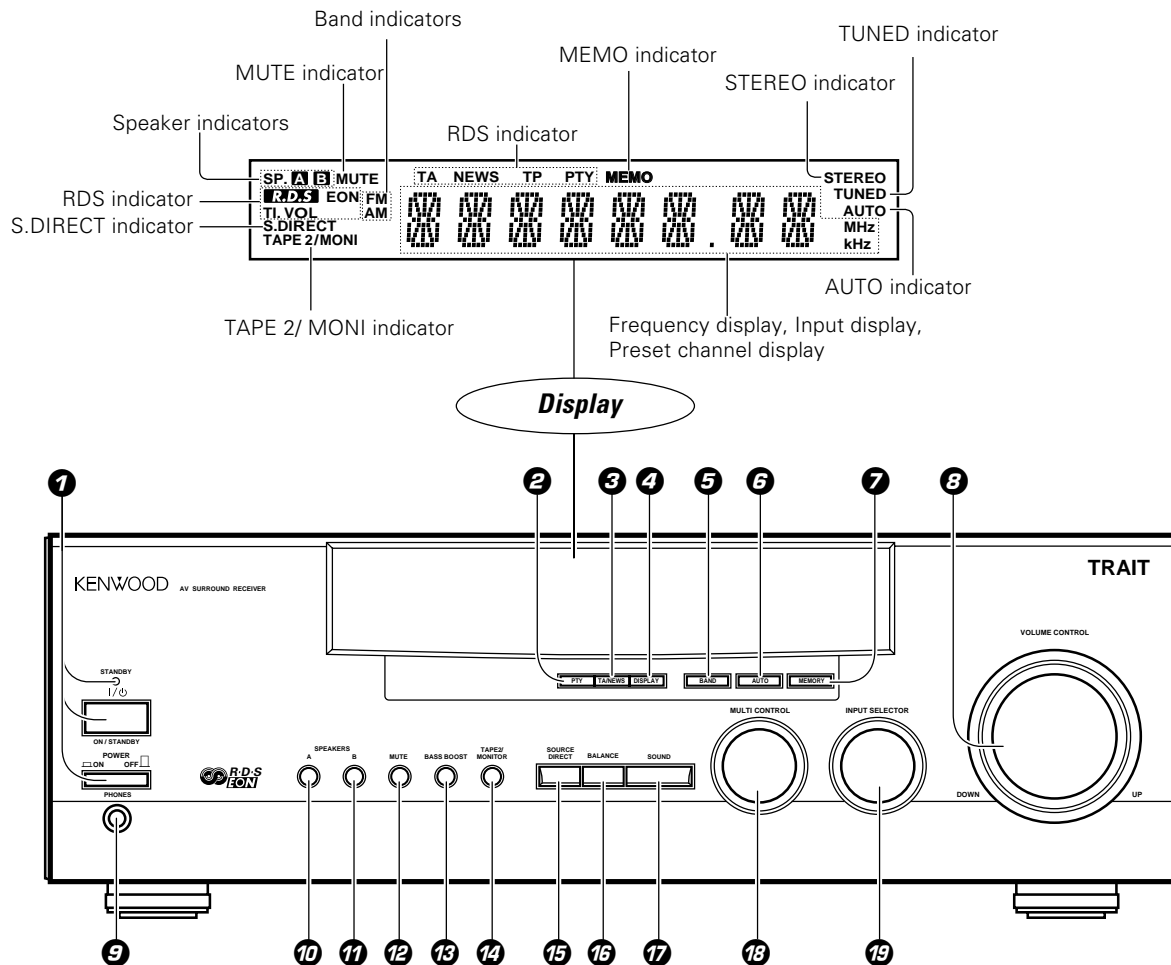

- |  |      |   |           |
|--|------|---|-----------|
| <b>1 ON/STANDBY ( I/O ) key</b>                                      | → 10 | <b>10 SPEAKERS A key</b>  | → 10      |
| Use to switch the power ON/STANDBY when the POWER is turned ON.      |      | Use to turn speaker system A on and off.                                  |           |
| <b>STANDBY indicator</b>   |      | <b>11 SPEAKERS B key</b>  | → 10      |
| <b>POWER key</b>   | → 10 | Use to turn speaker system B on and off.                                  |           |
| <b>2 PTY key</b>   | → 16 | <b>12 MUTE key</b>  | → 11      |
| Use to perform PTY search.   |      | Use to temporarily mute the sound.  |           |
| <b>3 TA/NEWS key</b>   | → 17 | <b>13 BASS BOOST key</b>  | → 11      |
| <b>4 DISPLAY key</b>   | → 14 | Use to select the maximum adjustment setting for the low frequency range. |           |
| Use to change the display indications when receiving RDS broadcasts. |      | <b>14 TAPE2/MONITOR key</b>   | → 10 → 12 |
| Use to adjust the brightness of the display.                         |      | <b>15 SOURCE DIRECT key</b>   | → 11      |
| <b>5 BAND key</b>  | → 13 | <b>16 BALANCE key</b>   | → 11      |
| Use to select the broadcast band.                                    |      | Use to adjust the sound balance.  |           |
| <b>6 AUTO key</b>  | → 13 | <b>17 SOUND key</b>   | → 11      |
| Use to select the auto tuning mode.                                  |      | Use to adjust the sound quality.  |           |
| <b>7 MEMORY key</b>  | → 15 | <b>18 MULTI CONTROL knob</b>  |           |
| Use to store radio stations in the preset memory.                    |      | Used to make a variety of settings.                                       |           |
| <b>8 VOLUME CONTROL knob</b>   | → 10 | <b>19 INPUT SELECTOR knob</b>   | → 10      |
| <b>9 PHONES jack</b>   | → 11 | Use to select the input sources.  |           |
| Use for headphone listening.   |      |   |           |

## Standby mode

While the standby indicator of the unit is lit, a small amount of current is flowing into the unit's internal circuitry to back up the memory. This condition is referred to as the standby mode of the unit. While the unit is in the standby mode, it can be turned ON from the remote control unit.

## Remote control unit

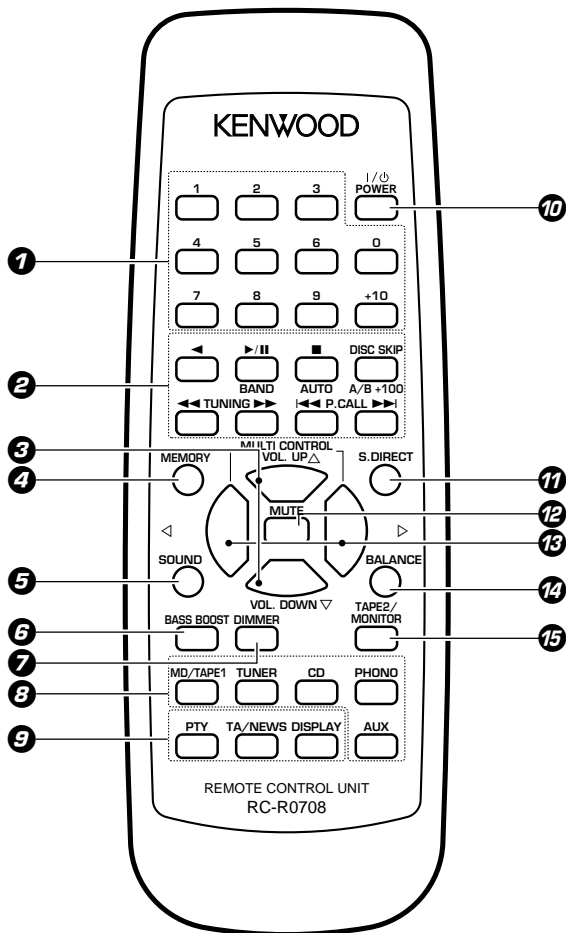

Model: RC-R0708  
Infrared ray system

### 1 Numeric keys (1~0, +10)

If CD or MD is selected as the input source, these keys function as numeric keys. If tuner is selected as the input source, these keys are used to call up station presets.

### 2 Component operation keys

Use these keys to operate other components with system control connections to the receiver.

#### TUNING (◀◀ ▶▶) keys

→ 13

If tuner is selected as the input source, these keys function as tuning keys.

If CD or MD is selected as the input source, these keys function as search keys.

#### P.CALL (◀◀ ▶▶) keys

→ 15

If tuner is selected as the input source, these keys function as P.CALL keys.

If CD or MD is selected as the input source, these keys function as skip keys.

#### ◀ key

If tape is selected as the input source, this key functions as the play key for side B of the cassette (the side facing away from the front of the deck).

#### BAND (▶/||) key

→ 13

If tuner is selected as the input source, this key functions as the band selector key.

If CD is selected as the input source, this key functions as the play/pause key.

If MD is selected as the input source, this key functions as the play key.

#### DISC SKIP, A/B, +100 key

If CD is selected as the input source, this key functions as the multi-CD player disc skip key.

If TAPE is selected as the input source, this key is used to switch between the two decks (A and B) of a double cassette deck.

If MD is selected as the input source, this key function as numeric key.

#### AUTO(■) key

→ 13

If tuner is selected as the input source, this key functions as the AUTO key.

If CD or MD is selected as the input source, this key functions as the stop key.

### 3 VOLUME UP, DOWN keys

→ 10

### 4 MEMORY key

→ 15

Use to store radio stations in the preset memory.

### 5 SOUND key

→ 11

Use to adjust the sound quality.

### 6 BASS BOOST key

→ 11

Use to select the maximum adjustment setting for the low frequency range.

### 7 DIMMER key

→ 14

Use to adjust the brightness of the display.

### 8 Input selector keys

→ 10

Use to select the receiver's input source.

### 9 RDS operation keys

→ 13

Use to receive RDS broadcasts.

### 10 POWER (I/O) key

→ 10

Use to switch the power ON/STANDBY when the POWER is turned ON.

### 11 S.DIRECT key

→ 11

### 12 MUTE key

→ 11

Use to temporarily mute the sound.

### 13 MULTI CONTROL keys

Used to make a variety of settings.

### 14 BALANCE key

→ 11

Use to adjust the sound balance.

### 15 TAPE2/ MONITOR key

→ 10 → 12



## Preparing the remote control

### Loading the batteries

- ① Remove the cover.      ② Insert the batteries.

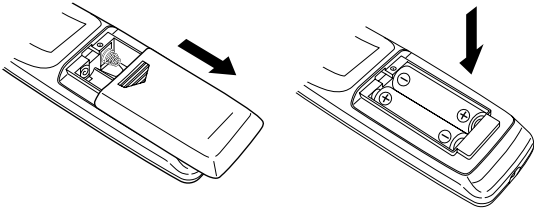

- ③ Close the cover.

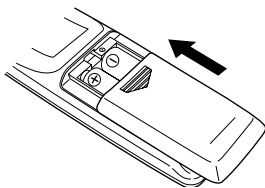

- Insert two AA-size (R06) batteries as indicated by the polarity markings.

### Operation

When the **"STANDBY"** indicator is lit, the power turns ON when you press the **POWER** (I/O) key on the remote control. When the power comes ON, press the key you want to operate.

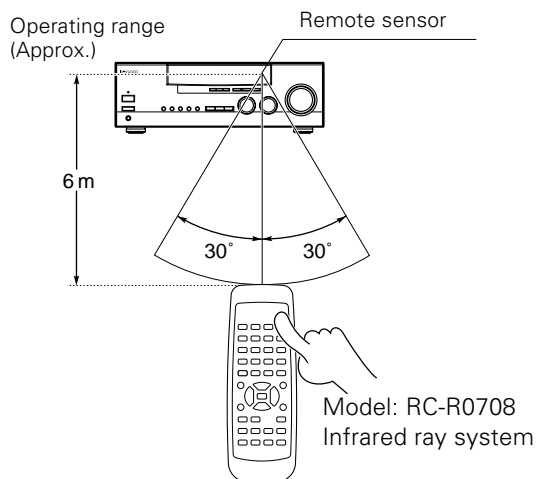

- When pressing more than one remote control key successively, press the keys securely by leaving an interval of 1 second or more between keys.

#### Notes:

1. The supplied batteries may have shorter lives than ordinary batteries due to use during operation checks.
2. When the remote-controllable distance gets shorter than before, replace both batteries with new ones.
3. Placing the remote sensor in direct sunlight, or in direct light from a high frequency fluorescent lamp may cause a malfunction.  
In such a case, change the location of the system installation to prevent malfunction.

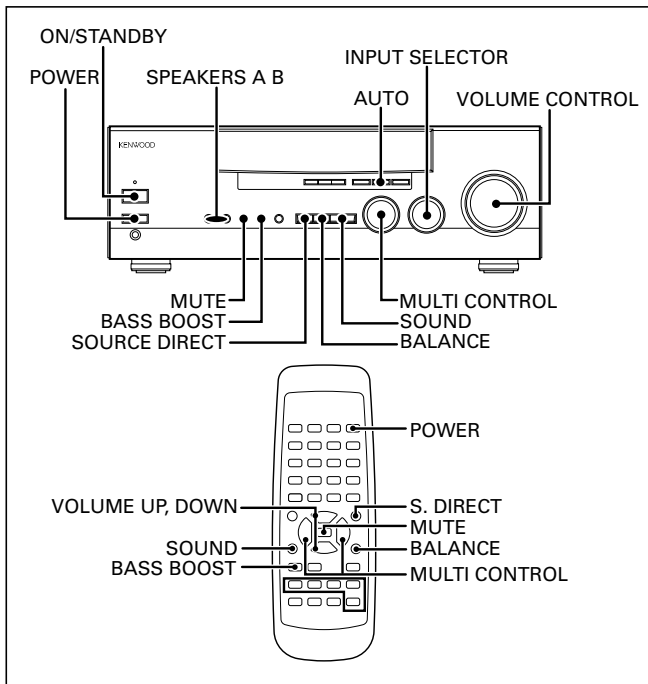

## Selecting the speaker system

Press the **SPEAKERS A** or **B** key to select the speaker system to be used.

- A ON** : Sound from the speakers connected to the **SPEAKERS A** terminals on the rear panel.
- B ON** : Sound from the speakers connected to the **SPEAKERS B** terminals on the rear panel.
- A+B ON** : Sound from both the speakers connected to the **SPEAKERS A** and **B** terminals on the rear panel.
- A+B OFF** : No sound from the speakers. Use this setting when listening with headphones.

The indicator for the speakers you want to use should be lit.

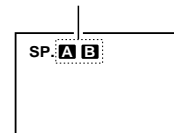

## Listening to a source component

- 1** Use the input selector (**INPUT SELECTOR**) to select the source you want to listen to.

The input sources change as shown below:

Selecting a source using the **INPUT SELECTOR** knob

- ➔ **1** TUNER (frequency display)
- ➔ **2** "CD"
- ➔ **3** "TAPE 1" or "MD"
- ➔ **4** "PHONO"
- ➔ **5** "AUX"

- When selecting an input source by using the remote control, press the desired input selector key.
- The **INPUT SELECTOR** on the front panel of the receiver always cycles through all inputs.

- 2** Start playback from the selected source.

- 3** Use the **VOLUME CONTROL (VOLUME UP, DOWN)** to adjust the volume.

- The sound of input source cannot be listened to with **TAPE2/MONITOR** is ON.

## Preparing for playback

Some preparatory steps are needed before starting playback.

### Turning on the receiver

- 1** Turn on the **POWER** key to **ON**.
- 2** Turn on the power to this receiver by pressing **ON/STANDBY** (1/⏻) key.

### Selecting MD/TAPE 1 (Main unit only)

Select the source name corresponding to the component connected to the **MD/TAPE1** jacks. The initial factory setting is "TAPE 1". To change the source name associated with the **MD/TAPE1** jacks to "MD", follow the steps below:

- 1** Use the **INPUT SELECTOR** knob to select "TAPE 1".
- 2** Hold down the **AUTO** key for more than 2 seconds.
  - The source indication changes to "MD".
  - To return to the original indication, repeat the above procedure.

## Adjusting the sound

### Adjusting the tone

Use the following procedure to adjust the bass and treble levels.

- 1 Press the **SOUND** key to select the tone mode to be adjusted.

**BASS** : Select this to adjust the low frequency range.  
(Press the **SOUND** key once.)

**TREBLE**: Select this to adjust the high frequency range.  
(Press the **SOUND** key twice.)

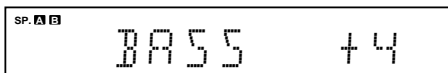

- 2 Use the **MULTI CONTROL** to adjust the sound quality.

- The bass and treble levels are adjustable from -10 to +10 in 2 step increments.
- The adjustment item is displayed for approximately 8 seconds.

### Once-touch low frequency emphasis (BASS BOOST)

Use the following procedure to emphasize the bass and create a richer sound.

Press the **BASS BOOST** key.

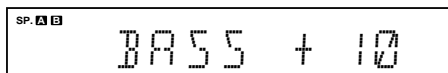

- Press the **BASS BOOST** key once to select the maximum (+10) low frequency emphasis setting.

### Switching back to the previous setting

Press the **BASS BOOST** key again.

### Muting the sound

MUTE lets you mute the sound of the speakers.

Press the **MUTE** key.

Blinks

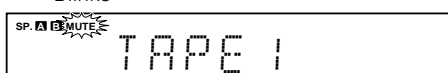

- Muting can also be cancelled by adjusting the volume.

### To cancel

Press the **MUTE** key again so that the "MUTE" indicator goes off.

### SOURCE DIRECT playback

Use this function to pass the source material direct to the amplifier, by passing any audio processing.

Press the **SOURCE DIRECT (S.DIRECT)** key.



- Switch to another input source to cancel **SOURCE DIRECT (S.DIRECT)** playback.

### To cancel

Press the **SOURCE DIRECT (S.DIRECT)** key again.

### Listening with headphones

- 1 Press the **SPEAKERS A** or **B** key so that the speaker indicator goes off.

Make sure the **SPEAKERS** indicators are turned off.

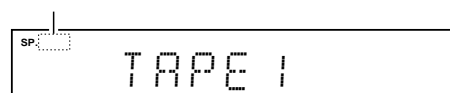

- 2 Connect headphones to the **PHONES** jack.

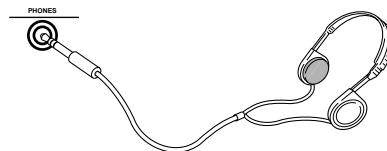

- 3 Use the **VOLUME CONTROL (VOLUME UP, DOWN)** to adjust the volume.

### To adjust the BALANCE

The mode for adjusting the volume balance between the left and right.

- 1 Press the **BALANCE** key.
- 2 Use the **MULTI CONTROL** to adjust the balance.

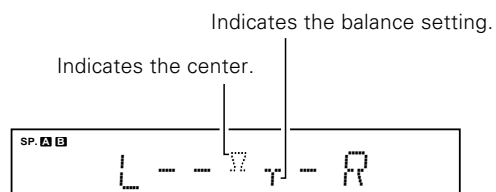

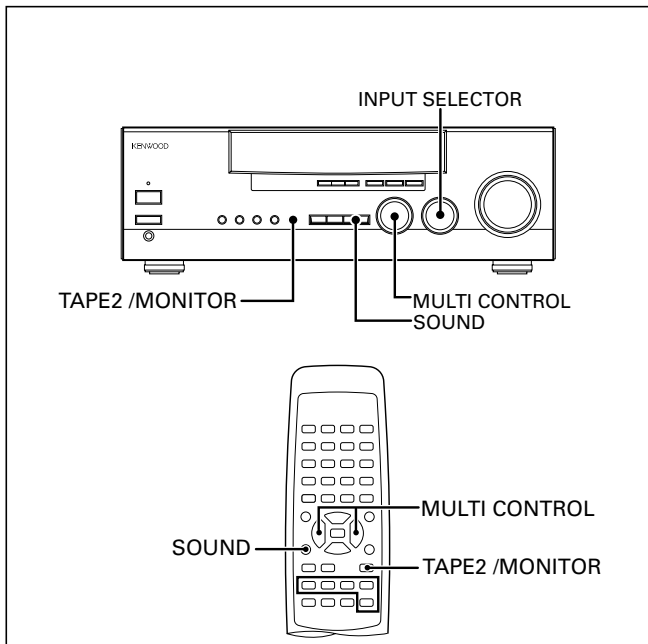

## Recording audio

### Recording a music source

- ❶ Use the input selector (INPUT SELECTOR) to select the source (other than "TAPE 1") you want to record.
- ❷ Set the cassette deck to record.
- ❸ Start playback, then start recording.

### Copying tapes

#### TAPE 1 → TAPE 2 copying

- ❶ Use the input selector to select "TAPE 1".
- ❷ Start playback on the cassette deck connected to the MD/TAPE1 jacks and start recording on the cassette deck connected to the TAPE2/MONITOR jacks.
  - To copy tapes using a double cassette deck, refer to the instruction manual of the double cassette deck.

### TAPE2/MONITOR function

You can connect a cassette deck or graphic equalizer to the **TAPE2/MONITOR** jacks of the receiver. If a graphic equalizer is connected, the **TAPE2/MONITOR** key should be left in the on position. Alternately, if a cassette deck equipped with a 3-head system is connected to the **TAPE2/MONITOR** jacks, you will be able to monitor the just-recorded signal while making recordings on the cassette deck. By switching the **TAPE2/MONITOR** key on and off, you can compare the sound of the source signal and the just-recorded signal. For more information, refer to the instruction manual of the connected component.

- The equalizer effect can be applied to the played audio but cannot be recorded together with the audio signal.
- Copy from "TAPE 2" to "TAPE 1" is not possible.

### Input level adjustment (when using the monitor function)

If the input level while using the monitor function is too high, adjust the input level as described below. The input level cannot be adjusted when in the source direct playback mode.

- ❶ Press the TAPE2/MONITOR key.
- ❷ Press the SOUND key several times until the "INPUT" indication appears.
- ❸ Use the MULTI CONTROL to adjust the input level.

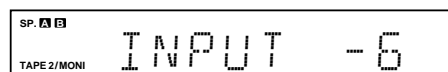

- The adjustment mode is displayed for approximately 8 seconds.
- The input level may be adjusted to any one of 2 settings: 0 and -6. (The initial setting is 0.)

- ❹ Press the SOUND key to return to the input indication.

# Listening to radio broadcasts

KRF-A4020 (En/E2T)

## Tuning (non-RDS) radio stations

Radio stations can be classified into RDS (Radio Data System) stations and other stations. To listen to or store RDS stations in the preset memory, see the section entitled, "Using RDS".

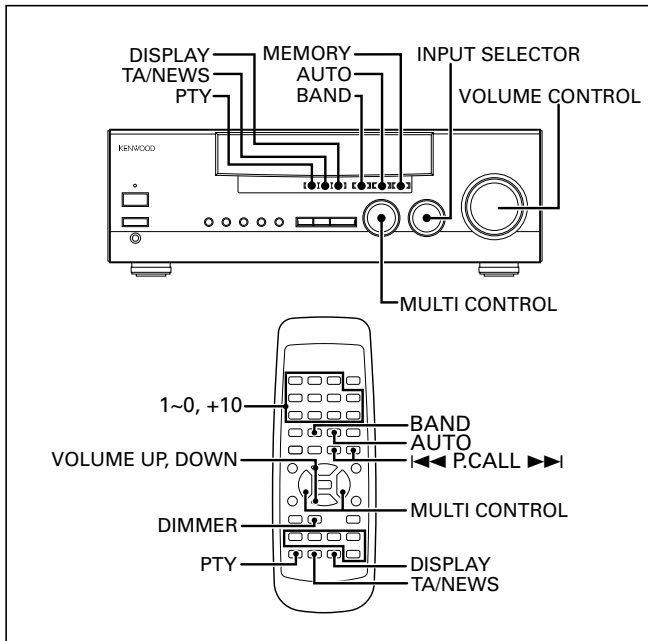

**1 Use the input selector (INPUT SELECTOR) to select the tuner.**

**2 Use the BAND key to select the desired broadcast band.**

Each press switches the band as follows:

- ① FM
- ② AM

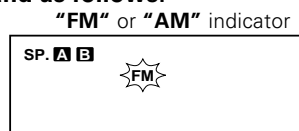

**3 Use the AUTO key to select the desired tuning method.**

Each press switches the tuning method as follows:

- ① AUTO lit (auto tuning)
- ② AUTO not lit (manual tuning)



- Normally, set to "AUTO" (auto tuning). If the radio waves are weak and there is a lot of interference, switch to manual tuning. (With manual tuning, stereo broadcasts will be received in monaural.)

**4 Use the MULTI CONTROL to select the station.**

Lights when a broadcast is being received in stereo.

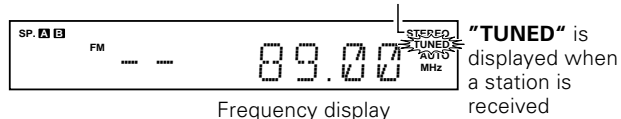

**Auto tuning** : The next station is tuned automatically.

**Manual tuning** : Turn the knob (press the key) to select the desired station.

- You can also use the **TUNING** key on the remote control to make the selection.

## Using RDS (Radio Data System)

RDS is a system that transmits useful information (in the form of digital data) for FM broadcasts along with the broadcast signal. Tuners and receivers designed for RDS reception can extract the information from the broadcast signal for use with various functions, such as automatic display of the station name.

### RDS functions:

#### PTY (Program Type identification) Search → 16

Automatically tunes to a station that is currently broadcasting the specified program type (genre).

#### EON (Enhanced Other Network) reservation → 16

Sets the tuner to automatically switch to stations broadcasting one of two types of programs, even though you are listening to another station. The tuner returns to the original station when the broadcast of the selected program ends.

#### PS (Program Service name) Display

Automatically displays the station name transmitted by the RDS station.

#### RDS Auto Memory function → 14

Automatically selects and stores up to 30 RDS stations in the preset memory.

If fewer than 30 RDS stations have been stored in the preset memory, regular FM stations will be stored in the remaining places.

#### Radio Text function

Displays the radio text data transmitted by some RDS stations when you press the **DISPLAY** key. There is no display if no text data was transmitted.

#### TI volume → 17

If you preset the volume level, you can listen to the information of your choice at that volume level automatically. After the information has been received, the volume returns to the previous level.

The "RDS" indicator lights up when an RDS broadcast (signal) is received.

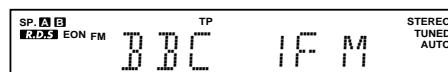

Note:

Some functions and function names may differ for certain countries and areas.

Before using a function utilizing the RDS, be sure to perform the RDS Auto Memory operation by referring to the description in "**Presetting RDS stations (RDS AUTO MEMORY)**". → 14

## 14 Using the DISPLAY key

Pressing the **DISPLAY** key changes the contents of the display.

Each press switches the display mode as follows:

- ① **PS** (Program Service name) display
- ② **RT** (Radio Text) display
- ③ **Frequency** display

### ① PS (Program Service name) display:

The station name is displayed automatically when an RDS broadcast is received, If no PS data was sent, "NO PS" is displayed.

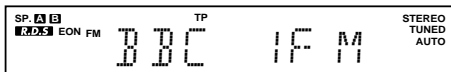

### ② RT (Radio Text) display:

Text data accompanying the RDS broadcast scrolls across the display. "NO RT" or "RT----" is displayed if the current RDS station does not provide RT data.

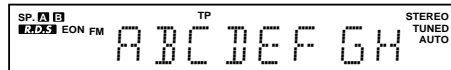

### ③ Frequency display:

Displays the frequency of the current station.

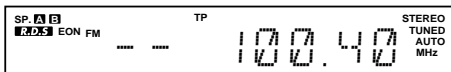

## Presetting RDS stations (RDS AUTO MEMORY) (Main unit only)

This function automatically stores up to 30 stations including the RDS stations and ordinary FM stations in the preset memory. In order to use the **EON** and **PTY** functions, the RDS stations must be stored in the preset memory using the **RDS AUTO MEMORY** function.

- ① Use the **INPUT SELECTOR** to select the tuner.
- ② Use the **BAND** key to set the broadcast band to "FM".
- ③ Press and hold the **MEMORY** key for more than 2 seconds.

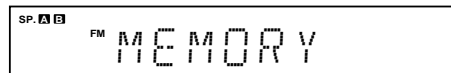
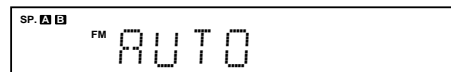

- After a few minutes, up to 30 RDS stations are preset in order from channel "01".
- Stations already stored in the preset memory may be replaced by RDS stations. (i.e., If the **RDS AUTO MEMORY** function finds 15 RDS stations, the stations currently preset at numbers 01~15 are replaced by the RDS stations.)
- The **RDS AUTO MEMORY** may take a few minutes to preset stations.

## Display dimmer adjustent

The dimmer function lets you select the brightness of the receiver's display. You might find this useful if you darken your room to watch movies or listen to music.

Each time you hold down the **DISPLAY** key of the main unit for more than 2 seconds, the display brightness changes among the three available settings. Select the brightness level you find most pleasing.

The same function as above is also available by pressing the **DIMMER** key of the remote control unit.

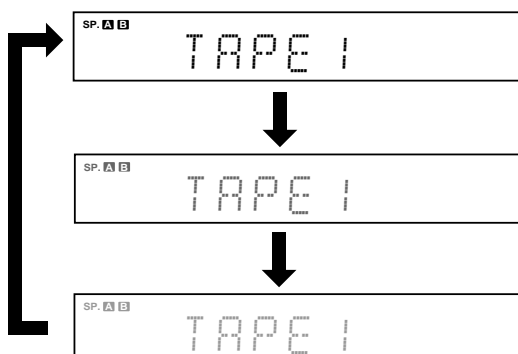

## Presetting radio stations manually

The RDS auto memory function assigns preset numbers to RDS stations starting from preset number "01". Therefore, be sure to execute the RDS auto memory function before using the following operations to manually store AM stations and other FM stations, and RDS stations.

"Presetting RDS stations (RDS AUTO MEMORY)" . -- 14

- 1 Tune to the station you want to store.
- 2 Press the **MEMORY** key while receiving the station.

Proceed to step 3 within 5 seconds.  
(If more than 5 seconds elapse, press the **MEMORY** key again).

- When storing radio stations manually, it may take a few seconds before the "MEMO" indicator appears in the display after pressing the **MEMORY** key depending on receiving conditions.

Blinks for 5 seconds    Lights for 5 seconds

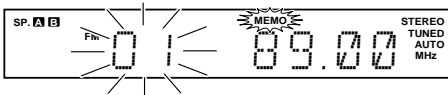

- 3 Use the **MULTI CONTROL** to select one of the station presets (1 – 30).
- 4 Press the **MEMORY** key to accept the setting.

- Repeat steps 1, 2, 3 and 4 to store as many stations as necessary.
- If you store a station at a previously used preset, the old station will be replaced by the new one.

## Receiving preset stations

- 1 Use the input selector (**INPUT SELECTOR**) to select the tuner.
- 2 Using the remote control unit, enter the number of the preset you want to receive (up to "30").

Press the numeric keys in the following order:

For "15", press ..... [+10], [5]

For "20", press ..... [+10], [+10], [0]

- If you make a mistake entering a two digit number, press the [+10] key several times to return to the original display and start again.



## Receiving preset stations in order (P.CALL)

- 1 Use the input selector (**INPUT SELECTOR**) to select the tuner.
- 2 Use the **P.CALL** key to select the desired station.

- Each time you press the **P.CALL** key, another preset station is received in order.

Pressing the **P.CALL** (▶▶) key does the following:

01→02→03→ ...28→29→30→01→02→03→

Pressing the **P.CALL** (◀◀) key does the following:

01←02←03←...28←29←30←01←02←03←

Holding down the **P.CALL** key, lets you skip through the presets, receiving each for 0.5 seconds apiece.

## Tuning by program type (PTY search)

This function lets you set the tuner to automatically search for stations which are currently broadcasting the type of program (genre) you want to listen to.

**Under certain receiving conditions, it may take more than 1 minute to complete the search.**

- **PTY** search cannot be activated during **EON** override reception.

### Preparations

- Execute the RDS auto memory procedure.
- Set the broadcast band to **"FM"**.
- Tune to a RDS station.

### 1 Press the **PTY** key to activate the **PTY** search mode.

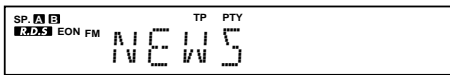

When a RDS broadcast is received, the program type is shown on the display. If no PTY data is available, or if the station is not a RDS station, **"NONE"** is displayed.

### 2 While the **"PTY"** indicator is lit, use the **MULTI CONTROL** to select the program type of your choice.

#### Program type table

Program Type Name	Display
Pop Music	POP M
Rock Music	ROCK M
Easy Listening Music	EASY M
Light Classical	LIGHT M
Serious Classical	CLASSICS
Other Music	OTHER M
News	NEWS
Current Affairs	AFFAIRS
Information	INFO
Sport	SPORT
Education	EDUCATE
Drama	DRAMA
Culture	CULTURE
Science	SCIENCE
Varied	VARIED
Weather	WEATHER
Finance	FINANCE
Children's programs	CHILDREN
Social Affairs	SOCIAL
Religion	RELIGION
Phone In	PHONE IN
Travel	TRAVEL
Leisure	LEISURE
Jazz Music	JAZZ
Country Music	COUNTRY
National Music	NATION M
Oldies Music	OLDIES
Folk Music	FOLK M
Documentary	DOCUMENT

**"NO PROG"** is displayed if this operation is attempted before performing the **RDS AUTO MEMORY** operation.

### 3 Press the **PTY** key to start searching.

#### Example: Searching for a Rock Music broadcast.

Display while searching

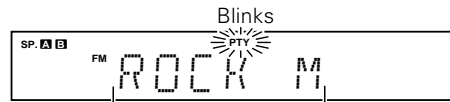

Blinks for 2 seconds  
Program type name display

Display when a station is received.

Goes out

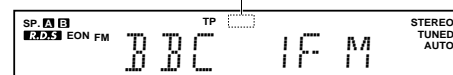

Station name display

- No sound is heard while **"PTY"** is blinking.
- If the desired program type cannot be found, **"NO PROG"** is displayed, then after several seconds the display returns to the original display.

### To select another program type

Repeat steps 1, 2 and 3.

## Reserving the desired information

When the receiver is tuned to a RDS EON station (a station at which the **"EON"** indicator lights up), this function lets you set the receiver to automatically switch stations to receive news or traffic programs as they are broadcast. When the broadcast is over, the receiver returns to the original station automatically.

### Preparation

- Set the broadcast band to **"FM"**. → 13

### 1 Complete steps 1 ~ 3 of "Presetting RDS stations (RDS AUTO MEMORY)".

→ 14

**Skip this step if you have already completed the RDS AUTO MEMORY procedure.**

- The EON function will not work if all 30 FM preset stations were stored manually using the procedure shown in **"Presetting radio stations manually"**. → 15  
Be sure to use the **RDS AUTO MEMORY** function.

Continued to next page



## 2 Press the TA/NEWS key to select the information type of your choice.

Display When "TA" is selected

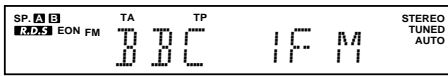

"TP" lights for stations where TP (Traffic Program) information can be received.

Each press switches the reservation mode as follows:

- ➔ 1 TA (Traffic Announcement)
- ➔ 2 NEWS (News)
- ➔ 3 TA, NEWS (Traffic Announcement and News)
- ➔ 4 Goes off (EON off)

- If "TA" and "NEWS" can not be selected, carry out the "Presetting RDS stations (RDS AUTO MEMORY)" again. 

## 3 Tune to a preset RDS station.

Choose a RDS preset station that displays both the "RDS" and "EON" indicators.

Display When "TA" is selected

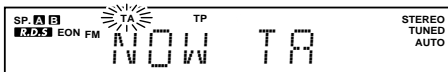

Be sure "EON" appears in the display

- If you want to reserve TA, receive a station with which the "TP" indicator lights. When "EON" does not light although an RDS station is received, that station is not transmitting EON data. Please select a different station.

## 4 Wait for the information you selected while listening to the current station.

The receiver will wait for the desired information to start as long as the tuner is set to a preset RDS station that displays both the "EON" and "RDS" indicators.

**When listening to the tuner:**

Be sure to stay tuned to stations that display both the "EON" and "RDS" indicators.

**To listen sources other than the tuner:**

1. Tune in a station which that displays both the "EON" and "RDS" indicators, then use the **INPUT SELECTOR** to switch the input to the source you desire.
2. Even when the **INPUT SELECTOR** is set to a source other than tuner, it will automatically switch to tuner when the desired EON program starts to broadcast. During this period, the source selected in step 1 continues playing, but will not be heard.
3. When reception of the desired EON program is complete, the **INPUT SELECTOR** returns to the previous input source.

- If a reserved EON program starts to broadcast during recording, the **INPUT SELECTOR** switches to the tuner and the station broadcasting the EON program is recorded.
- Do not use the EON function during recording.

### When waiting for information while listening to a RDS station without the EON function

If the "EON" indicator does not light in steps 3 and 4 and the desired kind of information has already been selected, the information from only the station being received will be waited for.

### TP (Traffic Program) indication

When the "TP" indicator is lit, this means that the presently-received station or a station in the same network is transmitting traffic information. When "TP" is displayed for the station being received, the traffic information of this station can be received without EON reservation.

### To cancel

Press the TA/NEWS key again.

### Setting the volume while receiving information (TI volume) (Main unit only)

If you preset the volume level, you can listen to the information of your choice at that volume level automatically. After the information has been received, the volume returns to the previous level.

- 1 Hold down the TA/NEWS key for more than 2 seconds so that the "TI.VOL" indicator starts blinking.

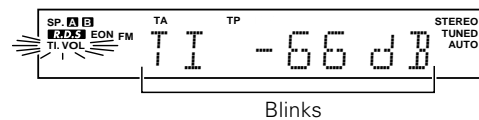

Blinks

- 2 Use the VOLUME CONTROL knob to select the desired volume level.

Proceed to next step within 5 seconds.

- 3 Press the TA/NEWS key to enter the new setting.

- The "TI.VOL" indicator stops blinking and remains lit.

### To cancel

Hold down the TA/NEWS key for more than 2 seconds so that the "TI.VOL" indicator goes off.

## Resetting the Microcomputer

If the microcomputer may malfunction (unit cannot be operated, or shows an erroneous display) if the power cord is unplugged while the power is ON, or due to some other external factor. If this happens, execute the following procedure to reset the microcomputer and return the unit to its normal operating condition.

**With the power cord plugged in, turn the POWER key OFF. Then, while holding down the ON/STANDBY key, press the POWER key.**

- Please note that resetting the microcomputer will clear the contents of the memory and returns the unit to the state it was in when it left the factory.

## Amplifier

Symptom	Cause	Remedy
<b>No sound from the speakers.</b>	<ul style="list-style-type: none"> <li>• The speaker cords are disconnected.</li> <li>• VOLUME is set to the minimum position.</li> <li>• MUTE is ON.</li> <li>• The <b>SPEAKERS</b> switches are set to OFF.</li> </ul>	<ul style="list-style-type: none"> <li>• Connect properly referring to "<b>Setting the speakers</b>". → 5</li> <li>• Adjust the volume to a proper level.</li> <li>• Turn OFF the MUTE. → 11</li> <li>• Set the <b>SPEAKERS</b> switch(es) to ON. → 10</li> </ul>
<b>The standby indicator blinks and sound is not output.</b>	<ul style="list-style-type: none"> <li>• Speaker cords are short-circuited.</li> </ul>	<ul style="list-style-type: none"> <li>• Turn the power off, eliminate the short-circuiting, then turn on the power again. → 5</li> </ul>
<b>Sound is not output from one of the speakers.</b>	<ul style="list-style-type: none"> <li>• The speaker cord is disconnected.</li> </ul>	<ul style="list-style-type: none"> <li>• Connect properly referring to "<b>Setting the speakers</b>". → 5</li> </ul>
<b>A humming noise is generated when the PHONO input selector is selected.</b>	<ul style="list-style-type: none"> <li>• The audio cord from the turntable is not connected to the <b>PHONO</b> jacks.</li> <li>• The turntable is not grounded.</li> </ul>	<ul style="list-style-type: none"> <li>• Insert the audio cord plugs securely into the <b>PHONO</b> jacks.</li> <li>• Connect the grounding wire to the GND terminal on the rear panel. → 4</li> </ul>

## Tuner

Symptom	Cause	Remedy
<b>Radio stations cannot be received.</b>	<ul style="list-style-type: none"> <li>• No antenna is connected.</li> <li>• The broadcast band is not set properly.</li> <li>• The frequency of the desired station is not tuned.</li> </ul>	<ul style="list-style-type: none"> <li>• Connect an antenna. → 5</li> <li>• Set the broadcast band properly.</li> <li>• Tune the frequency of the desired station. → 13</li> </ul>
<b>Interference.</b>	<ul style="list-style-type: none"> <li>• Noise due to ignition noise from an automobile.</li> <li>• Noise due to interference from an electric appliance.</li> <li>• Noise due to a nearby TV set.</li> </ul>	<ul style="list-style-type: none"> <li>• Install the outdoor antenna away from the road.</li> <li>• Turn off the power to the appliance.</li> <li>• Install the receiver farther away from the TV.</li> </ul>
<b>A station which was preset cannot be received by pressing the corresponding numeric key.</b>	<ul style="list-style-type: none"> <li>• The preset station belongs to a frequency that cannot be received.</li> <li>• The preset memory was cleared because the power cord had been unplugged for a long period of time.</li> </ul>	<ul style="list-style-type: none"> <li>• Preset a station with a receivable frequency.</li> <li>• Preset the station again.</li> </ul>

**Remote control unit**

Symptom	Cause	Remedy
Remote control operation is not possible.	<ul style="list-style-type: none"> <li>Batteries are exhausted.</li> <li>The remote control unit is too far away from the main system, controlling angle is too large, or there is an obstacle between the receiver and the remote.</li> <li>The audio cords and system control cords are not connected properly.</li> <li>No software is loaded in the source component.</li> <li>An attempt is made to play a tape which is being recorded in the cassette deck.</li> </ul>	<ul style="list-style-type: none"> <li>Replace with new batteries. → 9</li> <li>Operate the remote control unit within the controllable range.</li> <li>Connect properly referring to <b>"Setting up the system"</b>. → 4 → 6</li> <li>Place software in the source component you want to play.</li> <li>Wait until recording has completed.</li> </ul>

**Memory back up function**

Please note that the following items will be deleted from the unit's memory if the power cord is disconnected from the AC outlet or the main power switch is turned off for approximately 3 days.

- Power mode
- Input selector settings
- Volume level
- Broadcast band
- Frequency setting
- Preset stations

# Specifications

 **Caution :** Read this page carefully to ensure safe operation.

KRF-A4020 (En/E2T)

20

## [ AUDIO section ]

**Rated power output during STEREO operation**  
(DIN) 1 kHz, 0.7 % at 4 Ω ..... 105 W + 105 W  
(IEC) 63 kHz ~ 12.5 kHz, 0.5 % at 4 Ω.. 100 W + 100 W  
**Total harmonic distortion** ..... 0.02 % (1 kHz, 50 W, 4 Ω)  
**Signal to noise ratio**  
PHONO (MM) ..... 75 dB (IHF'66)  
55 dB (DIN 50mW output)  
CD ..... 92 dB (IHF'66)  
56 dB (DIN 50mW output)  
**Input sensitivity / impedance**  
PHONO (MM) ..... 2.5 mV / 27 kΩ  
CD ..... 200 mV / 47 kΩ  
**Output level / impedance**  
TAPE REC ..... 200 mV / 2.2 kΩ  
PRE OUT (SUBWOOFER) ..... 2 V / 2.2 kΩ  
**Tone control**  
BASS ..... ±9 dB (at 100 Hz)  
TREBLE ..... ±9 dB (at 10 kHz)

## [ FM tuner section ]

**Tuning frequency range**  
U.K. and Europe ..... 87.5 MHz ~ 108.0 MHz  
Russia ..... 87.5 MHz ~ 108.0 MHz (10 kHz STEP)  
65.0 MHz ~ 74.0 MHz (50 kHz STEP)  
**Usable sensitivity (DIN, 75 Ω)**  
MONO ..... 1.2 μV / 13.2 dBf (40 kHz DEV., S/N 26 dB)  
STEREO .... 45 μV / 44.2 dBf (46 kHz DEV., S/N 46 dB)  
**Total harmonic distortion (DIN, 1 kHz)**  
MONO ..... 0.2% (65.2 dBf input)  
STEREO ..... 0.8% (65.2 dBf input)  
**Signal to noise ratio (DIN weighted, 1 kHz)**  
U.K. and Europe  
MONO .... 65 dB (40 kHz DEV., S/N 26 dB, 65.2 dBf input)  
STEREO . 58 dB (46 kHz DEV., S/N 46 dB, 65.2 dBf input)  
Russia  
MONO ... 63 dB (40 kHz DEV., S/N 26 dB, 65.2 dBf input)  
STEREO . 58 dB (46 kHz DEV., S/N 46 dB, 65.2 dBf input)

**Stereo separation (DIN, 1 kHz)** ..... 36 dB  
**Selectivity (DIN, ±300 kHz)** ..... 64 dB  
**Frequency response (30 Hz ~ 15kHz)** ..... +0.5 dB ~ -3.0 dB

## [ AM tuner section ]

**Tuning frequency range** ..... 531 kHz ~ 1,602 kHz  
**Usable sensitivity (30% mod., S/N 20 dB)**  
..... 16 μV / (600 μV/m)  
**Signal to noise ratio (30% mod., 1 mV input)** ..... 50 dB

## [ GENEAL ]

**Power consumption** ..... 280 W  
**AC outlet**  
SWITCHED ..... 2 (total 150 W max.)  
**Dimensions** ..... W: 440mm  
H : 144mm  
D : 390mm  
**Weight (Net)** ..... 8.0 kg

## Notes:

1. KENWOOD follows a policy of continuous advancements in development. For this reason specifications may be changed without notice.
2. The full performance may not be exhibited in an extremely cold location (under a water-freezing temperature).

Other

# KENWOOD

## *For your records*

Record the serial number, found on the back of the unit, in the spaces designated on the warranty card, and in the space provided below. Refer to the model and serial numbers whenever you call upon your dealer for information or service on this product.

Model \_\_\_\_\_ Serial Number \_\_\_\_\_

## Free Manuals Download Website

<http://myh66.com>

<http://usermanuals.us>

<http://www.somanuals.com>

<http://www.4manuals.cc>

<http://www.manual-lib.com>

<http://www.404manual.com>

<http://www.luxmanual.com>

<http://aubethermostatmanual.com>

Golf course search by state

<http://golfingnear.com>

Email search by domain

<http://emailbydomain.com>

Auto manuals search

<http://auto.somanuals.com>

TV manuals search

<http://tv.somanuals.com>