

PROFESSIONAL



Model PMD325 User Guide

CD Player

marantz®

CLASS 1 LASER PRODUCT
LUOKAN 1 LASERLAITE
KLASS 1 LASERAPPARAT

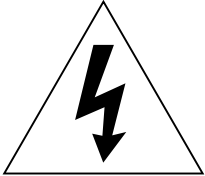

	CAUTION RISK OF ELECTRIC SHOCK DO NOT OPEN	
CAUTION: TO REDUCE THE RISK OF ELECTRIC SHOCK, DO NOT REMOVE COVER (OR BACK) NO USER-SERVICEABLE PARTS INSIDE REFER SERVICING TO QUALIFIED SERVICE PERSONNEL		

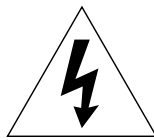

The lightning flash with arrowhead symbol within an equilateral triangle is intended to alert the user to the presence of uninsulated "dangerous voltage" within the product's enclosure that may be of sufficient magnitude to constitute a risk of electric shock to persons.



The exclamation point within an equilateral triangle is intended to alert the user to the presence of important operating and maintenance (servicing) instructions in the literature accompanying the product.

WARNING

**TO REDUCE THE RISK OF FIRE OR ELECTRIC SHOCK,
DO NOT EXPOSE THIS APPLIANCE TO RAIN OR MOISTURE.**

**CAUTION: TO PREVENT ELECTRIC SHOCK, MATCH WIDE
BLADE OF PLUG TO WIDE SLOT, FULLY INSERT.**

**ATTENTION: POUR ÉVITER LES CHOCS ÉLECTRIQUES,
INTRODUIRE LA LAME LA PLUS LARGE DE LA FICHE DANS
LA BORNE CORRESPONDANTE DE LA PRISE ET POUSSER
JUSQU'AU FOND.**

LASER SAFETY

This unit employs a laser. Only a qualified service person should remove the cover or attempt to service this device, due to possible eye injury.

**CAUTION : USE OF CONTROLS OR ADJUSTMENTS
OR PERFORMANCE OF PROCEDURE
OTHER THAN THOSE SPECIFIED HEREIN
MAY RESULT IN HAZARDOUS RADIATION
EXPOSURE.**

IMPORTANT SAFETY INSTRUCTIONS

READ BEFORE OPERATING EQUIPMENT

This product was designed and manufactured to meet strict quality and safety standards. There are, however, some installation and operation precautions which you should be particularly aware of.

1. Read Instructions – All the safety and operating instructions should be read before the product is operated.
2. Retain Instructions – The safety and operating instructions should be retained for future reference.
3. Heed Warnings – All warnings on the product and in the operating instructions should be adhered to.
4. Follow Instructions – All operating and use instructions should be followed.
5. Cleaning – Unplug this product from the wall outlet before cleaning. Do not use liquid cleaners or aerosol cleaners. Use a damp cloth for cleaning.
6. Attachments – Do not use attachments not recommended by the product manufacturer as they may cause hazards.
7. Water and Moisture – Do not use this product near water-for example, near a bath tub, wash bowl, kitchen sink, or laundry tub, in a wet basement, or near a swimming pool, and the like.
8. Accessories – Do not place this product on an unstable cart, stand, tripod, bracket, or table. The product may fall, causing serious injury to a child or adult, and serious damage to the product. Use only with a cart, stand, tripod, bracket, or table recommended by the manufacturer, or sold with the product. Any mounting of the product should follow the manufacturer's instructions, and should use a mounting accessory recommended by the manufacturer.
9. A product and cart combination should be moved with care. Quick stops, excessive force, and uneven surfaces may cause the product and cart combination to overturn.



10. Ventilation – Slots and openings in the cabinet are provided for ventilation and to ensure reliable operation of the product and to protect it from overheating, and these openings must not be blocked or covered. The openings should never be blocked by placing the product on a bed, sofa, rug, or other similar surface. This product should not be placed in a built-in installation such as a bookcase or rack unless proper ventilation is provided or the manufacturer's instructions have been adhered to.
11. Power Sources – This product should be operated only from the type of power source indicated on the marking label. If you are not sure of the type of power supply to your home, consult your product dealer or local power company. For products intended to operate from battery power, or other sources, refer to the operating instructions.
12. Grounding or Polarization – This product may be equipped with a polarized alternating-current line plug (a plug having one blade wider than the other). This plug will fit into the power outlet only one way. This is a safety feature. If you are unable to insert the plug fully into the outlet, try reversing the plug. If the plug should still fail to fit, contact your electrician to replace your obsolete outlet. Do not defeat the safety purpose of the polarized plug.

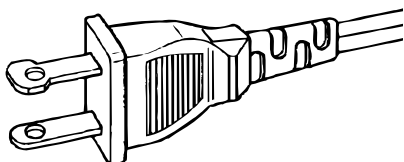

AC POLARIZED PLUG

13. Power-Cord Protection – Power-supply cords should be routed so that they are not likely to be walked on or pinched by items placed upon or against them, paying particular attention to cords at plugs, convenience receptacles, and the point where they exit from the product.
14. Protective Attachment Plug – The product is equipped with an attachment plug having overload protection. This is a safety feature. See Instruction Manual for replacement or resetting of protective device. If replacement of the plug is required, be sure the service technician has used a replacement plug specified by the manufacturer that has the same overload protection as the original plug.
15. Outdoor Antenna Grounding – If an outside antenna or cable system is connected to the product, be sure the antenna or cable system is grounded so as to provide some protection against voltage surges and built-up static charges. Article 810 of the National Electrical Code, ANSI/NFPA 70, provides information with regard to proper grounding of the mast and supporting structure, grounding of the lead-in wire to an antenna discharge unit, size of grounding conductors, location of antenna-discharge unit, connection to grounding electrodes, and requirements for the grounding electrode. See Figure 1.
16. Lightning – For added protection for this product during a lightning storm, or when it is left unattended and unused for long periods of time, unplug it from the wall outlet and disconnect the antenna or cable system. This will prevent damage to the product due to lightning and power-line surges.
17. Power Lines – An outside antenna system should not be located in the vicinity of overhead power lines or other electric light or power circuits, or where it can fall into such power lines or circuits. When installing an outside antenna system, extreme care should be taken to keep from touching such power lines or circuits as contact with them might be fatal.
18. Overloading – Do not overload wall outlets, extension cords, or integral convenience receptacles as this can result in a risk of fire or electric shock.
19. Object and Liquid Entry – Never push objects of any kind into this product through openings as they may touch dangerous voltage points or short-out parts that could result in a fire or electric shock. Never spill liquid of any kind on the product.
20. Servicing – Do not attempt to service this product yourself as opening or removing covers may expose you to dangerous voltage or other hazards. Refer all servicing to qualified service personnel.
21. Damage Requiring Service – Unplug this product from the wall outlet and refer servicing to qualified service personnel under the following conditions:
 - a. When the power-supply cord or plug is damaged.
 - b. If liquid has been spilled, or objects have fallen into the product.
 - c. If the product has been exposed to rain or water.
 - d. If the product does not operate normally by following the operating instructions. Adjust only those controls that are covered by the operating instructions as an improper adjustment of other controls may result in damage and will often require extensive work by a qualified technician to restore the product to its normal operation.
 - e. If the product has been dropped or damaged in any way, and
 - f. When the product exhibits a distinct change in performance – this indicates a need for service.
22. Replacement Parts – When replacement parts are required, be sure the service technician has used replacement parts specified by the manufacturer or have the same characteristics as the original part. Unauthorized substitutions may result in fire, electric shock, or other hazards.
23. Safety Check – Upon completion of any service or repairs to this product, ask the service technician to perform safety checks to determine that the product is in proper operating condition.
24. Wall or Ceiling Mounting – The product should be mounted to a wall or ceiling only as recommended by the manufacturer.
25. Heat – The product should be situated away from heat sources such as radiators, heat registers, stoves, or other products (including amplifiers) that produce heat.

FIGURE 1
EXAMPLE OF ANTENNA GROUNDING AS PER
NATIONAL ELECTRICAL CODE, ANSI/NFPA 70

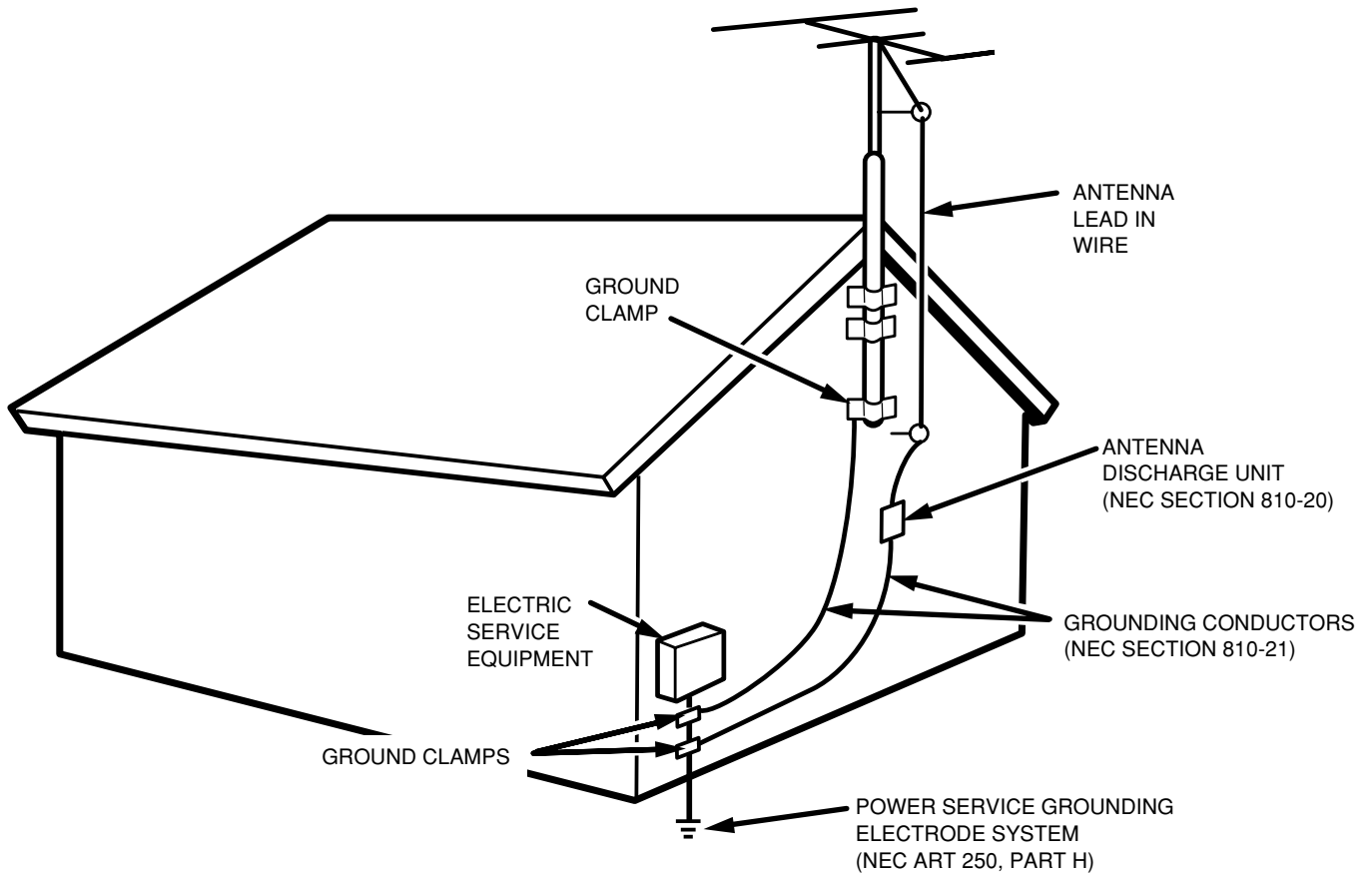

NEC - NATIONAL ELECTRICAL CODE

NOTE TO CATV SYSTEM INSTALLER:

This reminder is provided to call the CATV (Cable-TV) system installer's attention to Article 820-40 of the NEC, which provides guidelines for proper grounding and, in particular, specifies that the cable ground shall be connected to the grounding system of the building, as close to the point of cable entry as practical.

NOTE:

This equipment has been tested and found to comply with the limits for a Class B digital device, pursuant to Part 15 of the FCC Rules. These limits are designed to provide reasonable protection against harmful interference in a residential installation. This equipment generates, uses and can radiate radio frequency energy and, if not installed and used in accordance with the instructions, may cause harmful interference to radio communications. However, there is no guarantee that interference will not occur in a particular installation. If this equipment does cause harmful interference to radio or television reception, which can be determined by turning the equipment off and on, the user is encour-

aged to try to correct the interference by one or more of the following measures:

- Reorient or relocate the receiving antenna.
- Increase the separation between the equipment and receiver.
- Connect the equipment into an outlet on a circuit different from that to which the receiver is connected.
- Consult the dealer or an experienced radio/TV technician for help.

NOTE: Changes or modifications may cause this unit to fail to comply with Part 15 of the FCC Rules and may void the user's authority to operate the equipment.

This Class B digital apparatus complies with Canadian ICES-003.

Cet appareil numérique de la Classe B est conforme à la norme NMB-003 du Canada.

FOREWORD

This section must be read before any connection is made to the mains supply.

Warnings

Do not expose the equipment to rain or moisture.
 Do not remove the cover from the equipment.
 Do not insert anything into the equipment through the ventilation holes.
 Do not handle the mains lead with wet hands.
 Do not cover the ventilation with any items such as tablecloths, newspapers, curtains, etc.
 No naked flame sources, such as lighted candles, should be placed on the equipment.
 When disposing of used batteries, please comply with governmental regulations or environmental public instruction's rules that apply in your country or area.

CE marking (only EU version)

 This product is in conformity with the EMC directive and low-voltage directive.

EQUIPMENT MAINS WORKING SETTING

Your Marantz product has been prepared to comply with the household power and safety requirements that exist in your area. PMD325 product can be powered by 120 V AC only.

COPYRIGHT

Recording and playback of any material may require consent. For further information refer to the following:

- Copyright Act 1956
- Dramatic and Musical Performers Act 1958
- Performers Protection Acts 1963 and 1972
- any subsequent statutory enactments and orders

INSTALLATION

Remember the following important points when installing the player:

- Do not expose the player to rain or moisture, as this may cause damage to the player.
- All players produce some heat during operation and this heat must be allowed to disperse freely. Do not close any ventilation openings and insure that there is adequate ventilation space behind, beside and above the player.
- Prevent extra heat from reaching the unit. Never put the player in the full glare of the sun or near a heat source.

PRECAUTIONS

The following precautions should be taken when operating the equipment.

GENERAL PRECAUTIONS

When installing the equipment ensure that:

- the ventilation holes are not covered.
- air is allowed to circulate freely around the equipment.
- it is placed on a vibration-free surface.
- it will not be exposed to excessive heat, cold, moisture or dust.
- it will not be exposed to direct sunlight.
- it will not be exposed to electrostatic discharges.

In addition, never place heavy objects on the equipment.

If a foreign object or water does enter the equipment, contact your nearest dealer or service center.

Do not pull out the plug by pulling on the mains lead; grasp the plug. It is advisable when leaving the house for an extended period, or during a thunderstorm, to disconnect the equipment from the mains supply.

PRECAUTIONS IN CONNECTION

- Be sure to unplug the power cable from the AC outlet or turn off the POWER switch before proceeding with any connection.
- Connect one cable at a time observing the "input" and "output". This will avoid any cross connection between channels and signal inputs and outputs.
- Insert the plugs securely. Incomplete connection may result in noise.
- Prior to connecting other audio and video equipment to the PMD325, please read their owner's manuals.

CONTENTS

1. BEFORE USING	3
2. ACCESSORIES	5
3. FEATURES	6
4. CONNECTIONS	7
5. NAMES AND FUNCTIONS	9
Front panel	9
Display	10
Remote control unit	11
Rear panel	12
6. BASIC OPERATIONS	14
Playing CDs	14
Playing a specific track	15
Playing a specific part of a specific track	16
7. ADVANCED OPERATIONS	17
Repeat play (playing the same tracks repeatedly)	17
Random play (Playing tracks in a random sequence)	18
AMS play (Searching for a specific track)	18
Program play (playing tracks in the preferred sequence)	19
Delete program play (play with undesired tracks skipped)	21
Pitch control (changing the play speed)	24
Setting the position to start listening to play (manual cue)	25
8. SETTING THE PLAY FUNCTIONS	26
Using EASY JOG	26
Various play functions (play modes)	28
9. OTHER FUNCTIONS	38
Last memory	38
CD-TEXT	38
CD-R/RW disc play	39
MP3	39
Fader start	42
How to use the RS-232C connector	43
Installing the rack-mounting kit	44
10. SPECIFICATIONS AND DIMENSIONS	45
11. TROUBLESHOOTING	46

1. BEFORE USING

Notes about the discs

* **Handle the discs carefully so as not to scratch their surfaces.**

* **Keep the surfaces of the discs clean at all times.**

When cleaning the surfaces of discs, always be sure to use the special cleaner and wipe the surfaces in the directions shown in the figure below.

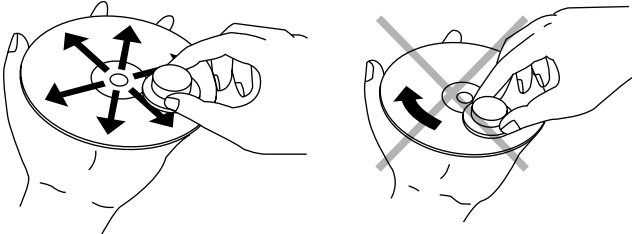

- Wipe the surface radially from the center.
- Do not wipe the surface in the circumferential direction.

* **Do not attach pieces of paper or stickers to the label surfaces of the discs.**

When a disc has a piece of plastic tape or rental CD label with paste protruding from the edge or when a disc still bears traces of sticky tape or adhesive labels, do not attempt to play it. If such a disc is played on the CD player, you may find that you cannot remove it or that some other kind of malfunctioning may occur.

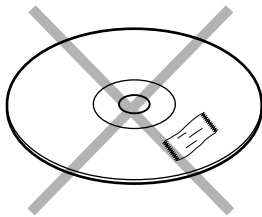

* **Do not use discs which come in special shapes.**

Do not attempt to play heart-shaped or octagonal discs or discs with any other special shapes. You may find that you cannot remove them or that some other kind of malfunctioning may occur in the player.

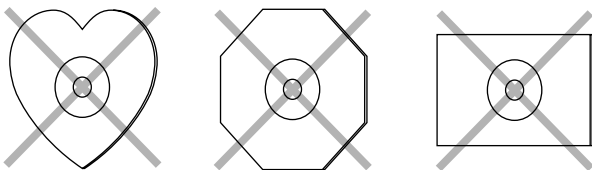

* **Use discs which satisfy the CD standards such as those with the "CD logo" or "Compact Disc Digital Audio" mark on their disc label surfaces.**

No guarantees are made for playback if discs which do not satisfy the appropriate CD standards are used. Similarly, no guarantees are made for their sound quality even if it is possible to play such discs.

* **To protect your discs from damage, avoid placing them in the following locations.**

- Where they will be exposed to direct sunlight or where they will be close to a heater or other heat-radiating appliance
- Where the humidity level is high or it is very dusty
- Near a window or other such location where they may be exposed to rain

* **Get into the habit of putting the discs back in their cases after use.**

Inappropriate places for installation

To keep your player in perfect working order for the longest possible time, avoid installing the player in the following locations.

- Wherever it will be exposed to direct sunlight
- Wherever it will be close to a heater or other heat-radiating appliance
- Wherever the humidity is high or ventilation is poor
- Wherever it is very dusty
- Wherever it will be subject to vibration
- On top of a rickety stand or in an unstable location which is tilted at an angle
- On top of an amplifier or other component which dissipates a great deal of heat
- In an audio rack with little space at the top and bottom or other location where the heat dissipation will be obstructed
To ensure proper heat dissipation, install the player while leaving clearances between the player and wall or other components, as shown in the figure below.

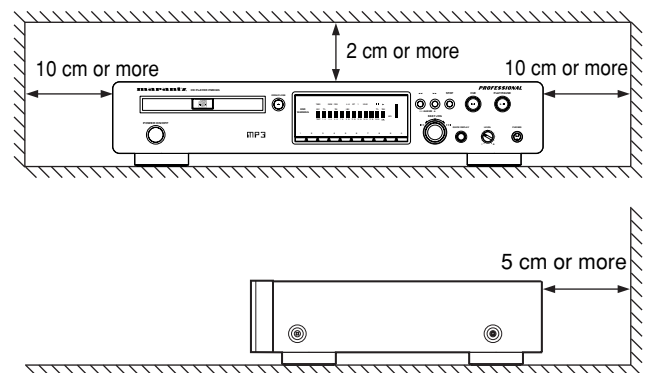

Installation precautions

In order to ensure that the unit will operate correctly, install and operate it within +/-10 degrees from the horizontal plane. If the unit tilts too far in one direction, its disc may be pinched or it may not be possible to open and close the disc holder properly.

When the unit is to be installed in a 19-inch rack for use, secure it firmly in four places.

Refer to page 45 for the outline drawing.

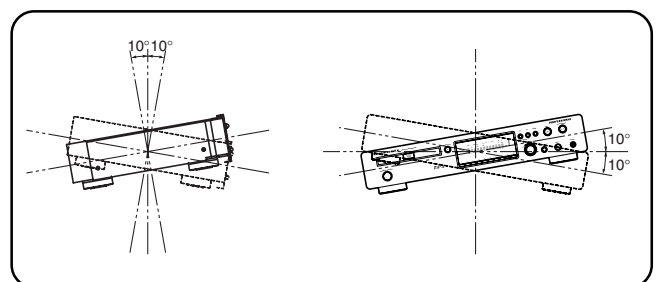

BEFORE USING

Do not place objects on top

- Refrain from placing any objects on top of the player.

Cautions on handling power cord

- Do not touch the power cord with wet hands.
- When disconnecting the power cord, always make sure that you take hold of the plug. Yanking out or bending the cord can damage it and/or cause electric shocks or a fire.
- Get into the habit of disconnecting the power plug before leaving home.

Do not attempt repairs yourself

- Refrain from lubricating the player: doing so can cause malfunctioning.
- Only qualified engineers with specialized expertise are authorized to repair the pick-up and parts inside the player.

Precautions

- In winter, droplets of water form on the insides of the windows of a heated room: this is called condensation. This CD player uses an optical lens, so the condensation may form in the following cases.
 - In a room immediately after the heating has been turned on
 - In a room where the humidity level is high
 - When the player has been suddenly brought from a cold location into a warm roomSince, in cases like this, the track numbers may not be read and the player is prevented from operating properly, wait about 30 minutes, and then operate the player.
- This player may cause interference on a tuner or TV set. If this is the case, place it further away from the tuner or TV set.
- Compact discs have much less noise than analog records and hardly any noise is heard before play starts. Bear in mind, therefore, that if the volume control on the amplifier is set too high, you will risk damaging other audio components.
- This player is designed to play music CDs only. It cannot play CD-ROMs used with personal computers, game CDs, video CDs or DVDs (video/audio).

Cautions on handling batteries

Misuse of the batteries can result in electrolyte leakage, rupturing, corrosion, etc.

Bear in mind the following points when using batteries.

- Remove the batteries from the remote control unit if the unit is not going to be used for a prolonged period (a month or more).
- Do not use an old battery together with a new one.
- Insert the batteries while ensuring that their \oplus and \ominus poles are properly aligned with the corresponding markings on the remote control unit.
- Batteries with the same shape may have different voltages. Do not use different types of batteries together.
- If electrolyte has leaked, thoroughly wipe the inside of the battery compartment, and then insert new batteries.

2. ACCESSORIES

Checking the accessories

After opening the cover of the packing box, check that the following accessories are included.

- **Remote control unit (RC7300CD)**

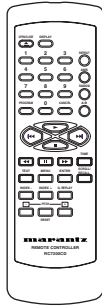

- **Size "AA" batteries x 2**

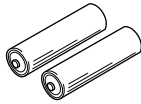

- **Audio connecting cord (1 meter long)**

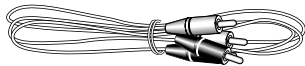

- **User Guide**
- **Warranty card**

- **Operational range**

As shown in the figure below, the player can be operated by the remote control unit in a range which of about 5 meters from the player's remote sensor and over an angle up to 30 degrees to the left and 30 degrees to the right of the position directly in front.

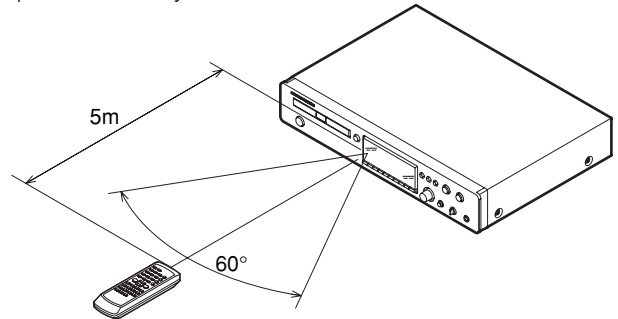

- **Loading batteries**

Before using the supplied remote control unit for the first time, load the batteries in the remote control unit. The batteries provided are used to verify the operations of the remote control unit only.

- 1 Take hold of the tab on the battery cover which is found on the back side of the remote control unit, and pull it up.

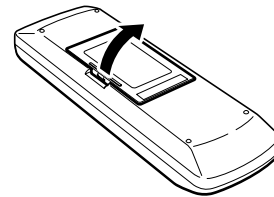

- 2 Load the two new size "AA" batteries inside the battery compartment while taking care to align their polarities correctly with the polarity markings (+ with + and - with -).

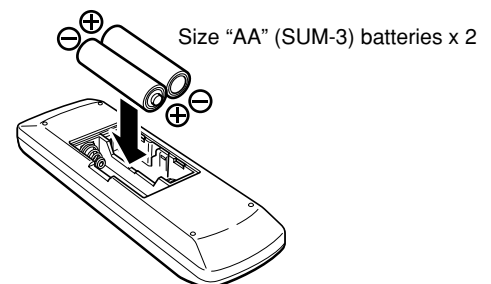

- 3 Push the battery cover down in the direction of the arrow to close it.

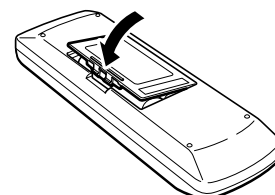

Usage of REMOTE CONTROL UNIT

- **Precautions**

- Do not allow direct sunlight, an inverter fluorescent light or other strong source of light to shine onto the player's infrared signal reception window (remote sensor). Otherwise, the operation of the remote control unit may be disabled.
- Bear in mind that operating the remote control unit may cause other devices operated by infrared rays to be operated by mistake.
- The remote control unit cannot be operated if the space between the controller and the player's remote sensor is obstructed.
- Do not place any objects on top of the remote control unit. Doing so may cause one or more buttons to be held down which will cause the batteries to run down.

3. FEATURES

- **Play of unfinalized CD-R and CD-RW discs supported**

The PMD325 can play even partially once-written CD-R and CD-RW discs that could not be played by conventional CD players. Since unfinalized discs which have some recording time left can be played, even partially edited discs can be played.

- **MP3 play and ID3 tag display supported**

The PMD325 supports not only the play of CD-R and CD-RW discs recorded with MP3 files but also the ID3 tags which are the text information of MP3 files so that text giving the track information or artists' names can be displayed. (Japanese characters cannot be displayed.)

- **CD-TEXT displays supported**

- **Pitch control function**

The PMD325 comes with a pitch control function that enables the play speed (pitch) to be varied in a -12% to +12% range. This is useful when practicing to play a musical instrument.

- **Quick replay function**

By means of a single-touch action, the quick replay function returns play to a position, which is a number of seconds (setting range: 1 to 30 seconds) that has been set, before the position of the track now playing. This enables you to return and listen again to the section a little before the position where the track is now playing.

- **End monitor function**

By means of a single-touch action, the end monitor function plays the end part of the track now playing for the duration (setting range: 1 to 30 seconds) which has been set. This makes it easy to check the end part of the track which is now being played.

- **Auto cue function**

This enables play to start automatically from the position where the sound begins.

- **Manual cue function**

By setting the play start position in advance, play can always be started at the preset position.

- **End warning function**

When the end of the track being played is approached, the end warning indicator starts flashing to signal that the end of the track now playing is near.

- **Wide range of play modes**

Among the many play modes featured by the PMD325 are single play (STOP, NEXT, RECUE), programmed play, repeat play (ALL, 1-track, A-B) and auto pause.

- **External control interfaces**

The PMD325 features RS-232C, parallel control I/O and remote I/O as external control interfaces.

- **Timer play supported**

- **CS4396 high-performance D/A converter (made by Cirrus Logic)**

High-linearity play is achieved by oversampling the PCM signals to 128fs inside the D/A converter and combining dynamic element matching (DEM) with multi-element switched capacitors.

- **Digital and analog areas configured separately**

The digital area consisting of the servo, decoder and microcomputer circuitry is mounted en bloc on the CD mechanism PCB away from the analog (audio circuitry) area.

This keeps out the pulsive noise generated from the digital area and yield a pure sound reproduction.

4. CONNECTIONS

This CD player is connected to an amplifier, CD recorder and other components for use. To ensure that the components are connected properly, refer to the instruction manuals that come with the components to be connected. Before connecting the components, be absolutely sure to turn off their power.

Connecting to an amplifier

• Connecting the analog unbalanced output connectors

Use the audio connecting cord to connect the player with a stereo amplifier or AV amplifier. Do not connect the player to the PHONO input connectors on the amplifier. When making the connections, insert the plugs securely into the connectors. Failure to insert the plugs securely may result in noise.

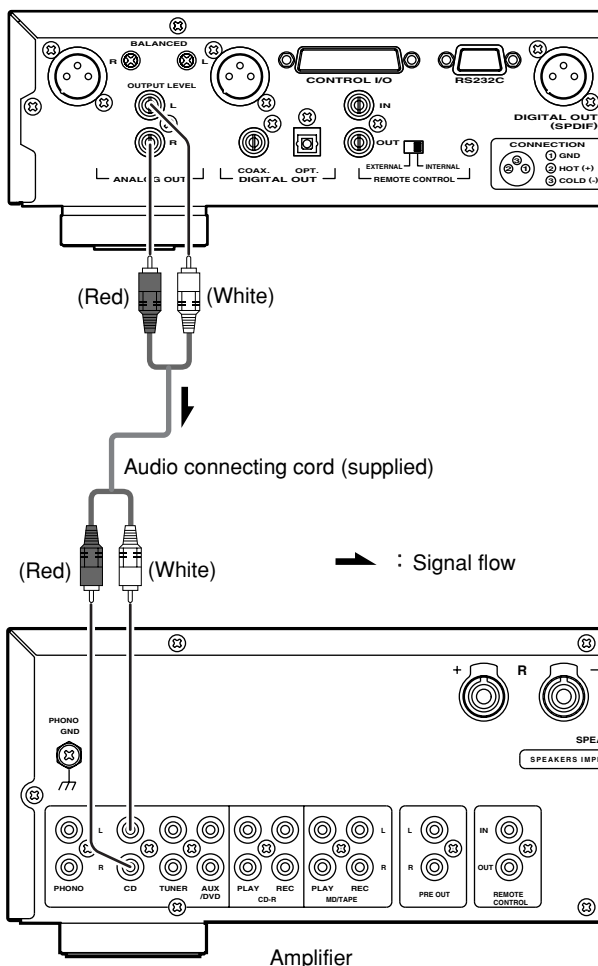

• Connecting the ANALOG BALANCED OUT (analog balanced output) connectors

Connect the unit to the stereo amplifier or AV amplifier using XLR connector cables. When making the connections, insert the plugs firmly into the connectors. Failure to insert them securely gives rise to noise.

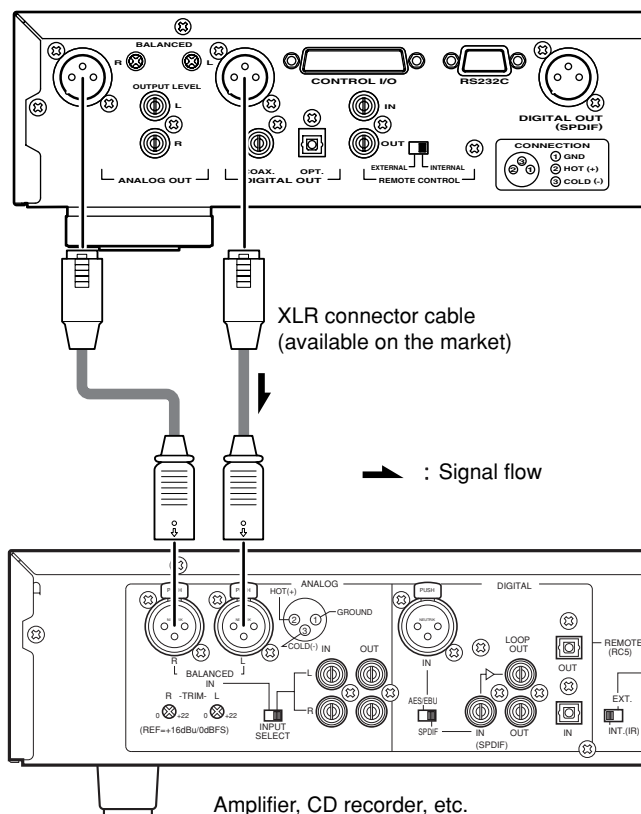

ENGLISH

Connecting to a digital audio component

This unit comes with three different digital output connectors: OPTICAL (x1), COAXIAL (x1) and DIGITAL OUT (SPDIF) (digital balanced).

You can enjoy digital recording when the player is connected to a CD recorder or other digital recording component.

Connecting the optical output connector

Use an optical digital connecting cable available on the market. Insert the plug firmly in until it clicks into place. Do not bend or bundle the optical digital connecting cable.

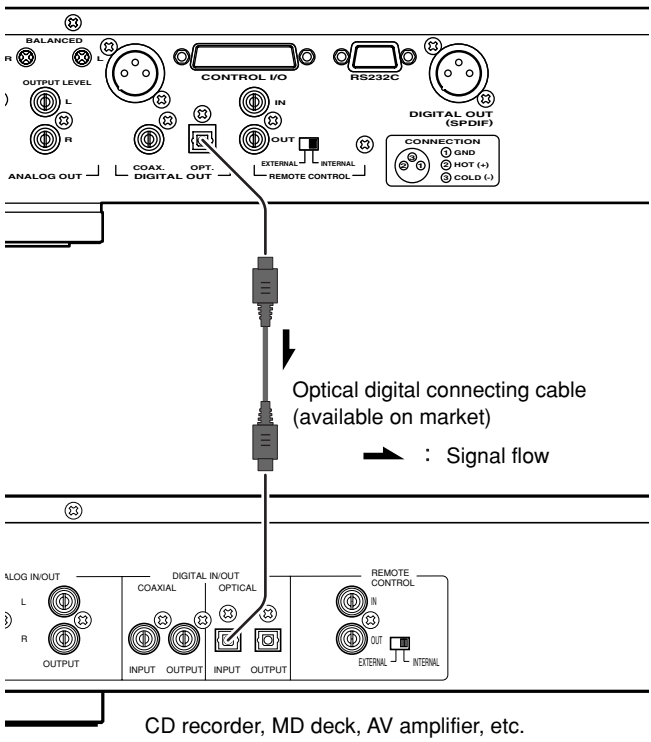

Connecting the coaxial output connector

Use a coaxial digital connecting cable available on the market.

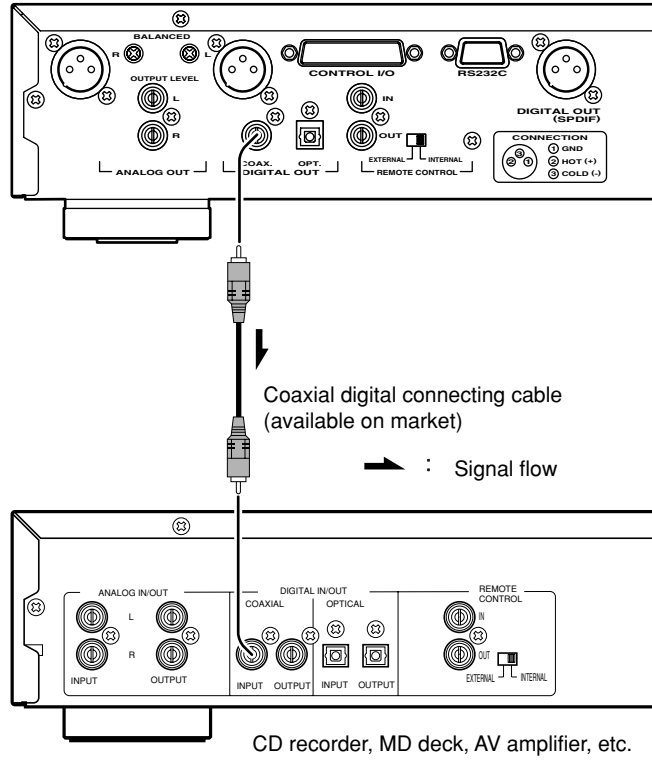

DIGITAL OUTPUT (SPDIF) (digital balanced output) connector

Use an XLR connector cable available on the market to connect this connector.

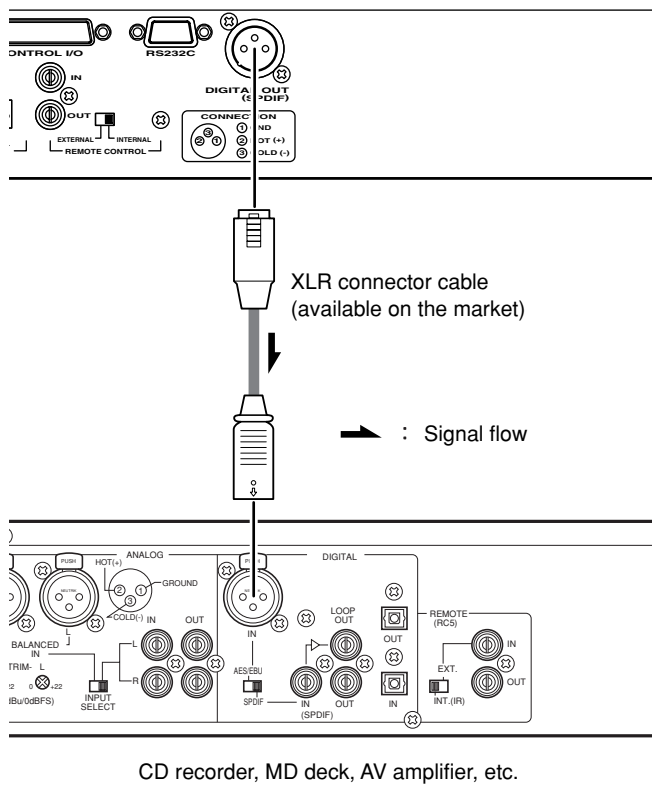

5. NAMES AND FUNCTIONS

Front panel

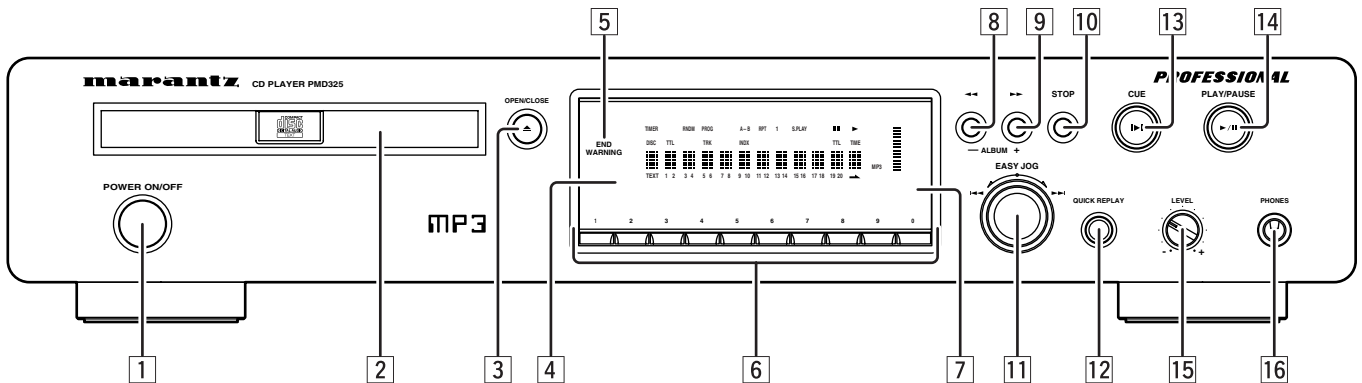

ENGLISH

1 POWER ON/OFF switch

This is used to turn the player's power ON and OFF. When it is pressed, the display lights and the power is turned on; when it is pressed again, the power is turned off.

2 Disc tray

This is where the CD to be played is placed.

3 OPEN/CLOSE ▲ button

This is used to open and close the disc tray. When it is pressed, the disc tray opens; when it is pressed again, it closes.

4 Remote sensor

This senses the infrared control signals sent from the remote control unit.

5 END WARNING indicator

This starts flashing 15 seconds before the end of the track now playing is reached.

6 Numeric buttons (0 to 9)

These are used to specify the numbers of the tracks to be played.

7 Display

This shows the settings, play status, text information, etc.

8 ◀◀ (search backward) button

This is used to search backward during play. It also serves as the album selector button when playing discs with MP3 files recorded on them.

9 ▶▶ (search forward) button

This is used to search forward during play. It also serves as the album selector button when playing discs with MP3 files recorded on them.

10 STOP ■ button

This is used to stop play.

11 EASY JOG/push enter button

Preceding or subsequent tracks can be searched (tracks can be skipped) by turning the jog dial clockwise or counterclockwise. In addition, the play functions (play modes) can be set using the jog dial.

12 QUICK REPLAY button

This is used to search backward from the current play position for the time equivalent to the setting and resume play.

The button is operated by the play setting function as the end monitor. In the case of the end monitor, play is resumed from the position which is before the end position of the track now playing by the duration which has been set.

13 CUE |▶| button

This button is used to move to and start set cue points.

14 PLAY/PAUSE ▶/|| button

This is used to start play or temporarily suspend play.

15 PHONES LEVEL control

This is used to adjust the headphones volume level. The level increases when it is turned clockwise.

16 PHONES jack

The headphones are connected to this jack. Use headphones that come with a standard plug.

Display

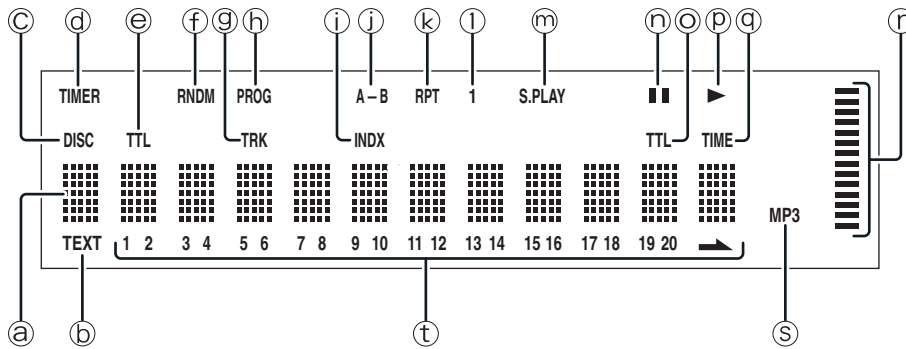

ENGLISH

- a Main display**
This displays the time information and text information of the disc played, the setting menus, etc.
- b TEXT indicator**
This lights when a disc supporting CD-TEXT has been loaded.
- c DISC indicator**
This flashes during readout of the table of contents (TOC) information on the disc.
- d TIMER indicator**
This lights when timer play has been set.
- e TTL (total track) indicator**
This lights above the display of the total number of tracks recorded on the disc.
- f RNDM (random) indicator**
This lights during random play.
- g TRK (track) indicator**
This lights above the display of the number of the track being played, etc.
- h PROG (program) indicator**
This lights during program play.
- i INDX (index) indicator**
This lights above the display of the index number being played, etc.
- j A-B (A-B repeat) indicator**
This lights during A-B repeat play.
- k RPT (repeat) indicator**
This lights during repeat play.
- l 1 (1-track repeat) indicator**
This lights during 1-track repeat play.
- m S.PLAY (single track play) indicator**
This lights during single track play.
- n || (pause) indicator**
This lights when play is temporarily suspended.
- o TTL (total time) indicator**
When the total remaining time or total program time is displayed, this lights above that display.
- p ► (play) indicator**
This lights during play.
- q TIME indicator**
This lights while the elapsed time or other such time is displayed.
- r Pitch control indicator**
This displays the pitch control setting.
- s MP3 indicator**
This lights when a disc on which MP3 files have been recorded is loaded.
- t 1 - 20, ► (music calendar)**
This displays the track numbers recorded on the disc, the track numbers still to be played, and the track numbers programmed for program play. During MP3 file play, the album is displayed.

Remote control unit

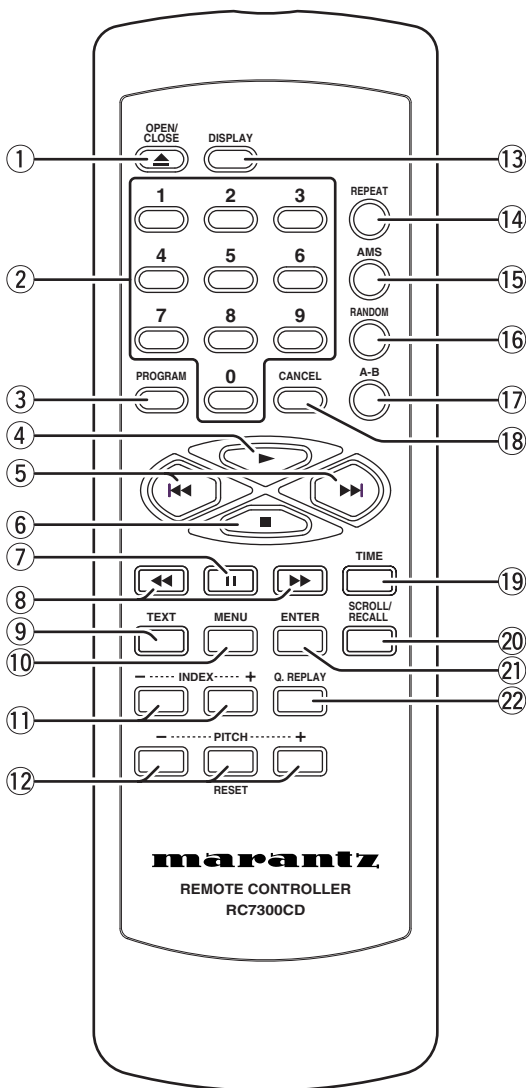

- ① **OPEN/CLOSE ▲ button**
This is used to open and close the disc tray. When it is pressed, the disc tray opens; when it is pressed again, it closes.
- ② **Numeric buttons (0 to 9)**
These are used to specify the numbers of the tracks to be played.
- ③ **PROGRAM button**
This is pressed to initiate program play.
- ④ **▶ (play) button**
This is used to start play.

- ⑤ **◀◀, ▶▶ (track skip) buttons**
◀◀ : Use this to return to the start of the track now playing or return to the start of the previous track.
▶▶ : Use this to advance to the start of the subsequent track.
- ⑥ **■ (stop) button**
This is used to stop the play.
- ⑦ **⏸ (pause) button**
This is used to temporarily suspend play.
- ⑧ **◀◀, ▶▶ (search) buttons**
◀◀ : This button is used to search backward when it is held down during play.
▶▶ : This button is used to search forward when it is held down during play.
These buttons also serve as the album selector buttons when playing discs with MP3 files recorded on them.
- ⑨ **TEXT button**
This is used to switch the main display from the time display to the text display.
- ⑩ **MENU button**
This is used to switch to the play function (play mode) setting menu.
- ⑪ **INDEX +/- (index down/up) buttons**
These are used to skip and search indexes. They can be used with discs on which index numbers have been recorded.
- ⑫ **PITCH -/RESET/+ (pitch control down/reset/up) buttons**
These are used to adjust the play speed (pitch) with a ±12% range.
- ⑬ **DISPLAY button**
This button is used to select the brightness of the display window.
- ⑭ **REPEAT button**
This is used to play one track or all the tracks on the disc repeatedly.
- ⑮ **AMS (auto music scan) button**
This is used to play the intros of all the tracks in sequence starting from the first track for the duration equivalent to the setting.
- ⑯ **RANDOM button**
This is used to play the tracks in a random sequence.

NAMES AND FUNCTIONS

17 A-B (A-B repeat) button

This is used to set start point (A) and end point (B) when a particular section is to be played repeatedly.

18 CANCEL button

This is used to cancel the programmed tracks.

19 TIME button

This switches the main display from the text display to the time display. It can also switch the time display during play.

It can display how much time has elapsed and how much play time remains for the current track as well as how much time has elapsed and how much play time remains for the whole disc.

During MP3 file play, it displays the elapsed time only.

20 SCROLL/RECALL button

This is used to scroll the text display when text is displayed. When it is pressed during program play, it is possible to check which tracks have been programmed.

21 ENTER button

This is used to enter the play function settings.

22 Q.REPLAY (quick replay) button

This is used to search backward from the current play position for the time equivalent to the setting and resume play.

Furthermore, operation is performed as the end monitor using one of the play setting functions. In the case of the end monitor, play is resumed from the position, which is a number of seconds that has been set, before the end position of the track now playing.

Rear panel

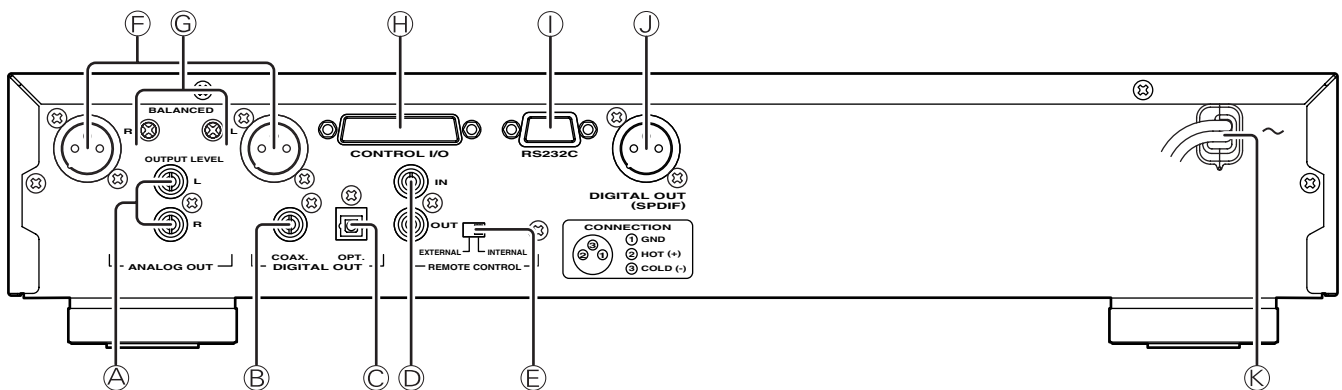

A ANALOG OUT (analog output) connectors

The music signals during play are output from these connectors.

B DIGITAL OUT COAX. (digital coaxial output) connector

The music signals during play are output digitally from this coaxial output connector.

* Digital signals are not output during MP3 file play or pitch control play.

C DIGITAL OUT OPT. (digital optical output) connector

The music signals during play are output digitally from this optical output connector.

* Digital signals are not output during MP3 file play or pitch control play.

D REMOTE CONTROL IN and OUT connectors

Using the remote control connecting cable, these connectors enable this player to be connected to a Marantz component equipped with remote control connectors. These connections make it possible to control an entire system that centers on the amplifier or other such component.

E EXTERNAL/INTERNAL switch

Before the player was shipped from the factory, this switch was set to INTERNAL to enable the remote sensor built into the player to be used.

Before using the connecting cable to make the connection between the player and the remote control connectors on a Marantz equipment, set the switch to EXTERNAL.

Note:

* Signals cannot be received from the remote control unit if the switch is kept at EXTERNAL when the player is to be used on its own.

Ⓕ ANALOG BALANCED OUT (analog balanced output) connector

The signals of the music now playing are output from this connector.

Using an XLR connector cable, connect the connector to a component equipped with an analog balanced input connector.

Note:

*** Before connecting the unit to another component, check that the XLR connectors have the same pin layout.**

If they have a different layout, reconnect the conductors of the XLR connector cable in such a way that the pin layouts match.

Pin layout of the unit's XLR connector pins

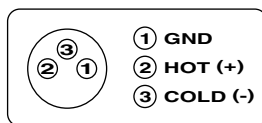

Ⓖ ANALOG BALANCED OUTPUT LEVEL control

This control is used to adjust the output level of the ANALOG BALANCED OUT (analog balanced output) connector.

The output level is increased by turning the control clockwise.

Note:

*** Do not apply excessive force to the control when adjusting it.**

*** The output level and channel balance were adjusted before the unit was shipped from the factory. (Output level: +16 dBu)**

Ⓗ CONTROL I/O (control input/output) connector

This connector is used to connect the remote control input/output signals. For details, refer to "How to use the CONTROL I/O (control input/output) connector" (page 41).

Ⓘ RS-232C connector

Using serial communication, the control signals from the external source and the status information from the unit are output through this connector. For details, refer to "How to use the RS-232C connector" (page 43).

Ⓙ DIGITAL OUTPUT (SPDIF) (digital balanced output) connector

The signals of the music now playing are digitally output through this balanced output connector.

Use an XLR connector cable to connect the connector with a component equipped with a digital balanced input connector.

Digital signals are not output while MP3 files are playing or during pitch control play.

Ⓚ AC POWER SOURCE CONNECTION

With the POWER switch set to the OFF position, plug the mains lead into a mains outlet providing the right voltage.

6. BASIC OPERATIONS

Playing CDs

ENGLISH

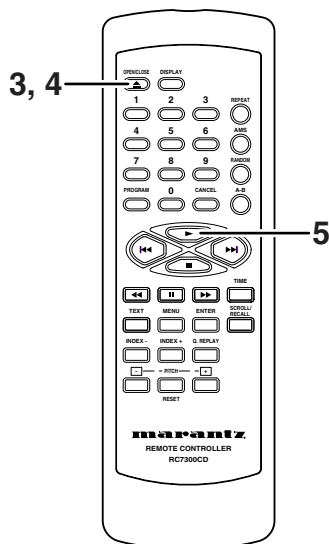
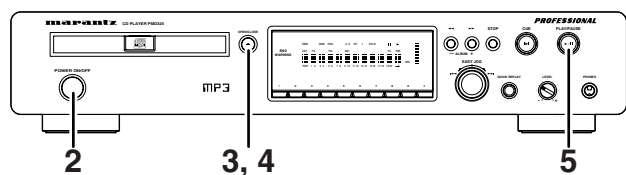

1. Turn on the power of the amplifier to which the player is connected, and use the input selector on the amplifier to select "CD" (the player's input source which has been connected).
2. Press the POWER button on the player to turn on the power.
3. Press the OPEN/CLOSE ▲ button on the player or remote control unit. Place the CD to be played in the extended disc tray while ensuring that the label with the printed text is facing up.

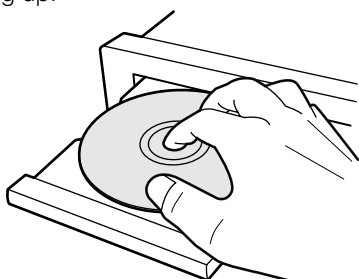

In the case of a single (8 cm) CD, align it with the indentation in the center of the tray.

4. Press the OPEN/CLOSE ▲ button on the player or remote control unit to retract the disc tray. Pushing the front of the disc tray lightly also causes the tray to be retracted. Once the disc tray has been retracted, "TOC Reading" appears on the display, after which the total number of CD tracks and total remaining time are displayed. In the case of a disc that supports CD-TEXT, the album title is displayed, and then the total number of CD tracks and total remaining time are displayed.
5. Press the ►/|| button on the player or ► button on the remote control unit to start play. Adjust the volume level at the amplifier.

• Stopping play

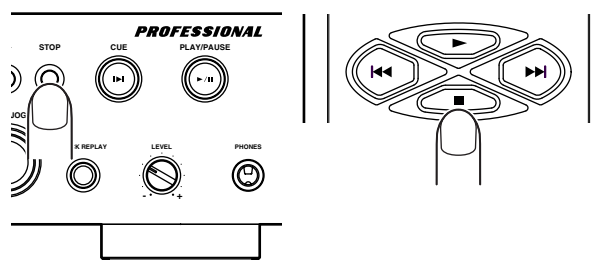

Press the ■ button on the player or remote control unit during play.

• Pausing play

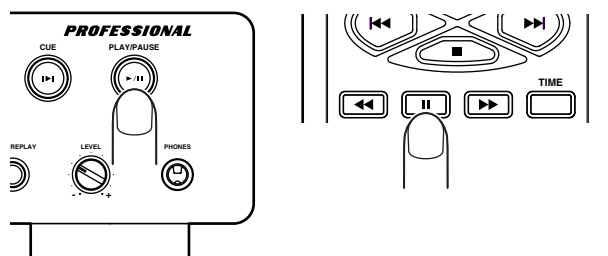

During play, press the ►/|| button on the player or || button on the remote control unit to temporarily suspend play. To resume play from the place where it was temporarily suspended, press the ►/|| button on the player or the ► button or || button on the remote control unit.

• Removing the CD

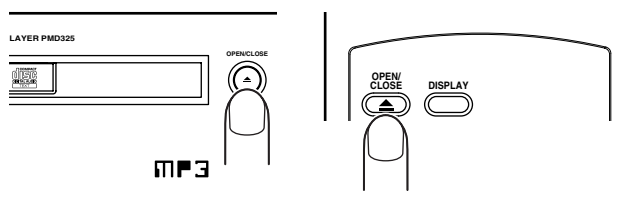

After play has finished, press the OPEN/CLOSE ▲ button on the player or remote control unit to extend the disc tray, and remove the CD.

After the CD has been removed, press the OPEN/CLOSE ▲ button again to retract the disc tray. The disc tray should always be retracted when the player is not in use.

Playing a specific track

• **Specifying the number of a track to be played (direct search)**

Select the number of the track to be played directly by pressing the numeric buttons (0 to 9) on the player or remote control unit.

To select track number 10 or above, use the numeric buttons to select the higher digit first and then select the lower digit. Once the number of the track is selected, play will start automatically.

Example: To play track 3

Press the "3" numeric button.

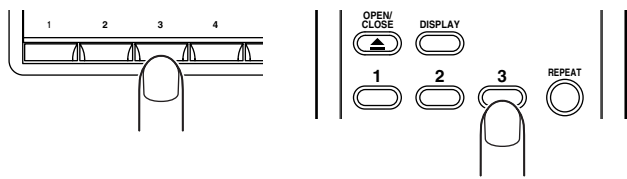

Example: To play track 12

Press the "1" numeric button.

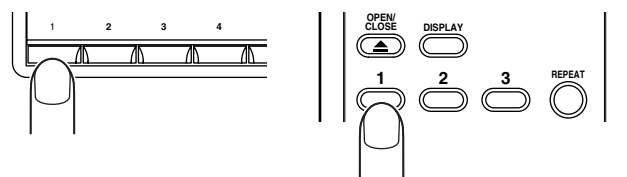

Within 1 second, press the "2" numeric button.

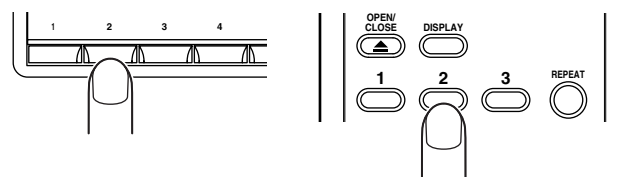

Note:

* If a disc recorded with MP3 files also contains some data files which are not MP3 files, the track before or after the number of the selected track may be played. Direct search is supported only for the album being played.

• **Playing a previous or subsequent track (track skip)**

Advancing to a subsequent track



Press the ►► button on the remote control unit for the number of times equivalent to the number of tracks through which play is to be advanced.

Play can also be advanced to the tracks ahead by turning EASY JOG on the player clockwise. When EASY JOG is no longer turned in the stop mode, the selected track is played after one second elapses.

Returning to the start of the track now playing or a previous track

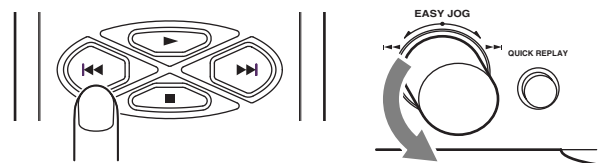

When the ◀◀ button on the remote control unit is pressed, play returns to the start of the track now playing. Play returns to the previous track which is equivalent to the number of times the button was pressed.

In the same way, play can also be returned to the start of the track now playing by turning EASY JOG dial on the player counterclockwise. If it is turned further, play will return to the previous track which is equivalent to the amount by which the dial was turned.

When EASY JOG is no longer turned in the stop mode, the selected track is played after one second elapses.

Note:

* If a disc recorded with MP3 files also contains some data files which are not MP3 files, the track before or after the number of the selected track may be played.

Playing a specific part of a specific track

• **Using the index function (index skip)**

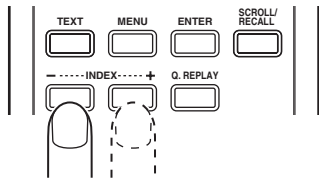

An index search can be performed during the play of a track whose index has been recorded.

This function is useful for starting play at a specific location of a long track. It returns play to a previous index which is equivalent to the number of times the INDEX- button on the remote control unit was pressed; alternatively, it advances play to a subsequent index which is equivalent to the number of times the INDEX+ button on the remote control unit was pressed.

If the index skip function is operated for a CD with no indexes recorded, the “No Index” message appears on the main display, and play returns to the start of the track now playing.

Note:

* **The index skip function cannot be used for discs recorded with MP3 files.**

• **Searching a specific part of a track (search)**

While listening to a track being played, it is possible to search a specific part of that track by a forward or backward search.

Forward searching through the track now playing

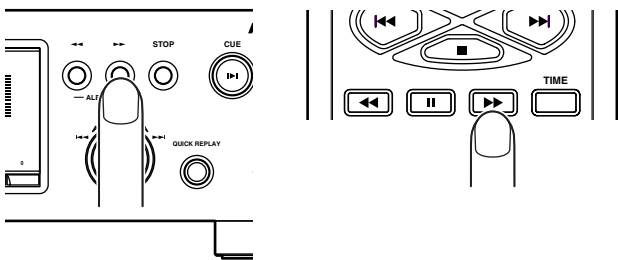

The search (forward search) mode is established by holding down the ►► button on the player or remote control unit. During MP3 file play, play advances to the album title which is equivalent to the number of times the button has been pressed. Holding down the button initiates a forward search.

Backward searching through the track now playing

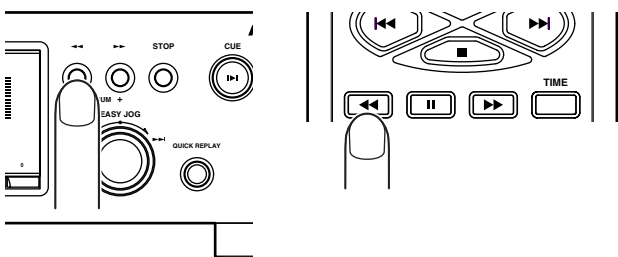

The search (backward search) mode is established by holding down the ◀◀ button on the player or remote control unit. During MP3 file play, play returns to the album title which is equivalent to the number of times the button has been pressed. Holding down the button initiates a backward search. (Returns during backward searches are not constant.)

• **Playing the last few seconds again during play (quick replay)**

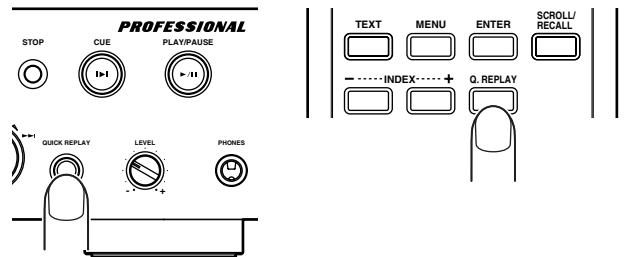

When the QUICK REPLAY button on the player or Q.REPLAY button on the remote control unit is pressed during play, play will be returned by the number of seconds set (factory setting for quick replay time: 10 seconds), and the same section will be played again. With a disc containing MP3 files, it will take some moments for replay to begin.

For details on how to set the quick replay time. (See page 31.)

Note:

* **The quick replay key on the play function menu must be set to “Quick Replay.” (Factory setting: Quick Replay) Refer to “How to set the quick replay key” (page 32).**

• **Listening to the end of a track (end monitor)**

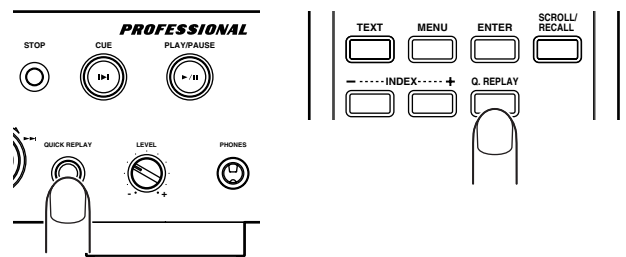

When the unit’s QUICK REPLAY button or the remote controller’s Q.REPLAY button is pressed during play, play is resumed from the position which is before the end position of the track now playing by the number of seconds which have been set (factory setting for quick replay time: 10 sec.).

Note:

* **The quick replay key on the play function menu must be set to “End Monitor.” (Since the key was set to Quick Replay at the factory, set it to End Monitor prior to operation.) Refer to “How to set the quick replay key” (page 32).**

* **With discs recorded with MP3 files, the quick play operation is performed even if the quick replay key is set to “End Monitor.”**

7. ADVANCED OPERATIONS

Repeat play (playing the same tracks repeatedly)

• Playing all tracks repeatedly (all-track repeat)

This function repeatedly plays all the tracks. Repeat play is possible even during random play or program play.

Press the REPEAT button on the remote control unit.

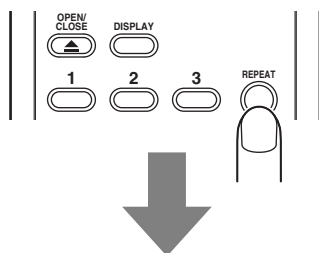

The "RPT" indicator on the display lights, and the repeat play of all the tracks starts.

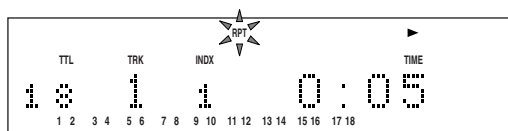

To stop all-track repeat play and resume normal play, press the REPEAT button on the remote control unit twice. The "RPT" indicator on the display goes off.

All-track repeat play can also be initiated using EASY JOG on the player. (See page 29.)

• Playing one track repeatedly (1-track repeat)

This function repeatedly plays one track only. Even during random play or program play, it repeats the track being played. Press the REPEAT button on the remote control unit twice while the track to be repeated is playing.

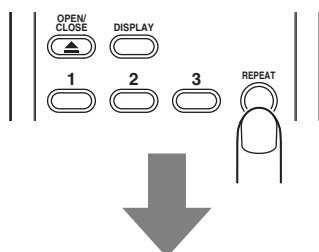

The "RPT" and "1" indicators light, and track now playing is repeated.

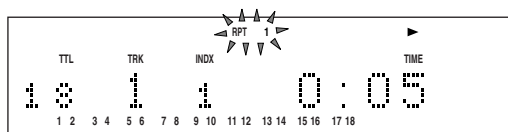

To stop 1-track repeat play and resume normal play, press the REPEAT button on the remote control unit to turn off the "RPT" indicator on the display. 1-track repeat play can also be initiated using EASY JOG on the player. (See page 29.)

• Playing a specific part repeatedly (A-B repeat)

This function repeatedly plays a specific part of a track that you want to hear.

1. During play, press the A-B button on the remote control unit at the start point of the part to be repeated.

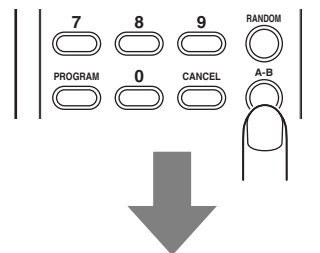

The "A-" indicator on the display now lights.

Display example: A-B repeat, point A (start), track 1, 5 sec.

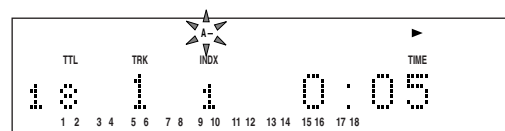

2. Press the A-B button on the remote control unit at the end point of the part to be repeated.

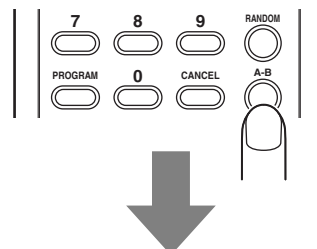

The "A-B" indicator on the display now lights, and the designated part (from point A to point B) is played repeatedly.

Display example: A-B repeat, point B (end), track 1, 20 sec.

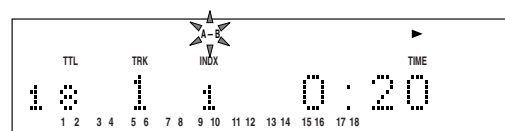

To stop A-B repeat play and resume normal play, press the A-B button on the remote control unit to turn off the "A-B" indicator on the display.

Note:

* The A-B repeat play function cannot be used during random play or program play. Neither can it be used with discs on which MP3 files have been recorded.

Random play (Playing tracks in a random sequence)

This function rearranges the tracks into a random sequence and it then plays all the tracks in this random sequence. If it is used together with repeat play, the same tracks can be repeatedly played but in a different sequence every time.

During play or stop, press the RANDOM button on the remote control unit.

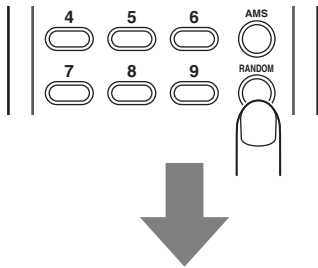

The items on the music calendar appear on the display one after the other, and the "RNDM" indicator lights.

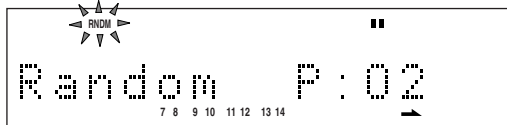

Random play now starts.

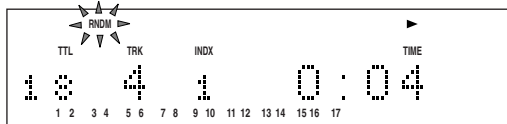

To stop random play and resume normal play, press the RANDOM button on the remote control unit. The "RNDM" indicator on the display goes off.

Random play can also be initiated using EASY JOG on the player. (See page 30.)

• Skipping tracks during random play to search other tracks

When the ►► button on the remote control unit is pressed or EASY JOG on the player is turned clockwise during random play, the next track is selected at random and played. Conversely, when the ◀◀ button on the remote control unit is pressed or EASY JOG on the player is turned counterclockwise during random play, play returns to the start of the track now playing. If the same operation is repeated, play is initiated in the reverse order in which the tracks were played.

AMS play (Searching for a specific track)

This function comes in handy when searching for a specific track that you want to hear.

During stop or play, press the AMS (auto music scan) button on the remote control unit.

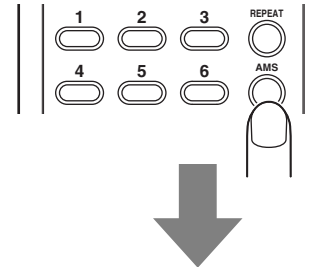

The total number of tracks, track "1" and "SCAN" light on the display, and the "►" indicator flashes.

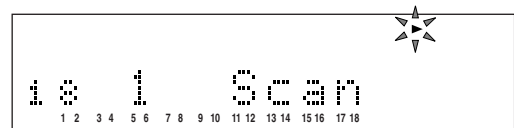

The intros of all the tracks starting from track 1 are played in succession for the duration which has been set (factory setting: 10 seconds).

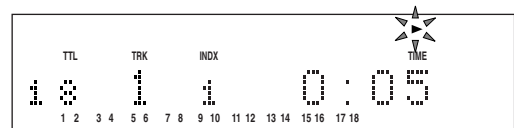

Once the track you want to hear has been found, press the AMS button again. The "►" indicator now lights, and the track found and whatever comes after that track will now be played normally.

When the RANDOM button on the remote control unit is pressed during AMS play, the AMS play function is released, and the random play mode is established.

AMS play can also be initiated using EASY JOG on the player. (See page 31.)

Program play (playing tracks in the preferred sequence)

The order in which the CD tracks are played can be rearranged into the sequence desired. Up to 30 tracks can be programmed.

• Program play in the time display mode

In the case of a CD-TEXT disc, first press the TIME button on the remote control unit to set the main display to the time display mode.

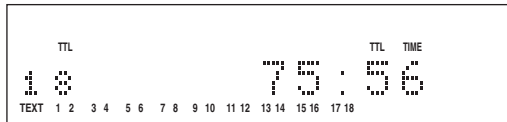
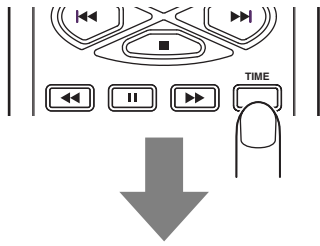

1. During stop, press the PROGRAM button on the remote control unit.

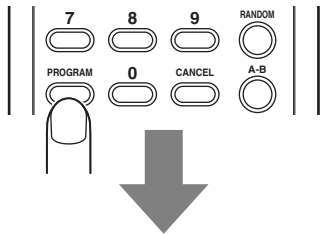

“Program” appears for an instant on the main display.

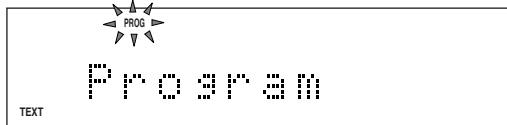

The PROG indicator flashes, and the program mode is established.

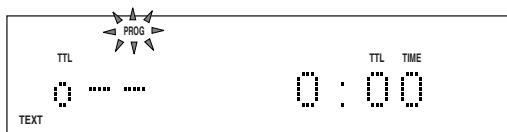

2. Press the numeric buttons on the remote control unit or player that correspond to the track numbers (the tracks can also be selected using the I◀◀ and ▶▶I buttons). To select track number 10 or above, use the numeric buttons to select the higher digit first and then select the lower digit.

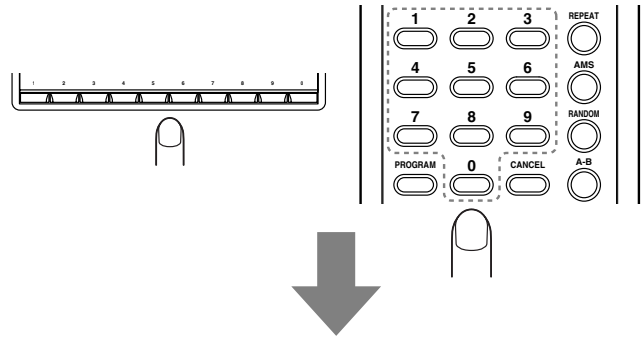

Display example: When track 2 has been selected

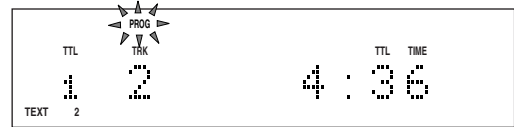

3. Repeat step 2 to program the desired tracks in sequence. At each step of the programming, the number of tracks programmed and their total time appear on the main display. Up to 30 tracks can be programmed.

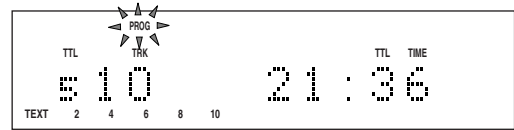

4. Once all the tracks have been programmed, press the ■ button on the player or remote control unit or press the PROGRAM button on the remote control unit.

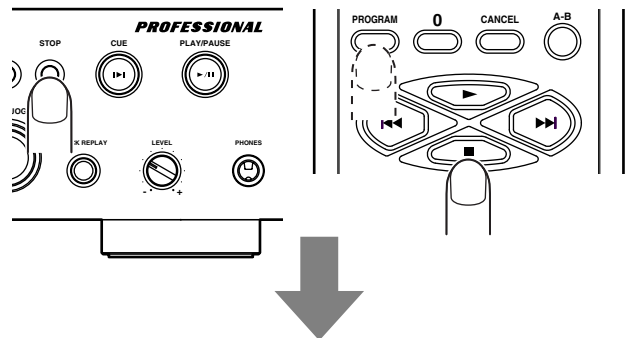

The PROG indicator stops flashing and lights up instead, and the program is entered.

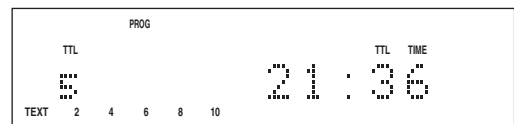

5. Press the ▶/|| button on the player or the ▶ button on the remote control unit. Play now starts in the programmed sequence. Program play will start even when step 4 is omitted. Program play can also be initiated using EASY JOG on the player. (See page 30.)

ADVANCED OPERATIONS

ENGLISH

• Program play in the text display mode

In the case of a CD-TEXT disc, tracks can be selected by title for program play.

If the main display is set to the time display mode, press the TEXT button on the remote control unit to establish the text display mode.

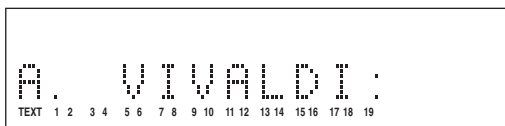
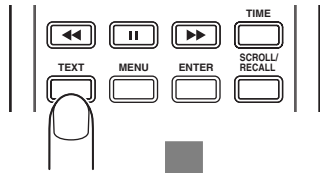

1. During stop, press the PROGRAM button on the remote control unit.

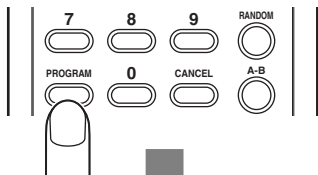

"Program" appears for an instant on the main display. Then the PROG indicator flashes, and the program mode is established.

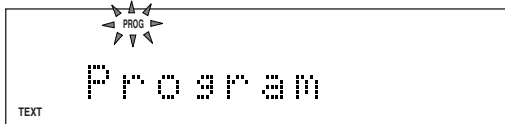

2. Press the ◀◀ and ▶▶ buttons on the remote control unit or use EASY JOG on the player to select the track. (The track can also be selected using the numeric buttons but in this case the title is not displayed).



The title of each selected track is scrolled, and once it has been scrolled, it is programmed automatically. If you do not want to program the track, select another track before the scrolling is completed.

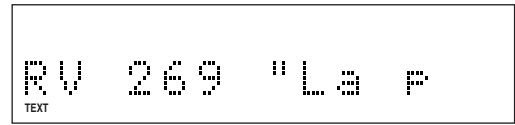

3. Repeat step 2 to program the desired tracks in sequence. Up to 30 tracks can be programmed.

4. Once all the tracks have been programmed, press the ■ button on the player or remote control unit or press the PROGRAM button on the remote control unit.

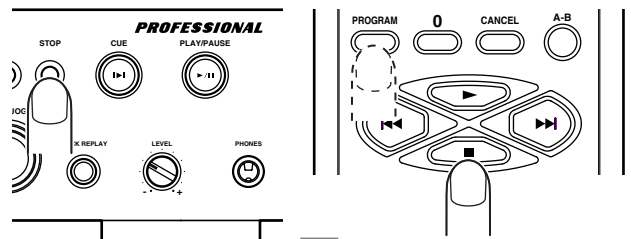

The PROG indicator stops flashing and lights up instead, and the program is entered.

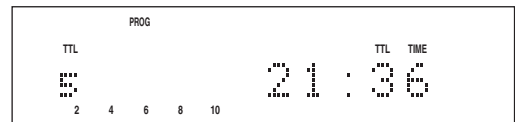

5. Press the ▶/|| button on the player or the ▶ button on the remote control unit. Play of the selected tracks now starts in the programmed sequence. Program play will start even when step 4 is omitted. Program play can also be initiated using EASY JOG on the player. (See page 30.)

Note:

* Programming in the text display mode cannot be performed for tracks which have no text information for their titles.

Delete program play (play with undesired tracks skipped)

This function makes it possible to skip those tracks that you do not want to hear during CD play. Up to 30 tracks can be deleted from the program.

• Delete program play in the time display mode

In the case of a CD-TEXT disc, first press the TIME button on the remote control unit to set the main display to the time display mode.

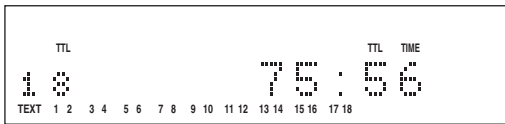
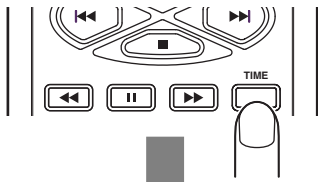

1. During stop, press the PROGRAM button on the remote control unit, and then press the CANCEL button.

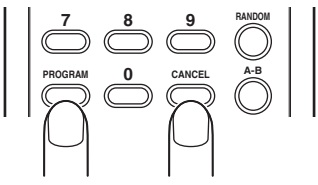

“Delete Prog.” appears for an instant on the main display.

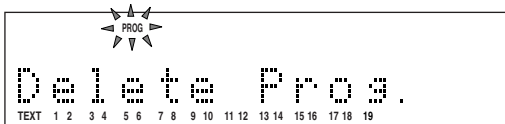

The total number of CD tracks and the total play time appear on the main display, the PROG indicator flashes, and the delete program mode is established.

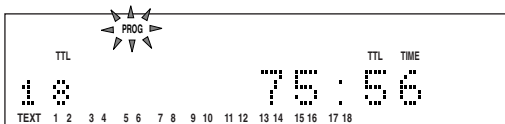

2. Press the numeric buttons on the remote control unit or player that correspond to the track number that you do not want to hear (the track can also be selected using the ◀◀ and ▶▶ buttons).

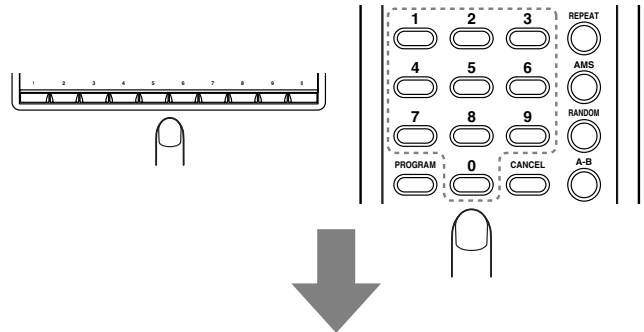

Display example: When track 2 has been selected

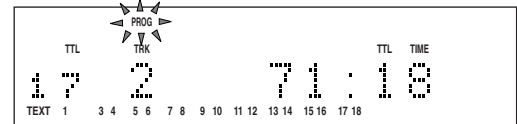

3. Repeat step 2, and upon completion of the programming, press the ■ button on the player or remote control unit or press the PROGRAM button on the remote control unit.

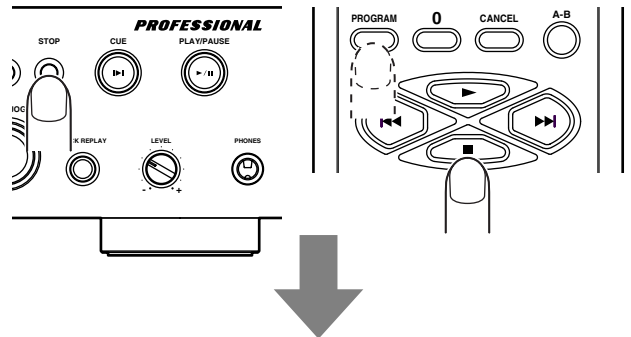

The PROG indicator in the display stops flashing and lights up instead, and the delete program is entered. Up to 30 tracks can be deleted from the program.

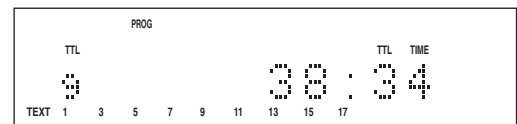

4. Press the ▶/|| button on the player or the ▶ button on the remote control unit. The CD is now played but with the deleted tracks skipped.

Delete program play can also be initiated using EASY JOG on the player. (See page 30.)

• Delete program play in the text display mode

In the case of a CD-TEXT disc, the tracks that are not desired can be selected by title for delete program play.

If the main display is set to the time display mode, press the TEXT button on the remote control unit to establish the text display mode.

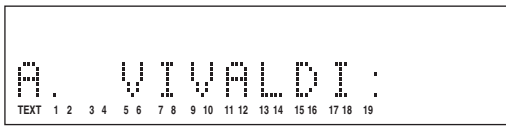
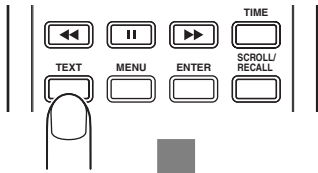

1. During stop, press the PROGRAM button on the remote control unit, and then press the CANCEL button.

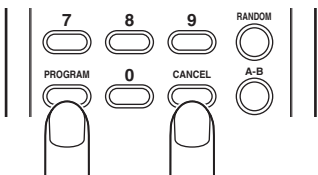

"Delete Prog." appears for an instant on the main display.

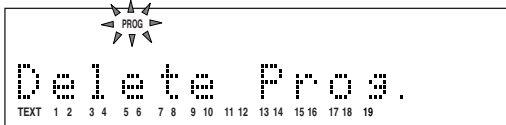

The total number of CD tracks and the album title appear on the main display, the PROG indicator flashes, and the delete program mode is established.

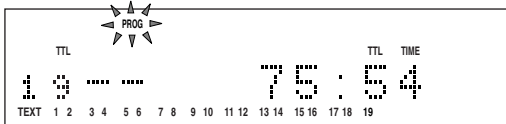

2. Press the ◀◀ and ▶▶ buttons on the remote control unit or use EASY JOG on the player to select the track which you do not want to hear. (The tracks can also be selected using the numeric buttons but in this case the titles will not be displayed.)

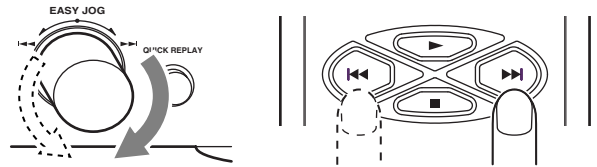

The title of each selected track is scrolled, and once it has been scrolled, it is deleted automatically. If you do not want to delete the track, select another track before the scrolling is completed.

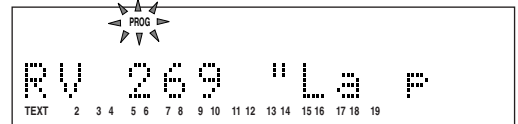

3. Repeat step 2, and upon completion of the programming, press the ■ button on the player or remote control unit or press the PROGRAM button on the remote control unit.

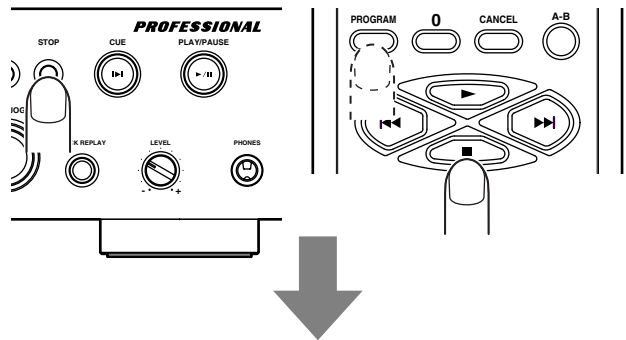

The PROG indicator in the display stops flashing and lights up instead, and the delete program is entered. Up to 30 tracks can be deleted from the program.

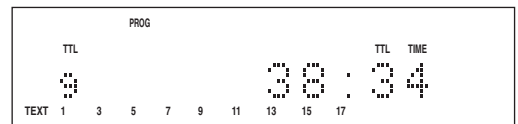

4. Press the ▶/|| button on the player or the ▶ button on the remote control unit. The CD is now played but with the deleted tracks skipped. Delete program play can also be initiated using EASY JOG on the player. (See page 30.)

Note:

* Delete programming in the text display mode cannot be performed for tracks which have no text information for their titles.

ADVANCED OPERATIONS

• Checking the program or delete program contents

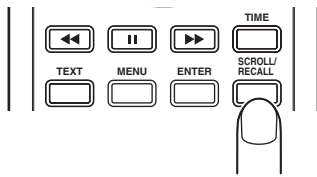

During programming operation or program play, press the SCROLL/RECALL button on the remote control unit.

With program play, the programmed tracks are displayed one after the other in sequence on the main display.

With delete program play, the deleted tracks are displayed one after the other in sequence on the main display.

• Changing the program or delete program contents

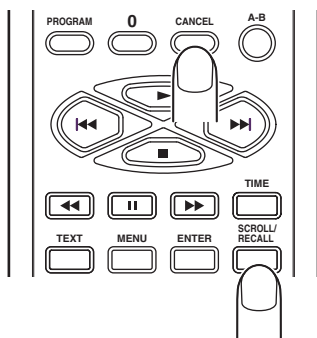

Deleting tracks which were programmed for program play

When the SCROLL/RECALL button on the remote control unit is pressed during programming, the programmed tracks are displayed one after the other in sequence.

As soon as the track to be deleted from the program has appeared, press the CANCEL button on the remote control unit immediately. The number of the deleted track is cleared from the music calendar on the display.

Canceling the deletion of tracks which were deleted for delete program play

When the SCROLL/RECALL button on the remote control unit is pressed during delete programming, the deleted tracks are displayed one after the other in sequence.

As soon as the track whose deletion is to be canceled has appeared, press the CANCEL button on the remote control unit immediately. The number of the track whose deletion was canceled is displayed in the music calendar on the display.

• Returning program play to normal play (canceling the entire program)

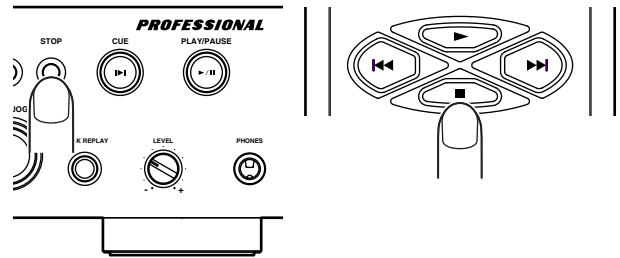

Press the ■ button on the player or remote control unit twice during program play or once during stop. The PROG indicator on the display goes off, and the entire program is canceled.

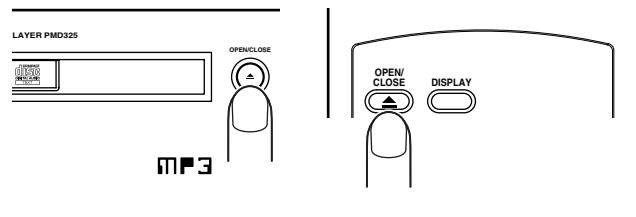

Alternatively, a program can be canceled when the disc tray is opened by pressing the OPEN/CLOSE ▲ button on the player or remote control unit.

Adding tracks to the program

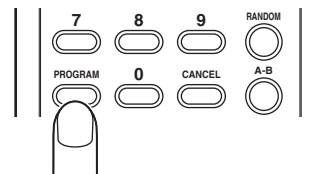

Press the PROGRAM button on the remote control unit during stop. The status of the PROG indicator in the display changes from lighted to flashing, and more tracks can be added to the program.

• Precautions for program and delete program play

- * The program play and delete program play functions cannot be used with discs on which MP3 files have been recorded.
- * When using the numeric buttons to select tracks 1 to 9 on a CD with 10 or more tracks in total, allow 1.5 seconds or so to elapse after the button corresponding to the number of the previous track was pressed before pressing the button corresponding to the number of the next track.
- * When using the numeric buttons to select track 10 or up on a CD with 10 or more tracks in total, press the button corresponding to lower digit within 1.5 seconds or so after the button corresponding to the higher digit was pressed.
- * When using the ◀◀ and ▶▶ buttons for programming, keep pressing one of these buttons with less than half a second or so in between until the number of the desired track is displayed.
- * If the total time for a program exceeds 99 minutes, the time display will appear as “-- : --.”

**Pitch control
(changing the play speed)**

The play speed (pitch) can be changed across a ± 12% range.
* Digital signals are not output during pitch control.

• Increasing the play speed

Press the PITCH+ button on the remote control unit.

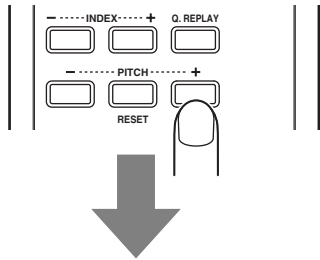

Each time the button is pressed, the play speed is increased in 1% increments (up to a maximum of +12%), and it is displayed on the main display.

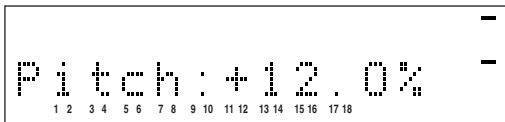

• Reducing the play speed

Press the PITCH- button on the remote control unit.

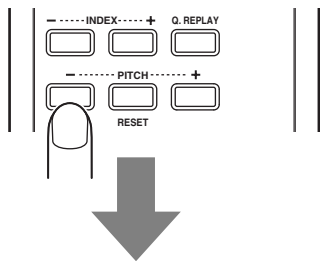

Each time the button is pressed, the play speed is reduced in 1% increments (up to a minimum of -12%), and it is displayed on the main display.

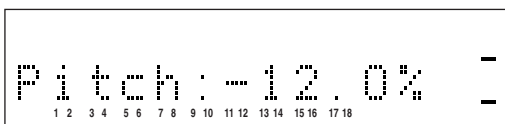

• Returning play to the normal speed (0%)

Press the PITCH RESET button on the remote control unit.

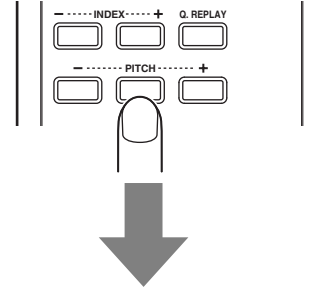

“Pitch: 0%” appears on the main display.

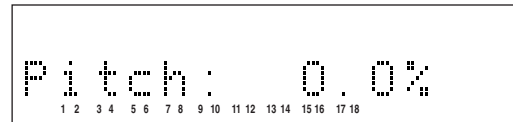

If the PITCH RESET button on the remote control unit is pressed again, play returns to the previous speed setting. Pitch control can also be performed using EASY JOG on the player. (See page 27.)

Setting the position to start listening to play (manual cue)

If the play start position is set ahead of time, you can start listening to the disc from the position which was set at any time.

• Setting the cue point (play start position)

1. Play the part at the approximate position of the cue point which is to be set, and press the ►/|| button to set the unit to the pause mode.
2. Press the CUE button.

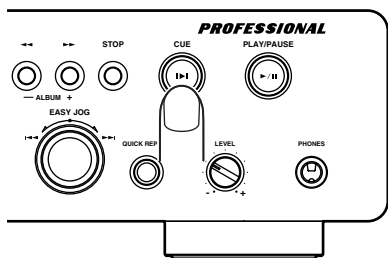

The frame display now appears on the display window, and the cue point setting mode is established.

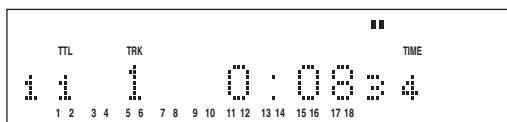

(The index display is cleared at this time.)

3. Turn EASY JOG or press the ◀◀ or ▶▶ button to finely adjust the cue point.
When EASY JOG is turned clockwise, the frames are advanced one at a time; conversely, when it is turned counterclockwise, they are returned one at a time.
When the ▶▶ button is held down, play is set to the fast forward status; conversely, when the ◀◀ button is held down, play is set to the fast backward status.
4. Press EASY JOG to enter the cue point. "Cue Point" appears for an instant on the display window.

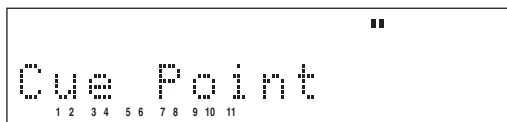

The time at which the cue point was set now flashes, and the unit is set to the pause mode. If the procedure is repeated from step 2 in this mode, a slightly different cue point can now be set.

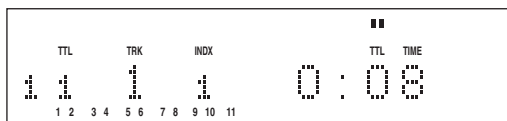

Once the cue point has been set, the position where it was set will be retained in the memory until the power is turned off or the CD is removed. To set a new cue point, repeat the procedure from step 1.

Note:

* The cue point cannot be set if a disc recorded with MP3 files is used.

• Listening from the cue point (play start position)

1. Press the CUE button while operation is stopped or during play. Play now moves to the cue point, and the unit is set to the pause mode.

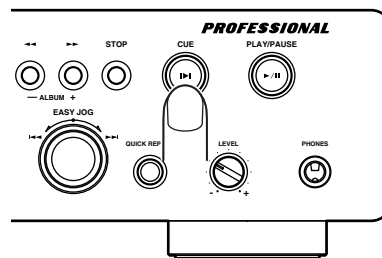

The position where the cue point was set now appears on the display window, and the time flashes.

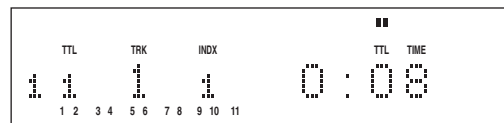

2. Press the ►/|| button. Play now starts from the cue point. Once the cue point has been set, play can be returned to the cue point at any time simply by pressing the CUE point during play.

8. SETTING THE PLAY FUNCTIONS

Using EASY JOG

The front panel of the player features the EASY JOG dial to facilitate a number of different operations to be performed. Under normal circumstances, play re-starts at the start of the previous or subsequent tracks by turning the dial clockwise or counterclockwise. The dial also enables the play functions (play modes) to be set from the menu. The menu can also be operated from the remote control unit.

• Setting the play functions (play modes)

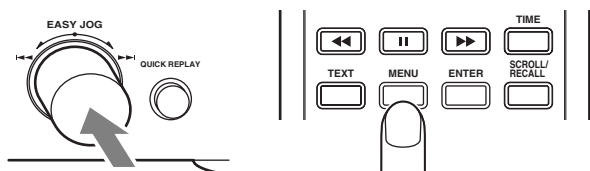

When EASY JOG is pressed or when the MENU button on the remote control unit is pressed, the play function (play mode) setting mode is established.

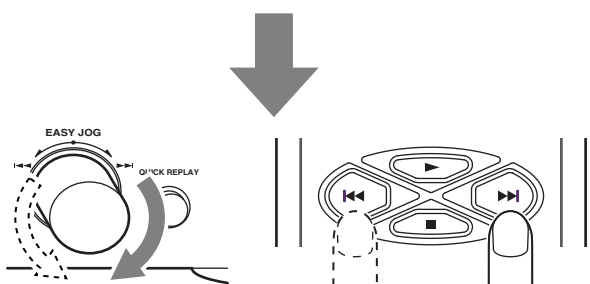

When EASY JOG is turned clockwise or counterclockwise in this mode, the play function menu is switched. The play function (play mode) menu can also be switched by pressing the MENU button or the I◀◀ or ▶▶I button on the remote control unit.

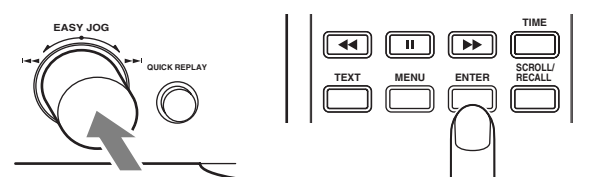

At the desired play function (play mode), either press EASY JOG on the player or press the ENTER button on the remote control unit to select the mode concerned. For subsequent details on the play functions (play modes), refer to pages 27 to 37.

Shown below is the play function (play mode) menu which is switched when EASY JOG is turned.

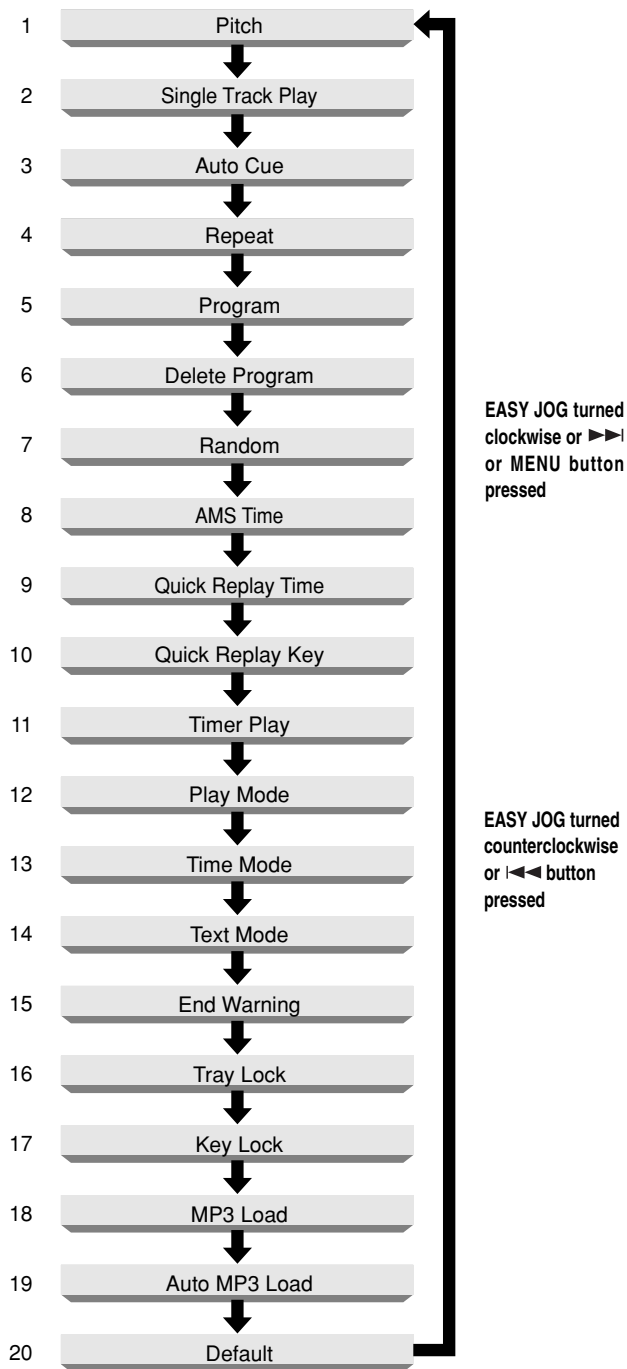

While one of the play functions is being selected, the number of the function as given in the figure above is displayed on the music calendar.

SETTING THE PLAY FUNCTIONS

• Pitch

This function enables the play speed (pitch) to be adjusted within a +/-12% range. The setting is restored to "0%" when the disc is replaced.

1. Press EASY JOG and then turn it so that "Pitch" appears on the main display.

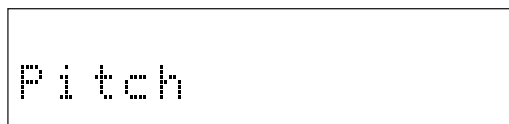

2. Press EASY JOG (or press the ENTER button on the remote control unit) to select Pitch Control.

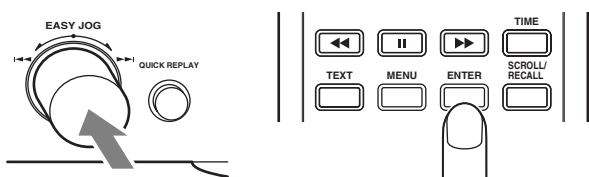

3. Turn EASY JOG (or press the <=> or >>> button on the remote control unit).



The pitch control setting now appears on the main display. The factory setting is 0% but this can be increased (to a maximum of +12%) by turning EASY JOG clockwise or reduced (to a minimum of -12%) by turning it counterclockwise.

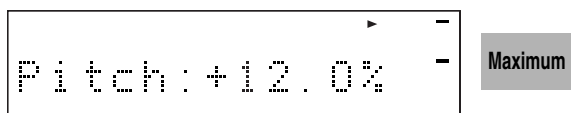
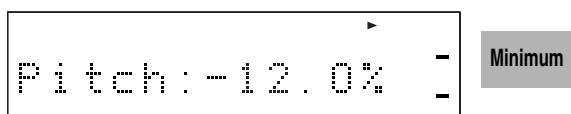

4. Set the play speed (pitch), and press EASY JOG (or press the ENTER button on the remote control unit) to enter the setting.

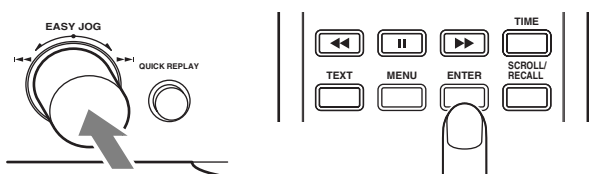

Various play functions (play modes)

• Single Track Play (ON/OFF)

This function enables single play searches which come in handy at such times as practicing musical performances or using the player at broadcast facilities.

1. Press EASY JOG and then turn it so that "Single Play" appears on the main display.

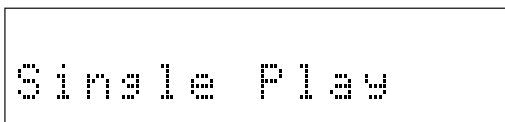

2. Press EASY JOG (or press the ENTER button on the remote control unit) to select Single Track Play.

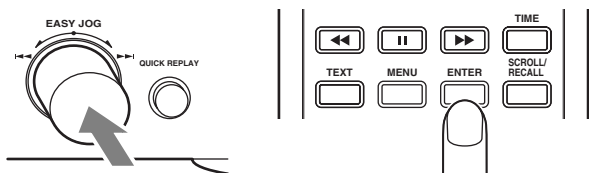

3. Turn EASY JOG (or press the <<< or >>> button on the remote control unit).



The play mode is selected in succession through a 4-step cycle: Single Recue → Single Next → Single Stop → Single Off → Single Recue.

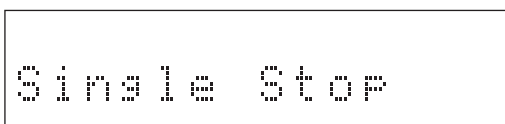
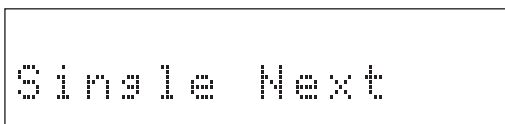
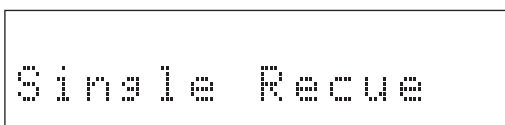

4. When EASY JOG (or the ENTER button on the remote control unit) is pressed, the mode now displayed is entered. When Single Recue, Single Next or Single Stop has been selected, "S.PLAY" lights on the display window.

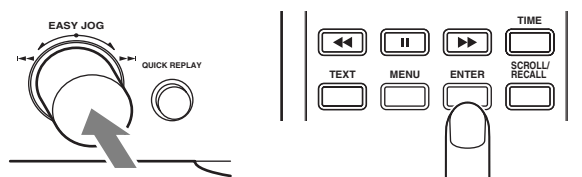

When Single Recue or Single Next is set, play stops temporarily at the start of the track and stands by.

Use the unit's >|| button (or the > or || button on the remote control unit) to start play.

At the Single Recue setting, play stops temporarily at the start of the track now playing when that track is finished, at the Single Next setting, it stops temporarily at the start of the next track when the track now playing is finished; and at the Single Stop setting, play stops when the track now playing is finished.

SETTING THE PLAY FUNCTIONS

Auto Cue (ON/OFF)

This function enables a blank part at the beginning of a track to be skipped and play to start where the sound has been recorded.

1. Press EASY JOG and then turn it to display "Auto Cue" on the main display.



2. Press EASY JOG (or the ENTER button on the remote control unit), and select "Auto Cue."

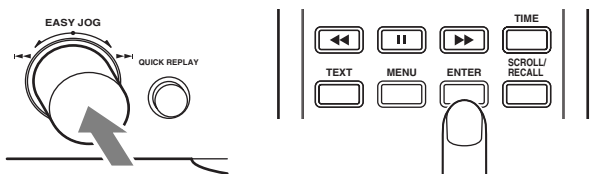

3. Press EASY JOG (or the <=> or >=> button on the remote control unit).



"Auto Cue: ON" and "Auto Cue: OFF" are displayed alternately on the main display.



4. When EASY JOG (or the ENTER button on the remote control unit) is pressed while "Auto Cue: ON" is displayed, the auto cue function is enabled.

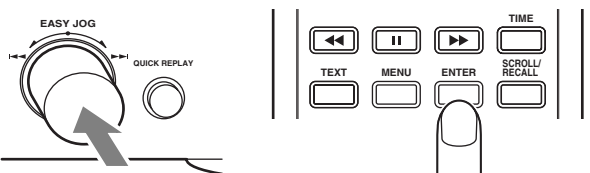

When auto cue is set to ON, the blank part at the beginning of the track is skipped, and the unit is set to the pause mode at the position where the sound is recorded and it stands by for play.

Use the unit's >|| button to start play from the position where the sound is recorded.

Note:

* The auto cue function does not work even when auto cue has been set to ON if a disc recorded with MP3 files is used.

Repeat (ALL/1/OFF)

This function enables some or all of the tracks on a disc to be played repeatedly.

1. Press EASY JOG and then turn it so that "Repeat" appears on the main display.



2. Press EASY JOG (or press the ENTER button on the remote control unit) to select Repeat.

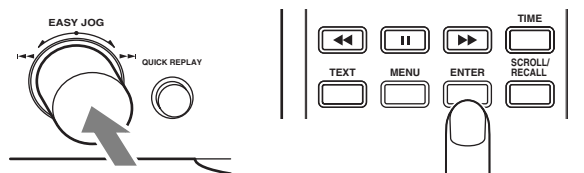

3. Turn EASY JOG (or press the <=> or >=> button on the remote control unit).



The function is switched through three settings: "Repeat:ALL" (all-track repeat) → "Repeat:1" (1-track repeat) → "Repeat OFF" → "Repeat:ALL."



4. Press EASY JOG (or press the ENTER button on the remote control unit) to enter the displayed status.

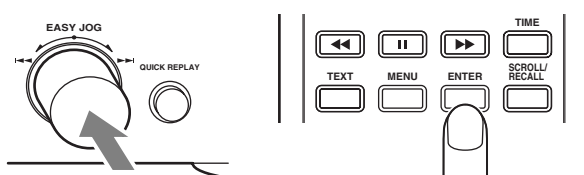

At the "Repeat:ALL" (all-track repeat) setting, all the tracks on the CD are played repeatedly; at the "Repeat:1" (1-track repeat) setting, one track is played repeatedly.

SETTING THE PLAY FUNCTIONS

ENGLISH

• Program

This function enables the tracks to be rearranged into the desired sequence for play.

Press EASY JOG and then turn it so that "Program" appears on the main display.

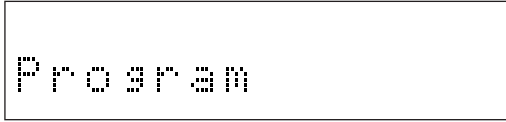

Press EASY JOG (or press the ENTER button on the remote control unit) to select Program.

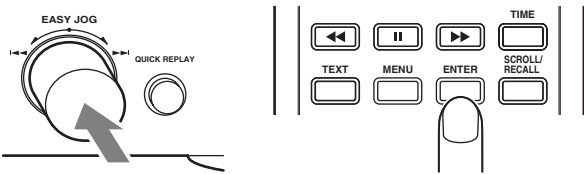

The PROG indicator flashes on the display, and the tracks can be rearranged in the desired sequence. Turning EASY JOG clockwise executes the same function as NEXT ►► (the track number is incremented); conversely, turning it counterclockwise executes the same function as PREVIOUS ◄◄ (the track number is decremented). The program settings are the same as the ones on page 19. The program function cannot be used with discs on which MP3 files have been recorded.

• Delete Program

This function makes it possible to play the CD with the tracks that are not desired skipped.

Press EASY JOG and then turn it so that "Delete Prog." appears on the main display.

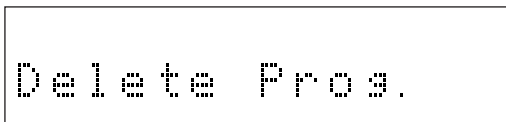

Press EASY JOG (or press the ENTER button on the remote control unit) to select Delete Program.

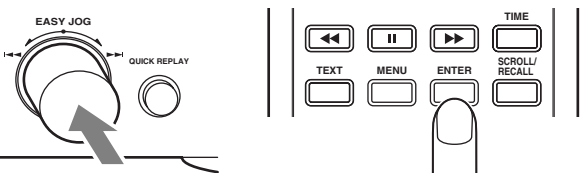

The PROG indicator flashes on the display, the total number of tracks and the total play time are displayed, and the tracks which are not going to be played can be selected. Turning EASY JOG clockwise executes the same function as NEXT ►► (the track number is incremented); conversely, turning it counterclockwise executes the same function as PREVIOUS ◄◄ (the track number is decremented). The delete program settings are the same as the ones on page 21.

Note:

* The delete program function cannot be used with discs on which MP3 files have been recorded.

• Random (ON/OFF)

This function enables the tracks to be rearranged in a random sequence and played.

1. Press EASY JOG and then turn it so that "Random" appears on the main display.

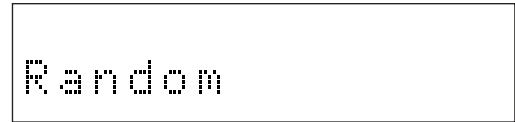

2. Press EASY JOG (or press the ENTER button on the remote control unit) to select Random.

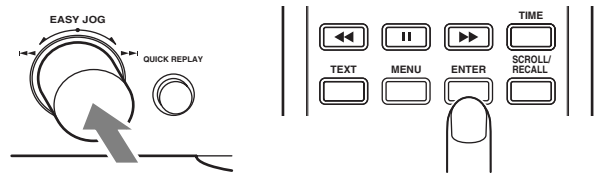

3. Turn EASY JOG (or press the ◄◄ or ►► button on the remote control unit).

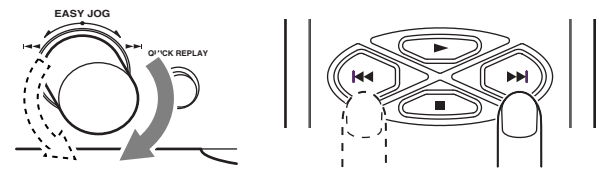

"Random:ON" and "Random:OFF" appear alternately on the main display.

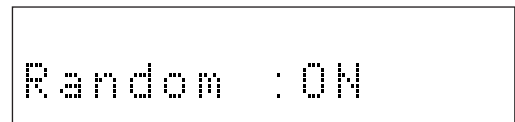

4. When EASY JOG (or the ENTER button on the remote control unit) is pressed while "Random: ON" is displayed, the "RNDM" indicator lights, the tracks are rearranged in a random sequence, and all the tracks are played.

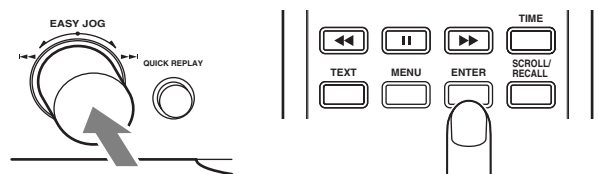

SETTING THE PLAY FUNCTIONS

• AMS (Auto Music Scan) Time

The AMS function enables the intros of all the tracks starting from track 1 to be played for the duration which has been set one after the other. In the case of this player, it enables the intro play time to be set.

1. Press EASY JOG and then turn it so that "AMS Time" appears on the main display.



2. Press EASY JOG (or press the ENTER button on the remote control unit) to select AMS Time.

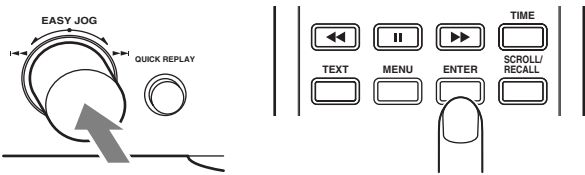

3. Turn EASY JOG (or press the <<< or >>> button on the remote control unit).

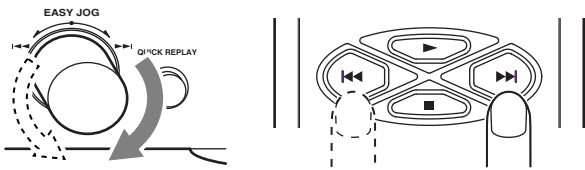

The AMS play time setting now appears on the main display. The factory setting is 10 seconds but this can be increased (to a maximum of 30 seconds) by turning EASY JOG clockwise or reduced (to a minimum of 3 seconds) by turning it counterclockwise.

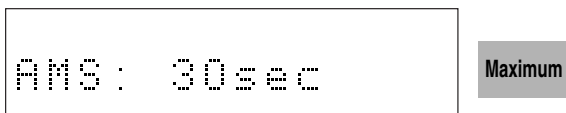
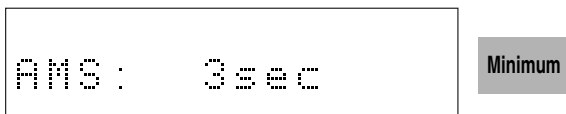

4. Set the time, and press EASY JOG (or press the ENTER button on the remote control unit) to enter the setting and start AMS play.

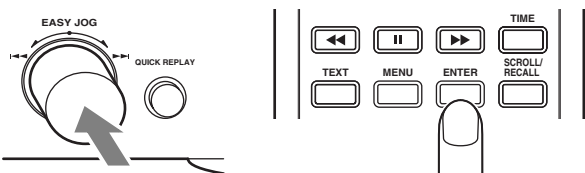

• Quick Replay Time

This is used to set the number of seconds for Quick Replay or End Monitor.

1. Press EASY JOG and then turn it so that "Q.ReplayTime" appears on the main display.

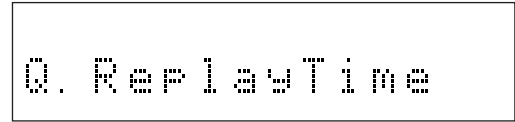

2. Press EASY JOG (or press the ENTER button on the remote control unit) to select Quick Replay Time.

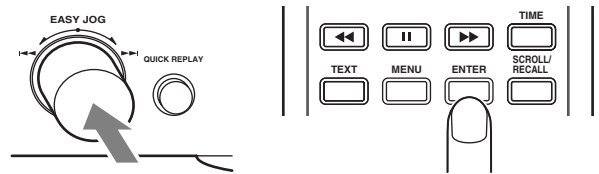

3. Turn EASY JOG (or press the <<< or >>> button on the remote control unit).



The quick replay time setting now appears on the main display. The factory setting is 10 seconds but this can be increased (to a maximum of 30 seconds) by turning EASY JOG clockwise or reduced (to a minimum of 1 second) by turning it counterclockwise.

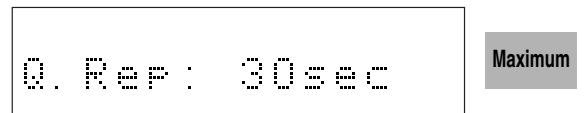
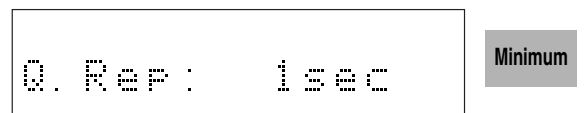

4. When the time (number of seconds) for Quick Replay or End Monitor is set and then EASY JOG (or the ENTER button on the remote control unit) is pressed, the setting is entered.

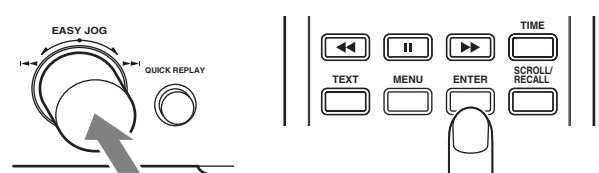

SETTING THE PLAY FUNCTIONS

ENGLISH

• Quick Replay Key (Quick Replay/End Monitor)

This function is used to switch the function when the unit's QUICK REPLAY button (and the Q.REPLAY button on the remote control unit) has been pressed.

1. Press EASY JOG and then turn it to display "Q.Replay" on the main display.

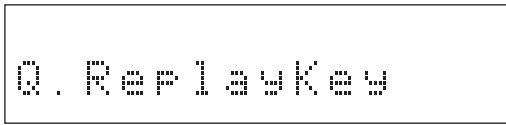

2. Press EASY JOG (or the ENTER button on the remote control unit), and select "Q.ReplayKey."

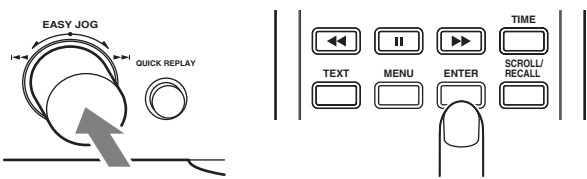

3. Press EASY JOG (or the <<< or >>> button on the remote control unit).



"Quick Replay" and "End Monitor" are displayed alternately on the main display.

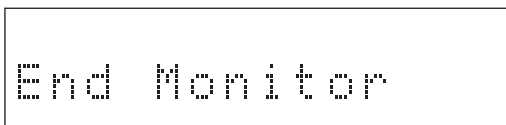
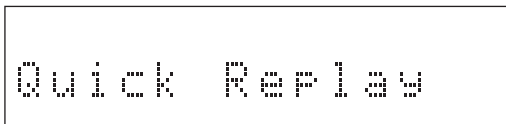

4. When EASY JOG (or the ENTER button on the remote control unit) is pressed, the displayed function is switched to the function of the QUICK REPLAY button (and the Q.REPLAY button on the remote control unit).

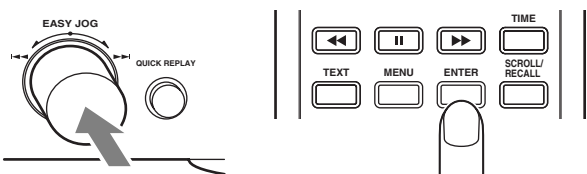

For details, refer to "• Returning a short way during play and listening" and "• Listening to the end of the track" on pages 16.

• Timer Play (ON/OFF)

This function uses a timer available on the market to perform timer play operations where play can be started at a designated time.

1. Press EASY JOG and then turn it so that "Timer Play" appears on the main display.



2. Press EASY JOG (or press the ENTER button on the remote control unit) to select Timer Play.

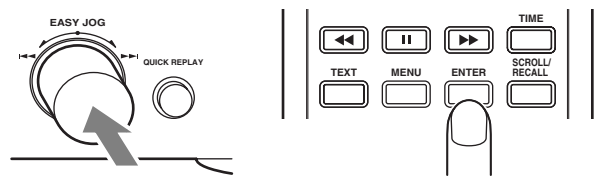

3. Turn EASY JOG (or press the <<< or >>> button on the remote control unit).

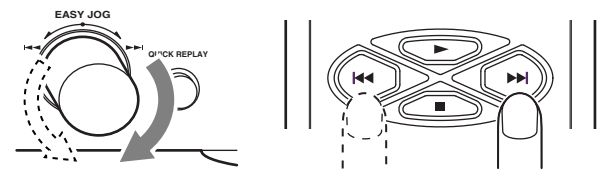

"Timer PLY:ON" and "Timer PLY:OFF" appear alternately on the main display.



4. With "Timer PLY:ON" displayed, press EASY JOG to enter the setting. "TIMER" indicator lights on the display.

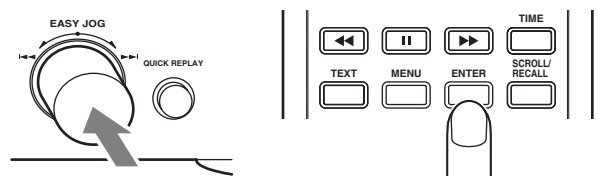

When this function is set to ON and an external timer is connected to the player in such a way that the player's power will be turned on by the timer, play starts as soon as the power is turned on by the timer. This configuration can be used in place of an alarm clock to wake you up in the morning, but make sure that the volume of the sound delivered by the amplifier, etc. is at the appropriate level. At the ON setting, the "auto start" mode is established where play will start at the same time as the power is turned on by the POWER switch as well.

SETTING THE PLAY FUNCTIONS

• Play Mode (Auto Pause/Auto Play)

This function makes it possible to select pause or play at the beginning of a track when performing play or play with a specific track number designation.

1. Press EASY JOG and then turn it to display "Play Mode" on the main display.

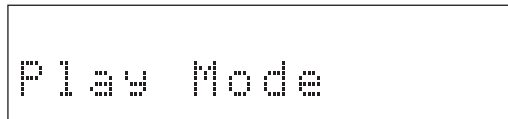

2. Press EASY JOG (or the ENTER button on the remote control unit), and select "Play Mode."

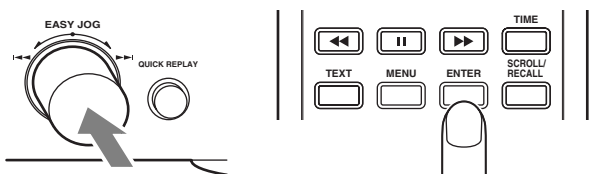

3. Press EASY JOG (or the ◀◀ or ▶▶ button on the remote control unit).



"Auto Pause" and "Auto Play" are displayed alternately on the main display.

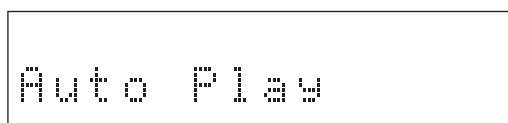
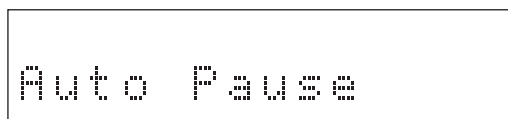

4. When EASY JOG (or the ENTER button on the remote control unit) is pressed, the displayed status is entered.

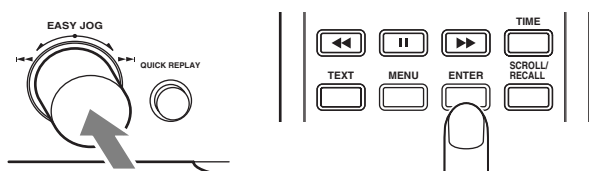

If, when performing play or play with a specific track number designation, Auto Pause has been set, pause is established at the beginning of the track or if Auto Play has been set, play starts immediately at the beginning of the track.

• Time Mode (Track Remain/Total Remain/Track Time/Total Lap)

This function selects what kind of time is to be displayed during play.

1. Press EASY JOG and then turn it to display "Time Mode" on the main display.

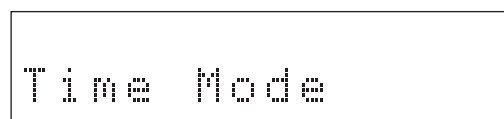

2. Press EASY JOG (or the ENTER button on the remote control unit), and select "Time Mode."

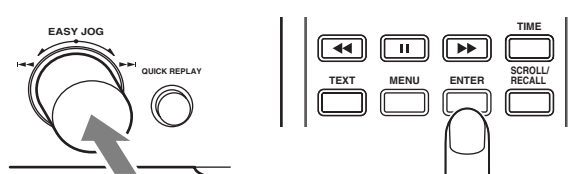

3. Press EASY JOG (or the ◀◀ or ▶▶ button on the remote control unit).



The time mode is selected in succession through a 4-step cycle: Track Remain → Total Remain → Track Time → Total Lap → Track Remain.

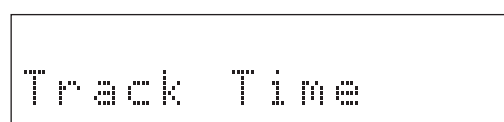
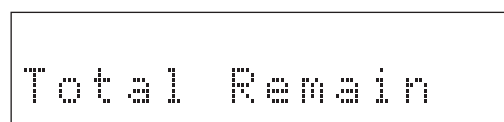
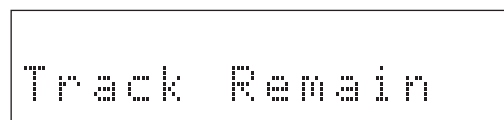

SETTING THE PLAY FUNCTIONS

- When EASY JOG (or the ENTER button on the remote control unit) is pressed, the displayed status is entered.

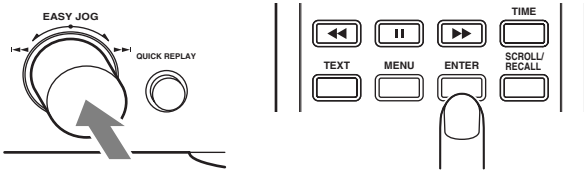

At the Track Remain setting, the remaining time of the track now playing is displayed; at the Total Remain setting, the remaining time of the disc now playing is displayed; at the Total Lap setting, the elapsed time of the disc now playing is displayed; and at the Track Time setting, the elapsed time of the track now playing is displayed.

Note:

* The time mode cannot be changed if a disc recorded with MP3 files is used.

• Text Mode (Auto Text/Title Text/Artist Text/Album Text/Text Off)

This function selects what CD-TEXT or ID3 tag information is to be displayed.

- Press EASY JOG and then turn it to display "Text Mode" on the main display.

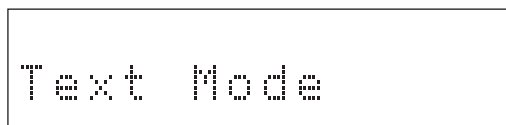

- Press EASY JOG (or the ENTER button on the remote control unit), and select "Text Mode."

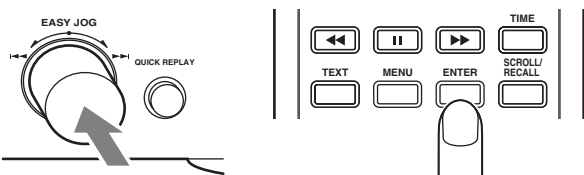

- Press EASY JOG (or the <=> or <=> button on the remote control unit).



The text to be displayed is selected in succession through a 4-step cycle when play is stopped and through a 5-step cycle during play: Auto Text → Title Text (not displayed when play is stopped) → Artist Text → Album Text → Text Off → Auto Text.

No ID3 tag information is displayed when play is stopped if a disc recorded with MP3 files is used.

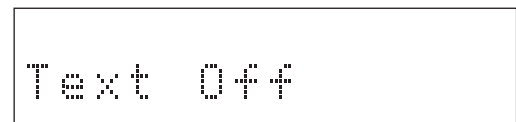
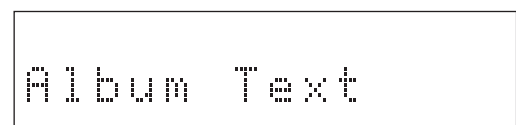
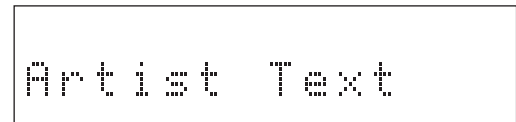
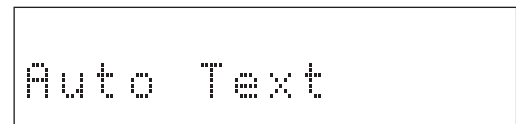

- When EASY JOG (or the ENTER button on the remote control unit) is pressed, the displayed status is entered.

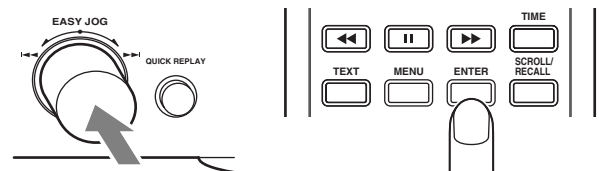

At the Auto Text setting, the album title is displayed when play is stopped and the track title is displayed during play, after which the time display is automatically restored.

At the Title Text setting, the track title is displayed; at the Artist Text setting, the album artist is displayed; and at the Album Text setting, the album title is displayed.

At the Text Off setting, no CD-TEXT or ID3 tag information is displayed, and the time information is displayed instead. For details on CD-TEXT, refer to "Concerning CD-TEXT" (page 38); for details on the ID3 tag, refer to "Concerning MP3" (page 39).

SETTING THE PLAY FUNCTIONS

• End Warning (ON/OFF)

This function uses an indicator to inform you that the end of the track now playing is approaching.

1. Press EASY JOG and then turn it to display "End Warning" on the main display.

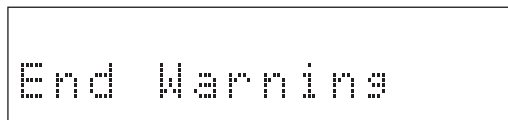

2. Press EASY JOG (or the ENTER button on the remote control unit), and select "End Warning."

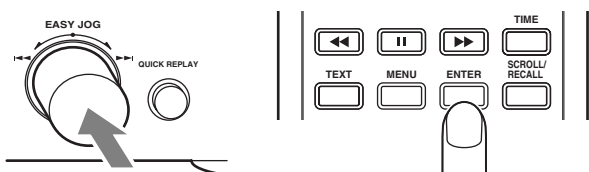

3. Press EASY JOG (or the <=> or >=> button on the remote control unit).

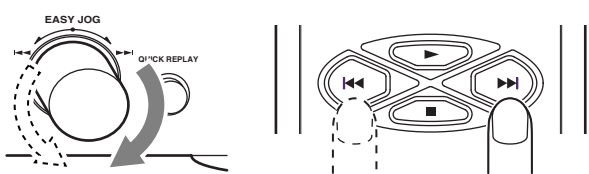

"EndWarn: ON" and "EndWarn: OFF" are displayed alternately on the main display.

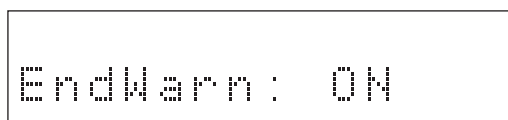

4. When EASY JOG (or the ENTER button on the remote control unit) is pressed while "EndWarn: ON" is displayed, the End Warning function is enabled.

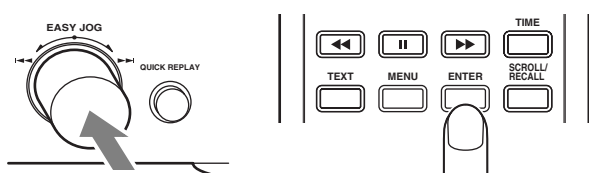

When End Warning is set to ON, the end warning indicator starts flashing 15 seconds before the end of the track now playing is reached to inform you that the end of the track is approaching.

Note:

* The end warning indicator does not flash even when the end warning is set to ON if a disc recorded with MP3 files is used.

• Tray Lock (ON/OFF)

This function prevents the tray from opening during play to safeguard against operational errors.

1. Press EASY JOG and then turn it to display "Tray Lock" on the main display.



2. Press EASY JOG (or the ENTER button on the remote control unit), and select "Tray Lock."

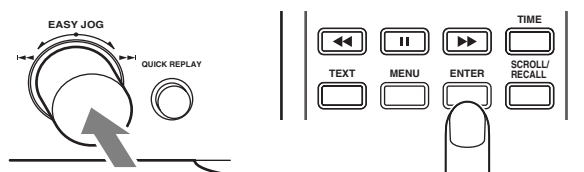

3. Press EASY JOG (or the <=> or >=> button on the remote control unit).



"TrayLock: ON" and "TrayLock: OFF" are displayed alternately on the main display.

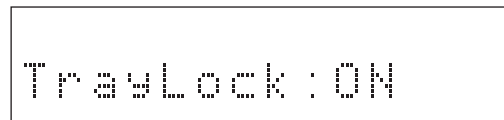

4. When EASY JOG (or the ENTER button on the remote control unit) is pressed while "TrayLock: ON" is displayed, the Tray Lock function is enabled.

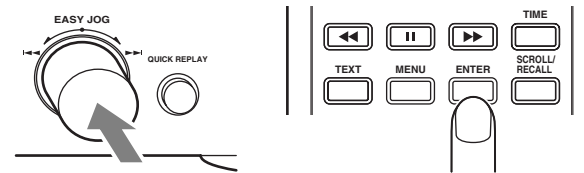

If the Tray Lock is set to ON, the ▲ button on the unit is disabled while playing and pausing. (The button on the remote work.) When this is set, "TrayLocked" appears on the main display to inform you that the tray lock setting is now ON.

SETTING THE PLAY FUNCTIONS

ENGLISH

• Key Lock (ON/OFF)

This function disables the input of the unit to safeguard against operational errors.

1. Press EASY JOG and then turn it to display "Key Lock" on the main display.



2. Press EASY JOG (or the ENTER button on the remote control unit), and select "Key Lock."

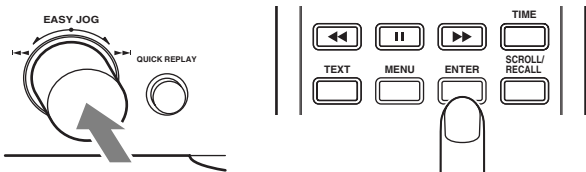

3. Press EASY JOG (or the <=> or >=> button on the remote control unit).

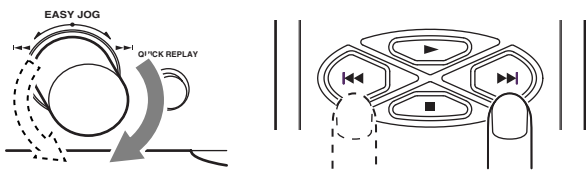

"KeyLock: ON" and "KeyLock: OFF" are displayed alternately on the main display.

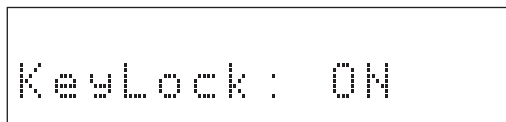

4. When EASY JOG (or the ENTER button on the remote control unit) is pressed while "KeyLock: ON" is displayed, the Key Lock function is enabled.

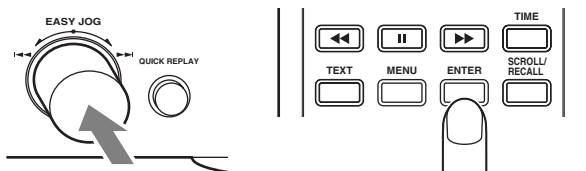

If the Key Lock is set to ON, all the buttons on the unit except the Easy Jog button are disabled. (The buttons on the remote work.) If a button except the Easy jog button is pressed, "KeyLocked" appears on the main display to inform you that the key lock setting is ON.

• MP3 Load

To play a disc recorded with MP3 files, the unit's system must be switched after turning on the power. Once the system is switched, both music CDs and discs with MP3 files can be played until the power is turned off.

The MP3 load function enables the system to be switched manually.

1. Press EASY JOG and then turn it to display "MP3 Load" on the main display.

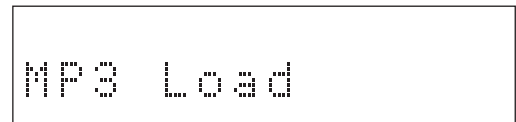

2. Press EASY JOG (or the ENTER button on the remote control unit), and select "MP3 Load."

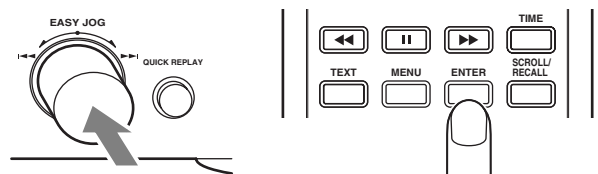

"MP3 Loading" and a bar indicating the system switching status appear on the main display.

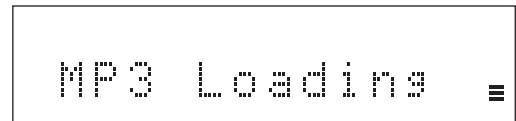

It takes about 40 seconds for the system to be switched. The normal display is restored upon completion of system switching.

SETTING THE PLAY FUNCTIONS

• Auto MP3 Load (ON/OFF)

This function enables the unit's system to be switched automatically in order to play discs recorded with MP3 files.

1. Press EASY JOG and then turn it to display "Auto MP3 Load" on the main display.

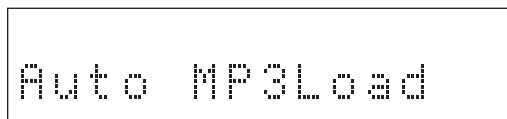

2. Press EASY JOG (or the ENTER button on the remote control unit), and select "Auto MP3 Load."

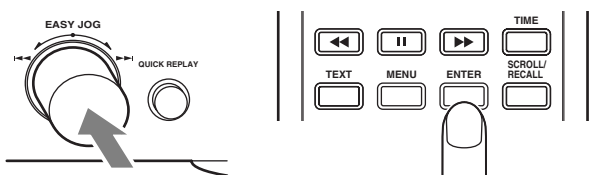

3. Press EASY JOG (or the <<< or >>> button on the remote control unit).



"AutoLoad: ON" and "AutoLoad: OFF" are displayed alternately on the main display.

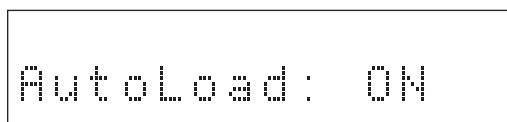

4. When EASY JOG (or the ENTER button on the remote control unit) is pressed while "AutoLoad: ON" is displayed, the auto MP3 load function is enabled.

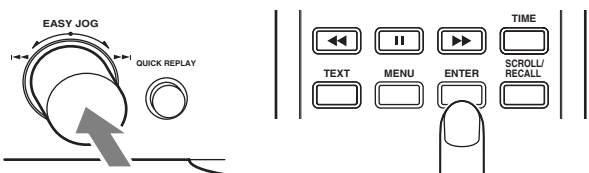

When auto MP3 load is set to ON, the unit's system is switched automatically when the power is turned on. When it is set to OFF, the unit's system is switched when a disc recorded with MP3 files is used.

Alternatively, the unit's system can be switched manually using the MP3 Load, which is a play function. (Page 36) It takes about 40 seconds for the system to be switched. For details on the displays that appear during system switching, refer to "MP3 Load" (on page 36).

• Default

This function enables the data last stored in the memory to be returned to the initial values. For details, refer to "Last Memory" (on page 42).

1. Press EASY JOG and then turn it to display "Init Preset" on the main display.

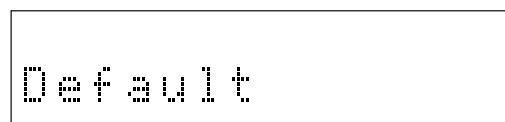

2. Press EASY JOG (or the ENTER button on the remote control unit).

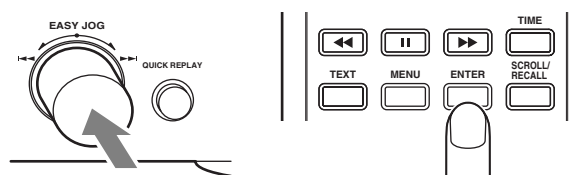

The data last stored in the memory is returned to the initial values, and the main display is restored to the normal display. The table below lists the initial settings.

Play function	Initial setting
Pitch Control	0.0%
Single Track Play	Single off
Auto Cue	Auto Cue off
Repeat	Repeat off
AMS Time	10 Sec
Quick Replay Time	10 Sec
Quick Replay Key	Quick Replay Key
Timer Play Mode	Timer Play off
Play Mode	Auto Pause
Time Mode	Track Remain
Text Mode	Auto
End Warning	End Warning off
Tray Lock	Tray Lock off
Key Lock	Key Lock off
Auto MP3 Loading	Auto Loading off

9. OTHER FUNCTIONS

Last memory

This function stores the play function settings even after the power has been turned off.

The settings that can be stored include "AMS Time," "Quick Replay Time" and "Timer Play."

The data that can be stored in the memory is listed below.

"Pitch", "Single Track Play Mode", "Repeat Mode", "AMS Time", "Quick Replay Time", "Quick Replay Key", "Timer Play Mode", "Play Mode", "Auto Cue Mode", "Time Mode", "Text Mode", "End Warning", "Tray Lock", "Auto MP3 Load", "Key Lock"

CD-TEXT

"CD-TEXT" refers to a new kind of music disc which differs from a conventional music disc in that album titles, track titles and other text information are recorded on it. CDs with the following logos support this function.



The text information is recorded on those parts which were not used by conventional music CDs.

This means that discs with recorded CD-TEXT can be played in the same way as in the past on existing CD players but the text information can be viewed only when they are played on a player that supports CD-TEXT.

This player automatically identifies whether a disc supports CD-TEXT, and it displays the information on the display.

Display of player

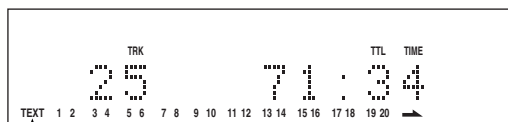

This lights when the disc that has been read is identified as supporting CD-TEXT.

The following items of the text information on CD-TEXT discs can be displayed in sequence by pressing the TEXT button on the remote control unit.

CD-TEXT can be displayed also with the Text Mode play function setting.

For details, refer to page 34.

However, the recorded information differs from one disc to another so that not all the information given below will necessarily be displayed. Items not recorded are automatically omitted and skipped by the player, and only the existing items are displayed.

• During play

Each time the TEXT button on the remote control unit is pressed, the information items are displayed in the following sequence. During play, the information of track now playing is mainly displayed.

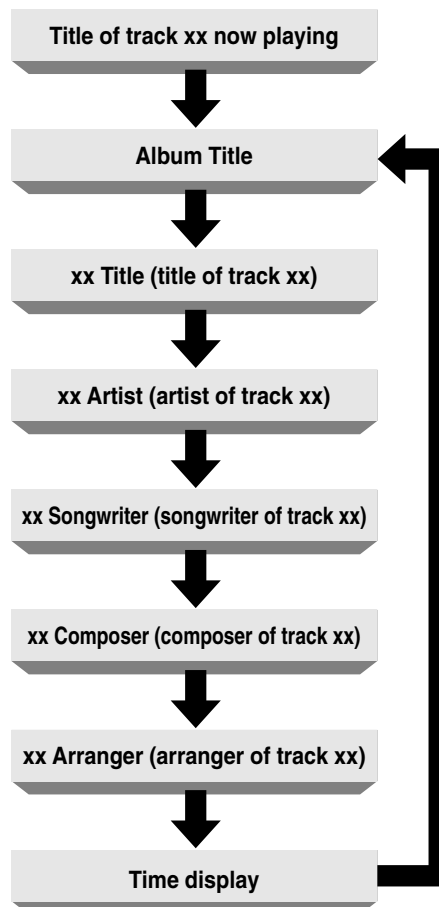

• In the stop mode

Each time the TEXT button on the remote control unit is pressed, the information items are displayed in the following sequence. When the ► button is pressed while "-- Title" is displayed, the track concerned starts playing. The maximum of characters that can be displayed is 64.

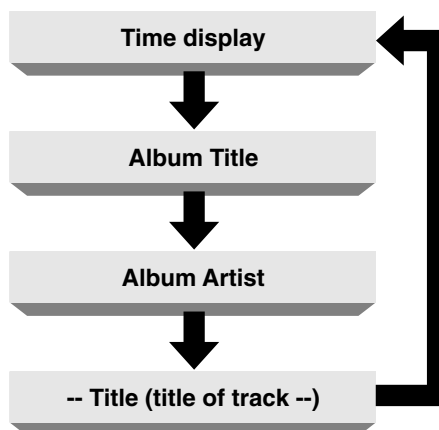

CR-R/CD-RW disc play

In addition to conventional music CDs and CD-R (recordable) discs, this player can also play CD-RW (rewritable) discs. It also supports the unfinalized discs that cannot be played by regular CD players.

• **Playing unfinalized CD-R/CD-RW discs**

CD players normally play only those discs on which the TOC information (*) has been recorded. This means that in order for a CD player to play a CD-R/CD-RW disc with music recordings, the disc had to be "finalized" by writing the TOC information onto it.

Discs for which this finalizing job has not been done are called unfinalized discs, and this player is designed to support the play of these unfinalized discs as well.

Consequently, even CD-R/CD-RW discs on which more material is to be recorded can be enjoyed without further ado using this player.

* "TOC" stands for the table of contents which contains the total number of tracks, the total play time and other such information on the disc. This information has been recorded on the inner circumference area of the disc.

• **Precautions for unfinalized CD-R/CD-RW discs**

Take care not to scratch or dirty the area near the innermost circumference of unfinalized CD-R/CD-RW discs. Scratches, dirt or other abnormalities in this area may make it impossible for the disc to be read.

On unfinalized CD-R/CD-RW discs recorded using a CD recorder for audio applications, provisional TOC information is recorded in the PMA area (*) which is further inside from the TOC information area. This player supports unfinalized discs by reading the information in the PMA area, but because this area is extremely narrow, any scratches, dirt or other abnormalities here may make it impossible for discs to be read.

On some discs, this area may be very difficult to read. In cases like this, use the disc after using a CD recorder to do the finalizing. It is recommended that the finalizing be done before scratches or dirt makes it hard for the discs to be read.

* "PMA" stands for program memory area, and it refers to the area where the provisional contents information such as the number of tracks and play times recorded on the CD-R/CD-RW discs is recorded. Discs cannot be played by this player unless the PMA has been recorded properly.

* This player supports the discs which have been recorded by any recorder that complies with the "Orange Book" of CD-R/CD-RW standards.

* The player can play only those discs recorded in the music format (CD-DA) or using MP3 files.

* If there is not much recording time, it may be difficult for the data to be read out, and it may cause error.

* When the player is to play a CD-RW disc or unfinalized CD-R/CD-RW disc, it automatically recognizes the type of disc, and changes some of its internal settings to suit the disc concerned. For this reason, the disc reading process will take a little longer compared with regular music CDs or CD-R discs.

MP3

This player can play CD-R/CD-RW discs as well as discs available on the market recorded using MP3 files (*).

The ID3 tag (*) is supported by this player. The album title, track title and name of the artist can be displayed for the track (file) on which the ID3 tag information has been recorded.

* "MP3" refers to music data which has been compressed by a file format known as "MPEG-1 Audio Layer 3." Files with the ".mp3" or ".MP3" extension are called MP3 files.

* "ID3 tag" refers to a format which adds the album title, track titles, names of the artists and other text information to the MP3 files.

• **MP3 file playback**

Playing albums in sequence

1. As with a music CD, place the disc recorded using the MP3 files on the disc tray, and retract the disc tray.

2. Press the ►/|| button on the player or the ► button on the remote control unit. Play now starts in sequence from the first album (on a folder by folder basis (*)). (See next section.)

* With a disc recorded with MP3 files, it takes about 40 seconds after the player's power has been turned on for the player's system to be switched before initial play.

Selecting and playing albums (folders)

Select the desired album (on a folder by folder basis (*)) using the ◀◀ or ▶▶ button on the player or remote control unit. Play now starts in sequence from the selected album. The album number appears on the display. (AL xxx)

• **Displaying the ID3 tag information**

The following display appears when the TEXT button on the remote control unit is pressed while playing an MP3 file disc on which the ID3 tag information has been recorded.

During play

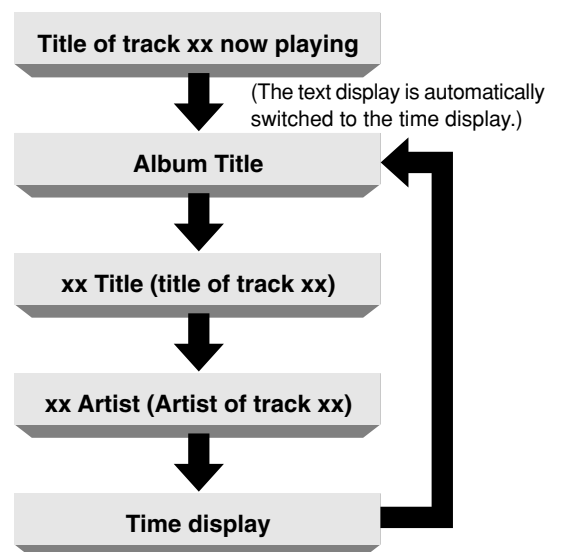

* Those items among the display information which were not recorded are skipped, and only the recorded items are displayed.

During stop

The ID3 tag information is not displayed during stop.2

OTHER FUNCTIONS

• Precautions for discs recorded using MP3 files

- * The format of the files played have the “.mp3” or “.MP3” extension. Files with any other extension cannot be played.
- * The Joliet file system, an extension to the ISO9660 file format, is supported as the write format. Both mode 1 (CD-ROM) and mode 2 (CD-ROM XA) are supported. MP3 file discs recorded using packet writing cannot be played.
- * The supported MP3 file sampling frequency is 16 kHz – 48 kHz and the bit rate is 32 kbps – 320 kbps. 44.1kHz, 128kbps are recommended for the unit.
- * The maximum number of characters in the ID3 tag information that can be displayed by this player is 32. Characters other than alphanumeric characters will not be displayed properly. Japanese characters cannot be displayed.
- * Digital signals are not output from the player while playing discs recorded using MP3 files.
- * It may not be possible for CD-R/CD-RW discs on which MP3 files were recorded to be played properly depending on the environment of the personal computer used to record the files, the writing software program and the CD-R/CD-RW discs concerned. Check the external components used.
- * MP3 files on mixed CDs or enhanced CDs containing a mixture of the CD-DA format for music purposes and MP3 files cannot be played. Only the CD-DA format for music purposes will be played.
- * This player also supports discs created by multisessions.
- * It is recommended that the maximum number of sessions on a CD-R or CD-RW disc be 10, the maximum number of albums for all sessions be 20 and the maximum number of files be 200.

• Functions not supported by MP3 play

The following functions are not supported when the player is to play discs recorded with MP3 files.

- A-B repeat
- Program play
- Delete program play
- Index skip
- End monitor
- Manual cue
- Auto cue
- Time mode changes
- End warning

• Concerning random play

Random play proceeds on an album by album (folder by folder) basis. When all the tracks of the album currently playing have been played, play moves on to the next album in the sequence.

During random play, the 1-track repeat and A-B repeat functions cannot be used.

• Example of play sequence

Diagram showing sequence as displayed by Windows Explorer

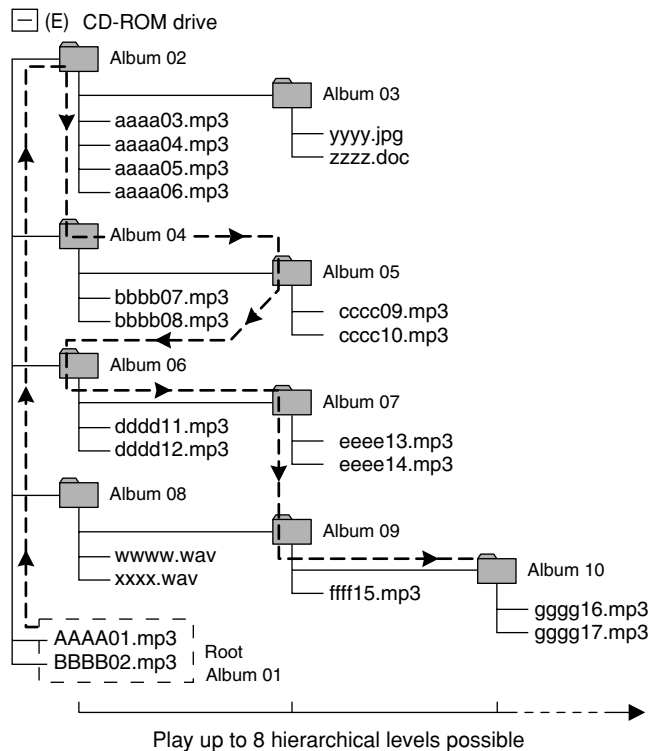

Display that appears when the disc shown above is inserted (in the stop mode)

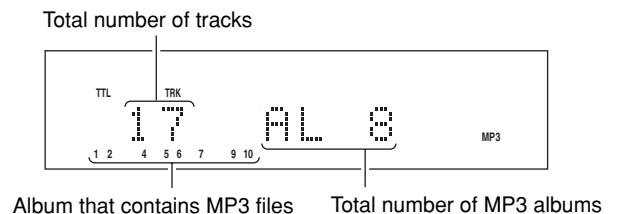

- The dotted line with arrow (· → ·) indicates the sequence in which the MP3 albums and tracks are played.
- Album 01 to album 10
In the example shown in the figure, this CD-ROM has 10 albums (folders) but albums 03 and 08 are not MP3 files and so cannot be played.
- AAAA01.mp3 to gggg17.mp3
In the example shown in the figure, this CD-ROM has 17 tracks starting with track “01” and ending with track “17.”
- Only those files with the “.mp3” extension are played; all other files with the .wav, .jpg, .doc and other extensions are skipped.
- Album 01 is allocated even when there are no files in the root.
- The sequence may differ from the one that appears on the personal computer. It may also differ depending on the writing software program.

How to use the CONTROL I/O (control input/output) connector

This input/output connector (D-Sub 25-pin female) is used for remote control.

Contact circuits (switches, etc.) can be connected to each of the input and output pins.

In addition, by connecting displays, etc. to the output pins, statuses can be monitored from a distance.

Notes:

- * Use the tally power supply at pin 12 at a total load current of less than 80 mA.
- * Use a D-Sub 25-pin male (4-40UNC for the screw part) connector as the compatible connector.
- * Refer to the example of the connections shown in the figure on the right to connect a cable to the CONTROL I/O connector.

Example of CONTROL I/O (input/output) connections

When using pin 4 (FADER NORMAL)

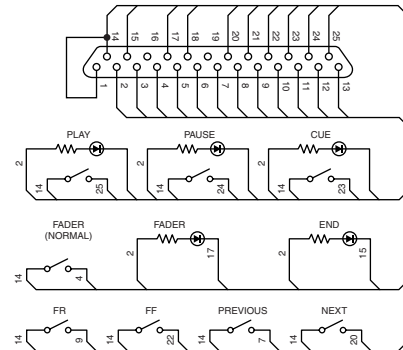

When using pin 16 (FADER INVERT)

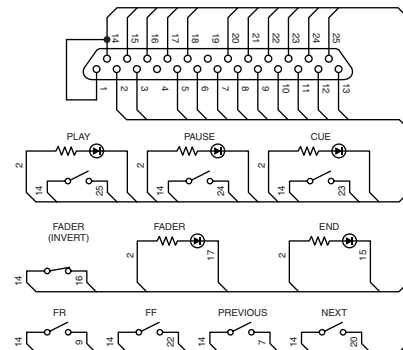

Table showing CONTROL I/O signal layout

Pin no.	Signal	I/O	Function	Port specification
1	FG	-	Frame GND	-
2	TALLY POWER SUPPLY	-	Tally power supply	+5V, I _{max} =80mA
3	QUICK REPLAY	I	Identical to QUICK REPLAY button	CMOS
4	FADER NORMAL	I	Refer to page 42 (fader start)	CMOS
5	PITCH ON OFF	I	Identical to PITCH RESET button on remote control unit	CMOS
6	PITCH+	I	Identical to PITCH+ button on remote control unit	CMOS
7	PREVIOUS	I	Identical to ◀◀ button	CMOS
8	INDEX-	I	Identical to INDEX- button on remote control unit	CMOS
9	FR	I	Identical to ◀◀ button	CMOS
10	STOP	I	Identical to ■ button	CMOS
11	CUE TALLY	O	ON when CUE point is set	I _i <20mA
12	PAUSE TALLY	O	ON during pause	I _i <20mA
13	PLAY TALLY	O	ON during play	I _i <20mA
14	TALLY COMMON	-	Tally GND	-
15	END TALLY	O	Identical to END WARNING indicator	I _i <20mA
16	FADER INVERT	I	Refer to page 42 (fader start)	CMOS
17	FADER TALLY	O	ON during fader play	I _i <20mA
18	PITCH-	I	Identical to PITCH- button on remote control unit	CMOS
19	N.C.	-	Not used	-
20	NEXT	I	Identical to ▶▶▶ button	CMOS
21	INDEX+	I	Identical to INDEX+ button on remote control unit	CMOS
22	FF	I	Identical to ▶▶▶ button	CMOS
23	CUE	I	Identical to ▶▶▶ button	CMOS
24	PAUSE	I	Identical to button	CMOS
25	PLAY	I	Identical to ▶ button	CMOS

OTHER FUNCTIONS

ENGLISH

Fader start

When the fader start switch incorporated into a component such as a mixer board or mixing console or an external switch is connected to the fader start jack, play/pause control can be exercised by opening and closing the switch.

When using CONTROL I/O connector pins 4 (FADER NORMAL) and 14 (TALLY COMMON)

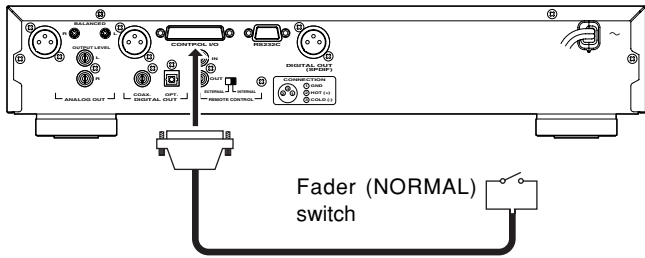

Fader start polarity	
Play	Closed
Pause	Open

When using CONTROL I/O connector pins 16 (FADER INVERT) and 14 (TALLY COMMON)

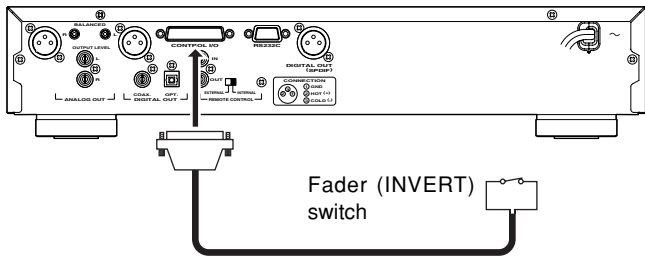

Fader start polarity	
Play	Open
Pause	Closed

Remote control codes

This unit receives the codes listed in the table below from the infrared remote sensor on the front panel and the remote control connector on the rear panel, and it performs the operations that correspond to those codes.

Remote control codes (RC5)

Command	CODE
0	2000
1	2001
2	2002
3	2003
4	2004
5	2005
6	2006
7	2007
8	2008
9	2009
Time	2011
Recall/Scroll	2015
Random	2028
Repeat	2029
Next	2032
Previous	2033
Index +	2034
Index -	2035
Pitch Reset	2037
Pitch +	2038
Pitch -	2039
Program	2041
AMS	2043
Open/Close	2045
Pause	2048
Cancel	2049
Search Rev	2050
Search FF	2052
Play	2053
Stop	2054
A-B	2059
Display (Dimmer)	2071
Menu	2082
Enter	2087
Text	2088
Edit	20104
Quick Replay	205304

OTHER FUNCTIONS

How to use the RS-232C connector

This input/output connector (D-Sub 9-pin female) is used for RS-232C external control.

A straight cable available on the market can be connected to this connector to exercise external control and send status information.

Connector pin assignment

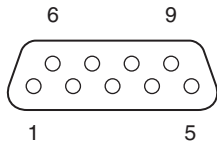

1	NC
2	TX
3	RX
4	NC
5	GND
6	NC
7	NC
8	NC
9	NC

RS232C Connection

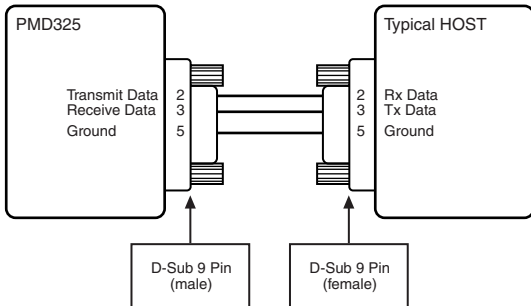

The wiring requirements for a 9 pin to 9 pin serial connection, are a male to female straight cable.

RS-232C physical specifications

Cable	Straight cable
Baud rate	9600 bps
Data bits	8 bits
Parity bit	None
Stop bit	1 bit
Flow control	None

Command reception

The command packets have a data length of 5, 6 or 7 bytes. ASCII codes from 0x00 to 0x7f are used to receive serial data. At the transmission end, therefore, take steps to convert the ASCII codes into HEX data to set the data in the data packets. CR (0x0d) is added as the data packet delimiter.

Example: Reception Time Command (code 2011)

[2]	[0]	[1]	[1]	[CR]
0x32	0x30	0x31	0x31	0x0d

When transmitting commands consecutively, put more than 100ms blank between commands.

Received command data

Command	Code	Command	Code
0	2000	Pitch Down Start	2039
1	2001	Pitch Down Stop	203901
2	2002	Program	2041
3	2003	AMS	2043
4	2004	Open/Close	2045
5	2005	Pause	2048
6	2006	Cancel	2049
7	2007	Fast Backward Start	2050
8	2008	Fast Backward Stop	205001
9	2009	Fast Forward Start	2052
Time	2011	Fast Forward Stop	205201
Recall/Scroll	2015	Play	2053
Random	2028	Stop	2054
Repeat	2029	A-B	2059
Next	2032	Display (Dimmer)	2071
Previous	2033	Menu	2082
Index +	2034	Enter	2087
Index -	2035	Text	2088
Pitch Reset	2037	Quick Replay	205304
Pitch Up Start	2038	Cue	205910
Pitch Up Stop	203801		

Status transmission

The status packets have a fixed data length of 4 bytes. ASCII codes from 0x00 to 0x7f are used to transmit serial data. For this reason, the ASCII codes are converted into HEX data before the data is set in the data packets and transmitted. CR (0x0d) is added as the data packet delimiter.

Example 1: Transmission Power On (code PWON)

[P]	[W]	[O]	[N]	[CR]
0x50	0x57	0x4f	0x4e	0x0d

Transmitted status data

Status	Code	Description
Power On	PWON	Transmitted when the power is turned on.
Tray Open	TROP	Transmitted upon completion of tray open.
Tray Close	TRCL	Transmitted upon completion of tray close.
TOC Error	TOCE	Transmitted when a TOC read error has occurred.
TOC Reading	TOCR	Transmitted when TOC read is started.
No Disc	NODI	Transmitted when "No disc" is detected.
Stop	STOP	Transmitted when the disc has stopped.
Play	Pxxx	Transmitted along with the track number (xxx) when play is started; also transmitted when the track number is changed during play.
Pause	Axxx	Transmitted along with the track number (xxx) when the pause status is established.
Fast Forward	FFON	Transmitted when Fast Forward is started.
Fast Backward	RWON	Transmitted when Fast Backward is started.
Repeat Off	RPOF	Transmitted when Repeat Off is set.
Repeat All	RPAL	Transmitted when Repeat All is set.
Repeat One	RPON	Transmitted when Repeat One is set.
Repeat A	RPA-	Transmitted when Repeat A is set.
Repeat AB	RPAB	Transmitted when Repeat A-B is set.
End Warning	ENDW	Transmitted when End Warning is started.

ENGLISH

Installing the rack-mounting kit

Follow the steps below to install the rack-mounting kit on the unit.

1. Remove the four screws on the side panels of the unit.

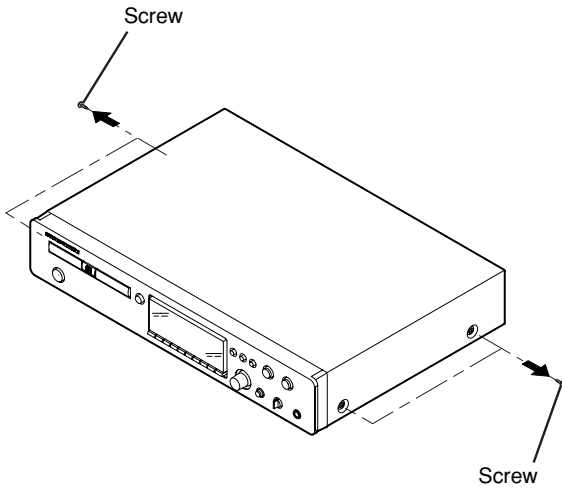

2. Using the four screws which were removed in step 1, attach the two side panels of the rack-mounting kit as shown in the figure below.

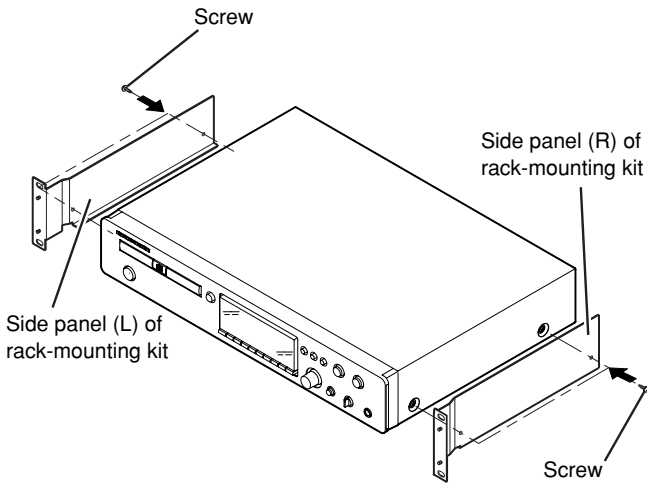

3. Align the front panel with the boss screws provided in the side panels of the rack-mounting kit, and fit it in place. After having attached the front panel, secure it by tightening up the four box nuts as shown in the figure below.

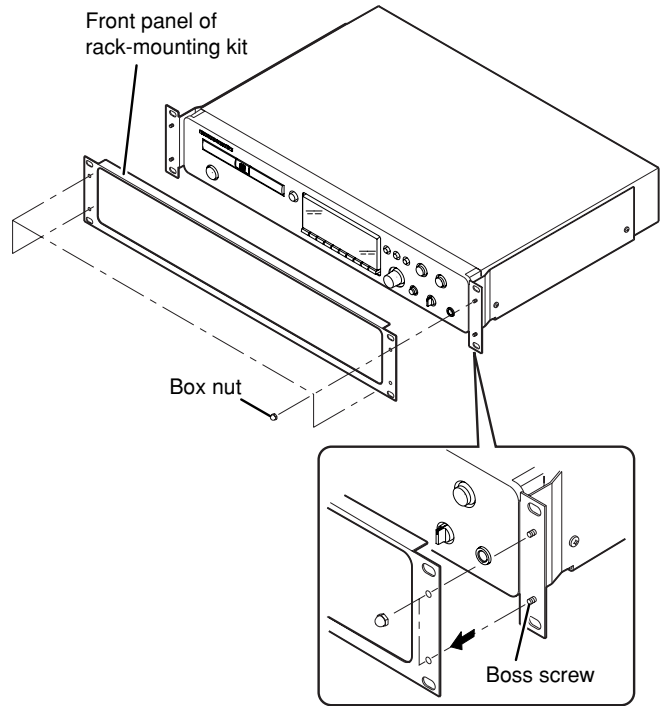

4. The figure below shows how the rack-mounting kit looks when it has been installed.

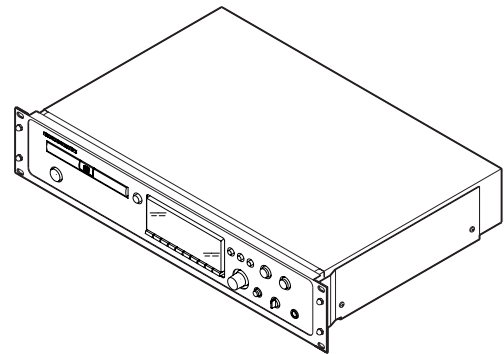

Tips

- * When attaching the two side panels of the rack-mounting kit in step 2, first loosely tighten the four screws, and then while making adjustments so that the front panel of the rack-mounting kit and front panel of the main unit are level, tighten up these four screws securely.
- * If necessary, remove the feet on the unit's bottom panel.

10. SPECIFICATIONS AND DIMENSIONS

Specifications

General specifications

System Compact disc digital audio
 Number of channels 2
 Compatible discs CD, CD-R, CD-RW (12 cm, 8 cm)

Audio characteristics

Channels 2
 Frequency response 20 Hz to 20 kHz ± 0.5 dB
 Dynamic range 100 dB or more
 Signal-to-noise ratio Better than 110 dB
 Channel separation 100 dB or more (1 kHz)
 Total harmonic distortion 0.0025% (1 kHz)
 Wow & flutter Quartz crystal accuracy
 Error correction system Cross-interleave Reed-Solomon code (CIRC)

Analog output

Analog unbalanced output (RCA) 2V RMS stereo
 Analog balanced output (XLR) +16 dBu/600 ohms
 (factory setting)

Variable range -11 to +21 dBu

Digital output

Coaxial digital output 0.5Vp-p/75 ohms
 Optical digital output -19 dBm
 Digital balanced output 3.5Vp-p/110 ohms
 Pitch control $\pm 12.0\%$ in 0.1 dB increments

Remote control

Infrared remote control input IR sensor
 Remote control input RCA (INT/EXT switching enabled)
 Control input/output D-Sub 25-pin female
 RS-232C D-Sub 9-pin female

Optical readout system

Laser AlGaAs semiconductor
 Wavelength 780 nm

Signal system

Sampling frequency 44.1 kHz
 Quantization 16-bit linear/channel

Power supply

U version AC 120 V, 60 Hz
 Power consumption 12 W

Cabinet, etc.

Maximum dimensions

Including rack-mounting kit
 19 (W) x 3-1/2 (H) x 12-7/16 (D) in.
 (482.6 (W) x 88.4 (H) x 316.5 (D) mm)
 Main unit only ... 17-5/16 (W) x 3-9/16 (H) x 12-1/2 (D) in.
 (440(W) x 90(H) x 317 (D) mm)

Weight

Including rack-mounting kit 11 lbs (5.0 kg)
 Main unit only 9.46 lbs (4.3 kg)
 Allowable operating temperature +5 to +35°C
 Allowable operating humidity 5 to 90% (no condensation)

This player's specifications and exterior are subject to change without notice for improvements.

Dimensions (unit: inch (mm))

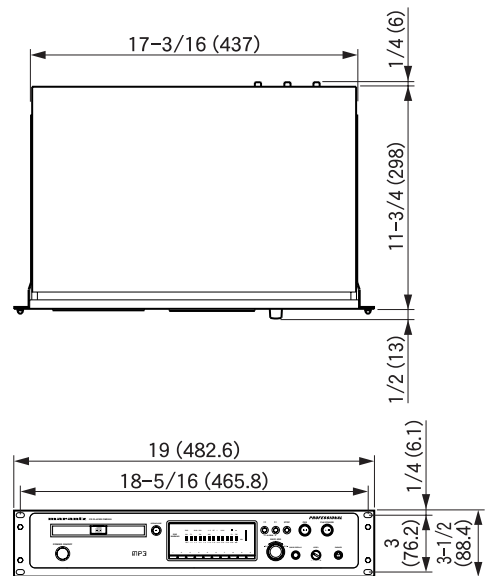

11. TROUBLESHOOTING

If you think that something is wrong with your player, first check the points listed below. Incorrect operations can sometimes be taken for trouble and malfunctions. If the trouble persists even after the following points have been checked, consult your dealer or nearest Marantz sales office or service center.

Disc fails to turn.

- Has the power cord been connected properly?
- Has the player's power been turned on?
- Has the disc been placed in the proper position?
- Is the disc upside down? (Is the disc's label surface facing up?)
- Is the disc dirty?
- Is the disc scratched?
- Is the disc warped?

Disc turns but no sound is heard.

- Have the amplifier and speakers been connected properly?
- Has the amplifier's power been turned on?
- Has the amplifier's function or selector switch been set to "CD" or "AUX" (or to whichever connectors the player has been connected)?
- Is the amplifier's volume at its lowest setting?

Disc starts turning but then stops at some point.

- Is the disc dirty?
- Is the disc scratched?
- Is the disc warped?
- Is the disc being played a music CD? CD-ROMs (except their MP3 files) for personal computers, etc. cannot be played.

No remote control operations.

- Is the transmitter of the remote control unit (RC7300CD) pointed at the remote sensor of the player? Is there anything between the player and remote control unit which is blocking the signals?
- Have the batteries of the remote control unit (RC7300CD) run down?
- Is a strong light shining on the remote sensor of the player?
- Is the REMOTE CONTROL switch on the rear panel set to the EXTERNAL position? (Set it to the INTERNAL position if the player is to be used on its own.)

CD-R/CD-RW discs cannot be played.

- Has the disc been placed upside down on the disc tray?
- Is the recorded information in a format (CD-DA or MP3) used for music applications?

Limited Warranty

Your Marantz Professional product is warranted against manufacturer defect for period of one year parts and labor.

Except as specified below this warranty covers defects in material and workmanship. The following are not covered under warranty.

1. a) Damage, deterioration, malfunction or failure to meet performance specification resulting from:
 - b) Accidents, acts of nature, misuse, abuse, neglect or unauthorized product modification.
 - c) Improper installation, removal or maintenance, or failure to follow supplied instruction.
 - d) Repair or attempted repair by a non Marantz authorized agent.
 - e) Any shipment of the product (claims must be presented to the carrier).
 - f) Any cause other than a defect in manufacturing.
2. Cleaning, check-ups with no fault found, or changes incurred for installation, removal or reinstallation of the product.
3. Any serialized product on which the serial number has been defaced, modified or removed.
4. Batteries and battery chargers.
5. Accessories, including but not limited to, cables, mounting hardware and brackets, cleaning accessories, power cords and adaptors, and carry cases.
6. Product purchased outside the United States, its possessions or territories.

Non-Transferable Warranty

This warranty may be enforced only by the original purchaser.

What We Will Pay For

We will pay for all labor and material expense for items covered by the warranty.

How You Can Get Service

1. If your unit needs service, contact our service referral at the appropriate telephone number indicated below. We will advise you of the name and location of one or more warranty authorized service centers from which service may be obtained. Please do not return your unit directly to us.
2. You must pay any shipping charges if it is necessary to ship the product for service. If the necessary repairs are covered by the warranty, we will pay the return shipping charges to your location anywhere in the United States or its territories.
3. Whenever warranty service is required, you must present the original dated sales receipt or other proof of date purchased.

Limitation of Implied Warranties

All implied warranties, including warranties of merchantability and fitness for a particular purpose, are limited in duration to the length of this warranty.

Exclusion of Damages

Liability for any defective product is limited to repair or replacement of the product at manufacturer's option. Manufacturer shall not be liable for damage to other products caused by any defects in Marantz products, damages based upon inconvenience or loss of use of the product, or any other damages, whether incidental, consequential, or otherwise.

Some states do not allow limitations on how long an implied warranty lasts and/or do not allow the exclusion or limitation of incidental or consequential damages, so the above limitations and exclusions may not apply to you.

How State Law Relates to the Warranty

This warranty gives you specific legal rights, and you may have other rights which may vary from state to state.

Marantz Professional Service Number:

Marantz Professional Factory Service (630) 820-4800

This warranty is enforceable only in the United States and its possessions and territories.

marantz[®] is a registered trademark.

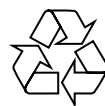

Free Manuals Download Website

<http://myh66.com>

<http://usermanuals.us>

<http://www.somanuals.com>

<http://www.4manuals.cc>

<http://www.manual-lib.com>

<http://www.404manual.com>

<http://www.luxmanual.com>

<http://aubethermostatmanual.com>

Golf course search by state

<http://golfingnear.com>

Email search by domain

<http://emailbydomain.com>

Auto manuals search

<http://auto.somanuals.com>

TV manuals search

<http://tv.somanuals.com>