

# **marantz®**

**Model MM9000 User Guide**

---

**Power Amplifier**

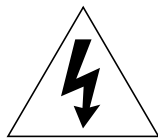
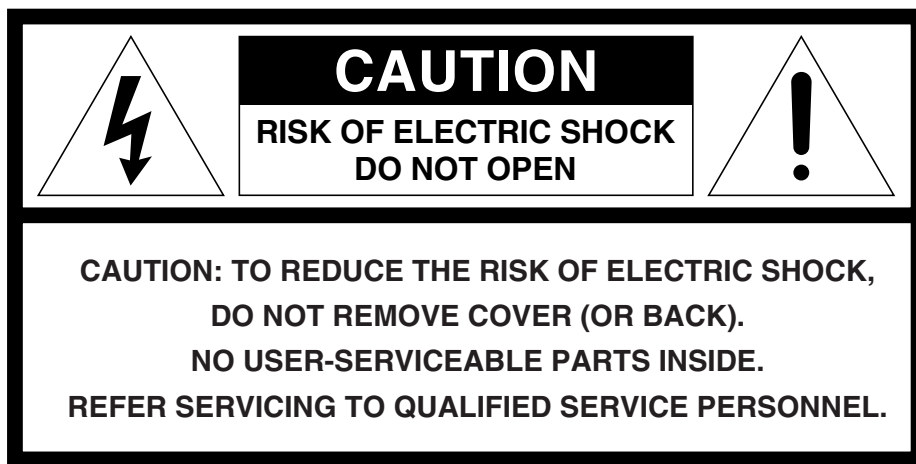

The lightning flash with arrowhead symbol, within an equilateral triangle, is intended to alert the user to the presence of uninsulated "dangerous voltage" within the product's enclosure that may be of sufficient magnitude to constitute a risk of electric shock to persons.



The exclamation point within an equilateral triangle is intended to alert the user to the presence of important operating and maintenance (servicing) instructions in the literature accompanying the product.

## WARNING

**TO REDUCE THE RISK OF FIRE OR ELECTRIC SHOCK,  
DO NOT EXPOSE THIS APPLIANCE TO RAIN OR MOISTURE.**

---

**CAUTION: TO PREVENT ELECTRIC SHOCK, MATCH WIDE BLADE  
OF PLUG TO WIDE SLOT, FULLY INSERT.**

**ATTENTION: POUR ÉVITER LES CHOC ÉLECTRIQUES,  
INTRODUIRE LA LAME LA PLUS LARGE DE LA FICHE DANS LA BORNE  
CORRESPONDANTE DE LA PRISE ET POUSSER JUSQU'AU FOND.**

---

# SAFETY INSTRUCTIONS

## READ BEFORE OPERATING EQUIPMENT

This product was designed and manufactured to meet strict quality and safety standards. There are, however, some installation and operation precautions which you should be particularly aware of.

1. Read Instructions — All the safety and operating instructions should be read before the appliance is operated.
2. Retain Instructions — The safety and operating instructions should be retained for future reference.
3. Heed Warnings — All warnings on the appliance and in the operating instructions should be adhered to.
4. Follow Instructions — All operating and use instructions should be followed.
5. Water and Moisture — The appliance should not be used near water — for example, near a bathtub, wash-bowl, kitchen sink, laundry tub, in a wet basement, or near a swimming pool, etc.
6. Carts and Stands — The appliance should be used only with a cart or stand that is recommended by the manufacturer.
7. An appliance and cart combination should be moved with care. Quick stops, excessive force, and uneven surfaces may cause the appliance and cart combination to overturn.



8. Wall or Ceiling Mounting — The appliance should be mounted to a wall or ceiling only as recommended by the manufacturer.
9. Ventilation — The appliance should be situated so that its location or position does not interfere with its proper ventilation. For example, the appliance should not be situated on a bed, sofa, rug, or similar surface that may block the ventilation openings; or, placed in a built-in installation, such as a bookcase or cabinet that may impede the flow of air through the ventilation openings.
10. Heat — The appliance should be situated away from heat sources such as radiators, heat registers, stoves, or other appliances (including amplifiers) that produce heat.
11. Power Sources — The appliance should be connected to a power supply only of the type described in the operating instructions or as marked on the appliance.

12. Grounding or Polarization — The precautions that should be taken so that the grounding or polarization means of an appliance is not defeated.

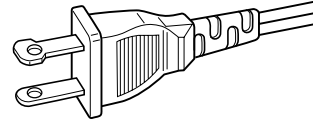

AC POLARIZED PLUG

13. Power-Cord Protection — Power-supply cords should be routed so that they are not likely to be walked on or pinched by items placed upon or against them, paying particular attention to cords at plugs, convenience receptacles, and the point where they exit from the appliance.
14. Cleaning — The appliance should be cleaned only as recommended by the manufacturer.
15. Power Lines— An outdoor antenna should be located away from power lines.
16. Outdoor Antenna Grounding — If an outside antenna is connected to the receiver, be sure the antenna system is grounded so as to provide some protection against voltage surges and built up static charges. Section 810 of the National Electrical Code, ANSI/NFPA No. 70-1984, provides information with respect to proper grounding of the mast and supporting structure, grounding of the lead-in wire to an antenna discharge unit, size of grounding conductors, location of antenna-discharge unit, connection to grounding electrodes, and requirements for the grounding electrode. See Fig. 1.
17. Nonuse Periods — The power cord of the appliance should be unplugged from the outlet when left unused for a long period of time.
18. Object and Liquid Entry — Care should be taken so that objects do not fall and liquids are not spilled into the enclosure through openings.
19. Damage Requiring Service — The appliance should be serviced by qualified service personnel when:
  - A. The power-supply cord or the plug has been damaged; or
  - B. Objects have fallen, or liquid has spilled into the appliance; or
  - C. The appliance has been exposed to rain; or
  - D. The appliance does not appear to operate normally or exhibits a marked change in performance; or
  - E. The appliance has been dropped, or the enclosure damaged.
20. Servicing — The user should not attempt to service the appliance beyond that described in the operating instructions. All other servicing should be referred to qualified service personnel.

**FIGURE 1**  
**EXAMPLE OF ANTENNA GROUNDING ACCORDING TO**  
**NATIONAL ELECTRICAL CODE INSTRUCTIONS**  
**CONTAINED IN ARTICLE 810 -"RADIO AND TELEVISION EQUIPMENT"**

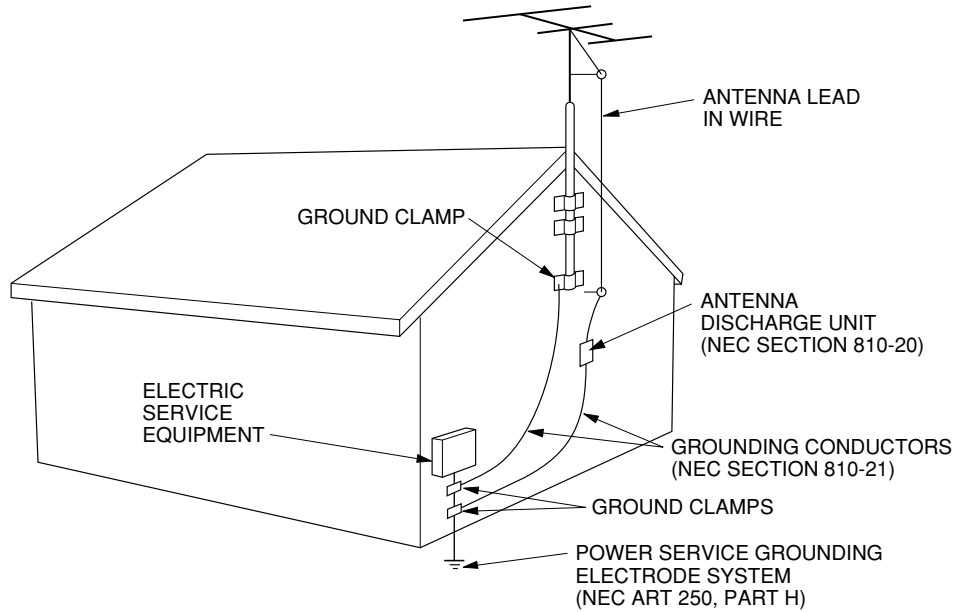

NEC - NATIONAL ELECTRICAL CODE

---

**This Class B digital apparatus meets all requirements of the Canadian Interference-Causing Equipment Regulations.**

Cet appareil numérique de la Classe B respecte toutes les exigences du Règlement sur le matériel brouilleur du Canada.

---

**NOTE TO CATV SYSTEM INSTALLER:**

This reminder is provided to call the CATV system installer's attention to Article 820-40 of the NEC that provides guidelines for proper grounding and, in particular, specified that the cable ground shall be connected to the grounding system of the building, as close to the point of cable entry as practical.

# 1. INTRODUCTION

Thank you for purchasing the Marantz MM9000 power amplifier for your sound system. Please take a few minutes to read this manual thoroughly, before you attempt connections and operation.

The Marantz MM9000 is a Multi channel power amplifier, that is designed for home theater and high quality audio systems.

# 2. FEATURES

The MM9000 is a five channel power amplifier developed for use in hi-fi AV systems.

- It is a high-power amplifier with all-discrete circuit configuration with rated outputs of 170W / 8-ohms.
- It is provided with the MARANTZ remote control capability so its power can be controlled from a MARANTZ preamplifier or surround receiver (MARANTZ remote control compatible products).
- The power of the unit can be switched by remote control using a video signal or DC signal.
- The MM9000 are equipped with peak power indicators which indicate that the amplifier attains the maximum peak power even this occurs for a very short instant.

# 3. NAMES AND FUNCTIONS



THX is an exclusive set of standards and technologies established by the world-renowned film production company, Lucasfilm Ltd. THX grew from George Lucas' personal desire to make your experience of the film soundtrack, in both movie theatres and in your home theatre, as faithful as possible to the master recording.

Before any home theatre component can be THX Ultra certified, it must pass a rigorous series of quality and performance tests. Only then can a product feature the THX Ultra logo, which is your guarantee that the Home Theatre products you purchase will give you superb performance for many years to come.

## Home THX Amplifiers

With today's superior quality but exceptionally complex audio systems it is important to ensure that noise, distortion and frequency response errors are negligible in all links in the audio chain. With discrete multichannel sources it is especially important that maximum power is instantly available without instability, rise in distortion or other undesirable side affects.

THX Ultra requirements cover every performance aspect of this product including operation, output power levels, gain, frequency response and numerous other parameters. Whether you choose music or movies, multichannel or stereo, this amplifier will be supremely flexible, easy to use, sonically transparent and absolutely reliable.

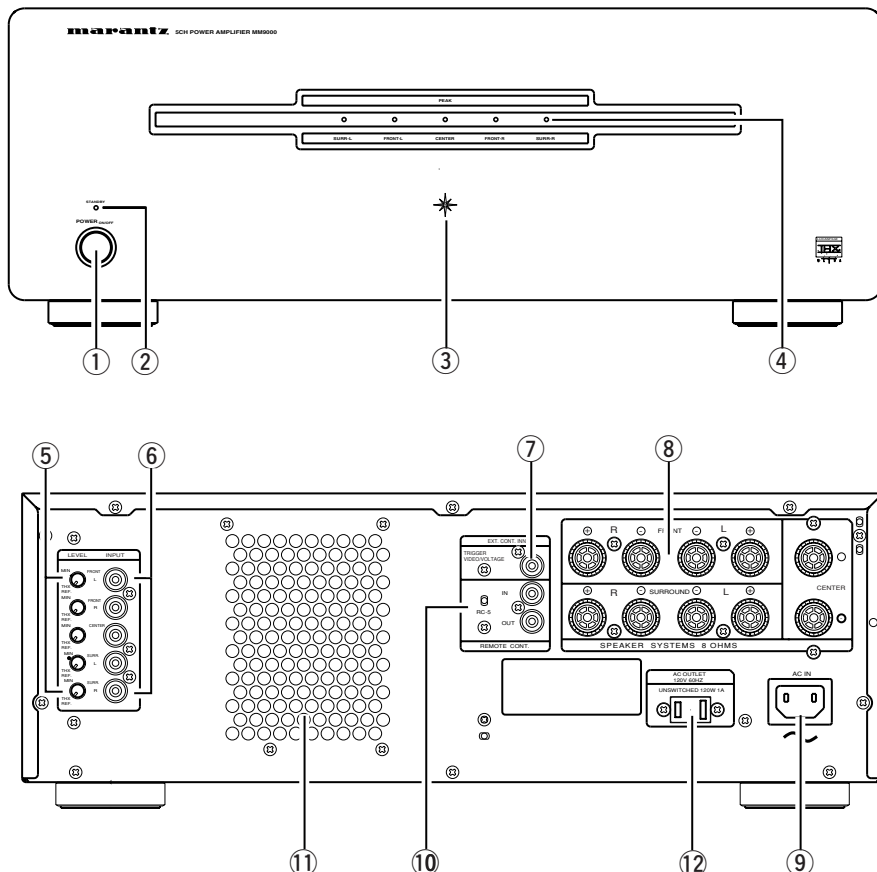

**① POWER switch**

Press the button to turn power on (POWER ON mode), and press it again to turn power off (POWER OFF mode). When it is required to remote control the power mode of the MM9000, be sure to leave this switch in the POWER ON mode.

**② STANDBY indicator**

This indicator lights up when the unit is put to the STANDBY mode by remote control or based on the video signal input. In the STANDBY mode, the power supply to the internal circuit of the amplifier is cut so the heat generation and power consumption are minimized.

**③ POWER indicator**

The indicator lights up when the power is on and the unit is ready to output sound.

**④ PEAK indicators**

When the output power of a channel is clipped momentarily, the corresponding indicator lights in red. If the indicators light continuously in red, decrease the listening volume.

**⑤ INPUT LEVEL control**

This control sets the amplifier's output level by adjusting its input level.

When you use the MM9000 in a THX system, the knob must be set to THX Ref. (Maximum position)

**⑥ AUDIO INPUT jack**

Connect the preamplifier output to this jack.

**⑦ EXT. CONT IN jack**

Not connected when the power is to be controlled from a MARANTZ remote control unit.

Connect to the video signal output of a video component when the power is to be controlled based on a video signal.

The external control allows to switch the "POWER ON" and "STANDBY" modes of the unit according to the "presence" and "absence" of video signal.

When the video signal becomes absent while the power of the unit is on, it enters the "STANDBY" mode in about 4 seconds, the unit enters the "POWER ON" mode again when the video signal is input again.

External control using a signal from 5 to 13 V in place of video signal is also possible using this jack. However, as this scheme belongs to the professional use, please consult MARANTZ if you want to adopt such an external control scheme.

**⑧ SPEAKER SYSTEM terminals**

Connect with speakers using speaker cords. Respect the + and - polarity when connecting speakers.

**⑨ AC INLET**

Connect AC cord (Supplied) and plug into a household AC power outlet.

**⑩ RC-5 IN / OUT jack**

If your system uses a Marantz remote control compatible component with preamplifier outputs, such as an A/V preamplifier or surround receiver, these jacks allow to turn the power of the MM9000 to ON or OFF/Standby through remote control from the preamplifier or receiver. Before using these jacks, check the owner's manual of the Marantz component to see if it is remote control compatible.

**⑪ Ventilation hole****CAUTION:**

When the amplifier is in operation, The temperature of set will rise. Never place any object on the set and back side to maintain ventilation.

**⑫ AC OUTLET**

This receptacle supplies AC power regardless of the power switch setting.

The total power consumption of the equipment connected to this receptacle should not exceed 120 W.

# 4. CONNECTIONS

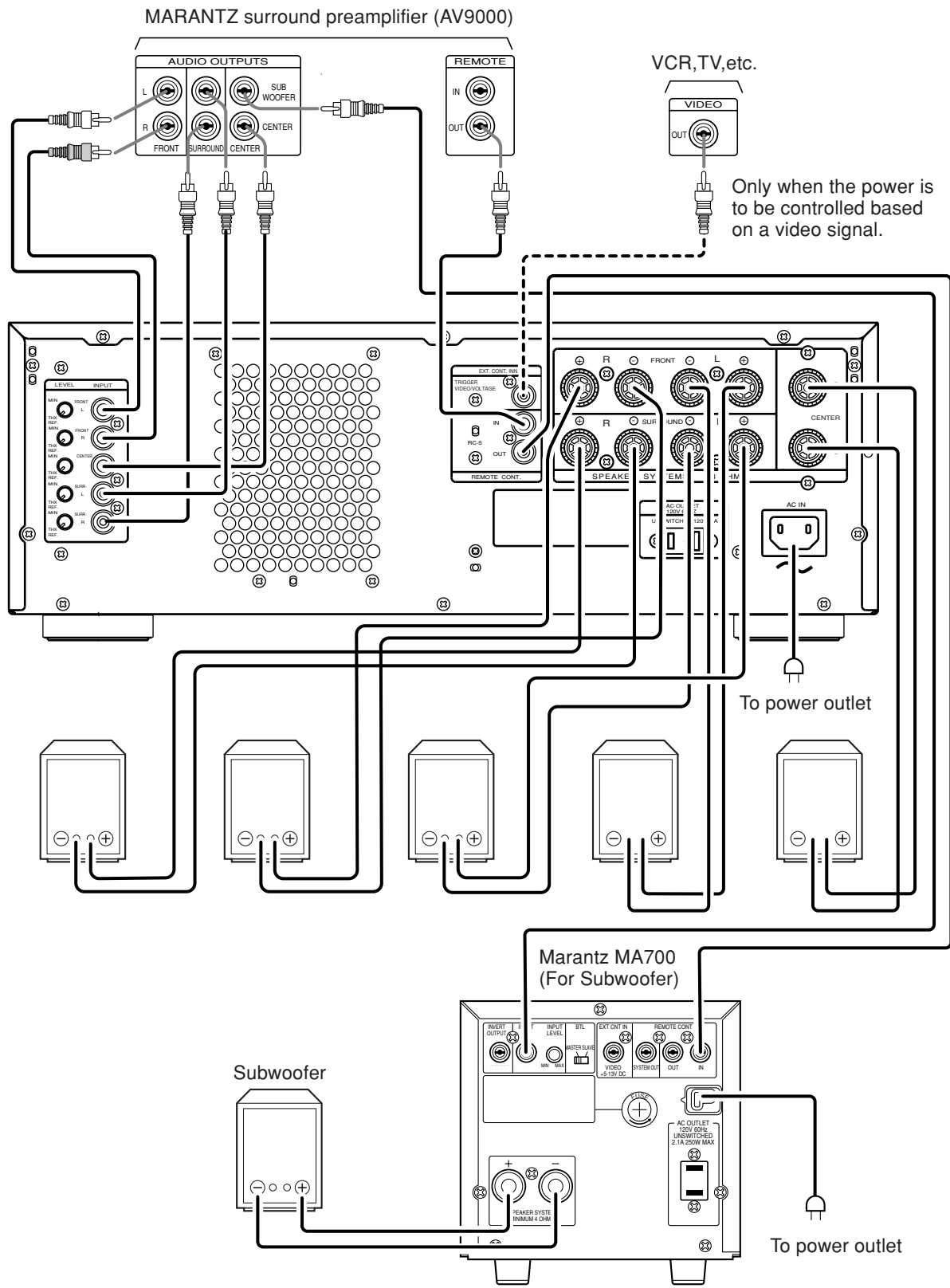

## 5. SPEAKER CONNECTION

This equipment, being a high audio output power amplifier, has a hazardous energy at its speaker terminal. Please be sure to make an appropriate speaker connection according to the following procedures:

- Confirm that the power switch of the equipment is at "OFF" position. If it is at "ON", turn it to "OFF" position to connect a speaker cable.
- Use a speaker cable with the flame retardant rating of type SPT12 or more.
- Don't strip the insulation off more than shown in the figure, at the speaker terminal connection of speaker cable.

Speaker cable (Type SPT12 )

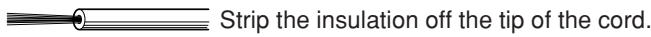

- Connect speakers in correct polarity, according to the indication for the polarity of speaker terminals.
- Prevent any stress from being applied to the speaker cable connected to the speaker terminal.
- Don't touch the speaker terminals during operation.

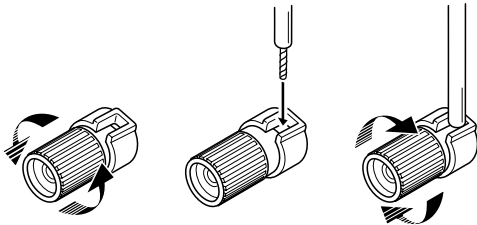

Loosen the Terminal    Insert the core    Tighten the Terminal  
Connection of speaker cable Terminal

## 6. CARE AND MAINTENANCE

This section describes the care and maintenance tasks that must be performed to optimize the operation of your Marantz equipment.

### CLEANING OF EQUIPMENT EXTERNAL SURFACES

The exterior finish of your unit will last indefinitely with proper care and cleaning. Never use scouring pads, steel wool, scouring powders or harsh chemical agents (e.g., lye solution), alcohol, thinners, benzene, insecticide or other volatile substances as these will mar the finish of the equipment.

Likewise, never use cloths containing chemical substances. If the equipment gets dirty, wipe the external surfaces with a soft, lint-free cloth.

If the equipment becomes heavily soiled:

- Dilute some washing up liquid in water, in a ratio of one part detergent to six parts water.
- Dip a soft, lint free cloth in the solution and wring the cloth out until it is damp.
- Wipe the equipment with the damp cloth.
- Dry the equipment by wiping it with a dry cloth.

## 7. REPAIRS

Only the most competent and qualified technicians should be allowed to service your unit. Marantz and its factory trained warranty station personnel have the knowledge and special equipment needed for repair and calibration of this precision instrument.

In the event of difficulty, call the toll-free telephone number listed on the face of the warranty to obtain the name and address of the Marantz Authorized Service Center nearest you. In many cases, the dealer where you purchased your Marantz unit may be equipped to provide service. Please include the model, serial number of your unit together with a copy of your purchase receipt and a full description of what you feel is abnormal in its behavior.

## 8. TROUBLESHOOTING

The amplifier does not operate and the POWER ON indicator does not light.

- Is the power cable plugged in properly to the AC power outlet? The POWER ON indicator lights, but the amplifier does not function.
- Are speaker cables and input cables connected properly?

## 9. SPECIFICATION

### Rated power output

Front L/R (20Hz -20KHz) .....	170W 8-ohm / Channel
Center (20Hz - 20KHz) .....	170W 8-ohm / Channel
Surround L/R (20Hz - 20KHz) .....	170W 8-ohm / Channel
THD (20Hz - 20KHz) .....	0.03% 8-ohm
Input sensitivity .....	100mV / 1W Output
Input impedance .....	20K ohms
Frequency response (-1dB) .....	5 Hz to 100KHz
Signal to noise ratio .....	95dB

Power requirement .....	120 VAC, 60 Hz
Power consumption (L/R channel 100W driven) .....	400W

### Dimensions (Maximum)

Width .....	17-5/16 inches (440mm)
Height .....	6-5/16 inches (159mm)
Depth .....	17-4/5 inches (452mm)
Weight .....	44.1 lbs (20Kg)

### Accessories

AC power cord .....	1
---------------------	---

Design and specifications are subject to change without notice.



COUNTRY	COMPANY	ADDRESS
AUSTRALIA	Scan audio Pty. Ltd.	4 Station Street, Thornleigh NSW 2120, Australia
AUSTRIA	Huber & Prohaska GmbH	Taborstraße 95 / Ladestraße 1, Gebäude Hangartner, A-1200 Wien, Austria
BELGIUM	Van der Heyden Audio N.V.	Brusselbaan 278, 9320 Erembodegem, Belgium
BULGARIA	Ariescommerce GmbH	Makedonia Blvd. 16, 1606 Sofia, Bulgaria
CANADA	Lenbrook Industries Limited	633 Granite Court, Pickering, Ontario
CYPRUS	Empire Hifi systems Ltd.	P.O. Box 5604, Nicosia, Cyprus
CZECH REPUBLIC	Audio International	Fugnerova 1, 67801 Blansko, Czech Republic
DENMARK	Hi-Fi Klubben Denmark	Aboulevarden 1, DK-8000 Arhus C., Denmark
DUBAI	V.V.& SONS	P.O. Box 105, Dubai, U.A.E.
ESTONIA	Audio International Baltic	Lo Hu 12, EE0026 Tallin, Estonia
F.Y.R.O.M.	T.P. KODI	ul.Cedomir Kantargiev 21a, Skopje, Former Yugoslavian Republic of Macedonia
FINLAND	Hi-Fi Klubi Finland	Uudenmaankatu 4-6, SF-00120 Helsinki, Finland
FRANCE	Marantz France	A division of Marantz Europe B.V., P.O. Box 301, 92 156 Suresnes Cedex, France
GERMANY	Marantz Deutschland	Hakenbusch 3, 49078 Osnabrück, Germany
GREECE	Adamco S.A.	188, Hippocratous Street, 11471 Athens, Greece
HEADQUARTERS EUROPE:	Marantz Europe B.V.	Building SFF-2, P.O. Box 80002, 5600 JB Eindhoven, The Netherlands
HONG KONG	Marantz Asia Ltd.	Unit 1706, Metroplaza II, 223 Hing Fong Road, Kwai Fong, N.T., Kowloon, Hong Kong
HUNGARY	Infovox Ltd.	Terez Krt.31, 1067 Budapest, Hungary
ICELAND	Radiobudin HF	Skipholt 19, P.O. Box 424, 121 Reykjavik, Iceland
INDIA	Marantz India	c/o Philips India Ltd., Plot 80, Bhosari Industrial Estate Pune - 411026, India
IRAN	Home Co.	5th floor no 878 Philips Building Enghelab ave, P.O. 11365/7844 Tehran, Iran
IRELAND	Marantz Ireland	Clonskeagh, Dublin 14, Ireland
ISRAEL	Elmor Ltd.	52 Heh Beiyar Street, Kikar Hamedina, Tel Aviv, Israel
ITALY	Marantz Italy	Via Casati 23, 20052 Monza (Milano), Italy, Servizio Consumatori 1678-20026, Numero Verde
JAPAN	Marantz Japan Inc.	35-1 Sagami Ohno 7-Chome, Sagamihara-shi, Kanagawa 228-8505, Japan
KOREA	Mk Enterprises Ltd.	#604 Electro-officetel, 16-58, 3GA Hangang-ro, Yongsan-ku, Seoul 140-013 Korea
KUWAIT	alAlamiah Electronics Intl.	P.O. Box 8196, Salmiah 22052, Kuwait
LATVIA	Ace Ltd.	61, LacPlesa Str., Riga LV 1011, Latvia
LEBANON	AZ Electronics S.A., 1,	P.O. Box 11 2833, Beirut, Lebanon
LITHUANIA	A Accapella Ltd.	Ausros, Vartu G5, Pasazo Skg., 2001 Vilnius, Lithuania
MALAYSIA	Wo Kee Hong Electronics Sdn. Bhd.	102 Jalan SS 21/35, Damansara Utama, 47400 Petaling Jaya, Selangordarul Ehsan, Malaysia
MALTA	Doneo Co Ltd.	78 The Strand, Sliema SLM07, Malta
MAURITIUS	SKR Electronics Ltd.	P.O. Box 685, Bell Village, Port Louis, Mauritius
NETHERLANDS	Marantz Trading	A division of Marantz Europe B.V., Building SFF-2, P.O. Box 80002, 5600 JB Eindhoven, The Netherlands
NEW ZEALAND	Scan audio Pty. Ltd.	4 Station Street, Thornleigh NSW 2120, Australia
NORWAY	Hi-Fi Klubben Norway	Lillegrensen 7, N-0159 Oslo, Norway
OMAN	Mustafa & Jawad Trading CO.	P.O. Box 1918, Ruwi, Oman
POLAND	Marantz Polska	Ul. Marszalkowska 45/49, 00-648 Warszawa, Poland
PORTUGAL	Corel2	Comércio de Electrónica Lda., Av. Luís Bivar, No 85 A, 1050 Lisboa, Portugal
PROFESSIONAL EUROPE	Marantz Professional Products	Kingsbridge House, Padbury Oaks, 575-583 Bath Road, Longford, Middlesex UB7 0EH, U.K.
PROFESSIONAL U.S.A.	Marantz Professional Products	Distributed by: Superscope Technologies Inc., 1000 Corporate Blvd. Ste.D, Aurora, Illinois
QATAR	Almana & Partners W.W.L.	P.O. Box 49, Doha, Qatar
REUNION	Vision +	180 Rue du Marechal Leclerc, 97400 Saint Denis, Ile de la Reunion
ROMANIA	Alltrom SRL	Soseaua Bucuresti, Ploiesti 10, Sector 1, Bucharest, Romania
RUSSIA	Trade Company SV	Bld. 2, 7 Montazhnaya Street, 107497 Moscow, Russia
SAUDI ARABIA	Ultimate Fidelity	Sameria Comm. Center, Roadah Dist., P.O. Box 7760, Jeddah 21472, Saudi Arabia
SINGAPORE	Forward Marketing (S) Pte. Ltd.	Wo Kee Hong Centre, 29 Leng Kee Road, Singapore 159099, Singapore
SLOVAKIA	Audio International Slovakia	Nam. SNP 10, 96001 Zvolem, Slovakia
SLOVENIA	Bofex	Smartinska 152, HALA V/3, 61000 Ljubljana, Slovenia
SOUTH AFRICA	Coherent Imports (PTY) Ltd.	P.O. Box 1614, Alberton, 1450, South Africa
SPAIN	Marantz Spain	Martinez Villergas 2, Apartado 2065, Madrid 28027, Spain
SWEDEN	Hi-Fi Klubben A.B.	Tegnersgatan 21, S-412 52 Gotenborg, Sweden
SWITZERLAND	Sound Company AG	Postfach, 8010 Zürich, Switzerland
TAHITI	Covecolor	Av. Prince Hinoi, Cours de l'union sacré, P.O. Box 2334, Papeete, Tahiti
TAIWAN	Pai-Yuing Co. Ltd.	6th No 148 Sung Kiang Road, Taipei 10429, Taiwan R.O.C.
THAILAND	MRZ Standard Co. Ltd.	746-750 Mahachai Road, Wangburapa, Bangkok 10200, Thailand
TURKEY	Penta Elektronik	Sanayi Ve Ticaret Ltd. Sti., Selvi Kokak, No. 4/1, Senlikkoy, 34810 Florya, Istanbul, Turkey
U.K.	Marantz Hifi UK Ltd.	Kingsbridge House, Padbury Oaks, 575-583 Bath Road, Longford, Middlesex UB7 0EH, U.K.
U.S.A.	Marantz America Inc.	440 Medinah Road, Roselle, IL 60172, U.S.A.
YUGOSLAVIA	ITM	Ljutice Bogdana la, Belgrade, Yugoslavia
EXPORT	Marantz Trading	A division of Marantz Europe B.V., Building SFF-2, P.O. Box 80002, 5600 JB Eindhoven, The Netherlands

[www.marantz.com](http://www.marantz.com)

<http://www.marantz.co.jp/>

Lucasfilm and THX are registered trademarks of Lucasfilm Ltd.

**marantz**® is a registered trademark.



## Free Manuals Download Website

<http://myh66.com>

<http://usermanuals.us>

<http://www.somanuals.com>

<http://www.4manuals.cc>

<http://www.manual-lib.com>

<http://www.404manual.com>

<http://www.luxmanual.com>

<http://aubethermostatmanual.com>

Golf course search by state

<http://golfingnear.com>

Email search by domain

<http://emailbydomain.com>

Auto manuals search

<http://auto.somanuals.com>

TV manuals search

<http://tv.somanuals.com>