



Loudspeaker System



XCS1K Owner's Manual

WARNING - TO REDUCE RISK OF FIRE OR ELECTRICAL SHOCK, DO NOT EXPOSE THIS EQUIPMENT TO RAIN OR MOISTURE.

NO USER-SERVICEABLE PARTS INSIDE. REFER SERVICING TO QUALIFIED PERSONNEL.

To prevent the risk of electric shock, do not remove cover or back. No user-serviceable parts inside.

IMPORTANT SAFETY INSTRUCTIONS!

PLEASE READ THEM BEFORE OPERATING THIS EQUIPMENT.

1. Read these instructions.
2. Keep these instructions.
3. Heed all warnings.
4. Follow all instructions.
5. Do not use this apparatus near water.
6. Clean only with a non-abrasive dry soft cloth.
7. Install in accordance with the manufacturer's instructions.
8. **This Loudspeaker is capable of producing extremely high sound pressure levels, even when connected to amplifiers of moderate power output. User caution is advised. Ear protection is recommended when playing at high volumes as continued exposure to high sound pressure levels can cause permanent hearing impairment or loss. The use of a Sound Level Pressure Meter will greatly aid in determining when high volume levels are occurring.**
9. Do not install near any heat sources such as radiators, heat registers, stoves, or other apparatus (including amplifiers) that produce heat.
10. Only use attachments/accessories specified by the manufacturer.
11. Use only with the cart, stand, tripod, bracket, or table specified by the manufacturer, or sold with the apparatus. When a cart is used, use caution when moving the cart/apparatus combination to avoid injury from tip-over. 
12. Refer all servicing to qualified service personnel. Servicing is required when the apparatus has been damaged in any way, liquid has been spilled or objects have fallen into the apparatus, the apparatus has been exposed to rain or moisture, does not operate normally, or has been dropped.
13. Do not expose this equipment to dripping or splashing and ensure that no objects filled with liquids, such as vases, are placed on the equipment.
14. **WARNING: When this Loudspeaker is connected to an amplifier that is Powered On, the connection terminals may have hazardous live voltages present with a risk of electric shock.**
15. **CAUTION: When this Loudspeaker is assembled it weighs 133 pounds (60.3 kgs). It requires two or more persons to safely move the Loudspeaker.**

Thank You

Your decision to own this McIntosh XCS1K Loudspeaker System ranks you at the very top among discriminating music listeners. You now have “The Best.” The McIntosh dedication to “Quality,” is assurance that you will receive many years of listening enjoyment from this unit. Please take a short time to read the information in this manual. We want you to be as familiar as possible with all the features and functions of your new McIntosh.

Please Take A Moment

The serial number, purchase date and McIntosh Dealer name are important to you for possible insurance claim or future service. The spaces below have been provided for you to record that information:

Serial Number: _____

Purchase Date: _____

Dealer Name: _____

Technical Assistance

If at any time you have questions about your McIntosh product, contact your McIntosh Dealer who is familiar with your McIntosh equipment and any other brands that may be part of your system. If you or your Dealer wish additional help concerning a suspected problem, you can receive technical assistance for all McIntosh products at:

McIntosh Laboratory, Inc.
2 Chambers Street
Binghamton, New York 13903
Phone: 607-723-1545
Fax: 607-724-0549

Customer Service

If it is determined that your McIntosh product is in need of repair, you can return it to your Dealer. You can also return it to the McIntosh Laboratory Service Department. For assistance on factory repair return procedure, contact the McIntosh Service Department at:

McIntosh Laboratory, Inc.
2 Chambers Street
Binghamton, New York 13903
Phone: 607-723-3515
Fax: 607-723-1917

Copyright 2008 © by McIntosh Laboratory, Inc.

Table of Contents

Safety Instructions	2
Thank You and Please Take a Moment.....	3
Technical Assistance and Customer Service	3
Table of Contents and General Information	3
Introduction.....	4
Performance Features	5
Dimensions	6-7
Installation	8
How to Connect using a single Amplifier	9
How to Connect using two Amplifiers.....	10-11
How to Connect using three Amplifiers.....	12-13
Specifications.....	14
Packing Instruction.....	15

General Information

Caution: The XCS1K weight is 133 pounds (60.3kg). It requires two or more persons to safely handle the Loudspeaker System.

- Loudspeaker Cables of adequate size are important to ensure that there will be no significant power loss or heating. Cable size is specified in Gauge numbers or AWG (American Wire Gauge). The smaller the Gauge number, the larger the wire size:
If the Loudspeaker Cables are 50 feet (38.1m) or less, use at least 12 Gauge (AWG) wire size or larger.
If the Loudspeaker Cables are 100 feet (76.2m) or less, use at least 10 Gauge (AWG) wire size or larger.*
- For additional connection information, refer to the owner's manual(s) for any component(s) connected to the XCS1K Loudspeaker.*
- The XCS1K's built-in speaker protection incorporates five automatic resetting solid-state devices in the crossover networks. One protects the tweeters, one for the midranges and three for the woofers. The protection allows a certain amount of overdrive but extended periods will trigger protection. If an obvious lack of high, mid or low frequencies is noticed, the Protection Device may have activated. These devices will automatically reset when the volume level is reduced significantly and kept low until the output of the affected Loudspeaker Element returns to normal.*
- When the XCS1K Loudspeaker System is driven by more than one amplifier, the output levels of the different amplifiers connected to the Loudspeaker System must be adjusted to achieve a proper balance between the low, midrange and high frequencies reproduced. This adjustment is best achieved through the use of audio test equipment operated by a qualified installer.*

Introduction

The new McIntosh XCS1K Loudspeaker System is a Center Channel Loudspeaker capable of reproducing the full dynamic range of a symphony orchestra with very low audible distortion. It is the perfect match to the famous XCS1K Column Loudspeakers, when used in a Home Theater/Music System. It uses the same acoustic technology found in the XCS1K Column Loudspeakers developed by the McIntosh Acoustic Engineers. The technology has been refined over the years and is now the 6th generation of the design and provides superior quality sound reproduction in a full range system.

The XCS1K Loudspeaker utilizes a Horizontal Arc Array Design with three-quarter inch Titanium Dome Tweeters and multiple rows of two inch Midrange Inverted Titanium Dome Drivers. Refer to figures 1, 2A and 2B. The Sound Waves from this Horizontal Arc Array produce a stable and focused symmetrical horizontal sound image. Since the audio power fed to each row is distributed among all the drivers, each driver does not have to work as hard, resulting in greater power handling capability, greatly reduced power compression and a dramatic reduction in distortion.

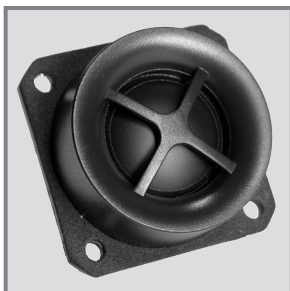

Figure 1



Figure 2A



Figure 2B

The Low Frequency Section of the System consists of two 10 inch Woofers. They have a large magnet assembly and long cone excursions with very low levels of harmonic distortion and frequency response down to 16Hz. Refer to figure 3. The Woofer also incorporates McIntosh's Patented LD/HP¹ Magnetic Circuit Design. Finite Element

¹LD/HP Pat. No 5,151,943

Analysis and testing resulted in a design concept which utilizes a pair of aluminum shorting sleeves in the magnetic circuit. Refer to figure 4. The sleeves virtually eliminate the negative influence of the fluctuating voice coil field on the permanent magnet field. This results in lower distortion due to more linear magnetic flux in the voice coil gap. Refer to figure 5. Additional benefits are less volume compression due to improved heat transfer through the sleeves and a cooler operating voice coil. Both measurements, as well as critical listening, reveal ten times less distortion than previous designs. A good example of this low distortion is incredible smoothness and clarity in the reproduction of the human voice.



Figure 3



Figure 4

The Crossover Networks used in the XCS1K Loudspeaker System are phase matched between the Low Frequency, Midrange

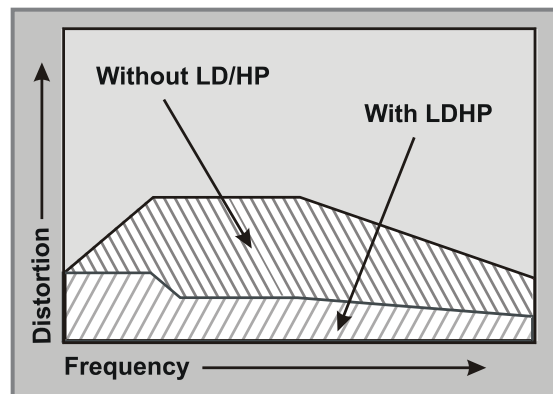

Figure 5

and High Frequency Sections to ensure a smooth frequency response over the entire audible range. Refer to figures 6, 7 and 8. The crossover inductors are selected so they will not add audible distortion. The network capacitors are film type for extra reliability. All the Capacitors and Inductors are chosen for high current capacity. Each section of the network utilizes its own self resetting high current PPTC type fuses to provide an extra measure of protection.

Performance Features

• Patented LD/HP Technology

The McIntosh Low Frequency Loudspeaker Elements feature the patented LD/HP Magnetic Circuit Design. This design, when compared to conventional Loudspeaker Elements, reduces distortion significantly. It also increases power handling and efficiency.

• Neodymium-Iron-Boron Alloy Magnets

The 32 two inch Midranges and 20 three-quarter inch Dome Tweeters all use this Alloy. The Neodymium-Iron-Boron Alloy has the highest flux density per unit of volume. The smaller overall size of the Midrange and Tweeter Loudspeakers allows for closer spacing and results in improved sound reproduction.

• Low Harmonic and Intermodulation Distortion

The XCS1K Loudspeaker System is capable of reproducing the full dynamic range of a symphony orchestra with very low audible distortion of any kind.

• High Power Handling

The Loudspeaker Elements and Crossover Components of the XCS1K are all chosen for use with powerful amplifiers up to 1,200 watts.

• Superior Imaging

Locating the Tweeters between the two rows of Midranges generates a symmetrical response for superior imaging.

• Versatile Operation and Placement

In addition to the regular connections, the XCS1K Loudspeaker System provides separate connections for Bi-Amplification and Tri-Amplification hookups.

• Extruded Column

The top, bottom and rear of the XCS1K Low Frequency enclosure is extruded thick aluminum construction with non-parallel internal sides and is given a High Gloss Black Piano Type Finish.

• Gold Plated Input Connectors

The XCS1K input connectors are gold plated for superior corrosion resistance and high electrical conductivity.

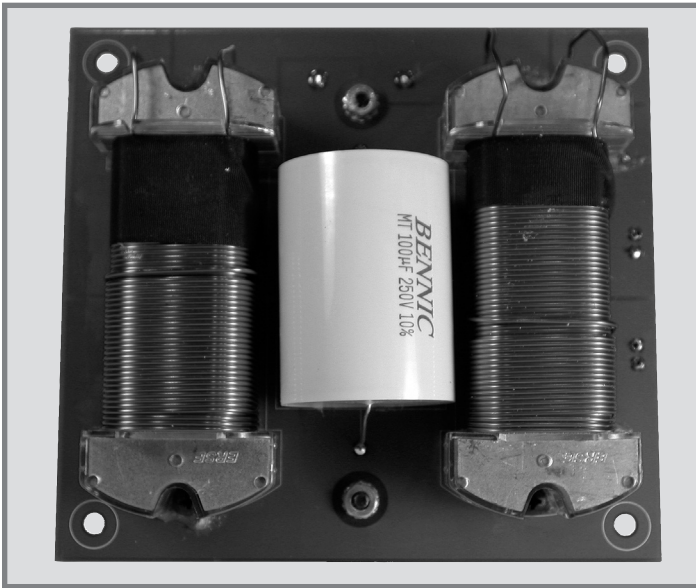

Figure 6



Figure 7

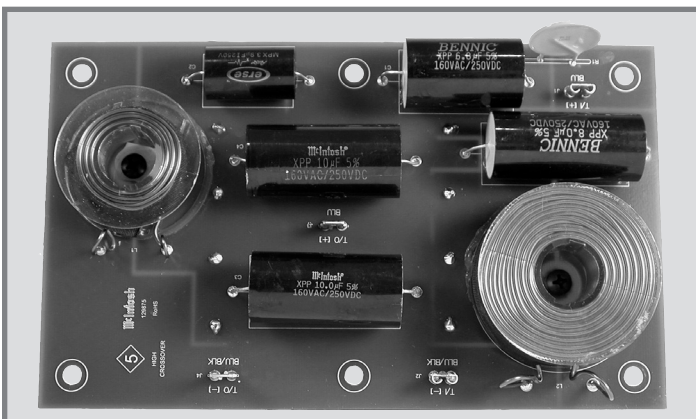

Figure 8



Dimensions

The following dimensions can assist in determining the best location for your XCS1K Loudspeaker System.

**Front View of the
XCS1K
Loudspeaker System**

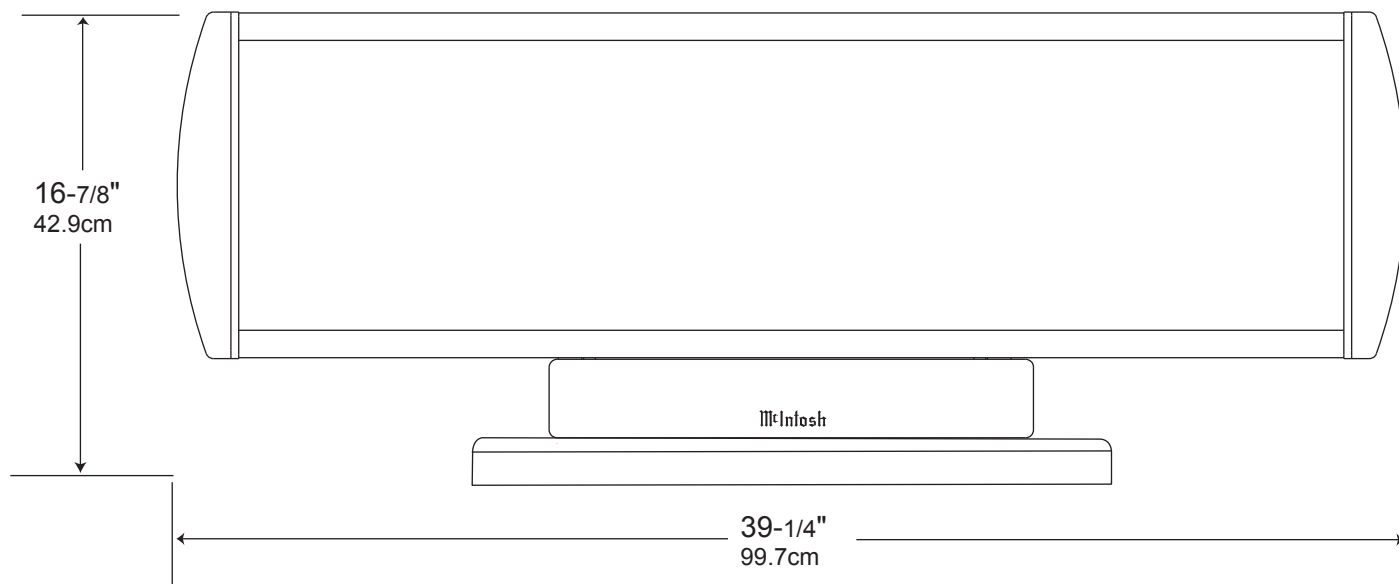

**Side View of the
XCS1K
Loudspeaker System
(shown at maximum
elevation of 30°)**

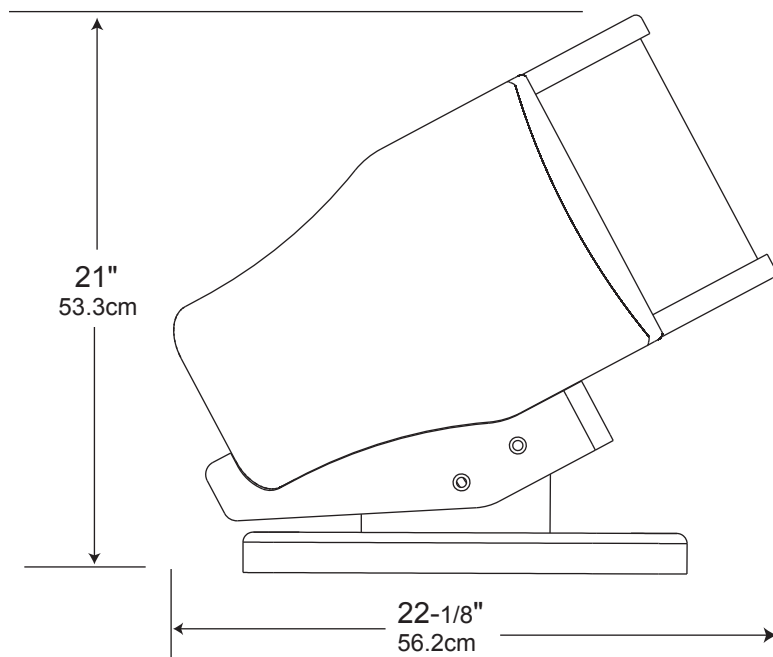

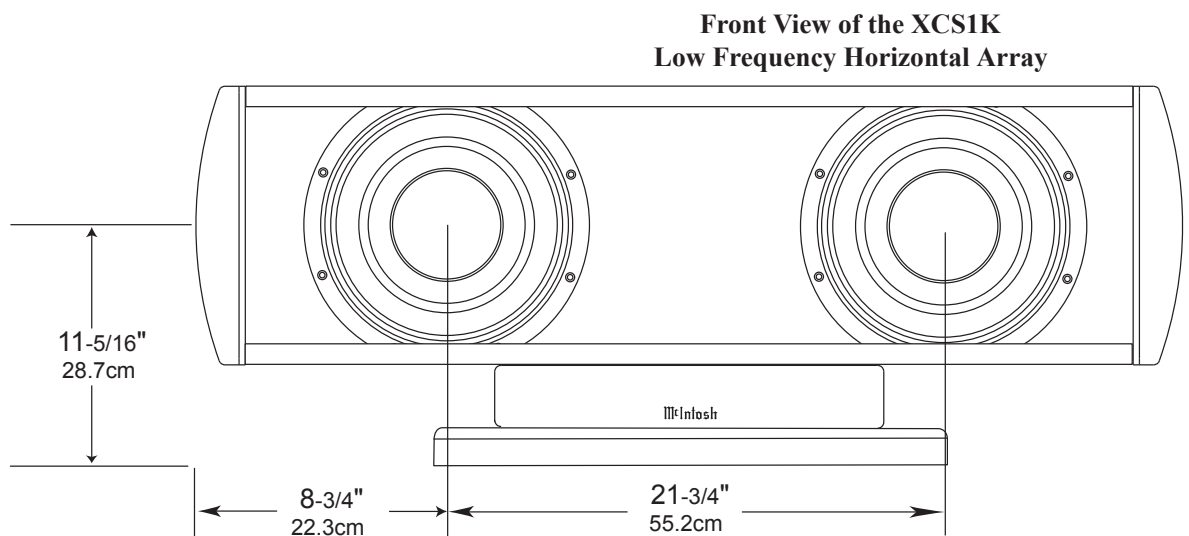
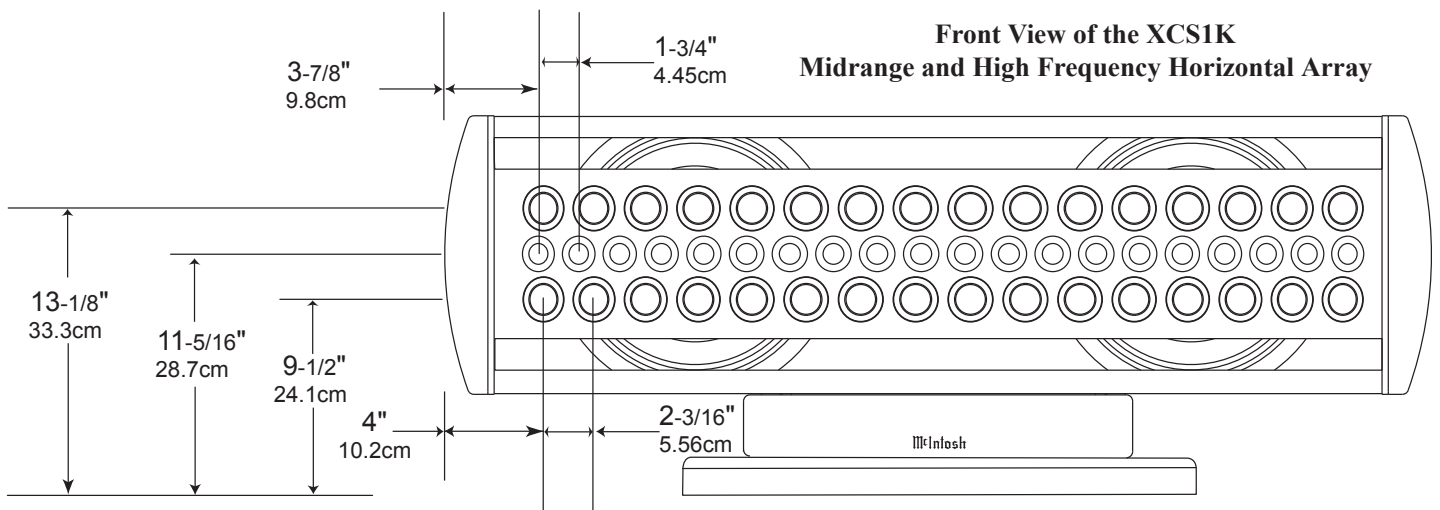
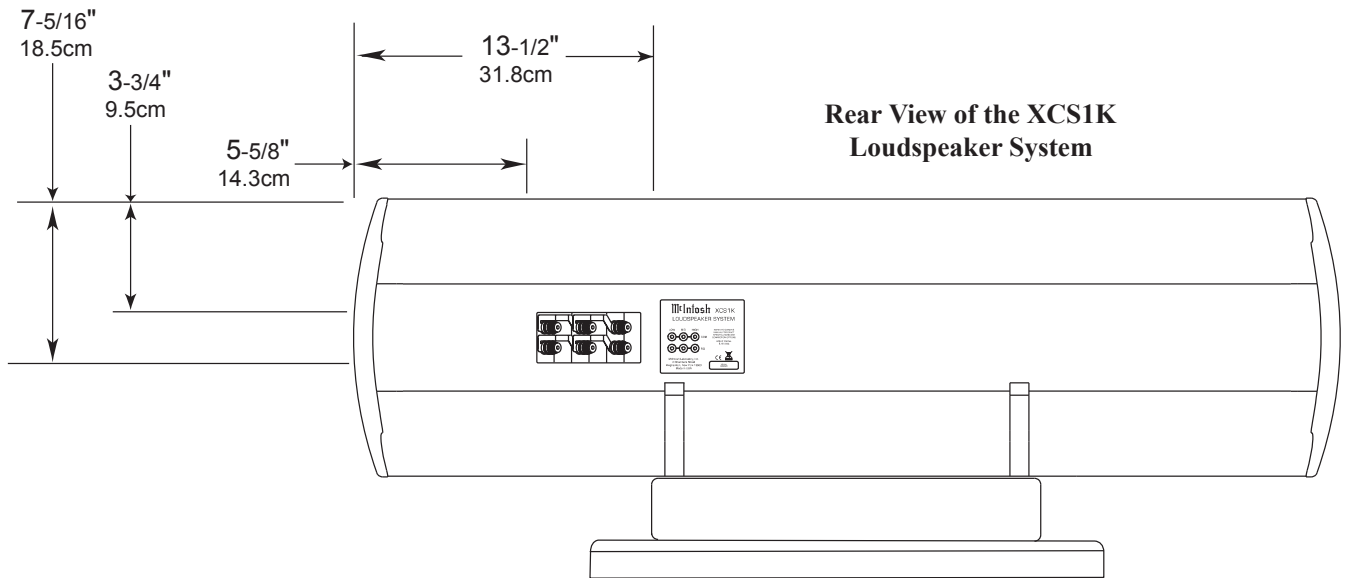

Installation

Location in the Room

The XCS1K Loudspeaker is designed for use as a Center Channel in a Home Theater System. The optimal method for selecting all the Loudspeaker Locations in a Home Theater System includes the use of a real time spectrum analyzer operated by an experienced system installer. An uncompromising installation would take into consideration the floor, wall and ceiling coverings, the type and placement of furniture and can even include the architectural design of the room and its construction materials. In those instances where placement in the room is fixed, an environmental equalizer may be needed to restore proper musical balance.

The XCS1K Loudspeaker's Smooth Frequency Response may be altered by a large object(s) located in the path of the sound waves or by locating the Loudspeaker too close to a side wall. There should be an unobstructed area in front of the XCS1K Loudspeaker on either side of the center axis for the best performance. The optimum location in a Home Theater System is directly under or in front of the TV/Monitor. Refer to figures 9 and 10.

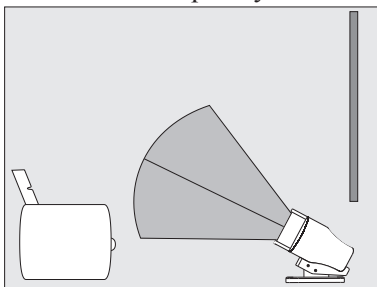

Figure 9

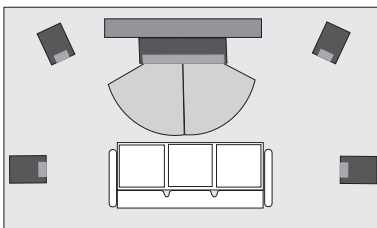

Figure 10

Unpacking the Loudspeaker

To protect the fine finish of the XCS1K Loudspeaker System during the assembly process, it is advisable to prepare a suitable area. A freshly vacuumed carpeted area covered with a soft, clean fabric, such as a large bed linen or blanket would be suitable. Start by unpacking the Loudspeaker.

It is recommended that the Professionals at your McIntosh Dealer, who are skilled in all aspects of installation and operation, install the XCS1K Loudspeaker System and any associated audio equipment.

CAUTION: The XCS1K Loudspeaker weighs 133 pounds (60.3 kgs). It requires two or more persons to safely handle during assembly, adjustment and placement in the room.

1. Orient the XCS1K shipping carton with the arrows on the outside of the carton pointing upward.
2. Remove the banding material from the shipping carton.

3. Lift off the top of the shipping carton and set it aside.
4. Remove the smaller inner carton labeled XCS1K Cradle.
5. Open the inner carton, remove the Cradle and place it in the final location of the XCS1K Loudspeaker. Refer to figure 11.
6. Remove the Top Foam from the Loudspeaker.
7. Remove the Loudspeaker from the Bottom Foam.
8. Remove the Blue Protective Cloth Cover from the Loudspeaker. Set the Loudspeaker and Cover aside on the previously prepared area.

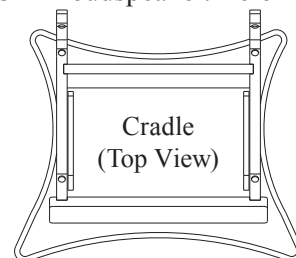

Figure 11

Adjusting the Elevation of the Loudspeaker

The acoustic output of the XCS1K Loudspeaker may be directed to line up with the height of the average ear in the prime viewing/listening area. There is a 30 degree range of adjustment built-in.

1. Using an appropriate tool, loosen the hex head screws on the insides of the XCS1K Cradle. Refer to figure 12.
2. Before placing the XCS1K Loudspeaker on the Cradle, rotate the top/sides of the Cradle to the desired angle so the sound will be directed toward ear level when seated in the main viewing/listening area.
4. Tighten the height adjustment and locking screws on the insides of the Cradle.

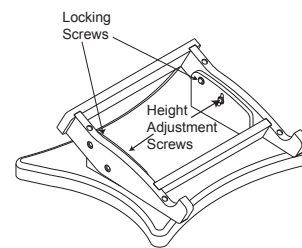

Figure 12

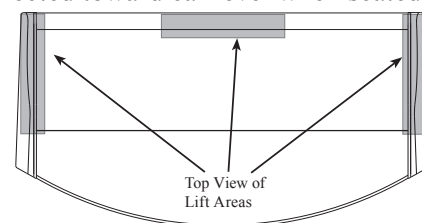

Figure 13

5. Referring to the lift areas in figure 13, lift up on the sides and center rear of the Loudspeaker with two or more persons. Place the Loudspeaker on the Cradle. Refer to figure 14.

Note: When lifting up on the sides of the Loudspeaker, be careful as to not remove the detachable sides.

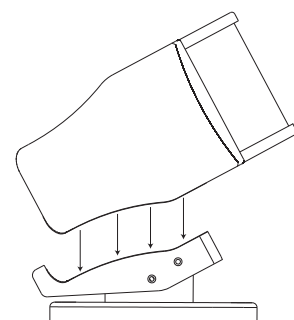

Figure 14

6. Proceed to "How to connect" starting on page 9.

How to Connect using a single Amplifier

Caution: The AC Power Cord should not be connected to the Power Amplifier until after the Loudspeaker Connections have been made. Failure to observe this could result in Electric Shock.

1. Prepare Loudspeaker cables by choosing one of the methods below:

Bare wire cable ends:

Carefully remove sufficient insulation from the cable ends, refer to figures 15, 16 & 17. If the cable is stranded, carefully twist the strands together as tightly as possible.

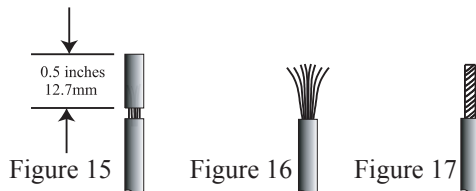

Note: If desired, the twisted ends can be tinned with solder to keep the strands together or attach spade lugs.

Spade lug or prepared wire connection:

Insert the spade lug connector or prepared section of the cable end into the terminal side access hole, and tighten the terminal cap until the cable is firmly clamped into the terminal so the wires cannot slip out. Refer to figures 18, 19 & 20.

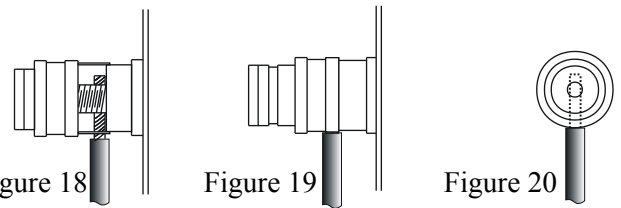

2. Connect a Loudspeaker cable from the XCS1K LOW Frequency COM (-) Binding Post to the (-) Binding Post of the Power Amplifier.

*Notes: 1. It is important to maintain the correct polarity at both ends of the Loudspeaker cables.
2. For proper operation the metal jumpers must be installed between the Loudspeaker Terminal Posts as illustrated.*

3. Connect a Loudspeaker cable from the XCS1K LOW Frequency 8Ω (+) Binding Post to the (8 ohm) Binding Post of the Power Amplifier.
4. Tighten all of the Loudspeaker and Amplifier Binding Posts.

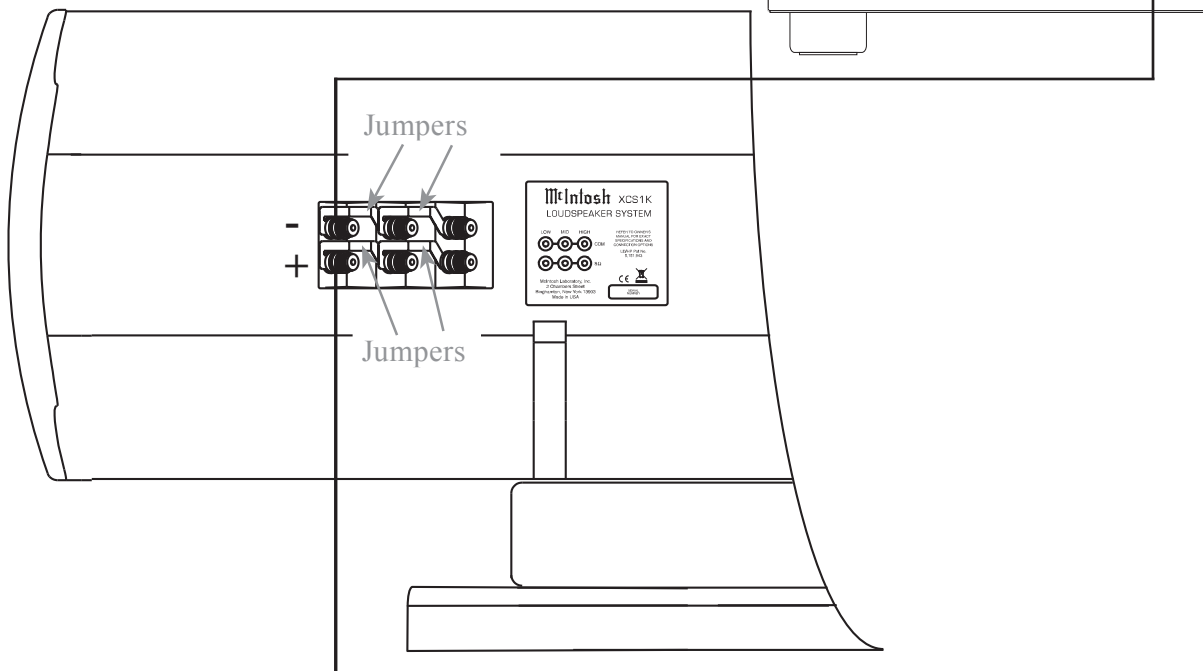
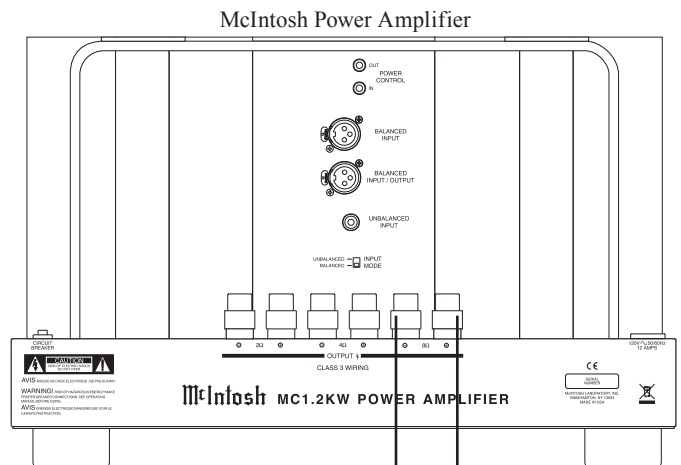

How to Connect using two Amplifiers

Caution: The AC Power Cord should not be connected to the Power Amplifier until after the Loudspeaker Connections have been made. Failure to observe this could result in Electric Shock.

1. Prepare Loudspeaker cables by choosing one of the methods below:

Bare wire cable ends:

Carefully remove sufficient insulation from the cable ends, refer to figures 15, 16 & 17. If the cable is stranded, carefully twist the strands together as tightly as possible.

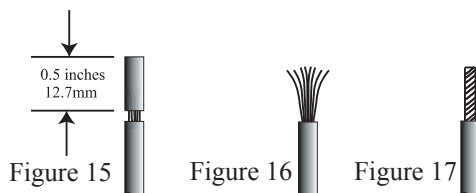

Note: If desired, the twisted ends can be tinned with solder to keep the strands together or attach spade lugs.

Spade lug or prepared wire connection:

Insert the spade lug connector or prepared section of the cable end into the terminal side access hole, and tighten the terminal cap until the cable is firmly clamped into the terminal so the wires cannot slip out. Refer to figures 18, 19 & 20.

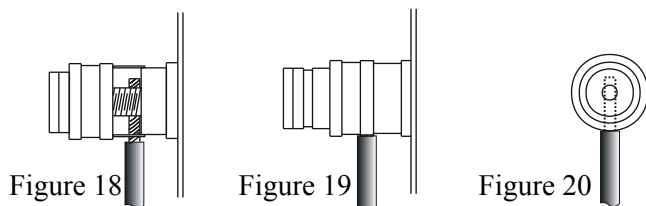

2. Remove the metal jumper between the Loudspeaker LOW Frequency COM (-) Binding Post and MID Frequency COM (-) Binding Post.
3. Remove the metal jumper between the Loudspeaker LOW Frequency 8Ω (+) Binding Post and MID Frequency 8Ω (+) Binding Post.
4. Connect a Loudspeaker cable from the XCS1K LOW Frequency COM (-) Binding Post to the (-) Binding Post of the Power Amplifier number one.

Notes: 1. It is important to maintain the correct polarity at both ends of the Loudspeaker cables.

2. For proper operation the metal jumpers must be installed between the Loudspeaker Terminal Posts as illustrated.

5. Connect a Loudspeaker cable from the XCS1K LOW Frequency 8Ω (+) Binding Post to the (8 ohm) Binding

Post of the Power Amplifier number one.

6. Connect a Loudspeaker cable from the XCS1K MID Frequency COM (-) Binding Post to the (-) Binding Post of the Power Amplifier number two.
7. Connect a Loudspeaker cable from the XCS1K MID Frequency 8Ω (+) Binding Post to the (8 ohm) Binding Post of the Power Amplifier number two.
8. Tighten all of the Loudspeaker and Amplifier Binding Posts.

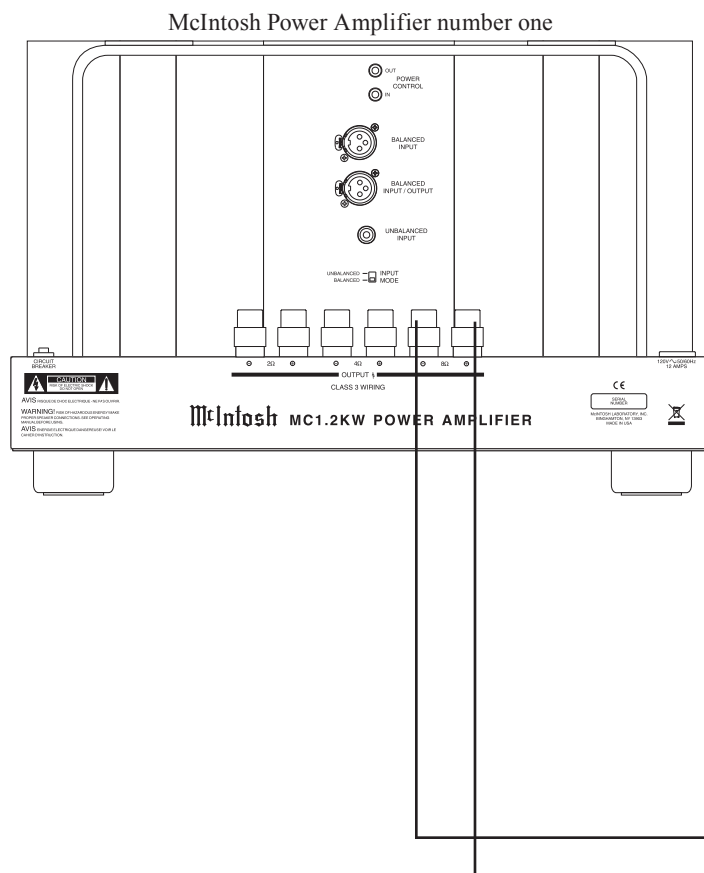

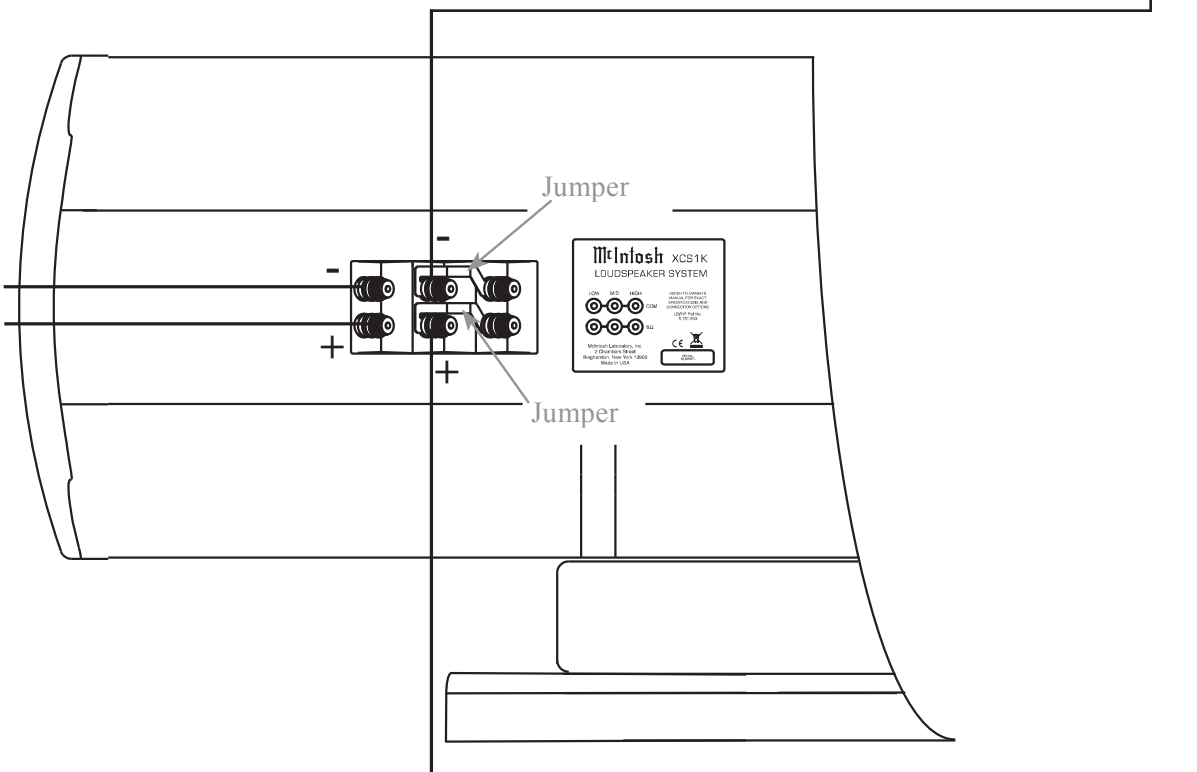
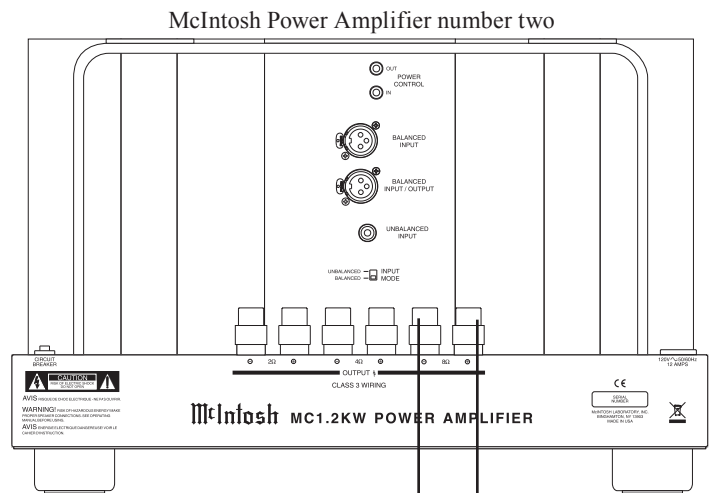

How to Connect using three Amplifiers

Caution: *The AC Power Cord should not be connected to the Power Amplifier until after the Loudspeaker Connections have been made. Failure to observe this could result in Electric Shock.*

1. Prepare Loudspeaker cables by choosing one of the methods below:

Bare wire cable ends:

Carefully remove sufficient insulation from the cable ends, refer to figures 15, 16 & 17. If the cable is stranded, carefully twist the strands together as tightly as possible.

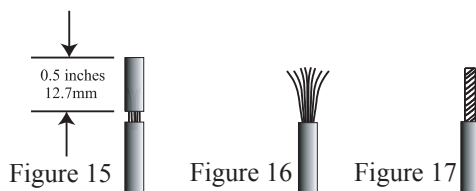

Note: If desired, the twisted ends can be tinned with solder to keep the strands together or attach spade lugs.

Spade lug or prepared wire connection:

Insert the spade lug connector or prepared section of the cable end into the terminal side access hole, and tighten the terminal cap until the cable is firmly clamped into the terminal so the wires cannot slip out. Refer to figures 18, 19 & 20.

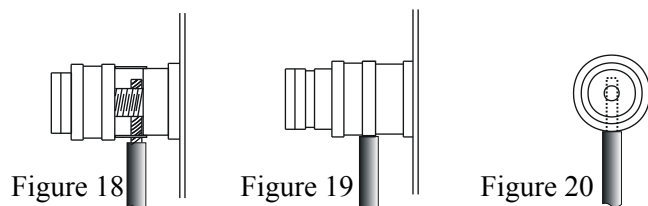

2. Remove all four metal jumpers between Loudspeaker Binding Posts.
4. Connect a Loudspeaker cable from the XCS1K LOW Frequency COM (-) Binding Post to the (-) Binding Post of the Power Amplifier number one.

Note: It is important to maintain the correct polarity at both ends of the Loudspeaker cables.
5. Connect a Loudspeaker cable from the XCS1K LOW Frequency 8Ω (+) Binding Post to the (8 ohm) Binding Post of the Power Amplifier number one.
6. Connect a Loudspeaker cable from the XCS1K MID Frequency COM (-) Binding Post to the (-) Binding Post of the Power Amplifier number two.
7. Connect a Loudspeaker cable from the XCS1K MID Frequency 8Ω (+) Binding Post to the (8 ohm) Binding Post of the Power Amplifier number two.

8. Connect a Loudspeaker cable from the XCS1K HIGH Frequency COM (-) Binding Post to the (-) Binding Post of the Power Amplifier number three.
9. Connect a Loudspeaker cable from the XCS1K HIGH Frequency 8Ω (+) Binding Post to the (8 ohm) Binding Post of the Power Amplifier number three.
10. Tighten all of the Loudspeaker and Amplifier Binding Posts.

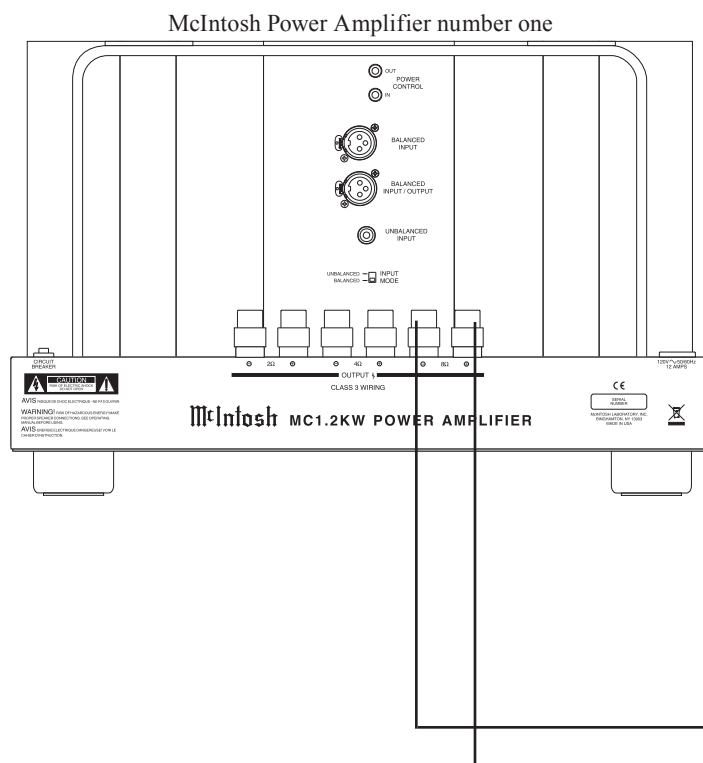

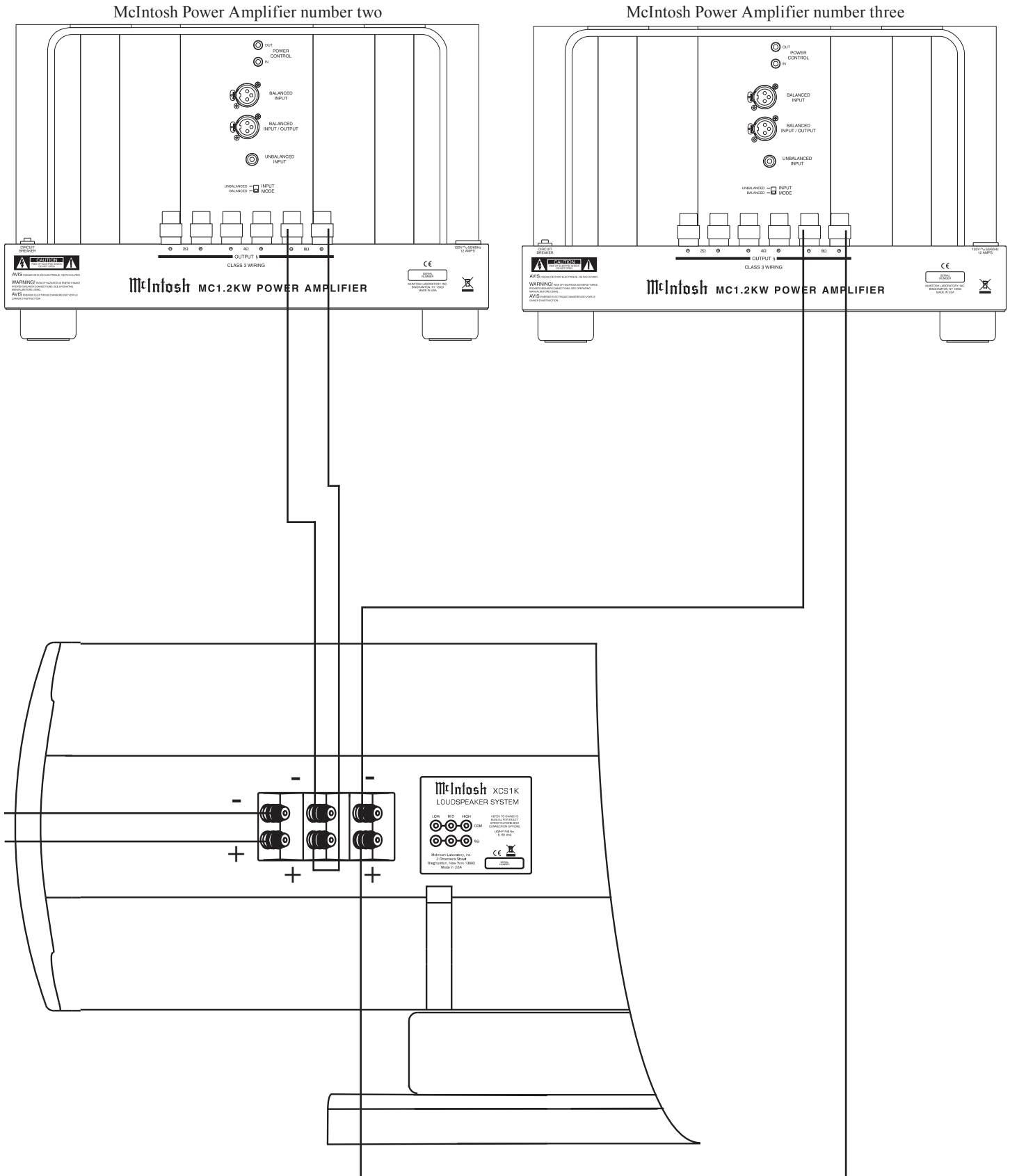



Specifications

System Driver Complement

Two 10 inch LD/HP Woofers
Thirty-Two 2 inch Titanium Inverted
Dome Midranges
Twenty 3/4 inch Titanium Dome Tweeters

Impedance

8 ohms Nominal

Frequency Response

16Hz - 45kHz

Sensitivity

86dB (2.8V/1m equivalent)

Crossover Frequencies

250Hz
1,500Hz

Power Handling

1,200 Watts Maximum

General Specifications

Finish Enclosures

High Gloss Black

Finish Grille

Black Knit Cloth with High Gloss Black Trim

Overall Dimensions

Width is 39-1/4 inches (99.7cm)
Height is 21 inches (53.3cm)
Depth is 22-1/8 inches (56.2cm)

Weight

133 pounds (60.3 kg) Loudspeaker net
15 pounds (6.8 kg) Cradle net
178 pounds (80.7 kg) in shipping carton

Shipping Carton Dimensions

Width is 28 inches (71.1cm)
Depth is 20 inches (50.8cm)
Height is 58 inches (147.3cm)

Packing Instructions

In the event it is necessary to repack the equipment for shipment, the equipment must be packed exactly as shown below. To protect the finish of the Loudspeaker it is advisable to place it in the original protective cotton blue cover before placing it into the shipping carton.

Use the original shipping carton and interior parts only if they are all in good serviceable condition. If a shipping carton or any of the interior part(s) are needed, please call or write Customer Service Department of McIntosh Laboratory. Please see the Part List for the correct part numbers.

Quantity	Part Number	Description
1	034431	Top shipping carton
1	034432	Bottom shipping carton
2	034433	Top and bottom foam
1	034430	Blue Protective cloth cover
1	034434	Cradle carton
1	033085	Bubble pack

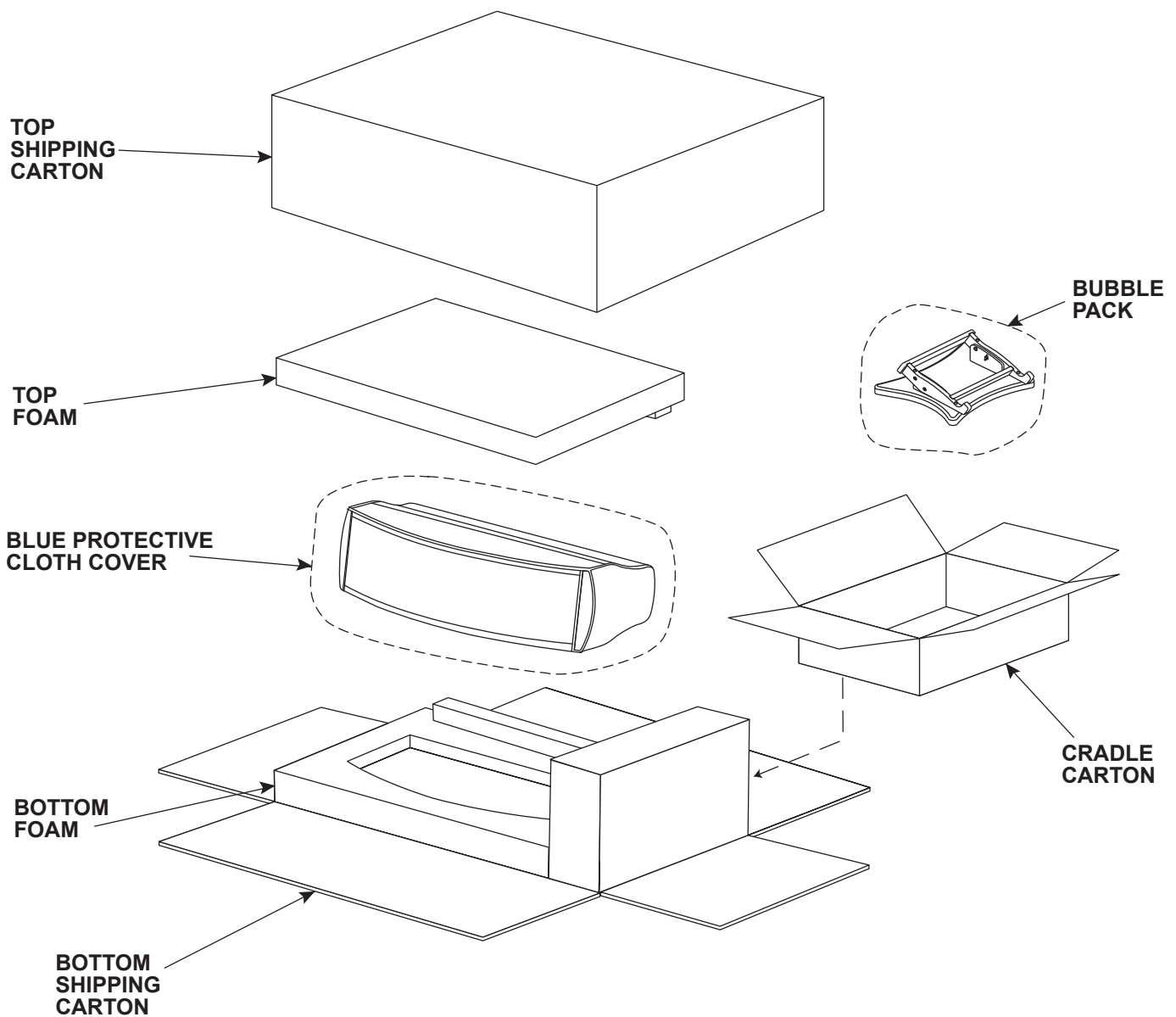



McIntosh Laboratory, Inc.
2 Chambers Street
Binghamton, NY 13903

The continuous improvement of its products is the policy of McIntosh Laboratory Incorporated who reserve the right to improve design without notice. Printed in the U.S.A.

McIntosh Part No. 04107900

Free Manuals Download Website

<http://myh66.com>

<http://usermanuals.us>

<http://www.somanuals.com>

<http://www.4manuals.cc>

<http://www.manual-lib.com>

<http://www.404manual.com>

<http://www.luxmanual.com>

<http://aubethermostatmanual.com>

Golf course search by state

<http://golfingnear.com>

Email search by domain

<http://emailbydomain.com>

Auto manuals search

<http://auto.somanuals.com>

TV manuals search

<http://tv.somanuals.com>