

# OPERATION AND PARTS MANUAL



## WHISPERWATT™ SERIES MODEL DCA-220SSJ 60 Hz GENERATOR

PARTS LIST NO. C1870300404

Revision #1 (03/22/07)

**THIS MANUAL MUST ACCOMPANY  
THE EQUIPMENT AT ALL TIMES.**



# **WARNING**



**CALIFORNIA — Proposition 65 Warning**

**Diesel engine exhaust and some of its constituents are known to the State of California to cause cancer, birth defects and other reproductive harm.**



**MQ POWER DCA-220SSJ  
WHISPERWATT™ GENERATOR**

California Proposition 65 Warning ..... 2  
 Table Of Contents ..... 4  
 Parts Ordering Procedures ..... 5  
 Specifications ..... 6  
 Dimensions (Top, Side, Front) ..... 7  
 Safety Message Alert Symbols ..... 8-9  
 Rules for Safe Operation ..... 10-13  
 Generator Decals ..... 14-15  
 Installation ..... 16-17  
 General Information ..... 18  
 Major Components ..... 19  
 Diagnostic Display ..... 20-36  
 Generator Control Panel ..... 37  
 Engine Operating Panel ..... 38-39  
 Output Terminal Panel Familiarization ..... 40-42  
 Load Application ..... 43  
 Generator Outputs ..... 44  
 Gauge Reading ..... 45  
 Output Terminal Panel Connections ..... 46  
 Setup ..... 47  
 Generator Start-up Procedure (Manual) ..... 52-54  
 Generator Start-up Procedure (Auto Mode) ..... 55  
 Generator Shut-Down Procedure ..... 56  
 Maintenance (Engine) ..... 57-58  
 Maintenance Jacket Water Heater/Battery Charger ..... 59  
 Maintenance (Trailer) ..... 60-63  
 Trailer Wiring Diagram ..... 64  
 Generator Wiring Diagram ..... 65  
 Engine Wiring Diagram ..... 66  
 Generator Troubleshooting ..... 67  
 Engine Controller Troubleshooting ..... 68  
 Explanation of Code in Remarks Column ..... 70  
 Suggested Spare Parts ..... 71

**COMPONENT DRAWINGS**

Generator Assembly ..... 72-74  
 Control Panel Assembly ..... 76-77  
 Control Box Assembly ..... 78-81  
 Engine and Radiator Assembly ..... 82-87  
 Output Terminal Assembly ..... 88-89  
 Battery Assembly ..... 90-91  
 Muffler Assembly ..... 92-93  
 Fuel Tank Assembly ..... 94-95  
 Enclosure Assembly ..... 96-101  
 Rubber Seals Assembly ..... 102-103  
 Nameplate and Decals ..... 104-105  
 Terms and Condition of Sale — Parts ..... 106

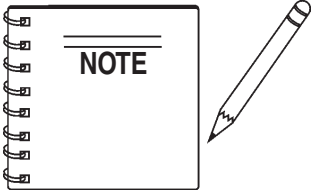

*Specification and part number are subject to change without notice.*

# PARTS ORDERING PROCEDURES

## When ordering parts, please supply the following information:

- Dealer account number
- Dealer name and address
- Shipping address (if different than billing address)
- Return fax number
- Applicable model number
- Quantity, part number and description of each part
- Specify preferred method of shipment:
  - ✓ FedEx or UPS Ground
  - ✓ FedEx or UPS Second Day or Third Day
  - ✓ FedEx or UPS Next Day
  - ✓ Federal Express Priority One
  - ✓ DHL
  - ✓ Truck

*Note: Unless otherwise indicated by customer, all orders are treated as "Standard Orders", and will ship within 24 hours. We will make every effort to ship "Air Shipments" the same day that the order is received, if prior to 2PM west coast time. "Stock Orders" must be so noted on fax or web forms.*



## Here's how to get help...

*Please have the model and serial number on hand when calling.*

### MQ POWER CORPORATE OFFICE

18910 Wilmington Ave. 800-421-1244  
 Carson, CA 90746 FAX: 310-632-2656  
 Email: mqpower@multiquip.com  
 Internet: www.mqpower.com

### PARTS DEPARTMENT

800-427-1244 FAX: 800-672-7877  
 310-537-3700 FAX: 310-637-3284

### SERVICE DEPARTMENT

800-835-2551 FAX: 310-638-8046  
 310-537-3700

### TECHNICAL ASSISTANCE

800-835-2551 FAX: 310-638-8046

### WARRANTY DEPARTMENT

800-835-2551, EXT. 279 FAX: 310-638-8046  
 310-537-3700, EXT. 279

## Place Your Parts Order Via Web or Fax For Even More Savings!

*(Domestic USA Dealers Only)*

### Extra Discounts!

All parts orders which include complete part numbers and are received by our automated web parts order system, or by fax qualify for the following extra discounts:

Ordered via	Standard orders	Stock orders (\$750 list and above)
Fax	3%	10%
Web	5%	10%

### Special freight allowances when you order 10 or more line items via Web or Fax! \*\*

FedEx Ground Service **at no charge for freight**

*No other allowances on freight shipped by any other carrier.*

**\*\*Common nuts, bolts and washers (all items under \$1.00 list price) do not count towards the 10+ line items.**

NOTE: DISCOUNTS ARE SUBJECT TO CHANGE



**MQPOWER**  
 A Division of Multiquip Inc.  
 POST OFFICE BOX 6254  
 CARSON, CA 90749  
 310-537-3700 • 800-421-1244  
 FAX: 310-632-2656  
 E-MAIL: mqpower@multiquip.com  
 INTERNET: www.mqpower.com

## Direct TOLL-FREE access to our Parts Department:

Toll-free nationwide — 800-427-1244

Toll-free FAX — 800-6-PARTS-7 (800/672-7877)

# DCA-220SSJ — SPECIFICATIONS

<b>Table 1. Generator Specifications</b>	
<b>Model</b>	<b>DCA-220SSJU</b>
<b>Type</b>	Revolving field, self ventilated, open protected type synchronous generator
<b>Armature Connection</b>	<b>Star with Neutral</b>
<b>Phase</b>	3
<b>Standby Output</b>	242 KVA (194 KW)
<b>Prime Output</b>	220 KVA (176 KW)
<b>Voltage</b>	240, OR 480V
<b>Frequency</b>	60 Hz
<b>Speed</b>	1800 rpm
<b>Power Factor</b>	0.8
<b>AUX. AC Power</b>	Single Phase, 60 Hz
<b>Voltage</b>	120V
<b>Output</b>	4.8 KW (2.4 KW X 2)
<b>Dry Weight</b>	6,895 lbs. (3,130 kg.)
<b>Wet Weight</b>	7,753 lbs. (3,520 kg.)
<b>Table 2. Engine Specifications</b>	
<b>Model</b>	<b>JOHN DEERE 6068HF485</b>
<b>Type</b>	4 cycle, water-cooled, direct injection, turbo-charged, air-air
<b>No. of Cylinders</b>	6 cylinders
<b>Bore x Stroke</b>	4.17 in. x 5.00 in. (106 mm x 127 mm)
<b>Rated Output</b>	286H.P./1800RPM
<b>Displacement</b>	415 cu. in. (6.8 liters)
<b>Starting</b>	Electric 12VDC
<b>Coolant Capacity</b>	6.4 gal. (24 liters)
<b>Lube Oil Capacity</b>	8.19 gal. (31 liters)
<b>Fuel Type</b>	#2 Diesel Fuel
<b>Fuel Tank Capacity</b>	100 gal. (380 liters)
<b>Fuel Consumption</b>	13.63 gal. (51.6 L)/hr at <b>full load</b>
<b>Battery</b>	128Ah x 1

# DCA-220SSJ — DIMENSIONS (TOP, SIDE AND FRONT)

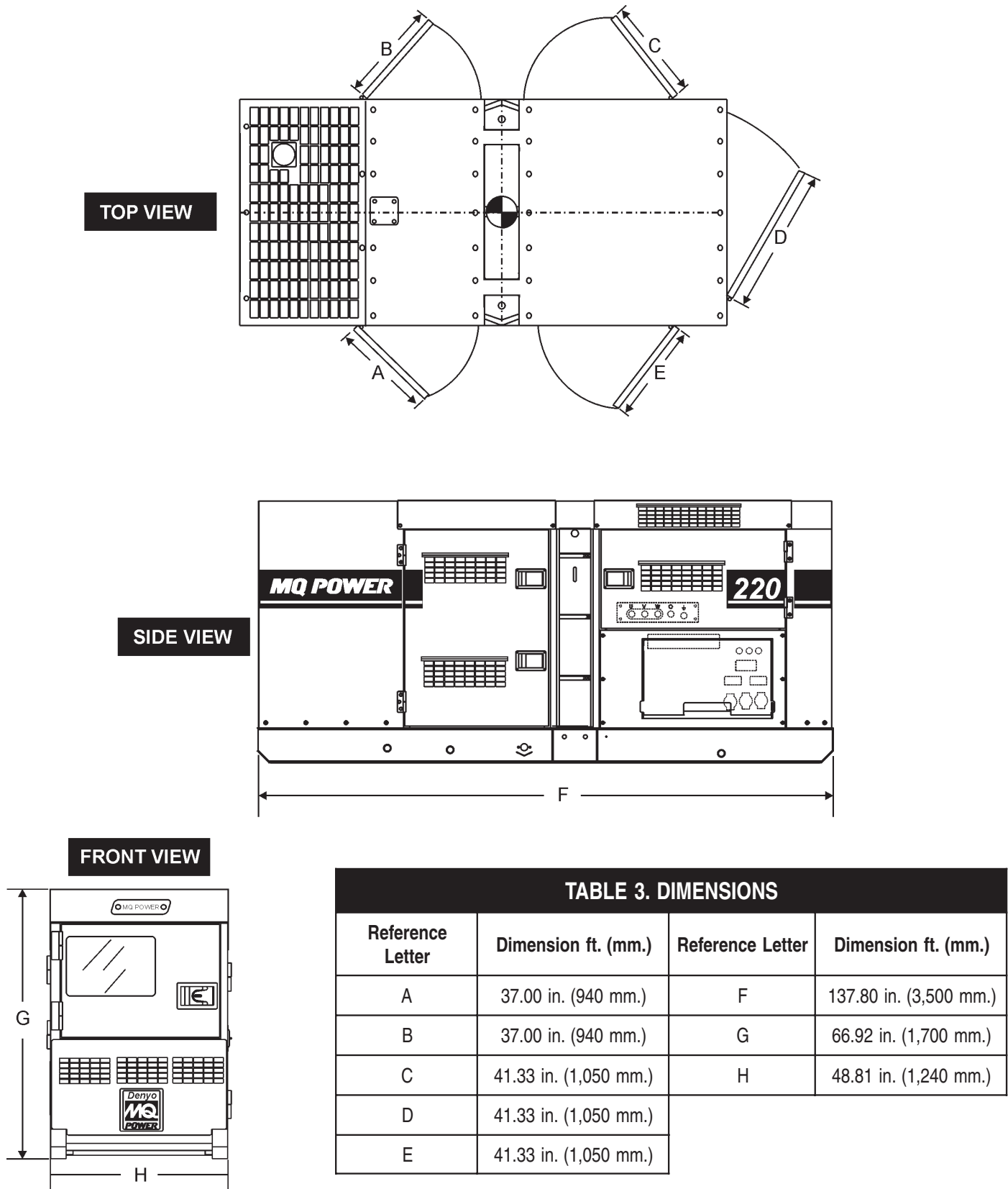
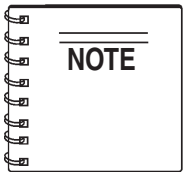

Figure 1. Dimensions

# DCA-220SSJ — SAFETY MESSAGE ALERT SYMBOLS

## FOR YOUR SAFETY AND THE SAFETY OF OTHERS!

Safety precautions should be followed at all times when operating this equipment. Failure to read and understand the Safety Messages and Operating Instructions could result in injury to yourself and others.



This Owner's Manual has been developed to provide complete instructions for the safe and efficient operation of the MQ Power **Model DCA-220SSJ Whisperwatt™ Generator**.

**Before using this generator, ensure that the operating individual has read and understands all instructions in this manual.**

## SAFETY MESSAGE ALERT SYMBOLS

The three (3) Safety Messages shown below will inform you about potential hazards that could injure you or others. The Safety Messages specifically address the level of exposure to the operator, and are preceded by one of three words: **DANGER**, **WARNING**, or **CAUTION**.

### **DANGER**

You **WILL** be **KILLED** or **SERIOUSLY** injured if you do not follow directions.

### **WARNING**

You **COULD** be **KILLED** or **SERIOUSLY** injured if you do not follow directions.

### **CAUTION**

You **CAN** be injured if you do not follow directions

## HAZARD SYMBOLS

Potential hazards associated with the operation of this equipment will be referenced with "**Hazard Symbols**" which appear throughout this manual, and will be referenced in conjunction with Safety "**Message Alert Symbols**".

### **WARNING - LETHAL EXHAUST GASES**



Gasoline engine exhaust gases contain poisonous carbon monoxide. This gas is colorless and odorless, and can cause **DEATH** if inhaled. **NEVER** operate this equipment in a confined area or enclosed structure that does not provide ample free flow air.

### **WARNING - EXPLOSIVE FUEL**

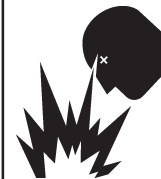

**Gasoline** is extremely flammable, and its vapors can cause an explosion if ignited. **DO NOT** start the engine near spilled fuel or combustible fluids. **DO NOT** fill the fuel tank while the engine is running or hot.

**DO NOT** overfill tank, since spilled fuel could ignite if it comes into contact with hot engine parts or sparks from the ignition system. Store fuel in approved containers, in well-ventilated areas and away from sparks and flames. **NEVER** use fuel as a cleaning agent.

### **WARNING - BURN HAZARDS**



Engine components can generate extreme heat. To prevent burns, **DO NOT** touch these areas while the engine is running or immediately after operations. **NEVER** operate the engine with heat shields or heat guards removed.

### **DANGER - ELECTROCUTION HAZARDS**

During operation of this generator, there exists the possibility of **electrocution**, **electrical shock or burn**, which can cause **severe bodily harm** or even **DEATH!**





# DCA-220SSJ — SAFETY MESSAGE ALERT SYMBOLS

## WARNING - ROTATING PARTS



**NEVER** operate equipment with covers, or guards removed. Keep **fingers, hands, hair** and clothing away from all moving parts to prevent injury.

## CAUTION - RESPIRATORY HAZARDS



**ALWAYS** wear approved **respiratory** protection.

## CAUTION - ACCIDENTAL STARTING



**ALWAYS** place the **MPEC** control switch in the **OFF/RESET** position when the generator is not in use.

## CAUTION - SIGHT AND HEARING HAZARDS



**ALWAYS** wear approved **eye** and **hearing** protection.

## CAUTION - OVER-SPEED CONDITIONS



**NEVER** tamper with the factory settings of the engine governor or settings. Personal injury and damage to the engine or equipment can result if operating in speed ranges above maximum allowable.

## CAUTION - EQUIPMENT DAMAGE MESSAGES

Other important messages are provided throughout this manual to help prevent damage to your generator, other property, or the surrounding environment.

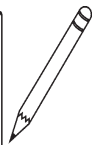
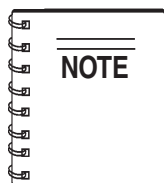

This generator, other property, or the surrounding environment could be damaged if you do not follow instructions.

# DCA-220SSJ — RULES FOR SAFE OPERATION

## DANGER - READ THIS MANUAL!

Failure to follow instructions in this manual may lead to **serious injury** or even **DEATH!** This equipment is to be operated by trained and qualified personnel only! This equipment is for industrial use only.

The following safety guidelines should always be used when operating the **DCA-220SSJ Whisperwatt™ AC Generator**.

### General Safety:

- **DO NOT** operate or service this equipment before reading this entire manual.



The operator **MUST BE** familiar with proper safety precautions and operations techniques before using generator.

- This equipment should not be operated by persons under 18 years of age.
- **NEVER** operate this equipment without proper protective clothing, shatterproof glasses, steel-toed boots and other protective devices required by the job.



- **NEVER** operate this equipment when not feeling well due to fatigue, illness or taking medicine.
- **NEVER** operate this equipment under the influence or drugs or alcohol.



- **NEVER** use accessories or attachments, which are not recommended by MQ Power for this equipment. Damage to the equipment and/or injury to user may result.
- Manufacturer does not assume responsibility for any accident due to equipment modifications. Unauthorized equipment modification will void all warranties.
- Whenever necessary, replace nameplate, operation and safety decals when they become difficult read.

- **ALWAYS** check the machine for loosened threads or bolts before starting.

- **NEVER** operate the generator in an explosive atmosphere or near combustible materials. An explosion or fire could result causing severe **bodily harm or even death**.

- **NEVER** touch the hot exhaust manifold, muffler or cylinder. Allow these parts to cool before servicing engine or generator.



- **High Temperatures** – Allow the engine to cool before performing service and maintenance functions. Contact with **hot!** components can cause serious burns.

- The engine of this generator requires an adequate free flow of cooling air. **NEVER** operate the generator in any enclosed or narrow area where free flow of the air is restricted. If the air flow is restricted it will cause serious damage to the generator or engine and may cause injury to people. The generator engine gives off **DEADLY** carbon monoxide gas.

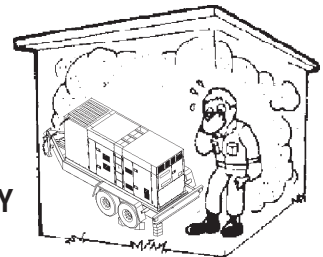

- **DO NOT** place hands or fingers inside generator engine compartment when engine is running.
- **NEVER** run engine without air filter. Severe engine damage may occur.
- **DO NOT** leave the generator running in the **manual mode** unattended.
- Refer to the **John Deere Engine Owner's Manual** for engine technical questions or information.
- **ALWAYS** store equipment properly when it is not being used. Equipment should be stored in a clean, dry location out of the reach of children.

## Generator Grounding

To guard against electrical shock and possible damage to the equipment, it is important to provide a good **EARTH** ground.

Article 250 (Grounding) of the **National Electrical Code** (NEC) provides guide lines for proper grounding and specifies that the cable ground shall be connected to the grounding system of the building as close to the point of cable entry as practical.

The following safety recommendations should also be followed:

- **ALWAYS** make sure generator is properly grounded.
- **NEVER** use gas piping as an electrical ground.
- **ALWAYS** make sure that electrical circuits are properly **grounded** per the **National Electrical Code** (NEC) and local codes before operating generator. Severe **injury** or **DEATH!** by electrocution can result from operating an ungrounded generator.
- **ALWAYS** be sure to use the ground terminal (green wire) when connecting a load to the U,V, and W output terminal lugs.

## Electrical Safety

- **ALWAYS** have a qualified electrician perform the generator wiring installation.
- **ALWAYS** make sure generator installation is accordance with the **National Electrical Code** (NEC) and local codes before operating generator.
- **NEVER** use a defective or frayed power cable. Check the cable for cuts in the insulation.
- **NEVER** use a extension cord that is frayed or damaged where the insulation has been cut.
- **ALWAYS** make certain that proper extension cord has been selected for the job. See Table 6.
- **NEVER** power cables or cords **lay in water**.
- **NEVER stand in water** while AC power from the generator is being transfer to a load.

## ⚠ DANGER - ELECTROCUTION HAZARDS

During operation of this generator, there exists the possibility of **electrocution, electrical shock or burn**, which can cause **severe bodily harm** or even **DEATH!**



To avoid these hazards:

**NEVER** use damaged or worn cables when connecting equipment to the generator. Make sure power connecting cables are securely connected to the generator's output terminals, insufficient tightening of the terminal connections may cause damage to the generator and electrical shock.

**NEVER** grab or touch a live power cord with wet hands.

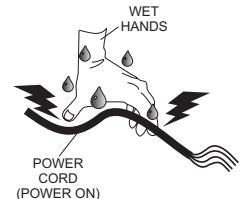

**NEVER** touch output terminals during operation. This is extremely dangerous. **ALWAYS** stop the machine and place the circuit breaker in the **OFF** position when contact with the output terminals is required.

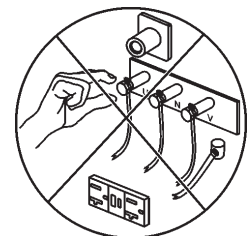

Backfeed to a utility system can cause **electrocution** and or property damage. **DO NOT** connect to any building's electrical system except through an approved device or after building main switch is opened. **ALWAYS** have a licensed electrician perform the installation

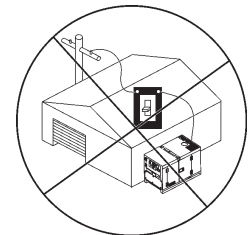

# DCA-220SSJ — RULES FOR SAFE OPERATION

## Maintenance Safety

- The electrical voltage required to operate the generator can cause severe injury or even death through physical contact with live circuits. Turn all circuit breakers **OFF** before performing maintenance on the generator.
- **NEVER** lubricate components or attempt service on a running machine.
- **ALWAYS** disconnect the **NEGATIVE battery terminal** before performing service on the generator.
- Follow all Battery Safety Guidelines listed in this manual when handling or servicing the generator.
- **ALWAYS** allow the machine a proper amount of time to cool before servicing.
- Keep the machinery in proper running condition.
- Fix damage to the machine immediately and always replace broken parts.
- **ALWAYS** service air cleaner frequently to prevent engine malfunction.

## WARNING - BURN HAZARDS

To prevent burns, **DO NOT** touch or open any of the below mentioned components while the engine is running or immediately after operations. Always allow sufficient time for the engine and generator to cool before performing maintenance.



- **Radiator Cap** - Removing the radiator cap while the engine is hot will result in high pressurized, boiling water to gush out of the radiator, causing severe scalding to any persons in the general area of the generator.
- **Coolant Drain Plug** - Removing the coolant drain plug while the engine is hot will result in hot coolant gushing out of the coolant drain plug, therefore causing severe scalding to any persons in the general area of the generator.
- **Engine Oil Drain Plug** - Removing the engine oil drain plug while the engine is hot will result in hot oil gushing out of the oil drain plug, therefore causing severe scalding to any persons in the general area of the generator.

## Battery Safety

Use the following guidelines when handling the battery:

- The battery contains acids that can cause injury to the eyes and skin. To avoid eye irritation, **always** wear safety glasses.
- Use well insulated gloves when picking up the battery.

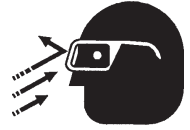

## ! DANGER - EXPLOSION HAZARDS

The risk of an explosion exists when performing service on the battery. To avoid **severe injury** or **DEATH**:

- **DO NOT** drop the battery. There is the possibility of risk that the battery may explode.
- **DO NOT** expose the battery to open flames, sparks, cigarettes etc. The battery contains combustible gases and liquids. If these gases and liquids come in contact with a flame or spark, an explosion could occur.

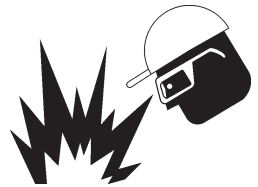

- **ALWAYS** keep the battery charged. If the battery is not charged a buildup of combustible gas will occur.
- **ALWAYS** keep battery charging and cables in good working condition. Repair or replace all worn cables.
- **ALWAYS** recharge the battery in an vented air environment, to avoid risk of a dangerous concentration of combustible gases.
- In case the battery liquid (dilute sulfuric acid) comes in contact with **clothing or skin**, rinse skin or clothing immediately with plenty of water.
- In case the battery liquid (dilute sulfuric acid) comes in contact with your **EYES**, rinse eyes immediately with plenty of water and contact the nearest doctor or hospital to seek medical attention.

## Towing & Transporting Safety

To reduce the possibility of an accident while transporting the generator on public roads, always make sure the trailer that supports the generator and the towing vehicle are in good operating condition and both units are mechanically sound.

The following list of safety precautions should be followed when towing your generator:

### CAUTION - FOLLOW TOWING REGULATIONS

Check with your local county or state safety towing regulations, in addition to meeting **Department of Transportation (DOT) Safety Towing Regulations**, before towing your generator.

- **ALWAYS** shutdown engine before transporting.
- Tighten both fuel tank caps securely.
- If generator is mounted on a trailer, make sure trailer complies with all local and state safety transportation laws. Follow the listed **Towing & Transporting Safety** guidelines for basic towing techniques.
- Make sure the hitch and coupling of the towing vehicle are rated equal to, or greater than the trailer "gross vehicle weight rating."
- **ALWAYS** inspect the hitch and coupling for wear. **NEVER** tow a trailer with defective hitches, couplings, chains etc.
- Check the tire air pressure on both towing vehicle and trailer. **Trailer tires should be inflated to 50 psi cold.** Also check the tire tread wear on both vehicles.
- **ALWAYS** make sure the trailer is equipped with a "Safety Chain".
- **ALWAYS** attach trailer's safety chains to towing vehicle properly.
- **ALWAYS** make sure the vehicle and trailer directional, backup, brake, and trailer lights are connected and working properly.
- DOT Requirements include the following:
  - Connect and test electric brake operation.
  - Secure portable power cables in cable tray with tie wraps.

- The maximum speed for highway towing is **55 MPH** unless posted otherwise. Recommended off-road towing is not to exceed **15 MPH** or less depending on type of terrain.
- Place **chock blocks** underneath wheel to prevent **rolling**, while parked.
- Use the trailer's swivel jack to adjust the trailer height to a level position while parked.
- Avoid sudden stops and starts. This can cause skidding, or jack-knifing. Smooth, gradual starts and stops will improve towing.
- Avoid sharp turns.
- Trailer should be adjusted to a level position at all times when towing.
- Raise and lock trailer wheel stand in up position when transporting.
- The maximum speed for highway towing is **55 MPH** unless posted otherwise. Recommended off-road towing is not to exceed **15 MPH** or less depending on type of terrain.
- Place **support blocks** underneath the trailer's bumper to prevent **tipping**, while parked.
- Avoid sharp turns to prevent rolling.
- **DO NOT** transport generator with fuel in tank.

## Emergencies

- **ALWAYS** know the location of the nearest **fire extinguisher**.
- **ALWAYS** know the location of the nearest and **first aid kit**.
- **ALWAYS** know the location of the nearest phone or **keep a phone on the job site**, in case of emergencies.
- **ALWAYS** have easy access to the phone numbers of the nearest **Ambulance, Doctor** and **Fire Department**. This information will be invaluable in the case of an emergency.





# DCA-220SSJ — GENERATOR DECALS

The DCA-220SSJ generator is equipped with a number of safety decals (Figures 2 & 3). These decals are provided for operator safety and maintenance information. The illustration below and on the preceding page show the decals as they appear on the machine. Should any of these decals become unreadable, replacements can be obtained from your dealer.

**OPERATING PROCEDURES**

**Manual Starting**

1. Check the engine oil, coolant, and fuel levels. Replenish if necessary.
2. Place all Generator Circuit Breakers in the "OFF" position and close all doors.
3. Check that the Voltage select switch (or the Voltage change-over board) is present at desired voltage.  
(In case of generator having multiple voltage ratings.)
4. Set the Engine speed switch to the "LOW" position.
5. Turn the Auto-Off/Reset-Manual switch to the "Manual" position to start the engine. If the engine fails to start in the specified number of attempts, the overcrank lamp will indicate and the Auto-Off/Reset-Manual switch must be returned to the "Off/Reset" position before proceeding.
6. When the engine is ready for starting during cold weather operating conditions, push the water heater button for approximately 30 seconds. Start engine using the Auto-Off/Reset-Manual switch to the "Manual" position. As soon as the engine starts, release the button.  
If the engine still does not start, utilize the water heater until water is warm. (If additional water heater is supplied.)
7. After starting, allow the engine to run for 1 or 2 minutes to warm-up. At temperatures below freezing, this time period must be extended to 2 to 4 minutes.
8. When the engine starts, immediately check for abnormal noise, vibration, fluid leakage or any indication of a problem. Check the control panel gauges. If all is normal, let the engine remain at the "Low" position for a short time, depending on the ambient conditions, warm up.
9. After sufficient warm-up time has elapsed, set the Engine speed switch to the "High" position and the unit is ready for operation.
10. Check the NO-Load speed as shown in the table below.  
60Hz operation—Approx. 60.0Hz (1800rpm)
11. Adjust the Voltage Regulator to the specified voltage.

**Manual Stopping**

1. Place the Generator Circuit Breakers in the "OFF" position.
2. Set the Engine speed switch to the "LOW" position, and allow the unit to cool for a few minutes.
3. Turn the Auto-Off/Reset-Manual switch, to the "Off/Reset" position.

**Auto Starting/Stopping**

1. With the Auto/Manual switch in the Auto position, the Auto Starting/Stopping controller monitors remote start contacts. Closure of the remote start contacts will begin engine cranking. When the contacts are opened cranking will stop. If cranking the engine will stop. All functions for the Automatic shutdown System work as in Manual Starting/stopping.
2. For cold weather conditions utilize the water heater until water is warm. If the engine still does not start, please operate as in Manual Starting.

**Emergency Stopping**

1. Place the Generator Circuit Breakers in the "OFF" position.
2. Turn the Auto-Off/Reset-Manual switch to the "Off/Reset" position.

M35200010

P/N M3552000103

**SAFETY INSTRUCTIONS**

Improper operation of this machine can cause severe injury or death.

- Read the instruction manual carefully before operating or servicing. This machine should only be operated by a person with sufficient knowledge and skill to ensure safe operation. High voltage circuits are located inside the output terminal cover and control panel.
- Close the cover and control panel before operating. Moving parts and hot surfaces are contained within the enclosure.
- Close all doors and lock them before operating.

M92010030

P/N M9520100304

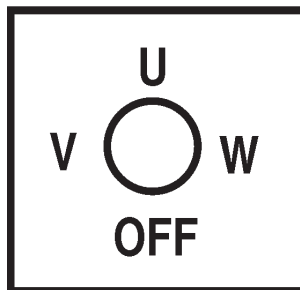

P/N M9520000104

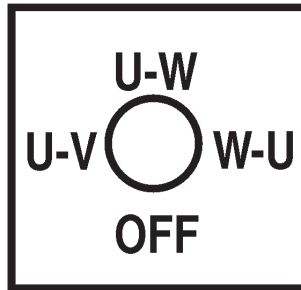

P/N M9520000204



P/N M950000004



P/N M9510200002

**OVER CURRENT RELAY**

If it is Impossible to reset the CIRCUIT BREAKER, open the control panel and push the RESET BUTTON as below.

M92020010

P/N M9520200104



P/N M9500300104



P/N M9500300004



P/N M9500500004



P/N M9503000103

Figure 2. Generator Decals

# DCA-220SSJ — GENERATOR DECALS

	<b>⚠ WARNING</b>	<b>⚠ WARNING</b>	<b>⚠ WARNING</b>
	<b>ELECTRIC SHOCK HAZARD</b> <ul style="list-style-type: none"> <li>Do not touch output terminals when this machine is operating.</li> <li>Turn power off before servicing.</li> </ul>	<b>ELECTRIC SHOCK HAZARD</b> <ul style="list-style-type: none"> <li>Always complete the grounding path from the ground terminal on this genset to an external grounding source. See instruction manual for details.</li> </ul>	<ul style="list-style-type: none"> <li>Before connecting this generator to any building's electrical system, a licensed electrician must install an isolation (transfer) switch.</li> <li>Serious injury or death may result without this transfer switch.</li> </ul>

P/N M9520100503

	<b>⚠ WARNING</b>
	<b>HOT COOLANT</b> can cause severe burns. <ul style="list-style-type: none"> <li>Do not remove cap if radiator is hot.</li> </ul>

P/N M9503100004

	<b>⚠ WARNING</b>
	<b>ENGINE EXHAUST</b> can cause severe injury or death. <ul style="list-style-type: none"> <li>Use only in open, well ventilated areas or vent exhaust outside.</li> </ul>

P/N M9503200004

<b>DANGER</b>
<b>HIGH VOLTAGE</b>

P/N M9520100404

<b>⚠ CAUTION</b>
Stop engine before switching

P/N M9520100204

	<b>⚠ CAUTION</b>
	<b>MOVING PARTS</b> can cause severe injury. <ul style="list-style-type: none"> <li>Do not operate with doors open.</li> <li>Stop engine before servicing.</li> </ul>

P/N M9503000004

<b>NOTE</b>
To use 50 amp receptacles, adjust the voltage selector switch to the single phase position and the main line circuit breaker to the on position.

P/N M1550000204

	<b>⚠ CAUTION</b>
	<ul style="list-style-type: none"> <li><b>HOT PARTS</b> can burn skin.</li> <li>Do not touch until the machine has sufficiently cooled.</li> </ul>

P/N M9510100004

	<b>⚠ WARNING</b>
	<b>ELECTRIC SHOCK HAZARD</b> <ul style="list-style-type: none"> <li>Do not touch output terminals while this machine is operating.</li> <li>Turn power off before servicing.</li> </ul>

P/N M9520100503

	<b>⚠ WARNING</b>
	<b>ELECTRIC SHOCK HAZARD</b> <ul style="list-style-type: none"> <li>Do not touch internal wiring or connections while this machine is operating.</li> <li>Turn power off before servicing.</li> </ul>

P/N M9520100004

<b>⚠ CAUTION</b>
This machine stops and starts Automatically and without notice.

P/N B15200010

Figure 3. Generator Decals (Cont inued)

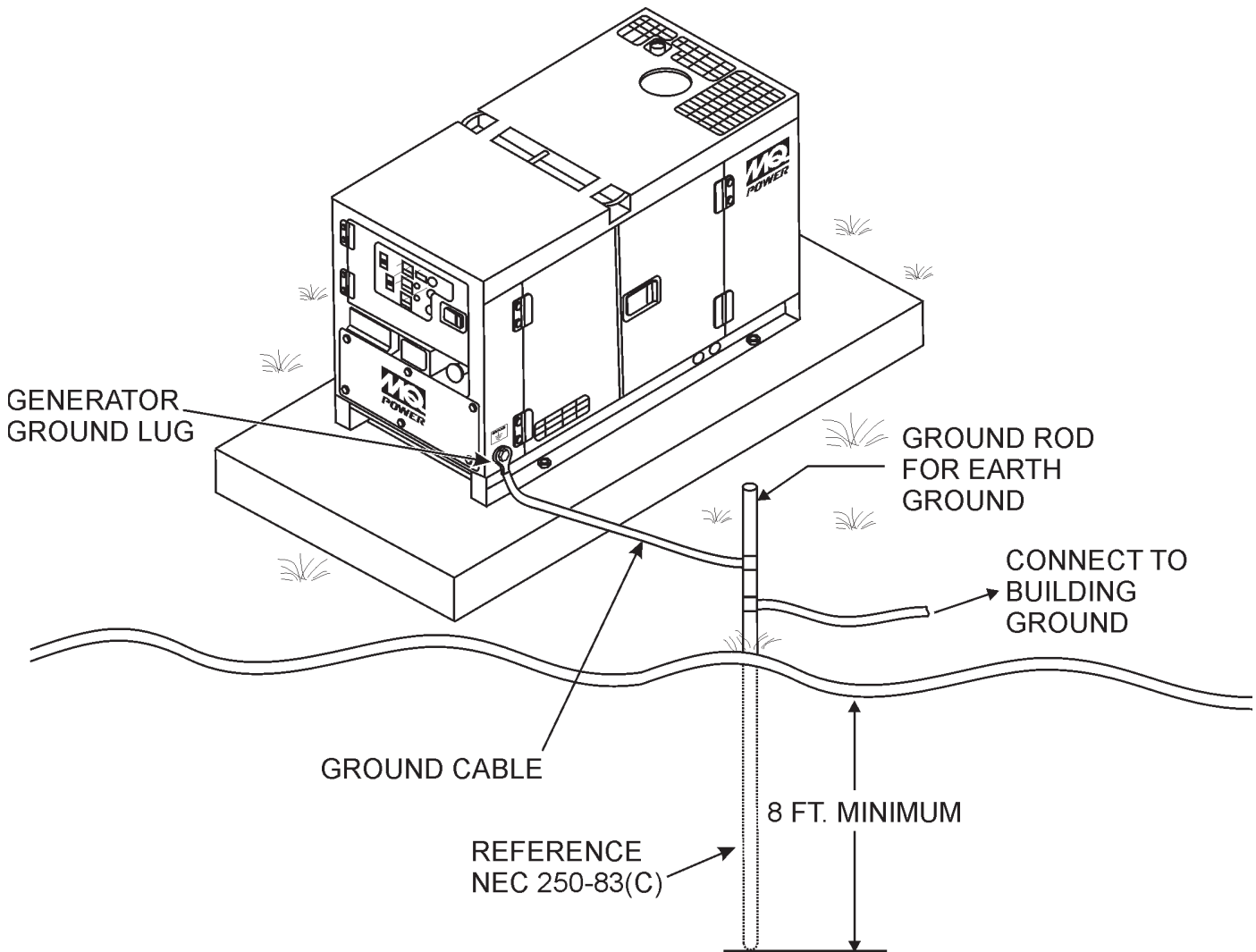

Figure 4. Typical Generator Grounding Application



## Outdoor Installation

Install the generator in a area that is free of debris, bystanders, and overhead obstructions. Make sure the generator is on secure level ground so that it cannot slide or shift around. Also install the generator in a manner so that the exhaust will not be discharged in the direction of nearby homes.

The installation site must be relatively free from moisture and dust. All electrical equipment should be protected from excessive moisture. Failure to do will result in deterioration of the insulation and will result in short circuits and grounding.

Foreign materials such as dust, sand, lint and abrasive materials have a tendency to cause excessive wear to engine and alternator parts.

### CAUTION - EXHAUST HAZARD

Pay close attention to ventilation when operating the generator inside tunnels and caves. The engine exhaust contains noxious elements. Engine exhaust must be routed to a ventilated area.

## Indoor Installation

Exhaust gases from diesel engines are extremely poisonous. Whenever an engine is installed indoors the exhaust fumes must be vented to the outside. The engine should be installed at least two feet from any outside wall. Using an exhaust pipe which is too long or too small can cause excessive back pressure which will cause the engine to heat excessively and possibly burn the valves.

## Mounting

The generator must be mounted on a solid foundation (such as concrete) and set firmly on the foundation to isolate vibration of the generator when it is running. The generator must set at least 6 inches above the floor or grade level (in accordance to NFPA 110, Chapter 5-4.1). **DO NOT** remove the metal skids on the bottom of the generator. They are to resist damage to the bottom of the generator and to maintain alignment.

## Generator Grounding

To guard against electrical shock and possible damage to the equipment, it is important to provide a good **EARTH** ground.

Article 250 (Grounding) of the National Electrical Code (NEC) provides guide lines for proper grounding and specifies that the cable ground shall be connected to the grounding system of the building as close to the point of cable entry as practical.

NEC articles 250-64(b) and 250-66 set the following grounding requirements:

1. Use one of the following wire types to connect the generator to earth ground.
  - a. Copper - 10 AWG (5.3 mm<sup>2</sup>) or larger.
  - b. Aluminum - 8 AWG (8.4 mm<sup>2</sup>) or larger.
2. When grounding the generator (Figure 4) connect the ground cable between the lock washer and the nut on the generator and tighten the nut fully. Connect the other end of the ground cable to earth ground.
3. NEC article 250-52(c) specifies that the earth ground rod should be buried a minimum of 8 ft. into the ground.

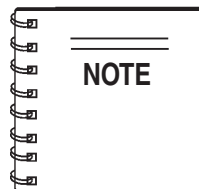

When connecting the generator to any buildings electrical system **ALWAYS** consult with a licensed electrician.

## DCA-220SSJ Whisperwatt™ Series Familiarization

### Generator

The MQ Power Model DCA-220SSJ is a 176 kW **generator** (Figure 5) that is designed as a high quality portable (requires a trailer for transport) power source for telecom sites, lighting facilities, power tools, submersible pumps and other industrial and construction machinery.

### Engine Operating Panel

The "Engine Operating Panel" is provided with the following:

- Tachometer
- Water Temperature Gauge
- Oil Pressure Gauge
- Charging Ammeter Gauge
- Fuel Level Gauge
- Engine Speed Switch
- Panel Light/Panel Light Switch
- Auto ON/OFF Engine Controller (MPEC)
- Preheat Lamp
- Warning Lamp
- Emergency Stop Lamp
- Emergency Stop Button

### Generator Control Panel

The "Generator Control Panel" is provided with the following:

- Frequency Meter (Hz)
- AC Ammeter (Amps)
- AC Voltmeter (Volts)
- Ammeter Change-Over Switch
- Voltmeter Change-Over Switch
- Voltage Regulator
- 3-Pole, 600 amp Main Circuit Breaker
- "Control Box" (located behind the Gen. Control Panel)
  - Automatic Voltage Regulator
  - Diagnostic Display
  - Current Transformer
  - Over-Current Relay
  - Voltage Rectifier
  - Starter Relay
  - Engine Controller (Computer Controlled)
  - Voltage Change-over Board

### Output Terminal Panel

The "Output Terminal Panel" is provided with the following:

- Three 120/240V output receptacles (CS-6369), 50A
- Three auxiliary circuit breakers, 50A
- Two 120V output receptacles (GFCI), 20A
- Two GFCI circuit breakers, 20A
- Five output terminal lugs (3Ø power)
- Battery Charger (Optional)
- Water Heater (Optional)

### Open Delta Excitation System

The DCA-220SSJ generator is equipped with the state of the art "**Open-Delta**" excitation system. The open delta system consist of an electrically independent winding wound among stationary windings of the AC output section.

There are four connections of the open delta A, B, C and D. During steady state loads, the power from the voltage regulator is supplied from the parallel connections of A to B, A to D, and C to D. These three phases of the voltage input to the voltage regulator are then rectified and are the excitation current for the exciter section.

When a heavy load, such as a motor starting or a short circuit occurs, the automatic voltage regulator (AVR) switches the configuration of the open delta to the series connection of B to C. This has the effect of adding the voltages of each phase to provide higher excitation to the exciter section and thus better voltage response during the application of heavy loads.

The connections of the AVR to the AC output windings are for sensing only. No power is required from these windings.

The open-delta design provides virtually unlimited excitation current, offering maximum motor starting capabilities. The excitation does not have a "**fixed ceiling**" and responds according the demands of the required load.

### Engine

The **DCA-220SSJ** is powered by a 6 cylinder, water cooled, direct injection, turbocharged **John Deere 6068HF485 Turbo Diesel Engine**. This engine is designed to meet every performance requirement for the generator. Reference Table 1 for engine specifications.

In keeping with MQ Power's policy of constantly improving its products, the specifications quoted herein are subject to change without prior notice.

### Electric Governor System

The electric governor system controls the RPMs of the engine. When the engine demand increases or decreases, the governor system regulates the frequency variation to  $\pm 0.25\%$ .

### Extension Cables

When electric power is to be provided to various tools or loads at some distance from the generator, extension cords are normally used. Cables should be sized to allow for distance in length and amperage so that the voltage drop between the generator and point of use (load) is held to a minimum. Use the cable selection chart (Table 6) as a guide for selecting proper extension cable size.

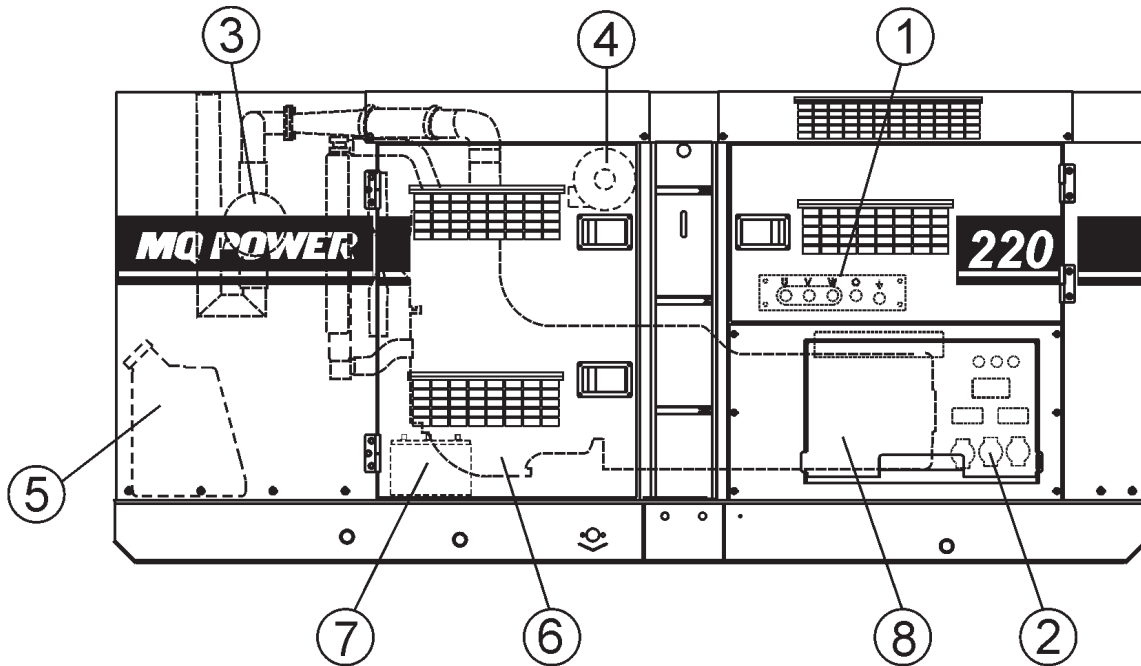

Figure 5. Major Components

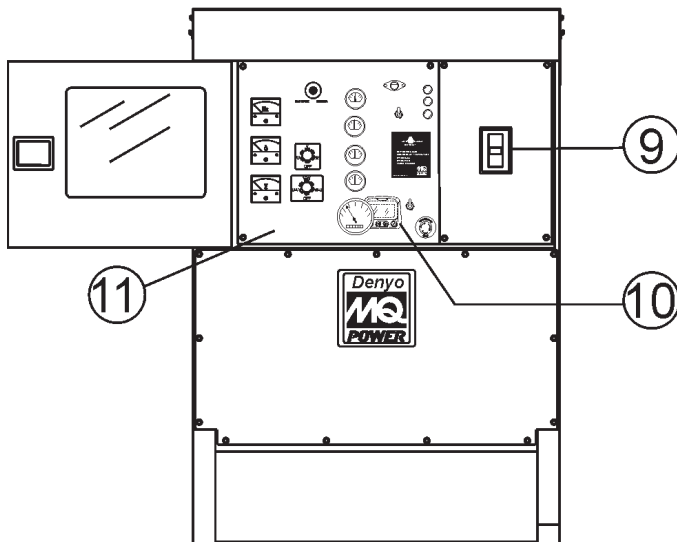
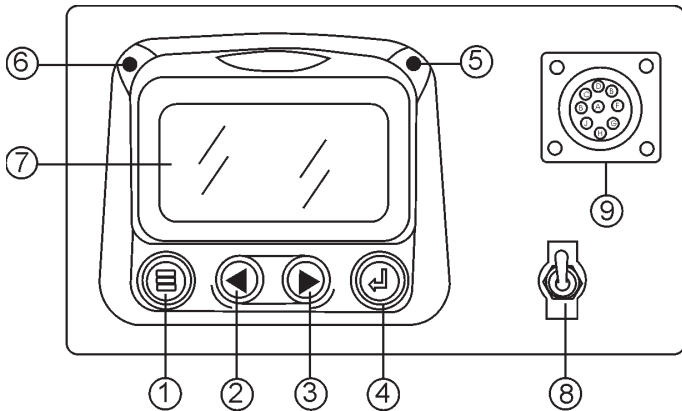

Table 4. Generator Major Components

ITEM NO.	DESCRIPTION
1	Output Terminal Panel Assembly
2	Output Receptacles Assembly
3	Air Filter Assembly
4	Muffler Assembly
5	Fuel Tank Assembly
6	Engine Assembly
7	Battery Assembly
8	Generator Assembly
9	Circuit Breaker Assembly
10	Diagnostic Display Assembly
11	Generator/Engine Control Panel Assembly



**Figure 6. Diagnostic Display Panel**

The diagnostic display panel located inside the control box on the generator (Figure 6) is designed to meet the needs for instrumentation and control of electronically controlled engine communication using the SAEJ1939 Controller Area Network (CAN). This diagnostic display is a multifunction tool that enables equipment operators to view many different engine parameters and service codes.

The keypad on the diagnostic display panel is a capacitive touch sensing system. There are no mechanical switches to wear or stick. This keypad (display unit) will operate in extreme hot or cold weather conditions.

Other components in the system are microprocessor-based components for displaying critical engine data broadcast by an electronic engine or transmission's Engine Control Unit (ECU): engine RPM, oil pressure, coolant temperature, system voltage, etc., and a combination audible alarm and relay unit for warning and shutdown annunciation.

The Engine Control Unit (ECU) used with this generator diagnosis engine faults that arise with the the engine control system and the engine itself. Engine faults can be determined by viewing the Diagnostic Trouble Codes (Active Fault Codes) which are displayed on the Diagnostic Display Panel. See the John Deere Engine Operator's Manual for a complete listing of active fault codes and countermeasures.

The following definitions describe the controls and functions of the **Diagnostic Display Panel** (Figure 6).

1. **Menu Button** – Press this button to enter or exit menu screens.
2. **Left Arrow Button**– Press this button to scroll through the screen either moving the parameter selection toward the left or upward.

3. **Right Arrow Button** – Press this button to scroll through the screen either moving the parameter selection toward the right or downward.
4. **Enter Key Button** – Press this button to select the parameter that is highlighted on the screen.
5. **Emergency Stop LED** – When lit (**RED**) indicates a major fault has occurred. This condition will shutdown the generator.
6. **Warning LED** – When lit (**AMBER**), indicates a engine parameter has exceeded its limits (minor fault). The generator will still run in this condition.
7. **Display Screen** – Graphical backlight LCD screen. Back lighting is controlled via menu or external dimmer potentiometer. The display can show either a single parameter or a quadrant display showing four parameters simultaneously.
8. **Diagnostic Switch** – When placed in the **ON** position, will activate the diagnostic display panel.
9. **CAN Diagnostic Connector** – Controller Area Network connector. This connector outputs diagnostic error codes. Connect a scanner or similar device into this connector to read error codes.

## Display Parameters

The following are some of the engine and transmission parameters displayed on the diagnostic display panel.

- Engine RPM's
- Engine Hours
- System Voltage
- % Engine Load at current RPM
- Coolant Temperature
- Oil Pressure
- Fuel Economy
- Current Fuel Consumption
- Throttle Position
- Engine Manifold Air Temperature
- Active Service Codes
- Set Units for Display (English or Metric)
- English Configuration Parameters.

# DCA-220SSJ — DIAGNOSTIC DISPLAY

## First Time Start Up

1. When power is first applied to the diagnostic display, the “Logo” is displayed.

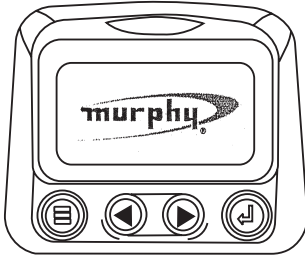

2. The “Wait to Start” message will be displayed for engines with a pre-startup sequence. Once the “Wait to Start” message is no longer displayed the operator may start the engine. Note: Displays only when SAE J1939 message is supported by engine manufacturer.



3. Once the engine has started the single engine parameter is displayed.



2. The first seven items of the “Main Menu” will be displayed. Touching the “Arrow Buttons” will scroll through the menu selection.

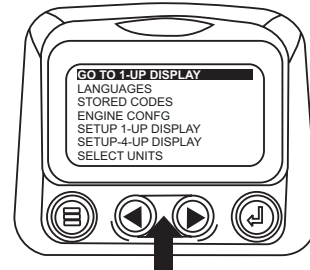

3. Touching the right arrow button will scroll down to reveal the last items of “Main Menu” screen highlighting the next item down.



4. Touch the “Arrows” to scroll to the desired menu item or touch “Menu” to exit the Main menu and return to the engine parameter display.

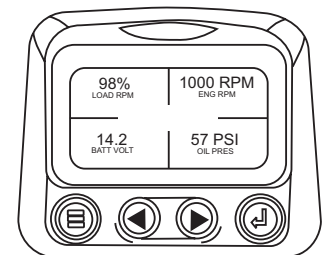
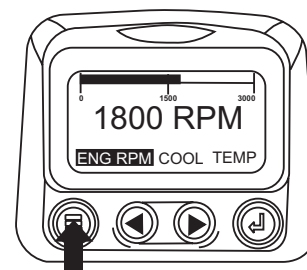

## Main Menu Navigation

1. Starting at the single or four engine parameter display, touch “Menu”.

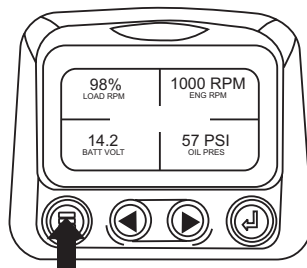
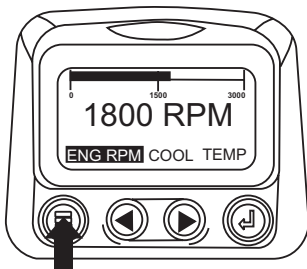

## Selecting a Language

1. Starting at the main menu display use the “Arrows” to scroll to the “Language” menu and once highlighted touch the “Enter” button.

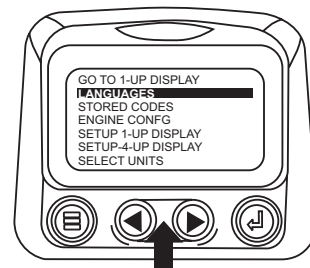



# DCA-220SSJ — DIAGNOSTIC DISPLAY

- The language choices will be displayed. Use the “Arrow” buttons to scroll through the selections and touch “Enter” to make a selection.



- Now that you have selected the language, touch the “Menu” button to return to the main menu display.

## Stored Fault Codes

- Starting at the single or the four engine parameter display touch the “Menu button”.

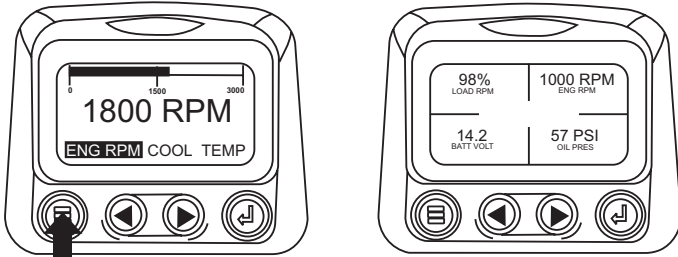

- The main menu will pop up on the display. Use the “Arrow Buttons” to scroll through the menu until the Stored Fault Codes is highlighted.

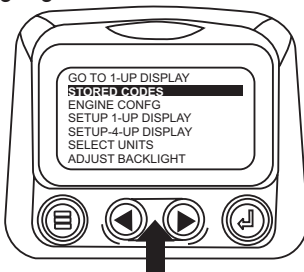

- Once the “Stored Fault Codes” menu item has been highlighted touch the “Enter Button” to view the “Stored Fault Codes” (when applicable, consult engine or transmission manufacturer for SAE J1939 supported parameters).

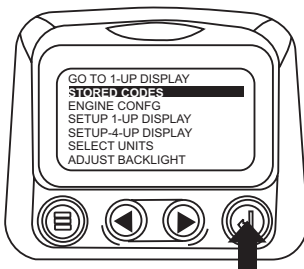

- If the word “MORE” appears above the “Arrow Buttons” there are more stored fault codes that may be viewed. Use the “Arrow Buttons” to scroll to the next Stored Diagnostic Code.

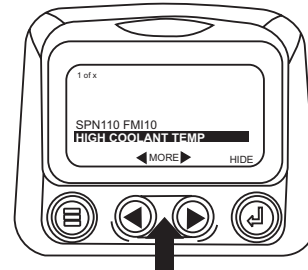

- Touch the “Menu Button” to return to the main menu.



- Touch the “Menu Button” to exit the Main menu and return to the engine parameter display.

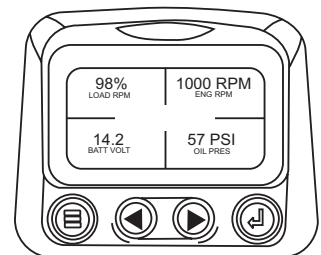
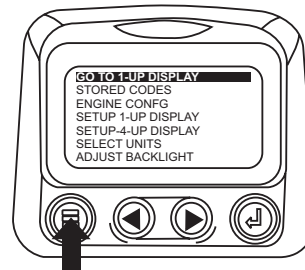

## Engine Configuration Data

- Starting at the single or four engine parameter display touch the “Menu Button”.

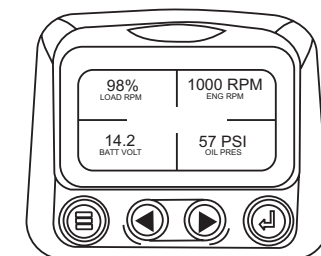
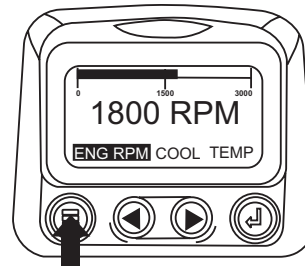

# DCA-220SSJ — DIAGNOSTIC DISPLAY

## First Time Start Up

1. When power is first applied to the diagnostic display, the “Logo” is displayed.



2. The “Wait to Start” message will be displayed for engines with a pre-startup sequence. Once the “Wait to Start” message is no longer displayed the operator may start the engine. Note: Displays only when SAE J1939 message is supported by engine manufacturer.



3. Once the engine has started the single engine parameter is displayed.



2. The first seven items of the “Main Menu” will be displayed. Touching the “Arrow Buttons” will scroll through the menu selection.

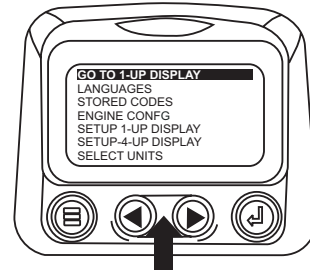

3. Touching the right arrow button will scroll down to reveal the last items of “Main Menu” screen highlighting the next item down.



4. Touch the Arrows” to scroll to the desired menu item or touch “Menu” to exit the Main menu and return to the engine parameter display.

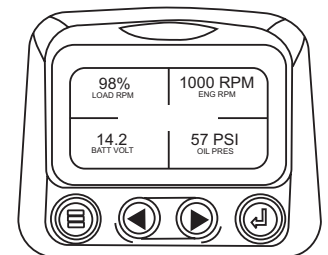
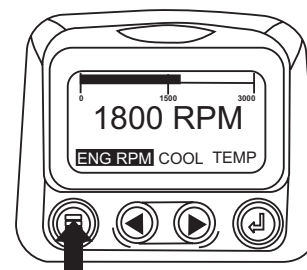

## Main Menu Navigation

1. Starting at the single or four engine parameter display, touch “Menu”.

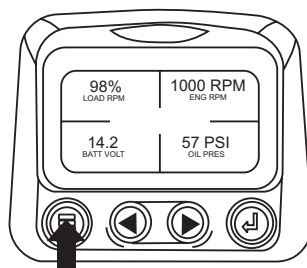
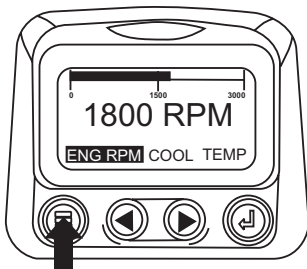

## Selecting a Language

1. Starting at the main menu display use the “Arrows to scroll to the “Language” menu and once highlighted touch the “Enter” button.

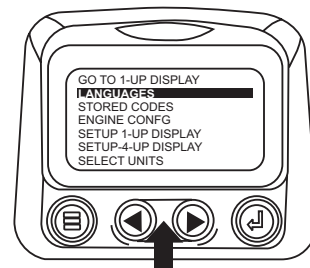

# DCA-220SSJ — DIAGNOSTIC DISPLAY

- The language choices will be displayed. Use the “Arrow” buttons to scroll through the selections and touch “Enter” to make a selection.



- Now that you have selected the language, touch the “Menu” button to return to the main menu display.

## Stored Fault Codes

- Starting at the single or the four engine parameter display touch the “Menu button”.

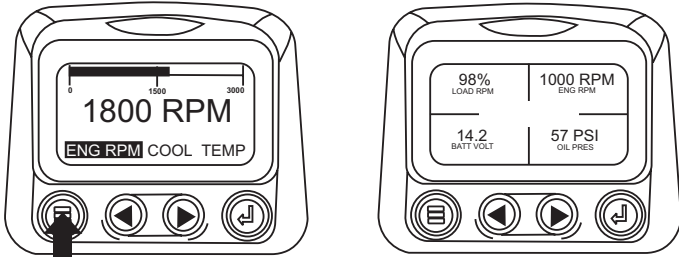

- The main menu will pop up on the display. Use the “Arrow Buttons” to scroll through the menu until the Stored Fault Codes is highlighted.

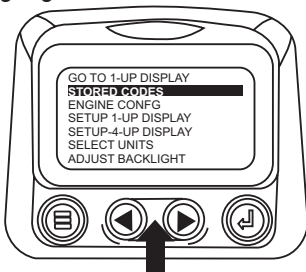

- Once the “Stored Fault Codes” menu item has been highlighted touch the “Enter Button” to view the “Stored Fault Codes” (when applicable, consult engine or transmission manufacturer for SAE J1939 supported parameters).

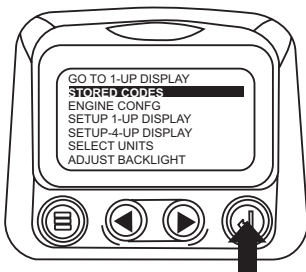

- If the word “MORE” appears above the “Arrow Buttons” there are more stored fault codes that may be viewed. Use the “Arrow Buttons” to scroll to the next Stored Diagnostic Code.

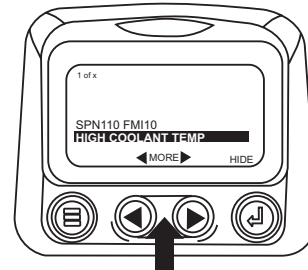

- Touch the “Menu Button” to return to the main menu.



- Touch the “Menu Button” to exit the Main menu and return to the engine parameter display.

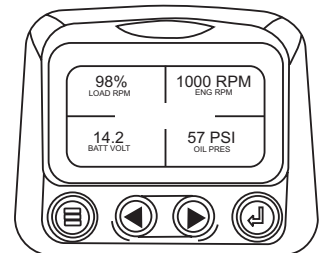
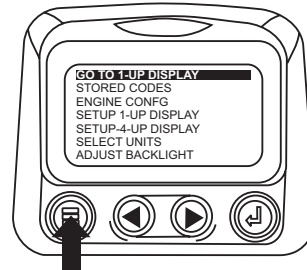

## Engine Configuration Data

- Starting at the single or four engine parameter display touch the “Menu Button”.

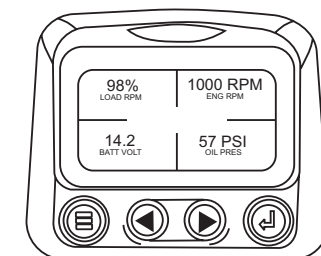
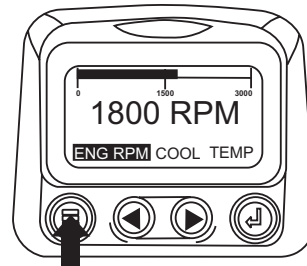



- The main menu will pop up on the display. Use the “Arrow Buttons” to scroll through the menu until the “Engine Configuration” menu item has been highlighted.

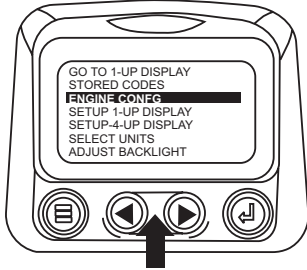

- Once the “Engine Configuration” menu item has been highlighted touch the “Enter Button” to view the engine configuration data.

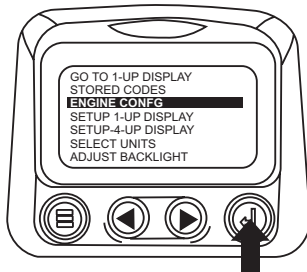

- Use the “Arrow Buttons” to scroll through the engine configuration data.

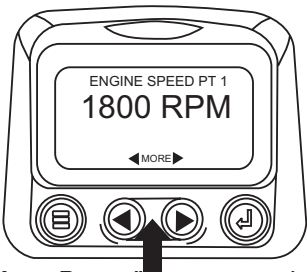

- Touch the “Menu Button” to return to the main menu.

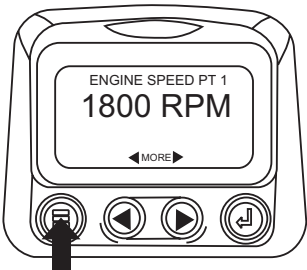

- Touch the “Menu Button” to exit the Main menu and return to the engine parameter display.

## FAULTS AND WARNINGS

### Auxiliary Gage Fault

- During normal operation the single or four parameter screen will be displayed.

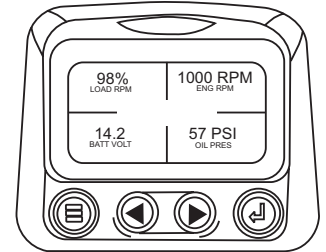
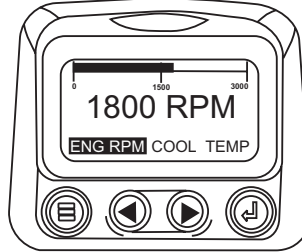

- The PVA Series of auxiliary gages can be attached to the PowerView. These auxiliary gages communicate with the Modbus master PowerView via a daisy-chained RS-485 port. If at any time during system initialization or normal operation an auxiliary gage should fail, the single or four parameter screen will be replaced with the “MLink Gage Fault” message.





- To acknowledge and “Hide” the fault and return to the single or four parameter display, touch the “Enter Button”.

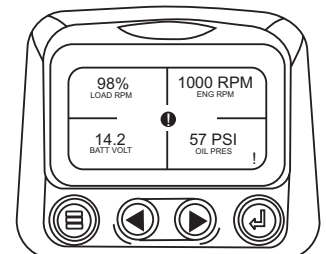
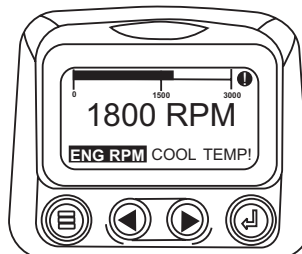

- The display will return to the single or four parameter screen.



# DCA-220SSJ — DIAGNOSTIC DISPLAY

-  Indicates Auxiliary Gage Fault
-  Indicates Fault Warning
-  Indicates Derate or Shutdown Condition Fault

5. Touching the “Enter Button” will redisplay the hidden fault. Touching the “Enter Button” once again will hide the fault and return the screen to the single or four parameter display. NOTE: The fault can only be cleared by correcting the cause of the fault condition.



## Active Fault Codes

1. During normal operation the single or four parameter screen will be displayed.

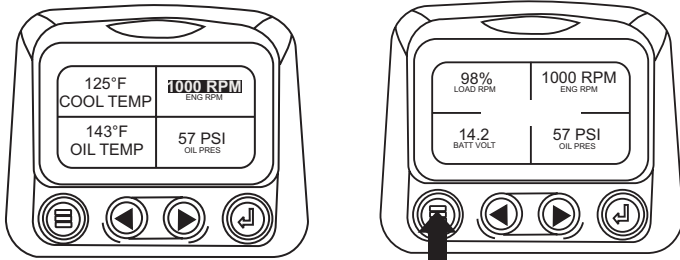

2. When the PowerView receives a fault code from an engine control unit the single or four parameter screen will be replaced with the “Active Fault Codes” message.



3. If the word “MORE” appears above the “Arrow Buttons”, there are more active fault codes that may be viewed. Use the “Arrow Buttons” to scroll to the next “Active Fault Code”.

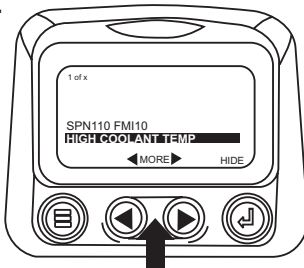

4. To acknowledge and “Hide” the fault and return to the single or four parameter display touch the “Enter Button”.



5. The display will return to the single or four parameter display but the display will contain the “Active Fault” warning icon. Touching the “Enter Button” will redisplay the hidden fault.

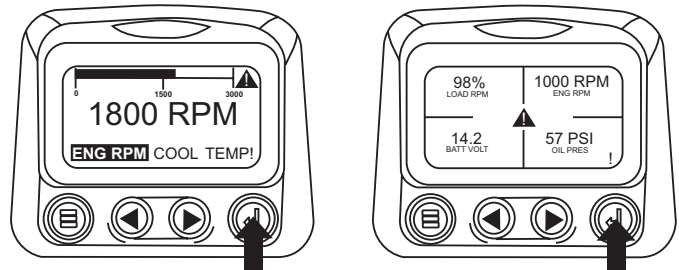

6. Touching the “Enter Button” once again will hide the fault and return the screen to the single or four parameter display.



7. The Single or Four parameter screen will display the fault icon until the fault condition is corrected. NOTE: Ignoring active fault codes could result in severe engine damage.

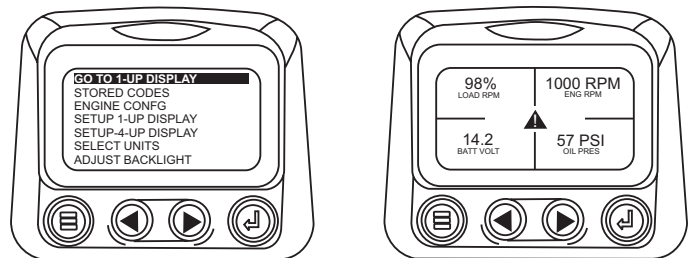

## Shut Down Codes

1. During normal operation the single or four parameter screen will be displayed.

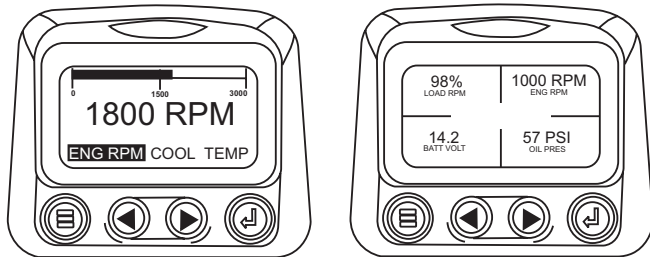

2. When the diagnostic display receives a severe fault code from an engine control unit the single or four parameter screen will be replaced with the "Shutdown" message.



3. To acknowledge and "Hide" the fault and return to the single or four parameter display touch the "Enter Button".

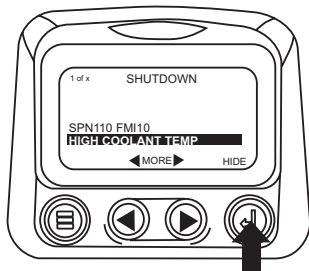

4. The display will return to the single or four parameter display, but the display will contain the "Shut Down" icon. Touching the "Enter Button" will redisplay the hidden fault.

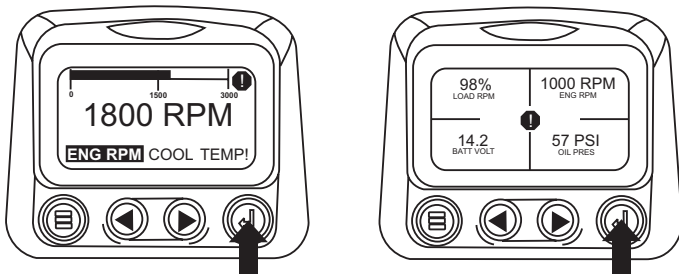

5. Touching the "Enter Button" once again will hide the fault and return the screen to the single or four parameter display.

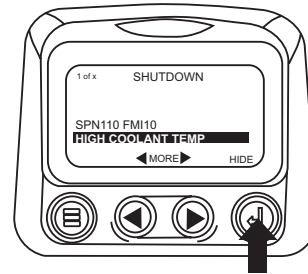

6. The Single or Four parameter screen will display the fault icon until the fault condition is corrected. NOTE: Ignoring active fault codes could result in severe engine damage.

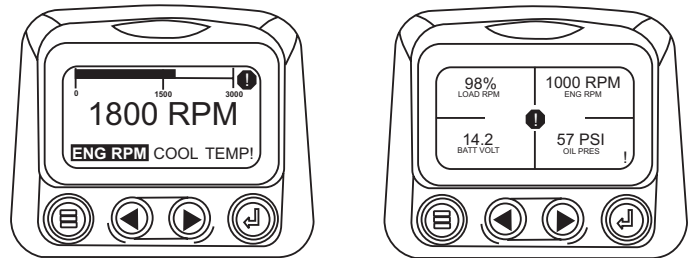

## Backlight Adjustment

1. Starting at the single or four engine parameter display touch the "Menu Button".

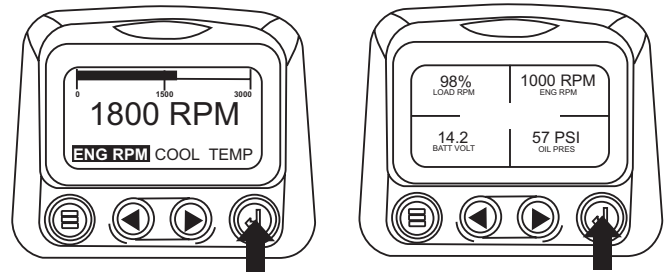

2. The main menu will pop up on the display. Use the "Arrow Buttons" to scroll through the menu until the "Adjust Backlight" is highlighted.

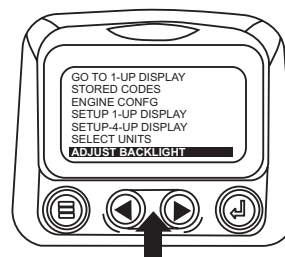

# DCA-220SSJ — DIAGNOSTIC DISPLAY

- Once the “Adjust Backlight” menu item has been highlighted touch the “Enter Button” to activate the “Adjust Backlight” function.

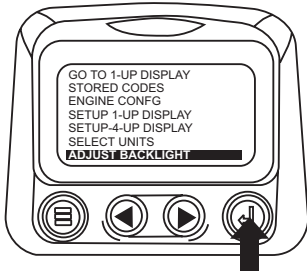

- Use the “Arrow Buttons” to select the desired backlight intensity.

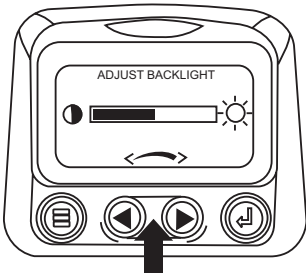

- Touch the “Menu Button” to return to the main menu.

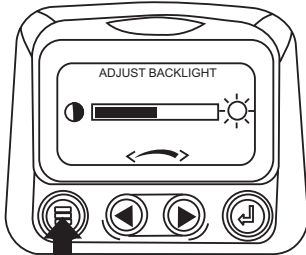

- Touch the “Menu Button” to exit the Main menu and return to the engine parameter display.

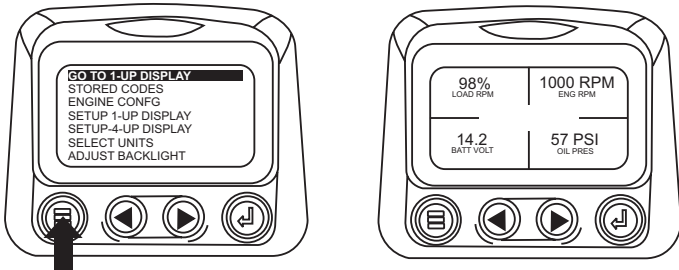

## Contrast Adjustment

- Starting at the single or four engine parameter display, touch the “Menu Button”.

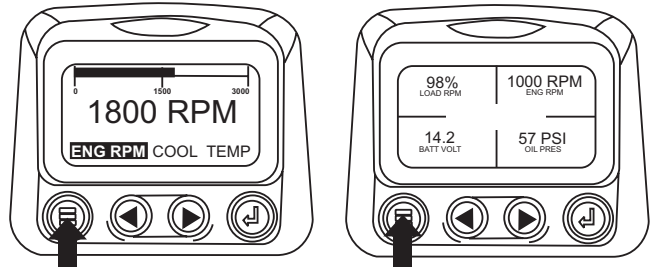

- The main menu will pop up on the display. Use the “Arrow Buttons” to scroll through the menu until “Adjust Contrast” is highlighted.

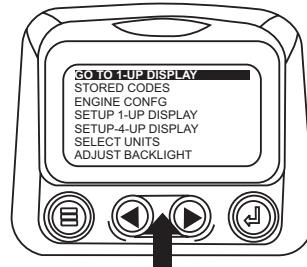

- Once the “Adjust Contrast” menu item has been highlighted touch the “Enter Button” to activate the “Adjust Contrast” function.

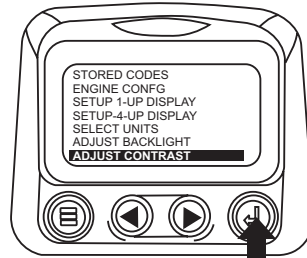

- Use the “Arrow Buttons” to select the desired contrast intensity.



- Touching the “Menu Button” will take you back through the menus.

## Select Units

- Starting at the single or four engine parameter display touch the “Menu Button”.

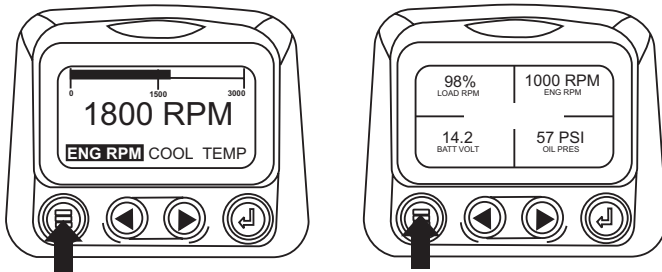

- The main menu will pop up on the display. Use the arrow buttons to scroll through the menu until the “Select Units” is highlighted.

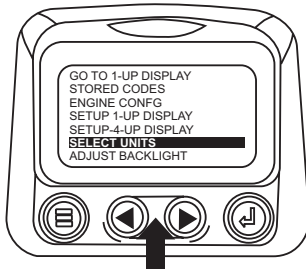

- Once the “Select Units” menu item has been highlighted touch the “Enter Button” to access the “Select Units” function.

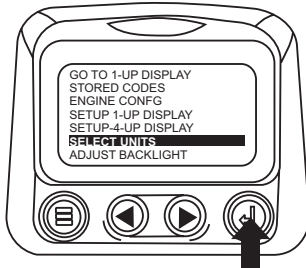

- Use the arrows to highlight the desired units. “English” for imperial units i.e. PSI, °F or Metric kPa, Metric Bar for IS units i.e. kPa, Bar, °C.



- Touch the “Enter Button” to select the highlighted units.



- Touch the “Menu Button” to return to the “Main Menu”.

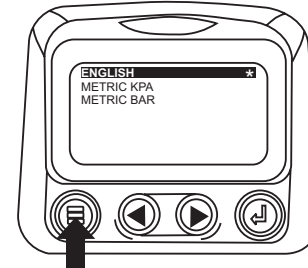

- Touch the “Menu Button” to exit the Main menu and return to the engine parameter display.

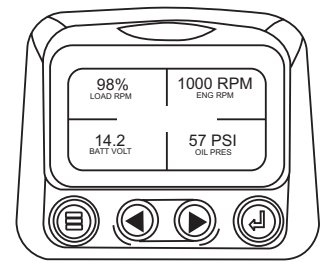
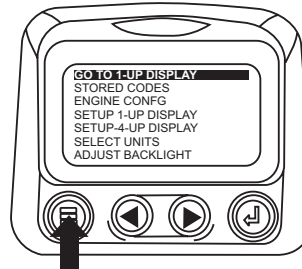

## Setup 1- Up Display

- Starting at the single engine parameter display, touch the “Menu Button”.

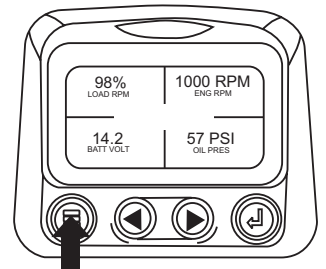
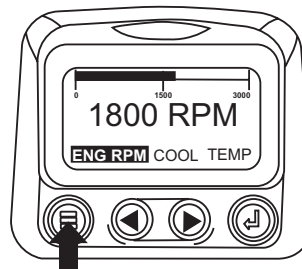

- The main menu will pop up on the display. Use the “Arrow Buttons” to scroll through the menu until the “Setup 1-up Display” is highlighted.

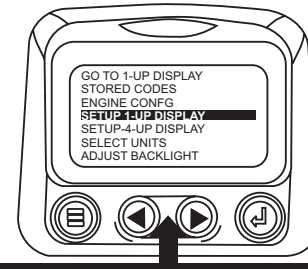



## DCA-220SSJ — DIAGNOSTIC DISPLAY

3. Once the “Setup 1-up Display” menu icon has been highlighted touch the “Enter Button” to access the “Setup 1-up display” function.

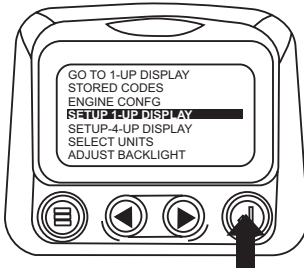

4. Three options are available for modification of the 1-Up display.

- Use defaults**- This option contains a set of engine parameters: Engine Hours, Engine RPM, System Voltage, Battery Voltage, % Engine Load at Current RPM, Coolant Temperature, Oil Pressure.
- Custom Setup**- This option allows for the modification of what parameter, the number of parameters, and the order in which the parameters are being displayed.
- Automatic scan** - Selecting the scan function will cause the 1-Up Display to scroll through the selected set of parameters one at a time, momentarily pausing at each.

5. Use Defaults- To select “Use Defaults” use the arrow buttons to scroll to and highlight “Use Defaults” in the menu display.

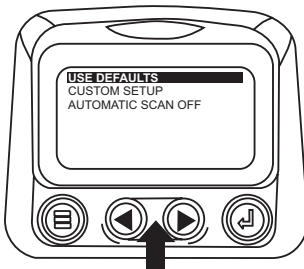

6. Touch the “Enter Button” to activate the “Use Defaults” function.



7. A message indicating the “Single Engine” parameter display parameters are reset to the factory defaults will be displayed, then the display will return to the “Custom Setup” menu.

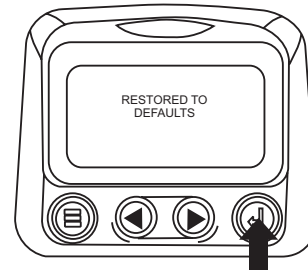

8. Custom Setup- To perform a custom setup of the 1-Up Display, use the arrow buttons to scroll to and highlight “Custom Setup” on the display.



9. Touching the “Enter Button” will display a list of engine parameters.



10. Use the “Arrow Buttons” to scroll to and highlight a selected parameter (parameter with a # symbol to right of it).

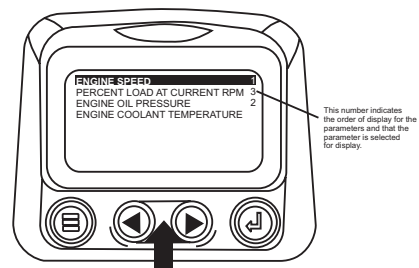

# DCA-220SSJ — DIAGNOSTIC DISPLAY

11. Touch the “Enter Button” to deselect the selected parameter removing it from the list of parameters being displayed on the 1-up display.

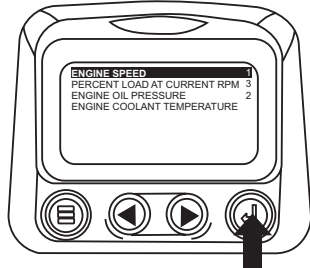

12. Use the “Arrow Button” to scroll and highlight the desired parameter that has not been selected for display.

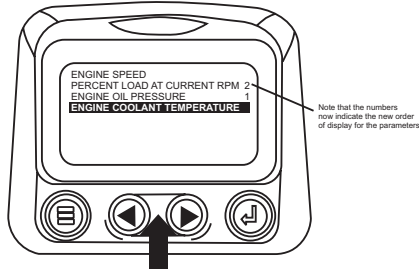

13. Touch the “Enter Button” to select the highlighted parameter for inclusion in the Single Engine Parameter Display.

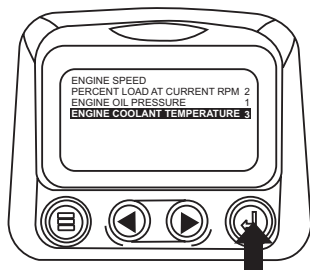

14. Continue to scroll and select additional parameters for the custom 1-up Display. Touch the “Menu Button” at any time to return to the “Custom Setup” menu.

15. Automatic Scan- Selecting the scan function will cause the 1-Up Display to scroll through the selected set of parameters one at a time. Use the “Arrow Buttons” to scroll to the “Automatic Scan” function.

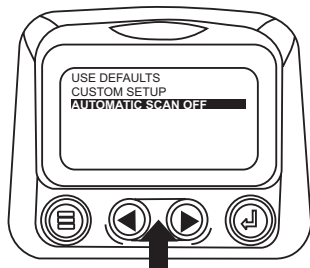

16. Touching the “Enter Button” toggles the “Automatic Scan” function on.

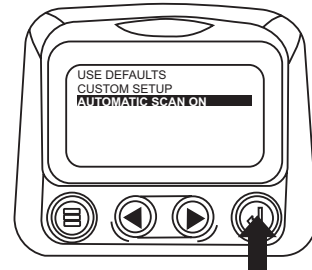

17. Touching the “Enter Button” again toggles the “Automatic Scan” function off.

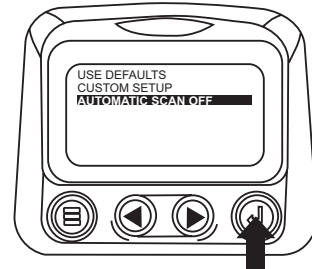

18. Once the “Use Defaults”, “Custom Setup” and “Automatic Scan” functions have been set touch the “Menu Button” to return to the main menu.

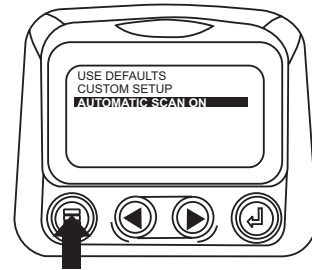

19. Touch the “Menu Button” to exit the Main menu and return to the engine parameter display.

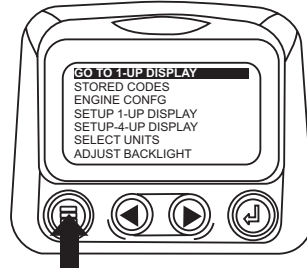

# DCA-220SSJ — DIAGNOSTIC DISPLAY

## Setup 4-Up Display

1. From the single or four engine parameter display touch the “Menu Button”.

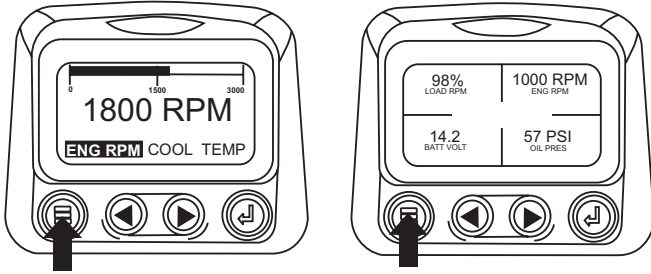

2. The main menu will pop up on the display. Use the “Arrow Buttons” to scroll through the menu until the “Setup 4- Up Display” is highlighted.

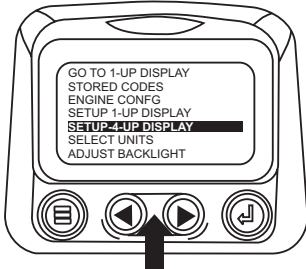

3. Once the “Setup 4-Up Display” menu item has been highlighted touch the “Enter Button” to activate the “Setup 4- Up Display” menu.

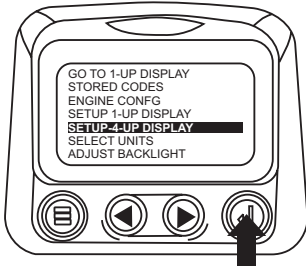

4. Touch the “Enter Button” to activate the “Use Defaults” function. This action will reset the unit to the factory default.



5. The “Use Defaults” screen will be displayed during the resetting period then will automatically return to the “Setup 4- Up Display” menu.

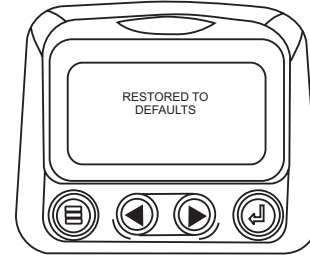

6. Select the “4-Up Custom Setup” from the “4-Up Setup” menu.

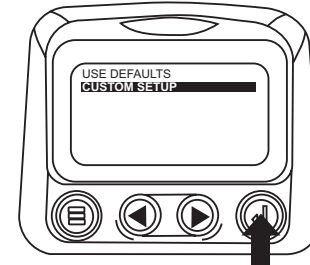

7. The quadrant with the backlit parameter value is the current selected parameter. Use the “Arrow Buttons” to highlight the parameter value in the quadrant you wish to place a new parameter.



8. Touch the “Enter Button” and a list of parameters will appear.

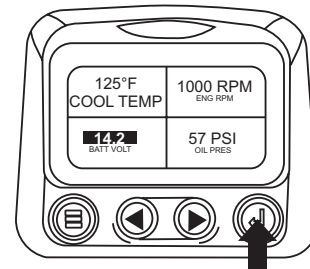



9. The parameter that is highlighted is the selected parameter for the screen. Use the “Arrow Buttons” to highlight the new parameter to be placed in the quadrant selected in the previous screen.

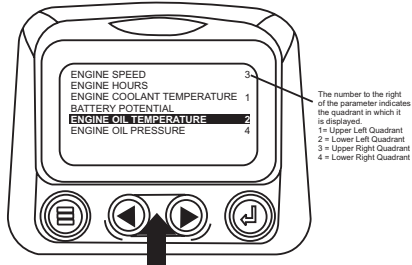

10. Touch the “Enter Button” to change the selected parameter in the quadrant to the new parameter.

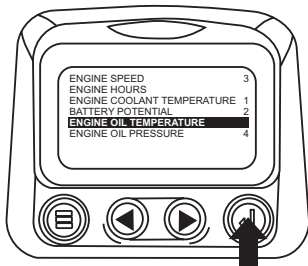

11. Use the “Menu Button” to return to the “4-Up Custom Setup” screen.

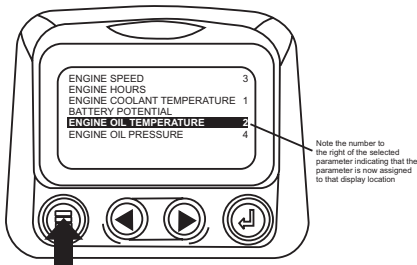

12. The parameter in the selected quadrant has changed to the parameter selected in the previous screen.

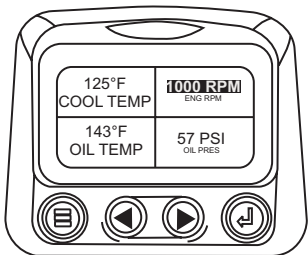

13. Repeat the parameter selection process until all spaces are filled.

14. Touch the “Menu Button” to return to the main menu.

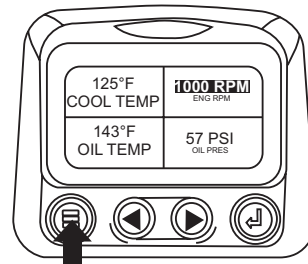

15. Touch the “Menu Button” to exit the Main menu and return to the engine parameter display.

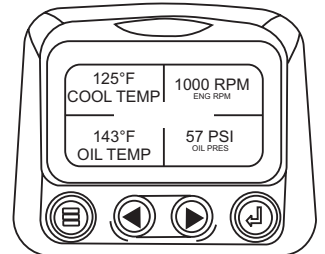

## Utilities (information and troubleshooting)

1. Starting at the single or four engine parameter display, touch the “Menu Button”.

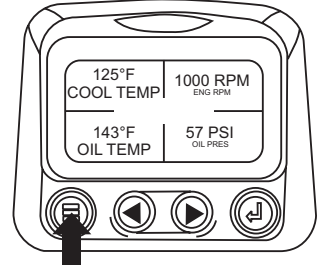
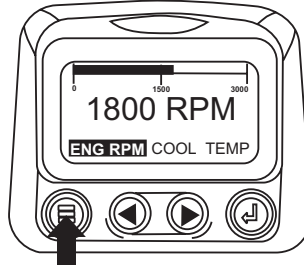

2. The main menu will be displayed. Use the “Arrow Buttons” to scroll through the menu until the “Utilities” is highlighted.



3. Once the “Utilities” menu item has been highlighted, touch the “Enter Button” to activate the “Utilities” functions.

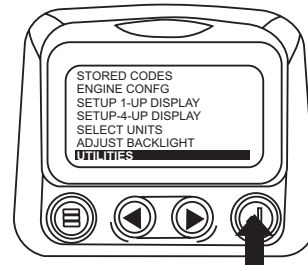

## DCA-220SSJ — DIAGNOSTIC DISPLAY

4. Touch “Select” to enter the “Gage Data” display. When “Gage Data” is selected the PowerView will communicate with the analog gages at a fixed rate of 38.4k Band, 8 data bits, no parity check, 1 stop bits, half duplex.



5. Use the “Arrow Buttons” to scroll through the items or touch “Menu” to return to the “Utilities” menu.



6. Touch “Menu Button” to return to the “Utilities” menu.



7. Use the “Arrows” to highlight Remove All Gages”. Touch “Select” to clear gage data from memory. It takes a moment to clear all gages.



8. When the gage data has cleared, the display automatically returns to the “Utilities” menu. Scroll to “Software Version”. Touch “Select” to view the software version currently in the diagnostic display.



9. Touch “Menu” to return to “Utilities”. Highlight Fault Conversion using the “Arrows”. Touch “Select” to enter the Fault conversion menu.



10. Use the “Arrows” to scroll to and highlight the desired version then touch “Select”. An asterisk denotes which version is currently selected.

**NOTE:** There are four (4) different methods for converting fault codes. The diagnostic display always looks for J1939 Version 4 and can be set to read the code as one of three (3) other J1939 versions if Version 4 is not being used. Most engine ECU's use Version 4, therefore in most cases adjustment of this menu option will not be required.

Upon receiving an unrecognizable fault, change to a different J1939 Version. If the fault SPN does not change when the version is changed, the ECU generating the fault is using Fault Conversion method 4. If the SPN number does not change but is still unrecognizable, try changing to another J1939 Version not yet used and continue to check the SPN number.



11. Touch the “Menu” button to return to “Utilities” menu. Touch the “Menu button again to return to the “Main” menu.

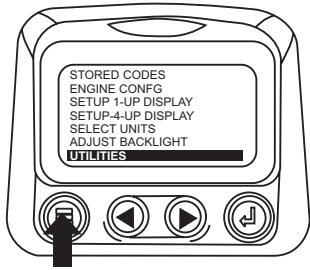

## MODBUS SETUP

1. Starting at the single or four engine parameter display, touch the “Menu Button”.

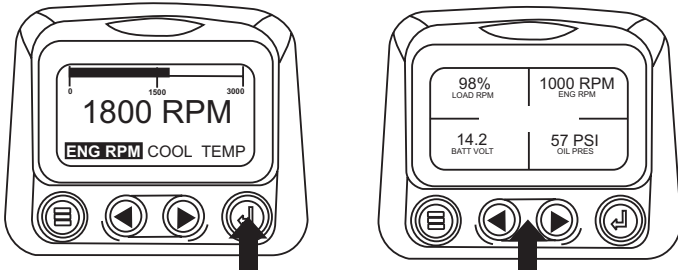

2. The main menu will be displayed. Use the “Arrow Buttons” to scroll through the menu until the “Utilities” is highlighted, then touch “Enter”.

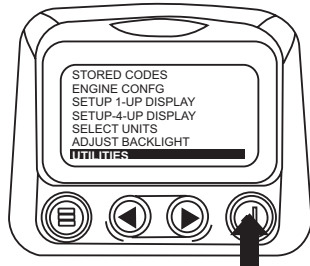

3. Once in the “Utilities” menu use the “Arrows” to scroll through the menu until the “Modbus Setup” menu is highlighted, then touch “Enter”.

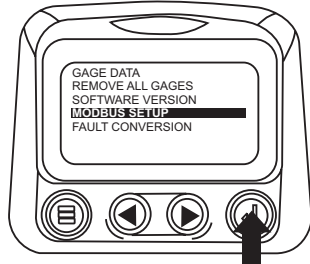

4. Use the “Arrows” to scroll down to and highlight either the “Slave Active or Master Active” modes. Touch the “Enter” button to toggle between master and slave.

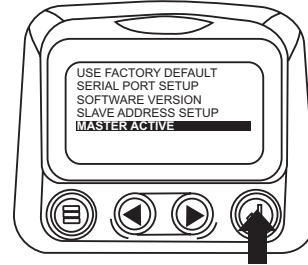

5. Use the “Arrows” to scroll to the “Serial Port” menu to highlight it, then touch “Enter”.

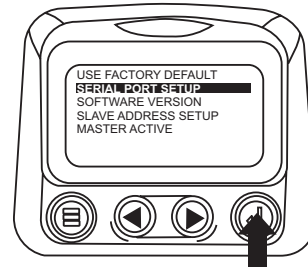

6. Use the “Arrow” button to scroll to each selection to configure the MODBUS values for your application.

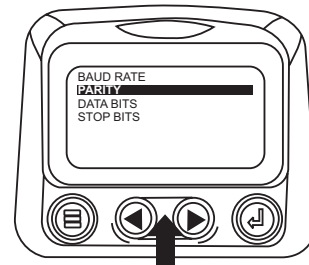

7. When finished, touch “Menu” to return to the previous screen.

## GLOSSARY (Troubleshooting information)

### **CANBUS FAILURE**

Diagnostic Display has not received any CAN messages for at least 30 seconds.

### **NO DATA**

Diagnostic Display has not received the particular message being displayed for at least 5 seconds.

### **NOT SUPPORTED**

Diagnostic Display has received a message from the ECU stating the displayed message is not supported

### **DATA ERROR**

Diagnostic Display has received an error message from the ECU for the displayed message.

### **EMPTY**

No parameter selected for this 4- UP quadrant.

### **WAIT TO START PREHEATING**

This is a message from the engine indicating it is in a preheating cycle.

Wait until this message clears before starting the engine.

### **TIMEOUT ECU NOT RESPONDING**

The ECU did not respond to the PowerView request.

### **NO GAGE DATA**

The Diagnostic Display has no record of connected gages to the RS485 bus.

### **DISPLAY NOT VISIBLE**

Press and hold the “Menu” button for approximately 3 seconds.

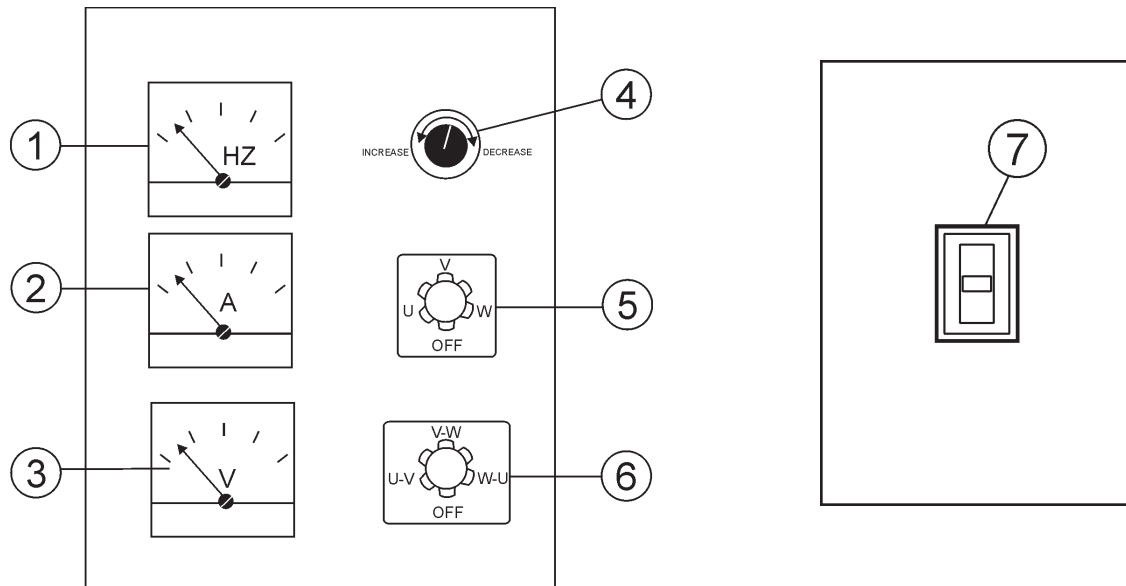

**Figure 7. Generator Control Panel**

The definitions below describe the controls and functions of the DCA-220SSJ **Generator Control Panel** (Figure 7).

1. **Frequency Meter** – Indicates the output frequency in hertz (Hz). Normally 60 Hz.
2. **AC Ammeter** – Indicates the amount of current the load is drawing from the generator per leg selected by the ammeter phase-selector switch.
3. **Ammeter Change-Over Switch** – This switch allows the AC ammeter to indicate the current flowing to the load connected to any phase of the output terminals, or to be switched off. This switch does not effect the generator output in any fashion, it is for current reading only.
4. **Voltage Regulator Control** – Allows  $\pm 15\%$  manual adjustment of the generator's output voltage.
5. **AC Voltmeter** – Indicates the output voltage present at the **U, V, and W Output Terminal Lugs**.
6. **Voltmeter Change-Over Switch** – This switch allows the AC voltmeter to indicate phase to phase voltage between any two phases of the output terminals or to be switched off.
7. **Main Circuit Breaker** – This three-pole, 600A main breaker is provided to protect the the **U, V, and W Output Terminal Lugs** from overload.

Located behind the generator control panel is the **Generator Control Box**. This box contains some of the necessary electronic components required to make the generator function.

The **Control Box** is equipped with the following major components:

- Over-Current Relay
- Voltage Rectifier (AVR)
- Starter Relay
- Current Transformer
- Voltage Selector Switch
- Three Phase Circuit Breaker

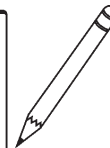
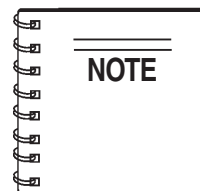

Remember the **overcurrent relay** monitors the current flowing from the **U, V, and W Output Terminal Lugs** to the load.

In the event of a short circuit or over current condition, it will automatically trip the 600 amp main breaker.

To restore power to the **Output Terminal Panel**, press the **reset** button on the overcurrent relay and place the **main** circuit breaker in the **closed** position (**ON**).

# DCA-220SSJ — ENGINE OPERATING PANEL

The definitions below describe the controls and functions of the DCA-220SSJ **Engine Operating Panel** (Figure 8).

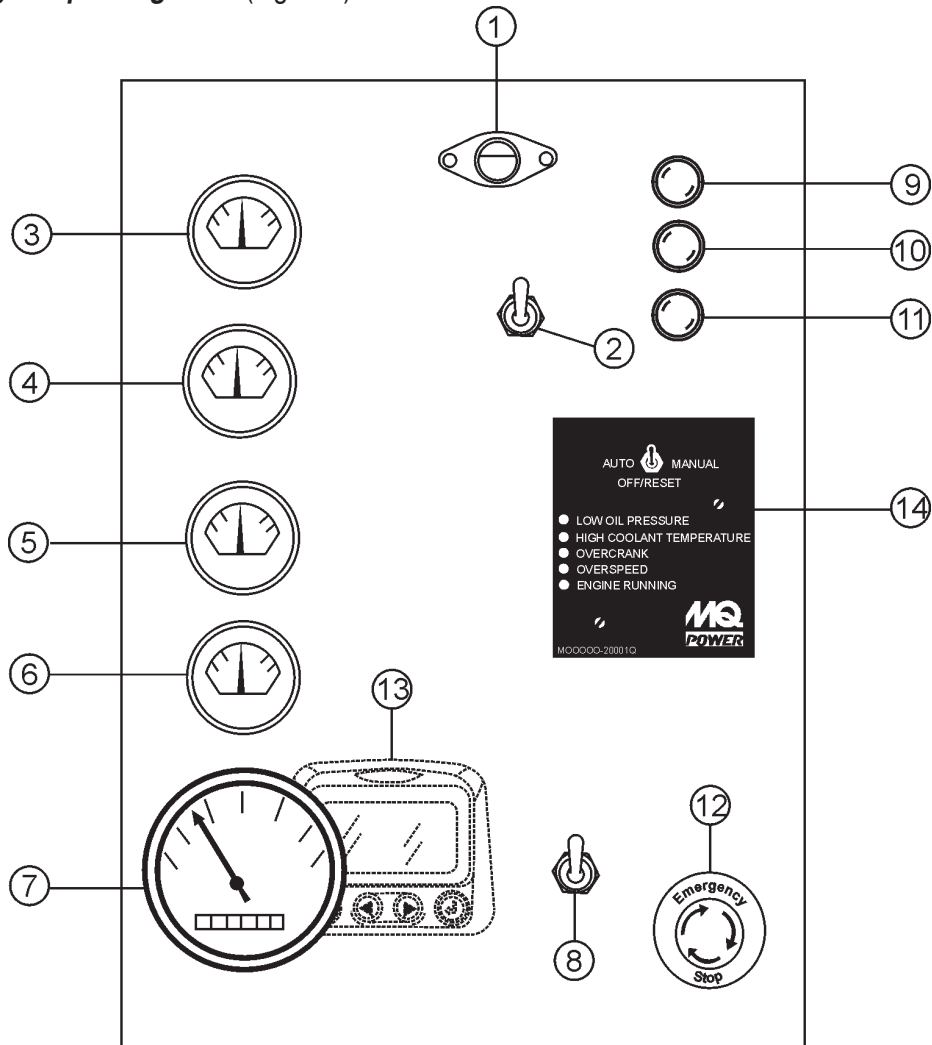
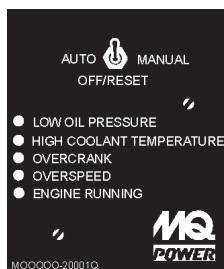

**Figure 8. Engine Operating Panel**

1. **Panel Light** – Normally used in dark areas or at night time. When activated, panel lights will illuminate. When the generator is not in use be sure to turn the panel light switch to the **OFF** position.
2. **Panel Light Switch** – When activated will turn on control panel light.
3. **Oil Pressure Gauge** – During normal operation this gauge should read between 35 to 65 psi. (241~448 kPa). When starting the generator the oil pressure may read a little higher, but after the engine warms up the oil pressure should return to the correct pressure range.
4. **Water Temperature Gauge** – During normal operation this gauge should read between 180° and 230°F. (82° C and 110° C)
5. **Charging Ammeter Gauge** – Indicates the current being supplied by the engine's alternator which provides current for generator's control circuits and battery charging system.
6. **Fuel Gauge** - Indicates amount of diesel fuel available.
7. **Tachometer** – Indicates engine speed in RPM's for 60 Hz operation. This meter should indicate 1800 RPM's when the rated load is applied. In addition a built in hour meter will record the number of operational hours that the generator has been in use.



8. **Engine Speed Switch** – This switch controls the speed of the engine (low/high).
9. **Pre-Heat Lamp** – When lit, indicates engine is in the pre-heating mode (for starting during cold weather operating conditions). When lamp goes off engine is ready for starting.
10. **Warning Lamp** – This lamp will illuminate when a critical engine fault has occurred.
11. **Emergency Stop Lamp** – This lamp will illuminate when the emergency stop button has been pressed or a critical engine fault has occurred.
12. **Emergency Stop Button** – In the event of an emergency, press this button to shutdown the generator.
13. **Diagnostic Display** – This display monitors critical engine functions. If any abnormal conditions occur, an Active Fault Code will be displayed. This diagnostic display can be located inside the control box.
14. **Auto On/Off Engine Controller (MPEC) –**  
This controller has a vertical row of status LED's (inset), that when lit, indicate that an engine malfunction (fault) has been detected. When a fault has been detected the engine controller will evaluate the fault and all major faults will shutdown the generator. During **cranking cycle**, The MPEC will attempt to crank the engine for 10 seconds before disengaging.



If the engine does not engage (start) by the third attempt, the engine will be shutdown by the engine controller's **Over Crank Protection** mode. If the engine engages at a speed (RPM's) that is not safe, the controller will shutdown the engine by initializing the **Over Speed Protection** mode.

Also the engine controller will shut down the engine in the event of low oil pressure, high coolant temperature, low coolant level, and loss of magnetic pickup. These conditions can be observed by monitoring the **LED** status indicators on the front of the controller module.

- A. **MPEC Control Switch** – This switch controls the running of the unit. If this switch is set to the **OFF/RESET** position, the unit will not run. When this switch is set to the **MANUAL** position, the generator will start immediately.

If the generator is to be connected to a building's AC power source via an automatic transfer switch (isolation), place the switch in the **AUTO** position. In this position, should an outage occur, the automatic transfer switch (ATS) will start the generator automatically via the generator's auto-start contacts connected to the ATS's start contacts. Please refer to your ATS installation manual for further instructions for the correct installation of the auto-start contacts of the generator to the ATS.

- B. **Low Oil Pressure** – Indicates the engine pressure has fallen below 15 psi. The oil pressure is detected using variable resistive values from the oil pressure sending unit. This is considered a **major** fault.
- C. **High Coolant Temperature** – Indicates the engine temperature has exceeded 239°F. The engine temperature is detected using variable resistive values from the temperature sending unit. This is considered a **major** fault.
- D. **Overcrank Shutdown** – Indicates the unit has attempted to start a pre-programmed number of times, and has failed to start. The number of cycles and duration are programmable. It is pre-set at 3 cycles with a 10 second duration. This is considered a **major** fault.
- E. **Overspeed Shutdown** – Indicates the engine is running at an unsafe speed. This is considered a **major** fault.
- F. **Engine Running** – Indicates that engine is running at a safe operating speed.

# DCA-220SSJ — OUTPUT TERMINAL PANEL FAMILIARIZATION

## Output Terminal Panel

The **Output Terminal Panel** (Figure 9) shown below is located on the right-hand side (left from control panel) of the generator. Lift up on the cover to gain access to receptacles and terminal lugs.

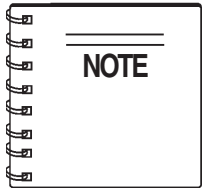

Terminal legs "O" and "Ground" are considered **bonded grounds**.

## Output Terminal Familiarization

The "**Output Terminal Panel**" (Figure 8) is provided with the following:

- Three (3) 120/240V output receptacles @ 50 amp
- Three (3) Circuit Breakers @ 50 amps
- Two (2) 100V GFCI receptacles @ 20 amp
- Two (2) GFCI Circuit Breakers @ 20 amps
- Five (5) Output Terminal Lugs ( U, V, W, O, Ground)

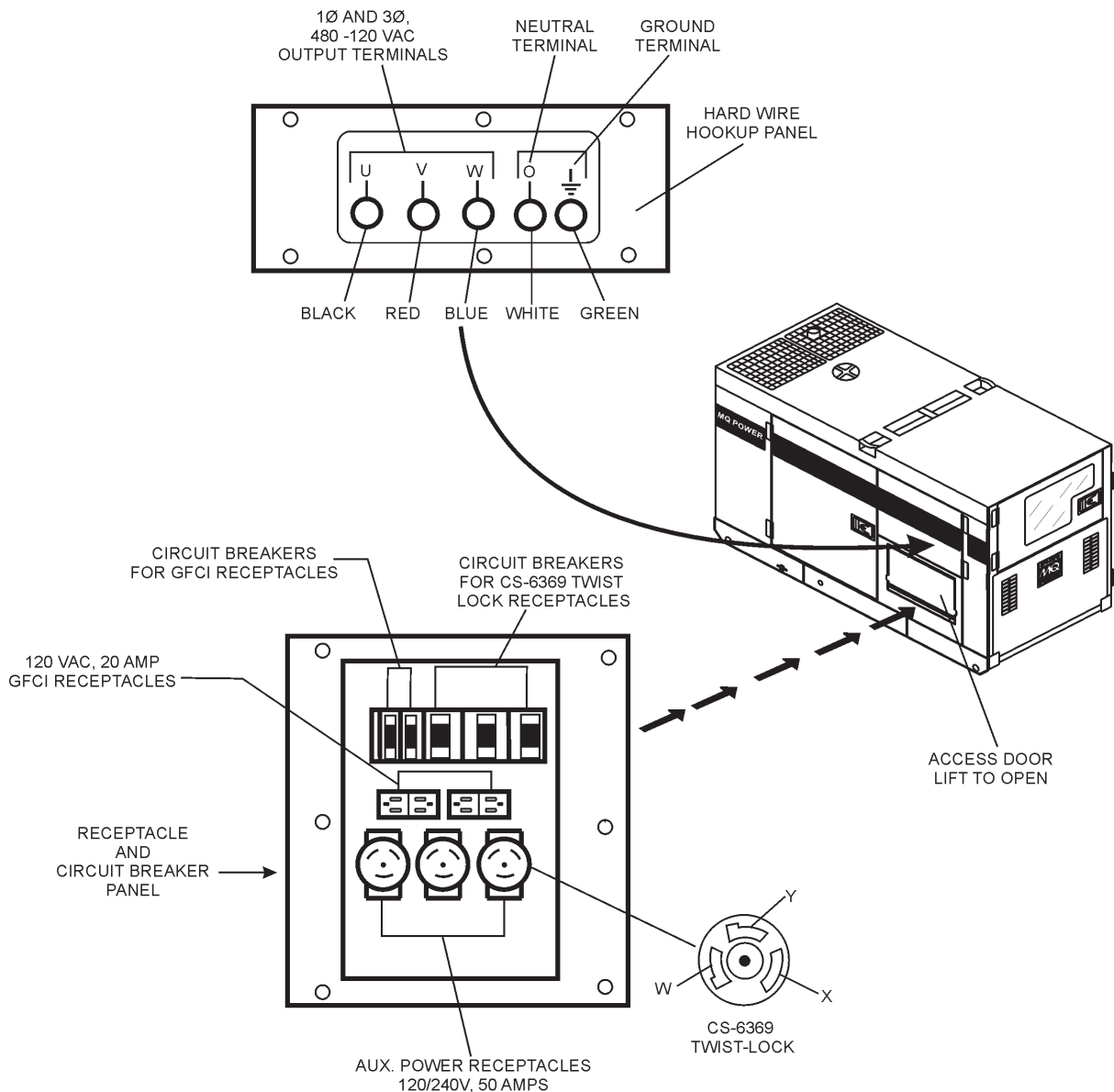

Figure 9. Output Terminal Panel



# DCA-220SSJ — OUTPUT TERMINAL PANEL FAMILIARIZATION

## 100 VAC GFCI Receptacles

There are two 120 VAC, 20 amp GFCI (Duplex Nema 5-20R) receptacles provided on the output terminal panel. These receptacles can be accessed in **any voltage selector switch** position. Each receptacle is protected by a 20 amp circuit breaker. These breakers are located directly above the GFCI receptacles. Remember the load output (current) of both GFCI receptacles is dependent on the load requirements of the U, V, and W output terminal lugs.

Pressing the **reset** button resets the GFCI receptacle after being tripped. Pressing the **Test Button** (See Figure 10) in the center of the receptacle will check the GFCI function. Both receptacles should be tested at least once a month.

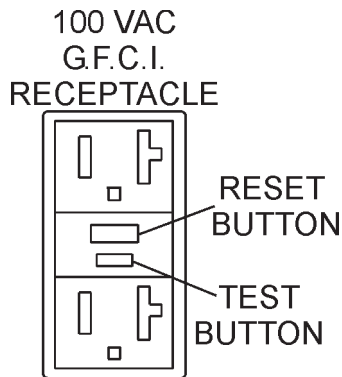

Figure 10. G.F.C.I. Receptacle

## Twist Lock Dual Voltage 120/240 VAC Receptacles

There are three 240/139V, 50 amp auxilliary twist-lock (CS-6369) receptacles (Figure 11) provided on the output terminal panel. These receptacles can **only** be accessed when the voltage change-over board is configured for **three-phase 240 operation**.

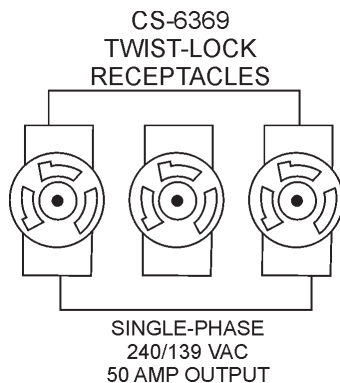

Figure 11. 240/139V Twist-Lock Auxiliary Receptacles

Each auxilliary receptacle is protected by a 50 amp circuit breaker. These breakers are located directly above the GFCI receptacles. Remember the load output (current) on all three receptacles is dependent on the load requirements of the **Output Terminal Lugs**.

Turn the **voltage regulator control knob** (Figure 12) on the control panel to obtain the desired voltage. Turning the knob clockwise will **increase** the voltage, turning the knob counter-clockwise will **decrease** the voltage.



Figure 12. Voltage Regulator Control Knob

## Removing the Plastic Face Plate (Hard Wire Hookup Panel)

The **Output Terminal Lugs** are protected by a plastic face plate cover (Figure 13). Un-screw the securing bolts and lift the plastic terminal cover to gain access to the terminal enclosure.

After the load wires have been securely attached to the terminal lugs, reinstall the plastic face plate.

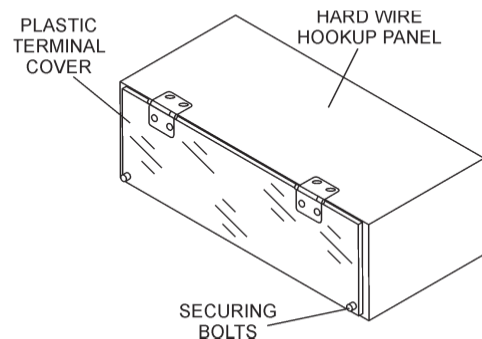

Figure 13. Plastic Face Plate (Output Terminal Lugs)

# DCA-220SSJ — OUTPUT TERMINAL PANEL FAMILIARIZATION

## Connecting Loads

Loads can be connected to the generator by the **Output Terminal Lugs** or the convenience receptacles (Figure 14). Make sure to read the operation manual before attempting to connect a load to the generator.

To protect the output terminals from overload, a 3-pole, 600A **main** circuit breaker is provided. Make sure to switch **ALL** circuit breakers to the **OFF** position prior to starting the engine.

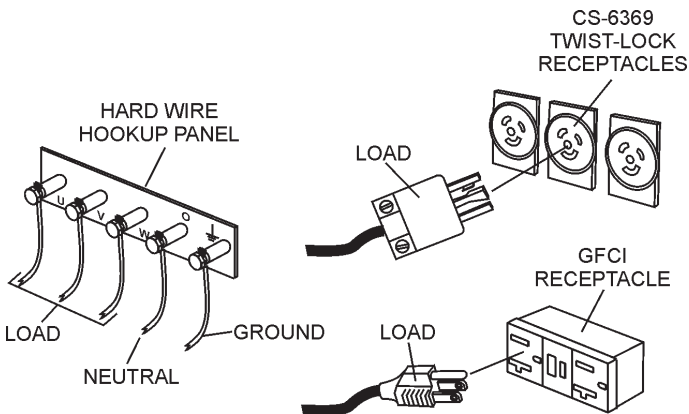

Figure 14. Connecting Loads

## Over Current Relay

An **over current relay** (Figure 15) is connected to the main circuit breaker. In the event of an overload, both the circuit breaker and the over current relay may trip. If the circuit breaker can not be reset, the **reset button** on the over current relay must be pressed. The over current relay is located in the control box.

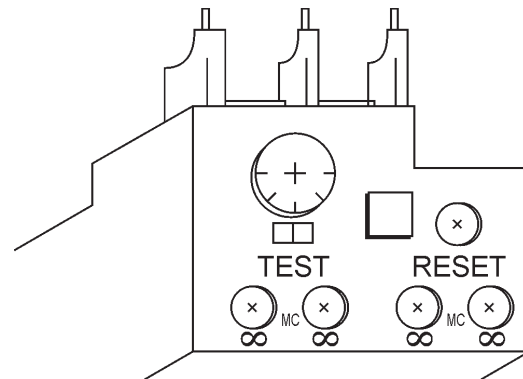

Figure 15. Over Current Relay

# DCA-220SSJ — LOAD APPLICATION

## Single Phase Load

Always be sure to check the nameplate on the generator and equipment to insure the wattage, amperage, frequency, and voltage requirements are satisfactorily supplied by the generator for operating the equipment.

Generally, the wattage listed on the nameplate of the equipment is its rated output. Equipment may require 130—150% more wattage than the rating on the nameplate, as the wattage is influenced by the efficiency, power factor and starting system of the equipment.

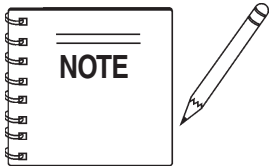

If wattage is not given on the equipment's name plate, approximate wattage may be determined by multiplying nameplate voltage by the nameplate amperage.

$$\text{WATTS} = \text{VOLTAGE} \times \text{AMPERAGE}$$

The power factor of this generator is 0.8. See Table 5 below when connecting loads.

**Table 5. Power Factor By Load**

Type Of Load	Power Factor
Single-phase induction motors	0.4 - 0.75
Electric heaters, incandescent lamps	1.0
Fluorescent lamps, mercury lamps	0.4 - 0.9
Electronic devices, communication equipment	1.0
Common power tools	0.8

**Table 6. Cable Selection (60 Hz, Single Phase Operation)**

Current in Amperes	Load In Watts		Maximum Allowable Cable Length			
	At 100 Volts	At 200 Volts	#10 Wire	#12 Wire	#14 Wire	#16 Wire
2.5	300	600	1000 ft.	600 ft.	375 ft.	250 ft.
5	600	1200	500 ft.	300 ft.	200 ft.	125 ft.
7.5	900	1800	350 ft.	200 ft.	125 ft.	100 ft.
10	1200	2400	250 ft.	150 ft.	100 ft.	
15	1800	3600	150 ft.	100 ft.	65 ft.	
20	2400	4800	125 ft.	75 ft.	50 ft.	

CAUTION: Equipment damage can result from low voltage.

## Three Phase Load

When calculating the power requirements for 3-phase power use the following equation:

$$\text{KVA} = \frac{\text{VOLTAGE} \times \text{AMPERAGE} \times 1.732}{1000}$$

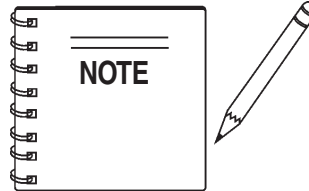

If 3Ø load (kVA) is not given on the equipment nameplate, approximate 3Ø load output may be determined by multiplying voltage by amperage by 1.732.

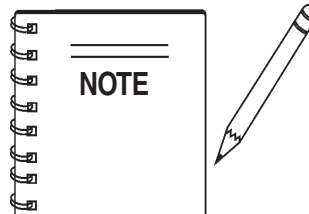

Motors and motor-driven equipment draw much greater current for starting than during operation.

An inadequate size connecting cable which cannot carry the required load can cause a voltage drop which can burn out the appliance or tool and overheat the cable. See Table 6.

- When connecting a resistance load such as an incandescent lamp or electric heater, a capacity of up to the generating set's rated output (kW) can be used.
- When connecting a fluorescent or mercury lamp, a capacity of up to the generating set's rated output (kW) multiplied by 0.6 can be used.
- When connecting an electric drill or other power tools, pay close attention to the required starting current capacity.

When connecting ordinary power tools, a capacity of up to the generating set's rated output (kW) multiplied by 0.8 can be used.

## DANGER - ELECTRICAL SYSTEM HAZARDS

Before connecting this generator to any building's electrical system, a **licensed electrician** must install an **isolation (transfer) switch**. Serious damage to the building's electrical system may occur without this transfer switch.

# DCA-220SSJ — GENERATOR OUTPUTS

## Generator Output Voltages

A wide range of voltages are available to supply voltage for many different applications. Voltages are selected by applying jumpers (6) to the **voltage change-over board** (Figure 15). To obtain some of the voltages as listed in Table 6 (see below) will require a fine adjustment using the **voltage regulator (VR) control knob** located on the control panel.

## Voltage Change-Over Board

The **voltage change-over board** (Figure 16) is located on the control box, behind the generator control panel. This board has been provided for ease of voltage selection.

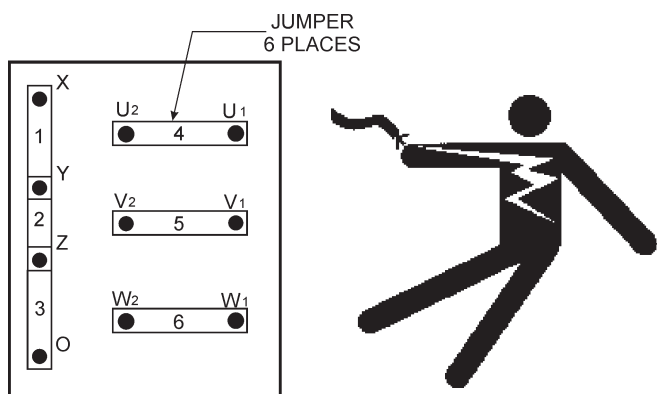

Figure 16. Voltage Change-Over Board

**⚠ CAUTION - CHANGING VOLTAGES**

**NEVER** attempt to place jumper plates on the **voltage change-over board** while the generator is in operation. There exist the possibility of **electrocution, electrical shock or burn, which can cause severe bodily harm or even death!**

Table 7. Voltages Available						
Three Phase (Selectable)	208V	220V	240V	416V	440V	480V
Single Phase (Selectable)	120V	127V	139V	240V	254V	277V

## Generator Amperage

Tables 8 and 9 describe the generator's current output capability for both 1Ø-phase and 3Ø phase applications.

Table 8. Generator Ampere Ratings — 1Ø		
kW	120V	240V
16	134	67
36	300	150
56	467	233
76	634	317
96	800	400
116	966	483
136	1,136	568
156	1,300	650
176 (Max)	1,466	733

Table 9. Generator Ampere Ratings — 3Ø		
KVA	240V	480V
25	60	30
45	108	54
60	144	72
70	168	84
82	197	99
100	241	120
125	301	150
150	361	180
180	433	216
220	529	265

# DCA-220SSJ — GENERATOR OUTPUTS/ GAUGE READING

## Maximum Amps

Table 10 shows the *maximum* amps the generator can provide. **DO NOT** exceed the maximum amps as listed.

Table 10. Generator Maximum Amps	
Model	DCA220SSJ
Rated Voltage	Maximum Amps
Single Phase 120 Volt	488.9 amps (4 wire)
Single Phase 240 Volt	244.4 amps (4 wire)
Three Phase 240 Volt	529 amps
Three Phase 480 Volt	264 amps

## How to Read the Output Terminal Gauge.

The AC ammeter and AC voltmeter change-over switches on the control panel **DO NOT** effect the generator output. They are provided to help observe how much power is being supplied, produced at the UVWO terminals lugs.

When the voltage change-over board (Figure 16) is jumpered for 3Ø, 240V operation place the **AC Voltmeter Change-Over Switch** (Figure 17) to the W-U position and the **AC Ammeter Change-Over Switch** (Figure 19) to the U or W position. Use the AC voltmeter or AC ammeter (Figures 18 and 20) to read the output on the selected leg of the UVWO terminals.

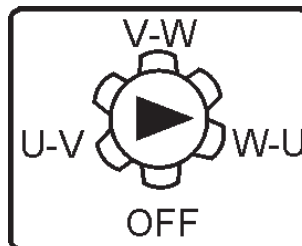

Figure 17. AC Voltmeter Change-Over Switch

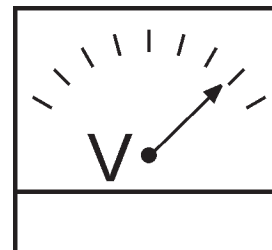

Figure 18. AC Voltmeter Gauge (Volt reading on W-U Lug)

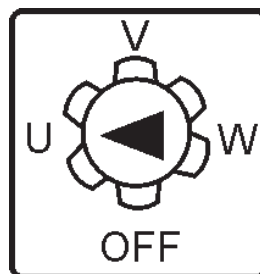

Figure 19. AC Ammeter Change-Over Switch

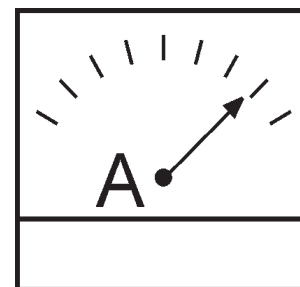
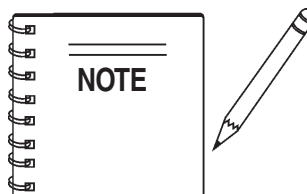

Figure 20. AC Ammeter (Amp reading on U lug)



The *ammeter* gauge will only show a reading when the **Output Terminal Lugs** are connected to a load and in use.

# DCA-220SSJ — OUTPUT TERMINAL PANEL CONNECTIONS

## UVWO Terminal Output Voltages

Various output voltages can be obtained using the UVWO output terminal lugs. The voltages at the terminals are dependent on the placement of the jumpers plates (6) on the **Voltage Change-Over Board** and the adjustment of the **Voltage Regulator Control Knob**.

Remember the voltage change-over board determines the **range** of the output voltage and can be configured in two different positions that provide 6 different output voltages at the UVWO output terminals. The generator is shipped from the factory in the 240V configuration. The voltage regulator (VR) allows the user to increase or decrease the selected voltage.

## 3Ø-240V UVWO Terminal Output Voltages

1. Jumper the voltage change-over board for 240V operation as shown in Figure 21.

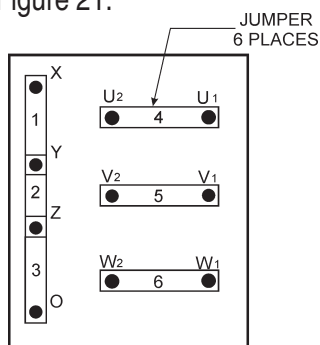

Figure 21. Voltage Change-Over Board 240V Configuration

2. Connect the load wires to the UVWO terminals as shown in Figure 22.

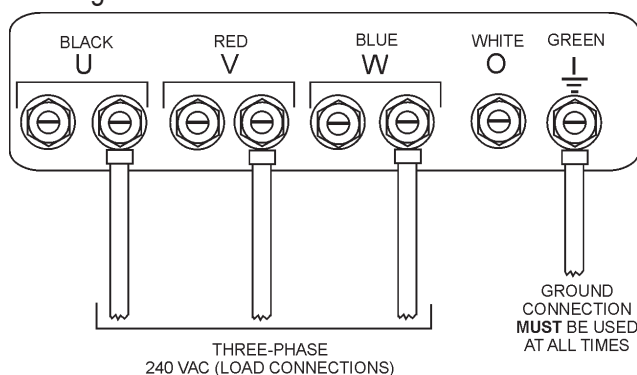

Figure 22. UVWO Terminal Lugs 3Ø-240V Connections

3. Turn the voltage regulator knob (Figure 23) clockwise to increase voltage output, turn counterclockwise to decrease voltage output. Use voltage regulator adjustment knob whenever fine tuning of the output voltage is required



Figure 23. Voltage Regulator Knob

## 1Ø-240V UVWO Terminal Output Voltages

1. Make sure the voltage change-over board is jumpered for 240V operation as shown in Figure 21 .
2. Connect the load wires to the UVWO terminals as shown in Figure 24.

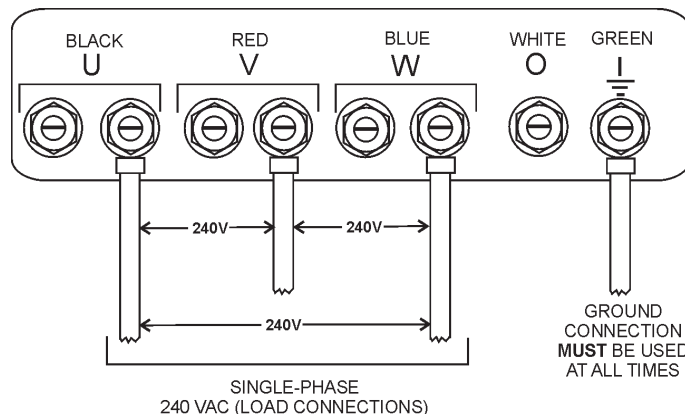

Figure 24. UVWO Terminal Lugs 1Ø-240V Connections

## 1Ø-139V UVWO Terminal Output Voltages

1. Make sure the voltage change-over board is jumpered for 240V operation as shown in Figure 21.
2. Connect the load wires to the UVWO terminals as shown in Figure 25.

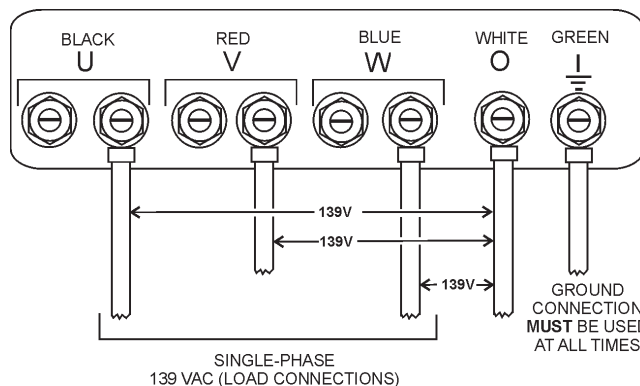

Figure 25. UVWO Terminal Lugs 1Ø-139V Connections



# DCA-220SSJ — OUTPUT TERMINAL PANEL CONNECTIONS

## 3Ø-480V UVW Terminal Output Voltages

1. Jumper the voltage change-over board for 480V operation as shown in Figure 26. This configuration uses 6 jumper plates in 3 different positions. Remember there are 2 jumper plates at every position. Every jumper plate **must** be used.

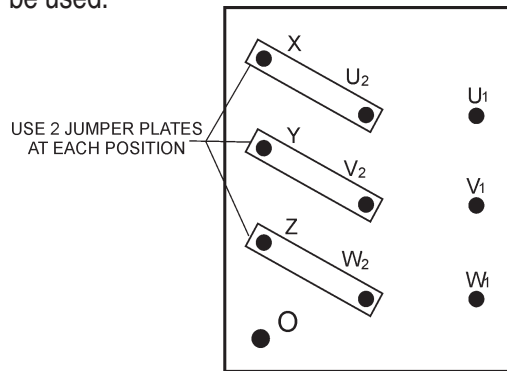

Figure 26. Voltage Change-Over Board 480V Configuration

2. Connect the load wires to the UVW terminals as shown in Figure 27.

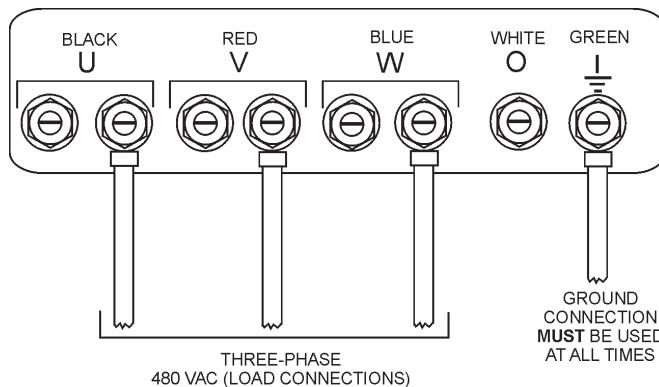
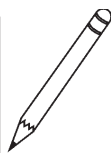
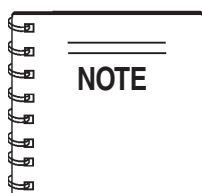

Figure 27. UVW Terminal Lugs 3Ø-480V Connections



**ALWAYS** make sure that the connections to the UVW terminals are **secure** and **tight**. The possibility of arcing exists, that could cause a fire.

## 1Ø-480V UVW Terminal Output Voltages

1. Make sure the voltage change-over board is jumpered for 480V operation as shown in Figure 26.
2. Connect the load wires to the UVW terminals as shown in Figure 28.

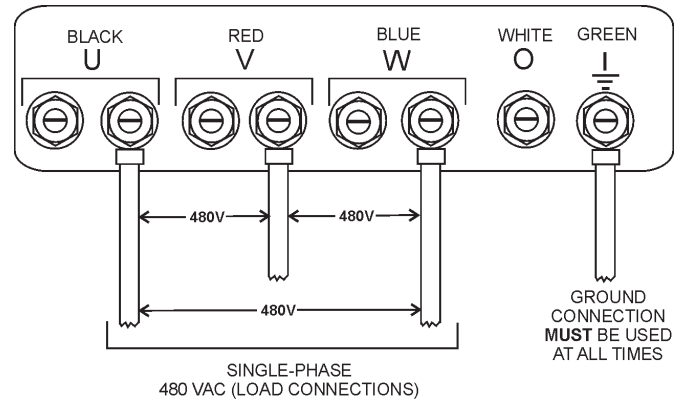

Figure 28. UVW Terminal Lugs 1Ø-480V Connections

## 1Ø-277V UVW Terminal Output Voltages

1. Make sure the voltage change-over board is jumpered for 480V operation as shown in Figure 26.
2. Connect the load wires to the UVW terminals as shown in Figure 29.

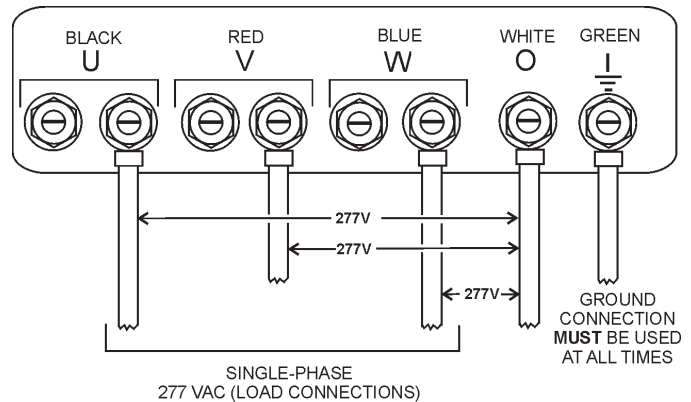

Figure 29. UVW Terminal Lugs 1Ø-277V Connections

## Circuit Breakers

To protect the generator from an overload, a 3-pole, 600 amp, **main** circuit breaker is provided to protect the **U, V, and W Output Terminals** from overload. In addition two single-pole, 20 amp **GFCI** circuit breakers are provided to protect the GFCI receptacles from overload. Three 50 amp **load** circuit breakers have also been provided to protect the auxiliary receptacles from overload. Make sure to switch **ALL** circuit breakers to the **OFF** position prior to starting the engine.

## Lubrication Oil

Fill the engine crankcase with lubricating oil through the filler hole, but **DO NOT** overfill. Make sure the generator is level, and verify that the oil level is maintained between the two notches (Figure 30) on the dipstick. See Table 9 for proper selection of engine oil.

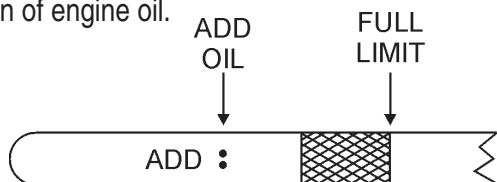

Figure 30. Engine Oil Dipstick

When checking the engine oil, be sure to check if the oil is clean. If the oil is not clean, drain the oil by removing the oil drain plug, and refill with the specified amount of oil as outlined in the **John Deere Engine Owner's Manual**. Oil should be warm before draining.

Other types of motor oils may be substituted if they meet the following requirements:

- API Service Classification CC/SC
- API Service Classification CC/SD
- API Service Classification CC/SE
- API Service Classification CC/SF

		OIL: SAE	
°F	°C		
122	50	10W/40	30
104	40	10W/40	30
86	30	10W/40	30
68	20	10W/40	30
50	10	10W/40	30
32	0	10W/40	30
-14	-10	5W/30	30
-4	-20	5W/30	30
-22	-30	5W/30	30
-40	-40	ARCTIC OIL	30

## Fuel Check

**! DANGER - EXPLOSION/FIRE HAZARDS**

Fuel spillage on a **hot** engine can cause a **fire** or **explosion**. If fuel spillage occurs, wipe up the spilled fuel completely to prevent fire hazards. **NEVER** smoke around or near the generator.

## Refilling the Fuel System

**! CAUTION - REFUELING THE GENERATOR**

**ONLY properly trained personnel** who have read and understand this section should refill the fuel tank system.

This generator has an internal fuel tank located inside the trailer frame and may also be equipped with an environmental fuel tank (Figure 31). **ALWAYS** fill the fuel tanks with clean fresh **#2 diesel fuel**. **DO NOT** fill the fuel tanks beyond their capacities.

Pay attention to the fuel tank capacity when replenishing fuel. The fuel tank cap must be closed tightly after filling. Handle fuel in a safety container. If the container does not have a spout, use a funnel. Wipe up any spilled fuel immediately.

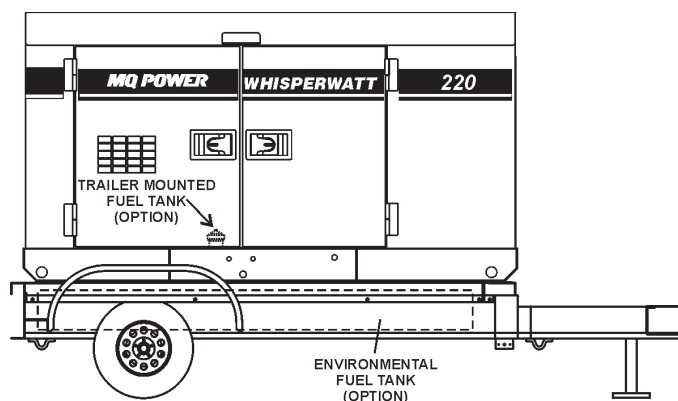

Figure 31. Internal Fuel Tank System

## Refueling Procedure:

### ! WARNING - RESPIRATORY HAZARDS

**Diesel fuel** and its vapors are dangerous to your health and the surrounding environment. Avoid skin contact and/or inhaling fumes.



1. **Level Tanks** – Make sure fuel cells are level with the ground. Failure to do so will cause fuel to spill from the tank before reaching full capacity (Figure 32).

### ! CAUTION - REFUELING THE GENERATOR

**ALWAYS** place trailer on firm level ground before refueling to prevent spilling and maximize the amount of fuel that can be pumped into the tank.

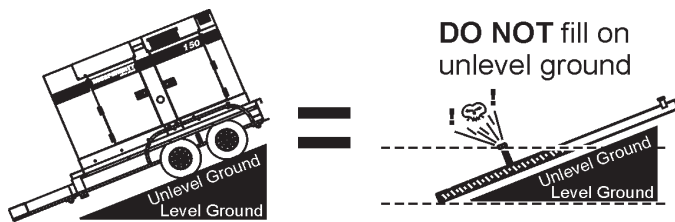
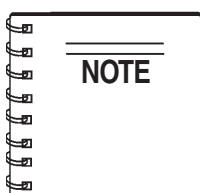

Figure 32. Only Fill on Level Ground



**ONLY!** use #2 diesel fuel when refueling.

3. Open cabinet doors on the “right side” of the generator (from generator control panel position). Remove fuel cap and fill tank (Figure 33).

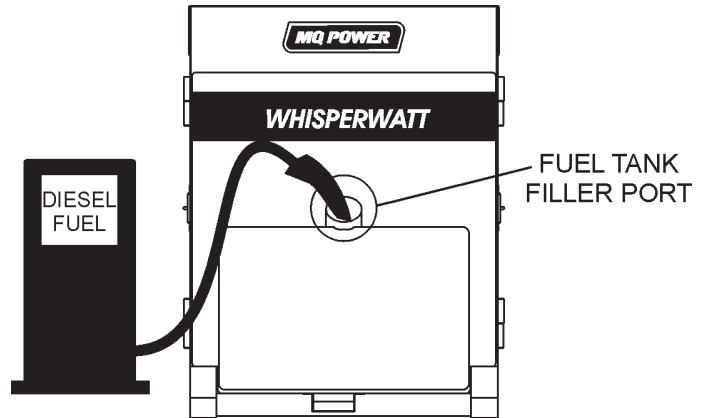

Figure 33. Fueling the Generator

3. **NEVER** overfill fuel tank – It is important to read the fuel gauge when filling trailer fuel tank. **DO NOT** wait for fuel to rise in filler neck (Figure 34).

FUEL GAUGE LOCATED ON CONTROL PANEL

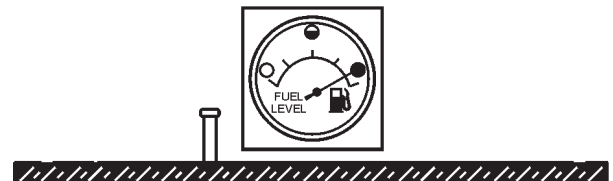

Figure 34. Full Fuel Tank

### ! CAUTION - REFUELING THE GENERATOR

**DO NOT OVER-FILL** fuel system. Leave room for fuel expansion. Fuel expands when heated (Figure 35).



Figure 35. Fuel Expansion

## Coolant (Antifreeze)

John Deere recommends Antifreeze/Summer Coolant for use in their engines, which can be purchased in concentrate (and mixed with 50% demineralized water) or pre-diluted. See the **John Deere Engine Owner's Manual** for further details

**! WARNING - BURN HAZARDS**

If adding coolant/antifreeze mix to the radiator, **DO NOT** remove the radiator cap until the unit has completely cooled. The possibility of **hot!** coolant exists which can cause severe burns.



Day-to-day addition of coolant is done from the recovery tank. When adding coolant to the radiator, **DO NOT** remove the radiator cap until the unit has completely cooled. See Table 12 for engine, radiator, and recovery tank coolant capacities. Make sure the coolant level in the recovery tank is always between the "H" and the "L" markings.

Component	Capacity
Engine and Radiator	6.4 Gal. (24 liters)
Reserve Tank	2 Quarts (1.9 liters)

## Operation Freezing Weather

When operating in freezing weather, be certain the proper amount of antifreeze (Table 13) has been added.

Vol % Anti-Freeze	Freezing Point	
	°C	°F
50	-37	-34

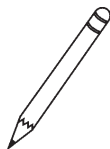
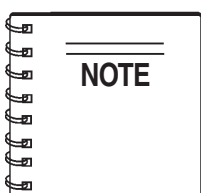

When the antifreeze is mixed with water, the antifreeze mixing ratio **must be** less than 50%.

## Cleaning the Radiator

The engine may overheat if the radiator fins become overloaded with dust or debris. Periodically clean the radiator fins with compressed air. Cleaning inside the machine is dangerous, so clean only with the engine turned off and the **negative** battery terminal disconnected.

## Air Cleaner

Periodic cleaning/replacement is necessary. Inspect it in accordance with the **John Deere Engine Owner's Manual**.

## Fan Belt Tension

A slack fan belt may contribute to overheating, or to insufficient charging of the battery. Inspect the fan belt for damage and wear and adjust it in accordance with the **John Deere Engine Owner's Manual**.

The fan belt tension is proper if the fan belt bends 10 to 15 mm (Figure 36) when depressed with the thumb as shown below.

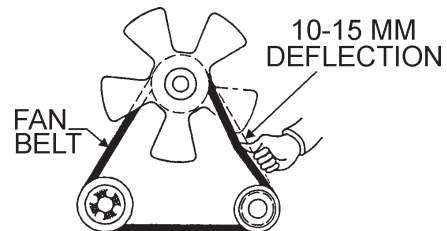

**Figure 36. Fan Belt Tension**

**! CAUTION - ROTATING PARTS**

**NEVER** place hands near the belts or fan while the generator set is running.

## Battery

This unit is of negative ground **DO NOT** connect in reverse. Always maintain battery fluid level between the specified marks. Battery life will be shortened, if the fluid level are not properly maintained. Add only distilled water when replenishment is necessary.

**DO NOT** over fill. Check to see whether the battery cables are loose. Poor contact may result in poor starting or malfunctions. **Always** keep the terminals firmly tightened. Coating the terminals with an approved battery terminal treatment compound. Replace battery with only recommended type battery.

The battery is sufficiently charged if the specific gravity of the battery fluid is 1.28 (at 68° F). If the specific gravity should fall to 1.245 or lower, it indicates that the battery is dead and needs to be recharged or replaced.

Before charging the battery with an external electric source, be sure to disconnect the battery cables.

## Battery Cable Installation

**ALWAYS** be sure the battery cables (Figure 37) are properly connected to the battery terminals as shown below. The **Red Cable** is connected to the positive terminal of the battery, and the **Black Cable** is connected to the negative terminal of the battery.

**! CAUTION - BATTERY SERVICING SAFETY**

**ALWAYS** disconnect the negative terminal **FIRST** and reconnect negative terminal **LAST**.

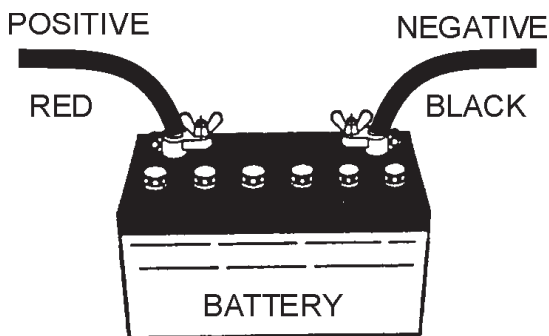
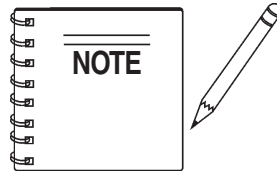

Figure 37. Battery Connections

When connecting battery do the following:

1. **NEVER** connect the battery cables to the battery terminals when the **MPEC Control Switch** is in either the **MANUAL** or **AUTO** position. **ALWAYS** make sure that the **MPEC Control Switch** is in the **OFF/RESET** position when connecting the battery.
2. Place a small amount of battery terminal treatment compound around both battery terminals. This will ensure a good connection and will help prevent corrosion around the battery terminals.



If the battery cable is connected incorrectly, electrical damage to the generator will occur. Pay close attention to the polarity of the battery when connecting the battery.

**! CAUTION - BATTERY SERVICING SAFETY**

Inadequate battery connections may cause poor starting of the generator, and create other malfunctions.

## Alternator

The polarity of the alternator is negative grounding type. When an inverted circuit connection takes place, the circuit will be in short circuit instantaneously resulting the alternator failure.

**DO NOT** put water directly on the alternator. Entry of water into the alternator can cause corrosion and damage the alternator.

## Wiring

Inspect the entire generator for bad or worn electrical wiring or connections. If any wiring or connections are exposed (insulation missing) replace wiring immediately.

## Piping and Hose Connection

Inspect all piping, oil hose, and fuel hose connections for wear and tightness. Tighten all hose clamps and check hoses for leaks.

If any hose (**fuel** or **oil**) lines are defective replace them immediately.

# DCA-220SSJ — GENERATOR START-UP PROCEDURE (MANUAL)

## Before Starting

### ⚠ CAUTION - LETHAL EXHAUST HAZARD

The engine's exhaust contains harmful emissions. **ALWAYS have adequate ventilation when operating.** Direct exhaust away from nearby personnel.

### ⚠ WARNING - STARTING THE GENERATOR

**NEVER!** manually start the engine with the **main, GFCI** or **auxiliary** circuit breakers in the **ON** (closed) position.

The Engine Control Unit (ECU) used with this generator diagnosis engine faults that arise with the the engine control system and the engine itself. Engine faults can be determined by viewing the Diagnostic Trouble Codes (Active Fault Codes) which are displayed on the Diagnostic Display Panel located inside the Control Box.

1. Before starting the engine, make sure the diagnostic switch (Figure 38) on the Diagnostic Display Panel Assembly is in the "OFF" position.

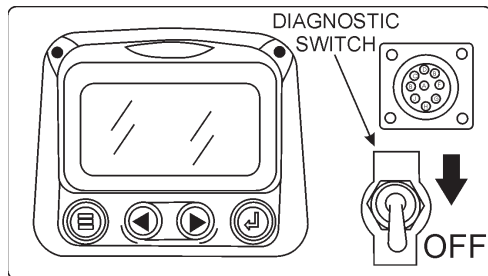

Figure 38. Diagnostic Switch (OFF position)

2. Place the **main, G.F.C.I.,** and **aux.** circuit breakers (Figure 39) in the **OFF** position prior to starting the engine.

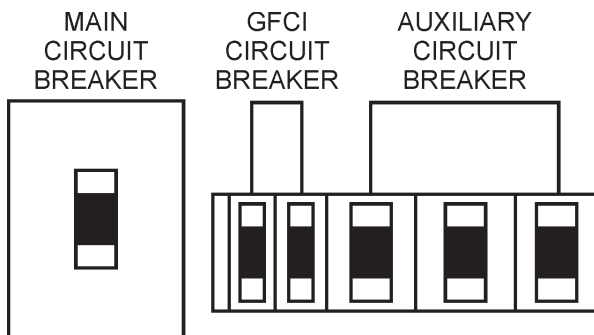
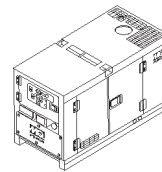
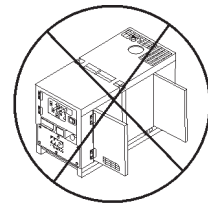

Figure 39. Main, Aux. and GFCI Circuit Breakers (OFF)

3. Make sure the the **voltage change-over board** has been configured for the desired output voltage.
4. Connect the load to the **receptacles** or the **output terminal lugs** as shown in Figure 14. These load connection points can be found on the output terminal panel and the output terminal panel's hard wire hookup panel.
5. The output terminal lugs are protected by a plastic cover. Remove this cover to gain access to the terminals. Tighten terminal nuts securely to prevent load wires from slipping out.
6. Close all engine enclosure doors (Figure 40).



CORRECT



INCORRECT

Figure 40. Engine Enclosure Doors

## Starting (Manual)

1. Place the engine speed switch (Figure 41) in the "**LOW**" (down) position



Figure 41. Engine Speed Switch (Low)

2. Place the **MPEC Control Switch** in the **MANUAL** position to start the engine (Figure 42). Observe that the Warning and Emergency Stop lamps on the Engine Operating Panel are lit during the initial starting of the engine. If no abnormal conditions exists, both lamps will turn off.



Figure 42. MPEC Control Switch (Manual Position)



# DCA-220SSJ — GENERATOR START-UP PROCEDURE (MANUAL)

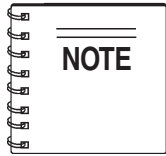

When the MPEC Control switch is placed in the manual position, preheating of the glow plugs will begin automatically and the preheat lamp will stay lit until the

glow plugs are warmed. When the preheat lamp goes off this signals the completion of the preheating cycle and the starting of the engine.

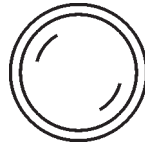

**Preheat Lamp**

- If any abnormalities exist, the Warning and Emergency Stop lamps on the Engine Operating Panel will be lit.
- Place the **MPEC Control Switch** (Figure 42) in the **OFF/RESET** position.
- Place the Diagnostic ON/OFF switch in the **ON** position. Verify that an Active Fault Code message is being displayed (Diagnostic Display Panel). The fault code message will continue to be displayed until the fault has been corrected. Figure 43 shown below is a typical example of an active fault code message (Low Radiator Coolant).

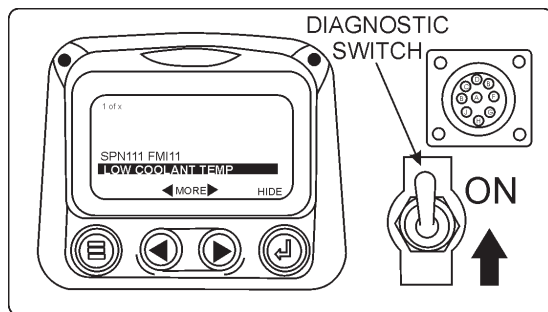

**Figure 43. Active Fault Code Message**

- In a situation where several engine problems occur simultaneously, the word **"MORE"** appears above the arrow buttons indicating that there are more fault codes that need to be viewed. Use the arrow buttons to scroll to the next active fault code.

If desired, the type of fault code, cause of error and the countermeasures of the error can be referenced in a separate engine operator's manual.

- Before the engine can be started, the engine fault must be corrected. Also observe that there are no active fault codes displayed on the diagnostic panel. If no fault codes are displayed, place the diagnostic switch in the **OFF** position.

- To restart the engine due to error codes, place the **MPEC Control Switch** in the **MANUAL** position (Figure 42)
- If the engine is running smoothly, place the engine speed switch (Figure 44) in the **"HIGH"** (up) position.



**Figure 44. Engine Speed Switch (High)**

- Verify that the **Engine Running** status LED on the MPEC unit (Figure 45) is **ON** (lit) after the engine has been started.



**Figure 45. Engine Running LED (ON)**

- Observe that the Warning and Emergency Stop lamps on the Engine Operating Panel are **OFF**.
- The generator's frequency meter (Figure 46) should be displaying the 60 cycle output frequency in **HERTZ**.

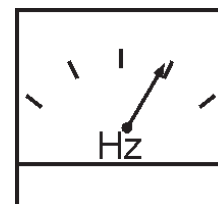

**Figure 46. Frequency Meter (Hz)**

- The generator's AC-voltmeter (Figure 47) will display the generator's output in **VOLTS**. If the voltage is not within the specified tolerance, use the voltage adjustment control knob (Figure 48) to increase or decrease the desired voltage.

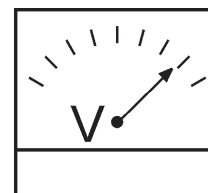

**Figure 47. Voltmeter**

# DCA-220SSJ — GENERATOR START-UP PROCEDURE (MANUAL)



Figure 48. Voltage Adjust Control Knob

14. The ammeter (Figure 49) will indicate **zero amps** with no load applied. When a load is applied, the ammeter will indicate the amount of current that the load is drawing from the generator.

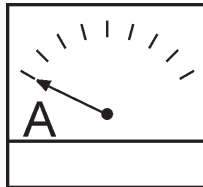

Figure 49. Ammeter (No Load)

15. The engine oil pressure gauge (Figure 50) will indicate the oil pressure of the engine. Under normal operating conditions the oil pressure is approximately 35 to 65 psi. (241~448 kPa). When starting the generator

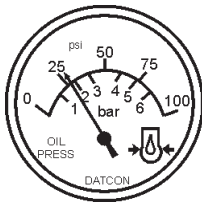

Figure 50. Oil Pressure Gauge

16. The **coolant temperature gauge** (Figure 51) will indicate the coolant temperature. Under normal operating conditions the coolant temperature should be between 180~230°F (82~110 °C) **Green Zone**.

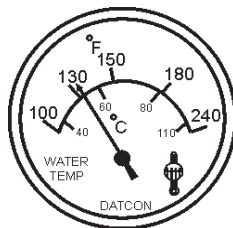

Figure 51. Coolant Temperature Gauge

17. The **tachometer gauge** (Figure 52) will indicate the speed of the engine when the generator is operating. Under normal operating conditions this speed is approximately 1800 RPM's.

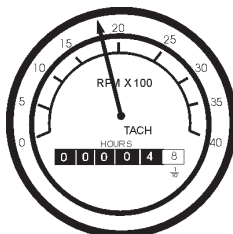

Figure 52. Engine Tachometer Gauge

18. Place the **main**, **GFCI**, and **aux.** circuit breakers in the **ON** position (Figure 53).

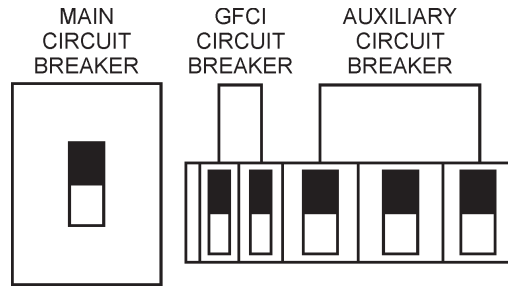

Figure 53. Main, Aux. and GFCI Circuit Breakers (ON)

19. Observe the generator's ammeter (Figure 54) and verify it reads the anticipated amount of current with respect to the load. The ammeter will only display a current reading if a load is in use.

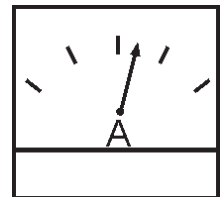

Figure 54. Ammeter (Load)

20. The generator will run until manually stopped or an abnormal condition occurs.

## Starting (Auto Mode)

### ! DANGER - ELECTRICAL SYSTEM HAZARDS

Before connecting this generator to any building's electrical system, a **licensed electrician** must install an **isolation (transfer) switch**. Serious damage to the building's electrical system may occur without this transfer switch.



### ! CAUTION - BACKUP GENERATOR USE

When connecting the generator to a isolation (transfer) switch, **ALWAYS** have power applied to the generator's internal battery charger. This will ensure that the engine will not fail due to a dead battery.

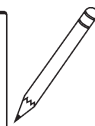
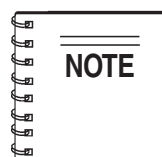

When the generator is set in the **AUTO** mode, the generator will **automatically start** in the event of commercial power falling below a prescribed level by means of a contact closure that is generated automatically by a transfer switch.

# DCA-220SSJ — GENERATOR START-UP PROCEDURE (AUTO MODE)

## WARNING - AUTO MODE MAINTENANCE

When running the generator in the **AUTO** mode, remember the generator can start up at any time without warning. **NEVER** attempt to perform any maintenance when the generator is in the auto mode.

## CAUTION - ENGINE SPEED SWITCH

The **Engine Speed Switch** must be set to the “**High**” position when running in the **Auto-Start** mode. Failing to set the switch in the proper position can result in damage to your generator when it turns on.

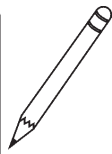
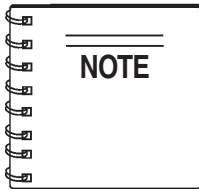

When the **MPEC Control Switch** is placed in the **AUTO** position, the engine glow plugs will be warmed and the engine will start automatically.

When starting generator in **AUTO** mode use the “**Manual Start-up**” procedure except where noted (see below).

1. Perform steps 1 through 6 in the **Before Starting** section as outlined in the **Manual Starting Procedure**.
2. Place the **engine speed switch** (Figure 54) in the **HIGH** position



**Figure 54. Engine Speed Switch (High)**

3. Place the **MPEC Control Switch** (Figure 55) in the **AUTO** position



**Figure 55. MPEC Control Switch (AUTO)**

4. Continue operating the generator as outlined in the **Manual Start-up** procedure (start at step 5).

# DCA-220SSJ — GENERATOR SHUT-DOWN PROCEDURES

## **! WARNING - SHUTTING DOWN THE GENERATOR**

**NEVER** stop the engine suddenly except in an emergency.

## **! CAUTION - DIAGNOSTIC SWITCH**

**ALWAYS** make sure the diagnostic switch is placed in the **OFF** position before attempting to shut down the generator. The **OFF/RESET** switch on the MEC controller will not shut down the generator if the diagnostic switch is left in the **ON** position.

### Normal Shutdown Procedure

To shutdown the generator use the following procedure:

1. Place both the **MAIN**, **GFCI** and **LOAD** circuit breakers as shown in Figure 39 to the **OFF** position.
2. Place the engine speed switch (Figure 56) in the "**LOW**" (down) position.



**Figure 56. Engine Speed Switch (Low)**

3. Let the engine cool by running it at low speed for 3-5 minutes with no load applied.
4. Place the **MPEC Control Switch** (Figure 57) to the **OFF/RESET** position.



**Figure 57. MPEC Control Switch (Off/Reset)**

5. Verify that the **all** status LED on the MPEC display are **OFF** (not lit).
6. Remove all loads from the generator.
7. Inspect entire generator for any damage or loosening of components that may have occurred during operation.

### Emergency Shutdown Procedure

1. To shut-down the engine in the event of an emergency, push the **Emergency Stop Button** (Figure 58).
2. Switch the **MAIN**, **GFCI** and **LOAD** (Figure 38) circuit breakers to **OFF** position.



**Figure 58. Emergency Stop Button**

TABLE 14. INSPECTION/MAINTENANCE		10 Hrs DAILY	250 Hrs	500 Hrs	1000 Hrs
<b>ENGINE</b>	Check Engine Fluid Levels	X			
	Check Air Cleaner	X			
	Check Battery Acid Level	X			
	Check Fan Belt Condition	X			
	Check for Leaks	X			
	Check for Loosening of Parts	X			
	Replace Engine Oil and Filter * 1		X		
	Clean Air Filter		X		
	Check Fuel Filter/Water Separator Bowl	X			
	Clean Unit, Inside and Outside		X		
	Change Fuel Filter			X	
	Clean Radiator and Check Coolant Protection Level*2			X	
	Replace Air Filter Element * 3			X	
	Check all Hoses and Clamps * 4				X
	Clean Inside of Fuel Tank				X
<b>GENERATOR</b>	Measure Insulation Resistance Over 3M ohms		X		
	Check Rotor Rear Support Bearing			X	

\*1 Replace engine oil and filter at 100 hours, first time only.

\*2 Add "Supplemental Coolant Additives (SCA'S)" to recharge the engine coolant.

\*3 Replace primary air filter element when restriction indicator shows a vacuum of 625 mm (25 in. H<sub>2</sub>O).

\*4 If blowby hose needs to be replaced, ensure that the slope of the blowby hose is at least a 1/2 inch per foot, with no sags or dips that could collect moisture and/or oil.

## General Inspection

Prior to each use, the generator should be cleaned and inspected for deficiencies. Check for loose, missing or damaged nuts, bolts or other fasteners. Also check for fuel, oil, and coolant leaks. Use Table 14 as a general maintenance guideline **Engine Side** (Refer to the Engine Instruction Manual)

### Air Cleaner

Every 250 hours: Remove air cleaner element and clean the heavy duty paper element with light spray of compressed air. Replace the air cleaner as needed.

### Air Cleaner with Dust Indicator

This indicator is attached to the air cleaner. When the air cleaner element is clogged, air intake restriction becomes greater and the dust indicator signal shows **RED** meaning the element needs changing or service. After changing the air element, press the dust indicator button to reset the indicator.

## Service Daily

If the engine is operating in very **dusty** or **dry grass** conditions, a clogged air cleaner will result. This can lead to a loss of power, excessive carbon buildup in the combustion chamber and high fuel consumption. Change air cleaner more **frequently** if these conditions exist.

### Fuel Addition

Add diesel fuel (the grade may vary according to season and locations).

### Removing Water from the Fuel Tank

After prolonged use, water and other impurities accumulate in the bottom of the tank. Occasionally inspect the fuel tank for water contamination and drain the contents if required.

During cold weather, the more empty volume inside the tank, the easier it is for water to condense. This can be reduced by keeping the tank full with diesel fuel.

## Air Removal

If air enters the fuel injection system of a diesel engine, starting becomes impossible. After running out of fuel, or after disassembling the fuel system, bleed the system according to the following procedure. See the *John Deere Engine Manual* for details.

To restart after running out of fuel, turn the switch to the "ON" position for 15-30 seconds. Try again, if needed. This unit is equipped with an automatic air bleeding system.

## Check Oil Level

Check the crankcase oil level prior to each use, or when the fuel tank is filled. Insufficient oil may cause severe damage to the engine. Make sure the generator is level. The oil level must be between the two notches on the dipstick as shown in Figure 31.

## Replacing Oil Filter

- Remove the old oil filter.
- Apply a film of oil to the gasket on the new oil filter.
- Install the new oil filter.
- After the oil cartridge has been replaced, the engine oil will drop slightly. Run the engine for a while and check for leaks before adding more oil if needed. Clean excessive oil from engine.

## Cleaning the Fuel Strainer

Clean the fuel strainer if it contains dust or water. Remove dust or water in the strainer cap and wash it in gasoline. Securely fasten the fuel strainer cap so that fuel will not leak. Check the fuel strainer every 200 hours of operation or once a month.

## Replacing Fuel Filter

- Replace the fuel filter cartridge with new one every 500 hours or so.
- Loosen the drain plug at the lower top of the fuel filter. Drain the fuel in the fuel body together with the mixed water. **DO NOT** spill the fuel during disassembly.
- Vent any air.

## Flushing Out Radiator and Replacing Coolant

- Open both cocks located at the crankcase side and at the lower part of the radiator and drain coolant. Open the radiator cap while draining. Remove the overflow tank and drain.
- Check hoses for softening and kinks. Check clamps for signs of leakage.
- Flush the radiator by running clean tap water through radiator until signs of rust and dirt are removed. **DO NOT** clean radiator core with any objects, such as a screwdriver.
- Tighten both cocks and replace the overflow tank.
- Replace with coolant as recommended by the engine manufacturer.
- Close radiator cap tightly.

### WARNING - BURN HAZARDS

Allow engine to **cool** when flushing out radiator. Flushing the radiator while hot could cause serious burns from water or steam.



## Generator Storage

For long term storage of the generator the following is recommended:

- Fill the fuel tank completely. Treat with a fuel stabilizer if necessary.
- Completely drain the oil from the crankcase and refill if necessary with fresh oil.
- Clean the entire generator, internal and external.
- Cover the generating set and store in a clean, dry place.
- Disconnect the battery.
- Make sure engine coolant is at proper level.
- If generator is mounted on a trailer, jack trailer up and place on blocks so tires do not touch the ground or block and completely remove the tires.



# DCA-220SSJ — MAINTENANCE (HEATER/CHARGER)

## Jacket Water Heater and Internal Battery Charger 120 VAC Input Receptacles (OPTIONAL)

This generator can be optionally equipped with two 120 VAC, 20 amp input receptacles located on the output terminal panel.

The purpose of these receptacles is to provide power via commercial power to the *jacket water heater* and *internal battery charger*.

These receptacles will **ONLY** function when commercial power has been supplied to them (Figure 59). To apply commercial power to these receptacles, a power cord of adequate size will be required (See Table 6).

When using the generator in *hot* climates there is no reason to apply power to jacket water heater. However, if the generator will be used in *cold* climates it is always a good idea to apply power to the jacket water heater at all times. To apply power to the jacket water heater simply apply power to the jacket water heater receptacle via commercial power using an power cord of adequate size.

If the generator will be used daily, the battery should normally not require charging. If the generator will be idle (not used) for long periods of time, apply power to the battery charger receptacle via commercial power using an power cord of adequate size.

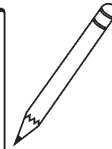
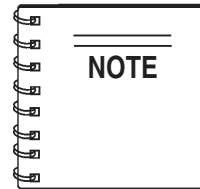

To ensure adequate starting capability, **always** have power applied to the generator's *internal battery charger*.

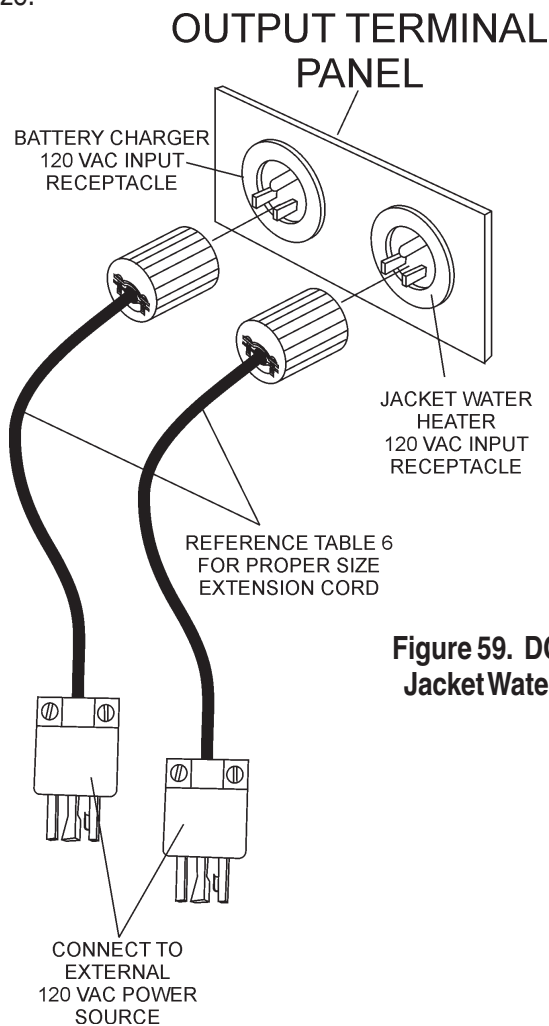

**Figure 59. DCA-220SSJ Battery Charger & Jacket Water Heater Power Connections**

## Trailer Maintenance

This section is intended to provide the user with generic trailer service and maintenance information. The service and maintenance guidelines referenced in this section refer to a wide range of trailers.

Remember periodic inspection of the trailer will ensure safe towing of the generator and will prevent personal injury and damage to the equipment.

The definitions below describe some of the major components of a typical trailer that would be used with the DCA-220SSJ *Whisperwatt™* Generator.

1. **Fuel Cell** - Provides an adequate amount of fuel for the equipment in use. Fuel cells must be empty when transporting equipment.
2. **Braking System** - System employed in stopping the trailer. Typical braking systems are electric, surge, hydraulic, hydraulic-surge and air.
3. **GVWR**- Gross Vehicle Weight Rating (GVWR) is the maximum number of pounds the trailer can carry, including the fuel cell (empty).
4. **Frame Length** - Measurement is from the ball hitch to the rear bumper (reflector).
5. **Frame Width** - Measurement is from fender to fender
6. **Jack Stand** - Trailer support device with maximum pound requirement from the tongue of the trailer.
7. **Coupler** - Type of hitch used on the trailer for towing.
8. **Tire Size** - Indicates the diameter of the tire in inches (10,12,14, etc.), and the width in millimeters (175,185,205, etc.). The tire diameter must match the diameter of the tire rim.
9. **Tire Ply** - The tire ply (layers) number is rated in letters; 2-ply,4-ply,6-ply, etc.
10. **Wheel Hub** - The wheel hub is connected to the trailer's axle.
11. **Tire Rim** - Tires mounted on a tire rim. The tire rim must match the size of the tire.
12. **Lug Nuts** - Used to secure the wheel to the wheel hub. Always use a torque wrench to tighten down the lug nuts. See Table 16 and Figure 59 for lug nut tightening and sequence.
13. **Axle** - Indicates the maximum weight the axle can support in pounds, and the diameter of the axle expressed in inches. Please note that some trailers have a double axle. This will be shown as 2-6000 lbs., meaning two axles with a total weight capacity of 6000 pounds.
14. **Suspension** - Protects the trailer chassis from shocks transmitted through the wheels. Types of suspension used are leaf, Q-flex, and air ride.
15. **Electrical** - Electrical connectors (looms) are provided with the trailer so the brake lights and turn signals can be connected to the towing vehicle.
16. **Application** - Indicates which units can be employed on a particular trailer.

## Brakes

Trailer brakes should be inspected the **first 200 miles** of operation. This will allow the brake shoes and drums to seat properly. After the first 200 mile interval, inspect the brakes **every 3,000 miles**. If driving over rough terrain, inspect the brakes more frequently.

Figure 59 displays the major hydraulic surge brake components that will require inspection and maintenance. Please inspect these components as required using steps 1 through 8 and Table 15 as listed below:

### Brake Adjustment

1. Place the trailer on jack stands. Make sure the jack stands are placed on secure level ground.
2. Check the wheel and drum for free rotation.
3. Remove the adjusting hole cover from the adjusting slot at the bottom brake backing plate.
4. With a screwdriver or standard adjusting tool, rotate the star wheel of the adjuster assembly to expand the brake shoes.
5. Adjust the brake shoes outward until the pressure of the lining against the wheel drum makes the wheel difficult to turn.
6. Adjust, rotate the star wheel in the opposite direction until the wheel rotates freely with slight lining drag.
7. Replace the adjusting hole cover and lower the trailer to the ground.
8. Repeat steps 1 through 7 on the remaining brakes.

## Hydraulic Surge Brakes

Hydraulic surge brakes (Figure 60) should not require any special attention with the exception of routine maintenance such as shoe and lining replacement. Brake lines should be periodically checked for cracks, kinks, or blockage.

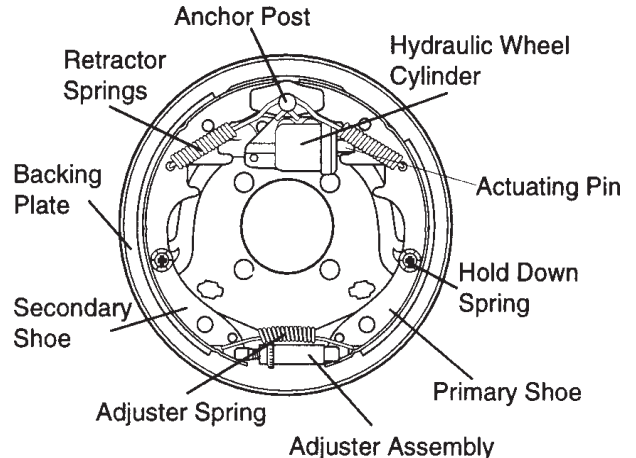

**Figure 60. Hydraulic Brake Components**

### Actuator

Hydraulic surge braking requires the installation of an actuator at the tongue of the trailer. Remember the **surge** or **push** of the trailer toward the tow vehicle automatically synchronizes the trailer brakes with the tow vehicle brakes. As the trailer pushes against the tow vehicle the actuator telescopes together and applies force to the master cylinder, supplying hydraulic pressure to the trailer brakes.

Periodically check and test the surge “**actuator**” to make sure that it is functioning correctly. Never use an undersize actuator.

**Table 15. Hydraulic Brake Troubleshooting**

Symptom	Possible Cause	Solution
No Brakes	Brake line broken or kinked?	Repair or replace.
Weak Brakes or Brakes Pull to One Side	Brake lining glazed?	Reburnish or replace.
	Trailer overloaded?	Correct weight.
	Brake drums scored or grooved?	Machine or replace.
	Tire pressure correct?	Inflate all tires equally.
	Tires unmatched on the same axle?	Match tires.
Locking Brakes	Brake components loose, bent or broken?	Replace components.
	Brake drums out-of-round?	Replace.
Noisy Brakes	System lubricated?	Lubricate.
	Brake components correct?	Replace and correct.
Dragging Brakes	Brake lining thickness incorrect or not adjusted correctly?	Install new shoes and linings.
	Enough brake fluid or correct fluid?	Replace rubber parts fill with dot 4 fluid.

# DCA-220SSJ — MAINTENANCE (TRAILER)

## Tires/Wheels/Lug Nuts

Tires and wheels are a very important and critical components of the trailer. When specifying or replacing the trailer wheels it is important the wheels, tires, and axle are properly matched.

### CAUTION - EYESIGHT HAZARD

**ALWAYS** wear safety glasses when removing or installing force fitted parts. Failure to comply may result in serious injury.



### CAUTION - REPAIRING TRAILER WHEELS

**DO NOT** attempt to repair or modify a wheel. **DO NOT** install in inner tube to correct a leak through the rim. If the rim is cracked, the air pressure in the inner tube may cause pieces of the rim to explode (break off) with great force and cause serious eye or bodily injury.



## Tire Wear/Inflation

Tire inflation pressure is the most important factor in tire life. Pressure should be checked cold before operation **DO NOT** bleed air from tires when they are **hot!** Check inflation pressure weekly during use to insure the maximum tire life and tread wear.

Table 16 (Tire Wear Troubleshooting) will help pinpoint the causes and solutions of tire wear problems.

**TABLE 16. TIRE WEAR TROUBLESHOOTING**

WEAR PATTERN	CAUSE	SOLUTION
Center Wear	Over Inflation.	Adjust pressure to particular load per tire manufacturer.
Edge Wear	Under Inflation.	Adjust pressure to particular load per tire manufacturer.
Side Wear	Loss of camber or overloading.	Make sure load does not exceed axle rating. Align wheels.
Toe Wear	Incorrect toe-in.	Align wheels.
Cupping	Out-of-balance.	Check bearing adjustment and balance tires.
Flat Spots	Wheel lockup & tire skidding.	Avoid sudden stops when possible and adjust brakes.

## Suspension

The **leaf suspension** springs and associated components (Figure 61) should be visually inspected every 6,000 miles for signs of excessive wear, elongation of bolt holes, and loosening of fasteners. Replace all damaged parts (suspension) immediately. Torqued suspension components as detailed in Table 17.

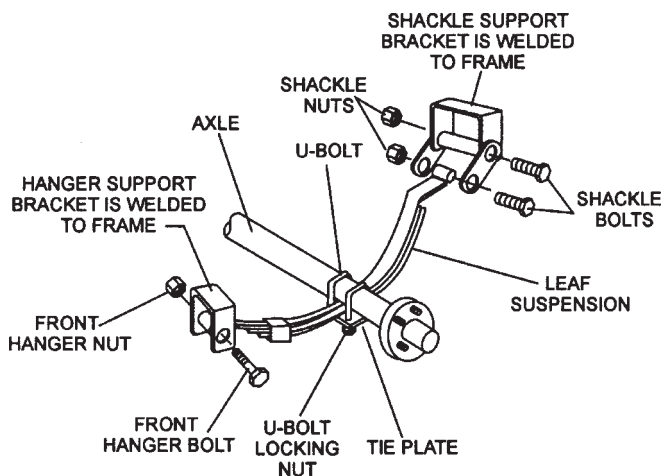

**Figure 61. Major Suspension Components**

**Table 17. Suspension Torque Requirements**

Item	Torque (Ft.-Lbs.)
3/8" U-BOLT	MIN-30 MAX-35
7/16" U-BOLT	MIN-45 MAX-60
1/2" U-BOLT	MIN-45 MAX-60
SHACKLE BOLT SPRING EYE BOLT	SNUG FIT ONLY. PARTS MUST ROTATE FREELY. LOCKING NUTS OR COTTER PINS ARE PROVIDED TO RETAIN NUT-BOLT ASSEMBLY.
SHOULDER TYPE SHACKLE BOLT	MIN-30 MAX-50

## Lug Nut Torque Requirements

It is extremely important to apply and maintain proper wheel mounting torque on the trailer. Be sure to use only the fasteners matched to the cone angle of the wheel. Proper procedure for attachment of the wheels is as follows:

1. Start all wheel lug nuts by hand.
2. Torque all lug nuts in sequence (see Figure 62). **DO NOT** torque the wheel lug nuts all the way down. Tighten each lug nut in 3 separate passes as defined by Table 18.
3. After first road use, retorque all lug nuts in sequence. Check all wheel lug nuts periodically.

Table 18. Tire Torque Requirements

Wheel Size	First Pass FT-LBS	Second Pass FT-LBS	Third Pass FT-LBS
12"	20-25	35-40	50-65
13"	20-25	35-40	50-65
14"	20-25	50-60	90-120
15"	20-25	50-60	90-120
16"	20-25	50-60	90-120

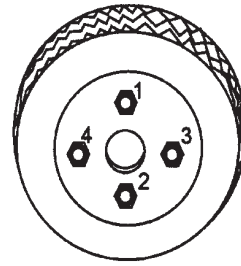

4-LUG NUTS

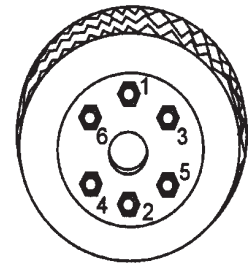

6-LUG NUTS

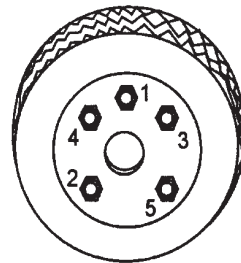

5-LUG NUTS

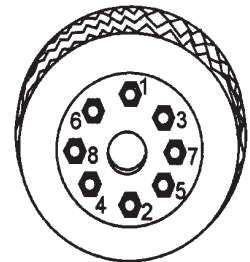

8-LUG NUTS

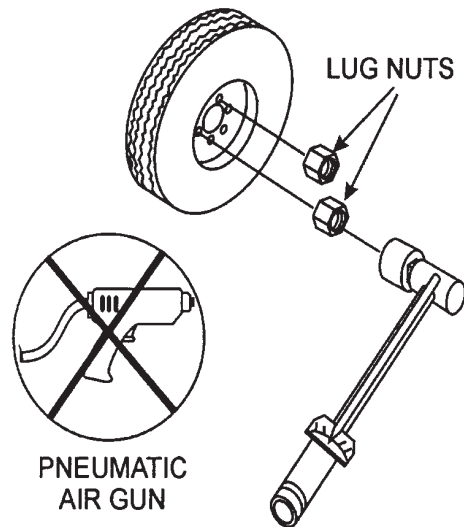

PNEUMATIC  
AIR GUN

TORQUE WRENCH

Figure 62. Wheel Lug Nuts  
Tightening Sequence

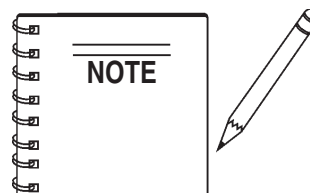

**NEVER** use an pneumatic air gun to tighten wheel lug nuts.

# DCA-220SSJ — TRAILER WIRING DIAGRAM

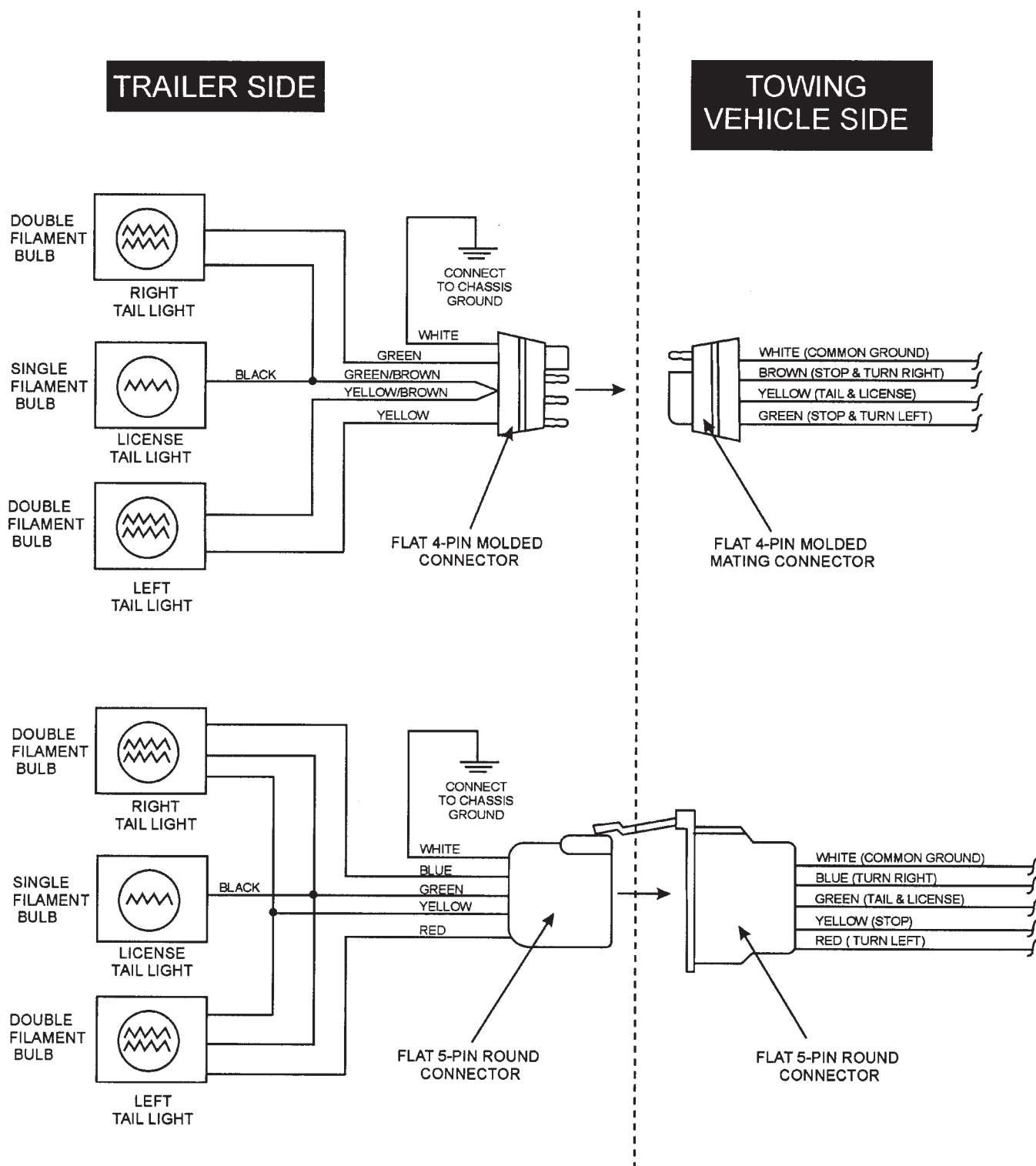

Figure 63. Trailer/Towing Vehicle Wiring Diagram



# DCA-220SSJ — GENERATOR WIRING DIAGRAM

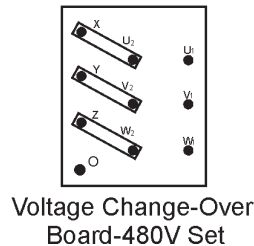
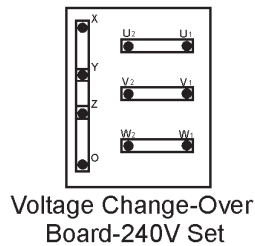
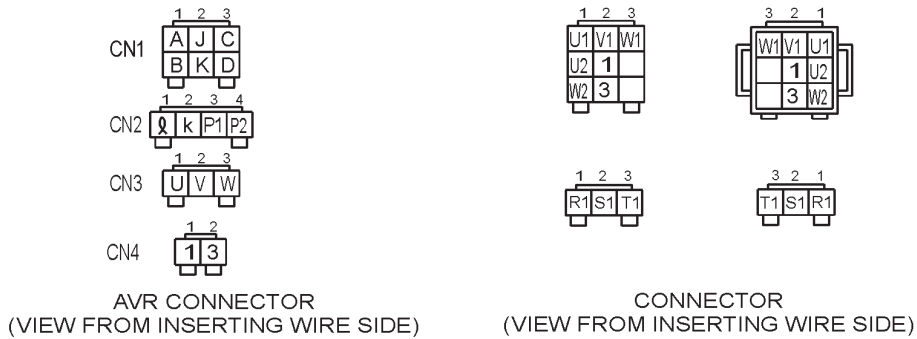
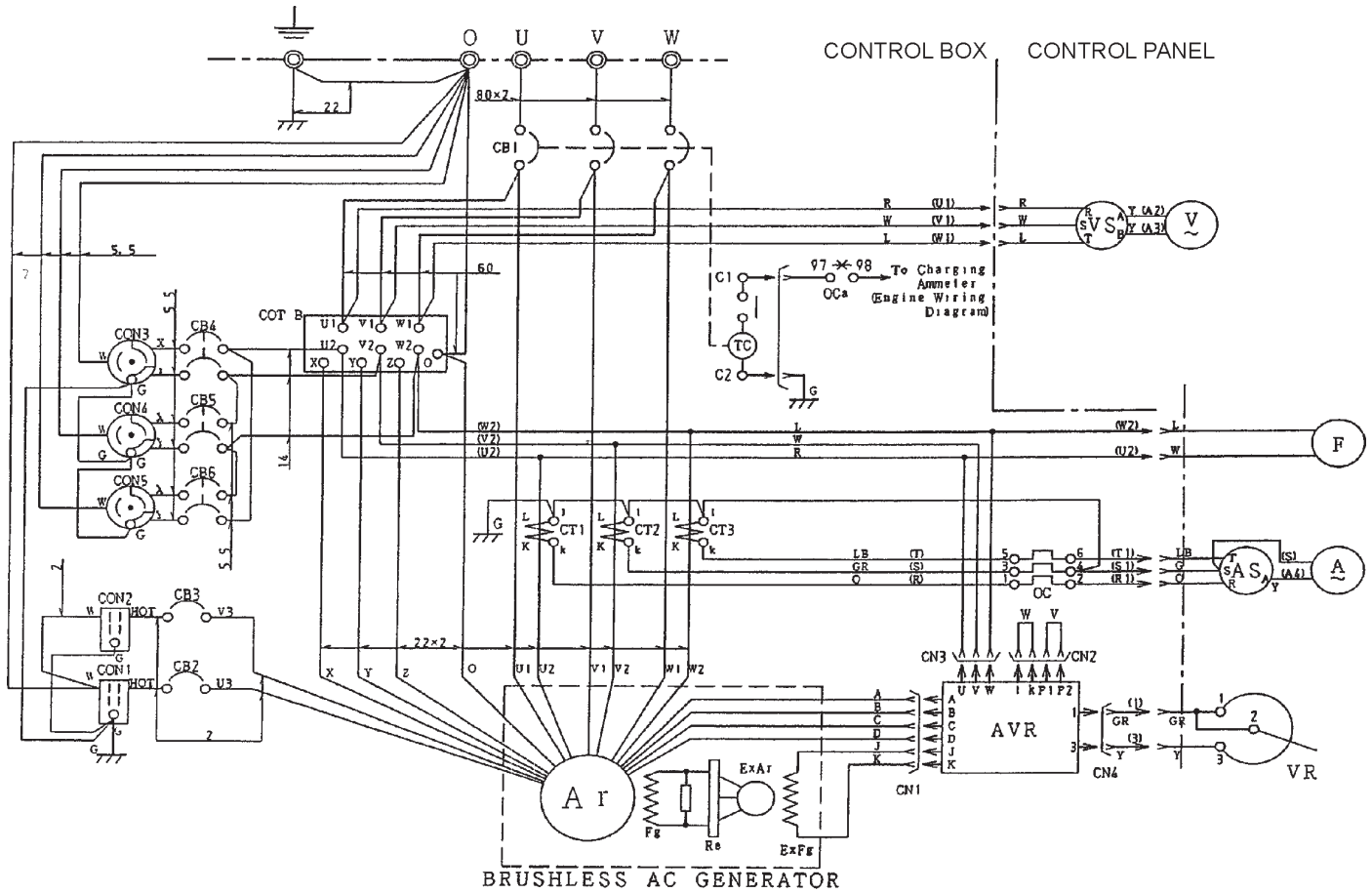
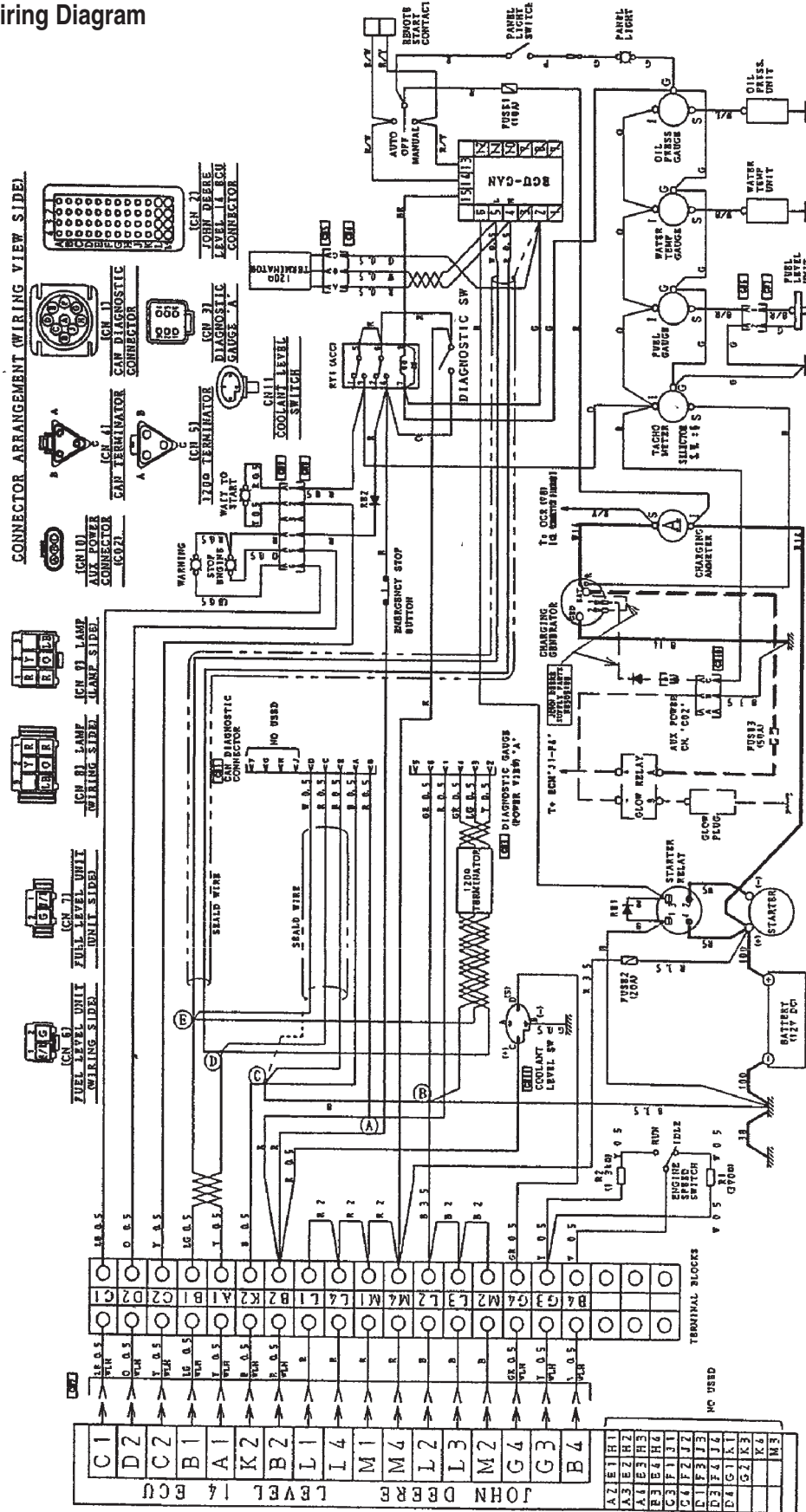

Figure 64. Generator Wiring Diagram

# DCA-220SSJ — ENGINE WIRING DIAGRAM

Figure 65. Engine Wiring Diagram



## DCA-220SSJ — TROUBLESHOOTING (GENERATOR)

Practically all breakdowns can be prevented by proper handling and maintenance inspections, but in the event of a breakdown, use Table 19 shown below for diagnosis of the Generator. If the problem cannot be remedied, consult our company's business office or service plant.

**TABLE 19. GENERATOR TROUBLESHOOTING**

SYMPTOM	POSSIBLE PROBLEM	SOLUTION
No Voltage Output	AC Voltmeter defective?	Check output voltage using a voltmeter.
	Is wiring connection loose?	Check wiring and repair.
	Is AVR defective?	Replace if necessary.
	Defective Rotating Rectifier?	Check and replace.
	Defective Exciter Field?	Check for 17.3 ohms across J & K on CN1
Low Voltage Output	Is engine speed correct?	Turn engine throttle lever to "High".
	Is wiring connections loose?	Check wiring and repair.
	Defective AVR?	Replace if necessary.
High Voltage Output	Is wiring connections loose?	Check wiring and repair.
	Defective AVR?	Replace if necessary.
Circuit Breaker Tripped	Short Circuit in load?	Check load and repair.
	Over current?	Confirm load requirements and reduce.
	Defective circuit breaker?	Check and replace.
	Over current Relay actuated?	Confirm load requirement and replace.

## DCA-220SSJ — TROUBLESHOOTING (ENGINE CONTROLLER)

Practically all breakdowns can be prevented by proper handling and maintenance inspections, but in the event of a breakdown, use Table 20 (Engine Controller Troubleshooting) as a basic guideline for troubleshooting the Microprocessor Engine Controller unit (MPEC). If the problem cannot be remedied, consult our company's business office or service plant.

**TABLE 20. ENGINE CONTROLLER TROUBLESHOOTING (MPEC)**

SYMPTOM	POSSIBLE PROBLEM	SOLUTION
Low oil pressure light is on.	Low oil level?	Fill oil level.
	Oil pressure sending unit failure?	Replace oil pressure sending unit.
	Time delay malfunction in Controller?	Refer to dealer.
	Wire shorted?	Inspect/repair wire.
Low coolant level light is on. (Optionally Installed)	Low coolant level?	Fill coolant level.
	Sending unit failure?	Replace sending unit.
	Low battery voltage?	Replace/charge battery.
High coolant temperature light is on.	Fan belt tension incorrect?	Tighten/replace fan belt.
	Air flow is not circulation through radiator?	Clean/repair radiator grill.
	Doors open?	Close doors.
	Exhaust leaking?	Replace/repair gaskets or faulty part.
	Generator being overloaded?	Check/reduce load.
	Thermostat failure?	Replace thermostat.
	Air intake blocked?	Clear all air intakes.
	Temperature switch failure?	Replace temperature switch.
Overcrank light is on.	No or low Fuel?	Fill fuel level.
	Controller needs to be calibrated?	Refer to dealer.
Overspeed light is on.	RPM engine speed too high?	Adjust RPM.
	Governor actuator needs to be adjusted?	Adjust governor actuator.
	Governor controller needs to be adjusted?	Adjust governor controller.
	Engine Controller needs to be calibrated?	Refer to dealer.
Loss of MPU light(s) or on.	Magnetic pick up out of adjustment?	Adjust magnetic pick up.
	Magnetic pick up dirty?	Clean magnetic pick up.



# DCA-220SSJ — EXPLANATION OF CODE IN REMARKS COLUMN

The following section explains the different symbols and remarks used in the Parts section of this manual. Use the help numbers found on the back page of the manual if there are any questions.

The contents and part numbers listed in the parts section are subject to change **without notice**. Multiquip does not guarantee the availability of the parts listed.

Sample Parts List:

NO.	PART NO.	PART NAME	QTY.	REMARKS
1	12345	BOLT .....	1 ....	INCLUDES ITEMS W/*
2*		WASHER, 1/4 IN. ....		NOT SOLD SEPARATELY
2*	12347	WASHER, 3/8 IN. ....	1 ....	MQ-45T ONLY
3	12348	HOSE .....	A/R ..	MAKE LOCALLY
4	12349	BEARING .....	1 ....	S/N 2345B AND ABOVE

## NO. Column

**Unique Symbols** - All items with same unique symbol (\*, #, +, %, or >) in the number column belong to the same assembly or kit, which is indicated by a note in the "Remarks" column.

**Duplicate Item Numbers** - Duplicate numbers indicate multiple part numbers are in effect for the same general item, such as different size saw blade guards in use or a part that has been updated on newer versions of the same machine.

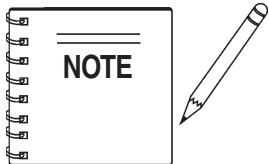

When ordering a part that has more than one item number listed, check the remarks column for help in determining the proper part to order.

## PART NO. Column

**Numbers Used** - Part numbers can be indicated by a number, a blank entry, or TBD.

TBD (To Be Determined) is generally used to show a part that has not been assigned a formal part number at time of publication.

A blank entry generally indicates that the item is not sold separately or is not sold by Multiquip. Other entries will be clarified in the "Remarks" Column.

## QTY. Column

**Numbers Used** - Item quantity can be indicated by a number, a blank entry, or A/R.

A/R (As Required) is generally used for hoses or other parts that are sold in bulk and cut to length.

A blank entry generally indicates that the item is not sold separately. Other entries will be clarified in the "Remarks" Column.

## REMARKS Column

Some of the most common notes found in the "Remarks" Column are listed below. Other additional notes needed to describe the item can also be shown.

**Assembly/Kit** - All items on the parts list with the same unique symbol will be included when this item is purchased.

Indicated by:

"INCLUDES ITEMS W/(unique symbol)"

**Serial Number Break** - Used to list an effective serial number range where a particular part is used.

Indicated by:

"S/N XXXXX AND BELOW"

"S/N XXXX AND ABOVE"

"S/N XXXX TO S/N XXX"

**Specific Model Number Use** - Indicates that the part is used only with the specific model number or model number variant listed. It can also be used to show a part is NOT used on a specific model or model number variant.

Indicated by:

"XXXXX ONLY"

"NOT USED ON XXXX"

**"Make/Obtain Locally"** - Indicates that the part can be purchased at any hardware shop or made out of available items. Examples include battery cables, shims, and certain washers and nuts.

**"Not Sold Separately"** - Indicates that an item cannot be purchased as a separate item and is either part of an assembly/kit that can be purchased, or is not available for sale through Multiquip.



## DCA-220SSJ WHISPER WATT GENERATOR W/JOHN DEERE 6068HF485 TURBO DIESEL ENGINE 1 TO 3 UNITS

<u>Qty.</u>	<u>P/N</u>	<u>Description</u>
1 .....	M4310500803 .....	HOSE, RADIATOR UPPER
1 .....	M4310500903 .....	HOSE, RADIATOR LOWER
1 .....	060202011062 .....	RADIATOR CAP
1 .....	0845500104 .....	FUEL CAP
1 .....	0602015230 .....	V-BELT SET, FAN
1 .....	0602122272 .....	UNIT, OIL PRESSURE
1 .....	0602122281 .....	SWITCH, OIL PRESSURE
1 .....	0602123282 .....	TEMP SENSOR UNIT
1 .....	0602123261 .....	SWITCH, TEMPERATURE SENSOR
3 .....	0810105400 .....	FILTER, FUEL, FUEL TANK
6 .....	0602042596 .....	FILTER, FUEL PRIMARY
6 .....	0602042597 .....	FILTER, FUEL FINAL
6 .....	0602041292 .....	FILTER, OIL CARTRIDGE
3 .....	0602046617 .....	ELEMENT AIR OUTER
3 .....	0602046618 .....	ELEMENT AIR INNER
1 .....	0601808803 .....	CIRCUIT BREAKER 1P 20A
1 .....	0601808804 .....	CIRCUIT BREAKER 2P 50A
2 .....	LY2DUS12VDC ...	RELAY

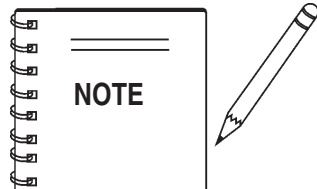

Part number on this Suggested Spare Parts list may supercede/replace the P/N shown in the text pages of this book.

# DCA-220SSJ — GENERATOR ASSY.

## GENERATOR ASSY.

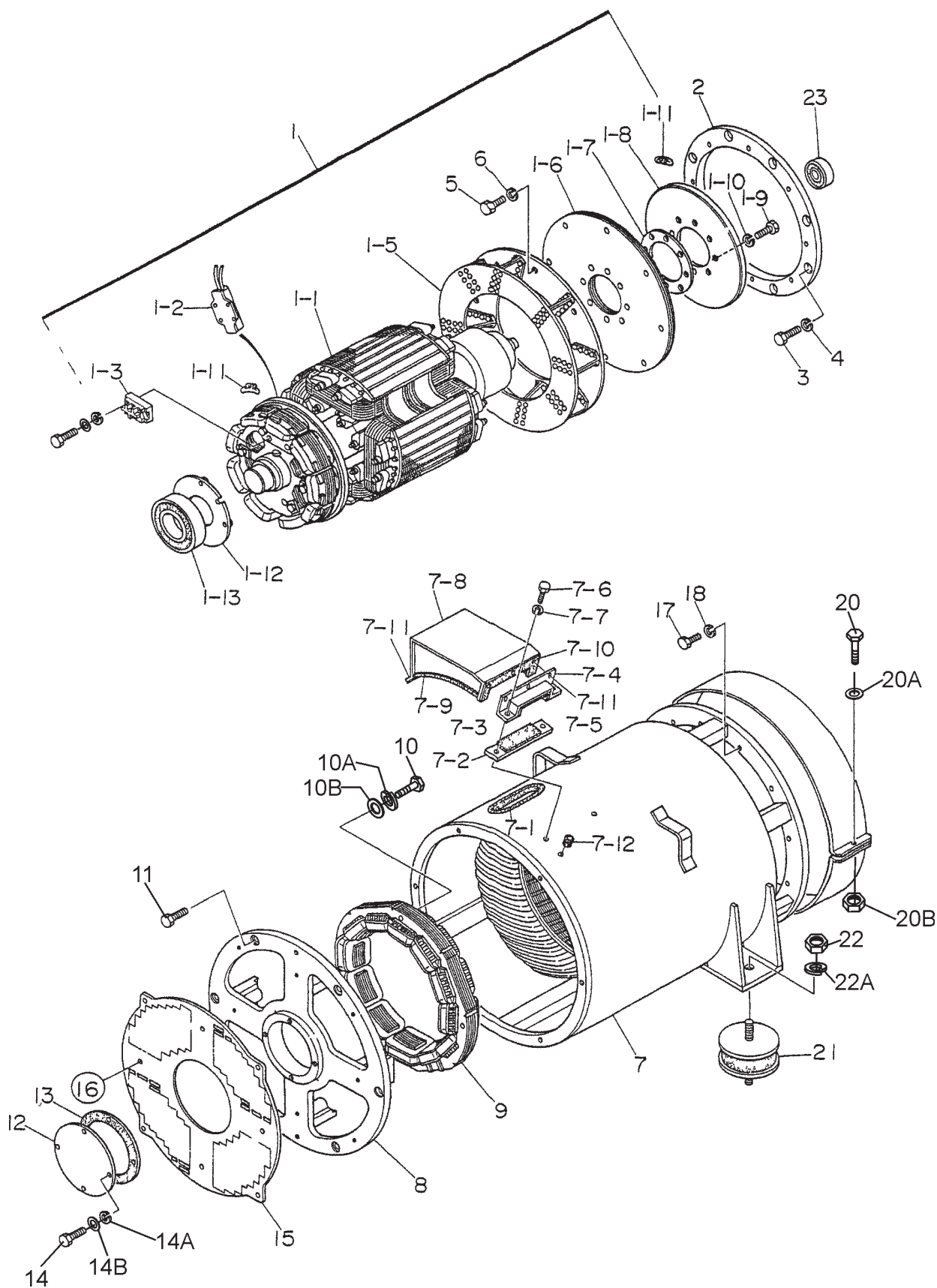

# DCA-220SSJ — GENERATOR ASSY.

## GENERATOR ASSY.

<u>NO.</u>	<u>PART NO.</u>	<u>PART NAME</u>	<u>QTY.</u>	<u>REMARKS</u>
1	C1110000002	ROTOR ASSEMBLY .....	1.....	INCLUDES ITEMS W/*
1-1*		FIELD ASSEMBLY	1	
1-2*	0601842334	RESISTOR, 80W 100K OHM	1	
1-3*	0601823282	RECTIFIER, RM50TC- 24	1	
1-4*	0018205020	HEX. SOCKET HEAD CAP SCREW	2	
1-4A	0040005000	SPRING WASHER	2	
1-4B	0041205000	PLAIN WASHER	2	
1-5	8171070002	FAN	1	
1-6	8171611003	COUPLING DISK	9	
1-7	C1164200004	WASHER, COUPLING HUB	1	
1-8	8171015003	BALANCING PLATE .....	1.....	PURCHASE ITEM 1-11 AS A SET
1-9	0012116045	HEX. HEAD BOLT	8	
1-10	0042616000	SPRING WASHER	8	
1-11	0601000209	BALANCING WEIGHT KIT	1	
1-12	C1112500004	BEARING FLANGE	1	
1-13	0071906314	BEARING, 6314DDU C3	1	
2	M4163400003	COUPLING RING	1	
3	0343206120	HEX. HEAD BOLT	8	
4	0043606000	SPRING WSHER	8	
5	0012112040	HEX. HEAD BOLT	8	
6	0042512000	SPRING WASHER	8	
7	C1130100103	STATOR ASSEMBLY .....	1.....	INCLUDES ITEMS W/#
7-1#	0226100420	RUBBER SEAL	1	
7-2#	8171323004	CLAMPER	1	
7-3#	0223300120	RUBBER SEAL	1	
7-4#	8171323103	CLAMPER	1	
7-5#	0221200300	RUBBER SEAL	1	
7-6#	0010110035	HEX. HEAD BOLT	2	
7-7#	0041210000	PLAIN WASHER	2	
7-8#	C1132200003	COVER	1	
7-9#	0226000510	RUBBER SEAL	1	
7-10#	0225000470	RUBBER SEAL	1	
7-11#	0017106016	HEX. HEAD BOLT	6	
7-12#	0601850144	GROMMET	1	
8	C1154999992	END BRACKET	1	
9	C1138000003	FIELD ASSEMBLY, EXCITER	1	

# DCA-220SSJ — GENERATOR ASSY. (CONT.)

## GENERATOR ASSY.

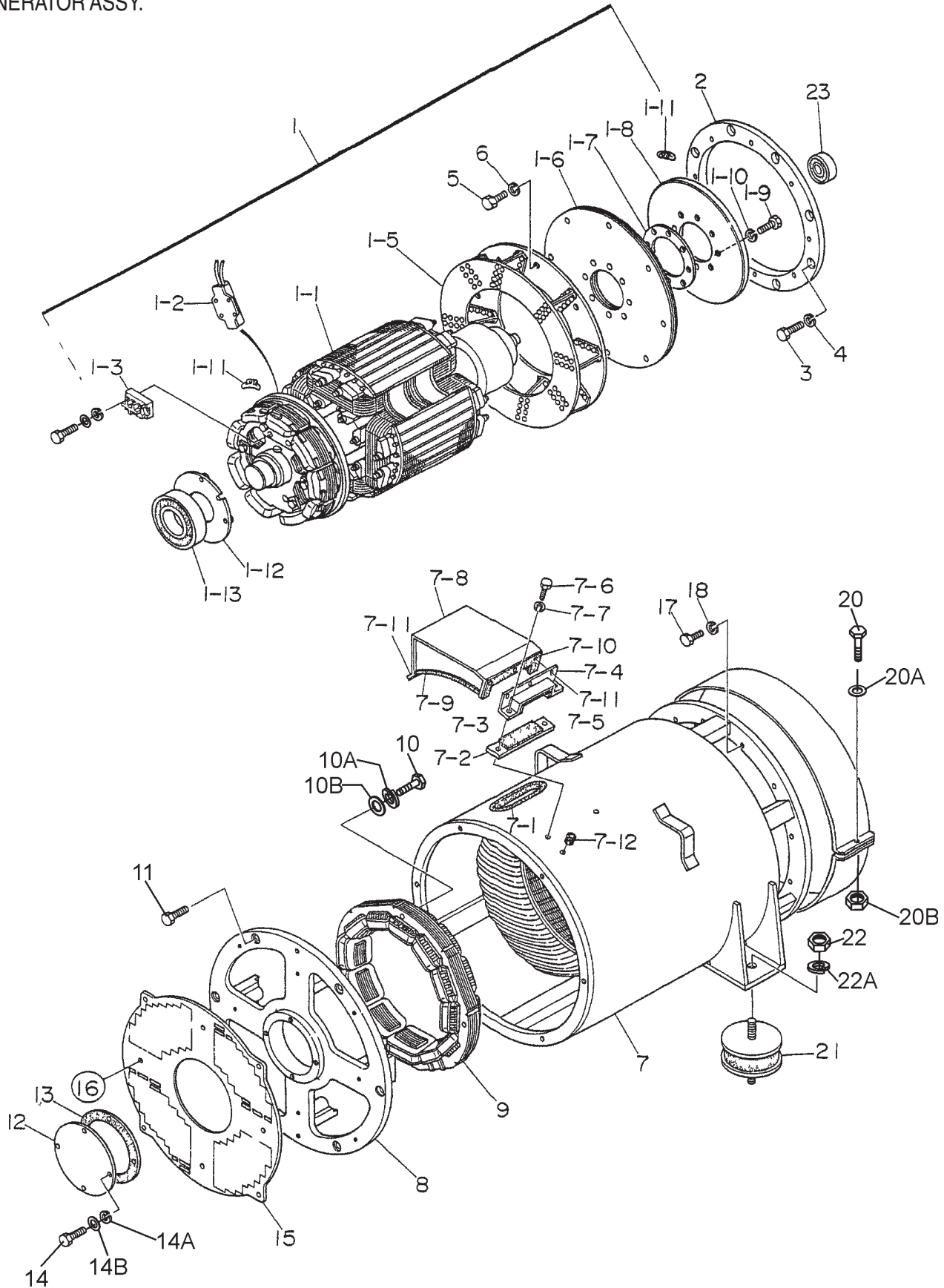

## DCA-220SSJ — GENERATOR ASSY. (CONT.)

### GENERATOR ASSY. (CONT.)

<u>NO.</u>	<u>PART NO.</u>	<u>PART NAME</u>	<u>QTY.</u>	<u>REMARKS</u>
10	0012110065	HEX. HEAD BOLT	4	
10A	0042610000	SPRING WASHER	4	
10B	0041210000	PLAIN WASHER	4	
11	0017112045	HEX. HEAD BOLT	6	
12	C1154400004	COVER, BEARING	1	
13	C1154300004	GASKET, BEARING	1	
14	0010106060	HEX. HEAD BOLT	4	
14A	0040006000	SPRING WASHER	4	
14B	0041206000	PLAIN WASHER	4	
15	C1154400103	SUCTION COVER	1	
16	0017106016	HEX. HEAD BOLT	8	
17	0343205150	HEX. HEAD BOLT	12	
18	0043605000	SPRING WASHER	12	
19	C1132300114	COVER, FAN	1	
20	0010106030	HEX. HEAD BOLT	1	
20A	0041206000	PLAIN WASHER	1	
20B	0600815000	NUT	1	
21	0605000012	RUBBER SUSPENSION	2	
22	0030020000	HEX. NUT	4	
22A	0040020000	SPRING WASHER	4	
23	0070506907	BEARING, 6907ZZ	1	

# DCA-220SSJ— CONTROL PANEL ASSY.

## CONTROL PANEL ASSY.

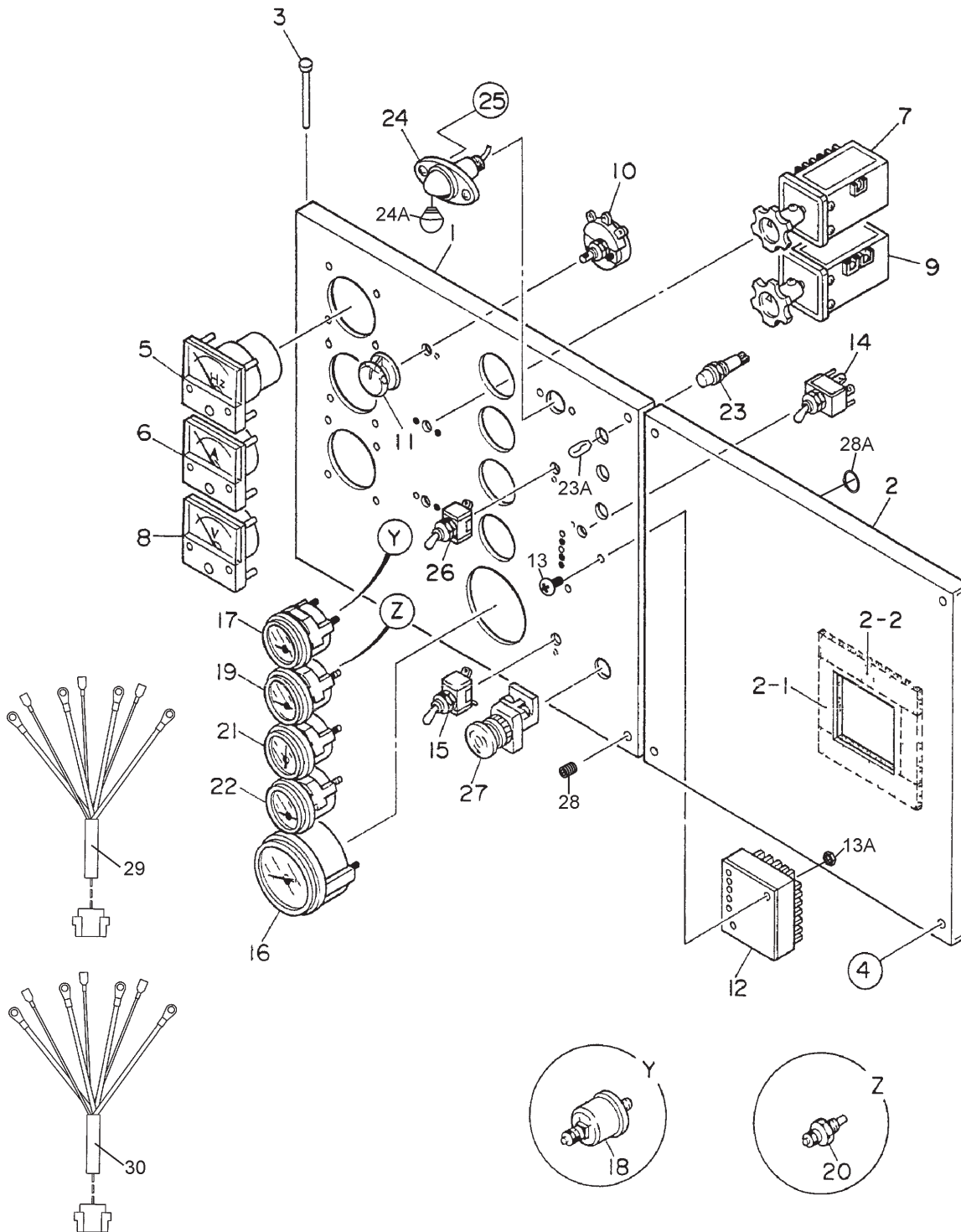



# DCA-220SSJ— CONTROL PANEL ASSY.

## CONTROL PANEL ASSY.

<u>NO.</u>	<u>PART NO.</u>	<u>PART NAME</u>	<u>QTY.</u>	<u>REMARKS</u>
1	M4223000303	CONTROL PANEL	1	
2	M4223000404	CONTROL PANEL	1	
2-1	0222100100	RUBBER SEAL	2	
2-2	0222100165	RUBBER SEAL	2	
3	0605011211	PIN	2	
4	0016908035	HEX. HEAD BOLT	4	
5	0601807642	FREQUENCY METER, 45 ~65HZ 240V	1	
6	0601808992	AC AMMETER, 0~400A 0~800A	1	
7	0601801040	CHANGE- OVER SWITCH, AMMETER	1	
8	0601800275	AC VOLTMETER, 0~600V	1	
9	0601801041	CHANGE- OVER SWITCH, VOLTMETER	1	
10	0601840073	RHEOSTAT (VR), 2W 1K OHM	1	
11	0601840121	KNOB	1	
12	0602202593	CONTROLLER, ECU	1	
13	0027104035	MACHINE SCREW	2	
13A	0207004000	HEX. NUT	2	
14	0601831340	SWITCH	1	
15	0601831395	ENGINE SPEED SWITCH	1	
16	0602120096	TACHOMETER	1	
17	0602122098	OIL PRESSURE GAUGE	1	
18	0602122272	OIL PRESSURE UNIT	1	
19	0602123092	WATER TEMPERATURE GAUGE	1	
20	0602123263	WATER TEMPERATURE UNIT	1	
21	0602121081	CHARGING AMMETER	1	
22	0602125090	FUEL GAUGE	1	
23	0602103092	ALARM LAMP	3	
23A	0601810245	BULB, DC 18V	3	
24	0601810160	PANEL LIGHT, DC 12V	1	
24A	0601810213	BULB	1	
25	0207004000	HEX NUT	2	
26	0601831330	PANEL LIGHT SWITCH	1	
27	0601831557	EMERGENCY STOP BUTTON	1	
28	M9220100004	SET SCREW	2	
28A	0080200007	SNAP RING	2	
29	M4246700304	WIRE HARNESS, GENERATOR	1	
30	M4357200102	WIRE HARNESS, ENGINE		

# DCA-220SSJ— CONTROL BOX ASSY.

CONTROL BOX ASSY.

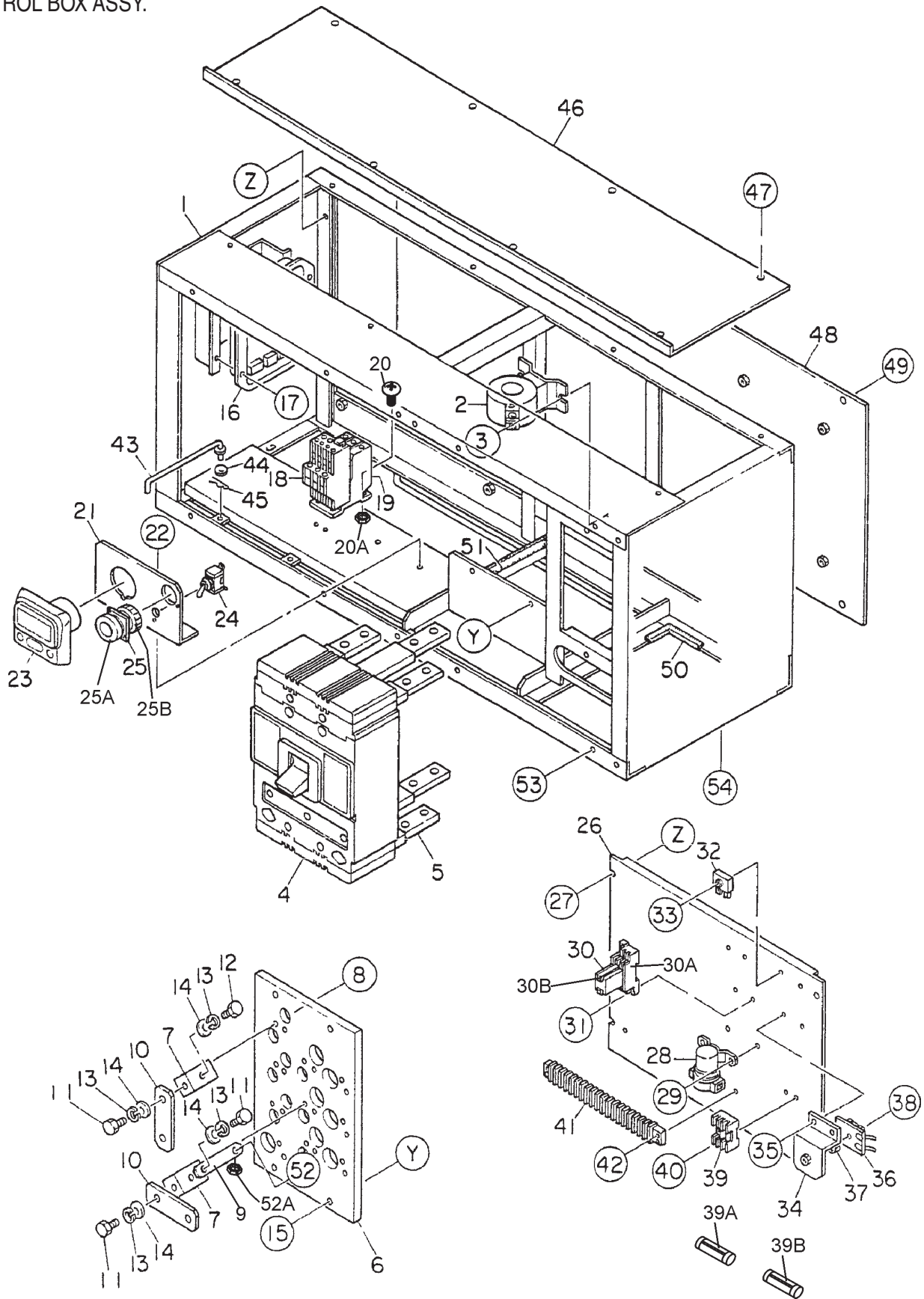

# DCA-220SSJ— CONTROL BOX ASSY.

## CONTROL BOX ASSY.

<u>NO.</u>	<u>PART NO.</u>	<u>PART NAME</u>	<u>QTY.</u>	<u>REMARKS</u>
1	M4213000102	CONTROL BOX	1	
2	0601809667	CURRENT TRANSFORMER, 400/5A	3	
3	0027106016	MACHINE SCREW	6	
4	0601870422	CIRCUIT BREAKER, 600A	1	
5	0601815168	REAR CONNECTOR KIT	1	
6	M4273000003	TERMINAL BOARD, VOLTAGE CHANGE- OVER	1	
7	M4276400004	CHANGE TERMINAL	10	
8	0017106025	HEX. HEAD BOLT	20	
9	M4276200004	TERMINAL PLATE	3	
10	M4276300004	CHANGE- OVER PLATE	6	
11	M4276100004	TIE BOLT	13	
12	M9220100104	TIE BOLT	13	
13	0040010000	WASHER, LOCK	26	
14	0041410000	WASHER, FLAT	26	
15	0016908030	HEX. HEAD BOLT	4	
16	0601820625	AUTOMATIC VOLTAGE REGULATOR	1	
17	0027105016	MACHINE SCREW	4	
18	0601820847	OVER CURRENT RELAY	1	
19	0601820848	OVER CURRENT RELAY	1	
20	0027104016	MACHINE SCREW	2	
20A	0207004000	HEX. NUT	2	
21	M4260600304	BRACKET, DIAGNOSTIC GAUGE	1	
22	0016908020	HEX. HEAD BOLT	2	
23	0602120690	POWER VIEW	1	
24	0601831330	DIAGNOSTIC SWITCH	1	
25	0601813977	RECEPTACLE	1	
25A	0601812891	DUST CAP	1	
25B	0601812890	STRAIN RELIEF	1	
26	M4270500003	SET PANEL, ELECTRIC PARTS	1	
27	0016908020	HEX HEAD BOLT	4	
28	0602202592	STARTER RELAY	1	
29	0027106016	MACHINE SCREW	2	
30	LY2DUS12VDC	RELAY .....	1	REPLACES P/N 0601827656
30A	PTF08A	BASE .....	1	REPLACES P/N 0601823109
30B	PYCA1	CLIP, .....	2	REPLACES P/N 0601824400
31	0027104020	MACHINE SCREW	2	
32	0601821370	RECTIFIER, DE45 .....	2	REPLACES P/N 0601823240
33	0027104020	MACHINE SCREW	2	
34	M4260600404	BRACKET, RESISTOR UNIT	1	
35	0016906016	HEX HEAD BOLT	2	
36	M4266600004	RESISTOR UNIT	1	
37	020106050	HEX NUT .....	1	REPLACES P/N 0030006000

# DCA-220SSJ— CONTROL BOX ASSY. (CONT)

## CONTROL BOX ASSY. (CONT.)

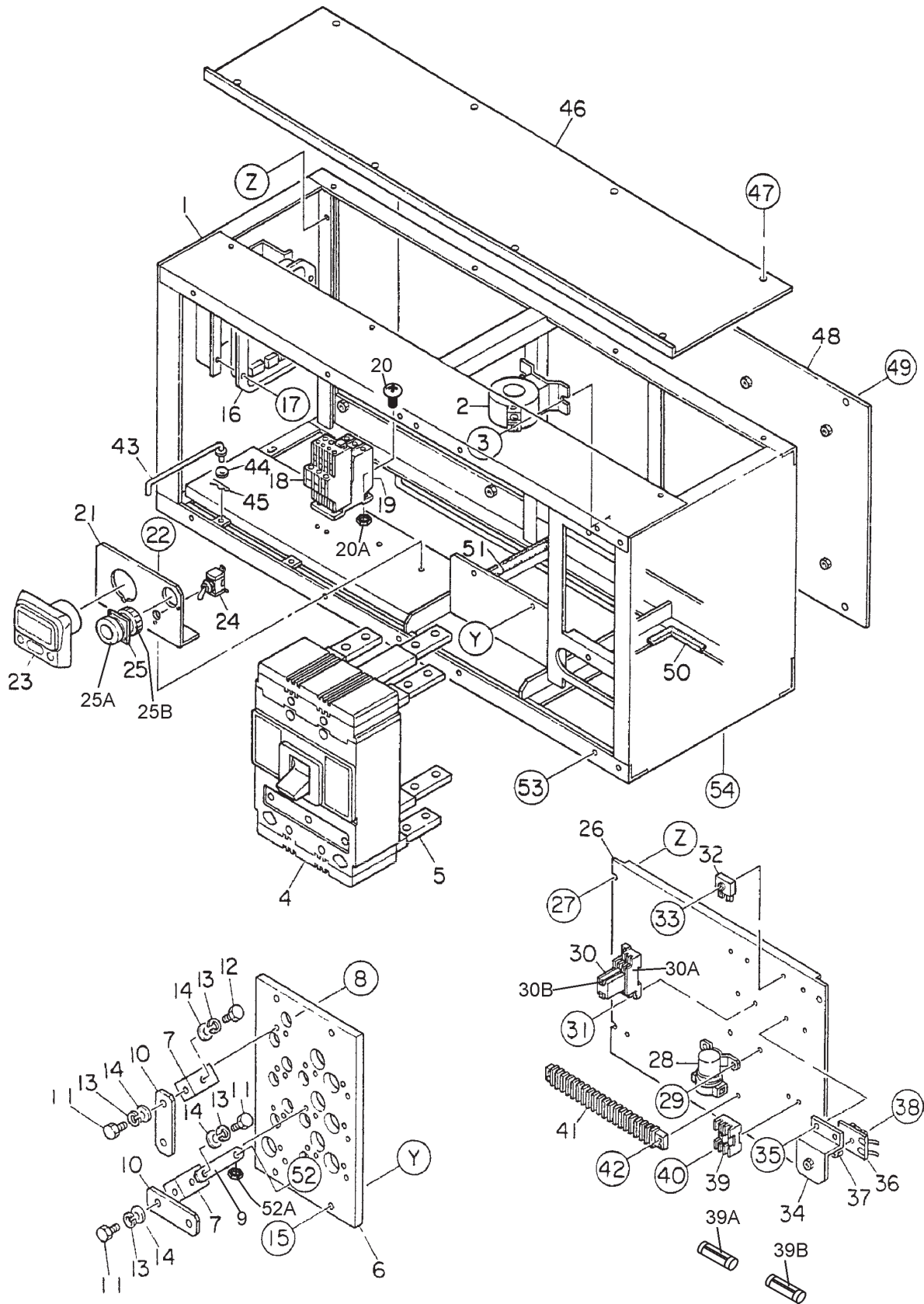

## DCA-220SSJ— CONTROL BOX ASSY. (CONT)

### CONTROL BOX ASSY.

<u>NO.</u>	<u>PART NO.</u>	<u>PART NAME</u>	<u>QTY.</u>	<u>REMARKS</u>
38	0027106020	MACHINE SCREW	1	
39	0601802218	FUSE HOLDER, 3P	1	
39A	0601806653	FUSE (RIGHT SIDE) 20A	1	
39B	0601802149	FUSE ( CENTER) 10A	1	
40	0027103020	MACHINE SCREW	2	
41	0601815154	TERMINAL BLOCK	1	
42	0027104016	MACHINE SCREW	2	
43	3871824004	CONTROL PANEL STOPPER	1	
44	0041206000	WASHER, FLAT	1	
45	0605010502	SNAP PIN	1	
46	M4213500104	CONTROL BOX COVER	1	
47	0016908020	HEX HEAD BOLT	8	
48	M4213400104	CONTROL BOX BACK PANEL	1	
49	0016908020	HEX HEAD BOLT	8	
50	0226900300	EDGING	1	
51	0226900215	EDGING	1	
52	0017110040	HEX HEAD BOLT	3	
52A	0207010000	HEX NUT	3	
53	0016908020	HEX HEAD BOLT	8	
54	0016908020	HEX HEAD BOLT	7	

# DCA-220SSJ— ENGINE AND RADIATOR ASSY.

## ENGINE AND RADIATOR ASSY.

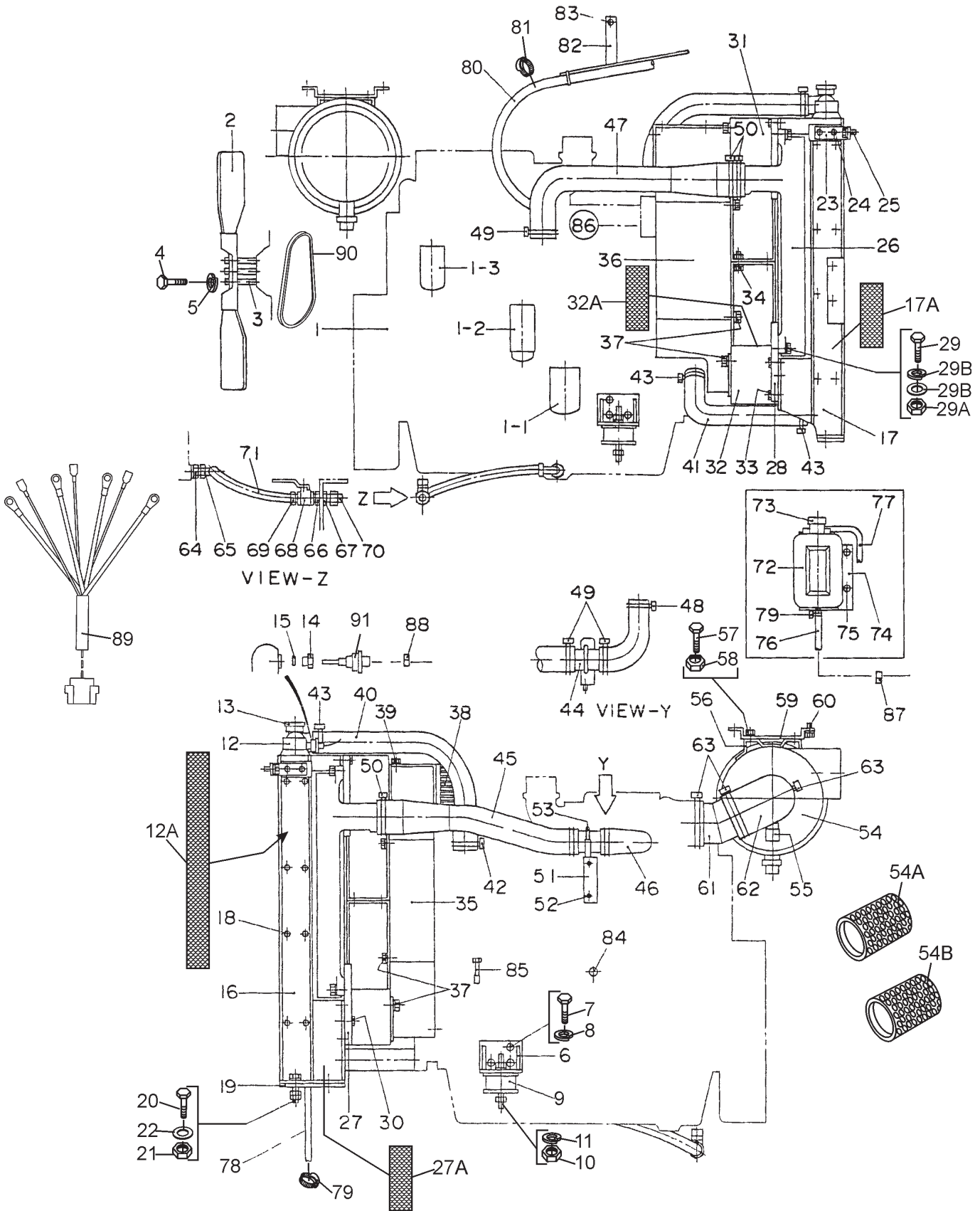



# DCA-220SSJ— ENGINE AND RADIATOR ASSY.

## ENGINE AND RADIATOR ASSY.

<u>NO.</u>	<u>PART NO.</u>	<u>PART NAME</u>	<u>QTY.</u>	<u>REMARKS</u>
1	M4923200034	ENGINE, JOHN DEERE 6068HF485	1	
1-1	0602041292	OIL FILTER CARTRIDGE, OIL FILTER .....	1 .....	RE504836
1-2	0602042596	PRIMARY FUEL FILTER CARTRIDGE .....	1 .....	RE529643
1-3	0602042597	FINAL FUEL FILTER CARTRIDGE .....	1 .....	RE522878
2	0602060015	BLOWER FAN .....	1 .....	4735-42599-02
3	0602061003	FAN SPACER .....	1 .....	R81876
4	0012110110	HEX HEAD BOLT	4	
5	0042510000	WASHER, LOCK	4	
6	M3303200404	ENGINE FOOT	2	
7	0010312030	HEX HEAD BOLT	6	
8	0042512000	WASHER, LOCK	4	
9	0605000011	RUBBER SUSPENSION	2	
10	0030016000	HEX NUT	4	
11	0040016000	WASHER, LOCK	4	
12	M4923200014	RADIATOR	1	
12A	M4493601304	ACOUSTIC SHEET	2	
13	0602011062	CAP	1	
14	M9200101004	ADAPTOR	1	
15	0150000016	O-RING	1	
16	M4310201103	SUPPORT, RADIATOR	1	
17	M4310201203	SUPPORT, RADIATOR	1	
17A	M4493601504	ACOUSTIC SHEET	1	
18	0016908020	HEX HEAD BOLT	16	
19	M4310600304	RUBBER SHEET	2	
20	0010112060	HEX HEAD BOLT	4	
21	0030012000	HEX NUT	8	
22	0041212000	WASHER, FLAT	8	
23	M4310200904	BRACKET, RADIATOR	2	
24	0016910025	HEX HEAD BOLT	4	
25	0016910025	HEX HEAD BOLT	2	
26	M4923200044	INTER COOLER	1	
27	M4310201304	BRACKET, INTER COOLER	1	
27A	M4493601604	ACOUSTIC SHEET	1	
28	M4310201404	BRACKET, INTER COOLER	1	
28A	M4493601604	ACOUSTIC SHEET	1	
29	0010110040	HEX HEAD BOLT	4	
29A	0030010000	HEX NUT	4	
29B	0040010000	WASHER, LOCK	4	
29C	0041210000	WASHER, FLAT	8	
30	0016910025	HEX HEAD BOLT	4	
31	M4310301103	FAN SHROUD	1	

# DCA-220SSJ— ENGINE AND RADIATOR ASSY.

## ENGINE AND RADIATOR ASSY.

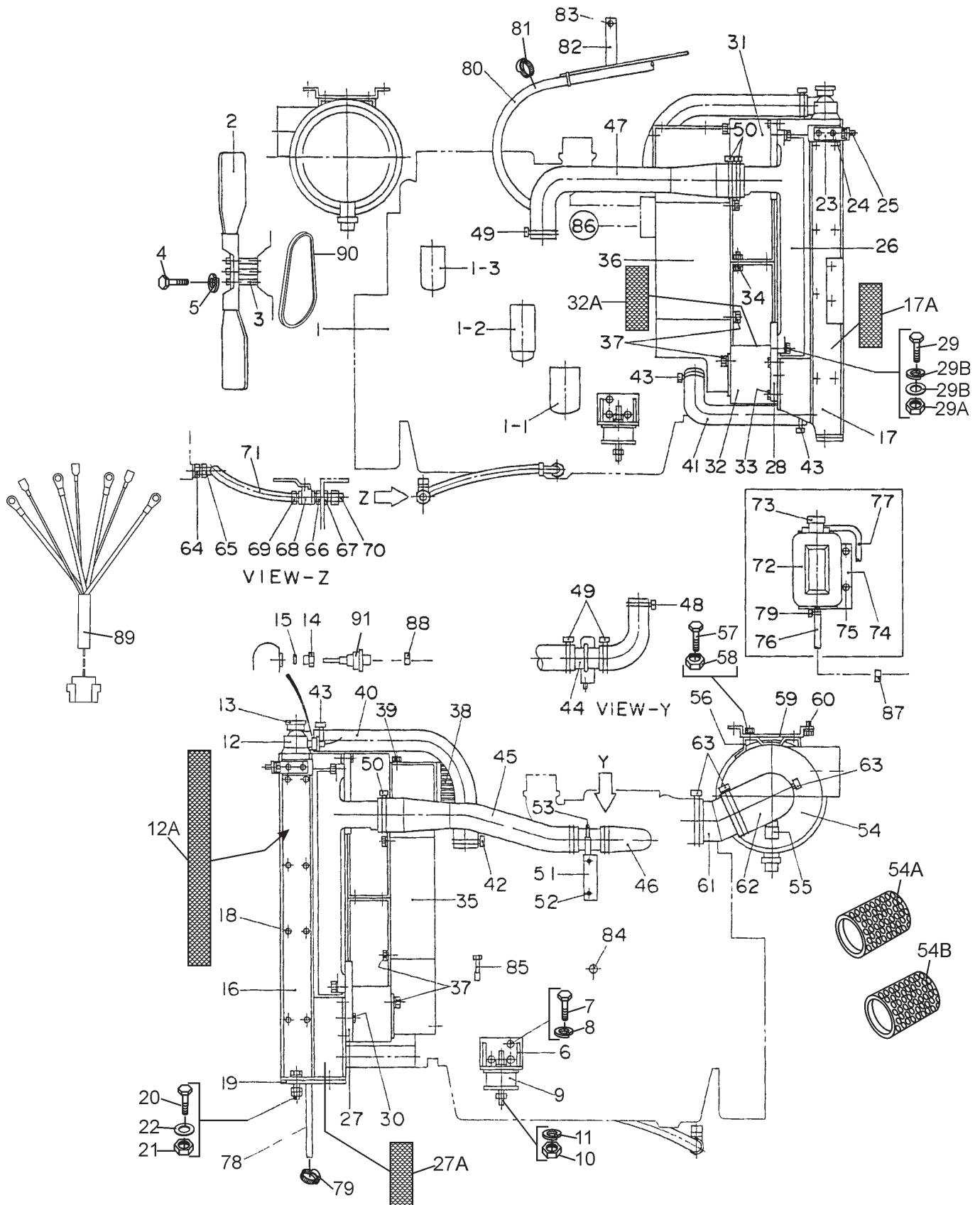

# DCA-220SSJ— ENGINE AND RADIATOR ASSY.

## ENGINE AND RADIATOR ASSY.

<u>NO.</u>	<u>PART NO.</u>	<u>PART NAME</u>	<u>QTY.</u>	<u>REMARKS</u>
32	M4310301203	FAN SHROUD	1	
	M4493601204	ACOUSTIC SHEET	1	
33	0016908020	HEX HEAD BOLT	6	
34	0016908020	HEX HEAD BOLT	4	
35	M4310300903	FAN GUARD	1	
36	M4310301003	FAN GUARD	1	
37	0016908020	HEX HEAD BOLT	11	
38	M4310300403	FAN GUARD	1	
39	0016908020	HEX HEAD BOLT	8	
40	M4310500803	RADIATOR HOSE, UPPER	1	
41	M4310500903	RADIATOR HOSE, LOWER	1	
42	0605515143	HOSE BAND	1	
43	0605515142	HOSE BAND	3	
44	M4310401004	INTER COOLER PIPE	1	
45	M4310501303	INTER COOLER HOSE	1	
46	M4310501003	INTER COOLER HOSE	1	
47	M4310501403	INTER COOLER HOSE	1	
48	0605515207	HOSE BAND	1	
49	0605515208	HOSE BAND	3	
50	0605515209	HOSE BAND	3	
51	M4310600404	BRACKET, INTER COOLER PIPE	1	
52	0016908020	HEX HEAD BOLT	2	
53	0602326063	U BOLT	1	
54	0602046538	AIR CLEANER	1	
54A	0602046617	OUTER ELEMENT, AIR CLEANER .....	1	P812363
54B	0602046618	INNER ELEMENT, AIR CLEANER .....	1	P838813
55	0602040690	INDICATOR, AIR CLEANER	1	
56	0602040559	BAND, AIR CLEANER	2	
57	0016908020	HEX HEAD BOLT	4	
58	0207008000	HEX NUT	4	
59	M4373200304	BRACKET, AIR CLEANER	1	
60	0016908020	HEX HEAD BOLT	4	
61	M4383000104	PIPE, AIR CLEANER	1	
62	0602040365	90 DEGREE ELBOW	1	
63	0605515260	HOSE BAND	3	
64	0602022580	ADAPTER	1	
65	0602022561	90 DEGREE ELBOW	1	
66	0603306590	CONNECTOR	1	
67	0603300285	ROCKNUT	1	
68	0605511395	VALVE	1	
69	0603306395	HOSE JOINT	1	

# DCA-220SSJ— ENGINE AND RADIATOR ASSY.

## ENGINE AND RADIATOR ASSY.

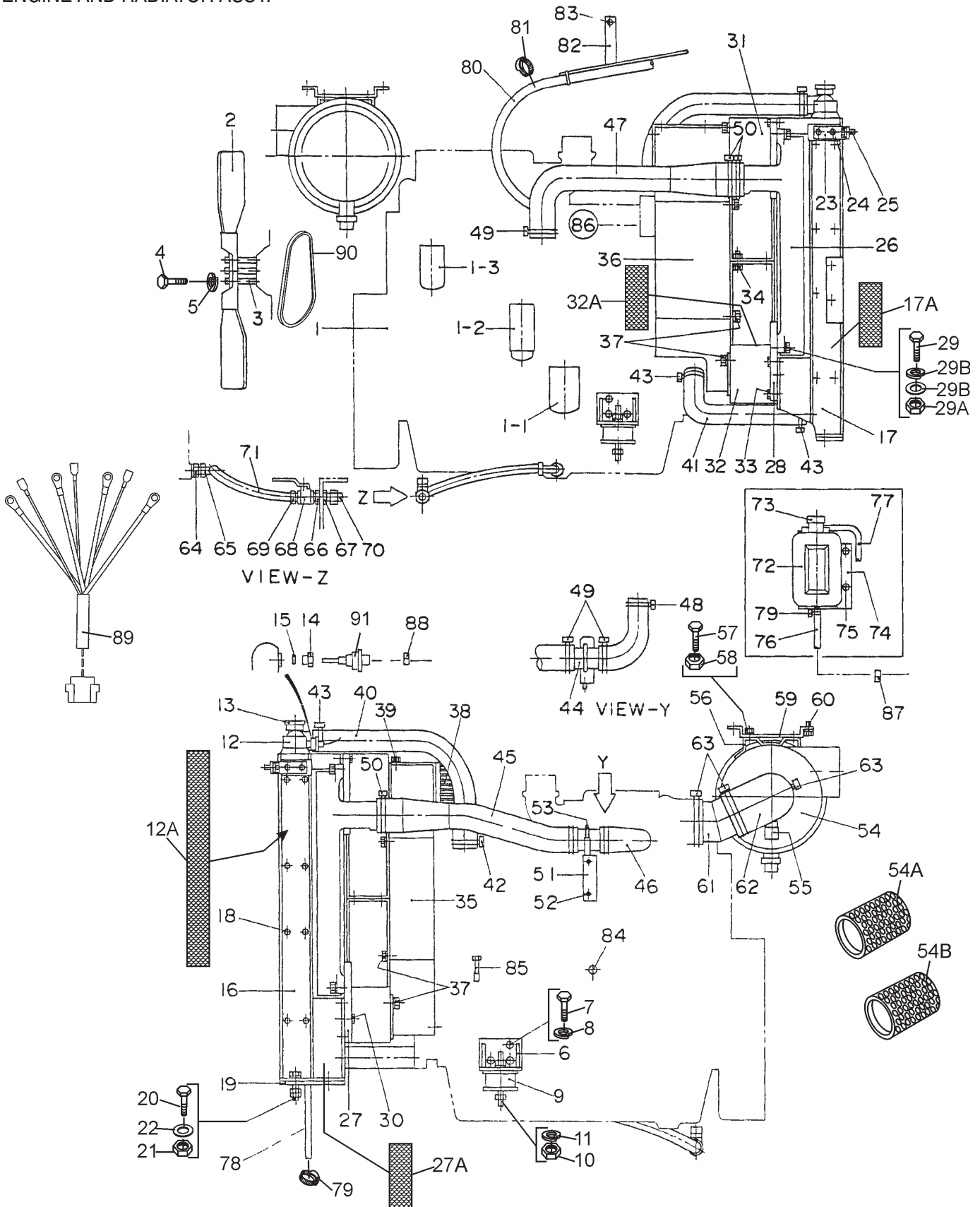

# DCA-220SSJ— ENGINE AND RADIATOR ASSY.

## ENGINE AND RADIATOR ASSY.

<u>NO.</u>	<u>PART NO.</u>	<u>PART NAME</u>	<u>QTY.</u>	<u>REMARKS</u>
70	0602021070	CAP	1	
71	0269200660	DRAIN HOSE	1	
72	0802081003	RESERVE TANK	1	
73	0602010900	RESERVE TANK CAP	1	
74	M4316100103	RESERVE TANK BRACKET	1	
75	0016910025	HEX HEAD BOLT	2	
76	0199901500	HOSE	1	
77	0193601600	HOSE	1	
78	0193600700	HOSE	1	
79	0605515106	HOSE BAND	3	
80	0191601700	BLOWBY HOSE	1	
82	M4483600003	HOSE GUIDE	1	
83	0016908020	HEX HEAD BOLT	2	
84	0602017090	DRAIN VALVE	1	
85	0602042601	LEAK OFF LINE	1	
86	0017110020	HEX HEAD BOLT	1	
86A	0040510000	TOOTHED WASHER	1	
87	0602220911	CLAMP	1	
88	0602220910	CLAMP	1	
89	0602202452	ENGINE WIRE HARNESS	1	
90	0602015230	FAN BELT	1	
91	813NLU0000T	COOLANT LEVEL SWITCH .....	1 .....	REPLACES P/N 0602123290

# DCA-220SSJ— OUTPUT TERMINAL ASSY.

OUTPUT TERMINAL ASSY.

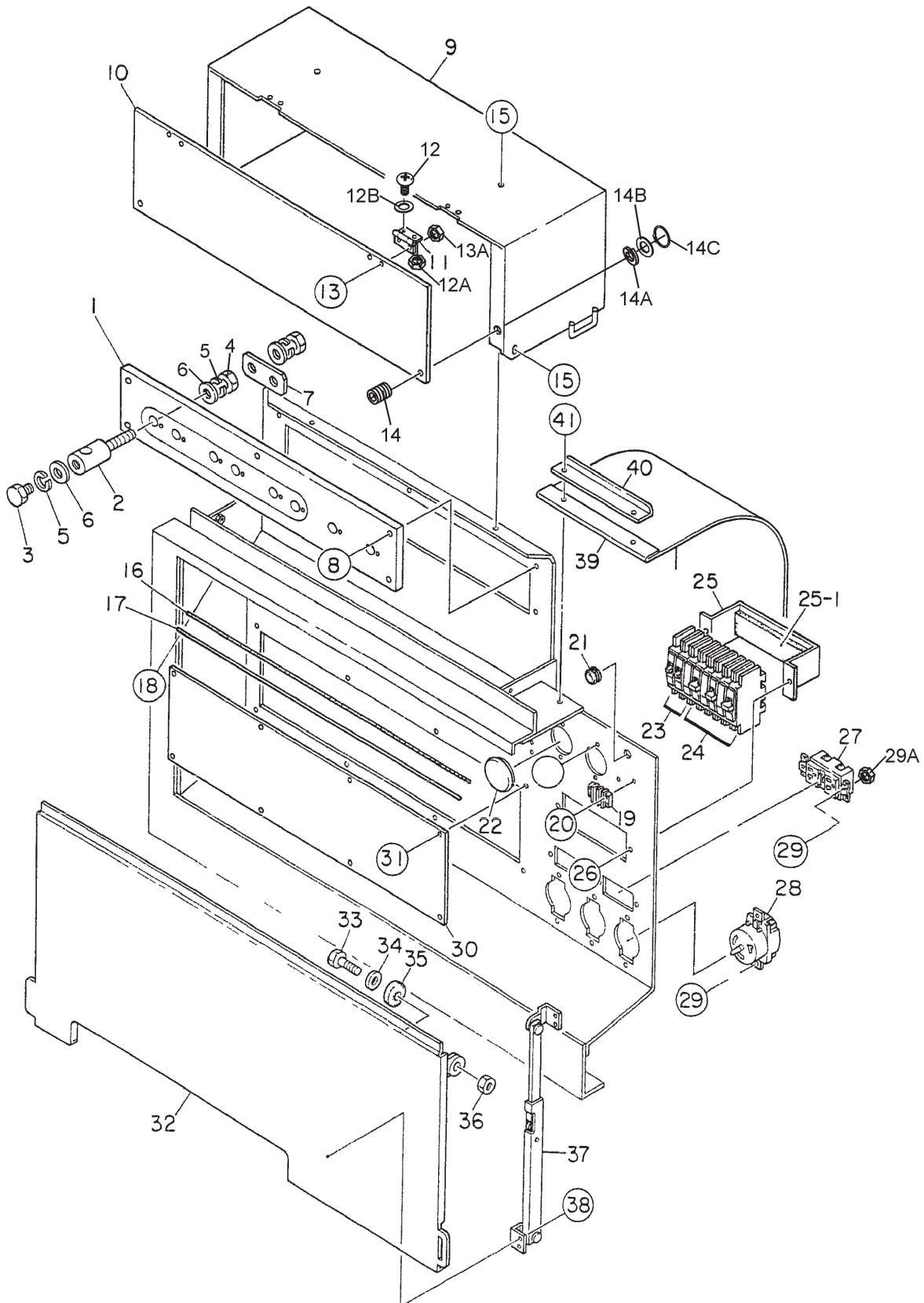



# DCA-220SSJ— OUTPUT TERMINAL ASSY.

## OUTPUT TERMINAL ASSY.

<u>NO.</u>	<u>PART NO.</u>	<u>PART NAME</u>	<u>QTY.</u>	<u>REMARKS</u>
1	M4230700003	TERMINAL BOARD	1	
2	M9220100304	OUTPUT TERMINAL BOLT	8	
3	0801830804	TIE BOLT	8	
4	0039316000	HEX. NUT	16	
5	0040016000	SPRING WASHER	24	
6	0041416000	PLAIN WASHER	32	
7	3461860504	TERMINAL PLATE	3	
8	0019208040	HEX. HEAD BOLT	5	
9	M4236100403	TERMINAL COVER	1	
10	M4236100504	OUTPUT WINDOW	1	
11	0605010040	HINGE	2	
12	0027103010	MACHINE SCREW	4	
12A	0030003000	HEX NUT	4	
12B	0041203000	WASHER, FLAT	4	
13	0027103015	MACHINE SCREW	4	
13A	0030003000	HEX NUT	4	
14	M9220100804	SET SCREW	2	
14A	0040006000	SPRING WASHER	2	
14B	0042806000	PLAIN WASHER	2	
14C	0080200005	RETAINING RING	2	
15	0019206015	HEX HEAD BOLT	4	
16	M4236400004	OUTLET CABLE COVER	1	
17	M4236400104	OUTLET CABLE COVER SUPPORTER	1	
18	0019206015	HEX HEAD BOLT	8	
19	0601815194	TERMINAL BLOCK	1	
20	0025304015	MACHINE SCREW	2	
21	0601850275	GROMMET	1	
22	0601851780	GROMMET	2	
23	0601808803	CIRCUIT BREAKER, 1P 20A	2	
24	0601808804	CIRCUIT BREAKER, 2P 50A	3	
25	C3261600704	CIRCUIT BREAKER BRACKET	1	
25-1	0222100150	RUBBER CUSHION	1	
26	0019206020	HEX HEAD BOLT	2	
27	0601812598	RECEPTACLE, GF-530EM 20A	2	
28	0601812565	RECEPTACLE, CS6369 50A	3	
29	0025304015	MACHINE SCREW	10	
29A	0207004000	HEX NUT	10	
30	M4236400204	COVER	1	
31	0019206015	HEX HEAD BOLT	8	
32	M4236100303	TERMINAL COVER	1	
33	0010112045	HEX HEAD BOLT	2	
34	0041212000	PLAIN WASHER	2	
35	0805009804	STAY RUBBER	2	
36	0030012000	HEX NUT	2	
37	0605011505	STAY	1	
38	0025305015	HEX HEAD BOLT	4	
39	M4236100604	COVER	1	
40	M4236400304	BRACKET	1	
41	0019206015	HEX HEAD BOLT	2	

# DCA-220SSJ— BATTERY ASSY.

BATTERY ASSY.

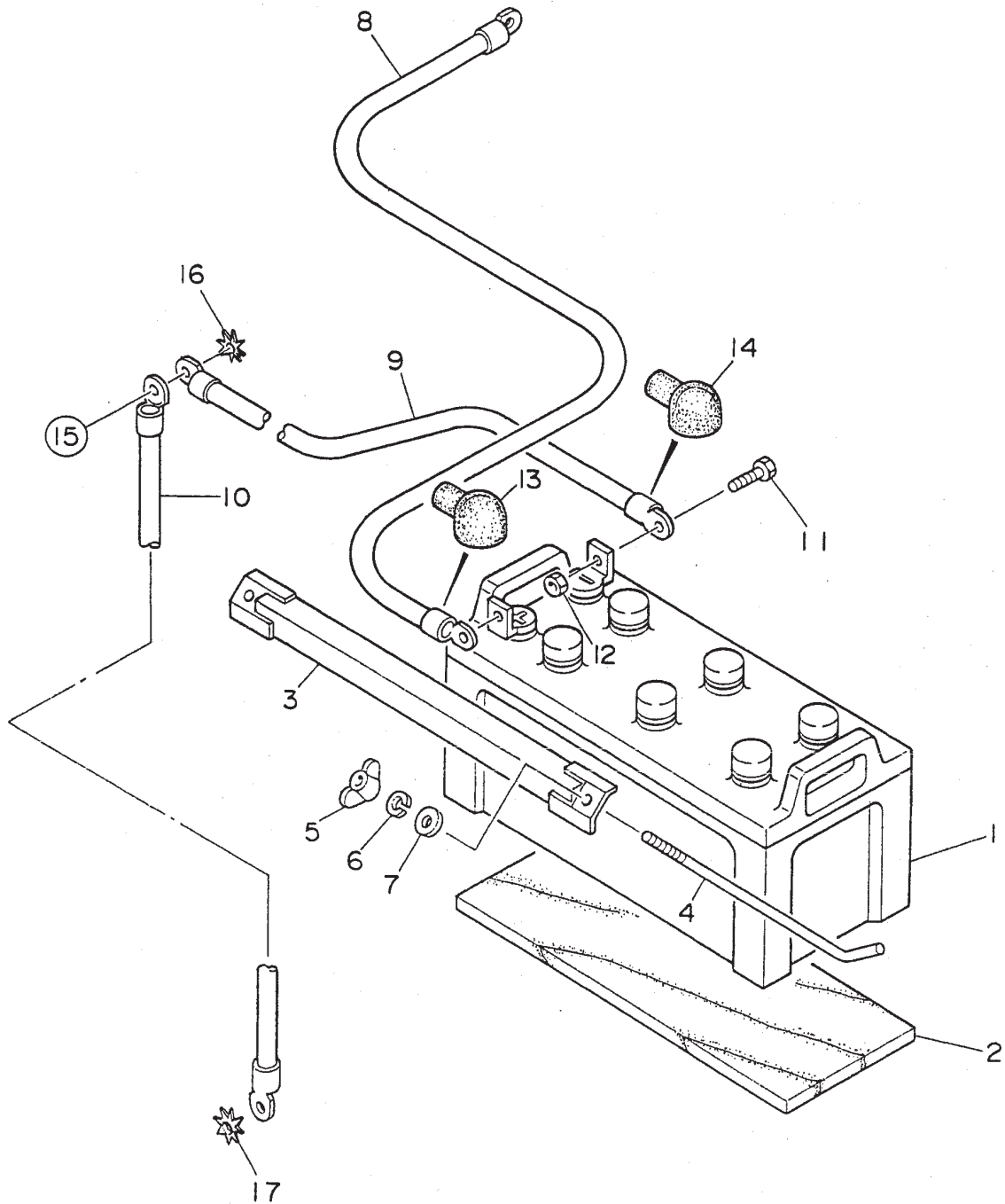

# DCA-220SSJ— BATTERY ASSY.

## BATTERY ASSY.

<u>NO.</u>	<u>PART NO.</u>	<u>PART NAME</u>	<u>QTY.</u>	<u>REMARKS</u>
1	0168614551	BATTERY, 145G51	1	
2	C9109100604	BATTERY SHEET	1	
3	0805000904	BATTERY BAND	1	
4	0805002904	BATTERY BOLT	2	
5	0037808000	WING NUT	2	
6	0040008000	SPRING WASHER	2	
7	0041608000	PLAIN WASHER	2	
8	C1346600004	BATTERY CABLE	1	
9	C1346600104	BATTERY CABLE	1	
10		EARTH CABLE .....	1	..... MAKE LOCALLY
11	0347010003	HEX HEAD BOLT	2	
12	0208110000	HEX NUT	2	
13	0845040414	TERMINAL CAP (+)	1	
14	0845041304	TERMINAL CAP (-)	1	
15	0017116030	HEX HEAD BOLT	1	
16	0040516000	TOOTHED WASHER	1	
17	0040520000	TOOTHED WASHER	1	

# DCA-220SSJ— MUFFLER ASSY.

MUFFLER ASSY.

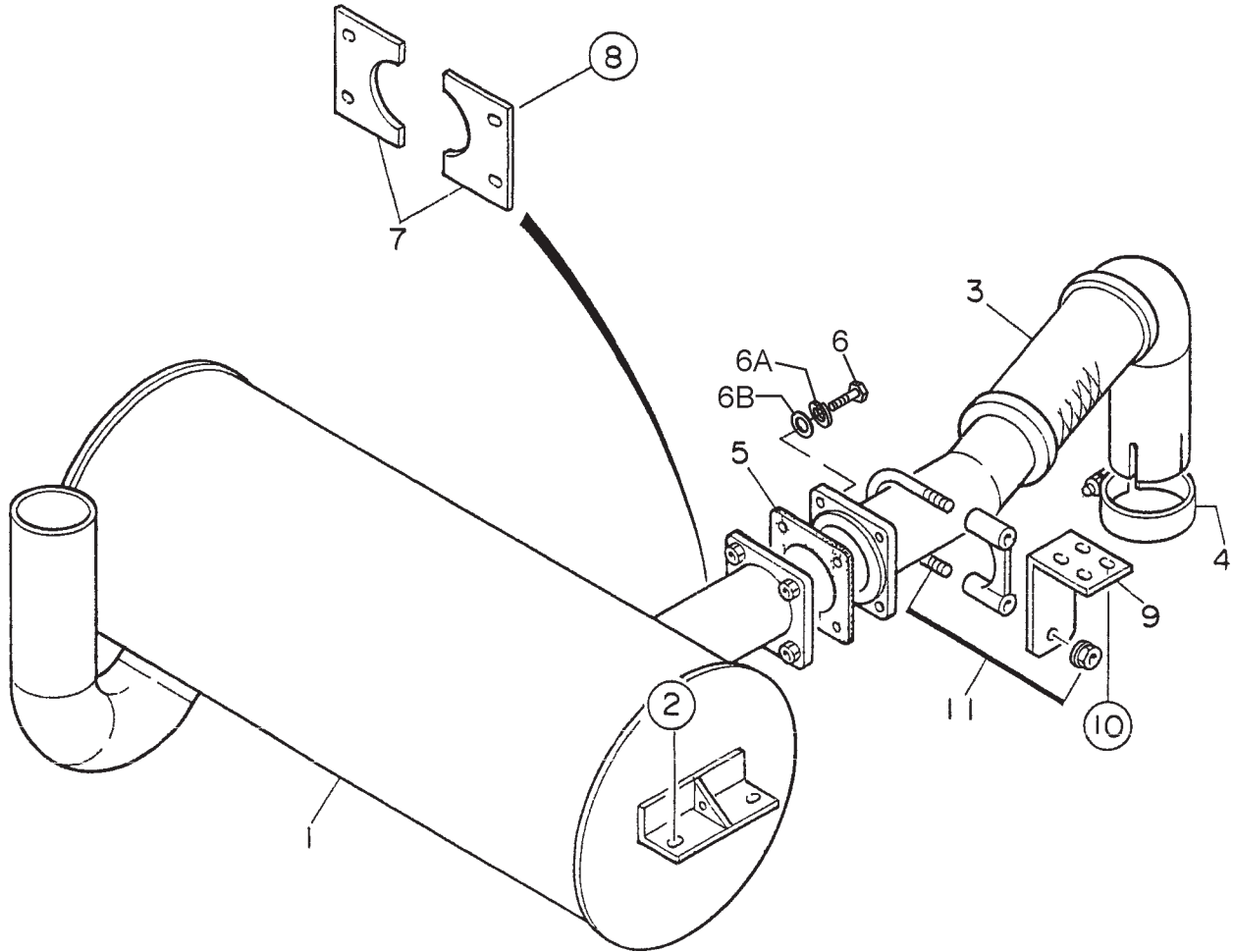

## DCA-220SSJ— MUFFLER ASSY.

### MUFFLER ASSY.

<u>NO.</u>	<u>PART NO.</u>	<u>PART NAME</u>	<u>QTY.</u>	<u>REMARKS</u>
1	M4330100602	MUFFLER	1	
2	0016910025	HEX. HEAD BOLT	4	
3	M4333000303	EXHAUST PIPE	1	
4	0602325066	CLAMP	1	
5	M4333200004	GASKET	1	
6	0010112055	HEX. HEAD BOLT	4	
6A	0040012000	SPRING WASHER	4	
6B	0041212000	PLAIN WASHER	4	
7	M4330300004	COVER	2	
8	0016908020	HEX. HEAD BOLT	4	
9	M4333300304	BRACKET	1	
10	0016908020	HEX. HEAD BOLT	4	
11	0602326062	U-BOLT SET	1	

# DCA-220SSJ— FUEL TANK ASSY.

FUEL TANK ASSY.

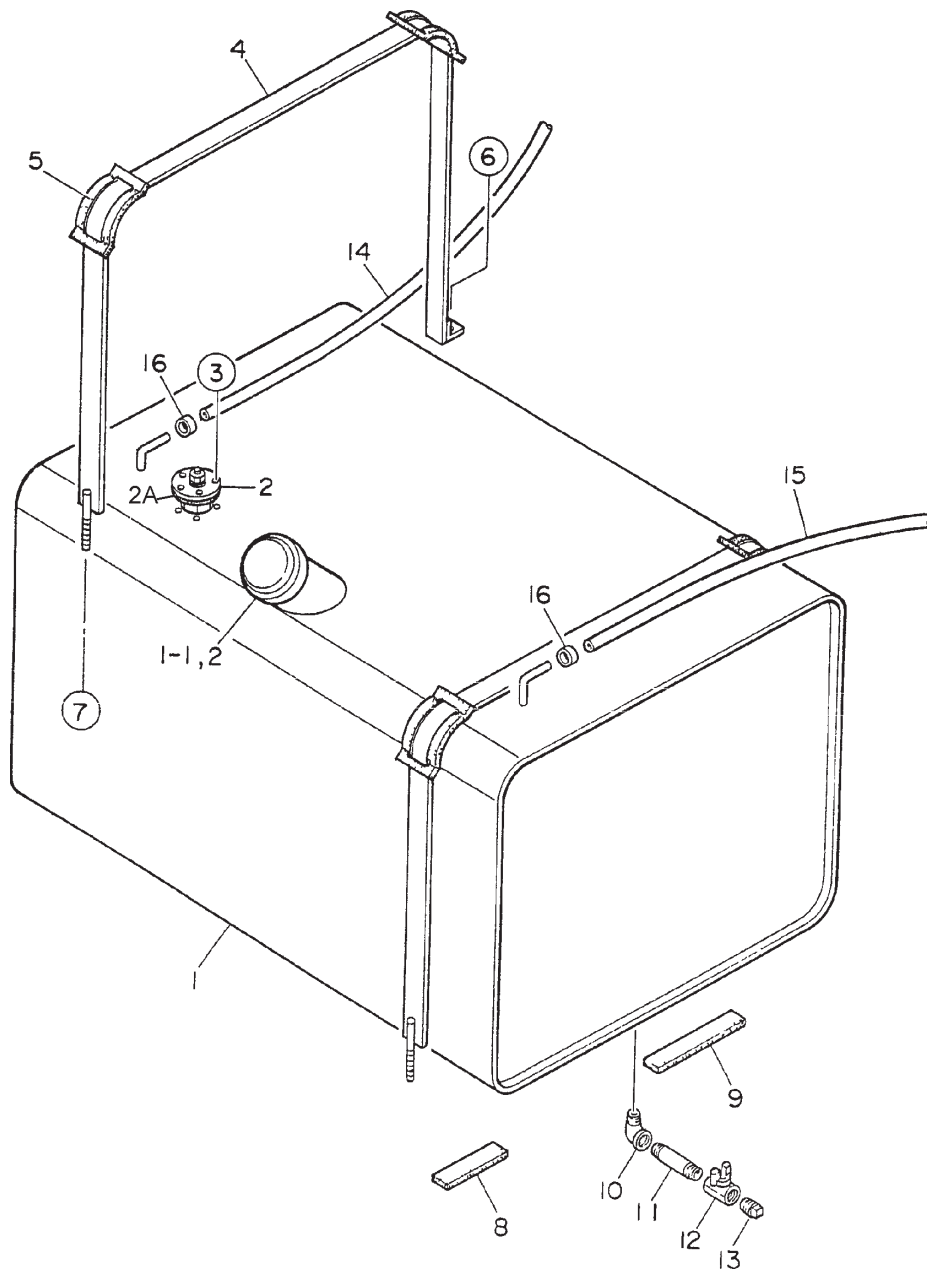



## FUEL TANK ASSY.

<u>NO.</u>	<u>PART NO.</u>	<u>PART NAME</u>	<u>QTY.</u>	<u>REMARKS</u>
1	C1363001403	FUEL TANK	1	
1-1	0845500104	CAP, FUEL TANK	1	
1-2	0810105400	FUEL FILTER	1	
2	0605501092	FUEL GAUGE SENDER	1	
2A	0605516090	GASKET	1	
3	0022905015	MACHINE SCREW	5	
4	M4363200104	TANK BAND	2	
5	0805003414	SUPPORTER SHEET	4	
6	0016908020	HEX HEAD BOLT	2	
7	0207308000	HEX NUT	2	
8	0222100120	RUBBER SHEET	2	
9	0222100180	RUBBER SHEET	2	
10	0130206000	STREET ELBOW, 1/2"	1	
11	8085512104	LONG NIPPLE	1	
12	0603325011	VALVE, 1/2"	1	
13	0132006000	PLUG, 1/2"	1	
14	0191302200	SUCTION HOSE	1	
15	0191302800	RETURN HOSE	1	
16	0605515109	HOSE BAND	4	

# DCA-220SSJ—ENCLOSURE ASSY.

ENCLOSURE ASSY.

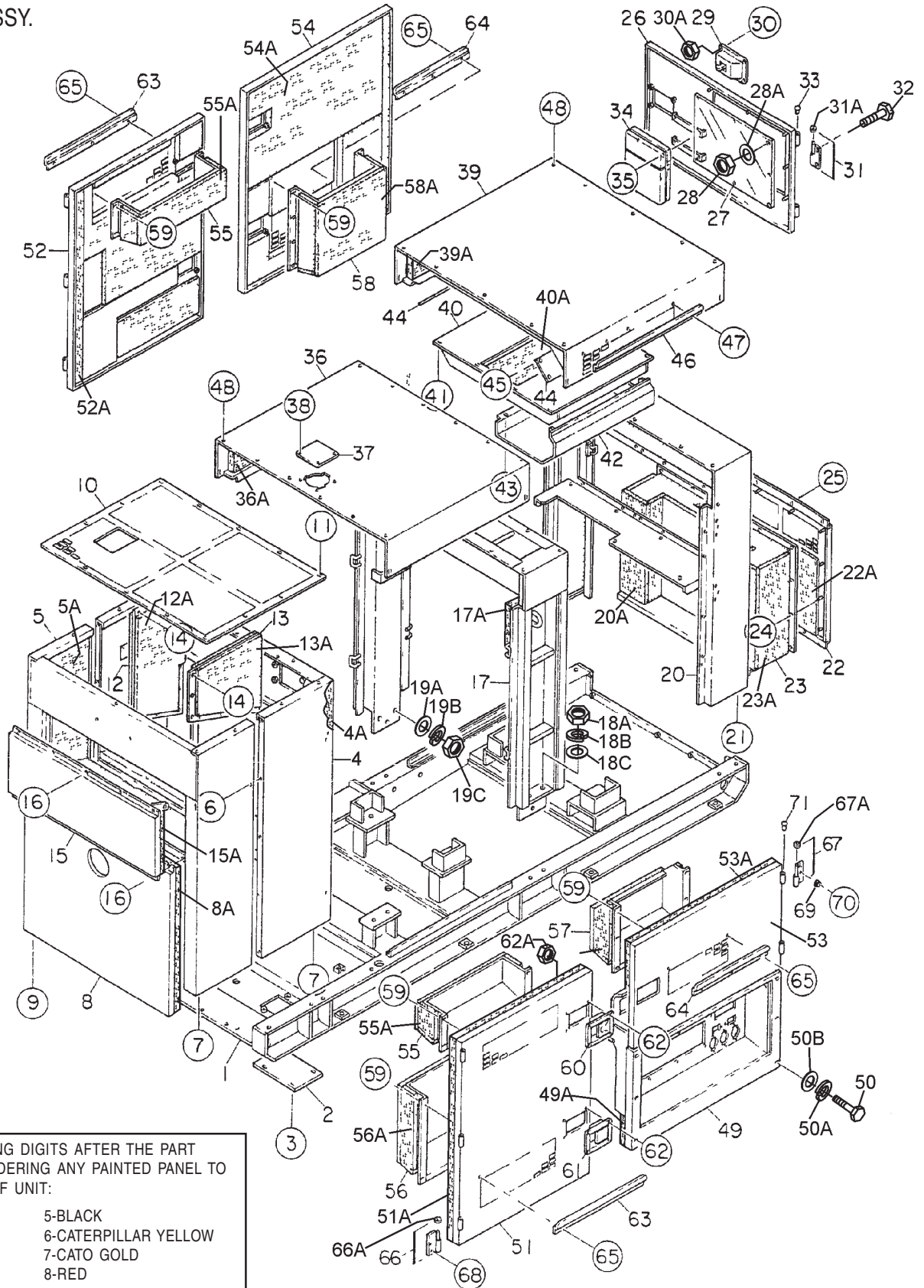

ADD THE FOLLOWING DIGITS AFTER THE PART NUMBER WHEN ORDERING ANY PAINTED PANEL TO INDICATE COLOR OF UNIT:

- |                 |                      |
|-----------------|----------------------|
| 1-ORANGE        | 5-BLACK              |
| 2-WHITE         | 6-CATERPILLAR YELLOW |
| 3-SPECTRUM GREY | 7-CATO GOLD          |
| 4-SUNBELT GREEN | 8-RED                |

THE SERIAL NUMBER MAY BE REQUIRED.

ENCLOSURE ASSY.

<u>NO.</u>	<u>PART NO.</u>	<u>PART NAME</u>	<u>QTY.</u>	<u>REMARKS</u>
1	C1413004402	BASE	1	
2	M1413400404	COVER	1	
3	0019208020	HEX. HEAD BOLT	4	
4	M4423000302	FRONT FRAME	1	
4A	M4493102503	ACOUSTIC SHEET	1	
5	M4423000402	FRONT FRAME	1	
5A	M4493102503	ACOUSTIC SHEET	1	
6	0016908020	HEX. HEAD BOLT	10	
7	0019210035	HEX. HEAD BOLT	8	
8	M4423200304	COVER, FRONT FRAME	1	
8A	M4493102704	ACOUSTIC SHEET	1	
9	0019208020	HEX. HEAD BOLT	6	
10	M4423200403	OVER COVER, FRONT FRAME	1	
11	0019208020	HEX. HEAD BOLT	14	
12	M4423300004	DISCHARGE GUIDE	1	
12A	M4493601404	ACUSTIC SHEET	1	
13	M4423300104	DISCHARGE GUIDE	1	
13A	M4493601404	ACOUSTIC SHEET	1	
14	0019206020	HEX. HEAD BOLT	12	
15	M4423200204	FRONT FRAME COVER	1	
15A	M4493102604	ACOUSTIC SHEET	1	
16	0019208020	HEX. HEAD BOLT	10	
17	M4433000102	CENTER FRAME	1	
17A	M4493200104	ACOUSTIC SHEET	1	
18	0010114050	HEX HEAD BOLT	4	
18A	0030014000	HEX NUT	4	
18B	0040014000	SPRING WASHER	4	
18C	0041214000	PLAIN WASHER	8	
19	0010120045	HEX HEAD BOLT	4	
19A	0030020000	HEX NUT	4	
19B	0040020000	SPRING WASHER	4	
19C	0041220000	PLAIN WASHER	8	
20	M4443000102	REAR FRAME	1	
20A	M4493301904	ACOUSTIC SHEET	1	
21	0019210035	HEX HEAD BOLT	4	
22	M4443300204	COVER, REAR FRAME	1	
22A	M4493302004	ACOUSTIC SHEET	1	

# DCA-220SSJ— ENCLOSURE ASSY. (CONT.)

ENCLOSURE ASSY. (CONT.)

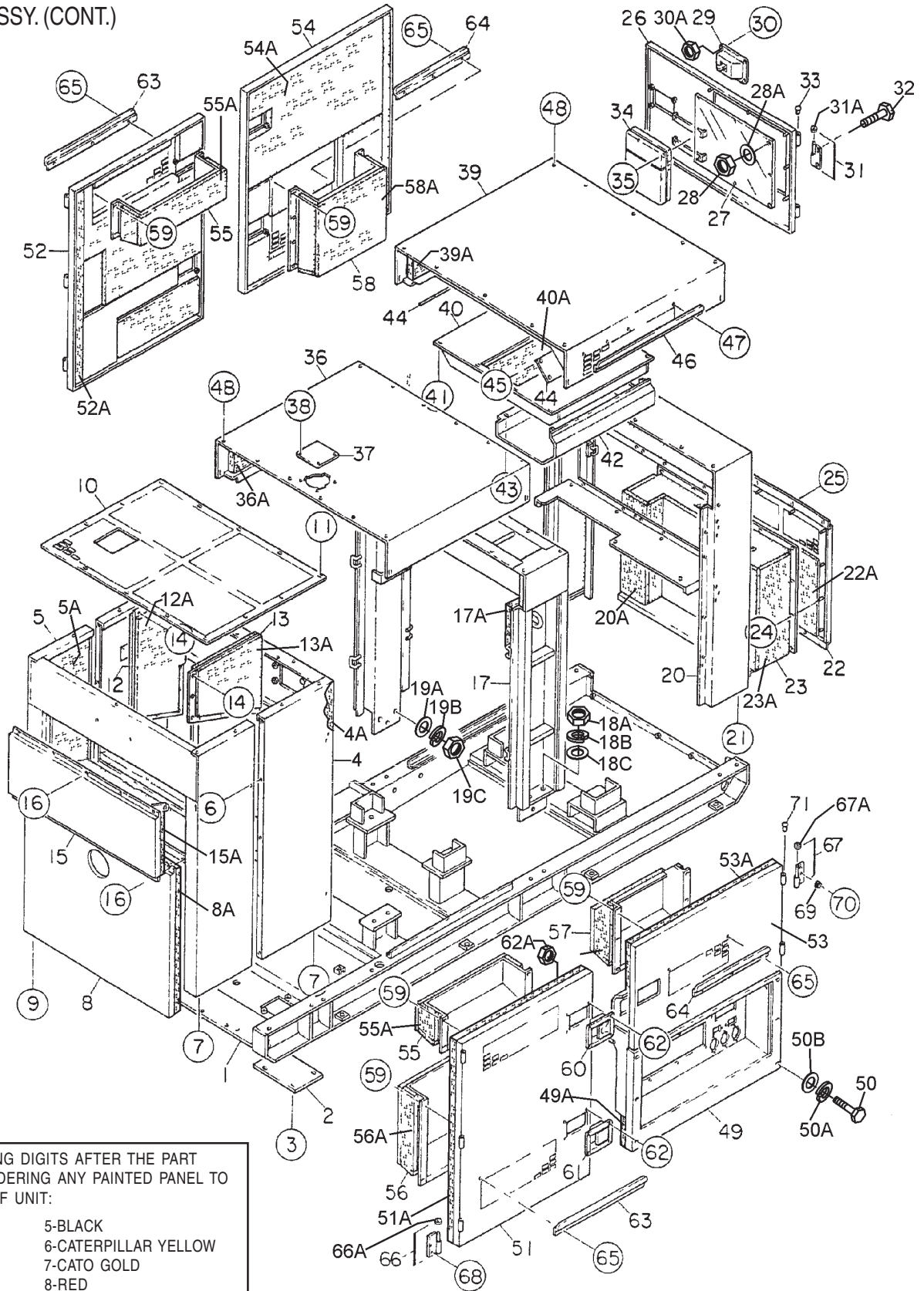

ADD THE FOLLOWING DIGITS AFTER THE PART NUMBER WHEN ORDERING ANY PAINTED PANEL TO INDICATE COLOR OF UNIT:

- |                 |                      |
|-----------------|----------------------|
| 1-ORANGE        | 5-BLACK              |
| 2-WHITE         | 6-CATERPILLAR YELLOW |
| 3-SPECTRUM GREY | 7-CATO GOLD          |
| 4-SUNBELT GREEN | 8-RED                |

THE SERIAL NUMBER MAY BE REQUIRED.

## DCA-220SSJ— ENCLOSURE ASSY. (CONT.)

### ENCLOSURE ASSY. (CONT.)

<u>NO.</u>	<u>PART NO.</u>	<u>PART NAME</u>	<u>QTY.</u>	<u>REMARKS</u>
24	0207306000	HEX. NUT	11	
25	0019208020	HEX. HEAD BOLT	10	
26	M4443200403	DOOR, REAR FRAME	1	
27	M4443600004	WINDOW PLATE	1	
28	0207306000	HEX. NUT	8	
28A	0041206000	PLAIN WASHER	8	
29	B9114000002	DOOR HANDLE	1	
30	0021806016	MACHINE SCREW	4	
30A	0030006000	HEX. NUT	4	
31	0845047104	HINGE	2	
31A	0845045004	WASHER	2	
32	0019208020	HEX. HEAD BOLT	3	
33	0845031504	BLIND PLUG	2	
34	0600800320	MANUAL PAK	1	
35	0027106016	MACHINE SCREW	4	
36	M4463100202	ROOF PANEL	1	
36A	M4493501003	ACOUSTIC SHEET	1	
37	M3310600004	COVER	1	
38	0019208020	HEX HEAD BOLT	4	
39	M4463200202	ROOF PANEL	1	
39A	M4493501903	ACOUSTIC SHEET	1	
40	M4463200403	REAR ROOF DUCT	1	
40A	M4493502004	ACOUSTIC SHEET	1	
41	0016908020	HEX HEAD BOLT	10	
42	M4463400003	DUCT COVER	1	
43	0016908020	HEX HEAD BOLT	7	
44	M4463200304	COVER	2	
45	0016906020	HEX HEAD BOLT	12	
46	M4465300204	GUTTER	2	
47	0019206016	HEX HEAD BOLT	8	
48	0019208020	HEX. HEAD BOLT	32	
49	M4453200102	SPLASHER PANEL	1	
49A	M4493404604	ACOUSTICSHEET	1	
50	0019108065	HEX. HEAD BOLT	6	
50A	0042308000	SPRING WASHER	6	
50B	0042408000	PLAIN WASHER	6	



# DCA-220SSJ— ENCLOSURE ASSY. (CONT.)

## ENCLOSURE ASSY. (CONT.)

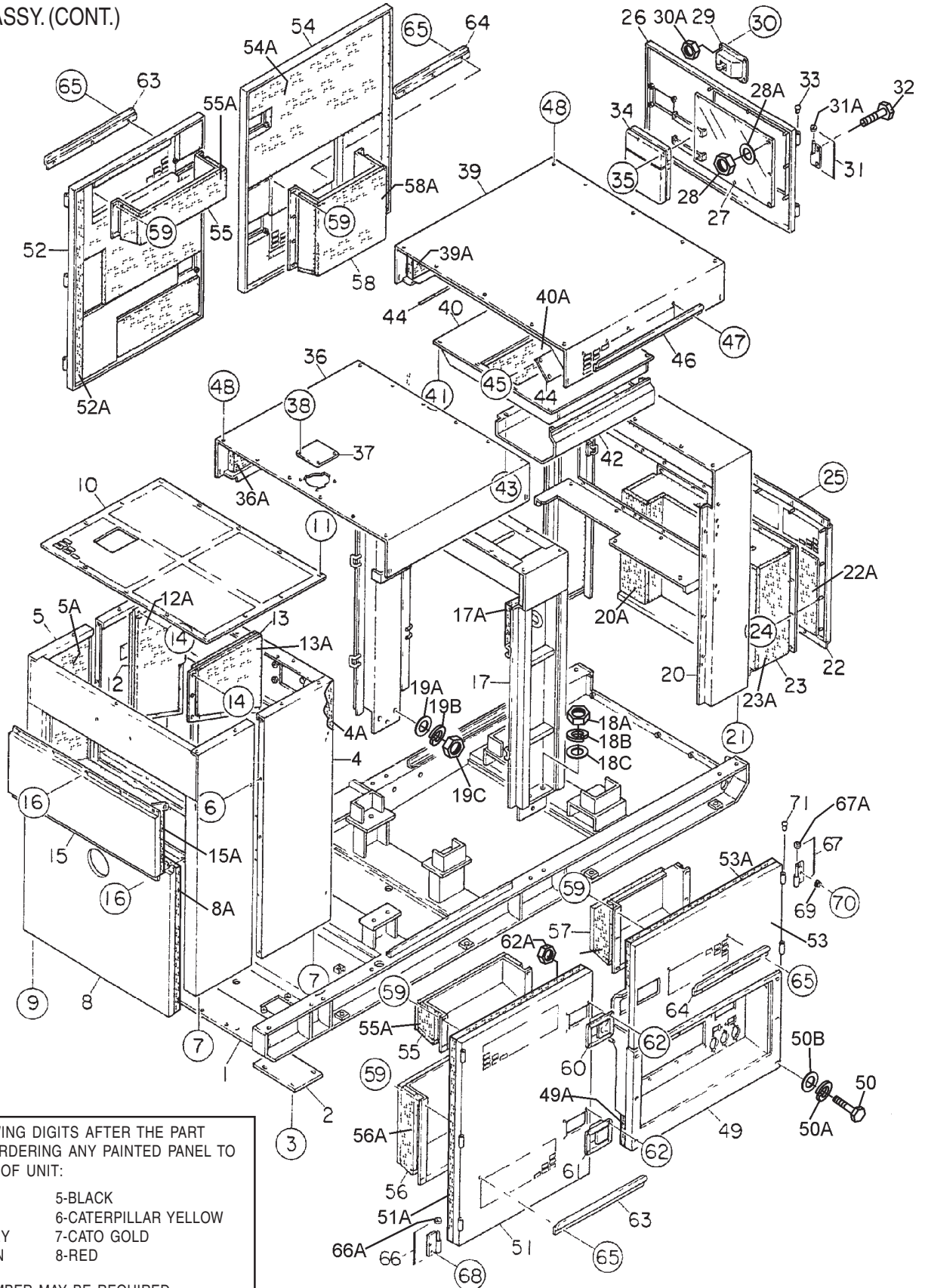

ADD THE FOLLOWING DIGITS AFTER THE PART NUMBER WHEN ORDERING ANY PAINTED PANEL TO INDICATE COLOR OF UNIT:

- |                 |                      |
|-----------------|----------------------|
| 1-ORANGE        | 5-BLACK              |
| 2-WHITE         | 6-CATERPILLAR YELLOW |
| 3-SPECTRUM GREY | 7-CATO GOLD          |
| 4-SUNBELT GREEN | 8-RED                |

THE SERIAL NUMBER MAY BE REQUIRED.



## DCA-220SSJ— ENCLOSURE ASSY. (CONT.)

### ENCLOSURE ASSY. (CONT.)

<u>NO.</u>	<u>PART NO.</u>	<u>PART NAME</u>	<u>QTY.</u>	<u>REMARKS</u>
51	M4453001203	SIDE DOOR	1	
51A	M4493403804	ACOUSTIC SHEET	1	
52	M4453001303	SIDE DOOR	1	
52A	M4493403904	ACOUSTIC SHEET	1	
53	M4453001003	SIDE DOOR	1	
53A	M4493403004	ACOUSTIC SHEET	1	
54	M4453001103	SIDE DOOR	1	
54A	M4493403104	ACOUSTIC SHEET	1	
55	M4453301004	DUCT	2	
55A	M4493404004	ACOUSTIC SHEET	2	
56	M4453300504	DUCT	1	
56A	M4493403204	ACOUSTIC SHEET	1	
57	M4453300704	DUCT	1	
57A	M4493403404	ACOUSTIC SHEET	1	
58	M4453300804	DUCT	1	
58A	M4493403504	ACOUSTIC SHEET	1	
59	0207008000	HEX. NUT	35	
60	B9114000002	DOOR HANDLE	4	
61	0825007362	DOOR HANDLE	3	
62	0021806016	MACHINE SCREW	28	
62A	0030006000	HEX. NUT	28	
63	M4453600004	GUTTER	3	
64	M4453600104	GUTTER	2	
65	0019206016	HEX. HEAD BOLT	15	
66	0845046904	HINGE	6	
66A	0845045004	WASHER	6	
67	0845047004	HINGE	5	
67A	0845045004	WASHER	5	
68	0019208020	HEX. HEAD BOLT	25	
69	0601850097	STOPPER	9	
70	0025408025	MACHINE SCREW	9	
71	0845031504	BLIND PLUG	11	

# DCA-220SSJ— RUBBER SEALS ASSY.

RUBBER SEALS ASSY.

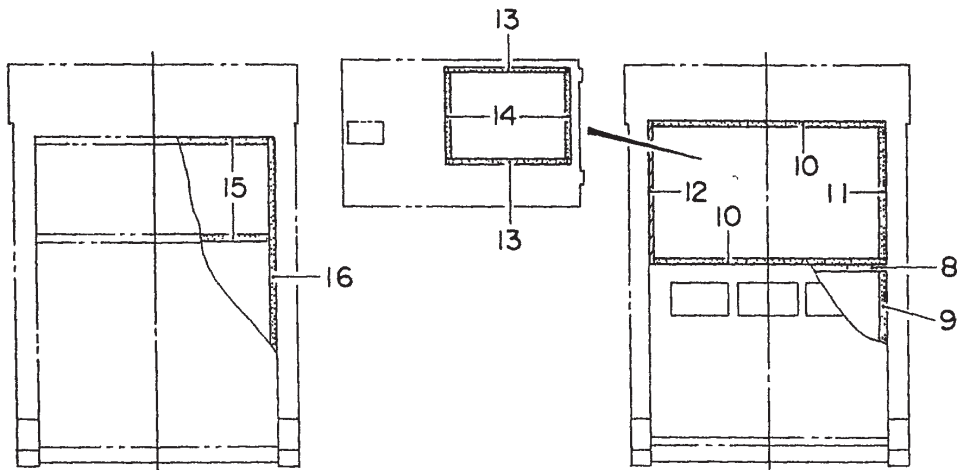
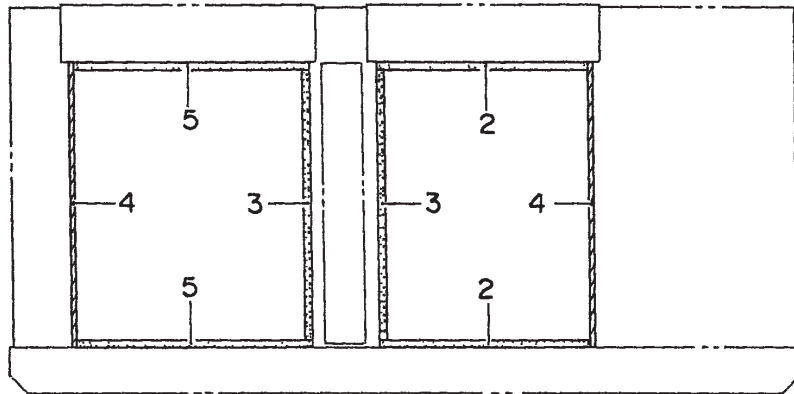
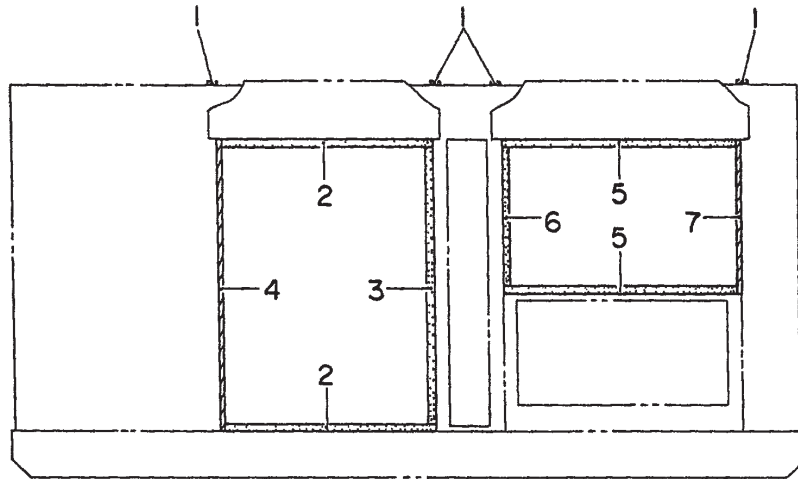

## DCA-220SSJ— RUBBER SEALS ASSY.

### RUBBER SEALS ASSY.

<u>NO.</u>	<u>PART NO.</u>	<u>PART NAME</u>	<u>QTY.</u>	<u>REMARKS</u>
1	0229201240	SEAL RUBBER	4	
2	0228900945	SEAL RUBBER	4	
3	0228901200	SEAL RUBBER	3	
4	0228901260	SEAL RUBBER	3	
5	0228901055	SEAL RUBBER	4	
6	0228900600	SEAL RUBBER	1	
7	0228900660	SEAL RUBBER	1	
8	0229201060	SEAL RUBBER	1	
9	0229200660	SEAL RUBBER	2	
10	0228801050	SEAL RUBBER	2	
11	0228800595	SEAL RUBBER	1	
12	0228800635	SEAL RUBBER	1	
13	0228100560	SEAL RUBBER	2	
14	0228100370	SEAL RUBBER	2	
15	0229201020	SEAL RUBBER	2	
16	0228301200	SEAL RUBBER	2	

# DCA-220SSJ— NAMEPLATE AND DECALS ASSY.

## NAMEPLATE AND DECALS ASSY.

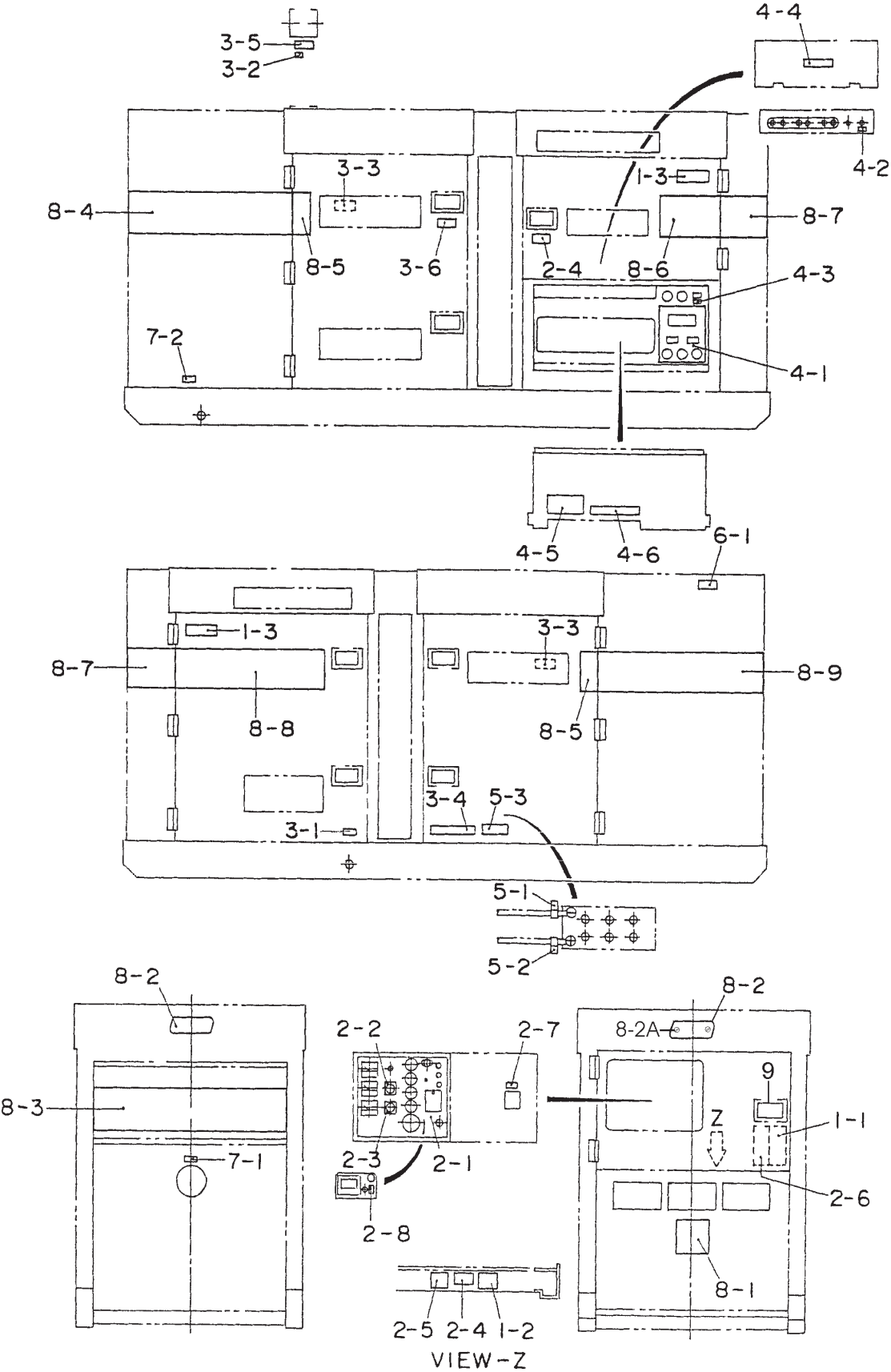

# DCA-220SSJ— NAMEPLATE AND DECALS ASSY.

## NAMEPLATE AND DECALS ASSY.

<b>NO.</b>	<b>PART NO.</b>	<b>PART NAME</b>	<b>QTY.</b>	<b>REMARKS</b>
1-1	M4550000303	DECAL; OPERATING PROCEDURES .....	1 .....	M45000030
1-2	B9521100404	DECAL; SAFETY INSTRUCTIONS .....	1 .....	B92110040
1-3	C9521100003	DECAL; CAUTION .....	2 .....	C92110000
		CONTROL PANEL & BOX GROUP		
2-1	C1550000102	DECAL; CONTROL PANEL .....	1 .....	C15000010
2-2	0800520904	PLATE; AMMETER CHANGE- OVER SWITCH .....	1 .....	N-2438
2-3	0800520814	PLATE; VOLTMETER CHANGE- OVER SWITCH .....	1 .....	N-2439
2-4	B9531100604	DECAL; WARNING ELECTRIC SHOCK HAZARD .....	2 .....	B93110060
2-5	M9520200404	DECAL; OVER CURRENT RELAY .....	1 .....	M92020040
2-6	C0551000903	DECAL; SETTING FOR OUTPUT VOLTAGE .....	1 .....	C05100090
2-7	M9522000504	DECAL; CIRCUIT BREAKER .....	1 .....	M92200050
2-8	C9521007504	DECAL; DIAGNOSTIC SWITCH .....	1 .....	C92100750
		ENGINE & RADIATOR GROUP		
3-1	6360620204	DECAL; OIL DRAIN PLUG .....	1 .....	S1885
3-2	6360610304	DECAL; WATER .....	1 .....	S1880
3-3	B9504000404	DECAL; WARNING MOVING PARTS .....	2 .....	B90400040
3-4	1320610603	DECAL; WATER - OIL CHECK .....	1 .....	S1760
3-5	B9504100104	DECAL; WARNING HOT COOLANT .....	1 .....	B90410010
3-6	B9504000304	DECAL; CAUTION HOT PARTS .....	1 .....	B90400030
		OUTPUT TERMINAL GROUP		
4-1	M1550000703	DECAL; RECEPTACLE & CIRCUIT BREAKER .....	1 .....	M15000070
4-2	0840614104	DECAL; GROUND .....	1 .....	S2635
4-3	9039209064	DECAL; START CONTACT .....	1 .....	S4468
4-4	M9520000704	DECAL; 3- PHASE OUTPUT TERMINAL .....	1 .....	M92000070
4-5	0840619904	DECAL; DANGER HIGH VOLTAGE .....	1 .....	S2731
4-6	M9520100503	DECAL; WARNING .....	1 .....	M92010050
		BATTERY GROUP		
5-1	0800689504	DECAL; - .....	1 .....	S2091
5-2	0800689404	DECAL; + .....	1 .....	S2090
5-3	C9505300004	DECAL; CAUTION .....	1 .....	C90530000
		MUFFLER GROUP		
6-1	B9504200004	DECAL; WARNING ENGINE EXHAUST .....	1 .....	B90420000
		FUEL TANK GROUP		
7-1	1320620904	DECAL; DIESEL FUEL .....	1 .....	S1756
7-2	6360620004	DECAL; FUEL DRAIN PLUG .....	1 .....	S1883
		BONNET GROUP		
8-1	0840625902	DECAL; MQ .....	1 .....	S3057
8-2	0600500090	EMBLEM	2	
	0021106016	MACHINE SCREW	4	
8-3	C1560100303	STRIPE	1	
8-4	C0560100403	STRIPE	1	
8-5	C1560100204	STRIPE	2	
8-6	C1560100404	STRIPE	1	
8-7	C1560100004	STRIPE	2	
8-8	C1560100103	STRIPE	1	
8-9	C0560100303	STRIPE	1	
9	M9503200104	DECAL, DANGER EXHAUST. GAS (INDOOR) .....	1 .....	A90400000

**PAYMENT TERMS**

Terms of payment for parts are net 30 days.

**FREIGHT POLICY**

All parts orders will be shipped collect or prepaid with the charges added to the invoice. All shipments are F.O.B. point of origin. Multiquip's responsibility ceases when a signed manifest has been obtained from the carrier, and any claim for shortage or damage must be settled between the consignee and the carrier.

**MINIMUM ORDER**

The minimum charge for orders from Multiquip is \$15.00 net. Customers will be asked for instructions regarding handling of orders not meeting this requirement.

**RETURNED GOODS POLICY**

Return shipments will be accepted and credit will be allowed, subject to the following provisions:

1. A Returned Material Authorization must be approved by Multiquip prior to shipment.
2. To obtain a Return Material Authorization, a list must be provided to Multiquip Parts Sales that defines item numbers, quantities, and descriptions of the items to be returned.
  - a. The parts numbers and descriptions must match the current parts price list.
  - b. The list must be typed or computer generated.
  - c. The list must state the reason(s) for the return.
  - d. The list must reference the sales order(s) or invoice(s) under which the items were originally purchased.
  - e. The list must include the name and phone number of the person requesting the RMA.
3. A copy of the Return Material Authorization must accompany the return shipment.
4. Freight is at the sender's expense. All parts must be returned freight prepaid to Multiquip's designated receiving point.

5. Parts must be in new and resalable condition, in the original Multiquip package (if any), and with Multiquip part numbers clearly marked.
6. The following items are not returnable:
  - a. Obsolete parts. (If an item is in the price book and shows as being replaced by another item, it is obsolete.)
  - b. Any parts with a limited shelf life (such as gaskets, seals, "O" rings, and other rubber parts) that were purchased more than six months prior to the return date.
  - c. Any line item with an extended dealer net price of less than \$5.00.
  - d. Special order items.
  - e. Electrical components.
  - f. Paint, chemicals, and lubricants.
  - g. Decals and paper products.
  - h. Items purchased in kits.
7. The sender will be notified of any material received that is not acceptable.
8. Such material will be held for five working days from notification, pending instructions. If a reply is not received within five days, the material will be returned to the sender at his expense.
9. Credit on returned parts will be issued at dealer net price at time of the original purchase, less a 15% restocking charge.
10. In cases where an item is accepted, for which the original purchase document can not be determined, the price will be based on the list price that was effective twelve months prior to the RMA date.
11. Credit issued will be applied to future purchases only.

**PRICING AND REBATES**

Prices are subject to change without prior notice. Price changes are effective on a specific date and all orders received on or after that date will be billed at the revised price. Rebates for price declines and added charges for price increases will not be made for stock on hand at the time of any price change.

Multiquip reserves the right to quote and sell direct to Government agencies, and to Original Equipment Manufacturer accounts who use our products as integral parts of their own products.

**SPECIAL EXPEDITING SERVICE**

A \$35.00 surcharge will be added to the invoice for special handling including bus shipments, insured parcel post or in cases where Multiquip must personally deliver the parts to the carrier.

**LIMITATIONS OF SELLER'S LIABILITY**

Multiquip shall not be liable hereunder for damages in excess of the purchase price of the item with respect to which damages are claimed, and in no event shall Multiquip be liable for loss of profit or good will or for any other special, consequential or incidental damages.

**LIMITATION OF WARRANTIES**

No warranties, express or implied, are made in connection with the sale of parts or trade accessories nor as to any engine not manufactured by Multiquip. Such warranties made in connection with the sale of new, complete units are made exclusively by a statement of warranty packaged with such units, and Multiquip neither assumes nor authorizes any person to assume for it any other obligation or liability whatever in connection with the sale of its products. Apart from such written statement of warranty, there are no warranties, express, implied or statutory, which extend beyond the description of the products on the face hereof.





# OPERATION AND PARTS MANUAL

## HERE'S HOW TO GET HELP

PLEASE HAVE THE MODEL AND SERIAL  
NUMBER *ON-HAND* WHEN CALLING

### **MQ POWER CORPORATE OFFICE**

18910 Wilmington Ave. 800-421-1244  
Carson, CA 90746 FAX: 310-632-2656  
Email: [mqpower@multiquip.com](mailto:mqpower@multiquip.com)  
Internet: [www.mqpower.com](http://www.mqpower.com)

### **PARTS DEPARTMENT**

800-427-1244 FAX: 800-672-7877  
310-537-3700 FAX: 310-637-3284

### **SERVICE DEPARTMENT**

800-835-2551 FAX: 310-638-8046  
310-537-3700

### **TECHNICAL ASSISTANCE**

800-835-2551 FAX: 310-638-8046

### **WARRANTY DEPARTMENT**

800-835-2551, EXT. 279 FAX: 310-638-8046  
310-537-3700, EXT. 279

Manufactured for Multiquip Inc.  
by  
DENYO CO., LTD, JAPAN

Your Local Dealer is:



### **MQ POWER**

*A Division of Multiquip Inc.*

POST OFFICE BOX 6254

CARSON, CA 90749

310-537-3700 • 800-421-1244

FAX: 310-632-2656

E-mail: [mqpower@multiquip.com](mailto:mqpower@multiquip.com)

Internet: [www.mqpower.com](http://www.mqpower.com)

## Free Manuals Download Website

<http://myh66.com>

<http://usermanuals.us>

<http://www.somanuals.com>

<http://www.4manuals.cc>

<http://www.manual-lib.com>

<http://www.404manual.com>

<http://www.luxmanual.com>

<http://aubethermostatmanual.com>

Golf course search by state

<http://golfingnear.com>

Email search by domain

<http://emailbydomain.com>

Auto manuals search

<http://auto.somanuals.com>

TV manuals search

<http://tv.somanuals.com>