

**INSTALLER: THESE INSTRUCTIONS MUST BE CONVEYED TO AND REMAIN WITH THE HOMEOWNER.**

CERTIFIED UNDER CANADIAN AND AMERICAN NATIONAL STANDARDS, CSA 2.33, ANSI Z21.88 FOR VENTED GAS FIREPLACE HEATERS



## **GAS INSERT**

**INSTALLATION AND OPERATION INSTRUCTIONS FOR  
GAS-FIRED VENTED ROOM HEATER**

NATURAL GAS MODEL **GI3016-N**

PROPANE GAS MODEL **GI3016-P**

**GAS-ZERO CLEARANCE WHEN INSTALLED WITH GI-700 KIT (FLUSH FRONT & LOUVRES)  
WITHOUT GI-700 KIT INSTALL RECESSED INTO A WOODBURNING NON-COMBUSTIBLE FIREPLACE**  
CERTIFICATION LABEL AFFIXED TO UNDERSIDE OF FRESH AIR DAMPER

**WARNING:** If the information in these instructions is not followed exactly, a fire or explosion may result causing property damage, personal injury or death.

### **FOR YOUR SAFETY**

Do not store or use gasoline or other flammable vapours and liquids in the vicinity of this or any other appliance.

### **WHAT TO DO IF YOU SMELL GAS:**

- Do not try to light any appliance.
- Do not touch any electrical switch.
- Do not use any phone in your building.
- Immediately call your gas supplier from a neighbor's phone. Follow the gas supplier's instructions.
- If you cannot reach your gas supplier, call the fire department.

Installation and service must be performed by a qualified installer, service agency or the gas supplier.



Wolf Steel Ltd., 24 Napoleon Rd., Barrie, ON L4M 4Y8 Canada • (705)721-1212 • fax(705)722-6031

[www.napoleonfireplaces.com](http://www.napoleonfireplaces.com) • [ask@napoleon.on.ca](mailto:ask@napoleon.on.ca)

W415-0171 / D / 01.06.04

# TABLE of CONTENTS

## PG 2-5 INTRODUCTION

Warranty  
 General Instructions  
 Mantle Clearance  
 General Information  
 Care of Glass, Enamelled & Plated Parts

## 5-6 INSTALLATION

Gas Installation  
 Spill Switch  
 Venting Action Check

## 6-9 FINISHING

Brick Panel Installation  
 Log Placement/Charcoal Embers  
 Glass, Flashing Kit, Logo Placement,  
 Louvre, Inset & Bay Kit Installation

## 10-11 OPERATION / MAINTENANCE

Operating Instructions  
 Fresh Air Damper System  
 Maintenance

## 11 BLOWER INSTALLATION

Blower Replacement Instructions

## 11 ADJUSTMENTS

Venturi Adjustments  
 Pilot Burner Adjustment

## 12-13 REPLACEMENTS

Ordering Replacement Parts  
 Replacement Parts  
 Accessories

## 14-15 TROUBLE SHOOTING GUIDE

**PLEASE RETAIN THIS MANUAL FOR FUTURE REFERENCE**

### WARNING

- Adults and especially children should be alerted to the hazards of high surface temperatures and should stay away to avoid burns or clothing ignition. Supervise young children when they are in the same room as the fireplace.
- Clothing or other flammable material should not be placed on or near the fireplace.
- Any safety screen or guard removed for servicing must be replaced prior to operating the fireplace.
- This fireplace must not be connected to a chimney flue pipe serving a separate solid fuel burning appliance.
- Do not operate the fireplace with the glass door removed, cracked or broken. Replacement of the glass should be done by a licensed or qualified service person.
- Do not strike or slam shut the fireplace glass door.
- Due to high temperatures, the fireplace should be located out of traffic and away from furniture and draperies.
- It is imperative that the control compartments, burners and circulating blower and its passageway in the fireplace and venting system are kept clean. The fireplace and its venting system should be inspected before use and at least annually by a qualified service person. More frequent cleaning may be required due to excessive lint from carpeting, bedding material, etc. The fireplace area must be kept clear and free from combustible materials, gasoline and other flammable vapours and liquids.
- Do not use this fireplace if any part has been under water. Immediately call a qualified service technician to inspect the fireplace and to replace any part of the control system and any gas control which has been under water.
- Under no circumstances should this fireplace be modified.
- Do not burn wood or other materials in this fireplace.

**NOTE:** CHANGES, OTHER THAN EDITORIAL, ARE DENOTED BY A VERTICAL LINE IN THE MARGIN

*NAPOLEON gas fireplaces are manufactured under the strict Standard of the world recognized ISO 9001 : 2000 Quality Assurance Certificate.*

*NAPOLEON products are designed with superior components and materials, assembled by trained craftsmen who take great pride in their work. The burner and valve assembly are leak and test-fired at a quality test station. The complete fireplace is thoroughly inspected by a qualified technician before packaging to ensure that you, the customer, receives the quality product that you expect from NAPOLEON.*

## **NAPOLEON GAS FIREPLACE PRESIDENT'S LIFETIME LIMITED WARRANTY**

***The following materials and workmanship in your new NAPOLEON gas fireplace are warranted against defects for as long as you own the fireplace. This covers: combustion chamber, heat exchanger, stainless steel burner, phazer™ logs and embers, ceramic glass (thermal breakage only), gold plated parts against tarnishing, porcelainized enamelled components and aluminum extrusion trims.***

***Electrical (110V and millivolt) components and wearable parts such as blowers, gas valves, thermal switch, switches, wiring, remote controls, ignitor, gasketing, and pilot assembly are covered and NAPOLEON will provide replacement parts free of charge during the first year of the limited warranty.***

***Labour related to warranty repair is covered free of charge during the first year. Repair work, however, requires the prior approval of an authorized company official. Labour costs to the account of NAPOLEON are based on a predetermined rate schedule and any repair work must be done through an authorized NAPOLEON dealer.***

## **CONDITIONS AND LIMITATIONS**

NAPOLEON warrants its products against manufacturing defects to the original purchaser only -- i.e., the individual or legal entity (registered customer) whose name appears on the warranty registration card filed with NAPOLEON -- provided that the purchase was made through an authorized NAPOLEON dealer and is subject to the following conditions and limitations:

This factory warranty is nontransferable and may not be extended whatsoever by any of our representatives.

The gas fireplace must be installed by a licenced, authorized service technician or contractor. Installation must be done in accordance with the installation instructions included with the product and all local and national building and fire codes.

This limited warranty does not cover damages caused by misuse, lack of maintenance, accident, alterations, abuse or neglect and parts installed from other manufacturers will nullify this warranty.

This limited warranty further does not cover any scratches, dents, corrosion or discolouring caused by excessive heat, abrasive and chemical cleaners nor chipping on porcelain enamel parts, mechanical breakage of PHAZER™ logs and embers, nor any venting components used in the installation of the fireplace.

NAPOLEON warrants its stainless steel burners against defects in workmanship and material for life, subject to the following conditions: During the first 10 years NAPOLEON will replace or repair the defective parts at our option free of charge. From 10 years to life, NAPOLEON will provide replacement burners at 50% of the current retail price.

In the first year only, this warranty extends to the repair or replacement of warranted parts which are defective in material or workmanship provided that the product has been operated in accordance with the operation instructions and under normal conditions.

After the first year, with respect to this President's Limited Lifetime Warranty, NAPOLEON may, at its discretion, fully discharge all obligations with respect to this warranty by refunding to the original warranted purchaser the wholesale price of any warranted but defective part(s).

After the first year, NAPOLEON will not be responsible for installation, labour or any other costs or expenses related to the reinstallation of a warranted part, and such expenses are not covered by this warranty.

Notwithstanding any provisions contained in this President's Limited Lifetime Warranty, NAPOLEON'S responsibility under this warranty is defined as above and it shall not in any event extend to any incidental, consequential or indirect damages.

This warranty defines the obligations and liability of NAPOLEON with respect to the NAPOLEON gas fireplace and any other warranties expressed or implied with respect to this product, its components or accessories are excluded.

NAPOLEON neither assumes, nor authorizes any third party to assume, on its behalf, any other liabilities with respect to the sale of this product. NAPOLEON will not be responsible for: over-firing, downdrafts, spillage caused by environmental conditions such as rooftops, buildings, nearby trees, hills, mountains, inadequate vents or ventilation, excessive venting configurations, insufficient makeup air, or negative air pressures which may or may not be caused by mechanical systems such as exhaust fans, furnaces, clothes dryers, etc.

Any damages to fireplace, combustion chamber, heat exchanger, brass trim or other component due to water, weather damage, long periods of dampness, condensation, damaging chemicals or cleaners will not be the responsibility of NAPOLEON.

The bill of sale or copy will be required together with a serial number and a model number when making any warranty claims from your authorized dealer. The warranty registration card must be returned within fourteen days to register the warranty.

NAPOLEON reserves the right to have its representative inspect any product or part thereof prior to honouring any warranty claim.

## GENERAL INSTRUCTIONS

Installation practices vary from region to region and it is important to know the specifics that apply to your area, for example: in Massachusetts State:

- The fireplace damper must be removed or welded in the open position prior to installation of a fireplace insert or gas log.
- The appliance off valve must be a "T" handle gas cock.
- The flexible connector must not be longer than 36 inches.
- The appliance is not approved for installation in a bedroom or bathroom unless the unit is a direct vent sealed combustion product.
- **WARNING:** This product must be installed by a licensed plumber or gas fitter when installed within the commonwealth of Massachusetts.

In absence of local codes, install to the current CAN1-B149 Installation Code in Canada or to the National Fuel Gas Code, ANSI Z223.1, and NFPA 54 in the United States.

**Purge all gas lines with the glass door of the fireplace removed. Assure that a continuous gas flow is at the burner before installing the door.**

**Under extreme vent configurations, allow several minutes (5-15) for the flame to stabilize after ignition. Altitudes greater than 4,000 ft. require a minimum vent run of 12 ft.**

The heater and its individual shutoff valve must be disconnected from the gas supply piping system during any pressure testing of that system at test pressures in excess of ½ psig (3.5 kPa). The fireplace must be isolated from the gas supply piping system by closing its individual manual shutoff valve during any pressure testing of the gas supply piping system at test pressures equal to or less than ½ psig (3.5 kPa).

A 1/8 inch NPT plug, accessible for test gauge connection, must be installed immediately upstream of the gas supply connection to the fireplace.

This fireplace must be connected to any accepted lined chimney system listed to ULC-S635M (in Canada) or UL-1777 (in USA). The venting connection must be in compliance with the chimney manufacturers installation instructions.

The draft hood must be installed so that it is in the same atmospheric pressure zone as the combustion air inlet to the fireplace.

This heater can be installed two different ways. If installed as is, it must be recessed into a vented noncombustible woodburning fireplace (prefabricated or masonry) only. This is referred to as an INSERT type of installation.

The minimum fireplace size in which the heater is to be installed is:

**HEIGHT 21 inches**  
**WIDTH 26½ inches**  
**DEPTH 17½ inches**

If installed in conjunction with kit #GI-700, it may be framed into an enclosure made of combustible materials. This is referred to as a ZERO CLEARANCE type of installation. This heater may only be installed in the GI-700 when using the glass front kit, GI-FF, as well as one louvre kit, GI-LPB, GI-LAB, GI-LG or GI-LK. The minimum clearance to combustible construction in this form of installation is:

<b>MANTLE HEIGHT*</b>	<b>7 inches**</b>
<b>SIDES, BACK, BOTTOM &amp; TOP</b>	<b>0 inches</b>
<b>B-VENT</b>	<b>1 inch</b>
<b>RECESSED DEPTH</b>	<b>18½ inches</b>

\* MEASUREMENTS TAKEN FROM KIT STANDOFFS. SEE KIT INSTRUCTIONS

\*\*MAXIMUM HORIZONTAL EXTENSION IS 6 INCHES.

**Objects placed in front of the fireplace must be kept a minimum of 48" away from the front face.**

The fireplace, when installed, must be electrically connected and grounded in accordance with local codes. In the absence of local codes, use the current CSA C22.1 CANADIAN ELECTRICAL CODE in Canada or the ANSI/NFPA 70 NATIONAL ELECTRICAL CODE in the United States. The blower power cord must be connected into a properly grounded receptacle. The grounding prong must not be removed from the cord plug.

**Provide adequate ventilation and combustion air. Provide adequate accessibility clearance for servicing and operating the fireplace. Never obstruct the front opening of the fireplace.**

## MANTLE CLEARANCE

Mantle clearance, while conforming to the stated clearance to combustible materials, can vary according to the mantle depth. These clearances do not apply to a GI-700 kit type installation.

**FIGURE 1**

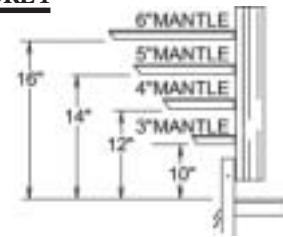

## GENERAL INFORMATION

**FOR YOUR SATISFACTION, THIS FIREPLACE HAS BEEN TEST-FIRED TO ASSURE ITS OPERATION AND QUALITY!** Maximum input is 30,000 BTU/hr for natural gas and 24,000 BTU/hr for propane. When the fireplace is installed at elevations above 4,500 ft., and in the absence of specific recommendations from the local authority having jurisdiction, the certified high altitude input rating shall be reduced at the rate of 4% for each additional 1,000 ft. Maximum output for natural gas is 22,800 BTU/hr at an efficiency of 76% with the fan on, 72% with the fan off; and 18,240 BTU/hr for propane at an efficiency of 76% with the fan on, 71% with the fan off. Minimum A.F.U.E. (Annual Fuel Utilization Efficiency) rating is 64% for both natural and propane gas. Where the fireplace has been factory equipped for hi-altitude, the input has been downrated by 10%. This fireplace is approved for bathroom, bedroom and bed-sitting room installations and is suitable for mobile home installation.

Minimum inlet gas supply pressure is 4.5 inches water column for natural gas and 11 inches water column for propane. Maximum inlet gas pressure is 7 inches water column for natural gas and 13 inches water column for propane. Manifold pressure under flow conditions is 3.5 inches water column for natural gas and 10 inches water column for propane.

**No external electricity (110 volts or 24 volts) is required for the gas system operation.**

Change in flame appearance from "HI" to "LO" is more evident in natural gas than in propane. The self generating pilot provides current for a remote burner On-Off switch.

## CARE OF GLASS, ENAMELLED AND PLATED PARTS

Do not use abrasive cleaners to clean these parts. Buff lightly with a clean dry cloth. Porcelain enamelled components must be handled with care. The baked-on finish is glasslike. If struck, it will chip! Touch-up paint is available through your Napoleon dealer.

The glass is 3/16" ceramic glass available from your Napoleon dealer. DO NOT SUBSTITUTE MATERIALS. Clean the glass after the first 10 hours of operation with a recommended gas fireplace glass cleaner. Thereafter clean as required. DO NOT CLEAN GLASS WHEN HOT! If the glass is not kept clean permanent discolouration and / or blemishes may result.

## INSTALLATION

**FIGURE 2**

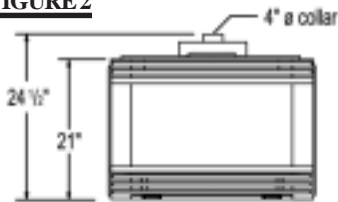

Clean out the ashes from the inside of the woodburning fireplace. Make sure that the chimney and woodburning fireplace are in clean and sound condition. Do not remove bricks or mortar from the masonry fireplace. If necessary have any repair work done by a qualified person before installing the insert. Remove the existing fireplace damper or lock into an open position. Line the chimney with a 4 inch diameter approved liner. Pack insulation around the liner in the damper area to prevent air flow from entering the chimney. Chimney installation must conform to both national and local code requirements. The liner must be continuous from the fireplace to the chimney cap.

**FIGURE 3**

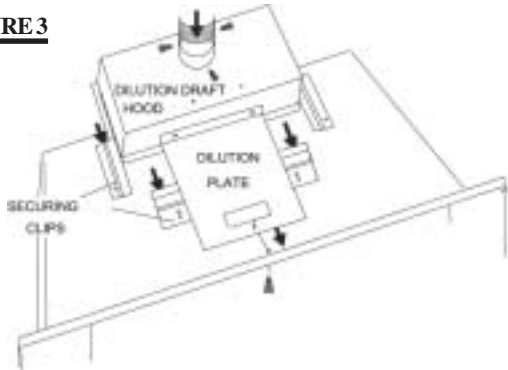

Remove the securing screw from the front of the dilution plate. Push the dilution hood out of its securing clip and attach the liner using 3 screws equally spaced. Move the insert into the centre of the woodburning fireplace making sure that the dilution draft hood inserts back into its securing clip. Level using the four levelling screws located front and back on either side of the fireplace base.

**FIGURE 4**

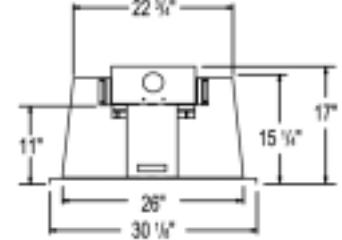
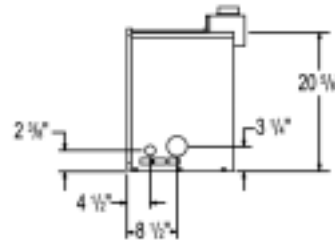
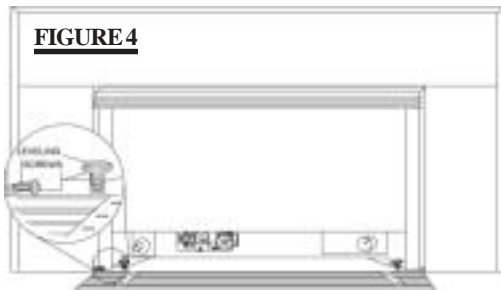

Levelling the insert will eliminate rocking or excessive noise when the fan is in operation. Replace the securing screw to the front of the dilution plate.



**FIGURE 5**

Install rigid black pipe, a flex connector, *if local codes permit*, or 1/2" type L, copper tubing with a 3/8" to 1/2" adapter and a shut off valve to the fireplace. Seal and tighten securely. The adapter will be required between the gas valve and the copper tubing or flex connector.

**Do not damage or kink flex connector!**

Check for gas leaks by brushing on a soap and water solution.

**Do not use open flame!**

An on/off switch has been included and can be located at the lower right, behind the louvre access door or at the right side trim.

For ease of accessibility, this switch may be replaced with a wall switch or substituted with a millivolt thermostat that may be installed in a convenient location on any wall. Route 2-strand (solid core) millivolt wire through the electrical hole located at the bottom right side of the unit. The recommended maximum lead length depends on wire size:

WIRE SIZE	MAX. LENGTH
14gauge	100 feet
16gauge	60 feet
18gauge	40 feet

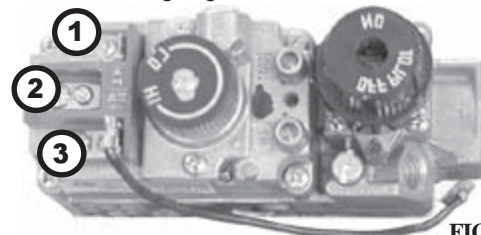

**FIGURE 6**

Attach the two leads to terminals 1 and 3 located on the gas valve.

**Do not connect either the wall switch or the gas valve to electricity (110 volts or 24 volts).**

W415-0171 / D/01.06.04

## SPILL SWITCH

This is a thermally activated switch, attached to the back of the unit and extending up into the dilution draft hood, which senses the change in temperature and shuts down the gas valve in the event of a severe downdraft of air or a blocked or disconnected vent. It acts as a safety shutoff to prevent a build up of carbon monoxide or an explosion of unburnt gases during start up. If the flue is blocked or has no "draw", the spill switch will automatically shut off the supply of gas within about 5-10 minutes.

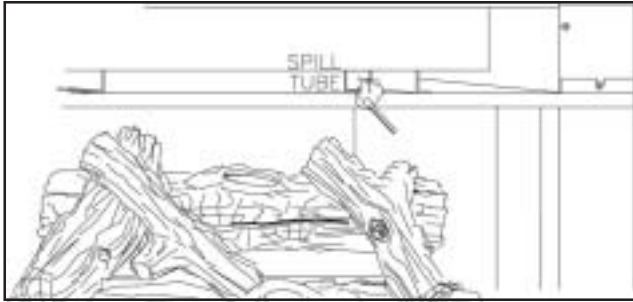

**FIGURE 8**



**TAMPERING WITH THE SWITCH CAN RESULT IN CARBON MONOXIDE (CO) POISONING AND POSSIBLE DEATH.**

## FINISHING

### OPTIONAL BRICK PANEL INSTALLATION

Remove the securing screws located on either of the firebox sides as illustrated. Remove protective plastic wrap from all four panels. Centre the rear brick panel against the back of the firebox. Place the left brick panel against the left side of the firebox, ensuring that it butts up to the rear panel.



**FIGURE 9a**

Excess material may be trimmed with a utility knife. Secure in place using a retainer bracket and 2 of the screws. Repeat for the right side.



**FIGURE 9b**

*When shipped, the brick panels range in colour from white to varying shades of brown. During initial use, the panels will darken temporarily and emit a slight odour for a few hours. This is a normal condition that will not occur again. Simply open a window to sufficiently ventilate the room. The appearance of the panels will permanently lighten in colour with use.*

## VENTING ACTION CHECK

**A check for correct venting action must be made before the installed insert is left with the customer.**

Test after installing the unit into either the GI-700 ZERO CLEARANCE KIT or a vented noncombustible fireplace in the following manner:

1. Close all doors and windows in the room / start exhaust fans in the home / turn fireplace blower off.
2. Set controls to "high" and light the unit.
3. Wait 5 minutes. Light a match and hold it to the spill tube opening.
4. Venting action is satisfactory if smoke is drawn into the spill tube. Venting action is unsatisfactory if the flame and smoke are not drawn into the tube.
5. If venting action is unsatisfactory, turn the unit off, wait 10 minutes and try again. If the smoke or flame is still not drawn into the spill tube, turn the unit off and check for adequate fresh air supply, vent blockage or restriction. If necessary, consult with a qualified inspector.

## LOG PLACEMENT

**PHAZER™** logs and charcoal embers, exclusive to Napoleon Fireplaces, provide a unique and realistic glowing effect that is different in every installation. Take the time to carefully position the charcoal embers for a maximum glowing effect.

**POSITIONING THE LOGS IMPROPERLY WILL CAUSE FLAME IMPINGEMENT AND CARBONING.**

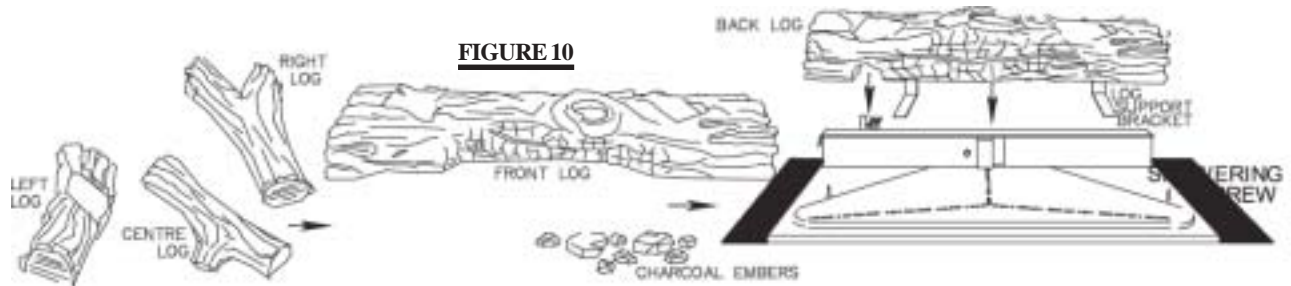

1. Place the front log onto the main burner, pushing it as close as possible to the burner ports without blocking/covering them. The left and right spacing between the log ends and the burner ports should be equal.
2. Place the back log onto the log support brackets located on the rear wall of the combustion chamber. The notch situated at the lower left of the back log should be centred evenly above the pilot assembly.
3. While supporting the back log, to prevent it from falling forward, set the three smaller logs into the pockets and grooves of the front and back logs, respectively.

**Log colours may vary. During the initial use of the fireplace, the colours will become more uniform as colour pigments burn in during the heat activated curing process.**

## CHARCOAL EMBERS

Randomly place the embers along the front burner ports. Keep ember dust away from burner ports to avoid plugging them.

**Fine dust found in bottom of bag not to be used.** **PHAZER™** logs and charcoal embers glow when exposed to direct flame. Use only certified **PHAZER™** logs and charcoal embers available from your Napoleon dealer.



**FIGURE 11**

**FLUSH GLASS FRONT KIT, GI-FF**

Attach the lower glass bracket. Seat the glass inside the bracket and using two screws attach the upper glass bracket, as shown.

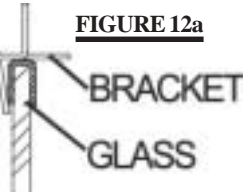

**FIGURE 12a**

**FLASHING SURROUND KITS, GI-900 / GI-909**

Assemble the flashing and mount to the inside of the outer shell using 4 securing screws (supplied with the louvre kit).

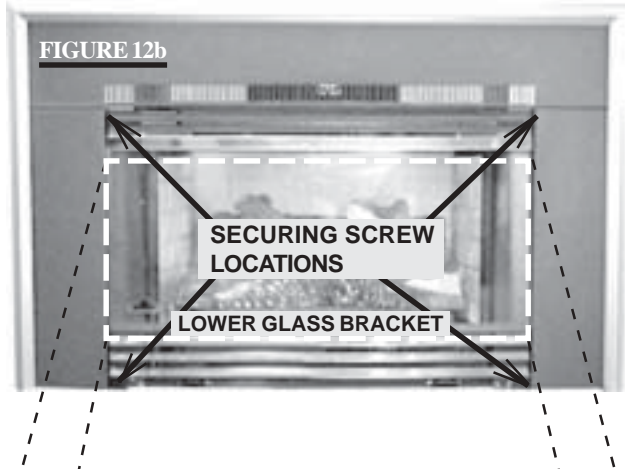

**FIGURE 12b**

**LOGO PLACEMENT**



**FIGURE 13**

Remove the backing of the logo supplied and place on the glass viewing area, as indicated.

**FLUSH LOUVRE KIT, GI-1L**

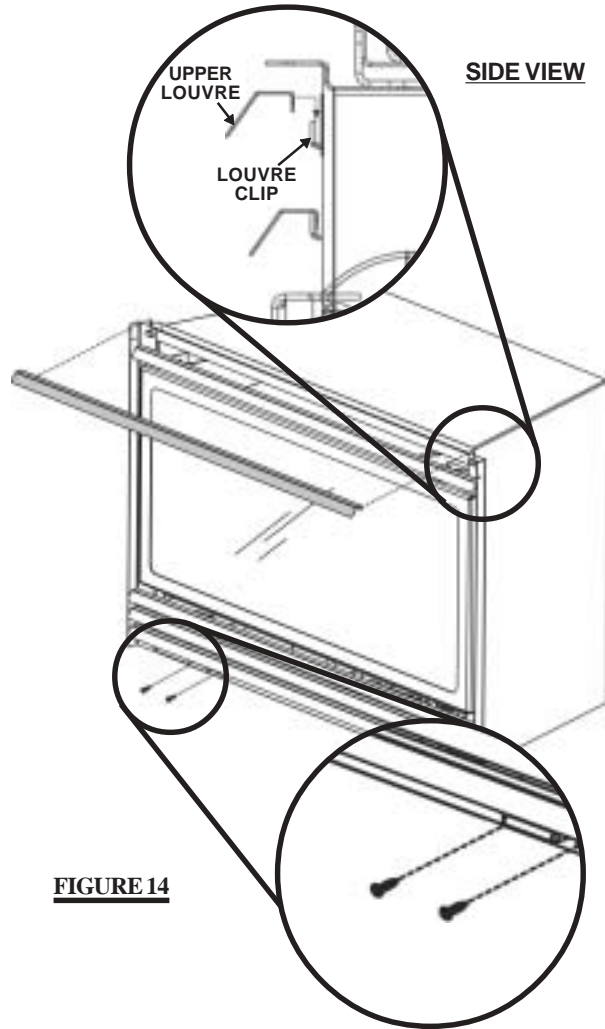

**SIDE VIEW**

**FIGURE 14**

**UPPER LOUVRES**

Insert the back edge of the upper louvre into the upper louvre clips.

**LOWER LOUVRES**

Secure the lower louvre assembly to the insert, using the 4 screws supplied.



**ORNAMENTAL FLUSH INSETS, GI-OI**

Assemble the flashing and mount to the inside of the outer shell using 4 securing screws and spacers (supplied) as shown. Hook the ornamental inlays over the spacers.

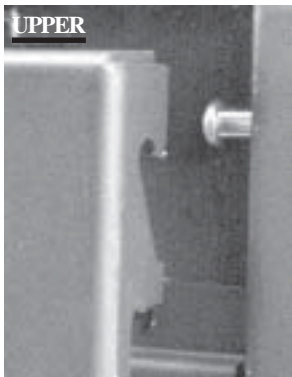

**FIGURE 17**



**FIGURE 18**

**ORNAMENTAL BAY INSETS, GI-OI**

**BAY GLASS FRONT, GI-BF**

With the bay chassis on a flat surface, insert the front glass (bottom first) and centred to the mitred edges of the chassis.

Fit the bevelled edge of the each side glass piece tightly to either edge of the front glass.

Secure the glass by bending up the retainer tabs at the top and bottom.

Spread and insert the spring clips between the side glass and the chassis (2 per side).

Place the front brick pa pieces into place at the b

Secure the bay to the insert front at the top and bottom outside corners using 4 screws.



**FIGURES 16**

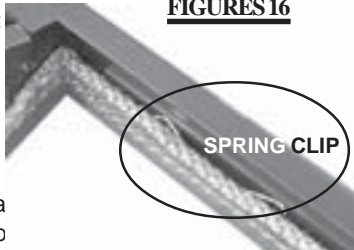

**FIGURE 19**



Both these options may be attached to the insert front using 4 magnets, positioned as shown:

**NOTE:**The ornamental bay inlays can be adjusted to align with the bay door assembly.

**FIGURE 20**



**BAY LOUVRES, GIB-L**

**Note:** Black louvre assembly, if supplied, must be installed as uppers, due to the high fireplace temperature.

# OPERATION / MAINTENANCE

## OPERATING INSTRUCTIONS

When lit for the first time, the stove will emit a slight odour for a few hours. This is a normal temporary condition caused by the curing of the logs and the "burn-in" of internal paints and lubricants used in the manufacturing process and will not occur again.

Simply open a window to sufficiently ventilate the room. After extended periods of non-operation such as following a vacation or a warm weather season, the fireplace may emit a slight odour for a few hours. This is caused by dust particles in the heat exchanger burning off. Open a window to sufficiently ventilate the room.

## FRESH AIR DAMPER SYSTEM

If your masonry fireplace is equipped with a fresh air inlet in the floor of the firebrick chamber, the insert is able to take outside air directly into the unit through an opening in its base thereby eliminating the need to use preheated room air for combustion. The flow of air may be adjusted through the use of a damper located below the louvre access door. The damper should be kept closed (pushed all the way in) when the unit is not in operation or if no outside air is available. The damper is fully open when pulled forward (one inch from the closed position).

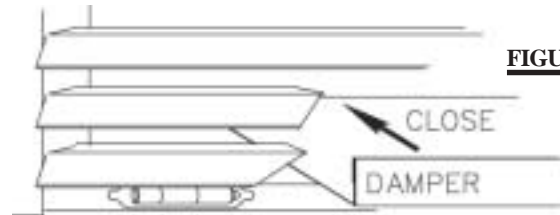

**FIGURE 22**

*Never obstruct the flow of combustion or ventilation air.*

## FOR YOUR SAFETY READ BEFORE LIGHTING:

- A** This stove has a pilot which must be lit by hand while following these instructions exactly.
- B** Before lighting, smell all around the fireplace area for gas and next to the floor because some gas is heavier than air and will settle on the floor.
- C** Use only your hand to push in or turn the gas control knob. Never use tools. If the knob will not push in or turn by hand, do not try to repair it.





Call a qualified service technician. Force or attempted repair may result in a fire or explosion.

- D** Do not use this insert if any part has been under water. Immediately call a qualified service technician to inspect the unit and replace any part of the control system and any gas control touched by water.

## WHAT TO DO IF YOU SMELL GAS:

- Do not try to light any appliance.
- Do not touch any electrical switch; do not use any phone in your building.
- Immediately call your gas supplier from a neighbour's phone. Follow the gas supplier's instructions.
- If you cannot reach your gas supplier, call the fire department.

## LIGHTING INSTRUCTIONS

- 1. Stop!** Read all the safety information above. When lighting and relighting, the gas knob cannot be turned from "pilot" to "off" unless the knob is depressed.
- 2. Turn** off all electrical power to the stove.
- 3. Turn** the gas knob  clockwise to off.
- 4. Wait** 5 minutes for any gas in the combustion chamber to escape. Continue to the next step if you do NOT smell any gas. *If you smell gas, STOP!* and follow the instructions in "What to do if You Smell Gas" listed above.
- 5. If** the unit is equipped with a flame adjustment valve, turn clockwise to off. 
- 6. Locate** the pilot situated in front of the rear log.
- 7. Turn** the gas knob counter-clockwise to  "pilot" position.
- 8. Depress** and hold the gas knob while lighting the pilot with the push button igniter. Keep the knob fully depressed for one (1) minute, then release. If the pilot does not continue to burn, repeat steps 3 through 7.
- 9. With** the pilot lit, turn the gas knob counter-clockwise  to "on" position.
- 10. If** your insert is equipped with a flame adjustment valve, push and turn the knob to "high".
- 11. If** your insert is equipped with a remote "on-off" switch, the main burner may not come on when you turn the gas valve to "on" or "high". *The remote switch must be in the "on" position as well to ignite the main burner.*
- 12. Turn** on all electrical power to the insert.

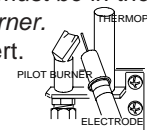
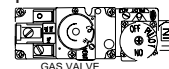

## TO TURN OFF GAS

- 1. Turn** off all electrical power to the unit if service is to be performed.
- 2. Push** in gas control knob slightly and turn clockwise to off.  **Do not force.**

## MAINTENANCE

### TURN OFF THE GAS AND ELECTRICAL POWER BEFORE SERVICING THE FIREPLACE.

**CAUTION:** Label all wires prior to disconnection when servicing controls. Wiring errors can cause improper and dangerous operation. Verify proper operation after servicing. This insert and its venting system should be inspected before use and at least annually by a qualified service person. The fireplace area must be kept clear and free of combustible materials, gasoline or other flammable vapours and liquids. The flow of combustion and ventilation air must not be obstructed.

1. In order to properly clean the burner and pilot assembly, remove the logs to expose both assemblies.
2. Keep the control compartment, logs, burner, air shutter opening and the area surrounding the logs clean by vacuuming or brushing, *at least once a year*.

3. Check to see that all burner ports are burning. Clean out any of the ports which may not be burning or are not burning properly. (right brick panel must be removed in order to facilitate burner removal)

4. Check to see that the pilot flame is large enough to engulf the thermopile on one leg and reaches toward the burner on the other leg.

5. Replace the cleaned logs.

6. Check to see that the main burner ignites completely on all openings when the gas knob for the burner is turned on. A 5 to 10 second total light-up period is satisfactory. If ignition takes longer, consult your Napoleon dealer / distributor.

7. Check that the gasketing on the door is not broken or missing. Replace if necessary.

## BLOWER REPLACEMENT INSTALLATION

### BLOWER SYSTEM

The Napoleon gas fireplace insert comes standard with a blower, a heat sensor, variable on/off speed control and a power cord. Because the blower is thermally activated, when turned on, it will automatically start approximately 15 minutes after lighting the fireplace and will run for approximately 30 minutes after the fireplace has been turned off. Use of the fan increases the output of heat. Air, drawn in through the lower louver access door, is driven up the back of the firebox, and exhausted as hot air between the upper louvers.



*Drywall dust will penetrate into blower bearings causing irreparable damage and must be prevented from coming into contact with the blower or its compartment.*

*Any damage resulting from this condition is not covered by the warranty policy.*

### BLOWER REPLACEMENT INSTRUCTIONS

- Turn off the gas and electric power to the unit.
- Remove the glass door.
- Remove the lower glass bracket.
- Remove the logs.
- Remove the burner assembly. (right brick panel must be removed in order to facilitate removal)
- Remove the four screws holding the access door in place on the control assembly (located to the back of the burner assembly.) For location, see picture in replacement parts.
- Disconnect the electrical connectors at the blower.
- Remove the blower.

## ADJUSTMENTS

### VENTURI ADJUSTMENT

Natural gas models have air shutters set at 1/16 (.063") inch open. Propane gas models have air shutters set at [5/16] (.313) inch open. Closing the air shutter will cause a more yellow flame, but can lead to carboning. Opening the air shutter will cause a more blue flame, but can cause flame lifting from the burner ports. The flame may not appear yellow immediately; allow 15 to 30 minutes for the final flame colour to be established.

**AIR SHUTTER ADJUSTMENT MUST ONLY BE DONE BY A QUALIFIED GAS INSTALLER!**

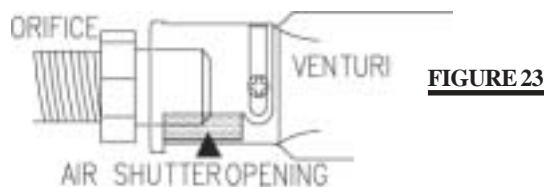

### PILOT BURNER ADJUSTMENT

1. Remove the pilot adjustment cap.
2. Adjust the pilot screw to provide properly sized flame.
3. Replace the pilot adjustment cap.

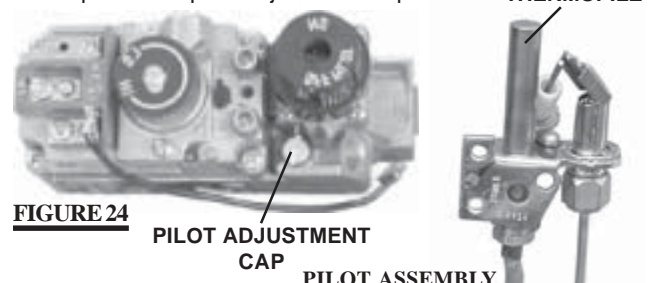

**FIGURE 25**  
FLAME MUST ENVELOPE UPPER  
3/16" TO 1/2" OF THERMOPILE

W415-0171 / D/01.06.04

# REPLACEMENTS

Contact your dealer for questions concerning prices and availability of replacement parts. Normally all parts can be ordered through your Napoleon dealer or distributor.

**FOR WARRANTY REPLACEMENT PARTS, A PHOTOCOPY OF THE ORIGINAL INVOICE WILL BE REQUIRED TO HONOUR THE CLAIM.**

**\*IDENTIFIES ITEMS WHICH ARE NOT ILLUSTRATED. FOR FURTHER INFORMATION, CONTACT YOUR NAPOLEON DEALER.**

When ordering replacement parts always give the following information:

1. MODEL & SERIAL NUMBER OF FIREPLACE
2. INSTALLATION DATE OF FIREPLACE
3. PART NUMBER
4. DESCRIPTION OF PART
5. FINISH

## REPLACEMENT PARTS

#	PART NO.	DESCRIPTION
1	GZ-551	REPLACEMENT BLOWER
2	W725-0036	NATURAL GAS VALVE C/W ADJUSTABLE REGULATOR
2	W725-0037	PROPANE GAS VALVE C/W ADJUSTABLE REGULATOR
3	W455-0004	#36 DMS NATURAL GAS BURNER ORIFICE
3	W455-0003	#54 DMS PROPANE GAS BURNER ORIFICE
3	W455-0013	#37 DMS NATURAL GAS BURNER ORIFICE - HIALT
3	W455-0002	#55 DMS PROPANE GAS BURNER ORIFICE - HIALT
4*	W660-0007	SPILL SWITCH (NATURAL GAS)
4*	W660-0006	SPILL SWITCH (PROPANE)
5	W010-0337	NATURAL GAS PILOT ASSEMBLY
5	W010-0338	PROPANE GAS PILOT ASSEMBLY
6	W357-0001	PIEZO IGNITER
7	W680-0004	THERMOPILE
8*	W690-0002	THERMAL SENSING SWITCH
9*	W660-0009	BURNER ON/OFF SWITCH
10	W135-0007	BACK LOG
11	W135-0052	FRONT LOG
12	W135-0015	RIGHT LOG
13	W135-0009	CENTER LOG
14	W135-0016	LEFT LOG
15	GL-610	LOG SET c/w CHARCOAL EMBERS
16*	W550-0001	CHARCOAL EMBERS
17	W010-0333	BURNER ASSEMBLY
18	W455-0025	NATURAL GAS PILOT INJECTOR
18	W455-0006	PROPANE GAS PILOT INJECTOR
19*	W385-0245	NAPOLEON LOGO
20*	W562-0012	DOOR GASKET (2PC - SIDE)
21	KB 35	VARIABLE SPEED SWITCH

## ACCESSORIES:

#	PART NO.	DESCRIPTION
22	GI-FF	FLUSH GLASS DOOR ASSEMBLY
23*	W300-0012	DOOR GLASS
24*	W562-0011	DOOR GASKET - TOP
25	GI-BF	BAY GLASS DOOR ASSEMBLY
26*	W010-0325	SIDE BAY DOOR GLASS -EACH C/W GASKET
27*	W010-0326	FRONT BAY DOOR GLASS C/W GASKET
28	GI-1LK	BLACK UPPER & LOWER LOUVRES
28	GI-1LPB	BLACK UPPER & POLISHED BRASS LOWER LOUVRES
28	GI-1LAB	BLACK UPPER & ANTIQUE BRASS LOWER LOUVRES
28	GI-1LSS	BLACK UPPER & BRUSHED STAINLESS STEEL LOWER LOUVRES
28	GI-1LG	GOLD PLATED UPPER & LOWER LOUVRES
29	GIB-LK	BLACK BAY LOUVRES c/w TRIM
29	GIB-LPB	POLISHED BRASS BAY LOWER LOUVRES c/w TRIM
29	GIB-LAB	ANTIQUE BRASS BAY LOWER LOUVRES c/w TRIM
29	GIB-LG	GOLD PLATED BAY LOUVRE ASSEMBLY
29	GIB-LSS	BRUSHED STAINLESS STEEL BAY LOWER LOUVRES c/w TRIM
30	GI-OIK	BLACK INSET W/ POLISHED BRASS LOWER DOOR TRIM
30	GI-OIG	GOLD PLATED ORNAMENTAL INSETS
31	GIB-OIK	BLACK BAY ORNAMENTAL INSETS c/w LOWER DOOR TRIM
31	GIB-OIG	GOLD PLATED BAY ORNAMENTAL INSETS
32	GI 778KT	BRICK PANEL KIT
33*	W470-0002	ENAMEL TOUCH UP AND BRUSH (SPECIFY COLOUR)
34	GI 700KT	ZERO CLEARANCE SHELL
35	111-KT	OUTSIDE AIR KIT
36*	W690-0001	MILLIVOLT THERMOSTAT
37*	W660-0011	REMOTE CONTROL - ADVANTAGE PLUS
38*	GD 660	WALL SWITCH/20FT WIRE
39*	W500-0033	V.S.S. MOUNTING PLATE FOR WALL SWITCH
40	GI-900AB6	ANTIQUE BRASS FLASHINGS - 6"
40	GI-900B6	POLISHED BRASS FLASHINGS - 6"
40	GI-900K6	BLACK FLASHINGS - 6"
40	GI-900AB9	ANTIQUE BRASS FLASHINGS - 9"
40	GI-900B9	POLISHED BRASS FLASHINGS - 9"
40	GI-900SS6	BRUSHED STAINLESS STEEL FLASHINGS - 6"
40	GI-900SS9	BRUSHED STAINLESS STEEL FLASHINGS - 9"
40	GI-900K9	BLACK FLASHINGS - 9"
40	GI-909S6	PORCELAIN ALMOND FLASHINGS - 6"
40	GI-909F6	PORCELAIN GREEN FLASHINGS - 6"
40	GI-909K6	PORCELAIN BLACK FLASHINGS - 6"
40	GI-909S9	PORCELAIN ALMOND FLASHINGS - 9"
40	GI-909F9	PORCELAIN GREEN FLASHINGS - 9"
40	GI-909K9	PORCELAIN BLACK FLASHINGS - 9"
41*	W175-0145	CONVERSION KIT - NAT - LP
41*	W175-0146	HIGH ALTITUDE CONVERSION KIT - NG - LP
41*	W175-0148	HIGH ALTITUDE CONVERSION KIT - NG - NG

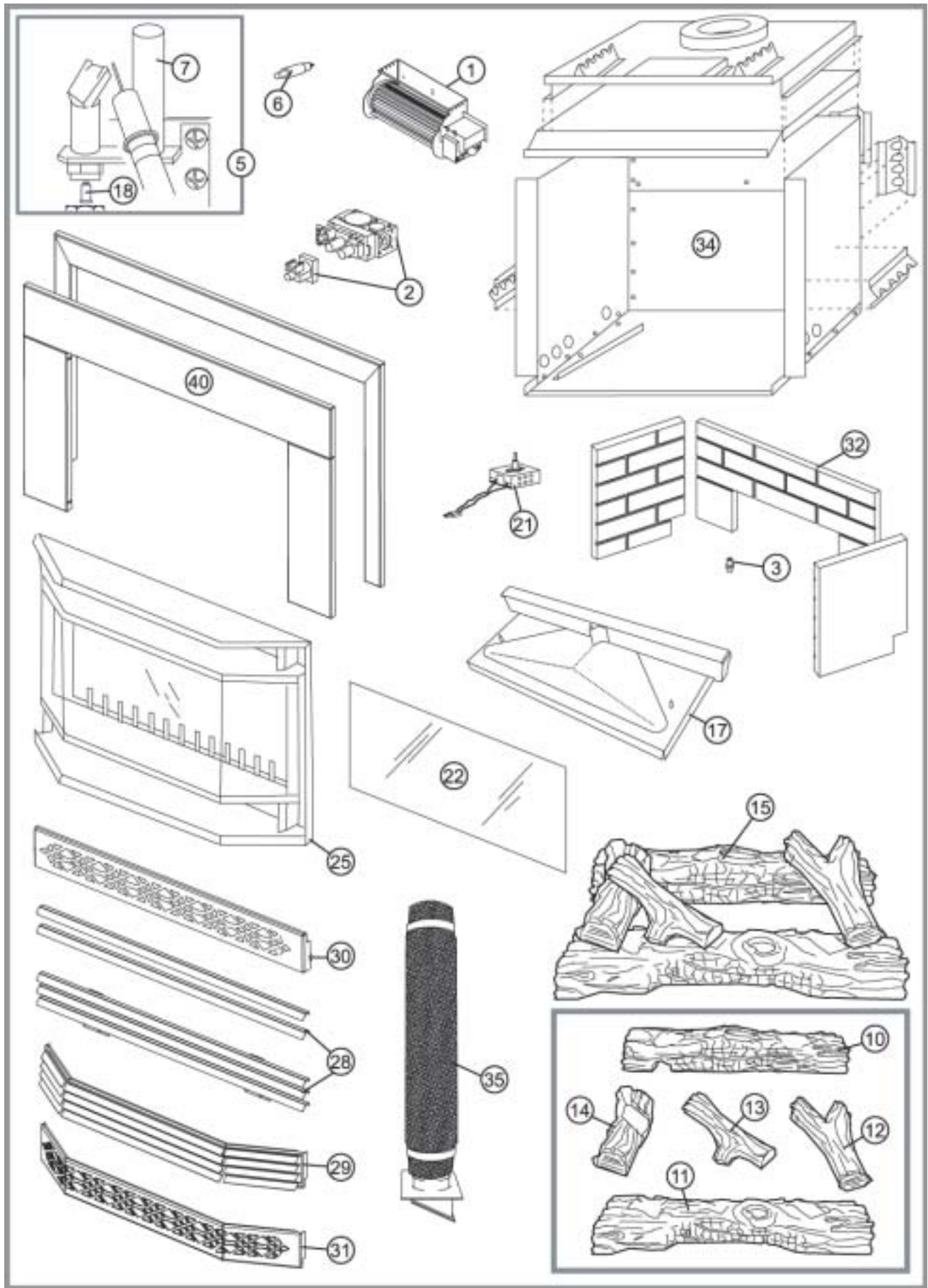

# TROUBLE SHOOTING GUIDE

BEFORE ATTEMPTING TO TROUBLESHOOT, PURGE YOUR UNIT AND INITIALLY LIGHT THE PILOT AND THE MAIN BURNER WITH THE GLASS DOOR REMOVED.

SYMPTOM	PROBLEM	TEST SOLUTION
Pilot goes out when the gas knob is released.	<b>A</b> - System is not correctly purged.	- purge the gas line with the glass door removed.
	<b>B</b> - Out of propane gas.	- fill the tank and purge the gas line with the glass door removed.
	<b>C</b> - Pilot flame is not large enough	- turn up the pilot flame.
	<b>D</b> - Pilot flame is not engulfing the thermopile.	- gently twist the pilot head to improve the flame pattern around the thermopile.
	<b>E</b> - Thermopile shorting.	- clean thermopile and valve connection. - check that thermopile insulation is not frayed and grounding out on the housing or the burner support. - replace thermopile. - replace valve.
	<b>F</b> - Faulty thermopile.	- test & replace if necessary.
	<b>G</b> - Faulty valve.	- test & replace if necessary.
Pilot burning; no gas to main burner; gas knob is on; wall switch is on; heat/flame adjustment valve is on (if so equipped).	<b>A</b> - Wall switch is defective	- connect a jumper wire across the wall switch terminals; if the main burner lights, replace the wall switch.
	<b>B</b> - Wall switch wiring is defective.	- disconnect switch wires from valve and connect a jumper wire across terminals 1 and 3; if the main burner lights, check the wires for defects and/or replace wires.
	<b>C</b> - Main burner orifice is plugged.	- remove stoppage in orifice.
	<b>D</b> - Remote gas valve operator is defective.	- connect a jumper wire across terminals 1 and 3; if main burner does not light, replace gas valve.
Pilot goes out while standing; Main burner is in 'OFF' position.	Gas piping is undersized.	- turn on all gas appliances and see if pilot flame flutters, diminishes or extinguishes, especially when main burners ignite. Monitor supply pressure. - check if supply piping size is to code. Correct all undersized piping.
Pilot will not light.	<b>A</b> - No spark at pilot burner	- check that the wire is connected to the push button ignitor. - check if the push button ignitor needs tightening. - replace pilot assembly if the wire insulation is broken or frayed. - replace pilot assembly if the ceramic insulator is cracked or broken. - replace the push button ignitor.
	<b>B</b> - Spark gap is incorrect	- spark gap should be 1/16" to 1/8" from the electrode tip and the pilot burner. Light the pilot with a match and adjust the electrode tip to the required spark gap and proper location.
	<b>C</b> - No gas at the pilot burner	- check that the manual valve is turned on. - check the pilot orifice for blockage. - replace the valve. - call the gas distributor.
	<b>D</b> - Out of propane gas	- fill the tank and purge the gas line with the glass door removed.

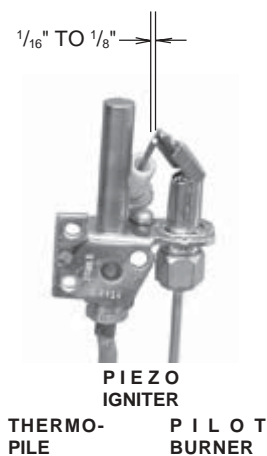

<b>SYMPTOM</b>	<b>PROBLEM</b>	<b>TEST SOLUTION</b>
Main burner goes out; pilot goes out.	<b>A</b> - Refer to "Main burner goes out; pilot stays on"	
	<b>B</b> - Chimney down-drafting	- wait ten minutes. Shut off all exhaust fans in the house (ie: kitchen and bathrooms), furnace, and clothes dryer. Open windows and/or doors. Start fireplace and monitor its operation. Close doors and windows and start appliances as before; room is in negative pressure; increase fresh air supply.
	<b>C</b> - Chimney is blocked	- check for chimney blockage.
	<b>D</b> - Liner disconnected from insert.	- re-attach liner.
	<b>E</b> - Faulty spill switch.	- replace.
Carbon is being deposited on glass, logs or combustion chamber surfaces.	Air shutter has become blocked	- ensure air shutter opening is free of lint or other obstructions.
	Flame is impinging on the logs or combustion chamber.	- check that the logs are correctly positioned. - open air shutter to increase the primary air. - check the input rate: check the manifold pressure and orifice size as specified by the rating plate values. - check that the door gasketing is not broken or missing and that the seal is tight. - check that the 4" vent liner is free of holes and well sealed at all joints. - check that minimum rise per foot has been adhered to for any horizontal venting.
Exhaust fumes smelled in room, headaches.	Fireplace is spilling.	- check for chimney blockage. - check that chimney is installed to building code. - room is in negative pressure; increase fresh air supply.
White / grey film forms.	Sulphur from fuel is being deposited on glass, logs or combustion chamber surfaces.	- clean the glass with a gas fireplace glass cleaner. DO NOT CLEAN GLASS WHEN HOT. If deposits are not cleaned off regularly, the glass may become permanently marked.
Remote wall switch is in off position; main burner comes on when gas knob is turned to "ON" position.	<b>A</b> - Wall switch is mounted upside down.	- reverse.
	<b>B</b> - Remote wall switch is grounding.	- replace.
	<b>C</b> - Remote wall switch wire is grounding.	- check for ground (short); repair ground or replace wire.
	<b>D</b> - Faulty valve.	- replace.
Main burner flame is a blue, lazy, transparent flame.	<b>A</b> - Insufficient secondary air.	- increase fresh air supply (open door, window, add make-up air supply)
	<b>B</b> - Downdraft or blockage in chimney.	- remove blockage. - check that chimney is installed to building codes (3ft above highest roof line or 2ft higher than any portion of a building within a horizontal radius of 10ft of the chimney.)
Main burner goes out; pilot stays on.	<b>A</b> - Pilot flame is not large enough or not engulfing the thermopile.	- turn on pilot flame. Gently twist the pilot head to improve the flame pattern around the thermopile.
	<b>B</b> - Thermopile shorting.	- clean thermopile and thermopile connection to valve.





## Free Manuals Download Website

<http://myh66.com>

<http://usermanuals.us>

<http://www.somanuals.com>

<http://www.4manuals.cc>

<http://www.manual-lib.com>

<http://www.404manual.com>

<http://www.luxmanual.com>

<http://aubethermostatmanual.com>

Golf course search by state

<http://golfingnear.com>

Email search by domain

<http://emailbydomain.com>

Auto manuals search

<http://auto.somanuals.com>

TV manuals search

<http://tv.somanuals.com>