

Operating Instructions

Mini DV NTSC
Digital Video Camera-Recorder

Model AG-DVC30 P

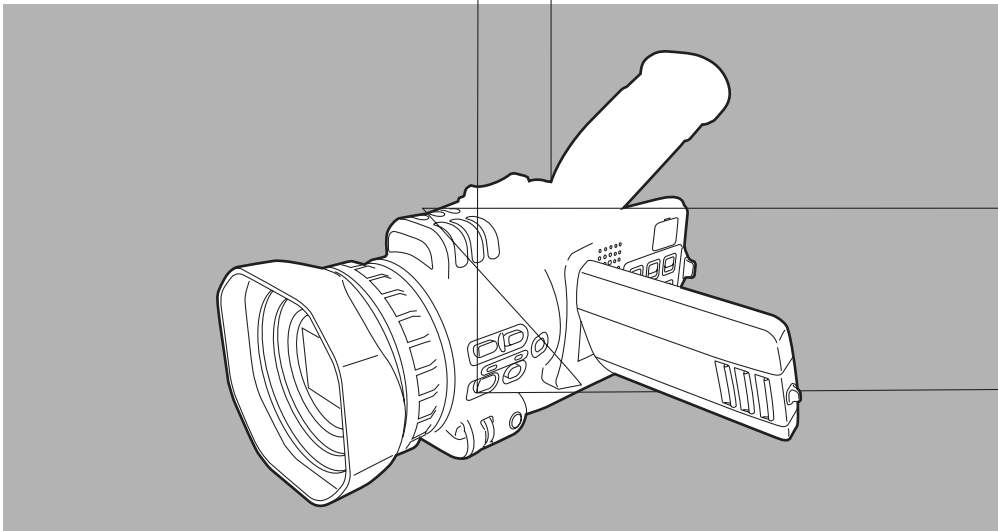

Panasonic®

Before operating this product, please read the instructions carefully and save this manual for future use.



Printed in Japan
F0204W1034

VQT0J25-1

Download from [Www.Somanuals.com](http://www.Somanuals.com). All Manuals Search And Download.

BEFORE USE

DESCRIPTION
OF PARTS

PREPARATION

SHOOTING

PLAYBACK

EDITING

DISPLAYS

MENUS

TROUBLE-
SHOOTING

SPECIFI-
CATIONS,
OTHER

IMPORTANT

“Unauthorized recording of copyrighted television programs, video tapes and other materials may infringe the right of copyright owners and be contrary to copyright laws.”



CAUTION

RISK OF ELECTRIC SHOCK
DO NOT OPEN



CAUTION: TO REDUCE THE RISK OF ELECTRIC SHOCK, DO NOT REMOVE COVER (OR BACK). NO USER SERVICEABLE PARTS INSIDE. REFER TO SERVICING TO QUALIFIED SERVICE PERSONNEL.



The lightning flash with arrowhead symbol, within an equilateral triangle, is intended to alert the user to the presence of uninsulated “dangerous voltage” within the product’s enclosure that may be of sufficient magnitude to constitute a risk of electric shock to persons.



The exclamation point within an equilateral triangle is intended to alert the user to the presence of important operating and maintenance (service) instructions in the literature accompanying the appliance.

WARNING:

TO REDUCE THE RISK OF FIRE OR SHOCK HAZARD, DO NOT EXPOSE THIS EQUIPMENT TO RAIN OR MOISTURE.

TO REDUCE THE RISK OF FIRE OR SHOCK HAZARD, KEEP THIS EQUIPMENT AWAY FROM ALL LIQUIDS-USE AND STORE ONLY IN LOCATIONS WHICH ARE NOT EXPOSED TO THE RISK OF DRIPPING OR SPLASHING LIQUIDS, AND DO NOT PLACE ANY LIQUID CONTAINERS ON TOP OF THE EQUIPMENT.

CAUTION:

TO REDUCE THE RISK OF FIRE OR SHOCK HAZARD AND ANNOYING INTERFERENCE, USE THE RECOMMENDED ACCESSORIES ONLY.

CAUTION:

Do not install or place this unit in a bookcase, built-in cabinet or any other confined space in order to maintain adequate ventilation. Ensure that curtains and any other materials do not obstruct the ventilation to prevent risk of electric shock or fire hazard due to overheating.

CAUTION:

THE AC OUTLET (MAINS SOCKET) SHALL BE INSTALLED NEAR THE EQUIPMENT AND SHALL BE EASILY ACCESSIBLE.

CAUTION:

TO PREVENT ELECTRIC SHOCK, MATCH WIDE BLADE OF PLUG TO WIDE SLOT, FULLY INSERT.

FCC Note:

This equipment has been tested and found to comply with the limits for a class A digital device, pursuant to Part 15 of the FCC Rules. These limits are designed to provide reasonable protection against harmful interference when the equipment is operated in a commercial environment. This equipment generates, uses, and can radiate radio frequency energy and, if not installed and used in accordance with the instruction manual, may cause harmful interference to radio communications. Operation of this equipment in a residential area is likely to cause harmful interference in which case the user will be required to correct the interference at his own expense.

Warning:

To assure continued FCC emission limit compliance, the user must use only shielded interface cable when connecting to external units. Also, any unauthorized changes or modifications to this equipment could void the user’s authority to operate it.

CAUTION:

Danger of explosion or fire if battery is mistreated.

- Replace only with same or specified type.
- Do not disassemble or dispose of in fire.
- Do not store in temperatures over 140°F (60°C).
- Use specified charger for rechargeable batteries.
- Do not recharge the battery if it is not a rechargeable type.

For Remote Controller

- Replace battery with part No. CR2025 only.
- Do not recharge the battery.

Notice (U.S.A.only):

This product has a fluorescent lamp that contains a small amount of mercury. It also contains lead in some components. Disposal of these materials may be regulated in your community due to environmental considerations.

For disposal or recycling information please contact your local authorities, or the Electronics Industries Alliance:

<<http://www.eiae.org.>>

Camera-Recorder

- The rating plate is on the underside of the Camera-Recorder

AC Adapter

- The rating plate is on the underside of the AC Adapter.
- Disconnect the AC mains plug from the AC mains socket when not in use.

 indicates safety information.

Important Safeguards

1. Read Instructions — All the safety and operating instructions should be read before the unit is operated.
2. Retain Instructions — The safety and operating instructions should be retained for future reference.
3. Heed Warnings — All warnings on the unit and in the operating instructions should be adhered to.
4. Follow Instructions — All operating and maintenance instructions should be followed.
5. Cleaning — Unplug this video unit from the wall outlet before cleaning. Do not use liquid or aerosol cleaners. Use a dry cloth for cleaning.
6. Attachments — Do not use attachments not recommended by the video product manufacturer as they may be hazardous.
7. Water and Moisture — Do not use this video unit near water — for example near a bath tub, wash bowl, kitchen sink, or laundry tub, in a wet basement, or near a swimming pool, and the like.
8. Accessories — Do not place this video unit on an unstable cart, stand, tripod, bracket, or table. The video unit may fall, causing serious injury to a child or adult, and serious damage to the unit. Use only with a cart, stand, tripod, bracket, or table recommended by the manufacturer, or sold with the video unit. Any mounting of the unit should follow the manufacturer's instructions and should use a mounting accessory recommended by the manufacturer.
An appliance and cart combination should be moved with care. Quick stops, excessive force, and uneven surfaces may cause the appliance and cart combination to overturn.
9. Ventilation — Slots and openings in the cabinet are provided for ventilation and to ensure reliable operation of the video unit and to protect it from overheating. These openings must not be blocked or covered. Never place the video unit on a bed, sofa, rug, or other similar surface, or near or over a radiator or heat register. This video unit should not be placed in a built-in installation such as a bookcase or rack unless proper ventilation is provided or the manufacturer's instructions have been adhered to.
10. Power Sources — This video unit should be operated only from the type of power source indicated on the marking label. If you are not sure of the type of power supply to your home, consult your appliance dealer or local power company. For video units intended to be operated from battery power, or other sources, refer to the operating instructions.
11. Grounding or Polarization — This video unit may be equipped with either a polarized 2-wire AC (Alternating Current) line plug (a plug having one blade wider than the other) or 3-wire grounding type plug, a plug having a third (grounding) pin.
The 2-wire polarized plug will fit into the power outlet only one way. This is a safety feature. If you are unable to insert the plug fully into the outlet, try reversing the plug. If the plug still fails to fit, contact your electrician to replace your obsolete outlet. Do not defeat the safety purpose of the polarized plug.
The 3-wire grounding type plug will fit into a grounding type power outlet. This is a safety feature. If you are unable to insert the plug into the outlet, contact your electrician to replace your obsolete outlet. Do not defeat the safety purpose of the grounding type plug.
12. Power-Cord Protection — Power-supply cords should be routed so that they are not likely to be walked on or pinched by items placed upon or against them, paying particular attention to cords of plugs, convenience receptacles, and the point where they exit from the unit.



Important Safeguards

13. Outdoor Antenna Grounding — If an outside antenna or cable system is connected to the video unit, be sure the antenna or cable system is grounded so as to provide some protection against voltage surges and built-up static charges. Part 1 of the Canadian Electrical Code, in USA Section 810 of the National Electrical Code, provides information with respect to proper grounding of the mast and supporting structure, grounding of the lead-in wire to an antenna discharge unit, size of grounding conductors, location of antenna discharge unit, connection to grounding electrodes, and requirements for the grounding electrode.

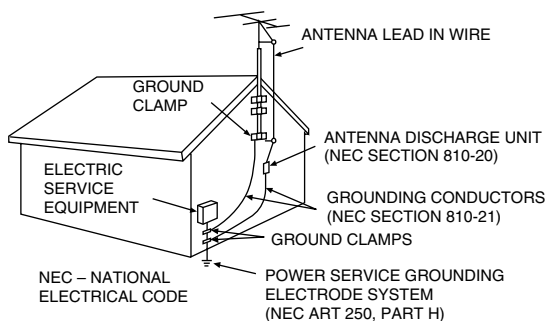

14. Lightning — For added protection of this video unit receiver during a lightning storm, or when it is left unattended and unused for long periods of time, unplug it from the wall outlet and disconnect the antenna or cable system. This will prevent damage to the video unit due to lightning and power-line surges.

15. Power Lines — An outside antenna system should not be located in the vicinity of overhead power lines or other electric light or power circuits, or where it can fall into such power lines or circuits. When installing an outside antenna system, extreme care should be taken to keep from touching such power lines or circuits as contact with them might be fatal.

16. Overloading — Do not overload wall outlets and extension cords as this can result in a risk of fire or electric shock.

17. Objects and Liquids — Never push objects of any kind into this video unit through openings as they may touch dangerous voltage points or short out parts that could result in a fire or electric shock. Never spill liquid of any kind onto the video unit.

18. Servicing — Do not attempt to service this video unit yourself as opening or removing covers may expose you to dangerous voltage or other hazards. Refer all servicing to qualified service personnel.

19. Damage Requiring Service — Unplug this video unit from the wall outlet and refer servicing to qualified service personnel under the following conditions:

- When the power-supply cord or plug is damaged.
- If any liquid has been spilled onto, or objects have fallen into the video unit.
- If the video unit has been exposed to rain or water.
- If the video unit does not operate normally by following the operating instructions. Adjust only those controls that are covered by the operating instructions, as an improper adjustment of other controls may result in damage and will often require extensive work by a qualified technician to restore the video unit to its normal operation.
- If the video unit has been dropped or the cabinet has been damaged.
- When the video unit exhibits a distinct change in performance – this indicates a need for service.

20. Replacement Parts — When replacement parts are required, be sure the service technician has used replacement parts specified by the manufacturer or have the same characteristics as the original part. Unauthorized substitutions may result in fire, electric shock or other hazards.

21. Safety Check — Upon completion of any service or repairs to this video unit, ask the service technician to perform safety checks to determine that the video unit is in safe operating order.

FCC Warning: Any unauthorized changes or modifications to this equipment would void the user's authority to operate.

Read this first!

Always take some trial shots before actual shooting.

When shooting important events (such as weddings), always take some trial shots and check that the sound and images have been recorded properly before actual shooting.

Remember to check the settings especially when you intend to use special effects or backlight compensation.

Panasonic makes no guarantees for your recordings.

Please understand that Panasonic makes no guarantees for your recordings in cases where images and/or sound were not recorded as you intended due to problems with the camera-recorder or cassette.

Respect copyrights

Copyright laws forbid the use of video and audio material you have recorded for any purpose other than your own personal enjoyment. Remember that restrictions apply to the shooting of certain material even it is intended for private use.

Caution concerning illustrations in these instructions

- Note that all illustrations (camera-recorder, menu screens, etc.) in these operating instructions will differ slightly from the actual camera-recorder.
- If the operations described can be performed using either the camera-recorder or the remote control unit, an illustration of the remote control unit is shown alongside.

Reference pages

Reference pages are indicated as (P00).

Usable cassette tapes

Digital video cassette tapes with the ^{Mini}**DV** mark can be used with this camera-recorder.

Contents

BEFORE USE

Accessories	8
Operating precautions	9
Storage precautions	11
Checking the system operations	12
Getting ready	12
Connecting the power cord	12
Inserting the cassette tape	13
Turning on the power	13
Shooting	14
Checking what you have shot (rec check)	14
Removing the tape	15
Turning off the power	15
Disconnecting the power cord	15
Adjusting the hand strap	16
Attaching the handle	16
Attaching the large eye-cup	16
Attaching the shoulder strap	17
Lens hood	18
Cassette tapes	18

DESCRIPTION OF PARTS

Camera-recorder	19
Wireless remote control unit	22

PREPARATION

Battery	23
Charging	23
Mounting	24
Removing	24
Remote control unit	25
Installing the battery	25
Setting the remote control unit	25
Viewfinder	26
Using the viewfinder	26
Using the LCD monitor	26
Adjusting the screen display	27
Time data	29
Adjusting the calendar	29
Charging the internal battery	30
Setting the user's bit	31
Setting the time code	33
Specifying the time code	33

SHOOTING

Regular shooting	35
Preparation and inspections	35
Shooting	35
Shooting techniques for different targets	36
Low-angle shooting	36
Searching specific scenes (image search)	36
Zoom functions	36
Self-portrait shooting	37
Recording the time stamp	37
High-sensitivity shooting (SNS)	37
Vibration reduction function	38
Wind noise reduction	38
Movie-like shooting	38
Photo shots	39
Color bars	39
Zebra pattern	39
Markers	39
Field and frame shooting	40
Frame-by-frame shooting	40
Changing the image size	40
Using the USER buttons	41
One-touch zooming	41
Backlight compensation function	41
AE lock function	41
Index recording	41
Backup recording	42
Switching to manual mode	42
Focusing	42
Shutter speed, iris and gain adjustments	43
Shutter speed adjustment	43
Iris and gain adjustments	44
White balance adjustments	45
Auto white balance	45
Setting the white balance	45
Adjusting the white balance manually	46
Audio level adjustments	47
Adjusting the mic input audio level	47
Adjusting the headphone volume	48

PLAYBACK

Normal playback49
Playing back a tape49
Adjusting the volume50
Connecting a TV to view images50
Checking the shooting date and time50
Variable-speed playback51
Slow playback51
Still-picture playback51
Frame-feed playback51
Cue and review51
Search functions52
Variable-speed search52
Blank search52
Index search53
Counter54
Counter display54
Counter memory function54

EDITING

Connecting external units55
Headphones55
Digital video equipment55
TV set56
Video deck56
External microphone (connected to phono jack)57
External microphone (connected to XLR connector)57
Audio dubbing58
Dubbing60
Analog input60
Analog output61
Digital input/output62

DISPLAYS

Screen displays63
Displays in CAMERA and VCR modes63
In VCR mode only66
Warnings66
Using the MODE CHK button67
Setting the DISPLAY items67

MENUS

Menu operations68
Setting the menu mode68
Selecting the main items69
Selecting the sub items69
Entering the settings70
Setting other sub items71
Returning to the main item screen71
Setting other main items71
Releasing the menu mode71
Initializing the menu settings71
Menu configuration72
CAMERA mode menu72
VCR mode menu72
SCENE FILE screen73
CAMERA SETUP screen73
PLAYBACK FUNCTION screen74
SW MODE screen75
RECORDING SETUP screen76
AV IN/OUT SETUP screen78
DISPLAY SETUP screen78
OTHER FUNCTIONS screen79

TROUBLESHOOTING

Before calling for service81
Power supply81
Battery81
Normal video recording81
Other types of video recording82
Editing82
Displays82
Playback (images)82
Playback (sound)83
Other83

SPECIFICATIONS, OTHER

Condensation84
Tally lamp84
System resetting84
Cleaning the video heads85
Maintenance cautions85
Specifications86

- "LEICA" is a registered trademark of Leica Microsystems IR GmbH.
 - "DICOMAR" is a registered trademark of Leica Camera AG.
- Other names, company names or product names mentioned in these instructions are the trademarks or registered trademarks of the companies concerned.

Accessories

Battery (*)

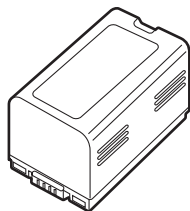

Handle

(VYH0312)

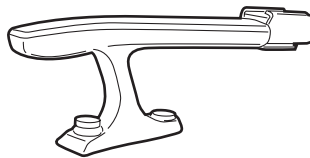

AC adapter (*)

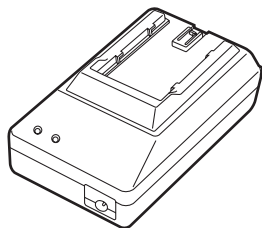

Shoulder strap

(VFC3891)

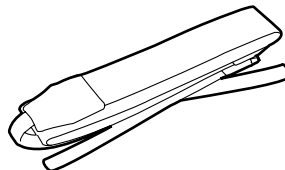

AC cord

(K2CB2CB00006)

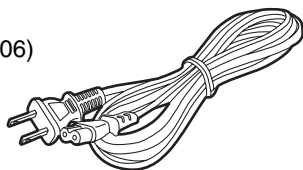

Mini DV cassette tape

(AY-DVM63MQ)

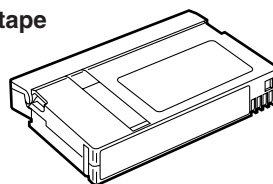

DC cord

(K2GJ2DC00002)

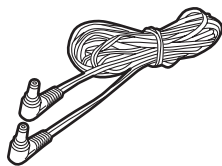

AV cable

(K2KC4CB00009)

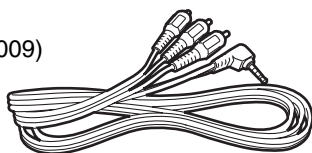

Wireless remote control

(VFA0402)

Button battery

(CR2025)

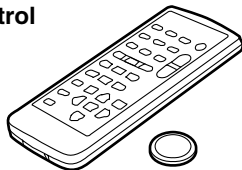

Eye-cup (large)

(VMG1370)

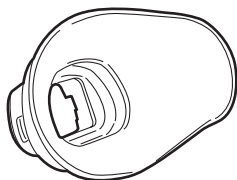

*: For the battery and AC adapter model numbers, refer to the "Optional peripheral units" section. (P87)

Operating precautions

Do not allow any water to get into the camera-recorder when using it in the rain or snow or at the beach.

- Failure to heed this caution will cause the camera-recorder or cassette to malfunction (and may result in irreparable damage).

Keep the camera-recorder away from equipment (such as TV sets and video game machines) that generate magnetic fields.

- Using the camera-recorder on top of or near a TV set may cause distortion in the images and/or sound due to the electromagnetic waves that the set emits.
- The powerful magnetic fields generated by speakers or large motors may damage your tape recordings or distort the images.
- The electromagnetic waves emitted from a microcomputer will adversely affect the camera-recorder, causing the images and/or sound to be distorted.
- If the camera-recorder is so adversely affected by products that generate magnetic fields that it no longer operates properly, turn it off and remove the battery or unplug the AC adapter from the power outlet. Then install the battery again or re-connect the AC adapter. After this, turn the camera-recorder back on.

Do not use the camera-recorder near radio transmitters or high-voltage equipment.

- Using the camera-recorder near a radio transmitter or high-voltage equipment may adversely affect the recorded images and/or sound.

Do not allow any sand or dust to get into the camera-recorder when using it at the beach and other similar places.

- Sand and dust can damage the camera-recorder and cassette. (Be especially careful when inserting or removing the cassettes.)

AC adapter and battery

- If the battery has become extremely hot or cold or if it has not been used for a long time and has no charge, the CHARGE lamp will blink several times and charging will start automatically.
- If the CHARGE lamp continues to blink even when the battery temperature is normal, it may mean that something is wrong with the battery or AC adapter. Consult your dealer.

- When the battery is warm, it will take longer to charge than normal.
- When the AC adapter is used near a radio, the sound from the radio may be distorted. Keep the AC adapter at least a yard away from the radio.
- Noise may be heard while the AC adapter is being used; however, this is not a sign of malfunctioning.

Do not drop the camera-recorder while carrying it.

- Strong impact may damage the camera-recorder to the extent that it will no longer operate properly.
- When carrying the camera-recorder around, use the hand strap, handle or shoulder strap, and remember to handle it carefully.

Do not expose the camera-recorder to insect sprays or volatile substances.

- Contact with insect sprays or volatile substances may distort the shape of the camera-recorder and/or cause its finish to peel off.
- Do not leave the camera-recorder in contact with rubber or PVC products for extended periods of time.

After use, always remove the cassette and remove the battery or unplug the AC cord from the power outlet.

- If the cassette is left inside the camera-recorder, the tape may become slack or damaged.
- Leaving the battery on the camera-recorder for an extended period may cause the battery voltage to drop excessively, and it may not be possible to re-use it even after charging it.

Operating precautions (cont.)

Battery characteristics

This camera-recorder uses a rechargeable lithium-ion battery that uses its internal chemical reaction to generate electrical energy. This reaction is easily influenced by the ambient temperature and humidity, and the battery's effective operating time is reduced as the temperature rises or falls. When the battery is used in an environment where the temperature is very low, it will not allow more than 5 minutes of operation.

If you let the battery get very hot, its protection function will be triggered, which will make it unusable for some time.

Always remove the battery after use.

If it is left inside, a small amount of current will be consumed even while the camera-recorder's power is off. Also, if it is left inside for an extended period, the battery may become over-discharged and it may not be possible to re-use it even after charging it.

To dispose of an unusable battery

- The battery has a definite service life.
In order to protect valuable natural resources, do not throw away a battery which you no longer need. Take it to a store that participates in the recycling of rechargeable batteries.

Protect the battery's terminal area.

Keep the battery's terminal area free of dust and other foreign matter. If a battery has been dropped, check whether its body or terminal area has been bent out of shape.

Attempting to install an out-of-shape battery in the camera-recorder or mounting it in the AC adapter may damage the camera-recorder or AC adapter.

Liquid crystal displays

- If the same image or characters are left displayed on the LCD monitor or viewfinder for an extended period, they may become burned onto the screen. However, if the power is kept off for several hours, the screen will return to normal.
- The liquid crystal parts are manufactured using high-precision technology. More than 99.99% of the pixels are effective, which means that less than 0.01% of the pixels are missing or permanently lighted. Missing or lighted pixels are not a sign of malfunctioning and have no effect at all on the images which are recorded.
-

Mounting the camera-recorder on a tripod

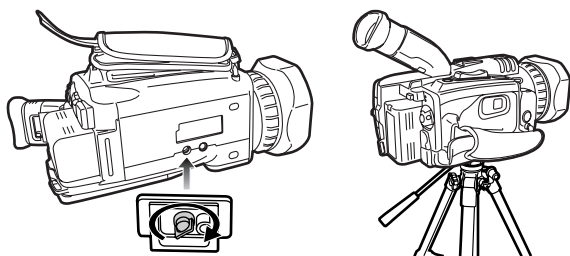

Camera mounted on a tripod
(1/4-20UNC type of screw)

The depth of the tripod mounting hole is 5.5 mm.

When mounting this camera-recorder on a tripod, do not force the screw beyond this depth.

Note that if you use any screw other than a 1/4-20UNC type you could damage the camera-recorder.

Storage precautions

Before storing the camera-recorder, remove both the cassette and battery. Store all of these items in a place with a low humidity and relatively constant temperature.

Recommended temperature range:

59°F to 77°F (15°C to 25°C)

Recommended relative humidity:

40% to 60%

Camera-recorder

Wrap the camera-recorder in a soft cloth to keep the dust off.

Battery

- The battery life is shortened in places which are very hot or cold.
- Storing the battery in a location with oily vapors or high dust concentrations may corrode the terminals, cause other damage and lead to malfunctioning.
- **Keep metal objects (such as necklaces and hairpins) away from the battery. Short-circuiting may occur across the terminals, causing the battery to heat up, and you may seriously burn yourself if you touch the battery in this state.**
- The battery should be discharged for storage. When storing it for an extended time, we recommended that at least once a year you charge it, use up its charge by operating the camera-recorder, and then store it again.

Cassette tapes

- Always rewind your tapes to the start before storing them. If a cassette that has been stopped part the way through is left standing for six months or more (this timeframe differs depending on the storage conditions), the tape will become slack.
- Always put tapes back into their original cases before storing them as factors such as dust, direct sunlight (ultraviolet rays) and humidity may damage the tapes. Dust contains particles of hard minerals which may damage the camera-recorder's heads and other parts if they get inside the cassette.
- Fast forward and rewind your tapes once every six months. If tapes are kept wound up for more than a year, the expansion and contraction caused by changes in the temperature and humidity may distort the tapes. Also, parts of the tape may get stuck together.
- Do not place cassettes near equipment or anything else with strong magnetic fields.
- The top surface of tapes is coated with microscopically small magnetic particles where the signals are recorded. Magnetic necklaces, toys and other products may have a stronger magnetic field than you might suspect: they may be strong enough to erase recordings and generate noise on the screen and in the sound.

1

Shooting

- 1 Set the AUTO/MANUAL selector switch to AUTO.

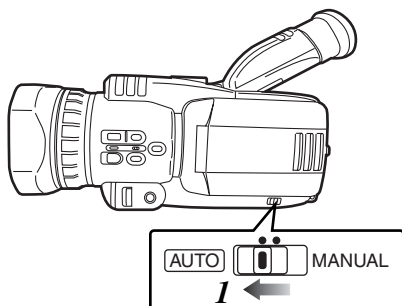

- 2 Squeeze both sides of the lens cap and remove it.

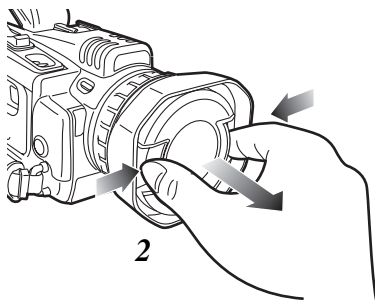

- 3 Look through the viewfinder and check what you want to shoot.

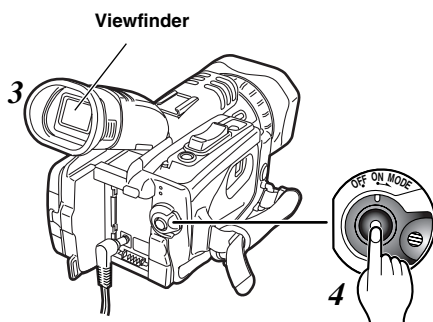

- 4 Shooting starts when you press the START/STOP (red) button on the POWER lever. Press this button again to pause shooting (shooting pause mode).

Checking what you have shot (rec check)

- 1 Open the LCD monitor while holding down the panel locking button. The LCD monitor can be opened to a maximum angle of 90°. Forcing it past this point will damage the camera-recorder.

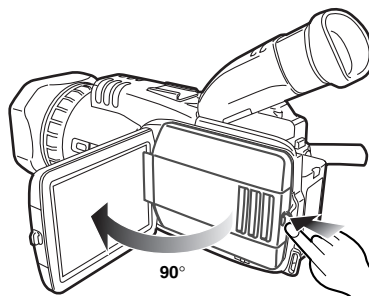

- 2 In the shooting pause mode, press the ◀◀ button. The last two or three seconds of the scenes you have shot are now played back. After playback, the shooting pause mode is restored.

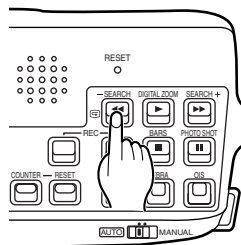

You can conduct an image search (P36) by holding down the ◀◀ button in the shooting pause mode. Do not hold down the ◀◀ button when conducting a rec check.

Tape protection mode

If you leave the camera-recorder in the shooting pause mode for 5 minutes or so, the camera-recorder will automatically switch to the tape protection mode and its power will turn off.

However, when "STBY" has been selected as the TAPE PROTECT item setting on the OTHER FUNCTIONS screen using the menus (P68-P71), the cylinder head will stop instead of the power being turned off. (P80)

Checking the system operations (cont.)

Removing the tape

- 1 Slide the OPEN/EJECT lever in the direction of the arrow, and open the cassette cover. When the cover is fully opened, the cassette holder pops out automatically.

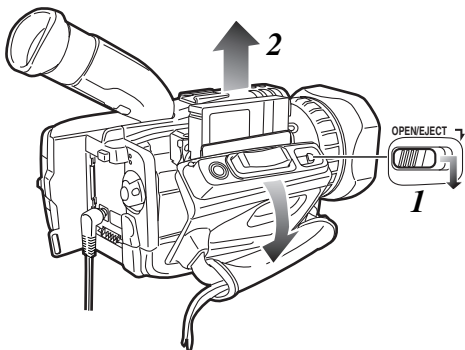

- 2 Take out the cassette tape.
- 3 Press the part marked "PUSH" and close the cassette holder.

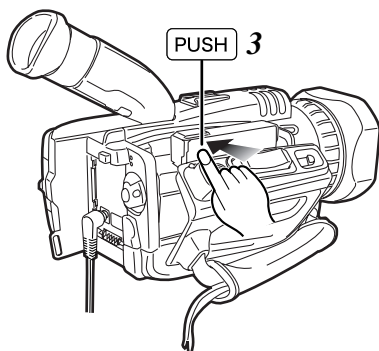

- 4 Close the cassette cover after the cassette holder has been completely retracted.

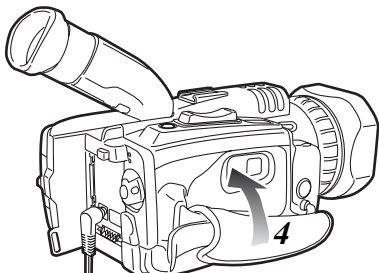

- Check that the camera-recorder's power is on before sliding the OPEN/EJECT lever.
- Close the cassette cover if you are not going to insert a cassette tape immediately after removing another.
- Do not attempt to remove a tape while you are recording. The cassette cover opens but recording will continue, allowing outside light and dust to adversely affect the tape.

Turning off the power

- CAMERA
- VCR
- POWER



Hold down the white button and turn the POWER lever to the OFF position. The power is now turned off, and the CAMERA lamp goes off.

Disconnecting the power cord

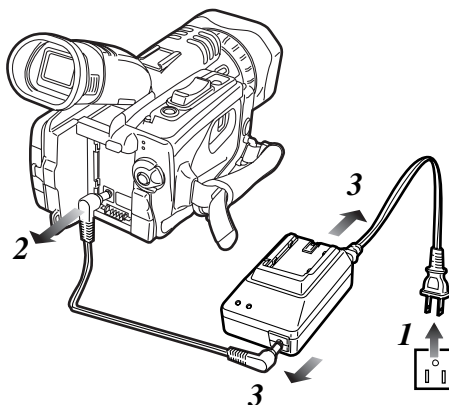

- 1 Disconnect the AC cord from the power outlet.
- 2 Disconnect the DC cord from the DC input socket.
- 3 Disconnect the DC cord and AC cord from the AC adapter.

Adjusting the hand strap

Adjust the hand strap to fit your hand.

1 Open the cover and adjust the strap length.



Attaching the shoulder strap

We recommended that you attach the shoulder strap to help you avoid dropping the camera-recorder.

BEFORE USE

When the handle is not attached

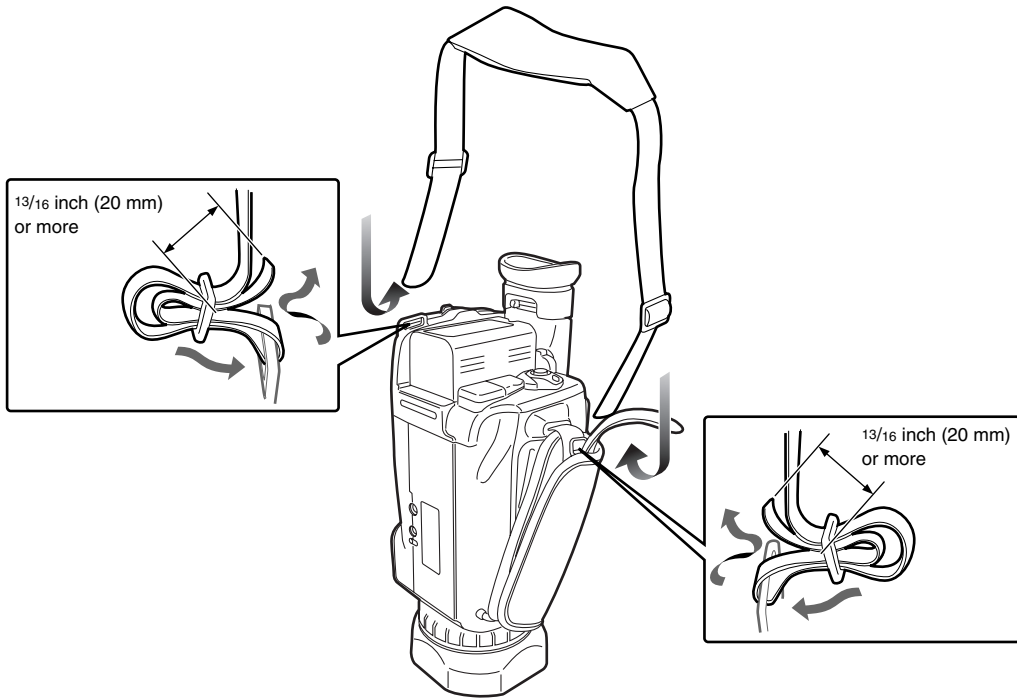

When the handle is attached

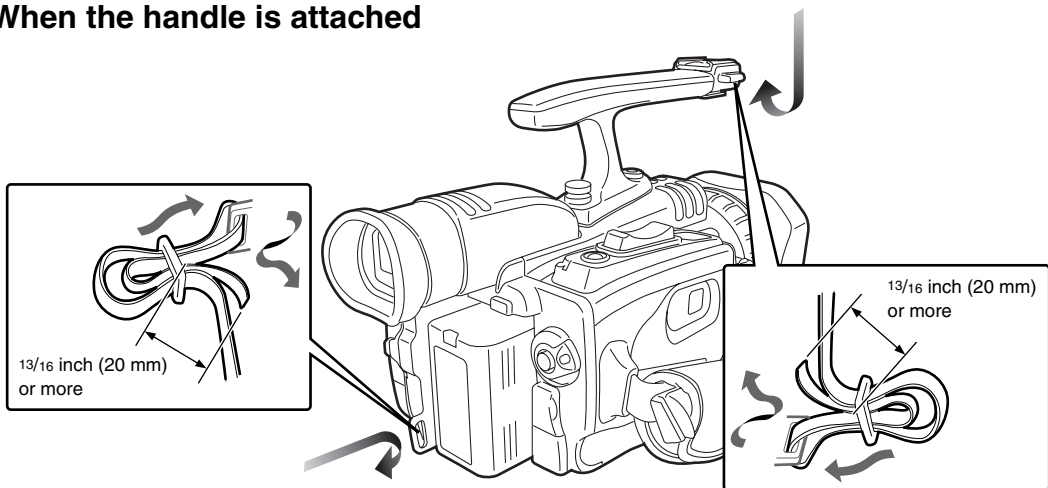

Lens hood

Removing the lens hood

- Turn the lens hood counterclockwise to remove it.

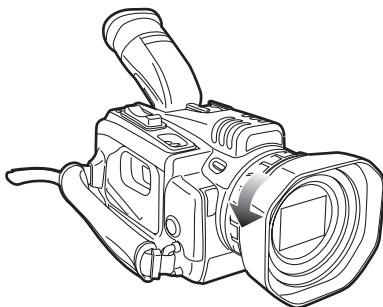

Attaching the lens hood

- Make sure that the larger flat part of the lens hood is pointing upward, then fit it into place.
- Turn the lens hood clockwise to attach it.

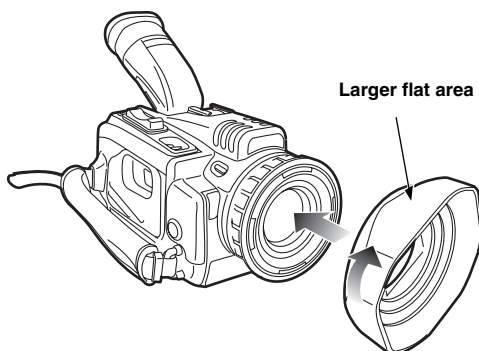

Cassette tapes

- We recommend that you use the following mini DV cassette tapes with this camera-recorder.

AY-DVM30 (30 minutes in SP mode)

AY-DVM60 (60 minutes in SP mode)

- Although the picture quality of material shot in the LP mode is not bad, mosaic-like noise may appear, limitations may apply to some of the memory functions and/or regular playback may not be possible when:
 - a tape shot in the LP mode using this camera-recorder is played back in another digital video unit;
 - a tape shot in the LP mode using another digital video unit is played back in this camera-recorder;
 - a tape shot in the LP mode using this camera-recorder is played back in another digital video unit that does not have an LP mode capability;
 - slow or frame-feed playback is performed; or
 - an image search is conducted
- Audio dubbing cannot be performed in the LP mode as the tracks on the tape are narrower than the heads.

Preventing accidental erasure

To prevent erasing the recordings on a tape by accident, set the tab on the cassette to SAVE.

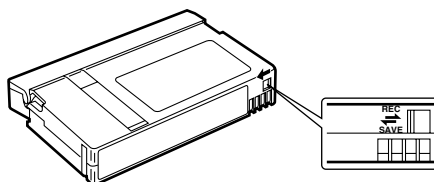

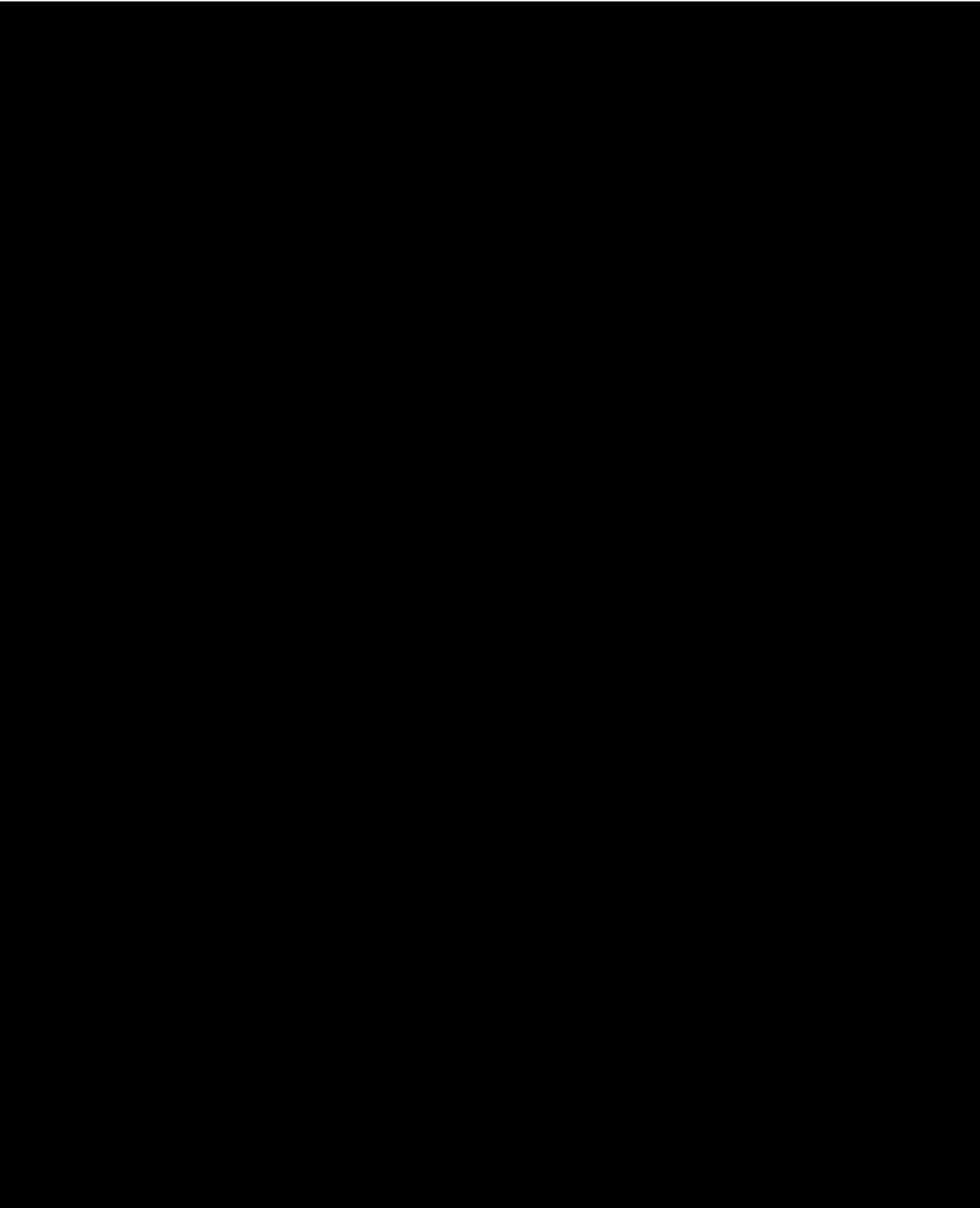

Camera-recorder

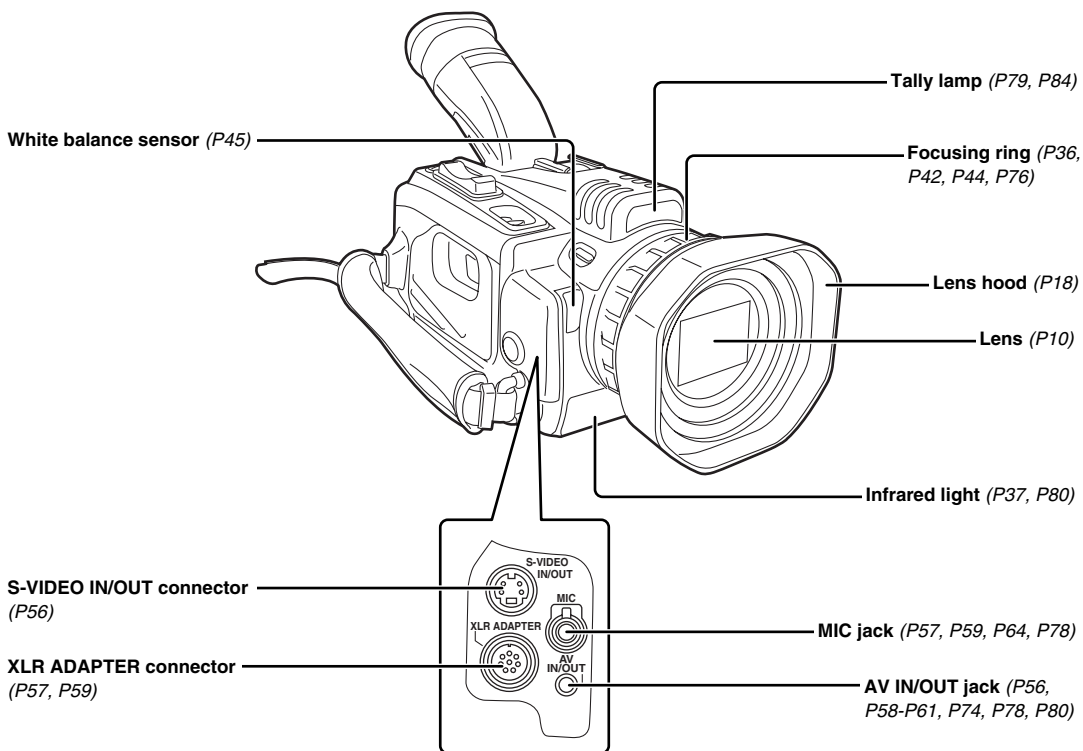

Description of parts (cont.)

Camera-recorder

DESCRIPTION OF PARTS

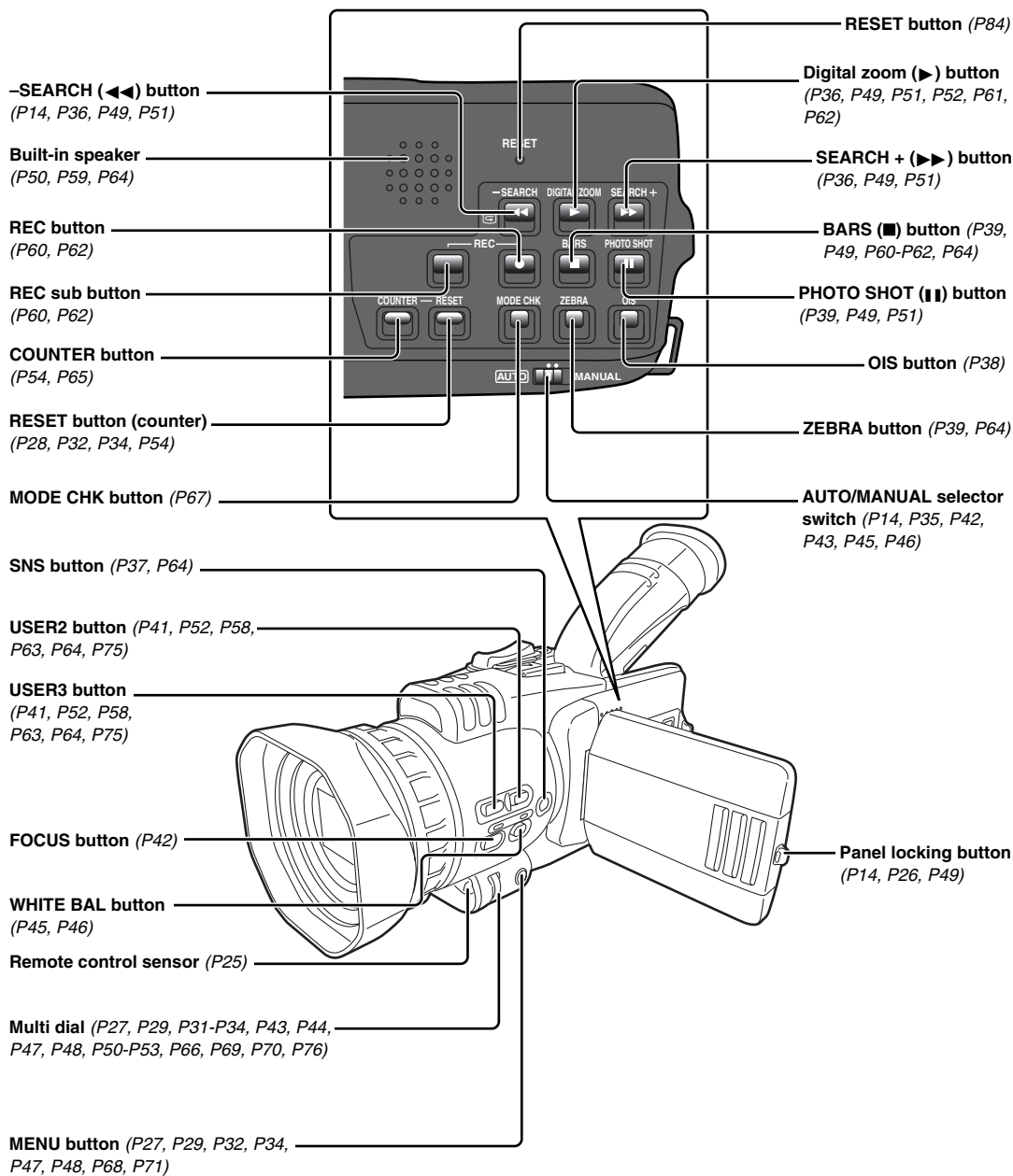

Wireless remote control unit

Note that the following buttons are for functions that cannot be executed on the camera-recorder.

- TITLE
- SELECT
- OFF/ON
- ◀
- MULTI/P-IN-P
- STORE
- PB. ZOOM

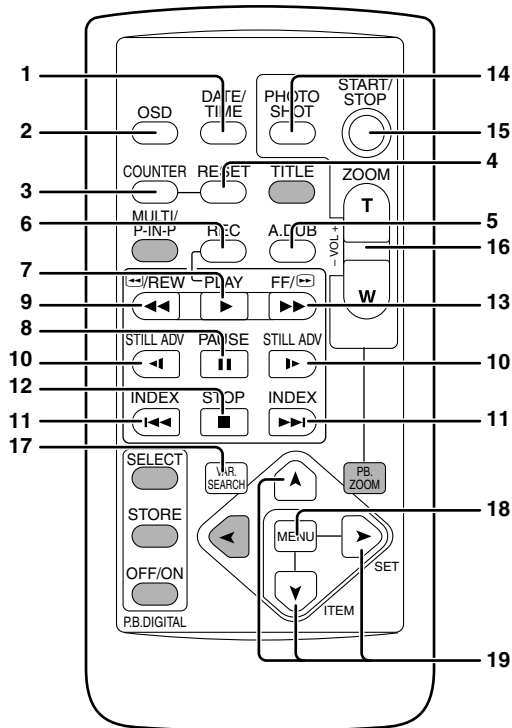

1. DATE/TIME button (P50)
2. OSD button (P50)
3. COUNTER button (P54)
4. RESET button (counter) (P28, P32, P34, P54)
5. A.DUB button (P58)
6. REC button (P60, P62)

<Playback controls>

7. PLAY button (▶) *1 (P49, P51, P52, P60-P62)
8. PAUSE button (||) *1 (P49, P51, P58)
9. ◀◀/REW button (◀◀) *1 (P36, P49, P54)
10. STILL ADV button (◀, ▶) (P25, P51)
11. INDEX button (◀◀, ▶▶) (P53, P74)
12. STOP button (■) *1 (P25, P49, P60-P62)
13. FF/▶▶ button (▶▶) *1 (P36, P49, P54)

*1: During playback, these buttons function in exactly the same way as the corresponding buttons on the camera-recorder.

<Shooting/volume controls>

14. PHOTO SHOT button *2 (P39)
 15. START/STOP button *2 (P35)
 16. ZOOM/VOL buttons *2 (P50)
- *2: During shooting, these buttons function in exactly the same way as the corresponding buttons on the camera-recorder.
17. VAR.SEARCH button (P52)
 18. MENU button (P27, P29, P31, P32, P34, P47, P48, P68, P71)
 19. [▲][▼], [▶] buttons (P27, P29, P31-P34, P47, P48, P52, P53, P69, P70)

Battery (cont.)

Mounting

1 Raise the viewfinder.

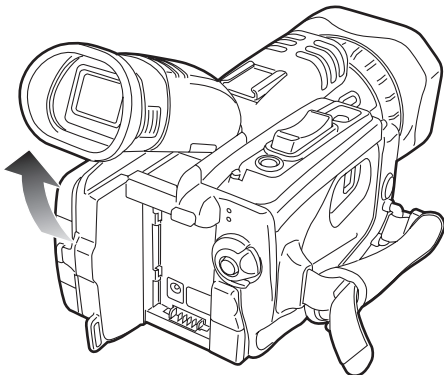

2 Press the battery straight against the camera-recorder body and slide it down until it clicks into place.

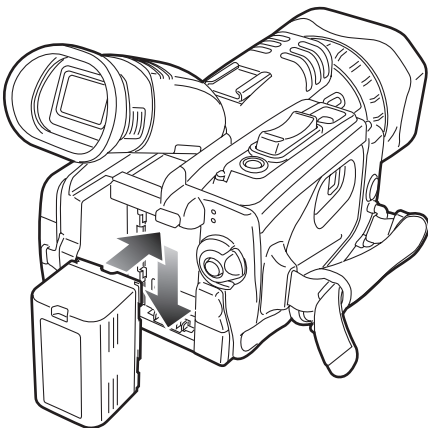

3 Return the viewfinder to its original position.

Removing

- Turn the POWER lever to the OFF position, check that the POWER lamp (CAMERA/VCR) has gone off, and then remove the battery.
- Support the battery with your hand so that it does not drop off.

To remove the battery, hold down the battery release button and slide it up.

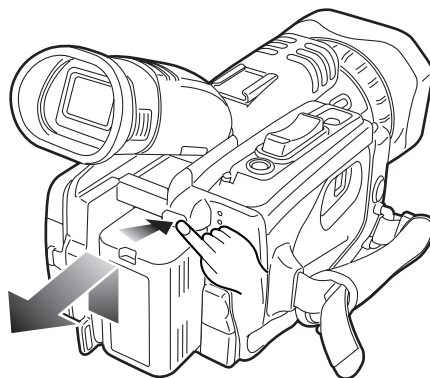

Installing the battery

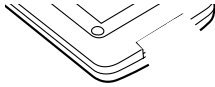

Setting the remote control unit

When two camera-recorders are used simultaneously, either [VCR1] or [VCR2] can be set for this camera-recorder and the wireless remote control unit so that the remote control unit will not be used to operate the wrong camera-recorder by mistake.

- The remote control sensor used for this is located at the lower side of the lens on the camera recorder. Point the wireless remote control unit towards the sensor when operating the camera-recorder with it.

Setting procedure

- Wireless remote control unit
Press the STOP (■) and STILL ADV (▶) buttons at the same time to set the remote control unit for use with VCR1. Alternatively, press the STOP (■) and STILL ADV (◀) buttons at the same time to set the remote control unit for use with VCR2.
When the battery in the remote control unit is replaced, the remote control unit is set for use with VCR1.

- Camera-recorder
Use the menus (P68-P71) to set the REMOTE item on the OTHER FUNCTIONS screen. (P79)

If different settings are used for the camera-recorder and remote control unit, "REMOTE" will light up in red on the viewfinder and LCD monitor.

Viewfinder

This camera-recorder offers a choice of viewfinders: a viewfinder with a small LCD screen and one with a 3.5-inch LCD monitor.

Use the viewfinder that best suits the application and shooting conditions.

- The brightness and hue may differ between the images appearing on the viewfinder and LCD monitor and those displayed on a TV monitor.

To see how the final images will appear, check them on a TV monitor.

Using the viewfinder

- 1 Set the POWER lever to the ON position, and check that images appear in the viewfinder.

- Keep the LCD monitor closed.



- 2 Adjust the viewfinder's angle so that the screen is positioned where it is easiest to see.

- 3 Adjust the diopter adjustment lever so that the characters on the viewfinder screen are seen most clearly.

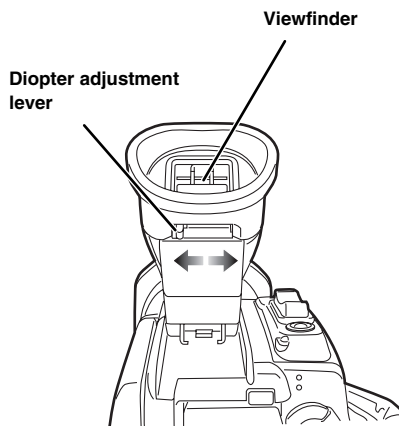

Do not point the viewfinder at the sun.
Doing so may damage the parts inside.

Using the LCD monitor

- 1 Set the POWER lever to the ON position.

- 2 Open the LCD monitor while holding down the panel locking button.

The LCD monitor can be opened to a maximum angle of 90°.

Forcing it past this point will damage the camera-recorder.

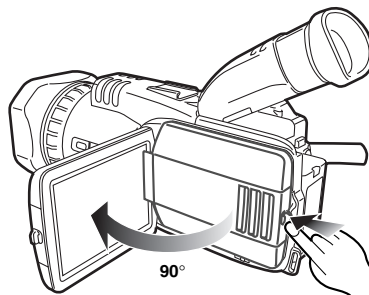

- 3 Position the LCD monitor where it is easiest to see.

- The monitor can be rotated by 180 degrees toward the lens and 90 degrees toward you.

Forcing the monitor beyond these angles or attempting to close the monitor while it has been rotated by 90 degrees will damage the camera-recorder.

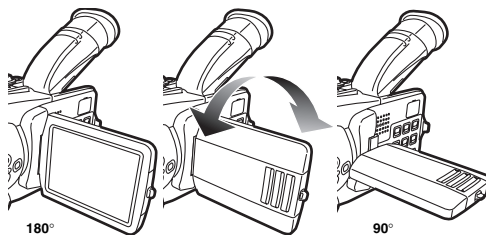

- When closing the LCD monitor, ensure that it is closed securely.
- When the LCD monitor is rotated toward the lens (for self-portrait shooting), the viewfinder and LCD monitor will light up at the same time.

Adjusting the screen display

- 1 Use the menus (P68-P71) to select “YES” as the LCD/EVF SET item setting on the DISPLAY SETUP screen.

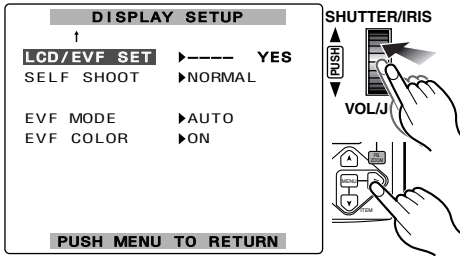

- 2 The LCD/EVF SET screen with “LCD BRIGHTNESS” selected appears. Turn the multi dial to adjust the brightness of the LCD monitor screen.

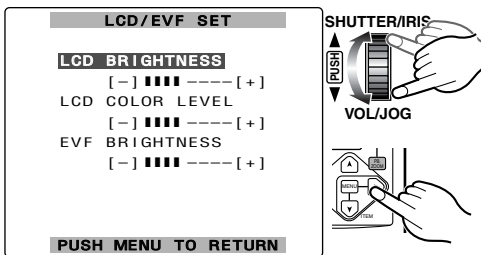

- 3 Upon completion of the settings, press the multi dial to select “LCD COLOR LEVEL.”

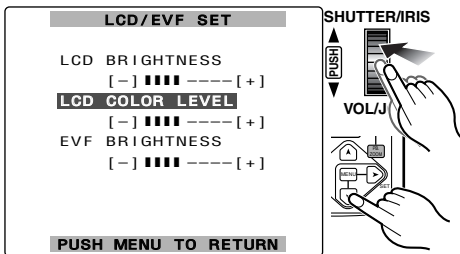

- 4 Turn the multi dial to adjust the color level of the LCD monitor screen.

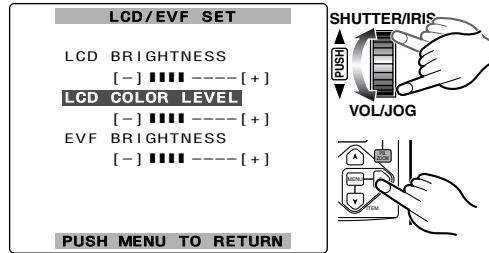

- 5 Upon completion of the settings, press the multi dial to select “EVF BRIGHTNESS.”

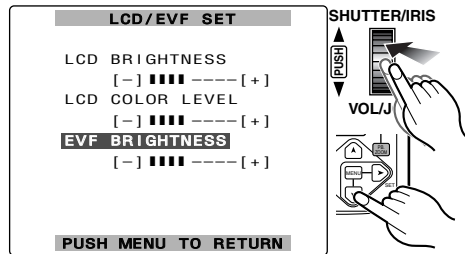

- 6 Turn the multi dial to adjust the brightness of the viewfinder screen.

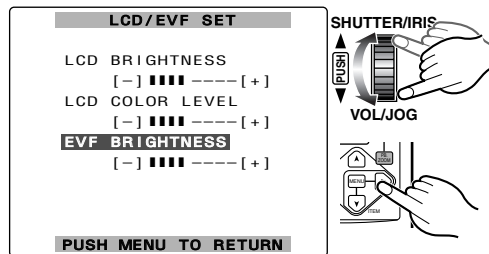

- 7 Press the MENU button three times to exit the menu mode.

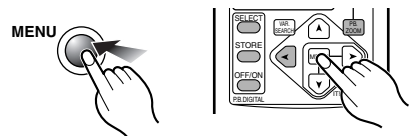

When the [▶] button on the remote control unit is used to make adjustments, the level meter reading starts changing in the opposite direction once it has reached the maximum (or minimum) position.

Adjusting the screen display

- If the RESET button (counter) is pressed when it is possible to change the settings by selecting the LCD/EVF SET item, the values set for those items (LCD BRIGHTNESS and COLOR LEVEL, and EVF BRIGHTNESS) can be returned to the factory settings.

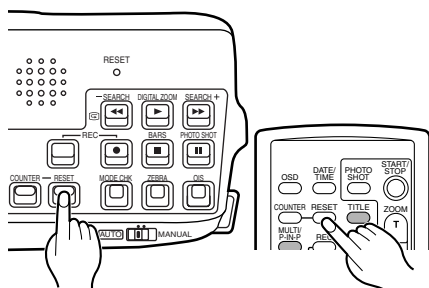

- When "ON" is selected as the setting for the EVF MODE item on the DISPLAY SETUP screen, the images will always be displayed on the viewfinder even if the LCD monitor is open. (P79)
- Using the EVF COLOR item on the DISPLAY SETUP screen, either color or black and white can be selected for displaying the viewfinder images. (P79)
No matter whether color or black and white is selected, the images will have the same resolution.
- When you press the USER button to which the EVF DTL function has been allocated, the contours of the images in the viewfinder and LCD monitor are emphasized, making it easier to bring the subject into focus. (P75)
Note that the contours of the images will still be emphasized to make focusing easier even if "ON" has been selected as the EVF DETAIL item setting on the DISPLAY SETUP screen. (P79)

Time data

Adjusting the calendar

This shows you how to adjust the calendar to **5:20 PM on December 25, 2004.**

1 Set the POWER lever to the ON position.

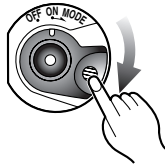

2 Use the menus (*P68-P71*) to select “YES” as the CLOCK SET item setting on the OTHER FUNCTIONS screen.

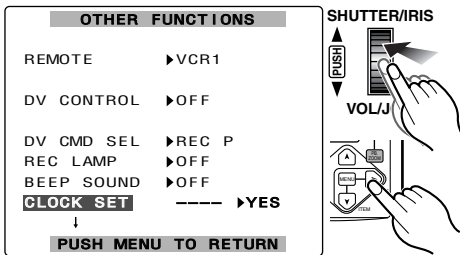

3 The CLOCK SET screen with “YEAR” selected appears. Turn the multi dial to set **2004.**

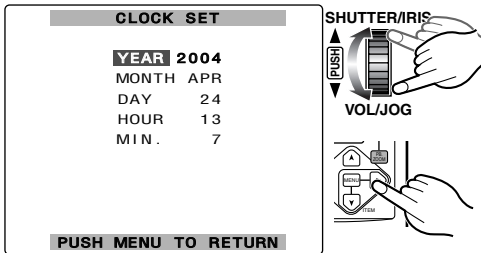

Any year from 2000 to 2089 can be set.

4 Press the multi dial to move the setting item to “MONTH.”

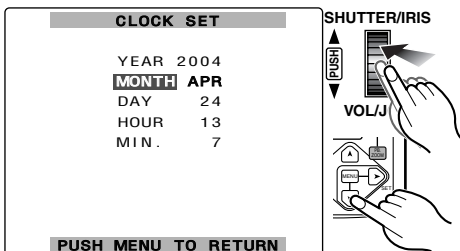

5 Turn the multi dial to set **DEC.**

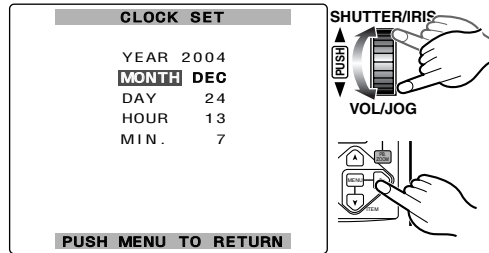

JAN (January), FEB (February), MAR (March), APR (April), MAY (May), JUN (June), JUL (July), AUG (August), SEP (September), OCT (October), NOV (November), DEC (December)

6 In the same way, use the multi dial to set **25** for “DAY,” **17** for “HOUR” and **20** for “MIN.”

- The 24-hour system is used for the time.

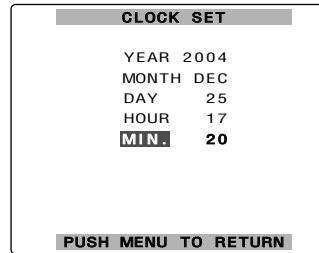

7 Press the MENU button three times to exit the menu mode.

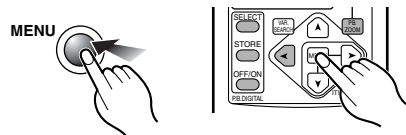

An error will gradually develop in the time, so check that the time is correct before shooting.

Charging the internal battery

The calendar data (year/month/day/hours/minutes) is kept in the memory by the internal battery.

When the “” display appears on the viewfinder and LCD monitor screen, it means that the battery has run out.

Follow the steps below to charge the battery.

Set the date and time after the battery is fully recharged.

- 1** Connect the AC adapter to the camera-recorder. (P12)
 - Keep the LCD monitor closed.
- 2** Leave the POWER lever at the **OFF** position.
- 3** Leave the camera-recorder like this for about 4 hours.
 - The internal battery is charged during this time.

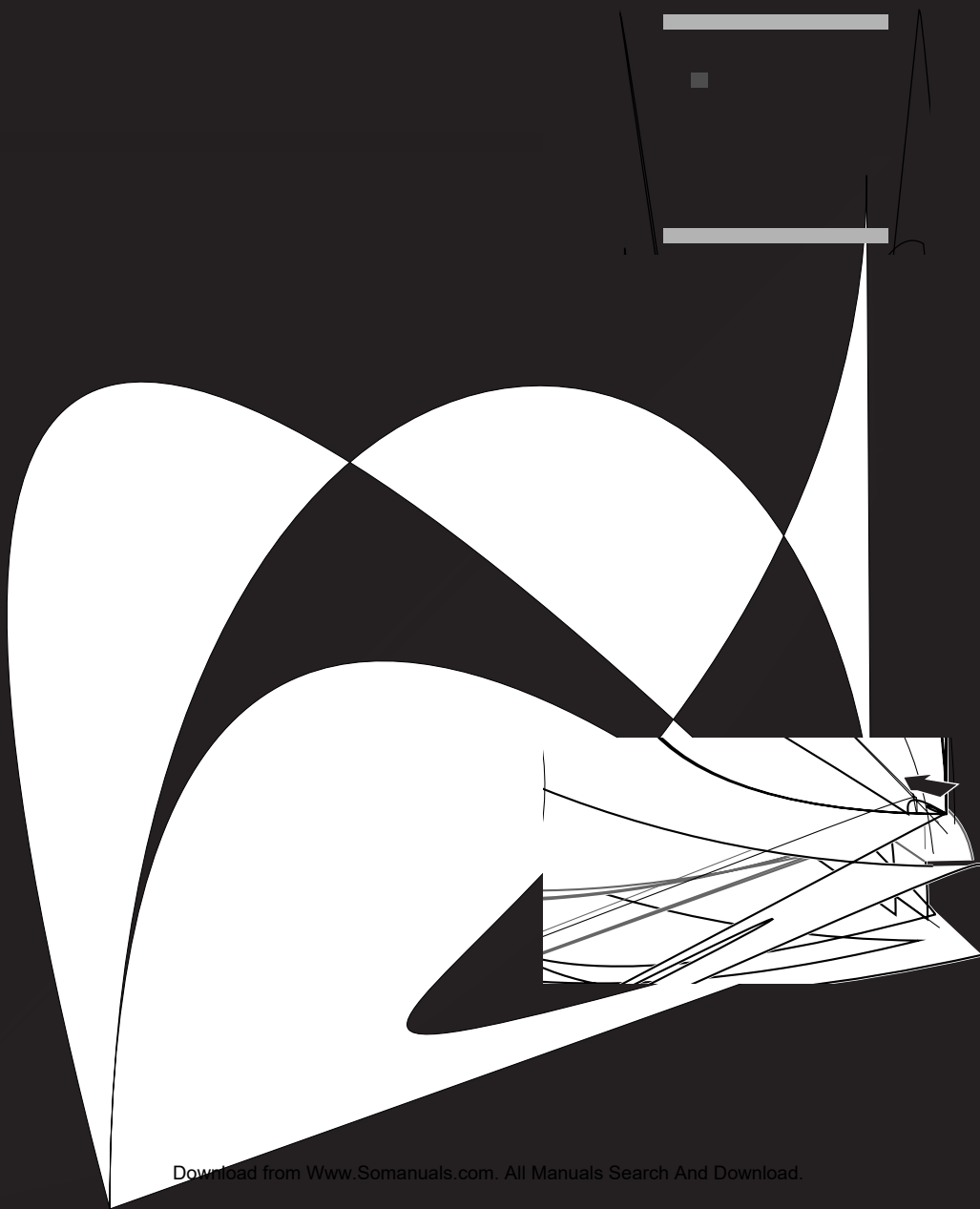

Setting the user's bit

- 7 The screen shown below appears. Turn the multi dial to select "YES."

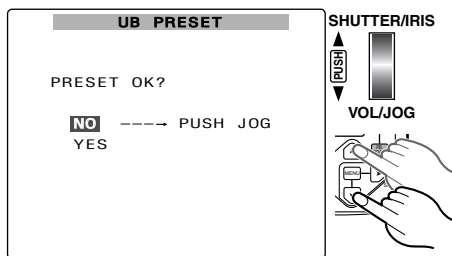

- 8 The user's bit is entered when the multi dial is pressed.

Setting the time code

Perform the settings related to the time code using the items below on the RECORDING SETUP screen. (P76, P77)

- TCG
- FIRST REC TC
- TC PRESET
- 1394 TC REGEN (the menu items appear in the VCR mode)

- In the VCR mode, the settings of the items listed here cannot be changed if “ON” has been selected as the 1394 TC REGEN item setting.

Specifying the time code

You can record a value of your choice as the initial setting for the time code to be used at the start of recording.

- 1 Set the POWER lever to the ON position.



- 2 Use the menus (P68-P71) to select “PRESET” as the FIRST REC TC item setting on the RECORDING SETUP screen.

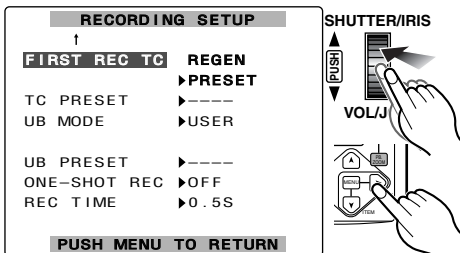

- 3 Turn the multi dial to move to the TC PRESET item.

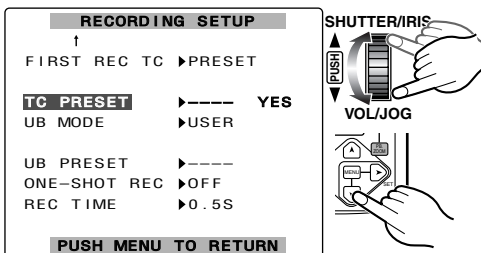

- 4 Press the multi dial to move ► to “YES.”

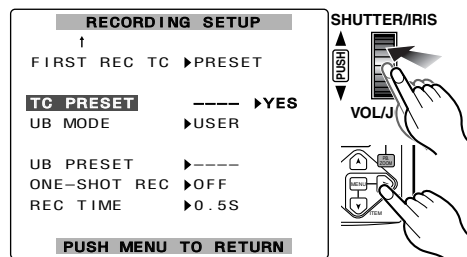

- 5 The screen shown below appears. Use the multi dial to set the time code.

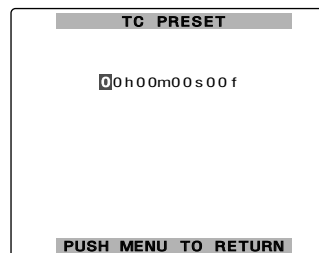

Turn the multi dial to specify the time code.

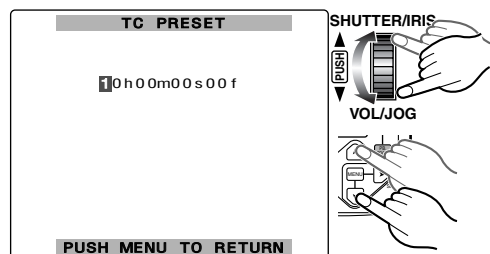



Regular shooting

Preparation and inspections

Before shooting, check that the camera-recorder is operating properly. Check the equipment as warranted by the shooting conditions.

■ Battery (P23)

Have a fully charged battery ready. We also recommend that you keep a spare battery on hand.

■ Cassette tape (P13, P18)

Check that the cassette tape can be used for recording:

- Is the cassette's accidental erasure prevention tab not set to the SAVE position?
- Is there not already any important material on the tape?
- Is the cassette cover closed securely?

■ Viewfinder (P26)

Check whether the viewfinder's diopter adjustment has been made.

■ Zoom/focus/iris

- Check that motor-driven zooming is possible. (P36)
- Check that the focusing can be performed both automatically and manually. (P42)
- Check that the lens iris operations can be performed automatically and manually. (P44)

■ Time data (P29-P34)

- Check that the calendar and time have been set correctly.
- Check that the time code and user's bit have been set correctly.

Shooting

1 Set the AUTO/MANUAL selector switch to the AUTO position.

2 Squeeze both sides of the lens cap and remove it.

3 Look through the viewfinder and check what you want to shoot.

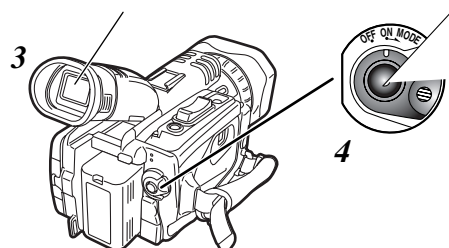

4 Shooting starts when you press the START/STOP (red) button on the POWER lever. Press this button again to pause shooting (shooting pause mode).

Shooting techniques for different targets

Low-angle shooting

For shooting at a low angle, you can attach the accessory handle (P16) and use the START/STOP button on the lens.

The recording operation of this button can be set using the FRONT S/S INHIBIT item on the SW MODE screen. (P76)

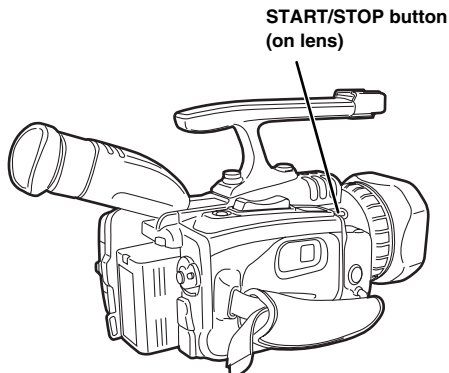

Searching specific scenes (image search)

To check what you have shot straight away, conduct a rec check (P14).

To find specific scenes among the ones that you have shot so far, conduct an image search while the shooting pause mode is established.

Image search comes in handy when you want to continue shooting from a particular scene you have found (shooting with frame-to-frame continuity).

1 In the shooting pause mode, hold down the **▶▶** or **◀◀** button.

While the button is held down, the tape is played back in the forward or reverse direction.

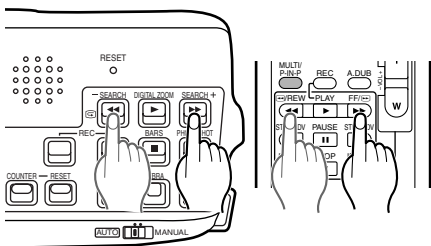

2 When you have found the scene you are looking for, release the button.

Upon completion of the image search, operation returns to the shooting pause mode.

Zoom functions

This camera-recorder comes with a $\times 16$ optical zoom. Press the ZOOM buttons gently for slow zooming; press them more forcefully for fast zooming.

The zoom speed resulting when the buttons are pressed gently can be set using the ZOOM MODE item (P76) on the SW MODE screen.

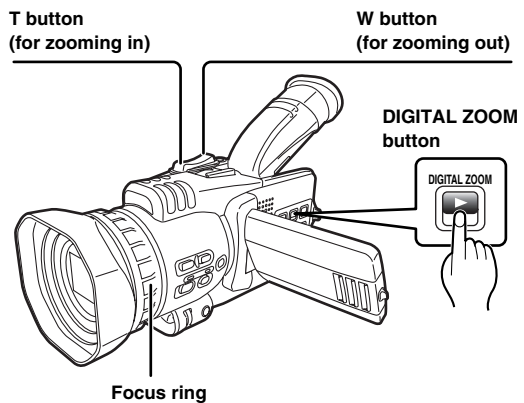

The digital zoom function is made operational by pressing the DIGITAL ZOOM button in the shooting pause mode.

When " $\times 24$ " is selected as the D.ZOOM item (P76) setting on the SW MODE screen, the digital zoom function works at the following magnification levels each time this button is pressed: $\times 1.25$ \blacktriangleright $\times 1.5$ \blacktriangleright $\times 1$ (OFF). Zooming at a maximum level of $\times 24$ is possible at this setting.

If, on the other hand, " $\times 160$ " is selected as the item's setting, the digital zoom function works at the following magnification levels each time this button is pressed: $\times 2$ \blacktriangleright $\times 5$ \blacktriangleright $\times 10$ \blacktriangleright $\times 1$ (OFF). Zooming at a maximum level of $\times 160$ is possible at this setting.

The zoom position is displayed at all times at the top right of the screen, and the magnification level of the digital zoom also appears when the digital zoom function is working. (P65)

- The magnification level cannot be changed during shooting.
- When shooting with the digital zoom function, you cannot obtain the same image quality as you can with normal (optical) zooming.

When "ZOOM" has been selected as the FOCUS RING item setting on the SW MODE screen using the menus (P68-P71), zooming operations can be performed using the focus ring but only when shooting in the auto focus mode. (P76)

Shooting techniques for different targets (cont.)

Self-portrait shooting

When the LCD monitor is opened and turned 180 degrees toward the lens to take shots of yourself, the images shot may appear differently from how you would normally.

When "MIRROR" has been selected as the SELF SHOOT item setting on the DISPLAY SETUP screen using the menus (P68-P71), an image with the left and right sides reversed will appear on the LCD monitor. This way, it feels as if you were looking at yourself in a mirror, which makes it easier to check what you are shooting. (P79)

However, even if you take self-portrait shots in the mirror mode, the images recorded on the tape will be exactly like the ones you would normally shoot (i.e. not mirror images).

When shooting in the mirror mode, the information displayed on the viewfinder and LCD monitor is limited to the following.

- : Shooting
- || : Shooting pause
- ▣ : Remaining battery charge
- ! : Warning

If [!] is displayed, return the LCD monitor to its original position, and check the contents of the warning.

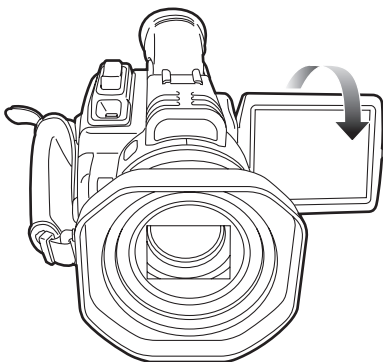

Recording the time stamp

By selecting "REC" as the TIME STAMP setting on the RECORDING SETUP screen using the menus (P68-P71), the shooting date and time can be superimposed on the images shot and recorded on the tape. (P76)

When "REC" is selected as the TIME STAMP item setting, [R] appears on the screen.

- The time stamp cannot be recorded when "×160" has been selected as the D.ZOOM item setting on the SW MODE screen. (P76)
- When the audio level is adjusted (P47, P48) during actual shooting, the time stamp recording will be suspended while the adjustments are being made.

High-sensitivity shooting (SNS)

This camera-recorder comes with a high-sensitivity shooting function to enable shooting in very dark places.

You can shoot scenes in three high-sensitivity shooting modes, which you could not capture using a regular camera, by combining the light in the infrared ray region (IR light) with the shutter speed.

Press the SNS button for high-sensitivity shooting.

Switch back to regular shooting by pressing the SNS button again.

The high-sensitivity shooting modes are selected using the SNS item on the SW MODE screen. (P76)

- High-sensitivity shooting cannot be performed during regular shooting even by pressing the SNS button. Temporarily stop shooting first, and then press the SNS button.

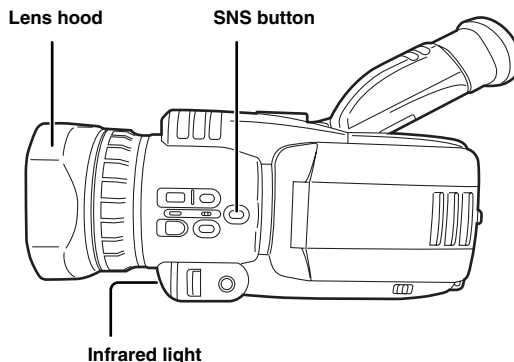

High-sensitivity shooting mode	IR light	Shutter speed	Recorded image
IR	Lighted	1/60 sec.	Black and white
SUPER_IR		1/4 sec.	
COLOR_NS	Off		Color

SNS: Super Night Shooting system

Shooting techniques for different targets (cont.)

- The aperture (IRIS) cannot be adjusted with the multi dial in the IR and SUPER_IR modes; however, both the aperture and gain can be adjusted in the COLOR_NS mode. (P44)
- You can change the lighting control of the IR light using the IR LED item on the OTHER FUNCTIONS screen. (P80)
- Do not look directly at the IR light when it is on.
- Do not cover the IR light with your hand or anything else.
- When using the camera-recorder's IR light, remove the lens hood before you start to shoot. (P18)
- For shooting at an even higher sensitivity, we recommend that you use the optional IR light (AG-YRL30G).
- Performing high-sensitivity shooting may give rise to such problems as after-image, a deterioration in the image quality and difficulties in focusing.

When SUPER_IR or COLOR_NS has been selected as the high-sensitivity shooting mode, images are shot with the CCD taking about 16 times more time than usual to accumulate the signals. As a result, very small brilliant points that are not usually visible may be recorded as the images: this is normal and does not indicate an error or malfunctioning.

Vibration reduction function

If you are going to hold the camera to shoot, you can use the vibration reduction function to achieve shooting with minimal vibration (camera shake).

 appears on the screen when this function is working.

To release the function, press the OIS (Optical Image Stabilizer) button. When the OIS button is pressed again, the function is reactivated.

If you use a tripod, you can obtain natural images by shooting with the vibration reduction function released.

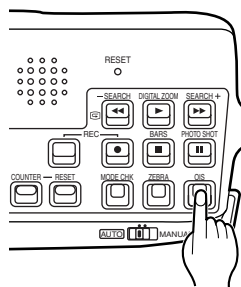

- It may not be possible to reduce the vibration at such times when the vibration is severe or when a moving subject is being tracked and shot at the same time.
- The vibration reduction function may not work properly when the digital zoom function is working.

Wind noise reduction

When "ON" has been selected as the WIND CUT item setting on the RECORDING SETUP screen using the menus (P68-P71), the noise created by wind blowing into the microphone on very windy days can be reduced. (P76)

When the wind noise reduction is activated, WIND CUT appears on the screen.

- The wind noise reduction function works for both the internal microphone and external microphone.
- If there is any bass sound, some of it may be reduced along with the wind noise.

Movie-like shooting

When "4. MOVIE-LIKE" has been selected as the SCENE FILE item setting on the SCENE FILE screen using the menus (P68-P71), you can shoot movie-like images. (P73)

Shooting techniques for different targets (cont.)

Photo shots

You can record still pictures on tape just as if you were taking snapshots with an ordinary camera.

When the PHOTO SHOT button is pressed in the shooting pause mode, a still picture lasting for about 7 seconds is recorded.

Once the still picture has been recorded, the camera-recorder is set to the shooting pause mode.

A photo index for images recorded using the photo shot function is created, enabling you to perform a photo index search when the tape is played back to find any still pictures you have recorded. (P53)

- While shooting is in progress, still pictures cannot be recorded even when the PHOTO SHOT button is pressed.

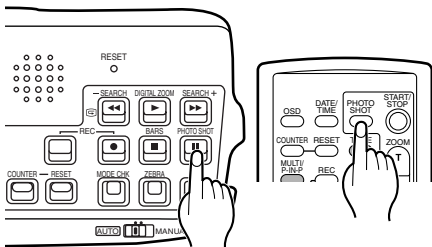

Color bars

When the BARS button is pressed during shooting or in the shooting pause mode, color bars (complying with the SMPTE standard), which come in handy for adjusting the picture quality of TV and external monitor images, can be displayed.

When the BARS button is pressed again, the original image is restored.

When the ID SET information in the ID SET item on the RECORDING SETUP screen have been set using the menus (P68-P71), the ID information will be displayed on the screen along with the color bars. (P76)

If the START/STOP button is now pressed, the images with ID information superimposed onto the color bars can be recorded on a tape.

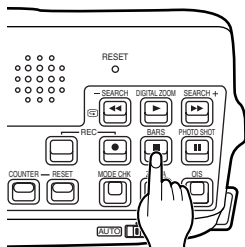

- The color bars will not be displayed when the digital zooming is performed. (P36)

Zebra pattern

When the ZEBRA button is pressed, parts that may be whitened out due to overexposure can be displayed in stripes.

- Parts that are extremely bright
- Parts that reflect a lot of light

By adjusting the iris and shutter speed in the manual mode to remove the areas with zebra patterns, you can obtain images with minimal whitened-out areas.

You can set the brightness level at which the zebra patterns are to be displayed by using the menus (P68-P71) and the ZEBRA DETECT item on the DISPLAY SETUP screen. (P78)

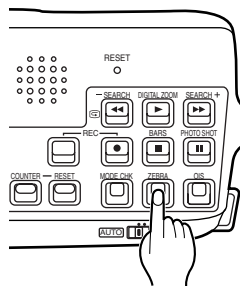

The markers are displayed when the ZEBRA button is pressed again.

Markers

When the ZEBRA button is pressed again while zebra patterns are displayed, markers will appear at the center of the screen.

When these markers are displayed, the video level is indicated at the bottom left of the screen.

The video level is displayed as a percentage from 0 to 99, and "99 ↑" appears when the level exceeds 99.

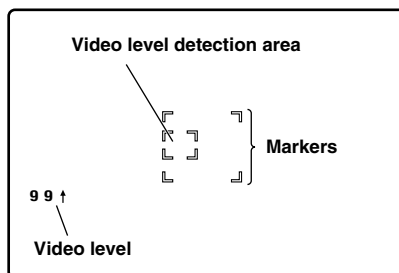

The regular screen is restored when the ZEBRA button is pressed again.

- The video level and video level detection area will not be displayed when the digital zooming is performed. (P36)

Shooting techniques for different targets (cont.)

Field and frame shooting

This camera-recorder normally shoots scenes using field recording (60 fields per second).

When "FRAME" has been selected as the REC MODE setting for the SETTING item on the SCENE FILE screen using the menus (P68-P71), scenes can be shot using frame recording (30 frames per second). (P73)

When playing back still pictures, high-quality images can be obtained.

- If normal (moving image) playback is performed, the images will appear jerky.

Field recording

Ac	Ae	Bo	Be	Co	Ce	Do	De	Eo	Ee	Fo	Fe	Go	Ge	Ho	He	Io	Ie	Jo	Je
----	----	----	----	----	----	----	----	----	----	----	----	----	----	----	----	----	----	----	----

Frame recording

A	B	C	D	E	F	G	H	I	J
---	---	---	---	---	---	---	---	---	---

When you are going to shoot scenes using frame recording, we recommend that you set the shutter speed to 1/60. (P43)

Frame-by-frame shooting

When "ON" has been selected as the ONE-SHOT REC item setting on the RECORDING SETUP screen using the menus (P68-P71), frame-by-frame shooting can be performed. (P77)

The number of seconds for the shooting is set using the REC TIME item on the same screen.

When the START/STOP button is pressed, shooting is initiated for the number of seconds set, and then the shooting pause mode is established.

- When the frame-by-frame shooting mode is set, an asterisk (*) at the left of the VCR's operating mode on the screen blinks. When recording is started, the asterisk stops blinking and lights.
- Even if the frame-by-frame shooting mode has been set, it is cancelled when the power is turned OFF.

Changing the image size

This camera-recorder allows you to change the size (aspect ratio) of the images recorded on tape.

Use the menus (P68-P71) to select the desired setting for the ASPECT CONV item on the CAMERA SETUP screen. (P73)

NORMAL:

Images are recorded with the standard 4:3 aspect ratio.



LETTER BOX:

Images are recorded with a 16:9 aspect ratio. Black bands are recorded at the top and bottom of the screen.



SQUEEZE:

The camera images are squeezed horizontally and recorded. When images recorded in this mode are played back on a TV monitor that supports the wide screen format, they are displayed with the 16:9 aspect ratio.

When SQUEEZE has been selected as the item's setting, "SQU" is displayed on the screen.



- When the mode is switched to SQUEEZE, the screen image may be disrupted for an instant. This is not a sign of malfunctioning.
- The image quality may deteriorate when images recorded at the SQUEEZE setting are played back.

Shooting techniques for different targets (cont.)

Using the USER buttons

You can allocate functions that you have selected using the menu to the USER1, USER2 and USER3 buttons.

This enables you to change the shooting conditions to match the subject or add fade effects to the images.

The USER button functions can be selected using the USER1, USER2 and USER3 items on the SW MODE screen. (P75)

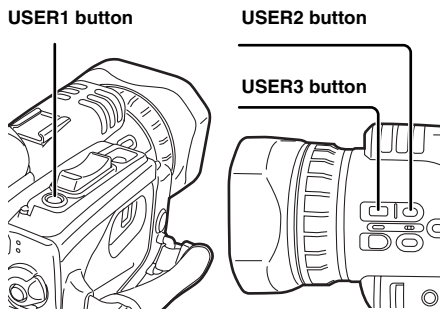

One-touch zooming

One-touch zooming is initiated while you are shooting by pressing the USER button (P75) to which you have allocated the (PUSH) AF+ZOOM function.

While this button is held down, the camera-recorder zooms in on the subject from the current zoom position for a close-up shot and focuses automatically.

When the button is released, the camera-recorder returns to the original zoom position.

This function is useful when you are shooting with manual focusing.

Backlight compensation function

When shooting subjects in backlight conditions, press the USER button (P75) to which you have allocated the BACKLIGHT (backlight compensation) function.

Backlight compensation prevents the image of the subject from turning out dark.

When the backlight compensation is activated,  appears on the screen.

Press the USER button again to release the backlight compensation.

- This function is activated when auto mode is used for the iris adjustment.

AE lock function

This function locks the shutter speed and iris for as long as you shoot when you press the USER button (P75) to which the AE lock function has been allocated.

When you zoom in on a subject so that it appears larger on the screen and then press the USER button, the shutter speed and iris that are suitable for the subject are fixed.

Even when the brightness of the background changes, you can shoot the subject at the same brightness level.

 appears on the screen while the AE lock function is working.

Index recording

The scene index signals are recorded on the tape when you press the USER button (P75) to which you have allocated the INDEX function during shooting or recording.

The scene index recording standby status is established when you press the USER button in the shooting or recording pause mode.

If you start shooting or recording after pressing the USER button, the scene index will be recorded on the tape.

Recording the scene index enables you to search (scene index search) scenes during playback. (P53)

Backup recording

You can automatically record backups of the camera images on an external unit (P55) connected to the DV connector.

Set the method used to control the external unit using the DV CONTROL and DV CMD SEL items on the OTHER FUNCTIONS screen. (P79)

Remember the following when you record backups of images.

- The menu item settings are retained in the memory even when the power is turned off. This means that if the camera-recorder is used with the settings for backup recording still in effect, images on tapes in any unit that has been connected may be overwritten. If you have performed backup recording, check the menu item settings before you operate the camera-recorder.
- If another AG-DVC30 is used as the external unit for the backup recording, select "OFF" as the DV CONTROL item setting for the external unit and then set it to the VCR mode before use.
- Backup recording may not work properly if two or more external units are connected.
- Make sure that the DV cable (IEEE 1394) used to connect the external unit is not more than 4.5 meters long.
- Before starting backup recording, make sure the external unit is set up to record DV signals.
- When backup recording is performed with "CHAIN" selected as the DV CONTROL item setting, recording will be started automatically by the backup unit that has been set to the recording standby mode as soon as the camera-recorder's tape approaches its end during shooting.
- If any of the following operations are performed when backup recording is performed with "EXT" or "CHAIN" selected as the DV CONTROL item setting, the pictures or sound recorded by the backup unit may be disrupted.
 - Digital zoom (P36)
 - High-sensitivity shooting (P37)
 - Photo shot (P39)
 - Frame recording (P40)
 - Squeeze recording (P40)
 - Slow shutter speed (P43)

Switching to manual mode

This camera-recorder enables you to switch over to the manual mode, which enables you to perform the operations listed below manually.

- Focusing (P42)
- Shutter speed (P43)
- Iris (P44)
- Gain (P44)
- White balance (P45, P46)

Focusing

With this camera-recorder, you can select either auto focusing or manual focusing.

When the AUTO/MANUAL selector switch is set to MANUAL and the FOCUS button is pressed, manual focusing is selected and "MF" appears on the screen.

Use the focus ring to bring the subject into focus.

Press the FOCUS button again to switch back to auto focusing.

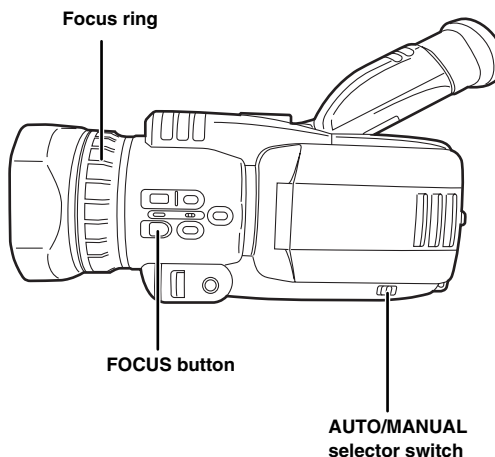

- The subject may not be in focus if you zoom out (wide angle), manually focus on the subject and then zoom in (telephoto).
- To blur the background so that the subject stands out, reduce the F-number (opening the iris) and focus. Conversely, to obtain a greater depth of field so that the object in front of and behind the subject are also in focus, increase the F-number (closing the iris) and focus.

Shutter speed, iris and gain adjustments

You can adjust the shutter speed, iris and gain to suit the scenes being shot and the lighting conditions.

1 Set the AUTO/MANUAL selector switch to MANUAL.

- No adjustments can be performed with this switch at AUTO.

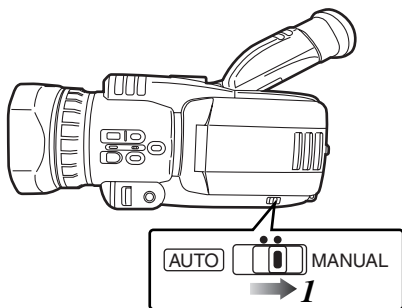

2 Press the multi dial.

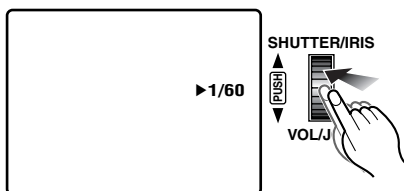

The shutter speed is displayed on the screen.

Shutter speed adjustment

3 Turn the multi dial to select the shutter speed.

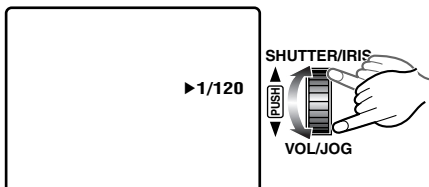

Slow shutter speeds:

1/4, 1/8, 1/15, 1/30

Regular shutter speeds:

1/60, 1/100-1/4000, 1/8000

Synchro scan shutter speeds:

1/60.3-1/250

Adjusting the slow shutter speed

You cannot switch to the slow shutter speed while you are shooting at a normal shutter speed.

Neither can you switch to the normal shutter speed while you are shooting at a slow shutter speed.

To make the switch, first set the camera-recorder to the shooting pause mode, and then select the normal shutter speed or slow shutter speed you desire.

1 Turn the multi dial in the direction for reducing the shutter speed until **SLOW** appears on the screen.

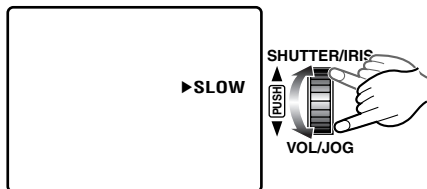

2 When the multi dial is pressed, the number representing the slow shutter speed appears on the screen.

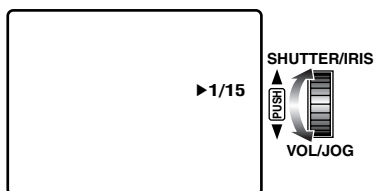
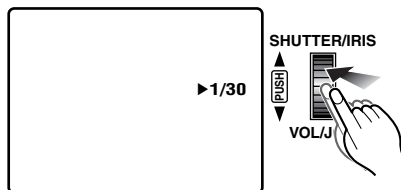

Returning to the normal shutter speed

4 Turn the multi dial in the direction for increasing the shutter speed until **NORM** appears on the screen.

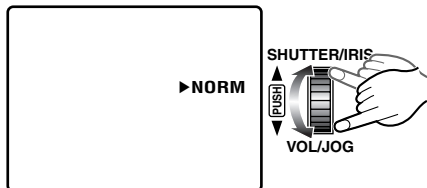

Shutter speed, iris and gain adjustments (cont.)

- 5 When the multi dial is pressed, the number representing the normal shutter speed appears on the screen.

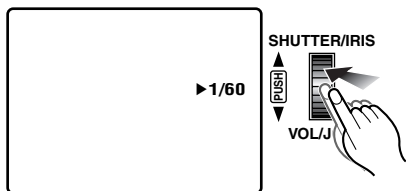

- With artificial lighting and especially fluorescent lights and mercury-vapor lamps, the luminance changes in synchronization with the power line frequency. In areas where this frequency is 50 Hz, mutual interference will occur between the camera-recorder's vertical sync frequency (approx. 60 Hz) and the lighting frequency (50 Hz). This means that the white balance may change periodically. Before shooting in areas with a 50 Hz frequency or adjusting the white balance, set the shutter speed to 1/100.
- The higher the shutter speed, the lower the camera's sensitivity.
- If the shutter speed is increased when the auto iris is set (when the F-number is not displayed), the iris will open (the F-number is reduced) so that the background is more blurred and the subject stands out.
- Shooting at a slow shutter speed may give rise to such problems as after-image, a deterioration in the image quality and difficulties in focusing.
- When a slow shutter speed has been selected, images are shot with the CCD taking more time than usual to accumulate the signals. As a result, very small brilliant points that are not usually visible may be recorded as the images: this is normal and does not indicate an error or malfunctioning.

Synchro scan shutter speeds

A synchro scan shutter speed is a shutter speed used to shoot TV screens or PC monitor screens.

The synchro scan shutter speed is set using the SYNCHRO SCAN item on the CAMERA SETUP screen when the synchro scan shutter speed has been selected by the multi dial. (P73)

- If you adjust the shutter speed to match the frequency of the TV screen or PC monitor screen, you can shoot the screen while minimizing the horizontal noise that is generated when TV screens are shot.

Iris and gain adjustments

- 4 When you press the multi dial, the iris and gain values are displayed on the screen.

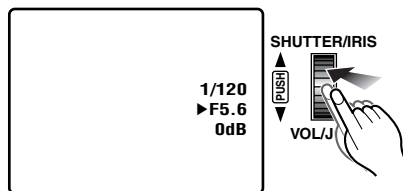

- 5 Turn the multi dial to select the F-number.

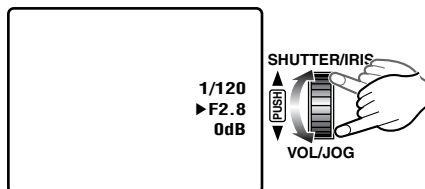

Iris (F-number):

CLOSE, F16-F1.7, OPEN

- 6 When OPEN is selected as the F-number, ► moves to the gain value.

- 7 Turn the multi dial to select the gain value.

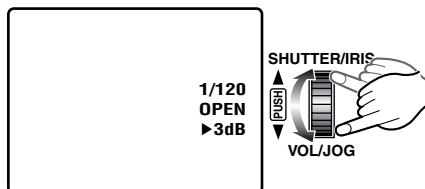

Gain value:

0 dB, 3 dB-15 dB, 18 dB

- When "IRIS" has been selected as the FOCUS RING item setting on the SW MODE screen using the menu (P68-P71), you can use the focus ring to adjust the iris and gain but only when you are shooting in the auto focus mode. (P76)

White balance adjustments

Auto white balance

When you shoot with the AUTO/MANUAL selector switch at the AUTO position, the white balance is adjusted automatically while scenes are being recorded.

As the white balance sensor is used to detect the light source during shooting so the camera-recorder can adjust the white balance, do not cover the sensor with your hand or anything else.

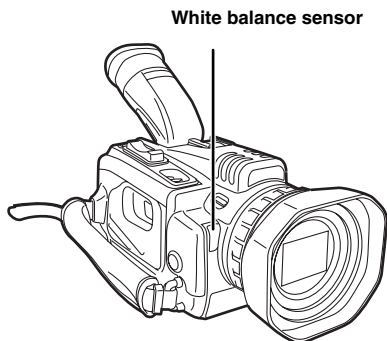

If you press the USER button to which the AWB LOCK function has been allocated (P75) when you are shooting in the auto white balance mode, the white balance at the time the button was pressed is used until the button is pressed again.

Each time the button is pressed, the camera-recorder switches between auto white balance and AWB lock.

Setting the white balance

Select the white balance setting mode if the white balance needs to be adjusted very precisely.

- Before shooting in areas with a 50 Hz power line frequency or adjusting the white balance, set the shutter speed to 1/100.

1 Set the AUTO/MANUAL selector switch to MANUAL.

- No adjustments can be performed with this switch at AUTO.

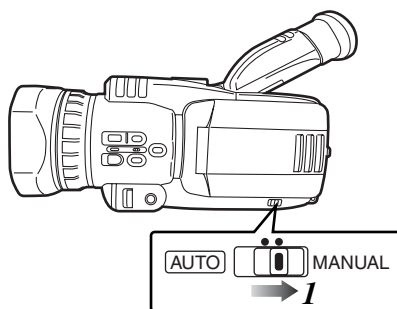

2 Press the WHITE BAL button to select the desired white balance setting mode.

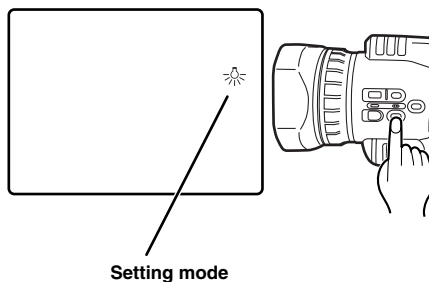

W. LOCK: Lock mode

The current white balance is retained.

: **Indoor (incandescent bulb) mode**
Incandescent bulbs, halogen lamps

: **Outdoor mode**
Outdoors under clear skies

: **Set mode**

- Mercury-vapor lamps, sodium-vapor lamps, some fluorescent lamps
- Lights used for wedding receptions in hotels, theater spotlights
- Sunset, sunrise, etc.

No display: **Auto mode**

The white balance setting mode cannot be selected while digital zooming is performed with "×160" selected as the D. ZOOM item (P76) setting on the SW MODE screen.

Adjusting the white balance manually

In the set mode (☐), you can save the white balance, which has been adjusted manually, in the memory.

1 Place a white pattern in a location with the same lighting conditions and light source as the subject, then zoom in and fill the whole screen with white.

A white object (a white cloth or white wall) near the subject can be used instead of the white pattern.

- Keep high-brightness spotlights and yellow subjects off the screen.

2 Set the AUTO/MANUAL selector switch to MANUAL.

- No adjustments can be performed with this switch at AUTO.

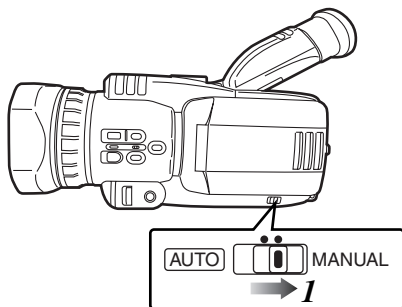

3 Press the WHITE BAL button and hold it down until the ☐ display lights.

The ☐ display will start to blink immediately after it lights.

- This operation can be performed even if the setting mode for the white balance has been selected.

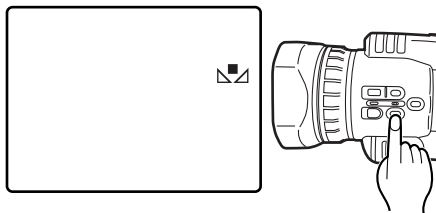

4 The white balance is now adjusted automatically.

The screen then darkens for a moment before the black balance is adjusted automatically.

When the adjustments have been completed, ☐ stops blinking and changes back to a lighted display.

- Do not move the screen away from the subject until the adjustments are completed.

- If these steps are taken during shooting, only the white balance will be adjusted.
- If the white balance cannot be adjusted satisfactorily because the place is extremely bright or extremely dark, the ☐ display will blink slowly.
- The white balance cannot be adjusted manually while digital zooming is performed with "×160" selected as the D. ZOOM item (P76) setting on the SW MODE screen.

Adjusting the headphone volume

1 Hold down the MENU button until the AUDIO LEVEL SETUP screen appears.

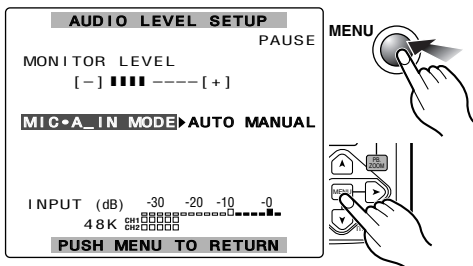

6 Press the MENU button to release the AUDIO LEVEL SETUP screen.

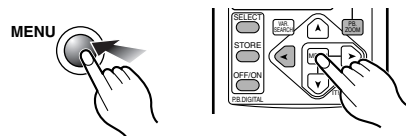

3 Press the multi dial.

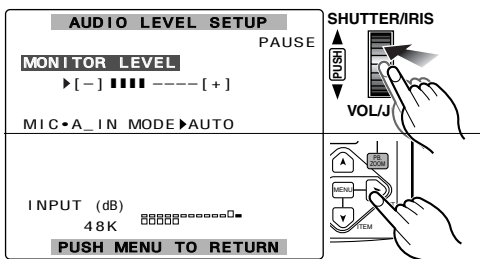

“▶” appears to the left of the level meter under the MONITOR LEVEL item.

Normal playback (cont.)

Adjusting the volume

You can adjust the speaker volume when a tape is being played back.

The adjustment will be reflected in the headphone volume.

- 1 Hold down the multi dial until the audio level meter is displayed.

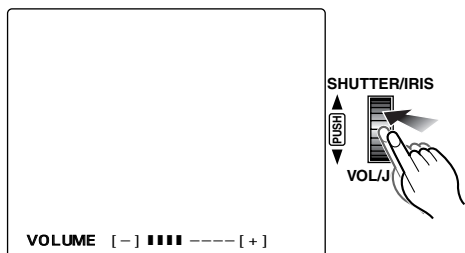

- 2 Turn the multi dial to adjust the volume.

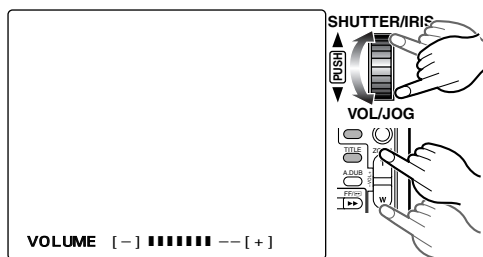

- 3 Press the multi dial to clear the level meter display.



Connecting a TV to view images

When the camera-recorder is connected to a TV set using the accessory AV cable or S-video cord (option), you can view the playback images on the TV screen.

- 1 Connect the camera-recorder to the TV set. (P56)

- 2 Start playback.

- Press the OSD button on the remote control unit to display the information (counter, mode displays) appearing on the LCD monitor and viewfinder on the TV screen.

The displays are cleared when the OSD button is pressed again.

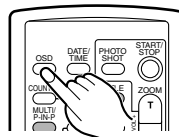

Checking the shooting date and time

You can display the shooting date and time on the screen by pressing the DATE/TIME button on the remote control unit while a tape is playing back.

Each time the button is pressed, the display changes in the following sequence.

- Time
- ↓
- Date
- ↓
- Time and date
- ↓
- Original screen

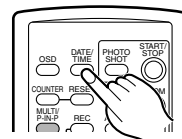

Variable-speed playback

Slow playback

You can play back tapes recorded in the SP and LP mode at about one-fifth and one-third of the normal tape speed, respectively.

1 Play back the tape.

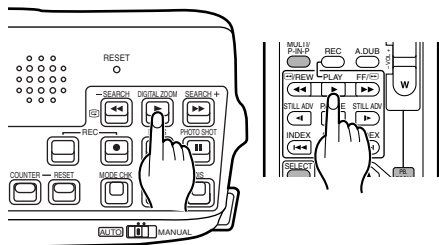

2 Press one of the STILL ADV (▶▶ or ◀◀) buttons on the remote control unit.

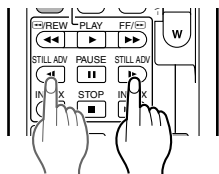

- Press the ▶▶ button to return to normal playback.

Still-picture playback

If you press the || button while the tape is playing back, the camera-recorder is set to the playback pause mode so that the still pictures of the frames can be viewed.

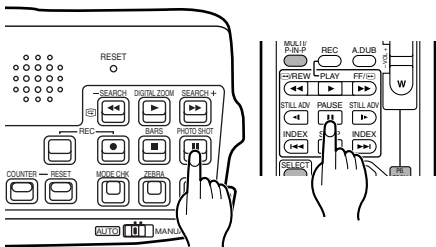

- Press the ▶▶ button or || button to return to normal playback.

Frame-feed playback

Frame-feed playback can be initiated by turning the multi dial during still-picture playback. Turn the multi dial upward to play back the tape in the forward direction and downward to play it back in the reverse direction.

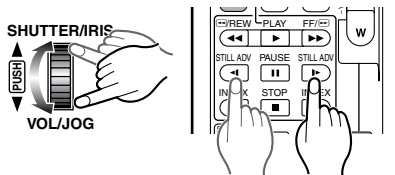

- Press the ▶▶ button to return to normal playback.

Cue and review

The tape is cued by pressing the ▶▶ button while the tape is playing back and reviewed by pressing the ◀◀ button. The tape is cued or reviewed only for as long as the button is held down.

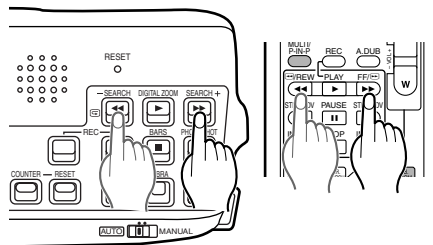

- Press the ▶▶ button to return to normal playback.

Search functions

Variable-speed search

This function enables you to change the playback speed and search for specific scenes.

- 1 Press the ► button on the camera-recorder or the VAR SEARCH button on the remote control unit while the tape is playing back.

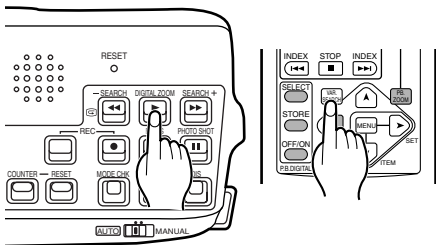

"1×" appears on the viewfinder and LCD monitor, and the tape is played back at the normal speed. No sound is heard at this time.

- 2 Turn the multi dial.
When the multi dial is turned, the playback speed changes in the sequence of 1/5× (or 1/3× in the LP mode), 1×, 2×, 5×, 10× and 20× the normal tape speed. The tape is played back in the forward direction when the dial is turned upward and in the reverse direction when it is turned downward.

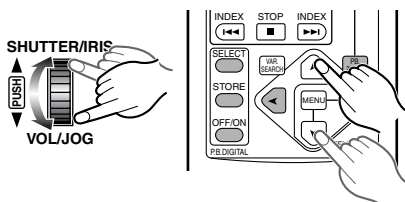

- Press the ► button to return to normal playback.

Blank search

If, in the VCR mode, you press the USER button (P75) to which you have allocated the BLANK SEARCH function, the end of the last scene shot (a blank part of the tape) is found, and a still picture of the frame that is about a second ahead of the end of the last scene is displayed.

- If there are no unrecorded blanks, the tape will stop at the end of the tape.
- If shooting is started immediately after an unrecorded blank has been found, the scene will be recorded with frame-to-frame continuity following on from the last frame.

USER1 button

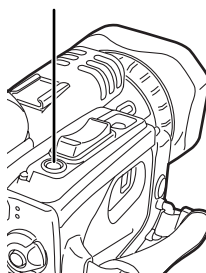

USER2 button

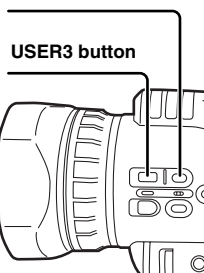

Index search

This function searches for the index signals recorded on the tape so that the tape can be cued up to a particular part.

Index searches can only be performed using the remote control unit.

1 Using the menus (P68-P71), select the index to be searched at the SEARCH item on the PLAYBACK FUNCTION screen.

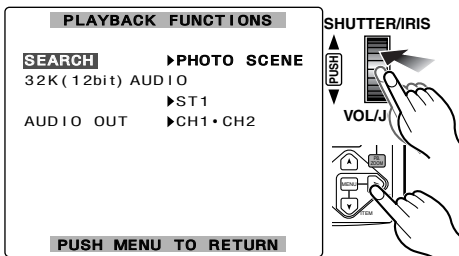

2 Press one of the INDEX buttons (▶▶ or ◀◀) on the remote control unit.

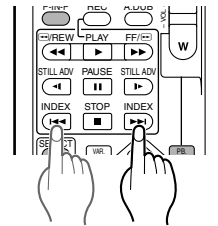

To stop the search at any time, press the STOP button (■).

Index signals

This camera-recorder can record index signals that serve as a guide for tape cue-up.

• **Photo index:**

These signals are recorded when a tape has been recorded using the photo shot technique. (P39)

• **Scene index:**

These signals are recorded when index recording has been performed. (P41, P75)

PHOTO:

When the INDEX button is pressed, the tape is cued back or forward to the image containing the photo index signal.

When the tape is cued, it is played back for about 4 seconds, and then the image is played back as a still picture. (If you continue still-picture playback for 5 or more minutes, the camera-recorder is set to the stop mode in order to safeguard the heads from wear.)

SCENE:

When the INDEX button is pressed once, "S1" is displayed, and the tape is cued back or forward to the image containing the photo index signal.

Each time this button is pressed again after operation has started, "S2" and then "S3" are displayed, and the tape is cued up to the second and subsequent scenes. When the tape is cued up, playback starts from that section. (Up to the ninth scene before or ahead on the tape can be specified for cue-up.)

The function may not work properly if the interval between one index and the next is less than one minute.

Counter

You can display a counter that indicates how much time has elapsed during shooting or playback by pressing the COUNTER button.

1 Press the COUNTER button to display the counter memory.

2 At the desired position on the tape, press the RESET button (counter) to reset the counter memory display.

3 Proceed with playback or shooting.

The following data is selected in turn each time the COUNTER button is pressed.

0 : 00.0 : Counter value
↓
M 0 : 00.0 : Counter memory
↓
TC XX : XX : XX. XX : Time code
↓
UB XX XX XX XX : User's bit
↓
Returns to original screen

- What is shown on the counter can be reset to zero by pressing the RESET button (counter) while the counter value or counter memory is displayed.
- The time code and user's bit cannot be reset using the RESET button (counter).

5 When the tape is rewound or fast forwarded, it stops automatically near where the counter memory display was reset.

When adding sound to an existing recording by audio dubbing, you can use this function to set the point at which the audio dubbing is to end. (P59)

Connecting external units

Headphones

(P48)

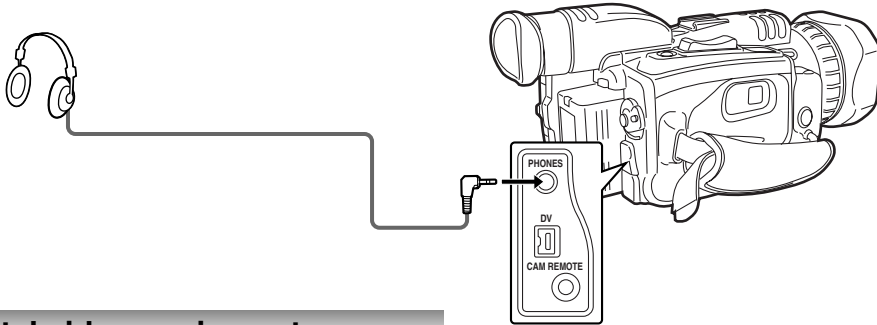

Digital video equipment

(P42, P61)

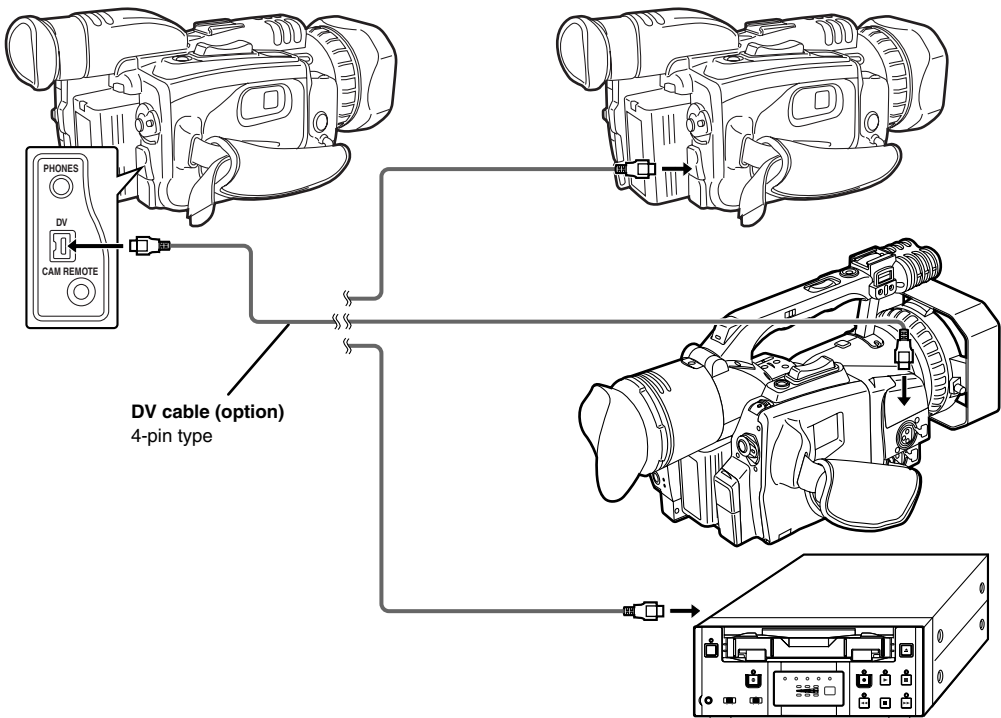

EDITING

- Before proceeding to connect or disconnect the DV cable (IEEE1394), be absolutely sure to turn off the power of the units that are to be connected or disconnected using this cable.

- Before proceeding to connect the unit which uses a 6-pin type of DV connector, carefully check the shape of the connectors on the DV cable and unit. Connecting a connector upside down may damage the parts inside the camera-recorder and cause malfunctioning.

Always connect the DV cable to the unit with the 6-pin type DV connector first.

- When recording signals from an external unit, first check that video signals are supplied.

- While signals from an external unit are being recorded, do not operate the external unit or disconnect any of its cables. This will stop the output, which may result in the signals not being recognized when recording is resumed.

- You can connect a digital video unit equipped with a DV connector and digitally transfer video and audio signals as well as time codes and other information.

- When a DV cable has been connected to the DV connector, do not apply any strong external force as this may damage the connector.

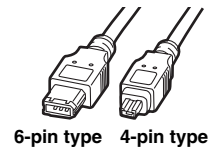

Connecting external units (cont.)

TV set

(P58-P61)

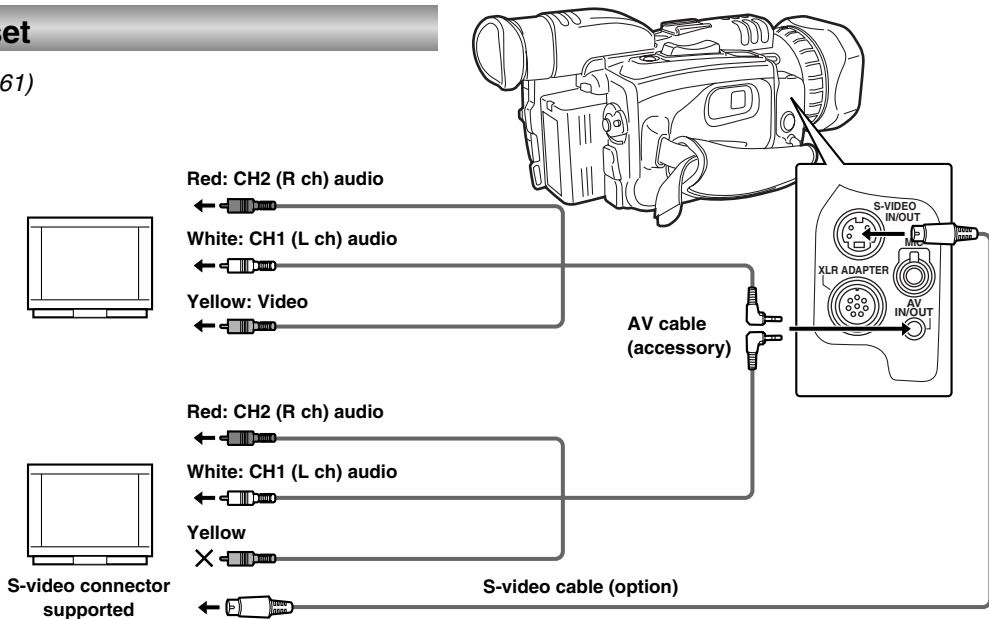

Video deck

(P58-P61)

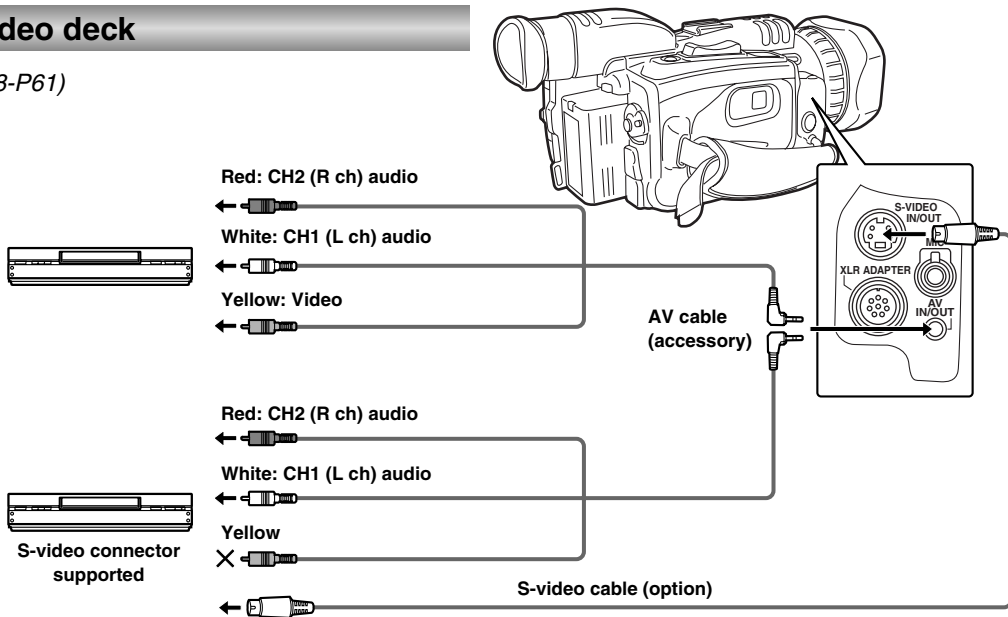

- When connecting an external unit to the camera-recorder and inputting the video and audio signals of that unit to the camera-recorder, connect the camera-recorder to the output connectors on the external unit.
- When connecting an external unit to the camera-recorder and outputting the video and audio signals of the camera-recorder to that unit, connect the camera-recorder to the input connectors on the external unit.
- When video signals are input to both the S-VIDEO IN/OUT connector and AV IN/OUT jack, the signals of the S-VIDEO IN/OUT connector take precedence.
- Except when performing audio dubbing on existing recordings, audio signals cannot be recorded unless video signals are input to the S-VIDEO IN/OUT connector and/or AV IN/OUT jack.

Connecting external units (cont.)

External microphone (connected to phono jack)

(P58, P59)

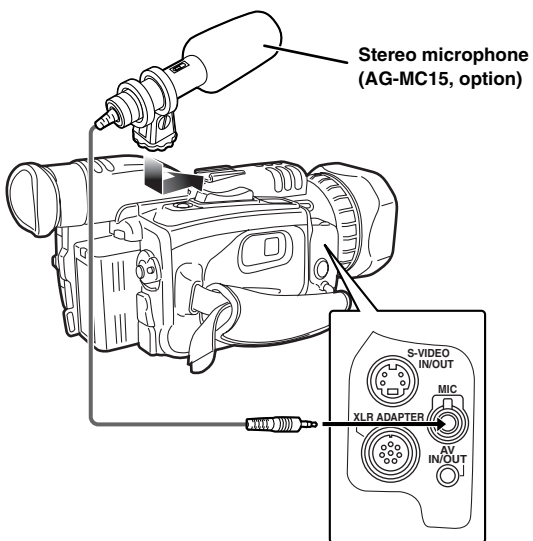

External microphone (connected to XLR connector)

(P58, P59)

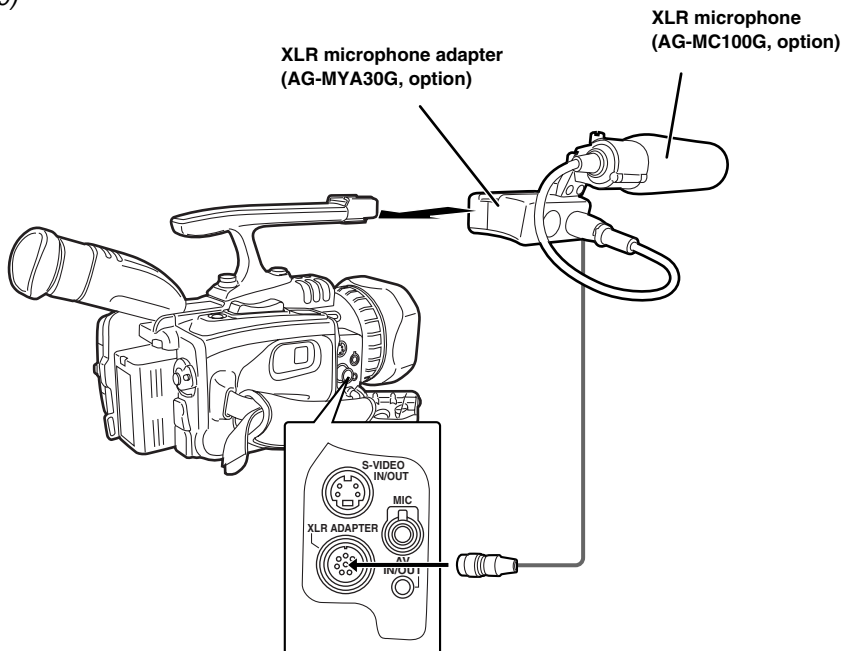

Audio dubbing

Background music or narration can be added to the images you have recorded on the tape. (P56, P57)

1 Turn the POWER lever to set the camera-recorder to the VCR mode.



2 Using the menus (P68-P71), select the audio recording system at the AUDIO REC item on the RECORDING SETUP screen. (P76)

32K (12bit):

The sound is recorded using the 12-bit/32kHz (4-channel) system. Use this mode when you want to keep the sound that was heard while you were shooting even after audio dubbing has been performed.

48K (16bit):

The sound is recorded using the 16-bit/48kHz system (2 channels with a good sound quality). When audio dubbing is performed, the sound that was heard while you were shooting will be erased.

3 Select the sound to be recorded using the A DUB INPUT item on the AV IN/OUT SETUP screen. (P78)

MIC:

The sound of the built-in or external microphone is recorded.

A_IN:

The sound of the audio component connected to the AV IN/OUT jack is recorded.

4 Find the scene where the sound is to be added, and set the camera-recorder to the still-picture playback mode. (P51)

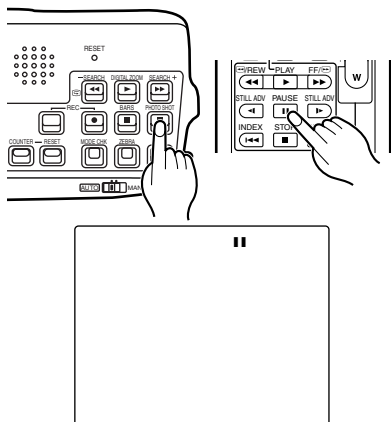

5 Press the A.DUB button on the remote control unit to establish the status ready for audio dubbing.

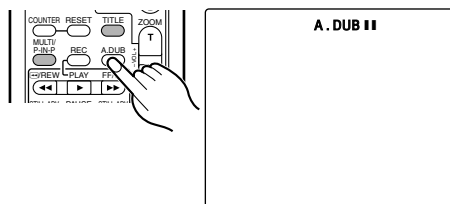

6 Press the PAUSE button (||) on the remote control unit and start input of the sound to be dubbed.

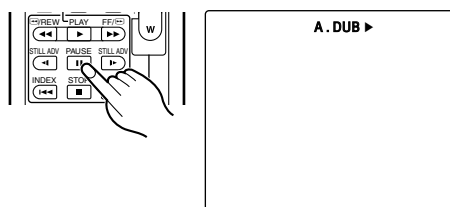

7 When the PAUSE button (||) on the remote control unit is pressed, the camera-recorder returns to the still-picture playback mode. If more sound is to be dubbed, repeat steps **5** and **6**.

8 When the STOP button (■) on the remote control unit is pressed, audio dubbing is stopped.

When the AUDIO DUB (sound adding) function is allocated to a USER button on the camera-recorder, audio dubbing can be performed (sound can be added) by operating that button in the same way as the PAUSE button (||) on the remote control unit.

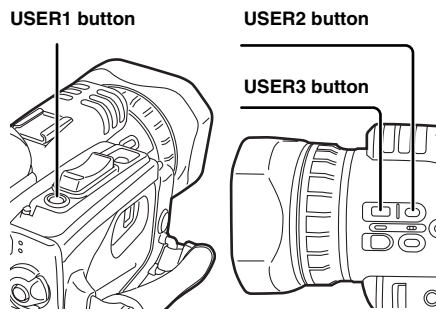

■ Listening to sound that has been dubbed

You can switch between the sound that has been dubbed and the sound heard during shooting using the 32K (12bit) AUDIO item setting on the PLAYBACK FUNCTION screen. (P74)

ST1:

The sound heard during shooting is played back.

ST2:

The sound that has been dubbed on a recording is played back.

MIX:

Both the sound heard during shooting and that you have dubbed on a recording are played back at the same time.

■ Performing audio dubbing as you listen to it

You can monitor the sound by setting “ST2” while audio dubbing is temporarily suspended.

If you use headphones when performing audio dubbing on a recording using mic input, you can listen to the sound being dubbed.

When you perform audio dubbing using line input (from the audio component connected to the AV IN/OUT jack), you can listen to the sound being dubbed through the speakers.

■ Using the counter memory function to edit dubbed sound

- ① First reset the counter memory display at the position where the audio dubbing is to end. (P54)
- ② Rewind the tape to the position where the audio dubbing is to start, and start the dubbing.
- ③ The tape then stops automatically at the position on the tape where the counter memory display was reset.

■ Adjusting the audio input level

Use the procedure described for “Adjusting the mic input audio level” (P47) to adjust the audio level of mic input and line input (from the audio component connected to the AV IN/OUT jack).

■ Adjusting the audio output level

Use the procedure described for “Adjusting the headphone volume” (P48) to adjust the audio level output from the headphones and speakers.

Inputs and audio tracks for recordings

Input	When shooting	When performing audio dubbing in the 32K (12bit) mode		Order of priority for mic inputs High ↓ Low
		A. DUB INPUT: MIC	A. DUB INPUT: A_IN	
External mic L channel	CH1	CH3	---	
External mic R channel	CH2	CH4	---	
INPUT 1 (XLR mic) *	CH1	CH3	---	
INPUT 2 (XLR mic) *	CH2 (CH1)	CH4 (CH3)	---	
Internal mic L channel	CH1	CH3	---	
Internal mic R channel	CH2	CH4	---	
Audio IN/OUT CH1 (L channel) (white phono jack)	---	---	CH3	
Audio IN/OUT CH2 (R channel) (red phono jack)	---	---	CH4	

- Which sound is to be recorded during shooting is automatically determined by the order of priority for the mic inputs.
- The audio tracks on which dubbed sound is to be recorded can be changed using the A.DUB INPUT item on the AV IN/OUT SETUP screen. (P78)

* You will need the XLR microphone adapter (AG-MYA30G, option) if you intend to use the XLR microphone. (P57)

Dubbing

Analog input

Using the dubbing function, you can dub (copy) the contents of S-VHS (or VHS) cassettes onto DV cassettes or record TV programs. (P56)

- 1 Turn the POWER lever to set the camera-recorder to the VCR mode.

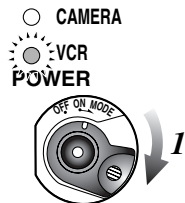



- 2 Turn on the power of the external unit, and play back the tape.

- 3 To start recording, press the REC button while holding down the REC sub button on the camera-recorder.

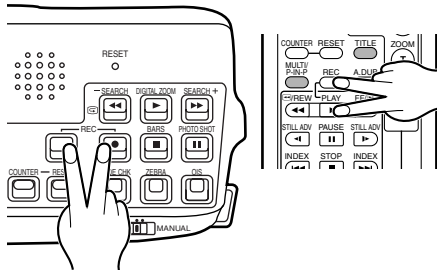
If you are using the remote control unit, press the PLAY button while holding down the REC button.



- If you do this during still-picture playback (P51), the camera-recorder will be set to the rec pause status. To resume recording from the rec pause status, press the  button.

- 4 Press the  button to stop the recording.

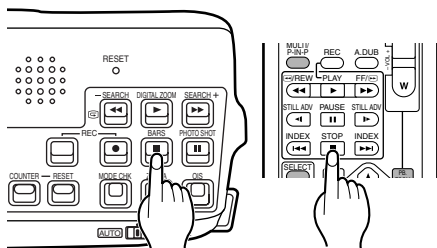

- 5 Stop play back on the external unit.

■ Adjusting the audio input level

Use the procedure described for “Adjusting the mic input audio level” (P47) to adjust the audio level of mic input and line input (from the audio component connected to the AV IN/OUT jack).

Analog output

You can use a video deck to dub the images you have shot using this camera-recorder onto an S-VHS (or VHS) cassette tape. (P56)

- 1 Turn the POWER lever to set the camera-recorder to the VCR mode.

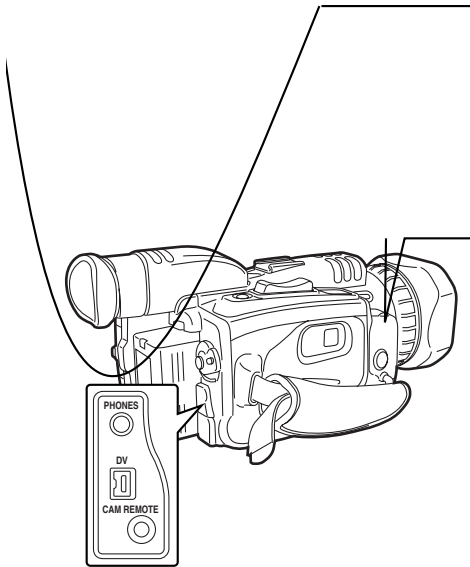
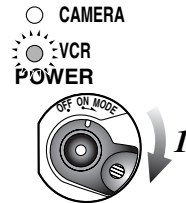

- 2 Press the ► button to play back the tape in the camera-recorder.

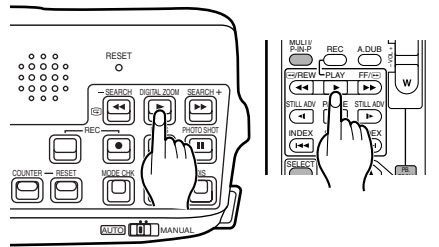

- 3 Start recording on the video deck.

- 4 Stop recording on the video deck.

- 5 Press the ■ button to stop playing back the tape in the camera-recorder.

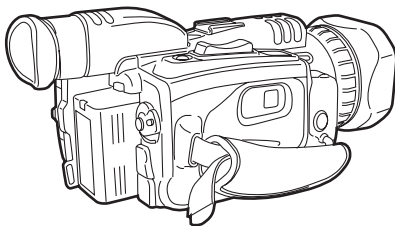
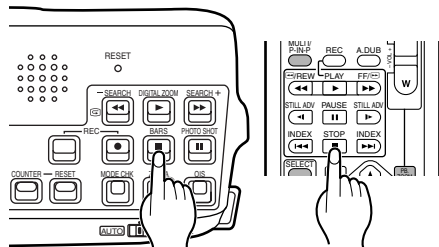

Digital input/output

You can perform dubbing with a high image quality by means of digital signals by using the DV cable (option) to connect the camera-recorder to a digital video unit equipped with a DV connector (IEEE 1394 connector). (P55)

1 Turn the POWER lever to set the player unit and recorder unit to the VCR mode.



2 Press the ► button to play back the tape in the player.

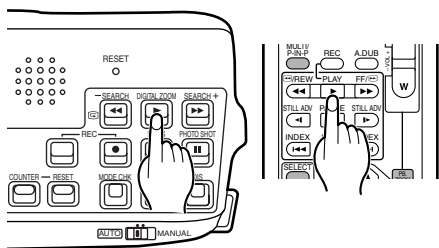

3 To start recording in the recorder, press the REC button while holding down the REC sub button.

If you are using the remote control unit, press the PLAY button while holding down the REC button.

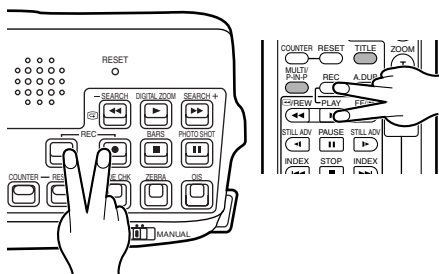

- If you do this during still-picture playback (P51), the camera-recorder will be set to the rec pause status. To resume recording from the rec pause status, press the **||** button.

4 Press the ■ button to stop the recording in the recorder.

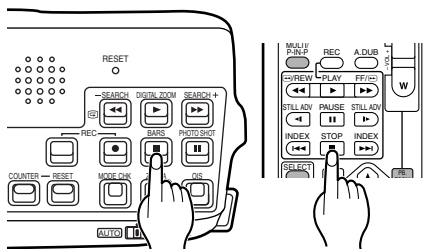

5 Press the ■ button to stop playback in the player.

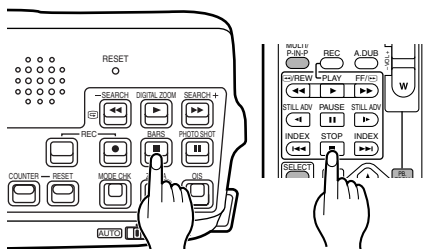

- Digitally dubbed sound is recorded in the same audio mode as the player's tape regardless of the recorder's menu setting.
- When dubbing is performed with "ON" selected as the 1394 TC REGEN and 1394 UB REGEN item settings on the recorder's menu, the player's time code and user's bit can be copied. (P76, P77)

In this case, check the recorder's screen to verify that the player's images are being received before starting to record.

If you start recording when there are no images being received from the recorder, it may not be possible to copy the time code and user's bit properly.

Screen displays

Displays in CAMERA and VCR modes

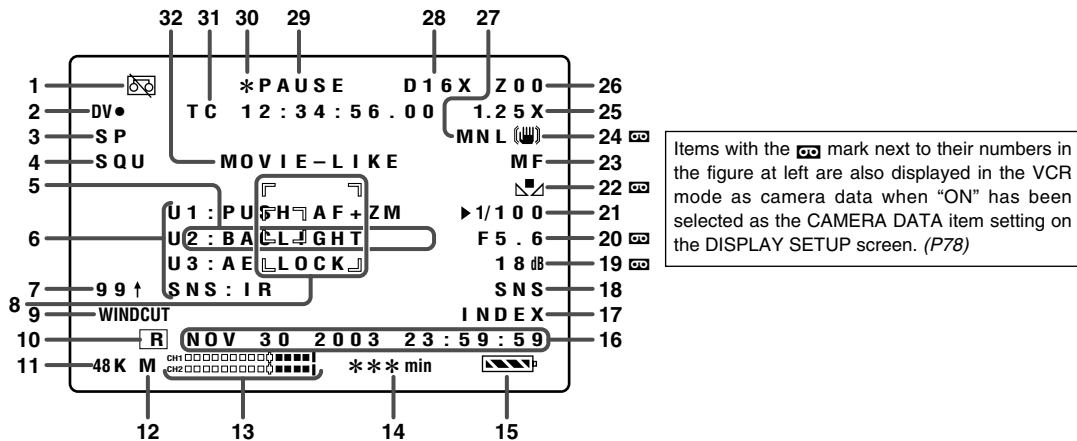

1. Warning information

REMOTE:

This blinks when the wrong equipment setting has been selected on the remote control unit. (P25)



This blinks when condensation has formed inside the camera-recorder. (P84)



This blinks when the cylinder heads are dirty.



This blinks when the cassette tape has not been inserted or the one that has been inserted is set to the recording inhibited status.



This blinks when the tape has come to its end.



This blinks if a problem has occurred in the camera-recorder while taking a self-portrait in the mirror mode.



This blinks when the internal battery for the calendar has run out. (P30)

2. Back-up unit modes

The status (modes) of the backup unit connected to the DV connector is displayed here.

No status is displayed when "OFF" has been selected as the DV CONTROL item setting on the OTHER FUNCTIONS screen. (P79)

DV ● : Recording

DV II : Recording standby

: The backup unit cannot be controlled.

DV : The backup unit has not been connected.

DV -- : The backup unit is connected but it is not in the recording or recording standby mode.

3. Recording time mode

SP : SP (standard play) mode

LP : LP (long play) mode

4. Squeeze information

This display appears when recording with "SQUEEZE" selected as the ASPECT CONV item setting on the CAMERA SETUP screen or when images recorded in the squeeze mode are played back. (P40, P73)

5. Setting selection

The selected setting is displayed here when a switch is selected or a button is pressed to select a setting.

Displays in CAMERA and VCR modes

6. Button functions

The functions allocated to the USER buttons (P75) and high-sensitivity shooting mode (P37) are displayed here while the MODE CHK button is held down.

7. Video level

The video level near the markers is displayed here. (P39)

8. Markers

The markers are displayed here when the ZEBRA button is pressed twice during shooting. (P39)

9. Wind noise reduction

WIND CUT is displayed here when "ON" has been selected as the WIND CUT item setting on the RECORDING SETUP screen. (P38, P76)

10. Time stamp

 is displayed here when "REC" has been selected as the TIME STAMP item setting on the RECORDING SETUP screen. The date and time are recorded as part of the images on the tape. (P37, P76)

11. Audio recording system

The digital sound recording system is displayed here. (P76)

12. Mic manual mode

"M" is displayed here when sound is recorded manually using the internal microphone or external microphone. (P47)

13. Audio level meter



This indicates the levels of the audio input and output signals.

14. Remaining tape

The remaining tape time is displayed here. It is not displayed while it is being calculated or during slow playback.

15. Remaining battery charge

As the remaining battery charge drops, the display changes as follows: .

When the battery has completely discharged,  () blinks. (When the AC adapter is being used, a display other than  may appear: this is not a sign of malfunctioning.)

16. Calendar

The current date and time are displayed here.

When the BARS button is pressed to display color bars, the ID information set at the ID SET item on the DISPLAY SETUP screen is displayed.

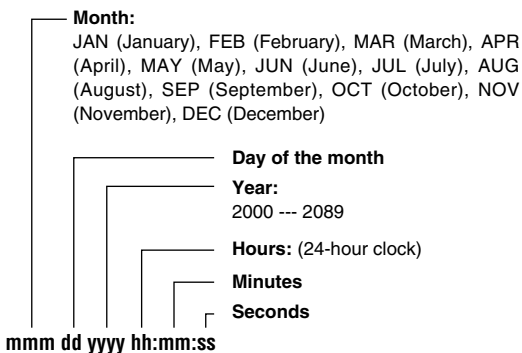

17. Index recording

"INDEX" lights during index signal recording. This is initiated by pressing the USER button in which the INDEX function has already been allocated during recording. (P41, P75)

It blinks when the INDEX button is pressed before recording (to indicate the index signal recording standby status).

18. High-sensitivity shooting mode

SNS is displayed here when shooting in a high-sensitivity mode. (P37)

19. Gain value

The gain value used for shooting is displayed here. (P44)

20. F-number

The iris (F-number) used for shooting is displayed here. (P44)

 appears when the backlight is being compensated. (P41)

 appears in the spotlight mode. (P75)

Displays in CAMERA and VCR modes

21. Shutter speed

The shutter speed used for shooting is displayed here. (P43)

22. White balance information

The white balance information is displayed here. (P45, P46)

23. Manual focus control

"MF" is displayed here when the focus is controlled manually. (P42)

24. Vibration reduction (()

"()" is displayed here when the vibration reduction function is used. (P38)

25. Digital zoom

This display appears when the digital zoom function is used. (P36)

26. Zoom position

The zoom position from Z00 (max. wide angle) to Z99 (max. telephoto) is displayed here.

27. Operation control

The operation control mode of the camera-recorder is displayed here.

No display : Auto mode

MNL : Manual mode

 : This is displayed while the AE lock function is working. (P41)

28. Zoom value

The zoom value is displayed here for several seconds when it has been changed. "D" appears when the digital zoom function is being used.

29. Operation mode displays

REC : Recording

● : Recording (for self-portraits)

PAUSE : Recording standby

● II : Recording standby (for self-portraits)

⏏ : Playback pause

STNDBY : Standby (cylinder heads stopped)

A.DUB ⏏ : Audio dubbing standby

A/DUB ▷ : Audio dubbing

▷ : Playback

▷▷ (<<) : Fast forward/cue (rewind/review)

▷▷ (<◁) : Slow playback (slow playback in reverse direction)

CHK : Rec check

▷▷ (<<) : Cue-up (cue-up in reverse direction)

⏏▷ (<◁) : Frame feed playback (frame feed playback in reverse direction)

BLANK : Blank search

×▷/×▷▷ (×◁/×◁◁) :

Variable-speed search (variable-speed search in reverse direction)

30. One-shot recording

An asterisk (*) appears when the camera-recorder has been set up for frame feed recording. It blinks in the shooting pause mode. (P40)

31. Counter

The following data is selected in turn each time the COUNTER button is pressed.

0 : 00. 0:

Counter value

M 0 : 00. 0:

Counter value in counter memory mode

TC XX : XX : XX. XX:

Time code value. "TC*" appears when this value cannot be read correctly from the tape.

UB XX XX XX XX:

User's bit value. "UB*" appears when this value cannot be read correctly from the tape.

32. Filename used

The name of the scene file used for the current shooting is displayed here. (P73)

In VCR mode only

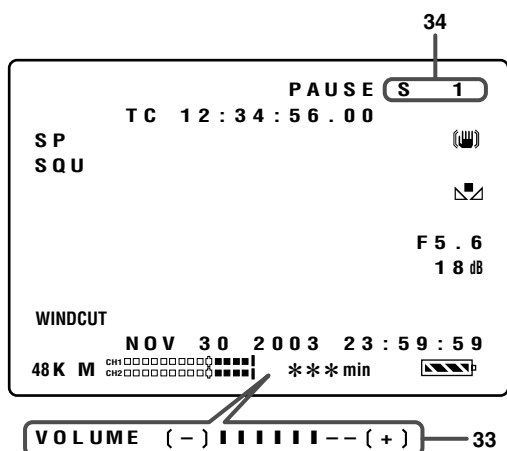

33. Monitor volume level meter

Press the multi dial to display the level meter showing the volume level of the sound that is output from the internal speaker and PHONES jack.

34. Search number

The index number used to perform the index search is displayed here. (S1 to S9)

Warnings

The following messages are displayed in the center of the screen when a problem with the camera-recorder, tape, etc. has occurred.

UNPLAYABLE TAPE (OTHER FORMAT)

The tape cannot be played back because it is in the wrong format.

COPY INHIBITED

The material cannot be recorded properly because its input signals are copy-guarded.

UNABLE TO A. DUB (LP RECORDED)

Audio dubbing cannot be performed on this tape since it was recorded in the LP mode.

INCOMPATIBLE TAPE

This tape cannot be used because it conforms to a different standard (data saving tape, etc.).

EXTERNAL DV DISCONNECT

This message appears when shooting with "EXT" selected as the DV CONTROL item setting on the OTHER FUNCTIONS screen and with no external unit connected to the DV connector. (P42, P55, P79)

FOCUS LOCK

This message appears when a problem has occurred during focusing.

ZOOM LOCK

This message appears when a problem has occurred during zooming.

PSD NG

This message appears when a problem has occurred with the vibration detection function.

AUTO OFF

AUTO OFF is displayed when a problem has occurred with the tape transport system. When it appears, the camera-recorder's power is automatically turned off.

CYLINDER LOCK

LOADING LOCK

LOW BATTERY

S REEL LOCK

(supply reel lock)

T REEL LOCK

(take-up reel lock)

UNLOADING LOCK

Using the MODE CHK button

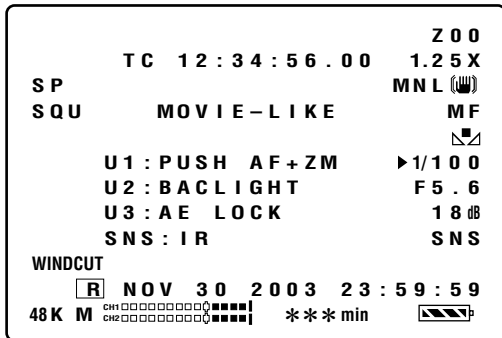

Setting the DISPLAY items

The amount of information to be displayed can be set by using the menus (P68-P71) to select the DISPLAY item setting on the DISPLAY SETUP screen. (P78)

When "PARTIAL" is selected as the DISPLAY item setting

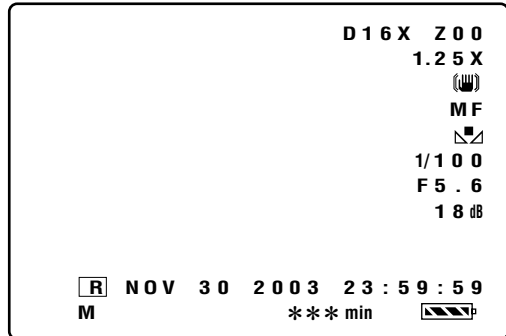

When "ALL" is selected as the DISPLAY item setting

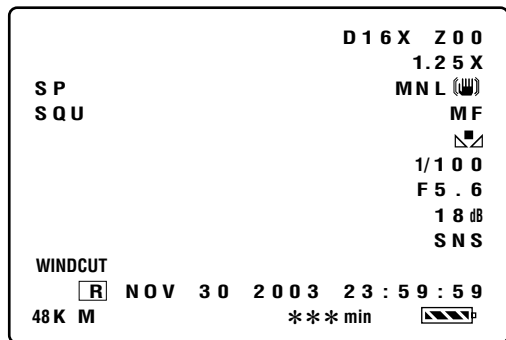

Menu operations

Using menus, you can change the camera-recorder's settings to suit the scenes to be shot or material to be recorded.

- You cannot perform menu operations while you are shooting or recording.

Setting the menu mode

I Press the MENU button.

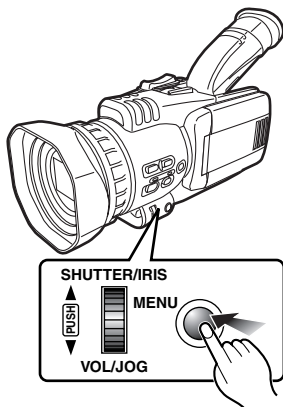

- When the remote control unit is used

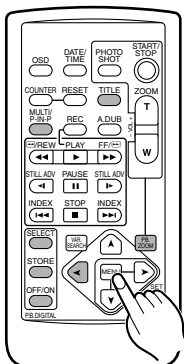

The main items now appear on the screen.

- The camera menu appears in the CAMERA mode; the VCR menu appears in the VCR mode.

[CAMERA mode]

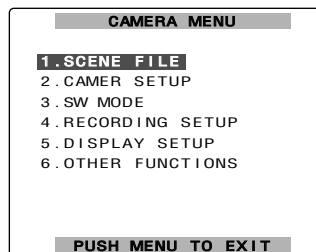

[VCR mode]

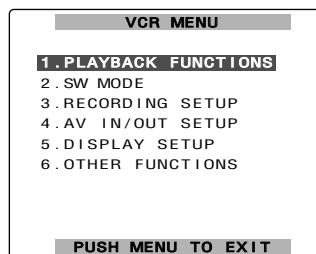

Menu operations (cont.)

Selecting the main items

2 Turn the multi dial.

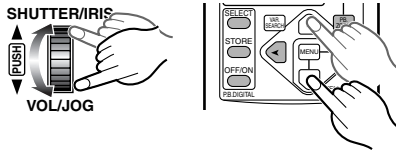

The highlighting moves to the next main item in turn.

Example:

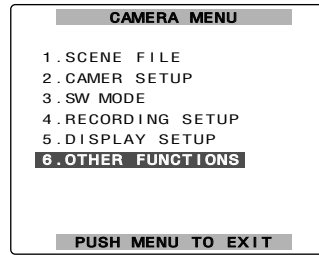

3 Press the multi dial at the position of the item to be displayed.

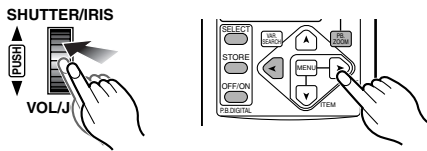

The sub items are now displayed.

Example:

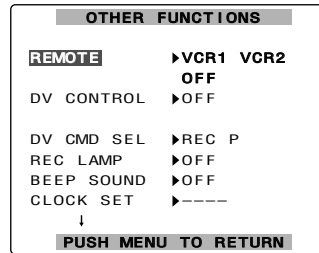

Selecting the sub items

4 Turn the multi dial.

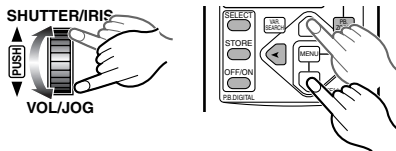

The highlighting moves to the next sub item in turn.

Example:

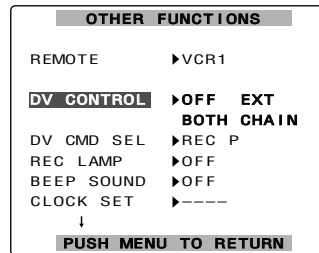

Menu operations (cont.)

Setting other sub items

6 To set another sub item, repeat steps 4 and 5.

Returning to the main item screen

7 Press the MENU button.

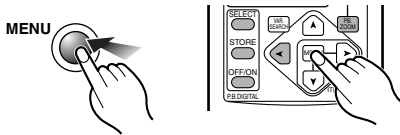

Example:

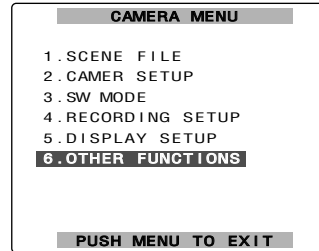

Setting other main items

8 To set another main item, repeat steps 2 to 5.

Releasing the menu mode

9 Press the MENU button again.

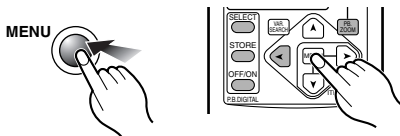

Initializing the menu settings

- When "INITIAL" is selected as the USER FILE item setting on the OTHER FUNCTIONS screen, you can return the menu settings in the currently used user file to their factory settings. (P80)
- If "INITIAL" is selected as the SAVE/INT item setting on the SCENE FILE screen while you are using a scene file (in the SETTING item on the SCENE FILE screen), you can return the menu settings in that scene file to their factory settings. (P73)

Menu configuration

CAMERA mode menu

CAMERA MENU

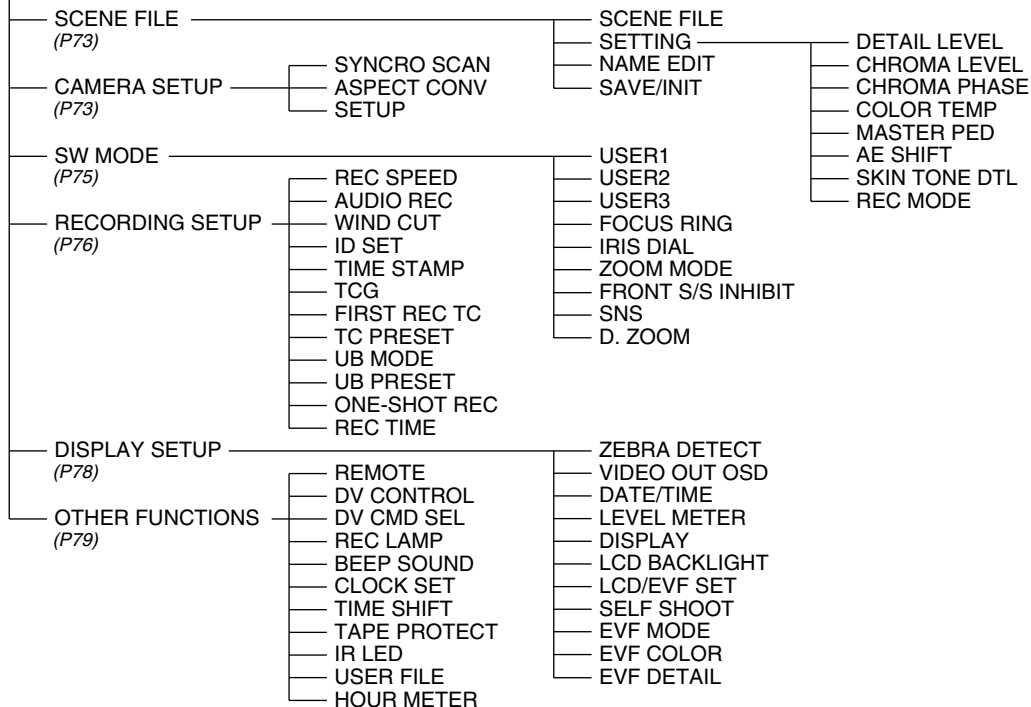

VCR mode menu

VCR MENU

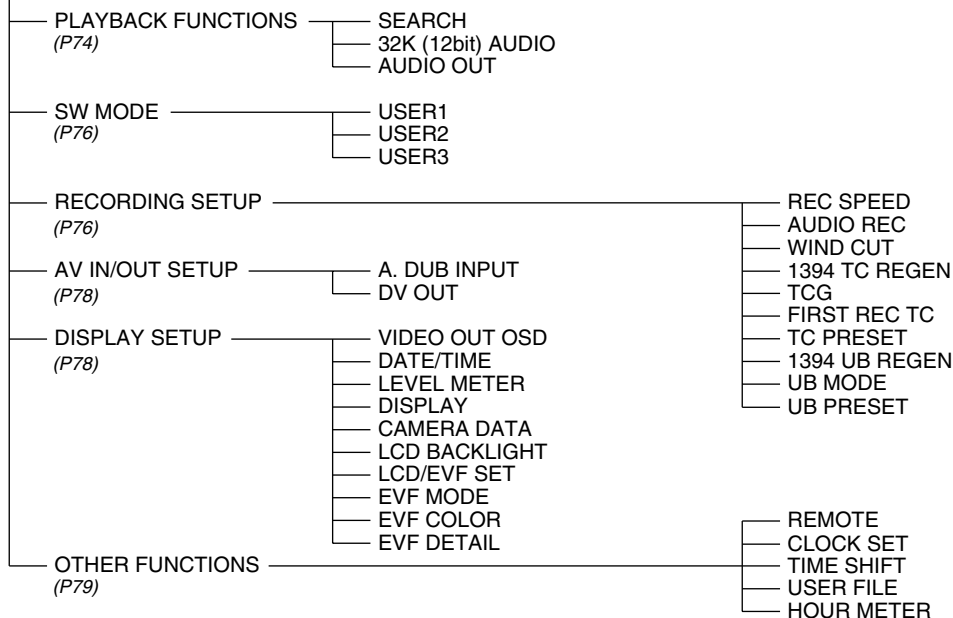

Menu configuration (cont.)

SCENE FILE screen

Item/ (Display mode)	Description of settings
SCENE FILE (CAMERA)	<p>Settings corresponding to four shooting conditions are saved as scene files in this camera-recorder. Use this item to select the scene file to be used.</p> <p>1. SCENE1: The settings of various menu items were stored in this file at the factory.</p> <p>2. SCENE2: The settings of various menu items were stored in this file at the factory.</p> <p>3. B.PRESS: This file is useful for shooting dark areas with a sharper contrast.</p> <p>4. MOVIE-LIKE: This file is useful for shooting movie-like images.</p> <p><Note> You can change the settings in the scene files using the SETTING item.</p>
SETTING (CAMERA)	<p>Use this to change the settings in the scene files.</p> <p>DETAIL LEVEL: <u>-7</u> --- 0 --- +7 Set this level in the “-” direction to soften the image outlines. When it is set in the “+” direction, the image outlines are emphasized and sharp images are produced, but the amount of noise is increased slightly.</p> <p>CHROMA LEVEL: <u>-7</u> --- 0 --- +7 Set this level in the “-” direction to make the image colors lighter. Set it in the “+” direction to make them darker.</p> <p>CHROMA PHASE: <u>-7</u> --- 0 --- +7 Use this to adjust the hue.</p> <p>COLOR TEMP: <u>-7</u> --- 0 --- +7 Set this in the “-” direction to make the images more reddish overall. Set it in the “+” direction to make the images more bluish overall.</p> <p>MASTER PED: <u>-15</u> --- 0 --- +15 Set this in the “-” direction to make the images darker overall. When a setting below -5 is selected, the dark parts of the images may become blackened out. When it is set in the “+” direction, the dark parts of the images (such as the shadows) become brighter.</p> <p>AE SHIFT: <u>-4</u> --- 0 --- +4 Use this to adjust the auto iris setting. Set it in the “-” direction for a darker setting. Set it the “+” direction for a brighter setting.</p>

Item/ (Display mode)	Description of settings
	<p>SKIN TONE DTL: <u>OFF</u>, ON When ON is selected, soft skin tones are reproduced when people are shot, making them look more attractive.</p> <p>REC MODE: <u>NORM</u> Shooting is performed using field recording (60 fields per second).</p> <p>FRAME Shooting is performed using frame recording (30 frames per second). High-quality images can be obtained at this setting when playing back still images, for example.</p>
NAME EDIT (CAMERA)	Use this to edit the name of the selected scene file.
SAVE/INIT (CAMERA)	<p>SAVE: The changed settings in the scene file (one of the files listed in the file selection item) are saved. The original scene file settings will be restored when the menu mode is released, the operation is switched to the VCR mode or when the power is turned off if SAVE has not been selected.</p> <p>INITIAL: The selected scene file settings are returned to the factory settings.</p>

CAMERA SETUP screen

Item/ (Display mode)	Description of settings
SYNCRO SCAN (CAMERA)	Use this to adjust the synchro scan shutter speed used for shooting images on a TV screen, etc. (P43, P44) <u>1/60.3</u> --- 1/250
ASPECT CONV (CAMERA)	Use this to select the aspect ratio of the images which are to be recorded. (P40) <u>NORMAL</u> , LETTER BOX, SQUEEZE
SETUP (CAMERA)	Use this to add the setup level (black level). <u>0%</u> : The setup level is not added. <u>7.5%</u> : A 7.5% setup level is added for recording.

The underlining indicates the factory setting.

Menu configuration (cont.)

PLAYBACK FUNCTION screen

Item/ (Display mode)	Description of settings
SEARCH (VCR)	Use this to set the operation to be performed when an INDEX button (▶▶ or ◀◀) on the remote control unit is pressed. PHOTO: A photo search is conducted. (P53) SCENE: An index search is conducted. (P53)
32K (12bit) AUDIO (VCR)	Use this to set the sound to be output as CH1 and CH2 signals when playing back a tape that was recorded in the 32K (12-bit) audio mode. ST1: This selects the sound that was recorded during shooting. CH1 signals = CH1 track CH2 signals = CH2 track ST2: This selects the sound that was dubbed on the recording. CH1 signals = CH3 track CH2 signals = CH4 track MIX: This mixes the sound that was recorded during shooting and the sound that was dubbed on the recording. CH1 signals = CH1 + CH3 tracks CH2 signals = CH2 + CH4 tracks <Note> When sound is recorded in the 48K (16-bit) audio mode, CH3 and CH4 do not exist so the following always stands: CH1 signals = CH1 track CH2 signals = CH2 track

Item/ (Display mode)	Description of settings
AUDIO OUT (VCR)	Use this to set the audio signals to be output from the AV IN/OUT jack when the tape is played back. CH1•CH2: CH1 output = CH1 signals CH2 output = CH2 signals CH1: CH1 output = CH1 signals CH2 output = CH1 signals CH2: CH1 output = CH2 signals CH2 output = CH2 signals

The underlining indicates the factory setting.

32K (12bit) AUDIO item/AUDIO OUT item settings and audio track signals output from the AV IN/OUT jack

Audio recording mode	32K (12bit) AUDIO item setting	AUDIO OUT item setting	AV IN/OUT jack CH1 output	AV IN/OUT jack CH2 output
32K (12-bit)	ST1	CH1•CH2 CH1 CH2	CH1 CH1 CH2	CH2 CH1 CH2
	ST2	CH1•CH2 CH1 CH2	CH3 CH3 CH4	CH4 CH3 CH4
	MIX	—	CH1+CH3	CH2+CH4
48K (16-bit)	—	CH1•CH2 CH1 CH2	CH1 CH1 CH2	CH2 CH1 CH2

SW MODE screen

Item/ (Display mode)	Description of settings
USER1 (CAMERA) (VCR)	<p>This enables one function to be allocated to the USER1 button.</p> <p>■ Camera menu mode (PUSH) AF+ZOOM: Select this to execute one-touch zooming. (P41)</p> <p>(PUSH) AF: Select this to switch to auto focus mode when the camera-recorder is operated in the manual focus mode but only while the button is held down.</p> <p>WHITE BAL: This works in the same way as the WHITE BAL button when the white balance is to be set. (P45, P46)</p> <p>AWB LOCK: Select this to enable operations to be performed with the white balance that was in effect when the button was pressed while operating the camera-recorder in the auto white balance mode. (P45)</p> <p>BACKLIGHT: Select this to set the backlight compensation function to ON or OFF. (P41)</p> <p>SPOTLIGHT: Select this to set the auto iris control for the spotlight to ON or OFF.</p> <p>REC CHECK: Select this to perform a rec check. (P14)</p> <p>D. ZOOM: Select this to perform digital zooming. (P36)</p> <p>WHITEFADE: Select this to fade out the whole image in white while the button is held down during shooting. At the same time, the sound is also faded out. Conversely, fade-in in white occurs when the button is released. At the same time, the sound is also faded in.</p> <p>BLACKFADE: Select this to fade out the whole image in black when the button is held down during shooting. At the same time, the sound is also faded out. Conversely, fade-in in black occurs when the button is released. At the same time, the sound is also faded in.</p> <p>PHOTO SHOT: Select this for photo shot recording. (P39)</p> <p>INDEX: Select this for index recording. (P41)</p> <p>SNS: Select this to set the camera-recorder to the high-sensitivity shooting mode. (P37)</p>

Item/ (Display mode)	Description of settings
	<p>EVF DTL: Select this to emphasize the outlines of the images on the screen when the button is pressed so that the subject becomes easier to bring into focus. "EVF DTL ON" appears for about 2 seconds in the center of the screen after the button has been pressed. However, the regular images are what is recorded, not the ones with their outlines emphasized. The original images are restored by pressing the button again. "EVF DTL OFF" appears for about 2 seconds in the center of the screen.</p> <p>LUMI-FLICK: Select this to make the screen flicker so that images which will give the impression that reels of photographic film are turning just as they did years ago are recorded.</p> <p>AE LOCK: Select this to set the camera-recorder to the AE lock mode. (P41)</p> <p>■ VCR menu mode BLANK SEARCH: Select this to conduct a blank search. (P52)</p> <p>AUDIO DUB: This works in the same way as the A.DUB button on the remote control unit when performing audio dubbing. (P58)</p> <p>INDEX: Select this for index recording. (P41)</p>
USER2 (CAMERA) (VCR)	<p>This enables one function to be allocated to the USER2 button. For further details, refer to the USER1 item.</p> <p>■ Camera menu mode (PUSH) AF+ZOOM, (PUSH) AF, AWB LOCK, BACKLIGHT, SPOTLIGHT, REC CHECK, D. ZOOM, WHITEFADE, BLACKFADE, PHOTO SHOT, INDEX, EVF DTL, LUMI-FLICK, AE LOCK</p> <p>■ VCR menu mode BLANK SEARCH, AUDIO DUB, INDEX</p>
USER3 (CAMERA) (VCR)	<p>This enables one function to be allocated to the USER3 button. For further details, refer to the USER1 item.</p> <p>■ Camera menu mode (PUSH) AF+ZOOM, (PUSH) AF, AWB LOCK, BACKLIGHT, SPOTLIGHT, REC CHECK, D. ZOOM, WHITEFADE, BLACKFADE, PHOTO SHOT, INDEX, EVF DTL, LUMI-FLICK, AE LOCK</p> <p>■ VCR menu mode BLANK SEARCH, AUDIO DUB, INDEX</p>

The underlining indicates the factory setting.

Menu configuration (cont.)

SW MODE screen

Item/ (Display mode)	Description of settings
FOCUS RING (CAMERA)	Use this to select the function to be allocated to the focus ring. ZOOM: Zooming can be performed using the focus ring when the camera-recorder is operated in the auto focus mode. IRIS: Iris adjustments can be performed using the focus ring when the camera-recorder is operated in the auto focus mode and the iris is to be adjusted manually. OFF: The focus ring is used to perform manual focus adjustments only.
IRIS DIAL (CAMERA)	Use this to set how the iris is to be controlled by the direction in which the multi dial is rotated when the iris is to be adjusted manually. DOWN OPEN: The iris opens when the multi dial is turned downward. UP OPEN: The iris opens when the multi dial is turned upward.
ZOOM MODE (CAMERA)	Use this to set the speed of the motor-driven lens zoom. (P36) NORM: Standard HIGH : High speed LOW : Low speed
FRONT S/S INHIBIT (CAMERA)	Use this to set whether the recording operation is to be performed using the START/STOP button on the lens. OFF: Recording is permitted. ON: Recording is inhibited so as to prevent operation from being conducted by mistake.
SNS (CAMERA)	Use this to select the high-sensitivity shooting mode. (P37) <u>IR</u> , <u>SUPER_IR</u> , <u>COLOR_NS</u>
D. ZOOM (CAMERA)	Use this to select the magnification level for the digital zoom. (P36) <u>x24</u> , <u>x160</u>

RECORDING SETUP screen

Item/ (Display mode)	Description of settings
REC SPEED (CAMERA) (VCR)	Use this to select the recording duration mode. SP: SP (standard recording) mode. LP: LP (long recording) mode.
AUDIO REC (CAMERA) (VCR)	Use this to select the digital audio recording system. 32K (12bit): The sound is recorded using the 12-bit/32 kHz (4 channels) recording system. Select this mode when leaving the sound heard during shooting intact even when audio dubbing is performed on an existing recording. 48K (16bit): The sound is recorded using the 16-bit/48 kHz (2 channels with a good sound quality) recording system. The sound heard during shooting will be erased when dubbing over an existing recording.
WIND CUT (CAMERA) (VCR)	Select ON to reduce the noise generated by the wind blowing into the microphone in windy conditions. OFF, ON
ID SET (CAMERA)	Use this to set the ID (5 characters) information. The ID information set is displayed when the color bar mode is established. ● Characters which can be set: □ (space), A to Z, 0 to 9, ;, ,, /
TIME STAMP (CAMERA)	Set this to REC to record the date and time that were selected using the DATE/TIME setting item (P78) on the DISPLAY SETUP screen as an image on the tape. NO-REC, REC
1394 TC REGEN (VCR)	Use this to select the time code to be recorded when recording the signals of the unit connected to the DV connector. OFF: The time code that was selected using the TCG setting item and FIRST REC TC setting item is used for the recording. ON: The time code of the signals which are input to the DV connector are used for the recording. ● When ON has been selected for this item, the time code of the signals concerned takes precedence over the TCG item and FIRST REC TC item settings. ● If no signals are input to the DV connector, the TCG item and FIRST REC TC item settings are used.

The underlining indicates the factory setting.

RECORDING SETUP screen

Item/ (Display mode)	Description of settings
TCG (CAMERA) (VCR)	Use this to set the mode in which to advance the time code. FREE RUN: The time code is advanced continuously regardless of the operation mode. It is recorded on the basis of the time appearing on the camera-recorder's calendar clock. REC RUN: The time code is advanced only when recording is underway. It is recorded while ensuring that continuity is maintained with the time code already recorded on the tape when shooting with frame-to-frame continuity.
FIRST REC TC (CAMERA) (VCR)	Use this to select the time code to be recorded when recording is started. REGEN: Select this to record the time code that will ensure continuity with the time code already on the tape. The time code is recorded in the REC RUN mode regardless of the setting selected for the TCG item. PRESET: Select this to record the time code using the value selected by the TC PRESET item as the initial value. However, when shooting with frame-to-frame continuity has taken place, the time code is recorded to ensure continuity with the time code already on the tape.
TC PRESET (CAMERA) (VCR)	Use this to set the initial value of the time code to be recorded. The item takes effect when "PRESET" has been selected as the FIRST REC TC item setting.
1394 UB REGEN (VCR)	Use this to select the user's bit to be recorded when recording the signals of the unit connected to the DV connector. OFF: The user's bit selected by the UB MODE item is recorded. ON: The user's bit of the signals input to the DV connector is recorded. <ul style="list-style-type: none"> • When "ON" has been selected as this item's setting, it takes precedence over the UB MODE item setting. • If the signals do not contain the user's bit information, the user's bit is not recorded. • If no signals are input to the DV connector, the UB MODE item setting is used for the recording.

Item/ (Display mode)	Description of settings
UB MODE (CAMERA) (VCR)	Use this to set what is to be recorded as the user's bit. USER: The user's information is recorded. TIME: The recording time is recorded. DATE: The recording date is recorded. TCG: The time code is recorded.
UB PRESET (CAMERA) (VCR)	Use this to set the user's bit. For this, however, "USER" must have been selected as the UB MODE item setting.
ONE-SHOT REC (CAMERA)	Use the ON setting when shooting on a frame-by-frame basis. OFF: Frame-by-frame shooting is not performed. ON: The camera-recorder is set to the frame-by-frame shooting mode. When the START/STOP button is pressed, recording proceeds for the number of seconds selected by the REC TIME item setting, and then the camera-recorder is set to the REC PAUSE mode.
REC TIME (CAMERA)	Use this to set the recording time for frame-by-frame shooting. <u>0.5s</u> : 0.5 sec. 1s : 1.0 sec. 1.5s : 1.5 sec. 2s : 2.0 sec.

The underlining indicates the factory setting.

Menu configuration (cont.)

AV IN/OUT SETUP screen

Item/ (Display mode)	Description of settings
A. DUB INPUT (VCR)	Use this to select the sound to be recorded when performing audio dubbing. MIC: The sound of the internal microphone or external microphone is recorded. (P58) A_IN: The sound of the audio unit connected to the AV IN/OUT jack is recorded. <Note> If audio dubbing is performed on a recording which was made in the 48K (16-bit) audio mode, the sound heard during shooting will be overwritten and the dubbed sound recorded in its place.
DV OUT (VCR)	Select the ON setting when converting analog input signals into digital signals and outputting them from the DV connector. OFF, ON

DISPLAY SETUP screen

Item/ (Display mode)	Description of settings
ZEBRA DETECT (CAMERA)	Use this to set the brightness level at which the zebra patterns are to be displayed. 80%, 85%, 90%, 95%, 100%, 105%
VIDEO OUT OSD (CAMERA) (VCR)	Select the ON setting to output the information displayed on the screen together with the signals from the AV IN/OUT jack. ON, OFF
DATE/TIME (CAMERA) (VCR)	Use this to set whether to display the date and/or time on the screen and on the signals that are output from the AV IN/OUT jack. OFF: The date and time are not displayed. TIME: The time is displayed. DATE: The date is displayed. TIME&DATE: The date and time are displayed. ● If any setting other than OFF is selected, the time and/or date are displayed for the signals that are output from the AV IN/OUT jack, regardless of the setting selected for the VIDEO OUT OSD item.
LEVEL METER (CAMERA) (VCR)	Select ON to display the audio level meter on the screen. OFF, ON
DISPLAY (CAMERA) (VCR)	Use this to set the amount of information to be displayed on the screen. (P67) OFF, PARTIAL, ALL
CAMERA DATA (CAMERA) (VCR)	With the ON setting, the camera settings (vibration reduction, F-number, gain value and white balance information) at the time of shooting are displayed when the tape is played back. OFF, ON <Note> When a tape on which the unit's camera settings has been recorded is played back on another unit, the camera settings may not be displayed properly.
LCD BACKLIGHT (CAMERA) (VCR)	Use this to adjust the backlight of the LCD monitor. When HI is selected, the backlight is made brighter than usual. HI, NORMAL

The underlining indicates the factory setting.

Menu configuration (cont.)

DISPLAY SETUP screen

Item/ (Display mode)	Description of settings
LCD/EVF SET (CAMERA) (VCR)	Use this to adjust the display level of the images appearing in the viewfinder or on the LCD monitor. LCD BRIGHTNESS: Select this to adjust the brightness of the images on the LCD monitor. LCD COLOR LEVEL: Select this to adjust the color level of the images on the LCD monitor. EVF BRIGHTNESS: Select this to adjust the brightness of the images in the viewfinder.
SELF SHOOT (CAMERA)	When MIRROR is selected, an image with the left and right sides reversed will appear on the LCD monitor when shooting a self-portrait. NORMAL, MIRROR
EVF MODE (CAMERA) (VCR)	Use this to select to switch the screen images. ON: The images are always displayed in the viewfinder. AUTO: The images in the viewfinder are cleared when the LCD monitor is opened.
EVF COLOR (CAMERA) (VCR)	Select ON to display the images on the viewfinder screen in color. OFF: The images are displayed in black and white. ON: The images are displayed in color.
EVF DETAIL (CAMERA) (VCR)	When ON is selected, the contours of the images in the viewfinder and on the LCD monitor are emphasized to make focusing easier. However, the images recorded will be normal images without emphasized contours. OFF, ON

OTHER FUNCTIONS screen

Item/ (Display mode)	Description of settings
REMOTE (CAMERA) (VCR)	Use this to set the operations to be performed using the accessory remote control unit. (P25) VCR1: Operations performed using the remote control unit which has been set up for use with VCR1 are accepted. VCR2: Operations performed using the remote control unit which has been set up for use with VCR2 are accepted. OFF: No operations performed using a remote control unit are accepted.
DV CONTROL (CAMERA)	Use this to set the control method to be used when a backup unit is connected to the DV connector and backup recording is to be performed. OFF: The backup unit is not controlled. EXT: The backup unit is controlled using the camera-recorder's START/STOP button. The images shot using the camera-recorder are recorded using the backup unit. (The camera-recorder does not perform the recording operation.) BOTH: The images shot using the camera-recorder are recorded by both the camera-recorder and the backup unit. CHAIN: When the camera-recorder's tape approaches its end during shooting, recording is automatically started by the backup unit that has been waiting in the recording standby mode.
DV CMD SEL (CAMERA)	Use this to set the recording operation to be performed by the backup unit when the camera-recorder's START/STOP button is pressed. REC_P: The START/STOP button switches between recording and rec pause. STOP: The START/STOP button switches between recording and stop. <Note> If the backup unit does not have a rec pause function, select STOP.
REC LAMP (CAMERA)	Select ON to light the tally lamp during shooting. (P84) OFF, ON

The underlining indicates the factory setting.

Menu configuration (cont.)

OTHER FUNCTIONS screen

Item/ (Display mode)	Description of settings
BEEP SOUND (CAMERA)	<p>Select ON to be warned by a beep that the shooting has started or ended or that a problem has occurred. <u>OFF, ON</u></p> <p>The beeps are output as audio signals from the PHONES jack and AV IN/OUT jack. When a beep is sounded, the audio signals from the built-in microphone are muted and the beep is output instead.</p> <p>One beep sounds:</p> <ul style="list-style-type: none"> when the POWER lever is set to the ON position when shooting has started <p>Two beeps sound:</p> <ul style="list-style-type: none"> when shooting is paused <p>10 beeps sound in succession:</p> <ul style="list-style-type: none"> when a cassette tape has not been inserted when the cassette tape is set to the recording inhibited status when condensation has formed inside the camera-recorder when a problem has occurred in the camera-recorder
CLOCK SET (CAMERA) (VCR)	Use this to set the camera-recorder's internal calendar.
TIME SHIFT (CAMERA) (VCR)	<p>The time set using this item is added to the clock time of the internal calendar (time difference compensation) and displayed on the viewfinder and LCD monitor. The added time is also recorded on the tape. <u>+23h --- +1h, OFF, -1h --- -23h</u> (In 1-hour increments)</p>
TAPE PROTECT (CAMERA)	<p>When the camera-recorder has been left in the pause mode for about 5 minutes, it is automatically set to the tape protection mode.</p> <p>Use this item to select the kind of tape protection mode to be established.</p> <p>POWER OFF: The camera-recorder's power is set to OFF.</p> <p>STBY: The cylinder head is set to the stop status.</p>
IR LED (CAMERA)	<p>Use this to set the control over the infrared light which is used during high-sensitivity recording. (P37)</p> <p>AUTO: The infrared light comes on as soon as the high-sensitivity shooting mode is established.</p> <p>OFF: The infrared light does not come on no matter whether the high-sensitivity shooting mode is established or not.</p>

Item/ (Display mode)	Description of settings
USER FILE (CAMERA) (VCR)	<p>LOAD: The menu (except scene file) settings which were saved last are loaded.</p> <p>SAVE: The changed menu settings are saved.</p> <p>INITIAL: The menu settings are returned to the factory settings.</p> <ul style="list-style-type: none"> When the power is turned off without selecting SAVE, the VCR mode menu settings will be saved but the CAMERA mode menu settings will be returned to the original settings. When a LOAD or INITIAL operation has been performed, set the camera-recorder's POWER lever first to the OFF position and then back to ON in order to ensure that the settings concerned will take effect.
HOURL METER (CAMERA) (VCR)	Use this to display the total running time (a 5-digit figure in 1-hour increments) of the cylinder head.

The underlining indicates the factory setting.

Before calling for service

Power supply

There's no power.

- Have the battery and AC adapter been connected properly?
Check the connections again. (P12, P24)

Power shuts off for no apparent reason.

- To prevent the battery from running down needlessly and to safeguard the tape from wear, the camera-recorder's power is automatically turned off when the camera-recorder has been left in the shooting pause mode for more than 5 minutes.
Check the setting you have selected for the TAPE PROTECT item on the OTHER FUNCTIONS screen. (P80)

Power goes off as soon as it is turned on.

- Has the battery run out?
If the remaining battery charge display is blinking or the  display appears, it means that the battery has run out.
Either recharge the battery or replace the discharged battery with a fully charged one. (P23)
- Has any condensation formed?
At times when, for instance, the camera-recorder is taken from a cold place to a heated room, condensation may form inside. If this happens, the power is automatically turned off and the only operation that you will be able to perform is to remove the cassette. Wait until the condensation has dried out. (P84)

Battery

The battery runs down quickly.

- Has the battery been fully charged?
Keep charging it until the AC adapter's CHARGE lamp goes off. (P23)
- Are you using the battery in a cold place?
The battery is affected by the ambient temperature. Its operating time is reduced in low-temperature locations.
- Has the battery reached the end of its service life?
The battery has a fixed service life which differs depending on how the battery is used. If the battery operates only for a short period even when it is charged adequately, it means that it has reached the end of its service life.

The battery cannot be charged.

- Is the DC cord connected to the AC adapter?
You cannot charge the battery if this cord is connected.

Normal video recording

I can't record even though I've inserted the cassette tape properly.

- Is the tab on the cassette tape used to prevent accidental erasure at the open (SAVE) position?
You cannot record if this tab is open. (P18)
- Has the cassette tape come to the very end?
If so, replace it with another one.
- Is the POWER lever at the ON position?
- Is the VCR lamp lighted?
You cannot shoot in the VCR mode.
- Has condensation formed?
If it has formed, the only operation you can perform is to remove the cassette tape. Wait until the condensation has dried out. (P84)
- Has the AUTO OFF or T REEL LOCK warning display appeared?
Check the tape as it may have snapped.
- Is the external unit disconnected from the DV connector while you are trying to perform backup recording with "EXT" selected as the DV CONTROL item setting on the OTHER FUNCTIONS screen? (P79)

Other types of video recording

The subject is not brought into focus automatically.

- Is the manual focus mode established?
You can focus automatically only when the auto focus mode is established. (P35, P42)
- Are you shooting a scene where it's hard to bring the subject into focus in the auto focus mode?

Some subjects are hard to bring into focus in the auto focus mode. If this is the case, bring the subject into focus in the manual focus mode.

It may be hard to bring the subject into focus when:

1. both close and distant objects are to be shot
2. shooting through dirty windows or other glass
3. shooting in dark places
4. there are sparkling or shiny objects around the subject
5. subjects are moving fast
6. shooting scenes with minimal contrast
7. shooting at a low shutter speed

Editing

I can't perform audio dubbing.

- Is the tab on the cassette tape used to prevent accidental erasure at the open (SAVE) position?
You cannot edit if this tab is open. (P18)
- Are you trying to edit a part that was shot in the LP mode?
You cannot perform audio dubbing on tapes recorded in the LP mode because the tracks on the tape in this mode are narrower than the head width.

Displays

There's something wrong with the time code display.

- If a tape is played in the reverse slow mode, the time code display may not register a regular count, but this is not a sign of malfunctioning.

The remaining tape display differs from the actual amount of tape remaining.

- The remaining tape is not displayed accurately if you shoot continuously for periods of less than 30 seconds.
- The display may show 2 to 3 minutes less remaining tape than the time actually remaining on the tape.

Playback (images)

I can't play back a tape even when I press the play button.

- Is the VCR lamp lighted?
No kind of playback operation can be performed unless this lamp is lighted. (P49)

Mosaic-like noise appears when I cue or review a tape.

- This noise is inherent to digital video technology. It is not a sign of malfunctioning.

Playback images do not appear on the TV screen even though I have connected the camera-recorder to the TV set properly.

- Is the TV input selector set to "video input?"
Read the TV set's instruction manual carefully, and select the video input connector you should use to connect your camera-recorder.

The playback images are not displayed clearly.

- Are the camera-recorder's heads dirty?
The playback images will not be displayed clearly if these heads are dirty.

Playback (sound)

I can't hear any sound from the camera-recorder's speaker.

- Have you turned down the camera-recorder's volume control too far?
In the VCR mode, adjust the volume level using the multi dial. (P50)

I can hear two sets of sound.

- Have you selected "MIX" as the 32K (12bit) AUDIO item setting on the PLAYBACK FUNCTION screen? (P74)
- If you perform audio dubbing on a tape that was recorded with "32K (12bit)" selected as the AUDIO REC item setting on the RECORDING SETUP screen, you will hear the sound heard during recording and that of the audio dubbing. (P76)

When I performed audio dubbing on an existing recording, the original sound was erased.

- If you perform audio dubbing on a tape that was recorded with "48K (16bit)" selected as the AUDIO REC item setting on the RECORDING SETUP screen, you will erase the original sound on the tape. To leave the original sound intact, make sure that "32K (12bit)" is selected as the item setting when you shoot the original recording. (P76)

Other

I can't remove the cassette tape.

- Is power still being supplied to the camera-recorder? (Is the power from the AC adapter and battery supplied properly?)
So long as the power is supplied, you can remove the cassette even if the POWER lever is at the OFF position.

I can remove the cassette but I can't perform any other operations.

- Has condensation formed?
If it forms, the only operation you can perform is to remove the cassette. Wait until the condensation has dried out. (P84)
- If the cassette cover is closed immediately after sliding the EJECT switch to open the cassette cover, you may no longer be able to perform any operations other than eject.
If you did this, slide the EJECT switch again to open the cassette cover, check that the cassette mechanism has finished ejecting the cassette, and then close the cassette cover.

The remote control unit does not work.

- Has the button battery in the remote control unit run out?
If the remote control fails to work even when it is operated near the camera-recorder's remote control sensor, it means that the button battery has run out. Replace it with a new one. (P25)
- Is the remote control setting the same for the remote control unit and the camera-recorder?
If the REMOTE item setting does not correspond between the two units, the remote control unit will not work. (P25, P79)

I hear a rattling sound when I tilt the camera-recorder back and forth.

- There are some parts in the structure of the camera unit that make a rattling sound in the VCR mode or when the POWER lever is at the OFF position. This is not a sign that something is broken.

Condensation

How to find out whether there is condensation inside and what to do about it if it has formed

If the  condensation mark blinks after the camera-recorder's power has been turned on, it means that condensation has formed inside the camera-recorder. If this has happened, the power is automatically turned off within a matter of seconds.

Take the following action.

① Remove the cassette

No other functions will be operational. It may not even be possible to remove the cassette tape depending on the amount of condensation. If this is the case, wait two to three hours before removing the cassette.

② Wait two to three hours with the cassette holder open.

The time you need to wait will differ depending on the amount of condensation and the ambient temperature.

③ Turn on the power two to three hours later and check whether or not the condensation display has gone off.

To make doubly sure, wait another hour or so after the condensation display has gone off before using the camera-recorder again.

Also remember that even when the condensation display has not appeared, condensation may be forming.

- Condensation builds up gradually so the condensation display may not appear for 10 to 15 minutes after it has started to form inside.
- In very cold areas, the condensation may freeze. If this happens, it will take another two to three hours for it to thaw out.

Tally lamp

The tally lamp can be made to light up during shooting by selecting "ON" as the REC LAMP item (P79) setting on the OTHER FUNCTIONS screen.

When the camera-recorder is in any of the following statuses, the tally lamp blinks.

- When the remaining charge of the battery is low
- When there is not much tape left
- When trouble has occurred in the tape transport system
- When an operation initiated by the remote control unit has been received
- When the camera-recorder's mode is being switched to shooting

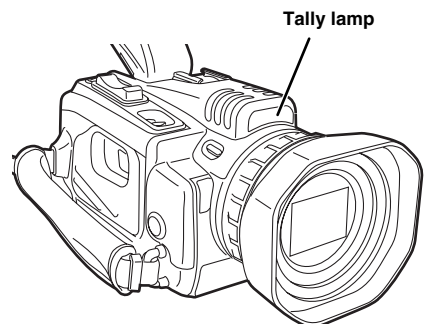

System resetting

Reset the system microcomputer if you can no longer operate the camera-recorder even though its power is on or a similar kind of a problem has occurred.

Use a pointed object to press the RESET button on the camera-recorder. This will reset the system microcomputer.

The menu settings entered and memory contents will not be cleared even when the system is reset.

Do not press the RESET button when the camera-recorder is operating normally.

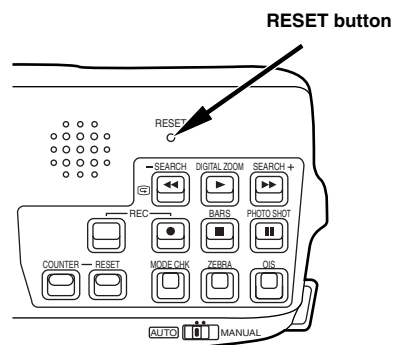

Specifications

[GENERAL]

Supply voltage: DC 7.2 V/7.9 V

Power consumption:

5.0 W (when the viewfinder is used)

6.1 W (when the LCD monitor is used)

Power consumption when XLR microphone adapter (AG-MYA30G) is connected:

6.2 W (when the viewfinder is used)

7.4 W (when the LCD monitor is used)

8.5 W (maximum)

 indicates safety information.

Ambient operating temperature

32°F to 104°F (0°C to 40°C)

Ambient operating humidity

10% to 85% (no condensation)

Weight

2.31 lb (1.05 kg)

(excluding battery and accessories)

Dimensions (W×H×D)

4 3/8×4 5/8×10 inches (110×116×253 mm)

The height increases to 6 5/16 inches (160 mm) when the handle is attached.

Recording format

Digital video SD format

Tape format

Mini DV system

Video signals recorded

525i (NTSC)

Shooting mode

60i

Audio signals recorded

PCM digital recording

16 bits: 48 kHz/2 channels

12 bits: 32 kHz/4 channels

Recording tracks

Digital video/audio:

Helical tracks

Time code:

Helical track (sub code area)

Tape speeds

SP mode: 18.812 mm/sec.

LP mode: 12.555 mm/sec.

Recording time (when AY-DVM60 is used)

SP mode: 60 minutes

LP mode: 90 minutes

Tapes used

6.35 mm wide metal tapes

FF/REW time

Approx. 140 sec. (when AY-DVM60 is used)

Pickup devices

Interline transfer 1/4-inch CCD image sensor (×3)

Number of pixels

Total number of pixels: 410,000,

Number of effective pixels: 380,000

(pixel offset system)

Lens

Leica DICOMAR optical image stabilizer lens, motorized 16× zoom,

F1.6 (f=4.1 to 65.6 mm)

(35 mm equivalent: 39.5 to 632 mm)

Color separation optical system

Prism system

ND filter

Interlocked with iris, auto ON/OFF

Gain settings

0, +3, +6, +9, +12, +15, +18 dB

Shutter speed settings

Slow shutter speeds:

1/4, 1/8, 1/15, 1/30 sec.

Regular shutter speeds:

1/60, 1/100, 1/120, 1/180, 1/250, 1/350,

1/500, 1/750, 1/1000, 1/1500, 1/2000,

1/3000, 1/4000, 1/8000 sec.

Synchro scan shutter speeds:

1/60.3 to 1/250 sec.

Minimum subject illuminance

4 lux:

F1.6, +18 dB gain, 50 IRE video output

Lens hood

Large-sized lens hood with wide angle of view

Filter diameter

43 mm

LCD monitor

3.5-inch LCD color monitor, 200,000 pixels

Viewfinder

0.44-inch, LCD color viewfinder, 180,000 pixels

Internal microphone

Stereo microphone

Internal speaker

20 mm diameter

Specifications (cont.)

[VIDEO]

Sampling frequency

Y: 13.5 MHz, PB/PR: 3.375 MHz

Quantizing

8 bits

Video compression system

DCT + variable-length code

Error correction

Reed-Solomon product code

[AUDIO]

Sampling frequency

48 kHz/32 kHz

Quantizing

16 bits/12 bits

Frequency response

20 Hz to 20 kHz

Wow & flutter

Below measurable limits

[CONNECTORS]

MIC

Stereo (3.5 mm diameter)

Mic sensitivity: -70 dBV

S-VIDEO IN/OUT

(input/output switched automatically)

S-connector, Y/C separate signal

input/output

Y: 1.0 V [p-p], C: 0.286 V [p-p], 75 Ω

AV IN/OUT

(input/output switched automatically)

Mini jack (3.5 mm diameter)

Video:

Analog composite input/output, 1.0 V [p-p],
75 Ω

Audio (CH1, CH2):

Input: -10 dBV, high impedance

Output: -10 dBV, low impedance

XLR ADAPTER

Dedicated mini XLR connector

DC input (INPUT 7.9 V)

DC 7.9 V

PHONES

Stereo (3.5 mm diameter)

DV

4 pins, digital input/output, compliant with

IEEE 1394 standard

CAM REMOTE

Mini jack (2.5 mm diameter)

[AC ADAPTER]

Power Source:

110/120/220/240 V AC, 50/60 Hz

Power Consumption:

18 W

 indicates safety information.

Weight

0.35 lb (0.16 kg)

Dimensions (W×H×D)

2 13/16 × 1 13/16 × 4 5/8 inches

(70 × 44.5 × 116 mm)

[OPTIONAL UNITS]

Wide conversion lens

AG-LW4307P

Stereo microphone

AG-MC15P

XLR microphone

AG-MC100G

XLR microphone adapter

AG-MYA30G

Infrared light

AG-YRL30G

Hard carrying case

AG-HT30G

Soft carrying case

AG-SC100G

Battery

CGR-D16

(1600 mAh: equivalent to accessory
battery)

CGP-D28 (2800 mAh)

CGA-D54 (5400 mAh)

AC adapter kit

AG-B15 (equivalent to accessory AC cord,
DC cord, AC adapter)

Cleaning tape

AY-DVMCLA

Weight and dimensions shown are approximate.
Specifications are subject to change without
notice.

Panasonic

PANASONIC BROADCAST & TELEVISION SYSTEMS COMPANY
UNIT COMPANY OF MATSUSHITA ELECTRIC CORPORATION OF AMERICA

Executive Office:

One Panasonic Way 4E-7, Secaucus, NJ 07094 (201) 348-7000

EASTERN ZONE:

One Panasonic Way 4E-7, Secaucus, NJ 07094 (201) 348-7621

Southeast Region:

1225 Northbrook Parkway, Ste 1-160, Suwanee, GA 30024 (770) 338-6835

Central Region:

1707 N Randall Road E1-C-1, Elgin, IL 60123 (847) 468-5200

WESTERN ZONE:

3330 Cahuenga Blvd W., Los Angeles, CA 90068 (323) 436-3500

Government Marketing Department:

52 West Gude Drive, Rockville, MD 20850 (301) 738-3840

Broadcast PARTS INFORMATION & ORDERING:

9:00 a.m. – 5:00 p.m. (EST) (800) 334-4881/24 Hr. Fax (800) 334-4880

Emergency after hour parts orders (800) 334-4881

TECHNICAL SUPPORT:

Emergency 24 Hour Service (800) 222-0741

Panasonic Canada Inc.

5770 Ambler Drive, Mississauga, Ontario L4W 2T3 (905) 624-5010

Panasonic de Mexico S.A. de C.V.

Av angel Urraza Num. 1209 Col. de Valle 03100 Mexico, D.F. (52) 1 951 2127

Panasonic Sales Company

Division of Matsushita Electric of Puerto Rico Inc.

San Gabriel Industrial Park, 65th Infantry Ave., Km. 9.5, Carolina, Puerto Rico 00630 (787) 750-4300

Free Manuals Download Website

<http://myh66.com>

<http://usermanuals.us>

<http://www.somanuals.com>

<http://www.4manuals.cc>

<http://www.manual-lib.com>

<http://www.404manual.com>

<http://www.luxmanual.com>

<http://aubethermostatmanual.com>

Golf course search by state

<http://golfingnear.com>

Email search by domain

<http://emailbydomain.com>

Auto manuals search

<http://auto.somanuals.com>

TV manuals search

<http://tv.somanuals.com>