

PENTAX



Digital Camera

Optio WS80

Operating Manual



To ensure the best performance from your camera, please read the Operating Manual before using the camera.

Thank you for purchasing this PENTAX Digital Camera. Please read this manual before using the camera in order to get the most out of all the features and functions. Keep this manual safe, as it can be a valuable tool in helping you to understand all the camera's capabilities.

Regarding copyrights

Images taken using the PENTAX Digital Camera that are for anything other than personal enjoyment cannot be used without permission according to the rights as specified in the Copyright Act. Please take care, as there are cases where limitations are placed on taking pictures even for personal enjoyment during demonstrations, performances or of items on display. Images taken with the purpose of obtaining copyrights also cannot be used outside the scope of use of the copyright as laid out in the Copyright Act, and care should be taken here also.

Regarding trademarks

- PENTAX, Optio and smc PENTAX are trademarks of HOYA CORPORATION.
- SDHC logo () is a trademark.
- ©2008 ACD Systems Ltd. All rights reserved. ACDSee and the ACDSee logo are trademarks of ACD Systems Ltd. in Canada, the U.S., Europe, Japan and other countries.
- Microsoft and Windows are registered trademarks of Microsoft Corporation in the United States and other countries. Windows Vista is either a registered trademark or trademark of Microsoft Corporation in the United States and/or other countries.
- Macintosh and Mac OS are trademarks of Apple Inc., registered in the U.S. and other countries.
- This product supports PRINT Image Matching III. PRINT Image Matching enabled digital still cameras, printers and software help photographers to produce images more faithful to their intentions. Some functions are not available on printers that are not PRINT Image Matching III compliant. Copyright 2001 Seiko Epson Corporation. All Rights Reserved. PRINT Image Matching is a trademark of Seiko Epson Corporation. The PRINT Image Matching logo is a trademark of Seiko Epson Corporation.
- All other brands or product names are trademarks or registered trademarks of their respective companies.

Regarding Product Registration

In order to better serve you, we request that you complete the product registration, which can be found on the CD-ROM supplied with the camera or the PENTAX website. Thank you for your cooperation.
Refer to "Connecting to a Computer" (p.211) for more information.

To users of this camera

- Do not use or store this device in the vicinity of equipment that generates strong electromagnetic radiation or magnetic fields.
Strong static charges or the magnetic fields produced by equipment such as radio transmitters could interfere with the monitor, damage the stored data, or affect the product's internal circuitry and cause camera misoperation.
- The liquid crystal panel used in the display is manufactured using extremely high precision technology. Although the level of functioning pixels is 99.99% or better, you should be aware that 0.01% or fewer of the pixels may not illuminate or may illuminate when they should not. However, this has no effect on the recorded image.
- If you point the camera toward an object that is bright, a band of light may appear on the screen display. This phenomenon is referred to as "smear" and is not a malfunction of the camera.
- There is a possibility that the illustrations and the display screen in this manual are different from the actual product.
- In this manual, both an SD Memory Card and an SDHC Memory Card are referred to as SD Memory Cards hereafter.
- In this manual, the generic term "computer(s)" refers to either a Windows PC or a Macintosh hereafter.

Using Your Camera Safely

We have paid close attention to the safety of this product. When using this product, we request your special attention regarding items marked with the following symbols.



Warning This symbol indicates that violating this item could cause serious personal injuries.



Caution This symbol indicates that violating this item could cause minor or medium personal injuries, or loss of property.

About the Camera

Warning

- Do not disassemble or modify the camera. High voltage areas are present inside the camera, with the risk of electric shock.
- If the camera interior is exposed due to dropping or otherwise damaging the camera, never touch the exposed portion. There is a risk of electric shock.
- Wrapping the strap around your neck is dangerous. Take care that small children do not hang the strap around their necks.
- If any irregularities occur during use, such as smoke or a strange odor, stop use immediately, remove the battery or the AC adapter, and contact your nearest PENTAX Service Center. Continuing to use the product can cause a fire or electric shock.

Caution

- Do not place your finger over the flash when discharging the flash. You may burn yourself.
- Do not cover the flash with clothing when discharging the flash. Discoloration may occur.
- Some portions of the camera heat up during use. There is a risk of low temperature burns when holding such portions for long periods.
- Should the monitor be damaged, be careful of glass fragments. Also, be careful not to allow the liquid crystal to get on your skin, in your eyes or mouth.
- Depending on your individual factors or physical condition, the use of the camera may cause itching, rashes or blisters. In case of any abnormality, stop using the camera and get medical attention immediately.

About the Battery Charger and the AC Adapter

Warning

- Always use the battery charger and AC adapter exclusively developed for this product, with the specified power and voltage. Using a battery charger or AC adapter not exclusive to this product, or using the exclusive battery charger or AC adapter with an unspecified power or voltage can cause a fire, electric shock, or camera breakdown. The specified voltage is 100 - 240V AC.

- Do not disassemble or modify the product. This can cause a fire or electric shock.
- If the generation of smoke or strange odor from the product or other abnormality occurs, immediately discontinue use and consult a PENTAX Service Center. Continuing to use the product can cause a fire or electric shock.
- If water should happen to get inside the product, consult a PENTAX Service Center. Continuing to use the product can cause a fire or electric shock.
- If a thunder storm should occur while using the battery charger, unplug the AC plug cord and discontinue use. Continuing to use the product can cause damage to the equipment, fire, or electric shock.
- Wipe off the plug of the AC plug cord if it becomes covered with dust. Dust on the plug may cause a fire.

 **Caution**

- Do not place or drop heavy objects on or forcefully bend the AC plug cord. Doing so may damage the cord. Should the AC plug cord be damaged, consult a PENTAX Service Center.
- Do not touch or short-circuit the terminal area of the AC plug cord while the cord is plugged in.
- Do not plug or unplug the power cord with wet hands. This can cause an electric shock.
- Do not drop the product, or subject it to violent impact. This can cause equipment breakdown.
- Do not use the battery charger to charge a battery other than a rechargeable lithium-ion battery D-LI88. Attempting to charge other types of batteries may cause an explosion, or heating, or may damage the battery charger.
- To reduce the risk of hazards, use only a CSA/UL certified power supply cord set, cord is Type SPT-2 or heavier, minimum NO.18 AWG copper, one end with a molded-on male attachment plug cap (with a specified NEMA configuration), and the other is provided with a molded-on female connector body (with a specified IEC nonindustrial type configuration) or the equivalent.

About the Battery

Warning

- Be sure to store the battery out of the reach of small children. Placing it in their mouths may cause an electric shock.
- If any leakage from the battery should come in contact with your eyes, do not rub them. Flush your eyes with clean water and get medical attention immediately.

Caution

- Only use the specified battery with this camera. Use of other batteries may cause an explosion or fire.
- Do not disassemble the battery. Disassembling the battery may cause an explosion or leakage.
- The battery should be inserted correctly, observing (+) and (-) marks on the battery and the camera. Inserting the battery incorrectly may cause an explosion or fire.
- Remove the battery from the camera immediately if it becomes hot or begins to smoke. Be careful not to burn yourself during removal.
- Keep wires, hairpins, and other metal objects away from the + and - contacts of the battery.
- Do not short the battery or dispose of the battery in fire. This can cause an explosion or fire.
- If any leakage from the battery should come in contact with skin or clothes, wash the affected areas thoroughly with water.
- Precautions for D-LI88 Battery Usage:
 - BATTERY MAY EXPLODE OR FIRE IF MISTREATED.
 - DO NOT DISASSEMBLE OR DISPOSE OF IN FIRE.
 - DO NOT CHARGE EXCEPT SPECIFIED CHARGING CONDITION.
 - DO NOT HEAT ABOVE 140°F / 60°C, OR SHORT CIRCUIT.
 - DO NOT CRUSH OR MODIFY.

About the SD Memory Card

Warning

- To avoid the risk of SD Memory Cards from being swallowed by mistake, keep them out of the reach of small children. Seek medical attention immediately if an SD Memory Card is accidentally swallowed.

Care to be Taken During Handling

Before Using Your Camera

- When traveling, take the Worldwide Service Network that is included in the package. This will be useful if you experience problems abroad.
- When the camera has not been used for a long time, confirm that it is still working properly, particularly prior to taking important pictures (such as at a wedding or when traveling). Pictures and sound cannot be guaranteed if recording, playback or transferring your data to a computer, etc. is not possible due to a malfunction of your camera or recording media (SD Memory Card), etc.

About the Battery and Charger

- Storing the battery fully charged may decrease the battery performance. Avoid storing in high temperatures.
- If the battery is left inserted and the camera is not used for a long time, the battery will over-discharge and shorten the battery's usage span.
- Charging the battery a day before use or on the day of use is recommended.
- The AC plug cord provided with this camera is developed exclusively for the battery charger D-BC88. Do not use it with other devices.

Precautions on Carrying and Using Your Camera

- Do not subject the camera to high temperatures or high humidity. Do not leave the camera in a vehicle, as the temperature can get very high.
- Do not subject the camera to strong vibrations, shocks, or pressure. Use a cushion to protect the camera from vibrations of motorcycles, automobiles, or ships.
- The temperature range for camera use is 0°C to 40°C (32°F to 104°F).
- The monitor may appear black at high temperatures, but will return to normal at normal temperatures.
- The monitor may respond more slowly at low temperatures. This is due to liquid crystal properties, and is not a malfunction.
- Sudden temperature changes will cause condensation on the inside and outside of the camera. Place the camera in your bag or a plastic bag, and remove it after temperature of the camera and surroundings are equalized.

- Avoid contact with garbage, mud, sand, dust, water, toxic gases, or salts. These could cause the camera to breakdown. Wipe dry any rain or water drops on the camera.
- Please do not press forcefully on the monitor. This could cause it to break or malfunction.
- Be careful not to sit down with the camera in your back pocket as this may damage the exterior of the camera or the display.
- Be careful not to overtighten the tripod screw when using a tripod.
- The lens on this camera is not interchangeable. The lens is not removable.

Waterproof and Dustproof Function

- This camera is provided with a waterproof/dustproof design complying with JIS waterproof grade 8 and JIS dustproof grade 6 (equivalent to IP68).
- To enhance the waterproof performance of the camera, the front of the lens is protected by glass. As any dirt or water on the glass will affect the quality of pictures taken, the glass should be kept clean at all times.
- Leaving the camera on the sand at the beach may cause the camera to exceed its operating temperature or cause the speaker or microphone to become blocked with sand.
- The camera will sink if dropped in water, so be sure to attach the strap and slip the strap over your wrist when using the camera in or near water.
- Be sure to check that the battery/card/terminal cover is securely locked before using the camera in an environment where it is likely to get wet or dirty, such as underwater or at the beach. Water, sand or dirt inside the camera may cause failure of the camera. Wipe off any water or dirt with a dry cloth as soon as possible after using the camera.
- Avoid opening the battery/card/terminal cover at the beach or by the sea. Wait until the camera is completely dry before changing the battery or the SD Memory Card. Avoid changing the battery or card where the camera is likely to get wet or dirty, and make sure that your hands are dry.
- If the camera is very dirty or after it has been used in the sea, make sure that it is turned off and the battery/card/terminal cover is firmly closed before rinsing it under running tap water or leaving it in a bowl of clean water for a short time (2 or 3 minutes).
- Avoid cleaning with agents such as soapy water, mild detergents, and alcohol as this may compromise the waterproof performance of the camera.

- Wipe off any dirt or sand on the waterproof packing or the packing contact surface. The camera waterproof function may be compromised by loose packing or cracks or dents in the packing or packing contact surface. If there is any such damage, contact your nearest PENTAX Service Center.
- To maintain the waterproof performance of the camera, you are recommended to change the waterproof packing once a year. Contact your nearest PENTAX Service Center regarding changing the packing. (A charge will be made.)
- Avoid subjecting the camera to substantial vibrations, shocks, or pressure as this may cause a loss in waterproof performance. If the camera is subjected to substantial vibrations, shocks or pressure, take your camera to your nearest PENTAX Service Center and have it checked.
- Avoid getting sunscreen or sun oil on the camera as it may cause discoloration of the surface. If any oil gets on the camera, wash it off immediately with warm water.
- The camera's accessories are not waterproof.

Cleaning Your Camera

- Do not clean the product with organic solvents such as thinner, alcohol or benzene.
- Use a lens brush to remove dust accumulated on the lens or viewfinder. Never use a spray blower for cleaning as it may damage the lens.





Storing Your Camera

- Do not store the camera with preservatives or chemicals. Storage in high temperatures and high humidity can cause mold to grow on the camera. Remove the camera from its case and store it in a dry and well-ventilated location.

Other Precautions

- Periodic inspections are recommended every one to two years to maintain high performance.
- Refer to “Precautions When Using an SD Memory Card” (p.44) regarding the SD Memory Card.
- Please note that deleting the data recorded on an SD Memory Card or formatting an SD Memory Card using a camera or computer will not necessarily delete the data so that it cannot be recovered using off the shelf data recovery software. Such data should be handled and managed at your own risk.

Contents

Using Your Camera Safely	1
Care to be Taken During Handling	5
Contents	9
Composition of the Operating Manual	15
Camera Features	16
Checking the Contents of the Package	20
Names of Parts	21
Names of Operating Parts	22
Monitor Indications	23
Getting Started	33
Attaching the Strap	34
Powering the Camera	35
Charging the Battery	35
Installing the Battery	36
Using the AC Adapter	40
Installing the SD Memory Card	42
Number of Images Recordable on an SD Memory Card	45
Turning the Camera On and Off	46
Starting-up in the Playback Mode	47
Initial Settings	48
Setting the Display Language	48
Setting the Date and Time	52
Common Operations	55
Understanding the Button Functions	56
 Mode	56
 Mode	58
Switching Between  Mode and  Mode	60
Setting the Camera Functions	61
Operating the Menus	61
Menu List	64

Taking Still Pictures	70
Taking Pictures	70
Setting the Shooting Mode	73
Using the Face Recognition Function.....	76
Taking Pictures Automatically (Auto Picture Mode)	78
Taking Pictures in the Custom Settings (Program Mode)	79
Taking Pictures in the Basic Mode (Green Mode).....	80
Using the Zoom	82
Taking Underwater Pictures (Underwater Mode/Underwater Movie Mode).....	84
Taking Pictures of Dark Scenes (Night Scene/Night Scene Portrait/Digital SR/Fireworks/Candlelight Mode)	86
Taking Pictures of People (Portrait/Half-length Portrait/Natural Skin Tone Mode).....	88
Taking Pictures of Children (Kids Mode).....	89
Taking Pictures of Your Pet (Pet Mode).....	90
Taking Pictures of Sports and Leisure Activities (Surf & Snow/Sport Mode).....	91
Taking Pictures Indoors (Party Mode).....	92
Framing Your Pictures (Frame Composite Mode).....	93
Using the Self-timer	95
Taking a Series of Pictures (Continuous Shooting/Burst Shooting Mode).....	96
Taking a Series of Pictures at a Set Interval (Interval Shoot).....	98
Using the Digital Wide Function (Digital Wide Mode).....	100
Taking Panoramic Pictures (Digital Panorama Mode).....	102
Setting the Shooting Functions	105
Selecting the Flash Mode	105
Selecting the Focus Mode	107
Selecting the Number of Recorded Pixels	110
Setting the Exposure (EV Compensation).....	112
Correcting the Brightness (D-Range Setting)	113
Adjusting the White Balance.....	114
Setting the AE Metering.....	116
Setting the Sensitivity	117
Setting Blink Detection	118
Setting Pixel Track SR.....	119
Setting the Instant Review.....	120
Setting the Image Sharpness (Sharpness).....	121
Setting the Color Saturation (Saturation).....	122
Setting the Image Contrast (Contrast).....	122
Setting the Date Imprint Function	123

Calling Up a Specific Function.....	124
Recording Movies	126
Recording a Movie.....	126
Selecting the Recorded Pixels and Frame Rate for Movies	128
Setting the Movie SR (Movie Shake Reduction) Function.....	129
Recording a Movie from Pictures Taken at a Set Interval (Interval Movie)	130
Saving the Settings (Memory)	133
Playing Back and Deleting Images	135
<hr/>	
Playing Back Images	136
Playing Back Still Pictures	136
Playing Back a Movie	137
Multi-Image Display	138
Using the Playback Function	140
Slideshow	143
Rotating the Image	145
Zoom Playback.....	146
Zoom In on the Subject's Face Automatically (Face Close-up Playback)	148
Deleting Images and Sound Files.....	150
Deleting a Single Image	150
Deleting Selected Images and Sound Files.....	152
Deleting All Images and Sound Files.....	154
Recovering Deleted Images	155
Protecting Images and Sound Files from Deletion (Protect)	156
Connecting the Camera to AV Equipment.....	159
Editing and Printing Images	161
<hr/>	
Editing Images	162
Changing the Image Size (Resize).....	162
Cropping Images	163
Processing Images So That Faces Look Smaller.....	164
Using the Digital Filters.....	166
Red-eye Compensation	170
Adding a Frame (Frame Composite)	171
Editing Movies	174
Copying Images and Sound Files.....	176
Setting the Printing Service (DPOF).....	179
Printing a Single Image	179
Printing All Images.....	181

Recording Sound (Voice Recording)	184
Setting the Voice Recording Function	184
Recording Sound	185
Playing Back Sound	186
Adding a Voice Memo to Images	188
Recording a Voice Memo	188
Playing Back a Voice Memo	189

Settings**191**

Camera Settings	192
Formatting an SD Memory Card	192
Changing the Sound Settings	193
Changing the Date and Time	194
Setting the World Time	197
Changing the Display Language	199
Changing the Naming Rule of the Folder	200
Changing the Video Output Format	201
Adjusting the Brightness of the Display	202
Using the Power Saving Function	203
Setting Auto Power Off	204
Changing the Start-up Screen	205
Correcting Defective Pixels in the CCD Sensor (Pixel Mapping)	206
Resetting to Default Settings (Reset)	207
Using the Clock Function	208
Displaying the Time	208
Setting the Alarm	208

Connecting to a Computer**211**

Setting Up Your Computer	212
Provided Software	212
System Requirements	213
Installing the Software	214
Setting the USB Connection Mode	218
Connecting to a Windows PC	220
Connecting the Camera and Your Windows PC	220
Transferring Images	221
Disconnecting the Camera from Your Windows PC	224
Starting "ACDSee for PENTAX 3.0"	225
Viewing Images	227

Details on How to Use "ACDSee for PENTAX 3.0"	228
Connecting to a Macintosh	229
Connecting the Camera and Your Macintosh.....	229
Transferring Images	230
Disconnecting the Camera from Your Macintosh	230
Starting "ACDSee 2 for Mac"	231
Viewing Images	232
Details on How to Use "ACDSee 2 for Mac"	232
Appendix	233
<hr/>	
Functions Available for Each Shooting Mode.....	234
Messages	236
Troubleshooting.....	238
Default Settings.....	240
List of World Time Cities	245
Optional Accessories	246
Main Specifications	247
WARRANTY POLICY.....	251
Index.....	256

In this manual, the method for operating the four-way controller is shown in illustrations, such as in the ones below.

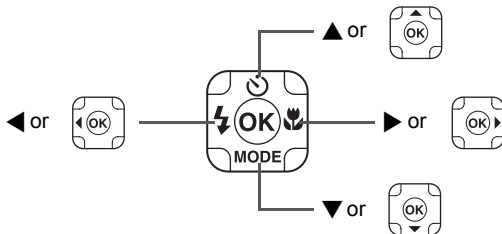

The meanings of the symbols used in this Operating Manual are explained below.

	indicates the reference page number for an explanation of the related operation.
	indicates information that is useful to know.
	indicates precautions to be taken when operating the camera.
mode	This is the mode for capturing still pictures and recording movies. In this manual, the mode for taking still pictures is referred to as the “still picture capture mode” and the mode for recording movies is referred to as the “ mode”.
mode	This is the mode for viewing still pictures and playing back movies and sound files.

Composition of the Operating Manual

This Operating Manual contains the following chapters.

1 Getting Started

This chapter explains what you need to do after purchasing the camera before you start taking pictures. Be sure to read it and follow the instructions.

2 Common Operations

This chapter explains common operations such as the functions of the buttons and how to use the menus. For more details, refer to the respective chapters below.

3 Taking Pictures

This chapter explains the various ways of capturing images and how to set the relevant functions.

4 Playing Back and Deleting Images

This chapter explains how to view still pictures and movies on the camera or on a TV screen and how to delete images from the camera.

5 Editing and Printing Images

This chapter explains the various ways of printing still pictures and how to edit images with the camera.

6 Recording and Playing Back Sound

This chapter explains how to record sound files or add sound (a voice memo) to an image, and how to play back them.

7 Settings

This chapter explains how to set the camera-related functions.

8 Connecting to a Computer

This chapter explains how to connect the camera to a computer, and includes installation instructions and a general overview of the provided software.

9 Appendix

This chapter deals with troubleshooting and lists the optional accessories.

Camera Features

In addition to basic picture-taking, the Optio WS80 has a variety of shooting modes to suit different situations. This section describes how to make the most of the key features of your camera. Together with the explanations of camera operations, it will enable you to enjoy your camera to the full.

Forget Your Worries About Water Getting in the Camera!

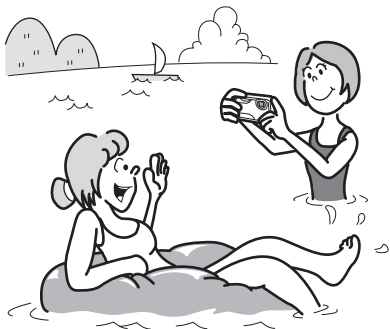

The Optio WS80 is waterproof/dustproof, and the water resistant coating on the lens protective glass enables you to take pictures underwater for two hours at a depth of 1.5 meters (4.9 ft.). It also allows the camera to be sprayed by water, and you can use the camera in locations where it will be exposed to dust and dirt such as beaches, kitchens, and workshops. Because it utilizes a lock mechanism for the battery/card/terminal cover, when the cover is firmly locked, you can use the camera underwater safely, with the knowledge that the battery and card are also secure.

- **For taking pictures while snorkeling (p.84)**
- **For taking pictures at the pool or while playing in a river or lake**
- **For taking pictures while enjoying various outdoor activities without worrying about your camera getting a bit dirty. A quick wipe with a wet cloth is all it needs!**

Easy-to-Navigate Capture and Playback Functions!

The user-friendly design of the Optio WS80 enables easy operation with only a few buttons. Simply by choosing the appropriate icon, you can select the shooting mode (p.73) and choose the optimal settings for the situation, or the playback mode (p.140, p.162) and enjoy the various playback and editing functions. A guide on the display lets you check the functions available in each mode and how to use them.



- **A shooting mode guide is displayed in the Capture Mode Palette and a playback mode guide in the Playback Mode Palette (p.73, p.140).**
- **Use the Green Mode to take pictures easily using standard settings (p.80).**

Perfect for Portrait Shots!

The Optio WS80 comes with a “Face Recognition” function that spots the faces in your shot and automatically adjusts the focus and exposure for the faces. It can recognize up to 32 people per shot (*), so it will help you take perfect group shots too. It will automatically release the shutter when people are smiling, or if anyone blinked, it will tell you that so you can take the shot again until it is perfect. It also has a feature that lets you enlarge each person’s face in sequence during playback so you can quickly check their facial expressions.

* Up to 31 face recognition frames (up to 30 frames in Half-length Portrait mode) are displayed on the monitor.

- **Face Recognition function (p.76)**
- **Modes for taking stunning pictures of people (p.88)**
- **Close-ups of people’s faces for easy checking during playback (p.148)**

Add Various Frames to Your Pictures!

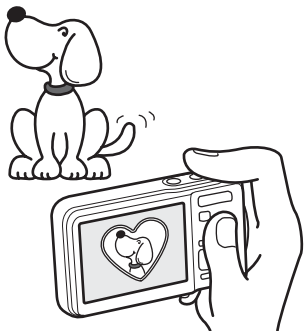

When you take a picture with the Optio WS80, you can choose from a wide range of fun frames to create attractive framed shots (p.93). You can also add frames to pictures you have taken. Adjust the position of the subject in the picture or reduce or enlarge the picture size to match the frame shape and size. Now you no longer have to worry about the subject not fitting into the frame (p.171).

- **For decorating your pictures with a frame**

Display Images and Sound Files in Calendar Format!

With the Optio WS80, you can display recorded images and sound files by date in calendar format (p.139). This lets you quickly find the image or sound file you want to play back.

Advanced Movie Recording Functions

The Optio WS80 has a shake reduction function (Movie SR) to reduce camera shake during movie recording (p.129). And it enables you to record movies in 1280×720 pixel (16:9) HDTV format (*) (p.128).

* When connecting to and playing back images on AV equipment, image data is output at normal screen resolution. To view movies in HDTV, transfer the data to a computer and play it back on the computer.

- **Use the camera to shoot fun-filled movies of your children or pets as a visual diary of their development (p.126).**

Perfect Size for Carrying Around With You!



With its design and excellent portability, the Optio WS80 is just right to slip into a pocket of your bag or hang around your neck, so you always have it with you, like your cell phone. It has a useful clock function, "Clock Mode" for telling the time. You can also set the alarm to ring at a specified time (p.208).

A Multitude of Functions Inside the Camera for Enjoying Images Without a Computer!

The Optio WS80 has a variety of functions to let you enjoy playing back and editing images without having to connect the camera to your computer and transfer the images first. The camera is all you need to take and edit still pictures and movies (p.162). And no more worries about accidentally deleting images, because now, with the Optio WS80, you can recover them again (p.155).

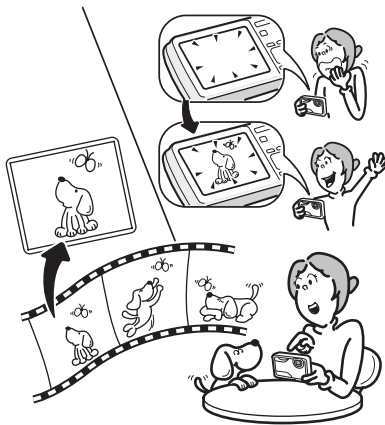

- **Resize (p.162), Cropping (p.163) and Red-eye Compensation (p.170) can be used, while the image is displayed in the playback mode.**
- **You can divide a movie into two or select a frame from a movie to save it as a still picture (p.174).**

Checking the Contents of the Package



Camera
Optio WS80

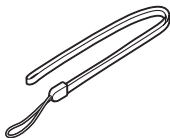

Strap
O-ST51 (*)

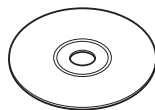

Software (CD-ROM)
S-SW87

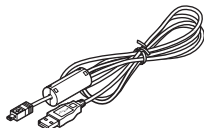

USB cable
I-USB7 (*)

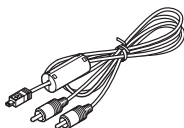

AV cable
I-AVC7 (*)



Rechargeable lithium-ion
battery D-LI88 (*)

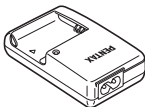

Battery charger
D-BC88 (*)



AC plug cord



Quick Guide



Operating Manual
(this manual)

Items marked with an asterisk (*) are also available as optional accessories. The battery charger and AC plug cord are only sold as a set (Battery Charger Kit K-BC88).

For other optional accessories, refer to "Optional Accessories" (p.246).

Names of Parts

Front

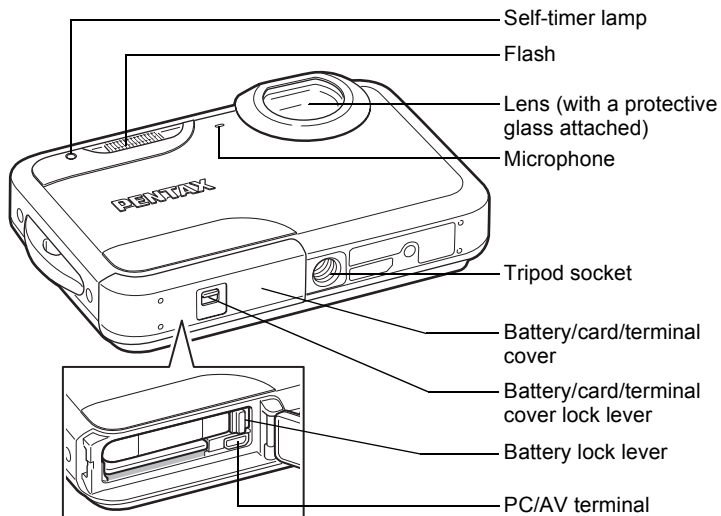

Back

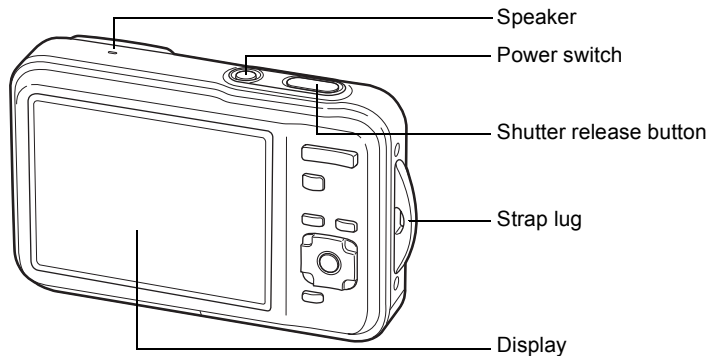

Names of Operating Parts

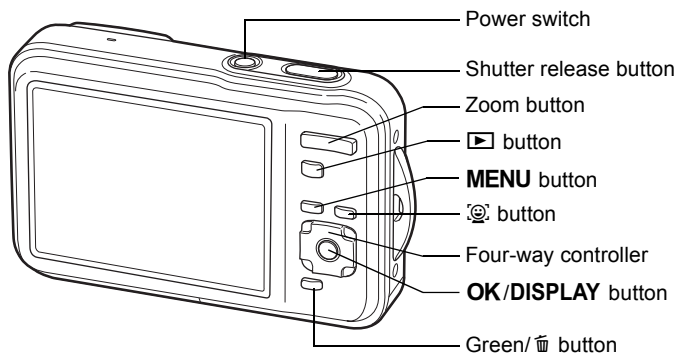



Refer to “Understanding the Button Functions” (p.56 - p.59) for an explanation of the function of each button.

Monitor Indications

Display in Mode

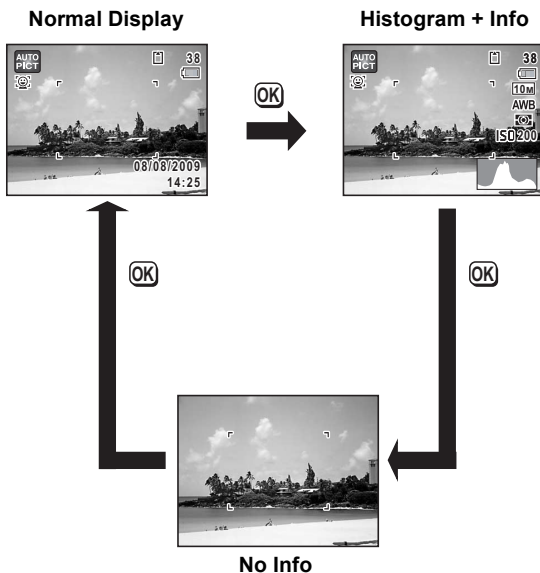
The display shows information such as the shooting conditions in the capture mode. The display changes in the following sequence each time you press the **OK/DISPLAY** button: “Normal Display”, “Histogram + Info” and “No Info”.



When the shooting mode is set to  (Green) mode, the monitor display is as shown on the right. You cannot change the information on the display by pressing the **OK/DISPLAY** button. (p.80)



Normal Display in Still Picture Capture Mode

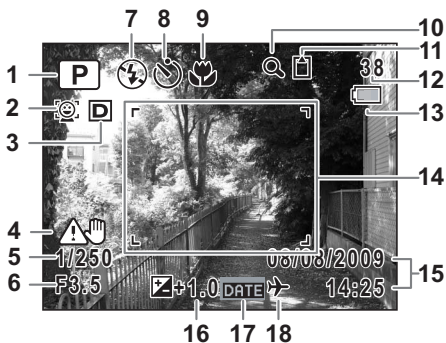





- | | |
|--|-------------------------------------|
| 1 Shooting mode (p.73) | 11 Memory status (p.46) |
| 2 Face Priority icon (p.76) | 12 Remaining image storage capacity |
| 3 D-Range Setting (p.113) | 13 Battery level indicator (p.39) |
| 4 Camera shake warning (p.119) | 14 Focus frame (p.70) |
| 5 Shutter speed | 15 Date and time (p.52) |
| 6 Aperture | 16 EV Compensation (p.112) |
| 7 Flash Mode (p.105) | 17 Date Imprint setting (p.123) |
| 8 Drive Mode (p.95, p.96, p.98) | 18 World Time setting (p.197) |
| 9 Focus Mode (p.107) | |
| 10 Digital Zoom/Intelligent Zoom icon (p.82) | |

* 3 depends on the [D-Range Setting] setting in the [📷 Rec. Mode] menu.

- When [Highlight Correction] is set to
- When [Shadow Correction] is set to
- When [Highlight Correction] and [Shadow Correction] are set to

If [Highlight Correction] and [Shadow Correction] are both set to (Off), nothing appears in 3.

- * 4 varies depending on the following conditions.
 -  When the shutter release button is pressed halfway with the [Pixel Track SR] in the [ Rec. Mode] menu set to (Off) and camera shake is likely to occur
 -  When [Pixel Track SR] is set to
- * 5 and 6 appear only when the shutter release button is pressed halfway.
- * For 9, when the focus mode is set to **AF** and the Auto-Macro function is activated, the  appears on the display (p.107).
- * Some indications may not appear depending on the shooting mode.

Histogram + Info/No Info Display in Still Picture Capture Mode

A1 to A18 and B1 appear when “Histogram + Info” is selected. Only B1 appears when “No Info” is selected.

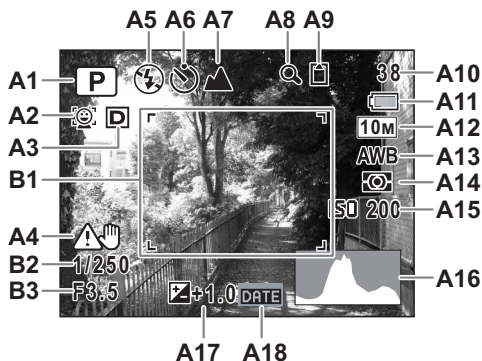



- | | |
|---|---|
| A1 Shooting mode (p.73) | A11 Battery level indicator (p.39) |
| A2 Face Priority icon (p.76) | A12 Recorded Pixels (p.110) |
| A3 D-Range Setting (p.113) | A13 White Balance (p.114) |
| A4 Camera shake warning (p.119) | A14 AE Metering (p.116) |
| A5 Flash Mode (p.105) | A15 Sensitivity (p.117) |
| A6 Drive Mode (p.95, p.96, p.98) | A16 Histogram (p.30) |
| A7 Focus Mode (p.107) | A17 EV Compensation (p.112) |
| A8 Digital Zoom/
Intelligent Zoom icon (p.82) | A18 Date Imprint setting (p.123) |
| A9 Memory status (p.46) | B1 Focus frame (p.70) |
| A10 Remaining image storage
capacity | B2 Shutter speed |
| | B3 Aperture |

* A3 depends on the [D-Range Setting] setting in the [📷 Rec. Mode] menu.

- When [Highlight Correction] is set to
- When [Shadow Correction] is set to
- When [Highlight Correction] and [Shadow Correction] are set to

If [Highlight Correction] and [Shadow Correction] are both set to (Off), nothing appears in A3.

- * A4 varies depending on the following conditions.
 -  When the shutter release button is pressed halfway with the [Pixel Track SR] in the [📷 Rec. Mode] menu set to (Off) and camera shake is likely to occur
 -  When [Pixel Track SR] is set to
- * B2 and B3 appear only when the shutter release button is pressed halfway.
- * When the shooting mode is  (Auto Picture) and if you press the shutter release button halfway, the automatically selected shooting mode appears in A1 even when “No Info” is selected (p.78).
- * Some indications may not appear depending on the shooting mode.

Display in Mode

The display shows the shooting information of the image in the playback mode. The display changes in the following sequence each time you press the **OK/DISPLAY** button: “Normal Display”, “Histogram + Info” and “No Info”.

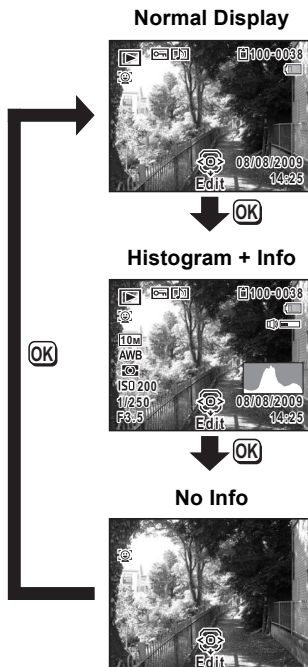

Normal Display/Histogram + Info Display in Playback Mode

(All of the display items are displayed here for explanatory purposes.)

The display shows information such as the shooting conditions. A1 to A11 appear when “Normal Display” or “Histogram + Info” is selected. B1 to B7 appear only when “Histogram + Info” is selected.



- | | |
|--|--|
| A1 Face Priority icon (p.76) | A9 Volume icon |
| A2 Playback mode
▶ : Still Picture (p.136)
▶ : Movie (p.137)
▶ : Sound (p.186) | A10 Captured date and time (p.52) |
| A3 Protect icon (p.156) | A11 Four-way controller guide |
| A4 Voice memo icon (p.189) | B1 Recorded Pixels (p.110) |
| A5 Memory status (p.46) | B2 White Balance (p.114) |
| A6 Folder number (p.200) | B3 AE Metering (p.116) |
| A7 File number | B4 Sensitivity (p.117) |
| A8 Battery level indicator (p.39) | B5 Shutter speed |
| | B6 Aperture |
| | B7 Histogram (p.30) |

- * A1 appears only if the Face Recognition function worked when the image was shot.
- * In “Normal Display”, A8 and A10 disappear if no operation is performed for two seconds.
- * A9 appears only when the volume is being adjusted during playback of movies, sound files or voice memo (p.137, p.186, p.189).
- * A11 appears even when “No Info” is selected, but disappears if no operation is performed for two seconds. When no operation is performed for two seconds in “Normal Display” or “Histogram + Info”, only “Edit” disappears.

Guide Indications

A guide for each available button operation appears as follows on the display during operation.

▲	Four-way controller (▲)
▼	Four-way controller (▼)
◀	Four-way controller (◀)
▶	Four-way controller (▶)
MENU	MENU button

	Zoom button
OK	OK/DISPLAY button
SHUTTER	Shutter release button
	Green/ button
	button

Using the Histogram

A histogram shows the brightness distribution of an image. The horizontal axis represents brightness (dark at the left and bright at the right) and the vertical axis represents the number of pixels.

The shape of the histogram before and after shooting tells you whether the brightness and contrast are correct or not, and lets you decide if you need to use EV compensation and take the picture again.

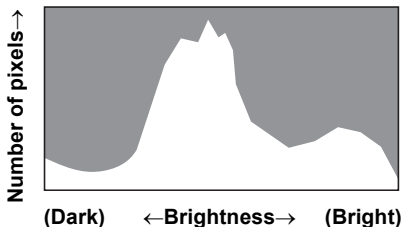

Setting the Exposure (EV Compensation) p.112

Understanding Brightness

If the brightness is correct, the graph peaks in the middle. If the image is too dark, the peak is on the left side, and if it is too bright, the peak is on the right side.

Dark image

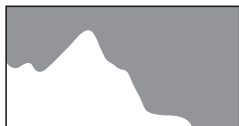

Correct image

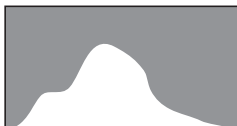

Bright image

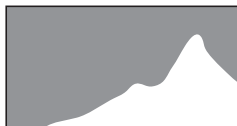

When the image is too dark, the part to the left is cut off (dark portions) and when the image is too bright, the part to the right is cut off (bright portions).

Understanding Contrast

The graph peaks gradually for images in which contrast is balanced. The graph peaks on both sides but sinks in the middle for images with a large difference in contrast and low amounts of mid-level brightness.

Memo

1 Getting Started

Attaching the Strap	34
Powering the Camera	35
Installing the SD Memory Card	42
Turning the Camera On and Off	46
Initial Settings	48

Attaching the Strap

Attach the strap (O-ST51) supplied with the camera.

1

Getting Started

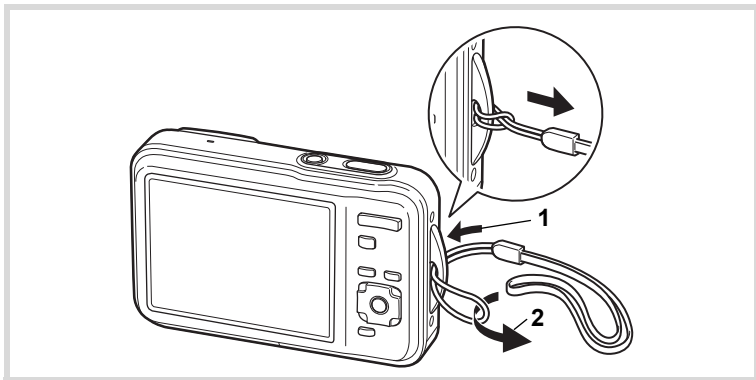

- 1** Pass the narrow end of the strap through the strap lug.
- 2** Pass the other end of the strap through the loop and pull tight.

Charging the Battery

Use the supplied battery charger (D-BC88) to charge the supplied rechargeable lithium-ion battery (D-LI88) before using it in the camera for the first time or after a long period of non-use, or when the [Battery depleted] message appears.

Note: AC plug cord "Listed, Type SPT-2 or NISPT-2, 18/2 flexible cord, rated 125 V, 7A, minimum 6 ft (1.8 m)"

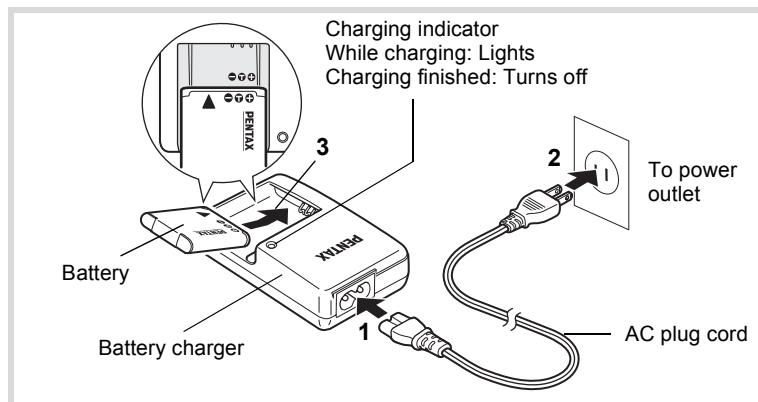

- 1** Connect the AC plug cord to the battery charger.
- 2** Plug the AC plug cord into the power outlet.
- 3** Place the battery in the battery charger so that the PENTAX logo is facing up.
The charging indicator lights while the battery is charging and turns off when charging is finished.
- 4** Remove the battery from the battery charger when charging is finished.



- Do not use the supplied battery charger (D-BC88) to charge batteries other than the rechargeable lithium-ion battery D-LI88, as the battery charger may overheat or be damaged.
- The battery has reached the end of its service life when it starts to run down soon after being charged. Replace it with a new battery.
- If the battery is inserted correctly but the charging indicator fails to light, the battery may be faulty. Replace it with a new battery.



The time required to fully charge the battery is about 120 minutes (max.). (The charging time may vary depending on the ambient temperature and charging conditions.) The appropriate ambient temperature for charging the battery is 0°C to 40°C (32°F to 104°F).

Installing the Battery

Use the rechargeable lithium-ion battery D-LI88 that is provided with the camera. Charge the battery before using it in the camera for the first time.

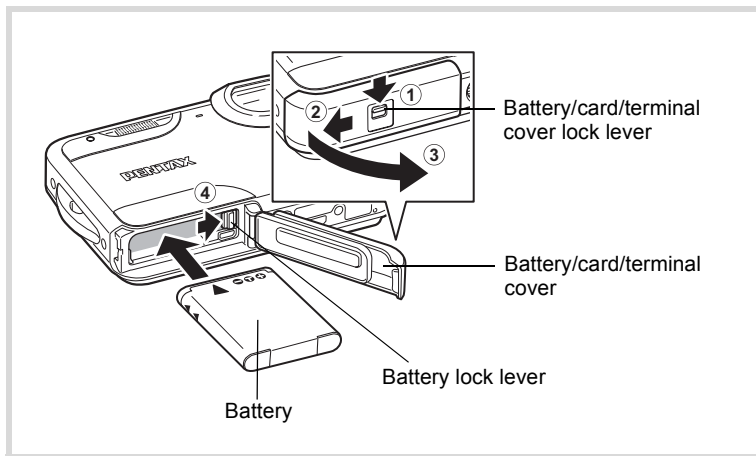

1 Open the battery/card/terminal cover.

While pushing the battery/card/terminal cover lock lever towards ①, slide the cover towards ② and open it towards ③.

- 2 Press the battery lock lever in the direction of ④ and insert the battery so that the PENTAX logo is facing toward the lens.**

Match the marks on the battery to the marks inside the battery compartment and push the battery in until it is locked in place.



Make sure that the battery is inserted with the PENTAX logo pointing toward the lens. If the battery is incorrectly oriented, malfunction may result.

- 3 Close the battery/card/terminal cover.**

Slide the battery/card/terminal cover in the opposite direction indicated by ②. If you hear a click, the cover is securely closed.

Removing the Battery

- 1 Open the battery/card/terminal cover.**

- 2 Press the battery lock lever in the direction of ④.**

The battery will be ejected. Take care not to drop the battery when removing it.



- This camera uses a rechargeable lithium-ion battery D-LI88. Use of any other type of battery may damage the camera and cause malfunction.
- Insert the battery correctly. If the battery is incorrectly oriented, malfunction may result.
- Do not remove the battery while the camera is turned on.
- Do not use excessive force when sliding the battery/card/terminal cover open and closed because the waterproof packing may peel off. If the packing is not in the correct position, the camera will not be waterproof.
- If the battery/card/terminal cover is not locked securely when you close it, water, sand, or dirt may get into the camera.
- Avoid changing the battery where the camera is likely to get wet or dirty, and make sure that the camera and your hands are dry completely.
- When storing the battery for more than 6 months, charge the battery for 30 minutes using the battery charger and store the battery separately.
Be sure to recharge the battery every 6 to 12 months. Storing the battery below room temperature is ideal. Avoid storing it in high temperatures.
- The date and time may be returned to the default setting if the camera is left without the battery for a long time.
- Be careful as the camera or the battery may become hot when the camera is used continuously for a long period of time.

• Image Storage Capacity, Movie Recording Time, Sound Recording Time, and Playback Time (at 23°C with the display on and the battery fully charged)

Image Storage Capacity ^{*1} (flash used for 50% of shots)	Movie Recording Time ^{*2}	Sound Recording Time ^{*2}	Playback Time ^{*2}
Approx. 200 pictures	Approx. 70 min.	Approx. 270 min.	Approx. 240 min.

*1 Recording capacity shows the approximate number of shots recorded during CIPA-compliant testing (with display on, flash used for 50% of the shots, and 23 degrees centigrade). Actual performance may vary according to operating conditions.





*2 According to the result of in-house testing.



- In general, battery performance may temporarily deteriorate as the temperature decreases.
- Be sure to take a spare battery with you when traveling abroad or to a cold region, or if you intend to take a lot of pictures.

• **Battery Level Indicator**

You can check the battery level by the indicator on the display.

Screen Display	Battery Status
 (green)	Adequate power remains.
 (green)	Battery is running low.
 (yellow)	Battery is running very low.
 (red)	Battery is exhausted.
[Battery depleted]	The camera will turn off after this message appears.

Using the AC Adapter

Use of the optional AC adapter kit (K-AC88) is recommended if you intend to use the camera for a long time or connect it to a computer.

1

Getting Started

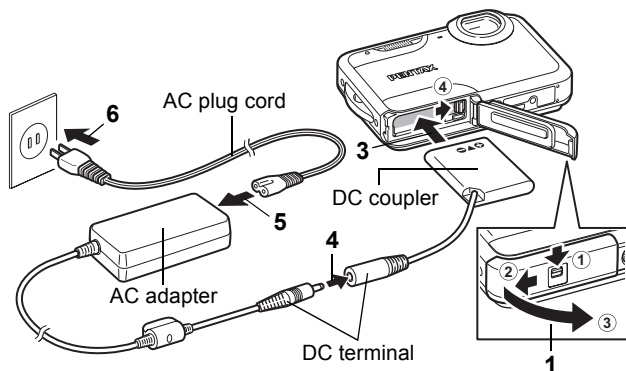

- 1 Make sure that the camera is turned off and open the battery/card/terminal cover.**
- 2 Remove the battery.**

Refer to p.36 - p.37 on how to open/close the battery/card/terminal cover and remove the battery.
- 3 Insert the DC coupler, as shown in the illustration, while holding down the battery lock lever.**

Confirm the DC coupler is locked in place.
The battery/card/terminal cover will not close while the DC coupler is inserted. Leave the cover open when using the AC adapter and do not attempt to close it.
- 4 Connect the DC terminal of the AC adapter to the DC terminal of the DC coupler.**
- 5 Connect the AC plug cord to the AC adapter.**
- 6 Plug the AC plug cord into the power outlet.**

- Make sure that the camera is turned off before connecting or disconnecting the AC adapter.
- Make sure that the AC plug cord and the DC terminal connecting the AC adapter to the camera are inserted securely. Data may be lost if either becomes disconnected while data is being recorded on the SD Memory Card or the built-in memory.
- Do not use excessive force when sliding the battery/card/terminal cover open and closed because the waterproof packing may peel off. If the packing is not in the correct position, the camera will not be waterproof.
- Use the AC adapter with due care to avoid fire or electric shock. Be sure to read "About the Battery Charger and the AC Adapter" (p.2) before using the AC adapter.
- Be sure to read the operation manual accompanying the AC adapter kit K-AC88 before using the adapter.
- When connecting the AC adapter, you cannot set the camera upright on the table because the cord from the DC coupler comes out of the bottom of the camera.

Installing the SD Memory Card

This camera uses either an SD Memory Card or an SDHC Memory Card. (Both cards are referred to as SD Memory Cards hereafter.) Captured images and sound files are saved on the SD Memory Card if a card is inserted in the camera. They are saved in the built-in memory if a card is not inserted (p.46).

Caution

- **Be sure to use this camera to format (initialize) an SD Memory Card that is unused or has been used on other cameras or digital devices. Refer to “Formatting an SD Memory Card” (p.192) for instructions on formatting.**
- Make sure that the camera is turned off before inserting or removing the SD Memory Card.
- Do not use excessive force when sliding the battery/card/terminal cover open and closed because the waterproof packing may peel off. If the packing is not in the correct position, the camera will not be waterproof.
- Avoid changing the SD Memory Card where the camera is likely to get wet or dirty, and make sure that the camera and your hands are completely dry.



- The still picture storage capacity varies depending on the capacity of the SD Memory Card and the selected number of recorded pixels and quality level (p.45).
- The self-timer lamp blinks while the SD Memory Card is being accessed (data is being recorded or read).

Backing Up Data

The camera may not be able to access data in the built-in memory in the case of a malfunction. Use a computer or other device to back up important data in another location.

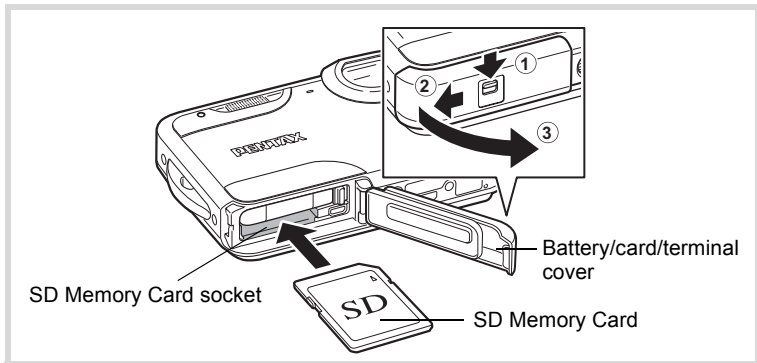

- 1 Open the battery/card/terminal cover.**

While pushing the battery/card/terminal cover lock lever towards ①, slide the cover towards ② and open it towards ③.
- 2 Insert the SD Memory Card into the SD Memory Card socket so that the label is facing toward the front of the camera (the side with the lens).**

Push the card in all the way. Data may not be recorded correctly if the card is not inserted all the way.
- 3 Close the battery/card/terminal cover.**

Slide the battery/card/terminal cover in the opposite direction indicated by ②. If you hear a click, the cover is securely closed.

To Remove the SD Memory Card

- 1 Open the battery/card/terminal cover.**
- 2 Push the card into the SD Memory Card socket to eject it.**

Pull the card out.



If the battery/card/terminal cover is not locked securely when you close it, water, sand, or dirt may get into the camera.

Precautions When Using an SD Memory Card

- The SD Memory Card is equipped with a write-protect switch. Setting the switch to LOCK prevents new data from being recorded on the card, the stored data from being deleted, and the card from being formatted by the camera or computer.
 - ☒ appears on the display when the card is write-protected.
- Care should be taken when removing the SD Memory Card immediately after using the camera, as the card may be hot.
- Do not remove the SD Memory Card or turn the camera off while the data is being played back or saved to the card, or the camera is connected to a computer with the USB cable, as this may cause the data to be lost or the card to be damaged.
- Do not bend the SD Memory Card or subject it to violent impact. Keep it away from water and store away from high temperature.
- Do not remove the SD Memory Card during formatting as this may damage the card and render it unusable.
- The data on the SD Memory Card may be deleted in the following circumstances. We do not accept any liability for data that is deleted
 - (1) when the SD Memory Card is mishandled by the user.
 - (2) when the SD Memory Card is exposed to static electricity or electrical interference.
 - (3) when the SD Memory Card has not been used for a long time.
 - (4) when the SD Memory Card is ejected or the battery is removed while the data on the card is being recorded or accessed.
- If it is not used for a long time, the data on the card may become unreadable. Be sure to regularly make a backup of important data on a computer.
- Avoid using or storing the card where it may be exposed to static electricity or electrical interference.
- Avoid using or storing the card in direct sunlight or where it may be exposed to rapid changes in temperature or to condensation.
- When using an SD Memory Card with a slow recording speed, recording may stop while you are taking movies even when there is adequate space in the memory, or shooting and playback may take a long time.
- Be sure to format SD Memory Cards that are unused or have been used on another camera. Refer to "Formatting an SD Memory Card" (p.192).
- Please note that formatting the SD Memory Card will not necessarily delete the data so that it cannot be recovered using off-the-shelf data recovery software. There are off-the-shelf secure data deletion software programs available that will completely delete the data. If you are going to discard, give away or sell your SD Memory Card, you should ensure that the data on the card is completely deleted or the card itself is destroyed if it contains any personal or sensitive information. In any case, the data on your SD Memory Card should be managed at your own risk.

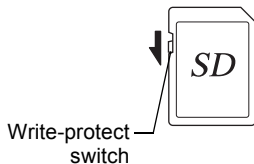

Number of Images Recordable on an SD Memory Card

The sizes of the recorded images differ depending on the number of recorded pixels of the images, so the number of images that will be saved on an SD Memory Card also differs.

Choose the appropriate number of recorded pixels for still pictures on the [📷 Rec. Mode] menu.

Selecting the Number of Recorded Pixels 📷p.110

Choose the appropriate number of recorded pixels and frame rate in [Movie] on the [📷 Rec. Mode] menu.

Selecting the Recorded Pixels and Frame Rate for Movies 📷p.128

For an approximate guide to the number of images or the length of recorded movies that can be saved on an SD Memory Card, see “Main Specifications” (p.248).

Turning the Camera On and Off

1

Getting Started

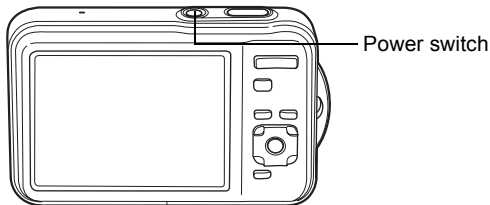

1 Press the power switch.

The camera turns on and the display turns on.

If the [Language/言語] screen or [Date Adjustment] screen appears when you turn the camera on, follow the procedure on p.48 to set the display language and/or current date and time.

2 Press the power switch again.

The display turns off, the lens closes, and the camera turns off.

Taking Still Pictures p.70

Checking the SD Memory Card

The SD Memory Card is checked when the camera turns on and the memory status is displayed.

	The SD Memory Card is inserted. Images and sound files will be saved on the SD Memory Card.
	The SD Memory Card is not inserted. Images and sound files will be saved in the built-in memory.
	The write-protect switch on the SD Memory Card is in the LOCK position (p.44). Images and sounds cannot be recorded.

Memory status



Starting-up in the Playback Mode

If you want to play back images or sound files straightaway without taking any pictures, you can start up the camera in the playback mode.

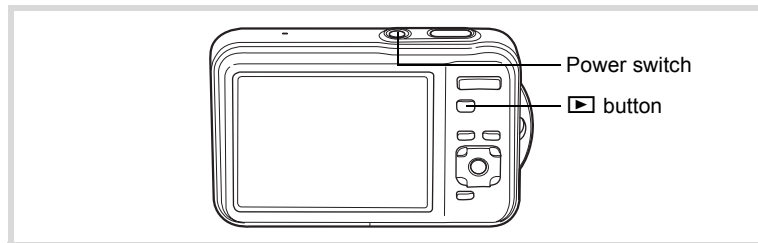

1 Press the power switch while holding down the ▶ button.

The display turns on and the camera turns on in the playback mode.



To switch from the playback mode to the capture mode, press the ▶ button or press the shutter release button halfway.

Playing Back Still Pictures p.136

Initial Settings

The [Language/言語] screen appears when the camera is turned on for the first time. Perform the operations in “Setting the Display Language” below to set the language, and in “Setting the Date and Time” (p.52) to set the current date and time.

The language, date, and time can be changed later. Refer to the pages below for instructions.

- To change the language, follow the steps in “Changing the Display Language” (p.199).
- To change the date and time, follow the steps in “Changing the Date and Time” (p.194).

Setting the Display Language

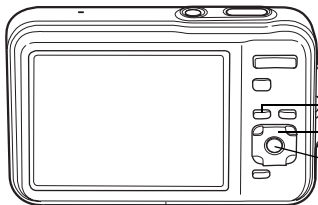

1 Use the four-way controller (▲▼◀▶) to choose the display language.

Language/言語		
English	日本語	Türkçe
Français	Dansk	Ελληνικά
Deutsch	Svenska	Русский
Español	Suomi	ไทย
Português	Polski	한국어
Italiano	Čeština	中文繁體
Nederlands	Magyar	中文简体
MENU	Cancel	OK

2 Press the OK button.

The [Initial Setting] screen appears in the selected language. If the desired settings for [Hometown] and [DST] (Daylight Saving Time) appear, proceed to Step 3. Proceed to “To Set Hometown and DST” (p.51) if the desired settings do not appear.

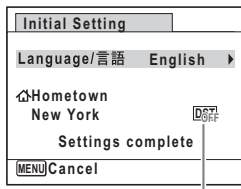

Daylight saving time

3 Press the four-way controller (▼) twice to select [Settings complete].

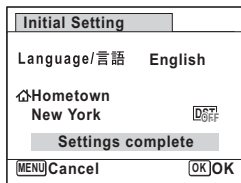

4 Press the OK button.

The [Date Adjustment] screen appears. Set the date and time by following the procedure in “Setting the Date and Time” (p.52).

If you accidentally select the wrong language and proceed to the next procedure, perform the following operation to set the desired language.

● **When the Wrong Language Has Been Inadvertently Selected**

- 1 Press the four-way controller (▶).**
- 2 Use the four-way controller (▲▼◀▶) to select the language and press the OK button.**

The [Initial Setting] screen appears in the selected language.

● **When the Screen After Step 2 Appears in the Wrong Language**

- 1 Press the MENU button.**
The setting screen is ended and the camera returns to capture status.
- 2 Press the MENU button.**
The [📷 Rec. mode] menu appears.
- 3 Press the four-way controller (▶).**
- 4 Use the four-way controller (▼▲) to select [Language/言語].**
- 5 Press the four-way controller (▶).**
The [Language/言語] screen appears.
- 6 Use the four-way controller (▲▼◀▶) to select the language.**
- 7 Press the OK button.**
The [🔍 Setting] menu appears in the selected language.

The language is now switched to your desired language. To reset [Hometown], [Date] and [Time], refer to the pages below for instructions.

- To change [Hometown], follow the steps in "Setting the World Time" (p.197).
- To change the [Date] and [Time], follow the steps in "Changing the Date and Time" (p.194).

To Set Hometown and DST

3 Press the four-way controller (▼).

The frame moves to [↗ Hometown].

4 Press the four-way controller (▶).

The [↗ Hometown] screen appears.

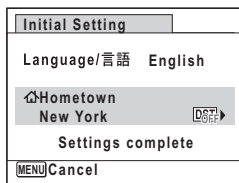

5 Use the four-way controller (◀▶) to choose a city.

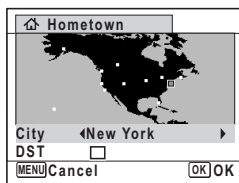

6 Press the four-way controller (▼).

The frame moves to [DST] (Daylight Saving Time).

7 Use the four-way controller (◀▶) to select or .

8 Press the OK button.

The [Initial Setting] screen reappears.

9 Press the four-way controller (▼) to select [Settings complete].

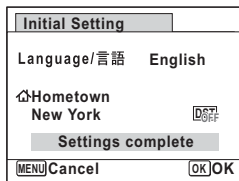

10 Press the OK button.

The [Date Adjustment] screen appears. Next, set the date and time.

The video output format (NTSC/PAL) is set to the format of the city selected in [Hometown] on the [Initial Setting] screen. Refer to “List of World Time Cities” (p.245) for the video output format of each city set as the initial setting, and “Changing the Video Output Format” (p.201) for changing the setting of the video output format.

Setting the Date and Time

Set the current date and time and the display style.

1 Press the four-way controller (▶).

The frame moves to [mm/dd/yy].

2 Use the four-way controller (▲▼) to choose the date and time display style.

Choose from [mm/dd/yy], [dd/mm/yy] or [yy/mm/dd].

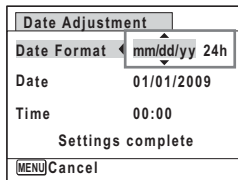

3 Press the four-way controller (▶).

The frame moves to [24h].

4 Use the four-way controller (▲▼) to select [24h] (24-hour display) or [12h] (12-hour display).

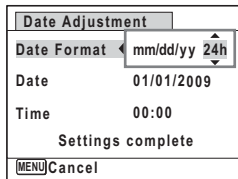

5 Press the four-way controller (▶).

The frame returns to [Date Format].

6 Press the four-way controller (▼).

The frame moves to [Date].

7 Press the four-way controller (▶).

The frame moves to the month.

Date Adjustment	
Date Format	mm/dd/yy 24h
Date	▶01/01/2009
Time	00:00
Settings complete	
[MENU]Cancel	

8 Use the four-way controller (▲▼) to change the month.

Change the day and year in the same manner.

Next, change the time.

If you selected [12h] in Step 4, the setting switches between am and pm corresponding to the time.

Date Adjustment	
Date Format	mm/dd/yy 24h
Date	◀01/01/2009
Time	00:00
Settings complete	
[MENU]Cancel	

9 Press the four-way controller (▼) to select [Settings complete].

Date Adjustment	
Date Format	mm/dd/yy 24h
Date	01/01/2009
Time	00:00
Settings complete	
[MENU]Cancel	[OK]OK

10 Press the OK button.

This confirms the date and time and completes the initial setting. The camera returns to capture status.



If you press the **OK** button in Step 10, the camera clock is reset to 00 seconds. To set the exact time, press the **OK** button when the time signal (on the TV, radio, etc.) reaches 00 seconds.



When the [Initial Setting] or [Date Adjustment] screen is displayed, you can cancel the setting operation and switch to the capture mode by pressing the **MENU** button. In this case, the [Initial Setting] screen will appear next time you turn the camera on.

[Language/言語], [Date], [Time], [Hometown] and [DST] can be changed. Refer to the pages below for instructions.

- To change the language, follow the steps in “Changing the Display Language” (p.199).
- To change the date and time, follow the steps in “Changing the Date and Time” (p.194).
- To change the city or turn DST on and off, follow the steps in “Setting the World Time” (p.197).

2 Common Operations

Understanding the Button Functions 56
Setting the Camera Functions 61

Understanding the Button Functions

Mode

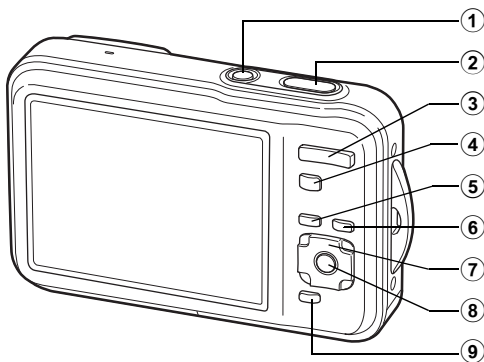

- ① **Power switch**
Turns the camera on and off (p.46).
- ② **Shutter release button**
Focuses the camera on the subject when pressed halfway in still picture capture mode (except in **PF**, **▲** and **MF** modes).
Takes a still picture when pressed down fully (p.71).
Starts and stops movie recording in **Movie** and **Underwater Movie** modes (p.126).
Starts and stops sound file recording in Voice Recording (p.185).
- ③ **Zoom button**
Changes the captured area (p.82).
- ④ **▶ button**
Switches to the ▶ mode (p.60).
- ⑤ **MENU button**
Displays the [Rec. Mode] menu (p.61).

⑥

☺ button

Switches the Face Recognition function (p.76). The Face Recognition function is switched as follows each time the ☺ button is pressed:

Smile Capture → Face Priority Off → Face Priority On

⑦

Four-way controller

▲ Changes the drive mode (p.95, p.96, p.98).

▼ Displays the Capture Mode Palette (p.73).

◀ Changes the flash mode (p.105).

▶ Changes the focus mode (p.107).

▲▼ Adjusts the focus when the focus mode is set to **MF** (p.108).

⑧

OK/DISPLAY button

Changes the information on the display (p.23).

⑨

Green button

Switches to the ● (Green) mode (p.80).

Calls up the assigned function (p.124).

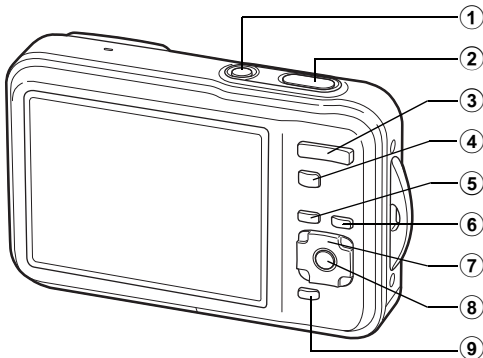

**① Power switch**



Turns the camera on and off (p.46).

② Shutter release button

Switches to  mode (p.60).

③ Zoom button

Press towards the left () during single-image display to change to four-image display. Changes to nine-image display when pressed towards the left again. Returns to the previous display when pressed towards the right () (p.138).

Enlarges the image when pressed towards the right () during single-image display. Returns to the previous display when pressed towards the left () (p.146).

Press towards the left () during nine-image display to change to folder or calendar display (p.139).

Press towards the right () during folder/calendar display to change to nine-image display (p.139).

Adjusts the volume during playback of movies, sound files or voice memo (p.137, p.186, p.189).

④  button

Switches to  mode (p.60).

⑤ MENU button

Displays the [ Setting] menu during single-image display (p.61).

Returns to single-image display during Playback Mode Palette display (p.140).

Returns to single-image display during four-/nine-image display or zoom display (p.138).

Changes to nine-image display of the selected folder during folder display (p.139).

Changes to nine-image display of the selected date during calendar display (p.139).

6 button

Zooms in on the subject's faces in the face-recognized image in the order the faces were recognized when the picture was taken. (Face close-up playback) (p.148).

7 **Four-way controller**

▲ Plays back and pauses a movie or sound file (p.137, p.186).

▼ Displays the Playback Mode Palette (p.140).

Stops a movie or sound file during playback (p.137, p.186).

◀▶ Displays the previous or next image or sound file during single-image display (p.136).

Fast-forwards, fast-reverses, frame forwards, frame reverses, reverses a movie and makes a movie play forwards during playback (p.137).

Fast-forwards, fast-reverses, and moves to the next index in sound file playback (p.186).

▲▼◀▶ Selects an image in four-/nine-image display, a folder in folder display, and a date in calendar display (p.138, p.139). Moves the display area during zoom display (p.146).

Moves the image when using the Frame Composite function (p.171).

8 **OK/DISPLAY button**

Changes the information on the display (p.28).

Returns to single-image display during four-/nine-image display or zoom display (p.138, p.146).

Changes to nine-image display of the selected folder during folder display (p.139).

Changes to single-image display of the selected date during calendar display (p.140).

9 **Green/ button**



Switches from single-image display to the Delete screen (p.150).

Switches from four-/nine-image display to the Select & Delete screen (p.152).

Switches from folder display to the calendar display screen (p.139).

Switches from calendar display to the folder display screen (p.139).

Switching Between Mode and Mode

In this manual, the capture mode, such as for taking still pictures, is referred to as “ mode” (the capture mode). The playback mode, such as for displaying captured images on the display, is referred to as “ mode” (the playback mode). In  mode, you can perform simple editing operations on the captured images.

Follow the procedure below to switch between  mode and  mode.

To Switch from Mode to Mode

1 Press the button.

The camera switches to  mode.

To Switch from Mode to Mode

1 Press the button or the shutter release button halfway.

The camera switches to  mode.



Displaying data stored in the built-in memory

When an SD Memory Card is inserted in the camera, images, movies, and sounds on the SD Memory Card are displayed. If you want to display images, movies and sounds in the built-in memory, turn the camera off and remove the SD Memory Card, or follow the procedure below to use the “Built-in memory display” function.



Make sure that the camera is turned off before inserting or removing the SD Memory Card.

- **Viewing images in the built-in memory while the SD Memory Card is inserted (built-in memory display)**

When you press and hold down the  button for more than one second in  mode, the message [Display image/sound from built-in memory] appears, and the images, movies and sound files stored in the built-in memory are displayed.

- In the built-in memory display, you can play back still pictures (including enlarged display) (p.136, p.146), movies (p.137) and sounds (p.186), and switch between four-/nine-image display, folder display and calendar display (p.138).
- In the built-in memory display, you cannot delete data, delete a selection, display the Playback Mode Palette or display the menu. If you want to perform any of these operations on images, movies or sounds in the built-in memory, do so after removing the SD Memory Card.

Setting the Camera Functions

To change the camera settings, press the **MENU** button to display the [📷 Rec. Mode] menu or [⚙️ Setting] menu. Menus for playing back and editing images and sound files are displayed from the Playback Mode Palette (p.140).

Operating the Menus

Press the **MENU** button in 📷 mode to display the [📷 Rec. Mode] menu. Press the **MENU** button in ▶ mode to display the [⚙️ Setting] menu. Use the four-way controller (◀▶) to switch between [📷 Rec. Mode] menu and [⚙️ Setting] menu.

During recording

During playback



MENU

MENU

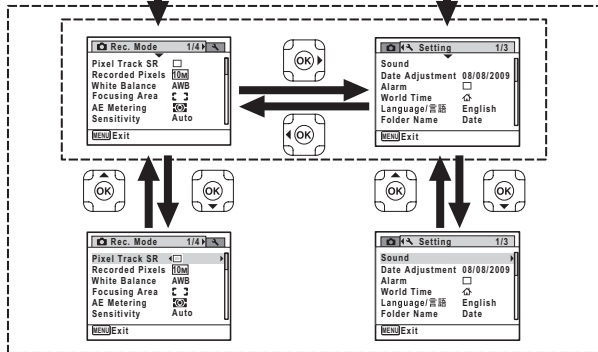

SHUTTER

MENU or

▶

Press halfway

The setting is complete and the camera returns to mode.



The setting is complete and the camera returns to mode.



Available button operations appear on the display during menu operation (p.30).

Ex.) To set the [Focusing Area] on the [📷 Rec. Mode] menu

1 Press the MENU button in 📷 mode.

The [📷 Rec. Mode] menu appears.

2 Press the four-way controller (▼).

The frame moves to [Pixel Track SR].

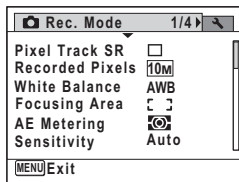

3 Press the four-way controller (▼) three times.

The frame moves to [Focusing Area].

4 Press the four-way controller (▶).

A pull-down menu appears with the items that can be selected.

The pull-down menu displays only those items that can be selected with the current camera settings.

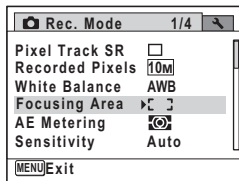

5 Use the four-way controller (▲▼) to change the setting.

The focusing area changes each time the four-way controller (▲▼) is pressed.

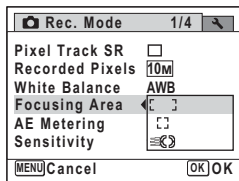

6 Press the OK button or the four-way controller (◀).

The setting is saved and then the camera is ready for setting the other functions.

To exit the settings, press the **MENU** button.

To use another operation, refer to the alternate Step 6 options on the next page.

To Save the Setting and Start Taking Pictures

6 Press the shutter release button halfway.

The setting is saved and the camera returns to capture status. When the shutter release button is pressed fully, the picture is taken.



When the [Setting] menu is displayed from mode, you can switch to mode by pressing the button.

To Save the Setting and Start Playback of Images

6 Press the button.

When the [Rec. Mode] menu is displayed from mode, the setting is saved and the camera returns to playback status.

To Cancel the Changes and Continue with Menu Operations

6 Press the MENU button.

The changes are canceled and the screen shown in Step 3 reappears.



The **MENU** button function differs depending on the screen. Refer to the guide indications.

- | | |
|--------|---|
| Exit | Exits the menu and returns to the original screen. |
| | Returns to the previous screen with the current setting. |
| Cancel | Cancels the current selection, exits the menu and returns to the previous screen. |

Menu List

This displays the items that can be set with the menus and provides descriptions of each item. See the list of default settings in the Appendix “Default Settings” (p.240) to check whether the settings are saved when the camera is turned off and whether the settings return to the defaults when the camera is reset.

[📷 Rec. Mode] Menu

This menu shows the functions related to taking still pictures and recording movies.

Item	Description	Page	
Pixel Track SR	For correcting camera shake during shooting	p.119	
Recorded Pixels	For choosing the number of recorded pixels of still pictures	p.110	
White Balance	For adjusting the color balance according to the lighting conditions	p.114	
Focusing Area	For changing the area of the autofocus	p.109	
AE Metering	For setting the area of the screen that is metered to determine the exposure	p.116	
Sensitivity	For setting the sensitivity	p.117	
EV Compensation	For adjusting the overall brightness of the picture	p.112	
Movie	Recorded Pixels	For choosing the number of recorded pixels of movies	p.128
	Movie SR	For choosing whether or not to use the movie shake reduction function	p.129
	Interval Shoot	For recording multiple still pictures taken at a set interval as a movie file	p.130
D-Range Setting	Highlight Correction	Adjusts the bright areas when the image is too bright	p.113
	Shadow Correction	Adjusts the dark areas when the image is too dark	
Interval Shoot	Interval	For setting the interval between shots	p.98
	Number of Shots	For setting the number of shots to be taken	
	Start Delay	For setting the start time for interval shooting	
Blink Detection	For choosing whether to use the Blink Detection function when the Face Recognition function worked	p.118	
Digital Zoom	For choosing whether or not to use the Digital Zoom function	p.83	
Instant Review	For choosing whether to display Instant Review	p.120	
Memory	For choosing whether to save the set values of the shooting function or return to the defaults when the camera is turned off	p.133	
Green Button	For assigning a function to the Green button in 📷 mode	p.124	
Sharpness	For choosing sharp or soft outlines	p.121	
Saturation	For setting the color saturation	p.122	
Contrast	For setting the image contrast level	p.122	
Date Imprint	For choosing whether to imprint the date and/or time when taking still pictures	p.123	

● [📷 Rec. Mode] Menu 1

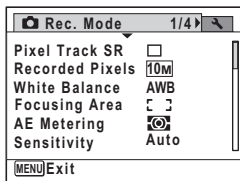

● [📷 Rec. Mode] Menu 2

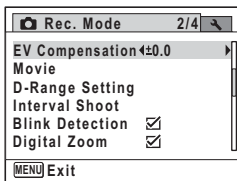

● [📷 Rec. Mode] Menu 3

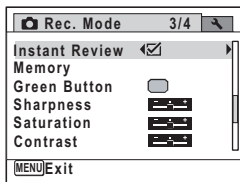

● [📷 Rec. Mode] Menu 4

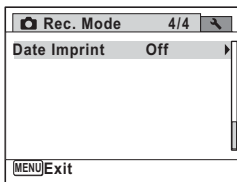

- Use the **●** (Green) mode to enjoy easy picture-taking using standard settings, regardless of the settings in the [📷 Rec. Mode] menu (p.80).
- Assigning frequently used functions to the Green button enables you to go straight to the desired function (p.124).

[🔧 Setting] Menu

Item	Description	Page
Sound	For adjusting the operation volume and playback volume, and setting the start-up sound, shutter sound, key operation sound and self-timer sound	p.193
Date Adjustment	For adjusting the date and time	p.194
Alarm	For setting the alarm	p.208
World Time	For setting the Hometown and Destination	p.197
Language/言語	For setting the language in which menus and messages appear	p.199
Folder Name	For choosing how names are assigned to folders for storing images and sound files	p.200
USB Connection	For setting the USB connection mode (MSC or PTP) when connected to a computer via the USB cable	p.218
Video Out	For setting the output format to AV equipment	p.201

Item	Description	Page
Brightness Level	For changing the brightness of the display	p.202
Power Saving	For setting the time until the camera enters power-saving mode	p.203
Auto Power Off	For setting the time until the camera turns off automatically	p.204
Reset	For returning settings to their defaults	p.207
Delete All	For deleting all the saved images and sound files at once	p.154
Pixel Mapping	For mapping out and correcting for defective pixels in the CCD sensor	p.206
Format	For formatting the SD Memory Card	p.192

● [Setting] Menu 1

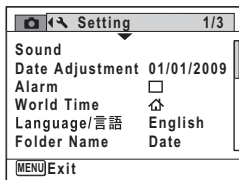

● [Setting] Menu 2

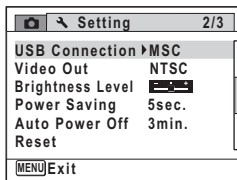

● [Setting] Menu 3

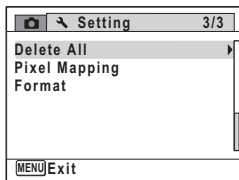

Memo

3 Taking Pictures

Taking Still Pictures	70
Setting the Shooting Functions	105
Recording Movies	126
Saving the Settings (Memory)	133

Taking Still Pictures

Taking Pictures

The Optio WS80 features a wide range of shooting modes and functions to suit almost any subject or scene. This chapter describes how to take pictures with the most commonly used standard settings (the factory default settings).

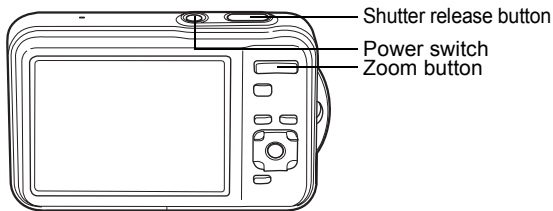

3

Taking Pictures

1 Press the power switch.

The camera turns on and is ready to take still pictures. In this manual, this is called “still picture capture mode”.

2 Confirm the subject and shooting information on the display.

The focus frame in the middle of the display indicates the zone of automatic focusing.



Focus frame

When the camera recognizes a person's face, the Face Recognition function is activated and the face recognition frame appears (p.76).

You can change the captured area by pressing the zoom button (p.82).

- Right (▲) Enlarges the subject.
- Left (▼) Widens the area that is captured by the camera.



Face recognition frame

3 Press the shutter release button halfway.

The focus frame (or face recognition frame) on the display turns green when the camera focuses on the subject at the correct distance.



4 Press the shutter release button fully.

The picture is taken.

The flash discharges automatically depending on the light conditions. The image appears on the display (Instant Review: p.73) and is saved to the SD Memory Card or the built-in memory.



Press the Green button to switch to the  (Green) mode and let the camera set all the shooting functions automatically (p.80).

Using the Shutter Release Button

The shutter release button works in a two-step action as follows.

Press halfway

This refers to pressing the shutter release button gently to the first position. This locks the focus setting and the exposure. The green focus frame lights on the display when the shutter release button is pressed halfway and the subject is in focus. If the subject is out of focus, the frame turns white.

Press fully

This refers to pressing the shutter release button all the way down to the fully depressed position. This takes a picture.

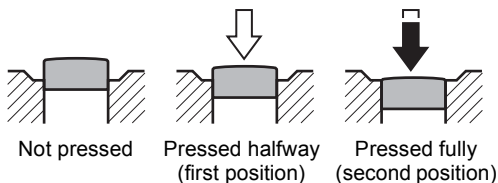

Poor focusing conditions

The camera may not be able to focus under the following conditions. In these cases, lock the focus on an object the same distance away as the subject (by pressing and holding the shutter release button halfway), then aim the camera at your subject and press the shutter release button fully.

- Objects that lack contrast such as a blue sky or white wall
- Dark places or objects, or conditions that prevent light being reflected back
- Horizontal lines or intricate patterns
- Fast moving objects
- When there is an object in the foreground and an object in the background in the captured area
- Strongly reflected light or strong backlighting (bright background)

Instant Review and Blink Detection

The image appears on the display immediately after it is captured (Instant Review). If the camera detects that the subject's eyes are closed while the Face Recognition function (p.76) is activated, the message [Closed eyes have been detected] appears for 3 seconds (Blink Detection).



- When the Face Recognition function does not work, Blink Detection also does not function. Even if the subject's faces are recognized, Blink Detection could not function depending on the condition of the recognized faces.
- You can also disable the Blink Detection function (p.118).

Setting the Shooting Mode

The Optio WS80 has a variety of shooting modes that let you take pictures or record movies in different situations simply by choosing the appropriate mode for the particular situation from the Capture Mode Palette.

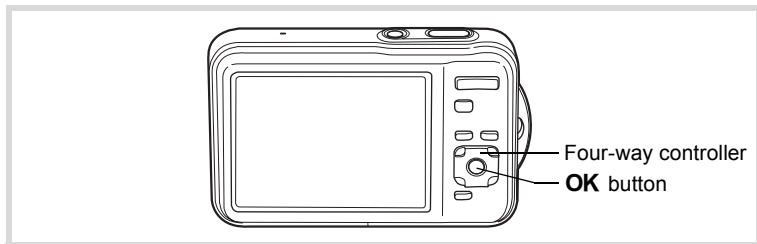

1 Press the four-way controller (▼) in mode.

The Capture Mode Palette appears.

2 Use the four-way controller (▲▼◀▶) to choose a shooting mode.

When an icon is selected in the Capture Mode Palette, the selected shooting mode guide appears.



3

















Press the OK button.









The shooting mode is selected and the camera returns to capture status.



There are 24 shooting modes which can be selected from the Capture Mode Palette.







3

Shooting Mode	Description	Page
 Auto Picture	Automatically selects the best capture mode.	p.78
 Program	Used for basic shooting. Various functions can also be set with this mode.	p.79
 Night Scene	For night time images. Use of a tripod or other support is suggested.	p.86
 Movie	For recording movies.	p.126
 Underwater	For capturing images underwater	p.84
 Underwater Movie	Use this mode for taking underwater movie.	p.84
 Landscape	For capturing landscape views. Enhances colors of sky and foliage.	—
 Flower	For images of flowers. The outline of the flower is softened.	—
 Portrait	For capturing portraits. Reproduces a healthy and bright skin tone.	p.88
 Digital Wide	Stitches two pictures together to create a wider image.	p.100
 Surf & Snow	For bright images such as sand or snow. Accurately meters for bright scenes.	p.91
 Digital SR	Higher sensitivity reduces blur.	p.86
 Kids	For capturing moving kids. Reproduces a healthy and bright skin tone.	p.89
 Pet	For capturing moving pets. Select the color according to the pet's coat.	p.90
 Half-length Portrait	For portraits with proper framing by automatic zoom.	p.88
 Sport	For a fast moving subject. Tracks the subject until the picture is taken.	p.91

Shooting Mode	Description	Page
 Fireworks	For capturing fireworks. Use of a tripod or other support is suggested.	p.86
 Candlelight	For capturing scenes in candlelight.	p.86
 Night Scene Portrait	For images of people at night. Use of a tripod or other support is advised.	p.86
 Natural Skin Tone	For images of people. Enhances skin tones while smoothing blemishes.	p.88
 Food	For images of food and prepared dishes. Enhances saturation and contrast.	—
 Digital Panorama	Stitches images taken with the camera to create a panoramic photograph.	p.102
 Frame Composite	For capturing images with a frame.	p.93
 Party	For capturing images at parties or in dim light. Increases ISO and clarity.	p.92

* In addition to the modes listed above,  (Green) mode (p.80) and Voice Recording (p.184) are also available.



- In shooting modes other than , , , , **WIDE**, ,  and , saturation, contrast, sharpness, white balance, etc. are automatically set to the optimal settings for the selected mode.
- Some functions may not be available or may not work fully depending on the selected shooting mode. For details, refer to “Functions Available for Each Shooting Mode” (p.234).

Using the Face Recognition Function

With the Optio WS80, the Face Recognition function is available with all shooting modes. When the camera detects a person's face in the image, the Face Recognition function displays a yellow face recognition frame around the face on the display screen, sets the focus (Face Recognition AF) and compensates the exposure (Face Recognition AE).



Face recognition frame

3 Taking Pictures
If the subject in the face recognition frame moves, the frame also moves and changes its own size as it tracks the face.

The Face Recognition function can recognize up to 32 people's faces. If it recognizes multiple faces, the camera displays a yellow frame over the main face and white frames over the other face(s). It can display up to a total of 31 frames (up to 30 frames in Half-length Portrait mode), including a main frame and white frame(s).

When the multiple faces are recognized



Main frame White frame



- Face Recognition AF and AE may not work if the subject is wearing sunglasses, has part of their face covered or is not looking toward the camera.
- If the camera cannot recognize the subject's face, the camera focuses using the setting currently selected in [Focusing Area].
- When the Smile Capture function is activated, the shutter may not be released automatically because the Smile Capture function may not work in some situations, such as when the recognized face is too small.

To Switch the Face Recognition Function

By default, the Face Recognition function is set to Face Priority On. You can switch to the Smile Capture function, which automatically releases the shutter when your subject smiles. The Face Recognition function is switched as follows each time the  button is pressed: Smile Capture → Face Priority Off → Face Priority On

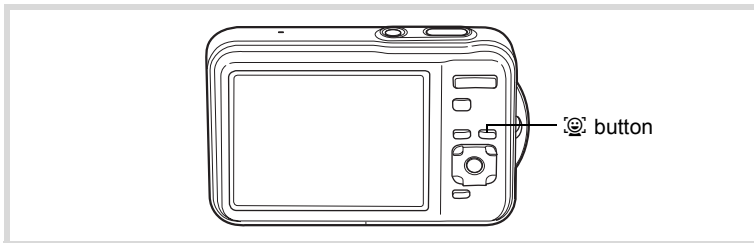

An icon indicating either Face Priority On or Smile Capture appears on the display. (The icon does not appear when the Face Recognition function is not activated.)

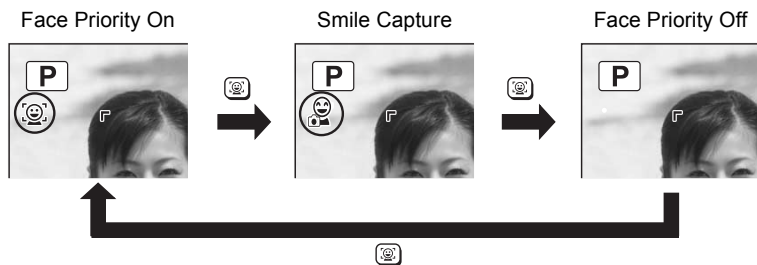

- The Face Recognition function cannot be set to off in **AUTO PICT** (Auto Picture), (Portrait), (Kids), (Half-length Portrait), (Night Scene Portrait) or (Natural Skin Tone) mode. You can select either Face Priority On or Smile Capture in these modes.
- Even if the Face Recognition function is set to off, it is automatically turned on when (Green), **AUTO PICT** (Auto Picture), (Movie), (Underwater Movie), (Portrait), (Kids), (Half-length Portrait), (Night Scene Portrait) or (Natural Skin Tone) mode is selected. When switching to another mode from one of these modes, the Face Recognition setting returns to the previous setting.
- If you use the Face Recognition function when the flash mode is set to (Auto), the flash mode automatically changes to (Flash On + Red-eye) when shooting.

Taking Pictures Automatically (Auto Picture Mode)

In **AUTO PICT** (Auto Picture) mode, the camera automatically selects the most appropriate mode depending on the situations and subjects.

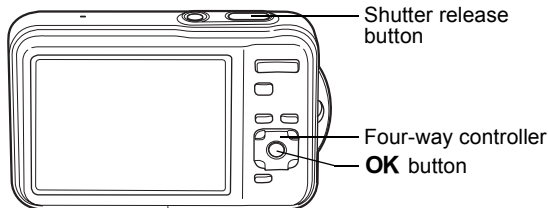

3

Taking Pictures

1 Press the four-way controller (▼) in **📷** mode.

The Capture Mode Palette appears.

2 Use the four-way controller (▲▼◀▶) to select **AUTO PICT**.

3 Press the OK button.

The **AUTO PICT** mode is selected and the camera returns to capture status.

When the camera recognizes a person's face, the Face Recognition function is activated and the face recognition frame appears (p.76).



4 Press the shutter release button halfway.

The selected shooting mode is displayed on the top left of the screen.

AUTO PICT Standard	AUTO PICT Night Scene	AUTO PICT Landscape
AUTO PICT Flower	AUTO PICT Portrait	AUTO PICT Sport
AUTO PICT Candlelight	AUTO PICT Night Scene Portrait	

The focus frame on the display turns green when the camera focuses on the subject at the correct distance.

5 Press the shutter release button fully.

The picture is taken.



The following restrictions apply in **AUTO PICT** mode:

- You cannot turn the Face Recognition function off.
- The focusing area setting is fixed at [] (Multiple).
- The (Flower) mode cannot be selected when using Digital Zoom or Intelligent Zoom.
- If the (Night Scene) mode is selected when the flash mode is (Auto) or (Auto + Red-eye), the flash mode automatically changes to (Flash Off).
- If the (Night Scene Portrait) mode is selected when the flash mode is (Auto), the flash mode automatically changes to (Flash On + Red-eye) when the camera recognizes a face and determines that the flash is needed.
- The camera automatically focuses on the subject when the focus mode is set to **AF** (Standard) or (Macro).

Taking Pictures in the Custom Settings (Program Mode)

In (Program) mode, the camera automatically sets the shutter speed and aperture for taking still pictures. However, you can change other settings such as the flash mode and the number of recorded pixels.

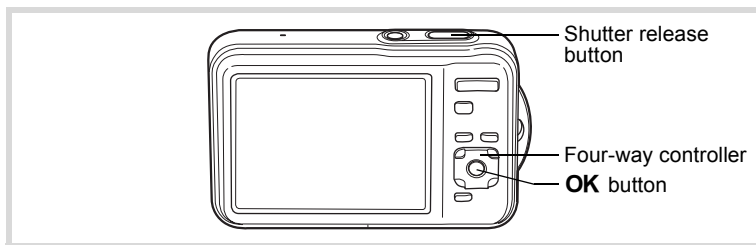

- 1 Press the four-way controller (▼) in mode.**
The Capture Mode Palette appears.
- 2 Use the four-way controller (▲▼◀▶) to select .**

3 Press the OK button.

The **P** mode is selected and the camera returns to capture status.

When the camera recognizes a person's face, the Face Recognition function is activated and the face recognition frame appears (p.76).



4 Set the functions you want to change.

Refer to "Setting the Shooting Functions" (p.105 - p.125) for details on how to set the functions.

5 Press the shutter release button halfway.

The focus frame on the display turns green when the camera focuses on the subject at the correct distance.

6 Press the shutter release button fully.

The picture is taken.

Taking Pictures in the Basic Mode (Green Mode)

In **■** (Green) mode, you can enjoy easy picture-taking using standard settings, regardless of the settings in the [**■** Rec. Mode] menu.

The **■** mode settings are as shown below.

Flash Mode	$\frac{1}{2}$ (Auto)	Sensitivity	Auto
Drive Mode	<input type="checkbox"/> (Standard)	EV Compensation	± 0.0
Focus Mode	AF (Standard)	Highlight Correction	<input type="checkbox"/> (Off)
Face Recognition	On	Shadow Correction	<input type="checkbox"/> (Off)
Information Display	Normal	Blink Detection	<input checked="" type="checkbox"/> (On)
Pixel Track SR	<input type="checkbox"/> (Off)	Digital Zoom	<input checked="" type="checkbox"/> (On)
Recorded Pixels	10M (3648×2736)	Instant Review	<input checked="" type="checkbox"/> (On)
White Balance	AWB (Auto)	Sharpness	$- \text{---} +$ (Normal)
Focusing Area	[] (Multiple)	Saturation	$- \text{---} +$ (Normal)
AE Metering	 (Multi-segment metering)	Contrast	$- \text{---} +$ (Normal)
		Date Imprint	Off

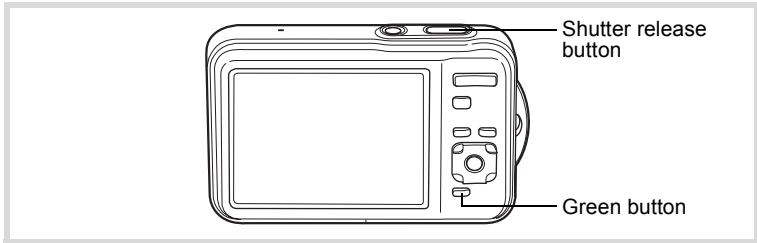

1 Press the Green button in mode.

The camera switches to  mode.

Press the Green button again to return to the status before  mode was selected.

When the camera recognizes a person's face, the Face Recognition function is activated and the face recognition frame appears (p.76).













2 Press the shutter release button halfway.

The focus frame on the display turns green when the camera focuses on the subject at the correct distance.

3 Press the shutter release button fully.

The picture is taken.



- Assign  mode to the [Green Button] on the [ Rec. Mode] for using  mode (p.124). The default setting is  mode.
- In  mode, you cannot change the information on the display by pressing the **OK/DISPLAY** button.
- If you press the **MENU** button in  mode, the [ Setting] menu appears. The [ Rec. Mode] menu cannot be displayed.
- When the camera is turned off in  mode, it turns on in  mode next time the power switch is pressed.

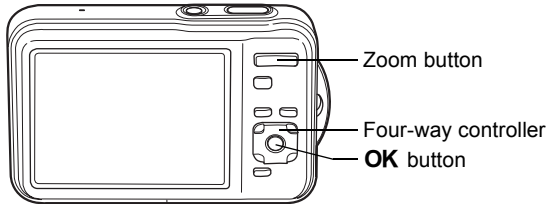

Using the Zoom

You can use the zoom to change the captured area.



3

1 Press the zoom button in mode.

- Right () Enlarges the subject.
- Left () Widens the area that is captured by the camera.

When you continue to press the button towards the right (), the camera automatically switches from optical zoom to Intelligent Zoom.

Once the button is released and pressed again, the camera switches to Digital Zoom.

The zoom bar is displayed as follows.

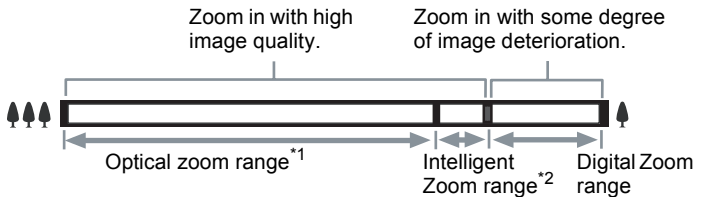
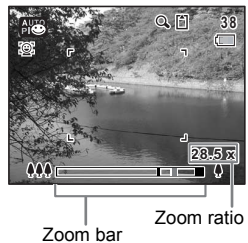

*1 You can zoom in to a maximum of 5x optically.

*2 The Intelligent Zoom range differs depending on the number of recorded pixels. See the following table.

Recorded pixels and the maximum zoom ratio

Recorded Pixels	Intelligent Zoom	Digital Zoom
10M/10M	Not Available (5× optical zoom only)	Equivalent to approx. 28.5×
7M	Approx. 5.9×	
5M	Approx. 7.0×	
3M	Approx. 8.9×	
2.1M/1639	Approx. 9.5×	
1024	Approx. 17.8×	
640	Approx. 28.5× (Same as Digital Zoom)	



- It is recommended to use a tripod to prevent camera shake when taking pictures at high zoom.
- Pictures taken in the Digital Zoom range appear grainier than pictures taken in the optical zoom range.
- Intelligent Zoom is not available under the following conditions:
 - When the number of recorded pixels is set to 10M/10M (5× optical zoom available)
 - In (SR) (Digital SR) mode
 - When the sensitivity is set to 3200 or 6400
- The image enlarged using Intelligent Zoom may appear rough on the display. This does not affect the quality of the recorded image.
- In (Movie) and (Underwater Movie) modes, only Digital Zoom is available while recording.

To Set the Digital Zoom

The Digital Zoom is set to (On) in the default settings. To take pictures using only the optical zoom and Intelligent Zoom, set the Digital Zoom to (Off).

1

Press the MENU button in  mode.

The [ Rec. Mode] menu appears.

2

Use the four-way controller (▲▼) to select [Digital Zoom].

3 Use the four-way controller (◀▶) to select or .

- Uses Digital Zoom
- Uses only optical zoom and Intelligent Zoom

The setting is saved.

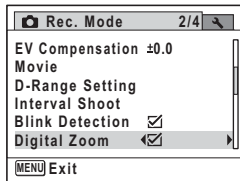



4 Press the MENU button.

The camera returns to capture status.

Saving the Digital Zoom Function setting p.133

Taking Underwater Pictures (Underwater Mode/Underwater Movie Mode)

This camera has been proven to comply with JIS waterproof grade 8 and can be used to take pictures at a depth of 1.5 m continuously for 2 hours. In addition, this camera complies with JIS dustproof grade 6 (IP68).

 Underwater	For capturing images under water. The blue color of water is reproduced beautifully
 Underwater Movie	Use this mode for taking underwater movie

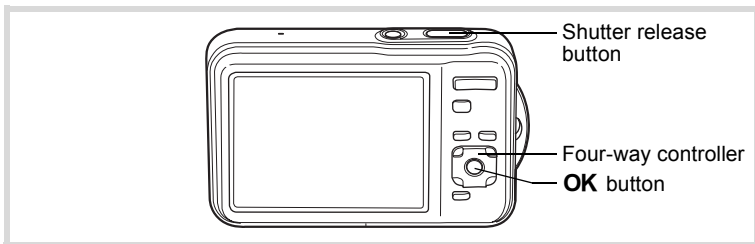



1 Press the four-way controller (▼) in mode.

The Capture Mode Palette appears.

2 Use the four-way controller (▲ ▼ ◀ ▶) to select  or .

3 Press the OK button.



The camera enters  or  mode and returns to capture status. When the camera recognizes a person's face, the Face Recognition function is activated and the face recognition frame appears (p.76).

4 Press the shutter release button halfway.

The focus frame (or face recognition frame) on the display turns green when the camera focuses on the subject at the correct distance.



5 Press the shutter release button fully.

If you selected , a picture is taken.

If you selected , movie recording starts. To stop recording, press the shutter release button fully again. Perform the same steps as  (Movie) to record movies.

Recording Movies  p.126



- Before taking pictures underwater, make sure that there is no dirt or sand on the waterproof packing of the battery/card/terminal cover and check that the cover is securely locked.
- Before opening the battery/card/terminal cover after using the camera underwater, make sure that there is no water, dirt or sand on the camera. Wipe the camera before opening the cover.
- In  mode, AE metering is fixed at  (Multi-segment metering).

Waterproof and Dustproof Function  p.6



- The flash will not discharge in mode.
- When the focus mode is set to **AF** or in mode, press the shutter release button halfway to lock the focus before recording a movie. When the focus mode is set to **MF**, you can only adjust the focus before recording starts.
- Optical and digital zoom in mode are only available before recording starts. Only digital zoom is available during recording.

Although the camera is provided with waterproof and dustproof functions, avoid using the camera under the following conditions. It may momentarily be subjected to water pressure beyond that covered in the guarantee and water may enter the interior of the camera.

- Jumping into the water while holding the camera
- Swimming while holding the camera in your hand
- Using the camera in environments where water is applied forcefully, such as strong river currents and waterfalls

3

Taking Pictures of Dark Scenes (Night Scene/ Night Scene Portrait/Digital SR/Fireworks/ Candlelight Mode)

You can choose settings appropriate for taking pictures of dark scenes, such as nightscapes.

Night Scene	For night time images. Use of a tripod or other support is suggested.
Digital SR	Higher sensitivity reduces blur. The sensitivity is automatically set to Auto and the number of recorded pixels is fixed at [5M] (2592×1944).
Fireworks	For capturing fireworks. Use of a tripod or other support is suggested. The sensitivity is fixed at its minimum setting.
Candlelight	For capturing scenes in candlelight.
Night Scene Portrait	For images of people at night. Use of a tripod or other support is advised. If you use the Face Recognition function when the flash mode is set to (Auto), the flash mode automatically changes to (Flash On + Red-eye) when shooting.

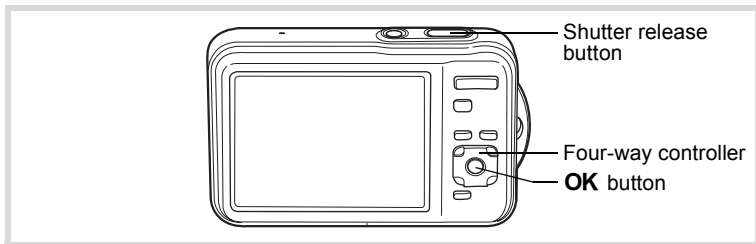

- 1 Press the four-way controller (▼) in mode.**
 The Capture Mode Palette appears.

- 2 Use the four-way controller (▲▼◀▶) to select , , , or .**

- 3 Press the OK button.**
 The , , , or mode is selected and the camera returns to capture status.
 When the camera recognizes a person's face, the Face Recognition function is activated and the face recognition frame appears (p.76).



- 4 Press the shutter release button halfway.**
 The focus frame on the display turns green when the camera focuses on the subject at the correct distance.



- 5 Press the shutter release button fully.**
 The picture is taken.







- The shutter speed tends to be slower when taking pictures of dark scenes.
- To prevent camera shake, set the Pixel Track SR function (p.119) or use a tripod and/or the self-timer function (p.95).

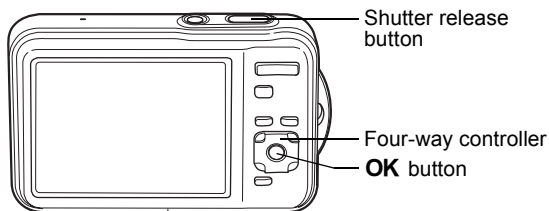

Taking Pictures of People (Portrait/Half-length Portrait/Natural Skin Tone Mode)

The  (Portrait),  (Half-length Portrait) and  (Natural Skin Tone) modes are suitable for taking pictures of people. The Face Recognition function (p.76) operates for each shooting mode, making it easier to emphasize the subject's face when taking pictures.

 Portrait	For capturing portraits. Reproduces a healthy and bright skin tone.
 Half-length Portrait	For portraits with proper framing by automatic zoom. The number of recorded pixels is fixed to 3M (2048×1536).
 Natural Skin Tone	For images of people. Enhances skin tones while smoothing blemishes.



- 1 Press the four-way controller (▼) in  mode.**
The Capture Mode Palette appears.
- 2 Use the four-way controller (▲▼◀▶) to select ,  or .**
- 3 Press the OK button.**

The ,  or  mode is selected and the camera returns to capture status. When the camera recognizes a person's face, the Face Recognition function is activated and the face recognition frame appears (p.76).

If the camera recognizes a person's face in  mode, an orange frame appears showing the area to be zoomed in.



4 Press the shutter release button halfway.

The focus frame on the display turns green when the camera focuses on the subject at the correct distance.

If the camera recognizes a person's face in  mode, the camera automatically zooms in to enlarge the area in the orange frame shown in Step 3.

5 Press the shutter release button fully.

The picture is taken.

Taking Pictures of Children (Kids Mode)

The  (Kids) mode is suitable for taking pictures of moving children. It also reproduces healthy and bright skin tone. The Face Recognition function (p.76) operates automatically for this mode, making it easier to emphasize the subject's face when taking pictures.

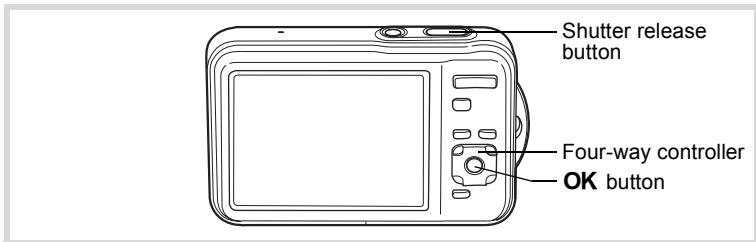

1 Press the four-way controller (▼) in mode.

The Capture Mode Palette appears.

2 Use the four-way controller (▲▼◀▶) to select .

3 Press the OK button.

The  mode is selected and the camera returns to capture status.

When the camera recognizes a person's face, the Face Recognition function is activated and the face recognition frame appears (p.76).



4 Press the shutter release button halfway.



The focus frame on the display turns green when the camera focuses on the subject at the correct distance.

5 Press the shutter release button fully.

The picture is taken.

Taking Pictures of Your Pet (Pet Mode)

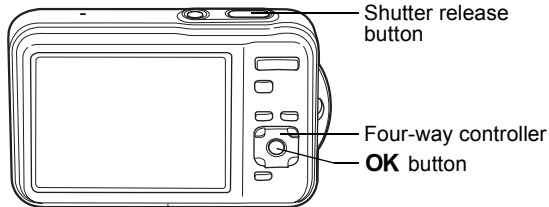





Use  (Pet) mode to keep your moving pet in focus and capture the color of your pet's coat when you take a picture. Choose the appropriate icon depending on what color your pet is (closer to black or white or in between).

**1 Press the four-way controller (▼) in  mode.**

The Capture Mode Palette appears.

2 Use the four-way controller (▲▼◀▶) to select .**3 Press the OK button.**

The  mode selection screen appears.

4 Use the four-way controller (▲▼) to select , , , ,  or .

There are two types of icons: a cat and dog icon. Choosing either the cat or dog icon does not affect the resulting picture. Choose whichever you prefer.

Choose an icon (white, gray, or black) whose tone best matches your pet's coat or fur.



5 Press the OK button.

The selected icon appears and the camera returns to capture status.

When the camera recognizes a person's face, the Face Recognition function is activated and the face recognition frame appears (p.76).



6 Press the shutter release button halfway.



The focus frame on the display turns green when the camera focuses on the subject at the correct distance.

The focus frame follows the subject while the shutter release button is pressed halfway.

7 Press the shutter release button fully.

The picture is taken.

Taking Pictures of Sports and Leisure Activities (Surf & Snow/Sport Mode)

 Surf & Snow	For bright images such as sand or snow. Accurately meters for bright scenes.
 Sport	For a fast moving subject. Tracks the subject until the picture is taken.

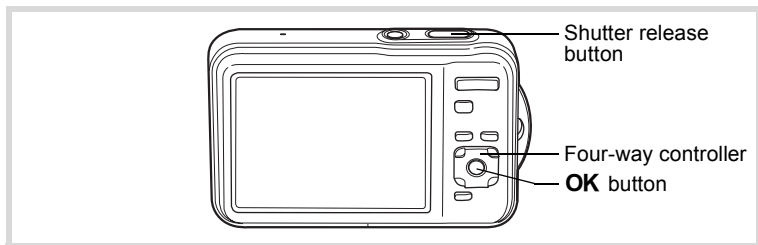



1 Press the four-way controller (▼) in mode.

The Capture Mode Palette appears.

2 Use the four-way controller (▲▼◀▶) to select or .

3 Press the OK button.

The  or  mode is selected and the camera returns to capture status. When the camera recognizes a person's face, the Face Recognition function is activated and the face recognition frame appears (p.76).

**4 Press the shutter release button halfway.**



The focus frame on the display turns green when the camera focuses on the subject at the correct distance. When the  (Sport) mode is selected, the focus frame follows the subject while the shutter release button is pressed halfway.

5 Press the shutter release button fully.

The picture is taken.

Taking Pictures Indoors (Party Mode)

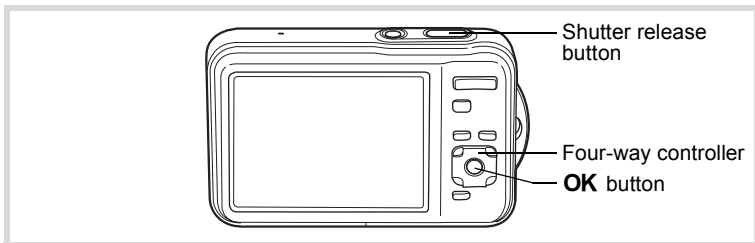
The  (Party) mode is perfect for taking pictures indoors, such as snapshots at parties.

**1 Press the four-way controller (▼) in  mode.**

The Capture Mode Palette appears.

2 Use the four-way controller (▲▼◀▶) to select .**3 Press the OK button.**

The  mode is selected and the camera returns to capture status. When the camera recognizes a person's face, the Face Recognition function is activated and the face recognition frame appears (p.76).

4 Press the shutter release button halfway.

The focus frame on the display turns green when the camera focuses on the subject at the correct distance.

5 Press the shutter release button fully.

The picture is taken.

Framing Your Pictures (Frame Composite Mode)

In  (Frame Composite) mode, you can take pictures using the frames stored in the camera.

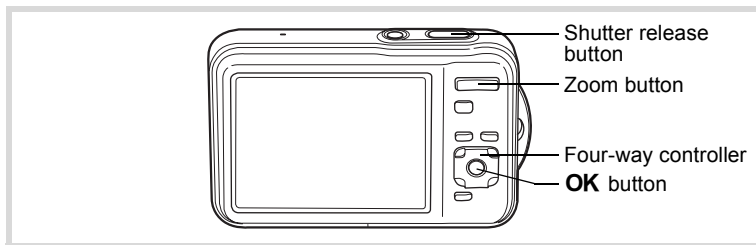

1 Press the four-way controller (▼) in mode.

The Capture Mode Palette appears.

2 Use the four-way controller (▲▼◀▶) to select .

3 Press the OK button.

The 9-frame display of the frame selection screen appears.

4 Use the four-way controller (▲▼◀▶) to choose the frame you want to use.

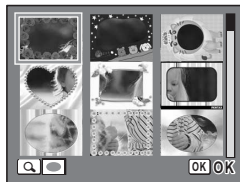

5 Press the zoom button towards the right (Q).

The selected frame appears in single-image display.

You can choose another frame using either of the following operations.

Four-way controller (◀▶)	Press to choose a different frame.
Zoom button towards the left (⊞)	Press to return to the 9-frame display of the frame selection screen, and then perform Step 4 to choose a different frame.

6 Press the OK button.

The framed image appears on the display. When the camera recognizes a person's face, the Face Recognition function is activated and the face recognition frame appears (p.76).

**7 Press the shutter release button halfway.**

The focus frame on the display turns green when the camera focuses on the subject at the correct distance.

8 Press the shutter release button fully.

The picture is taken.



- The number of recorded pixels is fixed at [3M] (2048×1536).
- At shipment, the camera includes 3 default frames and 87 optional frames built-in. (The CD-ROM supplied with the camera contains a total of 90 frames, including the default frames.)

Optional Frames



The optional frames are stored in the built-in memory in the Optio WS80. These optional frames are deleted if the files on the built-in memory are deleted with a computer or the built-in memory is formatted. To reload the optional frames into the built-in memory, copy the files from the CD-ROM (S-SW87) supplied with the camera (p.173).

Adding a Frame to a captured image p.171





Using the Self-timer

In Self-timer mode, the picture is taken ten seconds or two seconds after the shutter release button is pressed.

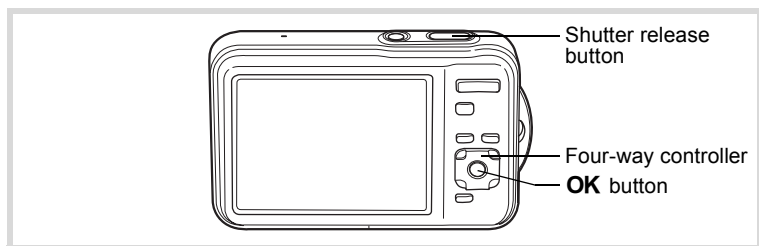
Stabilize the camera with a tripod or other support when taking a picture using the self-timer.

 Self-timer	Use this mode when you want to be included in a group picture. The picture is taken approximately ten seconds after the shutter release button is pressed.
 2 sec. Self-timer	Use this mode to avoid camera shake. The picture is taken approximately two seconds after the shutter release button is pressed.



- 1 Press the four-way controller (▲) in  mode.**
The [Drive Mode] screen appears.
- 2 Use the four-way controller (◀▶) to select  and press the four-way controller (▼).**
- 3 Use the four-way controller (◀▶) to select  or  and press the OK button.**
The camera is ready to take the picture using the self-timer.
When the camera recognizes a person's face, the Face Recognition function is activated and the face recognition frame appears (p.76).
- 4 Press the shutter release button halfway.**
The focus frame on the display turns green when the camera focuses on the subject at the correct distance.



5

Press the shutter release button fully.

The picture is taken ten seconds or two seconds later.



Focusing may be compromised if you move the camera while the self-timer lamp is blinking when taking still pictures.



- In (Movie) and (Underwater Movie) modes, recording will start after ten seconds (or two seconds).
- Press the shutter release button halfway while the self-timer is engaged to stop the countdown and press fully to restart the countdown.
- cannot be selected while (Green) mode setting remains the default. Select in another shooting mode and then switch the shooting mode to .

3

Taking a Series of Pictures (Continuous Shooting/Burst Shooting Mode)

In these modes, pictures are taken continuously as long as the shutter release button is pressed.

Continuous Shooting	Each time a picture is taken, the image is saved in the memory before the next image is taken. The higher the image quality, the longer the interval between shots. You can continue shooting until the memory of the SD Memory Card or the built-in memory is full.
Burst Shooting	The number of recorded pixels is fixed at [5M] (2592×1944) and up to 7 pictures are taken consecutively at 3.3 frames per second (5.6 frames per second when the sensitivity is 3200 or 6400).

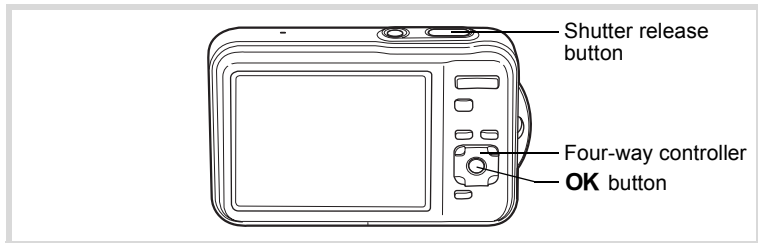



1

Press the four-way controller (▲) in mode.

The [Drive Mode] screen appears.

2 Use the four-way controller (◀▶) to select  and press the four-way controller (▼).

3 Use the four-way controller (◀▶) to select  or  and press the OK button.

The camera is ready to take a series of pictures.















4 Press the shutter release button halfway.

The focus frame on the display turns green when the camera focuses on the subject at the correct distance.

5 Press the shutter release button fully.

Pictures are taken continuously as long as you keep the shutter release button pressed.



- The flash does not discharge in  and  modes.
-  and  cannot be selected in  (Green),  (Auto Picture),  (Night Scene),  (Movie),  (Underwater Movie),  (Digital Wide),  (Fireworks),  (Digital Panorama) or  (Frame Composite) mode.



- The interval of  (Continuous Shooting) varies according to the Recorded Pixels and Quality Level settings.
- The focus, exposure and white balance are locked with the first shot.
- When the Face Recognition function is activated (p.76), it works only when taking the first shot.
- The Blink Detection function works only for the last shot.

Taking a Series of Pictures at a Set Interval (Interval Shoot)

In  (Interval Shoot) mode, pictures can be taken automatically at a certain interval from a set time. Specify the following settings.

Interval	Set the camera to take pictures in intervals from 10 seconds to 99 minutes. You can set the camera to take pictures in one second increments from ten seconds to four minutes intervals or in one minute increments from four minutes to 99 minutes intervals.
Number of Shots	Set the number of shots to be taken. You can take pictures from 2 to the number of recordable images. However, 1000 shots is the maximum.
Start Delay	Set the start delay from 0 minutes to 24 hours. The start delay can be set in increments of 1 minute for a delay time up to 59 minutes, and increments of 1 hour for a delay time longer than one hour. When set to 0 min., the first picture is taken as soon as the shutter release button is pressed.

1 Press the four-way controller (▲) in mode.

The [Drive Mode] screen appears.

2 Use the four-way controller (◀▶) to select and press the OK button.

The current settings for interval shooting appear for approximately 1 minute. To take pictures with the current settings, proceed to Step 7.

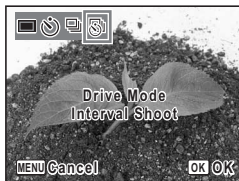

3 Press the OK button.

The [Interval Shoot] screen appears.

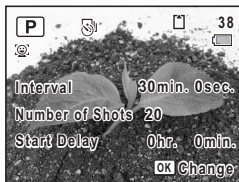

- 4** Use the four-way controller (▲▼) to select [Interval], [Number of Shots] or [Start Delay].

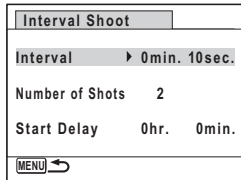

- 5** Press the four-way controller (▶), then use the four-way controller (▲▼) to change the settings.

To change another setting, press the four-way controller (▶).

- 6** When finished, press the MENU button.

The screen shown in Step 3 reappears.

The camera returns to capture status after approximately one minute.

- 7** Press the shutter release button halfway.

The focus frame (or face recognition frame) on the display turns green when the camera focuses on the subject at the correct distance.

- 8** Press the shutter release button fully.

After the message [Start interval shooting] appears, the display turns off. When [Start Delay] is set to [0 min.], the display turns off after the first image taken appears in Instant Review.

When the number of images set in [Number of Shots] is taken, the message [Interval shooting complete] appears and the camera turns off.



- Interval shooting is not available in (Auto Picture), (Digital Wide), (Fireworks) or (Digital Panorama) mode.
- The alarm will not ring during interval shooting.



- Refer to p.130 for instructions on interval shooting in (Movie) and (Underwater Movie) modes.
- The display turns off between shots (during standby). Press the power switch during standby to display the remaining number of shots and interval on the display.
- The message [Stop interval shooting?] appears when the power switch and then the MENU button are pressed during standby. To cancel interval shooting, press the OK button.
- Settings for interval shooting can also be made in [Interval Shoot] in the [Rec. Mode] menu. Perform Steps 4 to 6 to make the settings.

Using the Digital Wide Function (Digital Wide Mode)

In **WIDE** (Digital Wide) mode, you can stitch two vertical images captured with this camera into a single frame up to approx. 25.4 mm coverage (35 mm film equivalent).

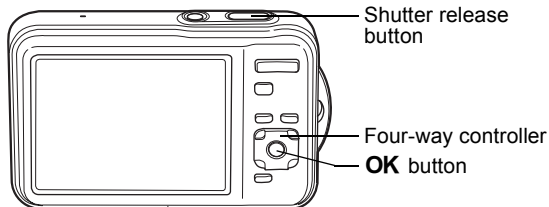
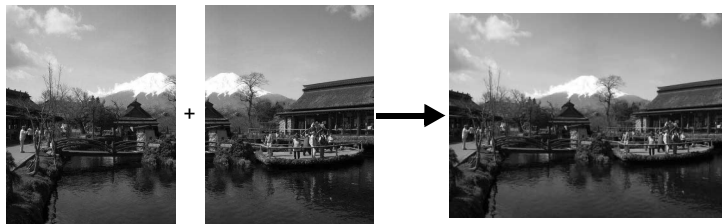

- 1 Press the four-way controller (▼) in  mode.**
The Capture Mode Palette appears.
- 2 Use the four-way controller (▲▼◀▶) to select **WIDE**.**

3 Press the OK button.

The camera enters the **WIDE** mode.
Turn the camera 90° counterclockwise and align your first picture.
When the camera recognizes a person's face, the Face Recognition function is activated and the face recognition frame appears (p.76).



4 Press the shutter release button halfway.

The focus frame on the display turns green when the camera focuses on the subject at the correct distance.

5 Press the shutter release button fully.

The first captured image is temporarily saved, and the shooting screen for the second image is displayed.



6 Take the second image.

Overlap the image on the preview guide on the left of the screen to compose the second image. Repeat Steps 4 and 5 to take the second image.

The stitched first and second image appears on the display (Instant Review), and then is saved.



- To minimize distortion when taking the second image, turn the camera so that it pivots around the right edge of the preview guide on the screen.
- Some distortion may result from moving objects, repeating patterns, or if nothing exists when overlapping the first and second image on the preview guide.
- When the Face Recognition function is activated (p.76), it works only when taking the first image.
- The stitched together images are saved with the pixel size of **5M** (2592×1944).

To Cancel after Taking the First Shot

- 1 When the shooting screen for the second image is displayed in Step 5 on p.101, press the **OK** button.

A confirmation dialog appears.

- 2 Use the four-way controller (**▲▼**) to select an option and press the **OK** button.

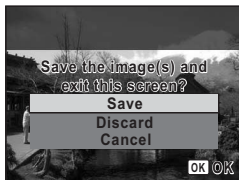

Save	Saves the first image and you can retake the first shot. The first image is saved in [3M] (2048×1536).
Discard	Discards the first image and you can retake the first shot.
Cancel	Returns to the shooting screen for the second image.

Taking Panoramic Pictures (Digital Panorama Mode)

In **■■■** (Digital Panorama) mode, you can stitch together two or three captured frames to create a panoramic photograph with the camera.

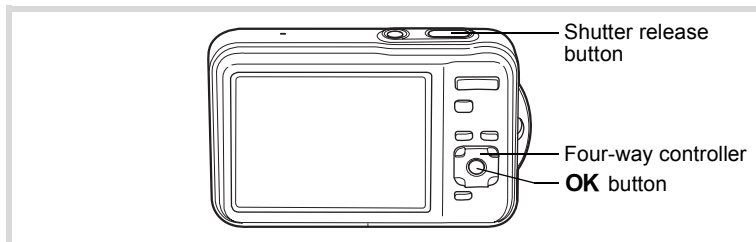

- 1 Press the four-way controller (**▼**) in **📷** mode.

The Capture Mode Palette appears.

- 2 Use the four-way controller (**▲▼◀▶**) to select **■■■**.

3 Press the OK button.

The camera enters the **■■■** mode and the message [Set shift direction] is displayed.

4 Use the four-way controller (◀▶) to choose the direction in which the images will be joined.

The screen for taking the first frame is displayed.



When the camera recognizes a person's face, the Face Recognition function is activated and the face recognition frame appears (p.76).



5 Press the shutter release button halfway.

The focus frame on the display turns green when the camera focuses on the subject at the correct distance.

6 Press the shutter release button fully.

The screen for taking the second frame is displayed after you take the first frame.

If you select right (▶) in Step 4:

The right edge of the first frame appears in semi-transparent form on the left edge of the display.

If you select left (◀) in Step 4:

The left edge of the first frame appears in semi-transparent form on the right edge of the display.

7 Take the second frame.

Move the camera so that the semi-transparent image and the actual view overlap and press the shutter release button.



8

Take the third frame.

Repeat Steps 5 to 7 to take the third frame.

The panorama images are joined and a stitched together image appears.

The stitched together image does not appear when [Instant Review] (p.73, p.120) is (Off).



- Some distortion may result from moving objects, repeating patterns, or if nothing exists when overlapping the first and second frames or the second and third frames on the preview guide.
- When the Face Recognition function is activated (p.76), it works only when taking the first frame.

3

To Cancel after Taking the First or Second Frame

1

After shooting the first frame in Step 6 on p.103 or the second frame in Step 7, press the OK button.

A confirmation dialog appears.

2

Use the four-way controller (▲▼) to select an option and press the OK button.

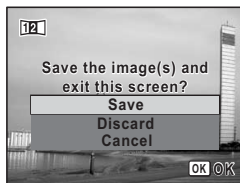







Save	Saves the captured image(s) and you can retake the first frame. When this option is selected after shooting the second frame, the first and the second frames are stitched together and saved as a panoramic photograph.
Discard	Discards the captured image(s) and you can retake the first frame.
Cancel	Returns to the previous shooting screen.















Unstitched images captured in **2M** mode are saved with a pixel size of **2M** (1600×1200).

Setting the Shooting Functions

Selecting the Flash Mode

 Auto	The flash discharges automatically depending on the light conditions. If you use the Face Recognition function, the mode is automatically set to  when shooting.
 Flash Off	The flash does not discharge, regardless of the brightness. Use this mode to take pictures where flash photography is prohibited.
 Flash On	The flash discharges regardless of the brightness.
 Auto + Red-eye	This mode reduces the phenomenon of red eyes caused by the light from the flash being reflected in the subject's eyes. The flash discharges automatically (A pre-flash discharges before the main flash).
 Flash On + Red-eye	This mode reduces the phenomenon of red eyes caused by the light from the flash being reflected in the subject's eyes. The flash discharges regardless of the light conditions (A pre-flash discharges before the main flash).
 Soft Flash	This mode reduces the intensity of the flash so that the flash is not too bright even when fired at close range. The flash discharges regardless of the light conditions.



- The flash mode is fixed at  in the following situations:
 - When  (Movie),  (Underwater Movie) or  (Fireworks) is selected as the capture mode
 - When  (Continuous Shooting) or  (Burst Shooting) is selected as the drive mode
 - When  (Infinity) is selected as the focus mode
- In  (Green) mode, you can only select  or .
- In  (Night Scene) mode, you cannot select  and .



Using the flash when capturing images at a close distance may cause irregularities in the image due to the light distribution.

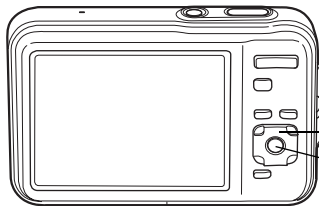

Four-way controller
OK button

1 Press the four-way controller (◀) in  mode.



The [Flash Mode] screen appears. The flash mode changes each time the button is pressed. You can also change the setting using the four-way controller (▲▼).



2 Press the OK button.



The setting is saved and the camera returns to capture status.

About the red-eye phenomenon

Taking pictures using the flash may cause the subject's eyes to appear red in the resulting picture. This phenomenon occurs when the light from the flash is reflected in the subject's eyes. It can be reduced by illuminating the area around the subject or moving closer to the subject and zooming out to a wider angle. Setting the flash mode to  or  is also an effective way of reducing red eyes. If the subject's eyes appear red despite such precautions, they can be corrected by the red-eye compensation function (p.170).

Saving the Flash Mode setting  p.133

Selecting the Focus Mode

AF Standard	Use this mode when the distance to the subject is 40 cm (16 in.) or more. The camera is focused on the subject in the autofocus area when the shutter release button is pressed halfway.
 Macro	This mode is used when the distance to the subject is approx. 10 cm to 50 cm (4 in. to 20 in.). The camera is focused on the subject in the autofocus area when the shutter release button is pressed halfway.
PF Pan Focus	This mode is used when you ask someone to take pictures for you, or when taking pictures of the scenery through the window of a car or train. The entire picture, from the front to the back, is focused.
 Infinity	This mode is used for taking distant objects. The flash is set to  (Flash Off).
MF Manual Focus	This mode lets you adjust the focus manually.

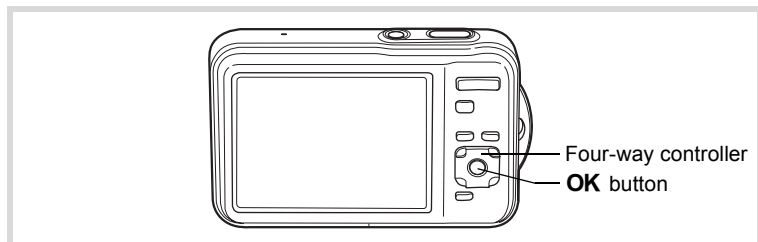

1 Press the four-way controller (▶) in mode.

The [Focus Mode] screen appears.

The focus mode changes each time the button is pressed. You can also change the setting using the four-way controller (▲▼).

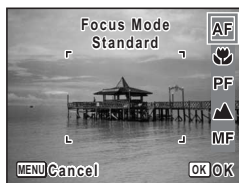

2 Press the OK button.

The setting is saved and the camera returns to capture status.



- In **AF** (Green) mode, you can only select **AF**, **MF** or **PF**.
- The focus mode is fixed at **MF** in **Fireworks** mode.
- The noise from focusing is recorded when the focus mode is set to **AF**, **MF** or **MF** in **Movie** and **Underwater Movie** modes.
- When **AF** is selected and the subject is closer than 40 cm, the camera automatically focuses from 10 cm (Auto-Macro function). In this case, **MF** appears on the display.
- When shooting with **MF** selected, if the subject is further than 50 cm away, the camera automatically focuses to ∞ (Infinity). By pressing the shutter release button fully, you can also take a picture even when the focus is not set.

3

Saving the Focus Mode setting p.133

To Set the Focus Manually (Manual Focus)

1 Press the four-way controller (▶) in **AF** mode.

The [Focus Mode] screen appears.

2 Press the four-way controller (▶) to select **MF**.

3 Press the **OK** button.

The central portion of the image is magnified to full screen on the display.

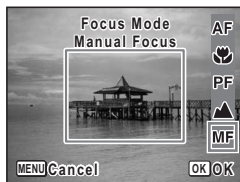

4 Use the four-way controller (▲▼) to adjust the focus.

The **MF** indicator appears on the display to indicate the approximate distance to the subject. Adjust the focus using the indicator as a guide.

- ▲ for distant focus
- ▼ for closer focus

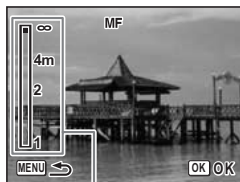

MF indicator

5 Press the OK button.

The focus is fixed and the camera returns to capture status. After the focus is fixed, you can press the four-way controller (▶) again to display the **MF** indicator and readjust the focus.



The shooting mode and drive mode cannot be changed while the **MF** indicator is displayed.



To switch from **MF** to another focus mode, press the four-way controller (▶) while the **MF** indicator is displayed.

To Set the Focusing Area

You can change the autofocus area (Focusing Area).

[] Multiple	Normal autofocus area
[] Spot	The autofocus area becomes smaller.
[] Automatic Tracking AF	Keeps moving subjects in focus.

1 Press the MENU button in mode.

The [Rec. Mode] menu appears.

2 Use the four-way controller (▲▼) to select [Focusing Area].

3 Press the four-way controller (▶).

A pull-down menu appears.

4 Use the four-way controller (▲▼) to change the focusing area setting.

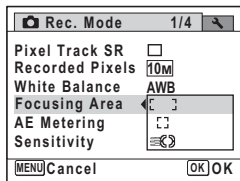

5 Press the OK button.

The setting is saved.

6

Press the MENU button.

The camera returns to capture status.



- In (Movie), (Underwater Movie), and (Frame Composite) modes, the focusing area cannot be set to .
- In (Green) and (Auto Picture) modes, the focusing area is fixed at .
- If you change the focusing area setting frequently, you can save time by assigning it to the Green button (p.124).

3

Selecting the Number of Recorded Pixels

You can choose from eight recorded pixels settings for still pictures. The larger the number of recorded pixels, the clearer the details will appear when you print your picture. As the quality of the printed picture also depends on the image quality, exposure control, resolution of the printer, and other factors, you do not need to select more than the required number of recorded pixels. **3M** is adequate for making postcard-size prints. The more pixels there are, the larger the picture and the bigger the file size.

Refer to the following table for the appropriate settings according to expected usage.

Recorded Pixels	Expected Usage
3648×2736	Clearer For printing high quality photos or A4-size pictures or larger, or editing images on a computer. For making postcard-size prints. For a natural feeling of expansiveness with the same aspect ratio as HDTV. For posting on a website or attaching to e-mail.
3072×2304	
2592×1944	
2048×1536	
1920×1080 (16 : 9)	
1024× 768	
640× 480	

The default setting is **10M**.



- Selecting **10M** provides better image quality than the **10M** setting, but the file sizes will be larger.
- If you select **2.1M16:9**, the aspect ratio of the image is 16:9 and the monitor display for recording and playback is as shown on the right.



1 Press the **MENU** button in mode.

The [Rec. Mode] menu appears.

2 Use the four-way controller () to select [**Recorded Pixels**].

3 Press the four-way controller ().

A pull-down menu appears.

4 Use the four-way controller () to change the number of recorded pixels.

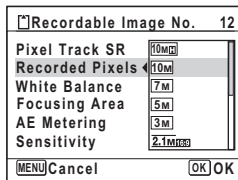

5 Press the **OK** button.

The setting is saved.

6 Press the **MENU** button.

The camera returns to capture status.



- The number of recorded pixels for images captured in (Green) mode is fixed at **10M**.
- The number of recorded pixels for images captured in (Half-length Portrait) or (Frame Composite) is fixed at **3M**.
- The number of recorded pixels for images captured in **WIDE** (Digital Wide) or (Digital SR) mode is fixed at **5M**. (The number of recorded pixels will be **3M** if you exit the **WIDE** mode without taking the second picture.)
- If you change the [Recorded Pixels] setting frequently, you can save time by assigning it to the Green button (p.124).

3

Setting the Exposure (EV Compensation)

You can adjust the overall brightness of the picture.

Use this function to take pictures that are intentionally overexposed or underexposed.

1 Press the MENU button in mode.

The [Rec. Mode] menu appears.

2 Use the four-way controller () to select [EV Compensation].

3 Use the four-way controller () to select the EV value.

To brighten, select a positive (+) value. To darken, select a negative (-) value.

You can choose the EV setting in the range of -2.0 EV to +2.0 EV in 1/3 EV steps.

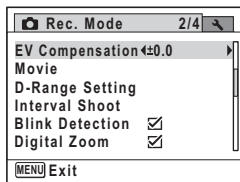

4 Press the MENU button.

The camera returns to capture status.



- When the histogram is displayed in still picture capture mode/playback mode, you can check the exposure (p.30).
- The EV compensation function cannot be used in (Green) or **AUTO PICT** (Auto Picture) mode.
- If you change the [EV Compensation] setting frequently, you can save time by assigning it to the Green button (p.124).

Correcting the Brightness (D-Range Setting)

Expands the dynamic range and prevents bright and dark areas from occurring. [Highlight Correction] adjusts the bright areas when the image is too bright and [Shadow Correction] adjusts the dark areas when the image is too dark.

1 Press the **MENU** button in mode.

The [ Rec. Mode] menu appears.

2 Use the four-way controller () to select [D-Range Setting].

3 Press the four-way controller () .

The [D-Range Setting] screen appears.

4 Use the four-way controller () to select [Highlight Correction] or [Shadow Correction].

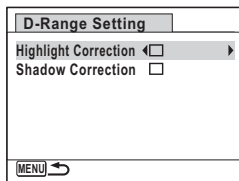



5 Use the four-way controller () to select or .

6 Press the **MENU** button twice.

The camera returns to capture status.

The D-Range Setting icon appears on the display.

	When [Highlight Correction] is set to <input checked="" type="checkbox"/>
	When [Shadow Correction] is set to <input checked="" type="checkbox"/>
	When [Highlight Correction] and [Shadow Correction] are set to <input checked="" type="checkbox"/>





- When [Highlight Correction] is set to , the minimum sensitivity becomes 2× the minimum sensitivity available for this camera.
- If you change the [Highlight Correction] or [Shadow Correction] setting frequently, you can save time by assigning it to the Green button (p.124).

Adjusting the White Balance

You can take pictures in natural colors by adjusting the white balance according to the light conditions at the time of shooting.

3

AWB Auto	The camera adjusts the white balance automatically.
Daylight	Use this mode when taking pictures outside in sunlight.
Shade	Use this mode when taking pictures outside in the shade.
Tungsten Light	Use this mode when taking pictures under electric or other tungsten light.
Fluores. Light	Use this mode when taking pictures under fluorescent light.
Manual	Use this mode when adjusting the white balance manually.



- Set another white balance if you are not satisfied with the color balance of pictures taken with the white balance set to **AWB**.
- Depending on the selected shooting mode, the white balance setting may not be changed. Refer to "Functions Available for Each Shooting Mode" (p.234) for details.

1 Press the **MENU** button in mode.

The [Rec. Mode] menu appears.

2 Use the four-way controller () to select [White Balance].

3 Press the four-way controller () .

The [White Balance] screen appears.

4 Use the four-way controller (▲▼) to change the setting.

You can check the results of selected white balance settings on the preview image each time you press the four-way controller (▲▼).

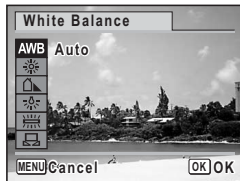

5 Press the OK button.

The setting is saved.

6 Press the MENU button.

The camera returns to capture status.



If you change the [White Balance] setting frequently, you can save time by assigning it to the Green button (p.124).

Saving the White Balance setting p.133

To Set the White Balance Manually

Have a blank sheet of white paper or similar material ready.

1 In the [White Balance] screen, use the four-way controller (▲▼) to select (Manual).

2 Point the camera at the blank sheet of paper or other material so that it fills the frame displayed in the center of the screen.

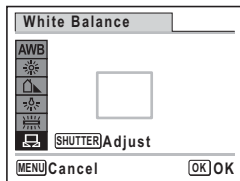

3 Press the shutter release button fully.

The white balance is automatically adjusted.

4 Press the OK button.



The setting is saved and the [📷 Rec. Mode] menu reappears.

5 Press the MENU button.

The camera returns to capture status.

Setting the AE Metering

You can set the area of the screen where the brightness is metered to determine the exposure.

 Multi-segment metering	The camera divides the image into 256 areas, meters the brightness and determines the exposure.
 Center-weighted metering	The camera takes a reading of the overall brightness of the picture with the center of the image having more influence on the exposure.
 Spot AE metering	The camera determines the exposure by metering the brightness only at the center of the image.

1 Press the MENU button in 📷 mode.

The [📷 Rec. Mode] menu appears.

2 Use the four-way controller (▲ ▼) to select [AE Metering].**3 Press the four-way controller (▶).**

A pull-down menu appears.

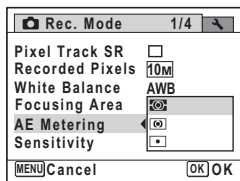
4 Use the four-way controller (▲ ▼) to select the AE Metering setting.**5 Press the OK button.**

The setting is saved.

6 Press the MENU button.

The camera returns to capture status.









- When the shutter release button is pressed halfway, the brightness is metered and the exposure is determined.
- When the subject is outside the focusing area and you want to use  (Spot AE metering), aim the camera at the subject and press the shutter release button halfway to lock the exposure, then compose your picture again and press the shutter release button fully.
- Depending on the selected shooting mode, the AE metering setting may not be changed. Refer to "Functions Available for Each Shooting Mode" (p.234) for details.
- If you change the [AE Metering] setting frequently, you can save time by assigning it to the Green button (p.124).

Saving the AE Metering setting  p.133

Setting the Sensitivity

You can select the sensitivity to suit the brightness of the surroundings.

Auto	The sensitivity is automatically adjusted by the camera. (Sensitivity 64 - 800)
64	 <p>The lower the sensitivity, the less noise that affects the image. The shutter speed will be slower in low light conditions.</p> <p>Higher sensitivity settings use faster shutter speeds in low light conditions to reduce camera shake, but the image may be affected by noise.</p>
100	
200	
400	
800	
1600	
3200	
6400	

- 1 Press the MENU button in  mode.**
The [ Rec. Mode] menu appears.
- 2 Use the four-way controller ( ) to select [Sensitivity].**
- 3 Press the four-way controller ().**
A pull-down menu appears.

4 Use the four-way controller (▲▼) to change the sensitivity.

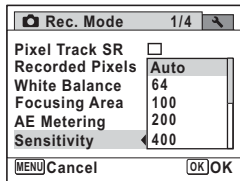

5 Press the OK button.

The setting is saved.

6 Press the MENU button.

The camera returns to capture status.



- When the sensitivity is set to 3200 or 6400, the number of recorded pixels is fixed at **5M** (2592×1944).
- When set to (Green), (Movie) or (Underwater Movie) mode, only Auto (sensitivity 64 - 800) is available.
- When set to (Digital SR) mode, only Auto (sensitivity 64 - 6400) is available.
- When set to (Fireworks) mode, the sensitivity is fixed at its minimum setting.
- If you change the [Sensitivity] setting frequently, you can save time by assigning it to the Green button (p.124).

Saving the Sensitivity setting p.133

Setting Blink Detection

This specifies whether Blink Detection function works when you use the Face Recognition function. The default setting is (On).

1 Press the MENU button in mode.

The [Rec. Mode] menu appears.

2 Use the four-way controller (▲▼) to select [Blink Detection].

3 Use the four-way controller (◀▶) to select or .

- Blink Detection function works.
- Blink Detection function does not work.

The setting is saved.

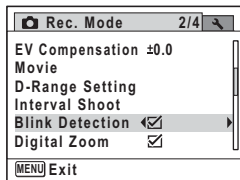

4 Press the MENU button.

The camera returns to capture status.

Blink Detection p.73

Setting Pixel Track SR

You can set this function to correct camera shake which occurs during shooting. If you set Pixel Track SR, the camera automatically corrects any camera shake in the images you shot. The default setting is (Off).



Use the Movie SR function (p.129) to correct camera shake in (Movie) and (Underwater Movie) modes.

1 Press the MENU button in mode.

The [Rec. Mode] menu appears.

2 Use the four-way controller (▲▼) to select [Pixel Track SR].

3 Use the four-way controller (◀▶) to select or .

- Corrects camera shake.
- Does not correct camera shake.

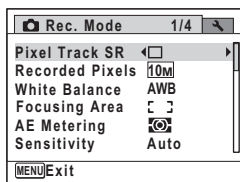



4

Press the MENU button.

The camera returns to capture status.

One of the following icons appears on the display.

	When [Pixel Track SR] is set to <input checked="" type="checkbox"/>
	When the shutter release button is pressed halfway with [Pixel Track SR] set to <input type="checkbox"/> , and the shutter speed is slow or the flash mode is set to  (Flash Off) (Camera shake warning).











When [Pixel Track SR] is set to , camera shake is corrected after shooting, and then the corrected image is saved.

3



The Pixel Track SR function does not work in the following situations:

- When  (Movie),  (Underwater Movie), **WIDE** (Digital Wide),  (Half-length Portrait),  (Fireworks),  (Digital Panorama) or  (Frame Composite) mode is selected as the shooting mode
- When  (Self-timer),  (Continuous Shooting) or  (Burst Shooting) is selected as the drive mode
- When the flash discharges
- When the sensitivity is set to 1600 or higher
- During Voice Recording

Setting the Instant Review

Use this setting to specify whether or not an Instant Review is displayed immediately after images are shot. The default setting is (On).

1

Press the MENU button in mode.

The [ Rec. Mode] menu appears.

2

Use the four-way controller () to select [Instant Review].

3

Use the four-way controller () to select or .

- Instant Review is displayed.
- Instant Review is not displayed.

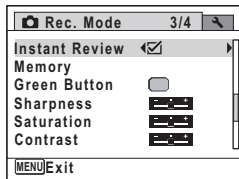

4 Press the MENU button.

The camera returns to capture status.

Instant Review p.73



If the Blink Detection function worked when shooting, the message [Closed eyes have been detected] appears for 3 seconds during Instant Review.

Setting the Image Sharpness (Sharpness)

You can give the image sharp or soft outlines.

1 Press the MENU button in mode.

The [Rec. Mode] menu appears.

2 Use the four-way controller (▲▼) to select [Sharpness].

3 Use the four-way controller (◀▶) to change the sharpness level.

- Soft
- Normal
- Sharp

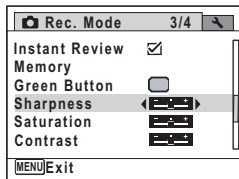

4 Press the MENU button.







The camera returns to capture status.





If you change the [Sharpness] setting frequently, you can save time by assigning it to the Green button (p.124).

Setting the Color Saturation (Saturation)

You can set the color saturation.

- 1 Press the MENU button in  mode.**
The [ Rec. Mode] menu appears.
- 2 Use the four-way controller ( ) to select [Saturation].**
- 3 Use the four-way controller ( ) to change the saturation level.**

-  Low
-  Normal
-  High

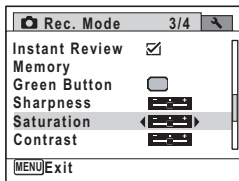







- 4 Press the MENU button.**
The camera returns to capture status.





If you change the [Saturation] setting frequently, you can save time by assigning it to the Green button (p.124).

Setting the Image Contrast (Contrast)

You can set the image contrast level.

- 1 Press the MENU button in  mode.**
The [ Rec. Mode] menu appears.
- 2 Use the four-way controller ( ) to select [Contrast].**
- 3 Use the four-way controller ( ) to change the contrast level.**

-  Low
-  Normal
-  High

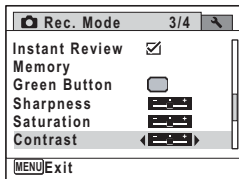

4 Press the MENU button.

The camera returns to capture status.



If you change the [Contrast] setting frequently, you can save time by assigning it to the Green button (p.124).

Setting the Date Imprint Function

You can choose whether to imprint the date and/or time when taking still pictures.

1 Press the MENU button in mode.

The [Rec. Mode] menu appears.

2 Use the four-way controller (▲▼) to select [Date Imprint].

3 Press the four-way controller (▶).

A pull-down menu appears.

4 Use the four-way controller (▲▼) to select the Date Imprint details.

Choose from [Date], [Date & Time], [Time] or [Off].

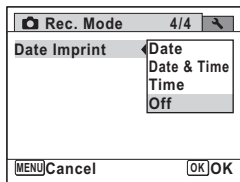

5 Press the OK button.

The setting is saved.

6 Press the MENU button.

The camera returns to capture status.



- The date and/or time imprinted with the Date Imprint function cannot be deleted.
- Note that if the printer or the image editing software is set to print the date and the images to be printed already have the date and/or time imprinted, the imprinted dates and/or times may overlap.



- **DATE** appears on the display in mode when [Date Imprint] is set.
- The date and/or time are imprinted on the picture with the display style set in the [Date Adjustment] screen (p.52).

Calling Up a Specific Function

You can assign a function to the Green button and recall it quickly by simply pressing the Green button. This is useful for going straight to the setting screens of frequently used functions.

The following functions can be assigned to the Green button:

- (Green) Mode
- Recorded Pixels
- White Balance
- Focusing Area
- AE Metering
- Sensitivity
- EV Compensation
- Highlight Correction
- Shadow Correction
- Sharpness
- Saturation
- Contrast
- Voice Recording



- The Green button setting can be returned to its default setting by selecting [Reset] on the [Setting] menu.
- The functions other than (Green) mode and Voice Recording can be set in the usual manner on the [Rec. Mode] menu.
- You cannot save different settings for the same function on the Green button and on the [Rec. Mode] menu.

To Assign a Function to the Green Button

- 1 Press the MENU button in mode.**
The [Rec. Mode] menu appears.
- 2 Use the four-way controller () to select [Green Button].**

3 Press the four-way controller (▶).

A pull-down menu appears.

4 Use the four-way controller (▲▼) to choose a function and press the OK button.

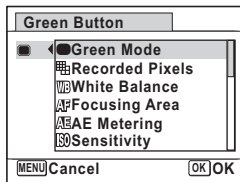

5 Press the MENU button.

The selected function is assigned to the Green button.

To Use the Green Button

1 Press the Green button in mode.

The function assigned to the Green button is called up.

2 Use the four-way controller (◀▶) to change the settings and press the OK button.

The camera returns to capture status.



Taking Pictures in the Basic Mode (Green Mode)  p.80

Recording Sound (Voice Recording)  p.184



If a function other than the  (Green) mode and Voice Recording has been assigned to the Green button, the camera returns to the original screen if no operation is performed for 1 minute after the Green button is pressed.

Recording Movies

Recording a Movie

This mode enables you to record movies. Sound is recorded at the same time.

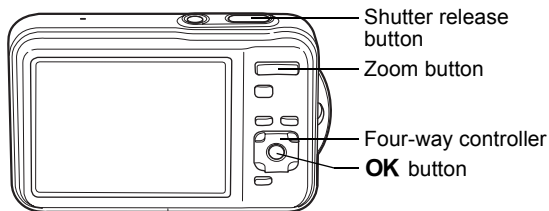

- 1 Press the four-way controller (▼) in mode.**

The Capture Mode Palette appears.

- 2 Use the four-way controller (▲▼◀▶) to select (Movie) or (Underwater Movie).**



- 3 Press the OK button.**

The camera enters or mode and returns to capture status.

The following information appears on the display.

- 1 Movie mode icon
- 2 Recording indicator (blinks during recording)
- 3 Remaining recordable time
- 4 Focus frame (does not appear during recording)
- 5 Movie shake reduction icon

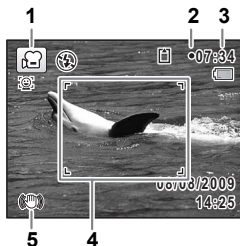

You can change the captured area by pressing the zoom button towards the left or right.

Right () Enlarges the subject.

Left () Widens the area that is captured by the camera.

4 Press the shutter release button fully.





Recording starts. You can continue recording until the built-in memory or the SD Memory Card is full, or the size of the recorded movie reaches 2 GB.

5 Press the shutter release button fully.

Recording stops.

Playing Back a Movie  p.137



- The flash does not discharge in  mode.
- The focus mode can be changed before recording starts.
- When the focus mode is set to **AF** or , press the shutter release button halfway to lock the focus before recording a movie. When the focus mode is set to **MF**, you can only adjust the focus before recording starts.
- You can use the optical zoom only before recording, while the digital zoom is available both before and during recording.
- Even if you change the display mode by pressing the **OK/DISPLAY** button while recording a movie, the histogram cannot be displayed on the monitor.
- When the shooting mode is set to  or , the Face Recognition function is automatically activated. You can switch to Smile Capture or Face Priority Off by pressing the  button before starting recording a movie (p.76). When the Smile Capture function is selected, movie recording starts automatically when the camera recognizes the subject's smile. However, depending on the condition of the recognized faces, movie recording may not start automatically because the Smile Capture function may not work. If this happens, press the shutter release button to start movie recording.







Keeping the Shutter Release Button Pressed

If you keep the shutter release button pressed for more than one second, recording will continue as long as you keep the button pressed. Shooting stops when you take your finger off the shutter release button.



Selecting the Recorded Pixels and Frame Rate for Movies

You can choose the number of recorded pixels and frame rate settings for movies.

The more pixels there are, the clearer the details and the bigger the file size. The more frames per second, the better the quality of the movie, but the file size becomes larger.

Setting	Recorded Pixels	Frame Rate	Use
	1280×720	30 fps	Records images in HDTV format (16:9). Movement is recorded smoothly. (default setting)
	1280×720	15 fps	Records images in HDTV format (16:9). Increases the total recording time by making the file size smaller.
	640×480	30 fps	Suitable for viewing on a TV or computer screen. Movement is recorded smoothly.
	640×480	15 fps	Suitable for viewing on a TV or computer screen. Increases the total recording time by making the file size smaller.
	320×240	30 fps	Suitable for posting on a website or attaching to e-mail. Movement is recorded smoothly.
	320×240	15 fps	Suitable for posting on a website or attaching to e-mail. Increases the total recording time by making the file size smaller.

* The frame rate (fps) indicates the number of frames per second.

- 1 Press the MENU button in  mode.**
The [ Rec. Mode] menu appears.
- 2 Use the four-way controller (▲▼) to select [Movie].**
- 3 Press the four-way controller (▶).**
The [Movie] screen appears.
- 4 Use the four-way controller (▲▼) to select [Recorded Pixels].**
- 5 Press the four-way controller (▶).**
A pull-down menu appears.

- 6** Use the four-way controller (▲▼) to change the number of recorded pixels and frame rate.

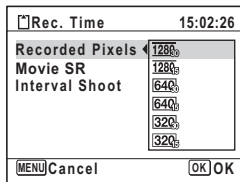

- 7** Press the OK button.

The setting is saved.

- 8** Press the MENU button twice.

The camera returns to capture status.

Setting the Movie SR (Movie Shake Reduction) Function

In or mode, you can correct camera shake while you are recording a movie with the Movie SR (Movie Shake Reduction) function.

- 1** Press the MENU button in mode.

The [Rec. Mode] menu appears.

- 2** Use the four-way controller (▲▼) to select [Movie].

- 3** Press the four-way controller (▶).

The [Movie] screen appears.

- 4** Use the four-way controller (▲▼) to select [Movie SR].

- 5** Use the four-way controller (◀▶) to select or .

- Corrects camera shake.
- Does not correct camera shake.

The setting is saved.

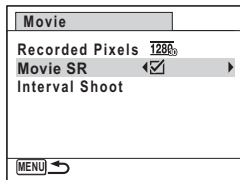





- 6** Press the MENU button twice.

The camera returns to capture status.

Recording a Movie from Pictures Taken at a Set Interval (Interval Movie)

In  (Interval Movie) mode, you can record multiple still pictures taken at a certain interval from a set time, and save them as a movie file. Specify the following settings.

Interval	You can set the interval to 1 minute, 5 minutes, 10 minutes, 30 minutes or 1 hour.
Total Time	Set the total recording time from 10 minutes to 359 hours. The total time and settable units (p.128) vary depending on the [Interval] setting and movie frame rate (p.132).
Start Delay	Set the start delay from 0 minutes to 24 hours. The start delay can be set in increments of 1 minute for a delay time up to 59 minutes, and increments of 1 hour for a delay time longer than one hour. When set to 0 min., the first picture is taken as soon as the shutter release button is pressed.

- 1 Press the four-way controller (▼) in  mode.**
The Capture Mode Palette appears.
- 2 Use the four-way controller (▲▼◀▶) to select  (Movie) or  (Underwater Movie).**
- 3 Press the four-way controller (▲).**
The [Drive Mode] screen appears.
- 4 Use the four-way controller (◀▶) to select  and press the OK button.**

The current settings for interval shooting appear for approximately 1 minute. To record movies with the current settings, proceed to Step 12.

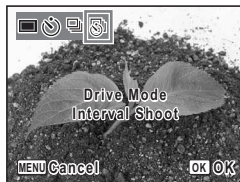

- 5 Press the OK button.**
The [Interval Shoot] screen appears.

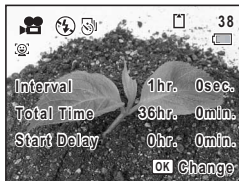

- 6 Use the four-way controller (▲▼) to select [Interval].**

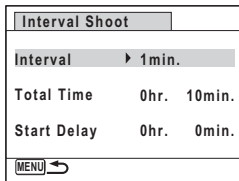

- 7 Press the four-way controller (▶).**
A pull-down menu appears.

- 8 Use the four-way controller (▲▼) to select the interval and press the OK button.**

- 9 Use the four-way controller (▲▼) to select [Total Time] or [Start Delay].**

- 10 Press the four-way controller (▶), then use the four-way controller (▲▼) to change the settings.**
To change another setting, press the four way controller (▶).

- 11 When finished, press the MENU button.**
The screen shown in Step 5 reappears.
The camera returns to capture status after approximately one minute.

- 12 Press the shutter release button halfway.**
The focus frame (or face recognition frame) on the display turns green when the camera focuses on the subject at the correct distance.

13 Press the shutter release button fully.

After the message [Start interval shooting] appears, the display turns off. When [Start Delay] is set to [0 min.], the display turns off after the image immediately taken appears in Instant Review.

When the time set in [Total Time] elapses, the message [Interval shooting complete] appears and the camera turns off.



- Confirm that the battery is sufficiently charged before starting recording. If the battery is not sufficiently charged, it may become depleted during recording and cause recording of the movie to stop.
- The alarm will not ring during interval shooting.

3



- The display turns off between shots (during standby). Press the power switch during standby to display the remaining recordable time and interval on the display.
- The message [Stop interval shooting?] appears when the power switch and then the **MENU** button are pressed during standby. To cancel interval shooting, press the **OK** button.
- In Interval Movie mode, the number of recorded pixels for still pictures is fixed at [640] (640×480) and the flash mode is fixed at ☹ (Flash Off).
- **MF** cannot be selected for the focus mode.
- The time remaining until recording starts is displayed on the monitor up until recording begins.
- [Total Time] varies depending on the [Interval] setting and movie frame rate (p.128). The total time that can be set are as follows.

Interval (Settable Units) \ Frame Rate	30 fps	15 fps
1 min.	10 minutes to 5 hours and 59 minutes	10 minutes to 5 hours and 59 minutes
5 min.	30 minutes to 29 hours and 55 minutes	15 minutes to 29 hours and 55 minutes
10 min.	1 hour to 59 hours and 50 minutes	30 minutes to 59 hours and 50 minutes
30 min.	3 hours to 179 hours and 30 minutes	1 hour and 30 minutes to 179 hours and 30 minutes
1 hr.	6 hours to 359 hours	3 hours to 359 hours

When the frame rate setting is 30 fps, 30 frames of still pictures are played back each second, as a movie. When the frame rate setting is 15 fps, 15 frames are played back each second.











- Settings for interval movie can also be made in [Movie] in the [📷 Rec. Mode] menu. Perform Steps 6 to 11 to make the settings.

Saving the Settings (Memory)

The Memory function is for saving the current camera settings when the camera is turned off.

For some camera settings, the Memory function is always set to (On) (the settings are saved when the camera is turned off), while for others you can choose on or off (to choose whether the settings are saved or not when the camera is turned off). The items which can be set to (On) or (Off) in the Memory function are shown in the table below. (Items not listed here are always saved in the selected settings when the camera is turned off.)

If you select (On), the settings will be saved in the status they were in immediately before the camera was turned off. If you select (Off), the settings will be reset to the defaults when the camera is turned off. The table below also shows whether the Memory default setting for each item is on or off.

Item	Description	Default Setting	Page
Face Priority	A Face Recognition mode set by using the  button	<input type="checkbox"/>	p.76
Flash Mode	The flash mode set with the four-way controller ()	<input checked="" type="checkbox"/>	p.105
Drive Mode	The drive mode set with the four-way controller ()	<input type="checkbox"/>	p.95 p.96 p.98
Focus Mode	The focus mode set with the four-way controller ()	<input type="checkbox"/>	p.107
Zoom Position	The zoom position set with the zoom button	<input type="checkbox"/>	p.82
MF Position	The manual focus position set with the four-way controller ( )	<input type="checkbox"/>	p.108
White Balance	The [White Balance] setting on the [ Rec. Mode] menu	<input type="checkbox"/>	p.114
Sensitivity	The [Sensitivity] setting on the [ Rec. Mode] menu	<input type="checkbox"/>	p.117
EV Compensation	The [EV Compensation] setting on the [ Rec. Mode] menu	<input type="checkbox"/>	p.112
AE Metering	The [AE Metering] setting on the [ Rec. Mode] menu	<input type="checkbox"/>	p.116
Digital Zoom	The [Digital Zoom] setting on the [ Rec. Mode] menu	<input checked="" type="checkbox"/>	p.83
DISPLAY	The information display mode set with the OK/DISPLAY button	<input type="checkbox"/>	p.23
File No.	If a new SD Memory Card is inserted when <input checked="" type="checkbox"/> (On) has been selected, file numbers are assigned sequentially	<input checked="" type="checkbox"/>	—

1 Press the **MENU** button in **📷** mode.

The [📷 Rec. Mode] menu appears.

2 Use the four-way controller (▲▼) to select [Memory].

3 Press the four-way controller (▶).

The [Memory] screen appears.

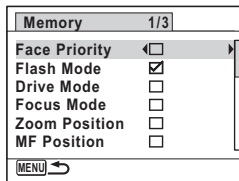
4 Use the four-way controller (▲▼) to choose an item.

5 Use the four-way controller (◀▶) to select or .

6 Press the **MENU** button twice.

The camera returns to capture status.

4 Playing Back and Deleting Images

Playing Back Images	136
Deleting Images and Sound Files	150
Connecting the Camera to AV Equipment	159

Playing Back Images

Playing Back Still Pictures

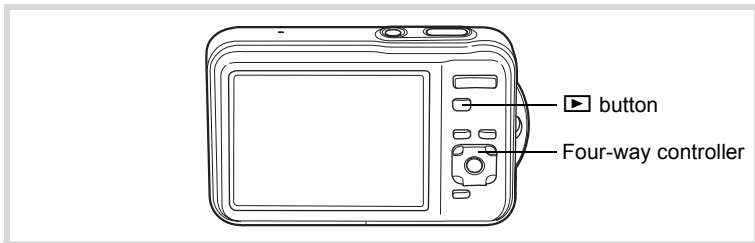

4

Playing Back and Deleting Images

- 1 Press the ▶ button after taking a picture.**

The camera enters the ▶ mode and the captured image appears on the display (single-image display).

File number



To Play Back the Previous or Next Image

- 2 Press the four-way controller (◀▶).**

The previous or next image appears.

To Delete the Displayed Image

Press the  button while the image is displayed to display the Delete screen. Press the four-way controller (▲) to select [Delete] and press the **OK** button.



For information on other deletion procedures  p.150

Playing Back a Movie

You can play back the movies you have taken. The sound is played back at the same time.

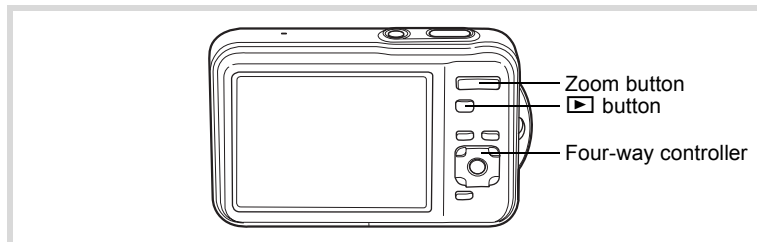

1 In ▶ mode, use the four-way controller (◀▶) to choose the movie you want to play back.

2 Press the four-way controller (▲). Playback starts.



Available operations during playback

Zoom button towards the right (▲)	Increases the volume.
Zoom button towards the left (▼▼▼)	Reduces the volume.
Four-way controller (▲)	Pauses playback.
Four-way controller (▶)	Fast-forwards playback while the button is held down.
Four-way controller (◀)	Plays back in reverse. Fast-reverses playback while the button is held down.

Available operations while playback is paused

Four-way controller (▲)	Resumes playback.
Four-way controller (▶)	Forwards the frame.
Four-way controller (◀)	Reverses the frame.

3 Press the four-way controller (▼). Playback stops.

Multi-Image Display

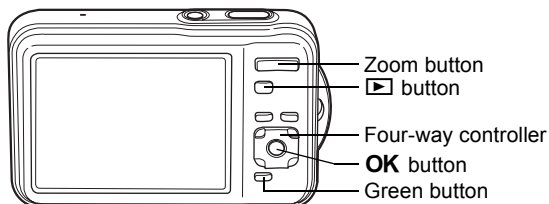

Four-Image Display/Nine-Image Display

4 You can display four or nine thumbnails of captured images at a time.

1 In mode, press the zoom button towards the left ().

The four-image display appears showing a page consisting of four thumbnail images. Press the zoom button towards the left () again to switch to nine-image display.

A page consisting of four or nine thumbnail images appears. The displayed images change four or nine images at a time page by page.

Use the four-way controller (, , ,) to move the frame. If there are too many images to fit on one page, pressing the four-way controller () while the image is selected will display the previous page. Similarly, if you choose image and press the four-way controller (), the next page appears.

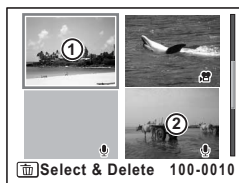

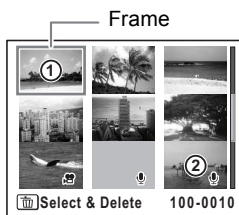

Four-Image Display





Nine-Image Display

The icons that appear on the images indicate the following:



(No icon)	Still picture without sound
	Movie (the first frame appears)
 (With image)	Still picture with sound
 (Without image)	Sound file only

Press the **OK** button to switch to single-image display of the selected image.

Press the  button to switch to  mode.

Folder Display/Calendar Display





In nine-image display, press the zoom button towards the left () to switch to folder display or calendar display. Press the Green button to switch between folder display and calendar display.

1 In  mode, press the zoom button towards the left () three times.

The screen changes to folder display or calendar display.

Folder display

The list of folders with recorded images and sound files appears.

Four-way controller (   )	Moves the frame.
Zoom button towards the right ()/ OK button	Displays the images in the selected folder in nine-image display.
MENU button	Returns to nine-image display.

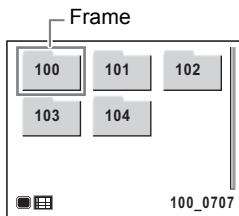

Calendar display

Images and sound files are displayed by date in calendar format.

The first image recorded on a date is displayed for that date on the calendar.

 appears for dates on which a sound file was the first recorded file.

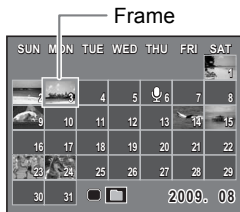

Four-way controller (▲▼◀▶)	Moves the frame.
Zoom button towards the right (Q)	Displays the images for that date in nine-image display.
OK button	Displays the first image recorded on that date in single-image display.
MENU button	Returns to nine-image display.

4

Using the Playback Function

1 Press the four-way controller (▼) in mode.

The Playback Mode Palette appears.

2 Use the four-way controller (▲▼◀▶) to choose an icon.

The guide for the selected function appears below.



3 Press the OK button.



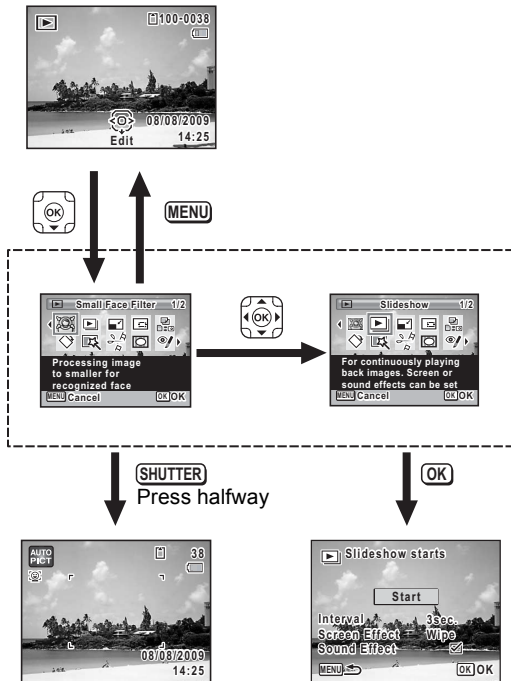











The selected playback function is called up.



Closes the Playback Mode
Palette and goes to mode.

Goes to the screen for
selected playback function.

Playback Mode Palette

Playback Mode	Description	Page
 Small Face Filter	Processing image to smaller for recognized face.	p.164
 Slideshow	For continuously playing back images. Screen or sound effects can be set.	p.143
 Resize	Changes Recorded Pixels and Quality Level to make the file size smaller.	p.162
 Cropping	For cropping images to the size you like. Saved as a new image.	p.163
 Image/Sound Copy	For copying images and sounds between the built-in memory and SD Memory Card.	p.176
 Image Rotation	Rotates captured images. Useful when viewing vertical images on a TV.	p.145
 Digital Filter	For modifying images with a Color filter or Soft filter.	p.166
 Movie Edit	Save as Still Image	p.174
	Divide Movies	
 Frame Composite	For composing an image with a frame. Select Overwrite or Save as to save.	p.171
 Red-eye Compensation	For compensating red-eye. May not work due to the condition of the image.	p.170
 Voice Memo	Attaches sound to images. Recording is possible till the memory card is full.	p.188
 Protect	Protects images and sounds from accidental deletion. Formatting will delete.	p.156
 DPOF	For the print settings. Useful when printing at a printing service.	p.179
 Image Recovery	For recovering image and sound files which were accidentally deleted.	p.155
 Start-up Screen	For setting a captured image as the Start-up Screen.	p.205

Slideshow

You can play back recorded images one after another.

1 In  mode, use the four-way controller (◀▶) to choose the image to start the slideshow with.

2 Press the four-way controller (▼).

The Playback Mode Palette appears.

3 Use the four-way controller (▲▼◀▶) to select  (Slideshow).



4 Press the **OK** button.

The slideshow setting screen appears.

5 Use the four-way controller (▲▼) to select [Start].

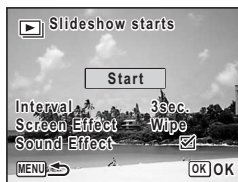

6 Press the **OK** button.

The slideshow starts.

Pressing the **OK** button during the slideshow pauses the slideshow. To resume the slideshow, press the **OK** button again.

7 Press any button other than the **OK** button.

The slideshow stops.

To Set the Slideshow Conditions

You can set the playback interval and also a screen effect and sound effect for when one image changes to the next.

- 1 Use the four-way controller (▲▼) to select [Interval] in Step 5 on p.143.**

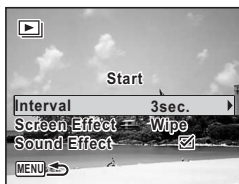

- 2 Press the four-way controller (▶).**

A pull-down menu appears.

- 3 Use the four-way controller (▲▼) to change the interval and press the OK button.**

Choose from [3sec.], [5sec.], [10sec.], [20sec.] or [30sec.].

- 4 Use the four-way controller (▲▼) to select [Screen Effect].**

- 5 Press the four-way controller (▶).**

A pull-down menu appears.

- 6 Use the four-way controller (▲▼) to choose the screen effect and press the OK button.**

Wipe	The next image slides over the previous one from left to right
Checker	The next image appears in small square mosaic blocks
Fade	The current image gradually fades out and the next image fades in
Off	No effect

- 7 Use the four-way controller (▲▼) to select [Sound Effect].**

- 8 Use the four-way controller (◀▶) to select or .**

Except when the [Screen Effect] is set to [Off], you can choose (On) or (Off) for the sound that is played when one image changes to the next.

9 Use the four-way controller (▲▼) to select [Start] and press the OK button.

The slideshow starts using the selected interval and effect.



- The slideshow will continue until you press any button other than the **OK** button.
- Movies or pictures with sound will be played through to the end before the next picture is played back, regardless of the interval setting. However, pressing the four-way controller (▶) while playing back a movie or a picture with sound skips to the next image.
- Sound files made in Voice Recording are not played back in the slideshow.
- Panorama images are displayed by scrolling from left to right in 4 seconds before the next picture is played back, regardless of the Interval or Screen Effect setting.

Connecting the Camera to AV Equipment p.159

Rotating the Image

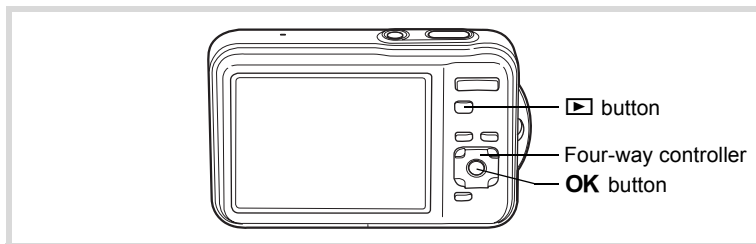

1 Press the ▶ button after taking a picture.

The image appears on the display.

2 Press the four-way controller (▼).

The Playback Mode Palette appears.

- 3** Use the four-way controller (▲▼◀▶) to select  (Image Rotation).

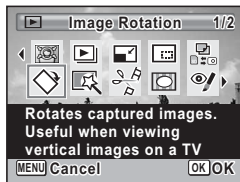

- 4** Press the **OK** button.

The rotation selection screen (0°, Right 90°, Left 90°, or 180°) appears.

- 5** Use the four-way controller (▲▼◀▶) to choose the rotation direction and press the **OK** button.

The rotated image is saved.

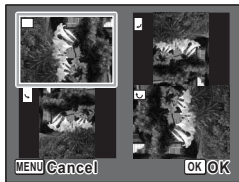



- Panoramic images and movies cannot be rotated.
- Protected images can be rotated, but they cannot be saved in a rotated state.

Zoom Playback

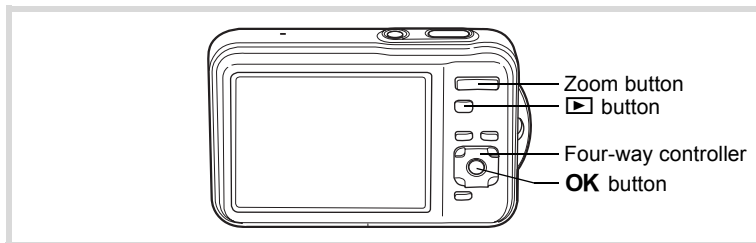
You can magnify an image up to ten times.









1 In  mode, use the four-way controller ( ) to choose the image you want to magnify.

2 Press the zoom button towards the right ().

The image is magnified ($\times 1.1$ to $\times 10$). Continuing to press the zoom button towards the right () changes the magnification continuously.

You can use the + mark of the guide at the bottom left of the screen to check which portion of the image is magnified.

Available operations while an image is magnified

Four-way controller (   )	Moves the position to be magnified.
Zoom button towards the right ()	Makes the image bigger (max. $\times 10$).
Zoom button towards the left ()	Makes the image smaller (min. $\times 1.1$).



Guide

3 Press the OK button.

The image returns to single-image display.





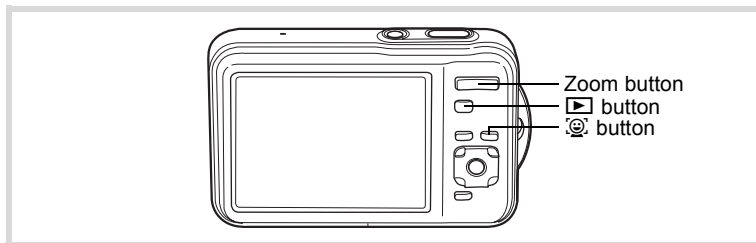

Movies cannot be magnified.

Zoom In on the Subject's Face Automatically (Face Close-up Playback)

You can enjoy playing back images with the subject's faces zoomed up simply by pressing the  button (Face close-up playback) if the Face Recognition function operated when the images were taken.



4

- 1** In  mode, use the four-way controller ( ) to choose the image you want to magnify.
- 2** Confirm that the  icon is displayed in the image and press the  button.

The image is magnified around the face first recognized when the image was taken.



If multiple faces were recognized when the image was taken, the subject's faces are zoomed up on each time the  button is pressed in order of the recognition during shooting.



Available operations during Face close-up playback mode

Zoom button towards the right (Q)	Zooms up on the subject being displayed for Face close-up playback at an equal or slightly larger magnification ratio.
Zoom button towards the left (Z)	Zooms up on the subject being displayed for Face close-up playback at an equal or slightly smaller magnification ratio.

3

Press the OK button.

The image returns to single-image display.



- Face close-up playback is not available for movies or images that are saved as still pictures from movies.
- The magnification ratio for Face close-up playback may differ depending on the conditions such as the size of the face recognized when shooting.

4

Deleting Images and Sound Files

You can delete images and sound files that you do not want to keep.

When images or sound files are inadvertently deleted

Deleted images and sound files can be recovered with the Optio WS80 (p.155). Deleted images and sound files can be recovered even if the camera has been turned off after deletion as long as the SD Memory Card has not been removed. However, deleted images and sound files cannot be recovered after operations to write data such as taking pictures, recording movies, protecting images, saving DPOF settings, resizing images, cropping images, or formatting has been performed.

4

Playing Back and Deleting Images

Deleting a Single Image

You can delete a single image or sound file.



Protected images and sound files cannot be deleted (p.156).

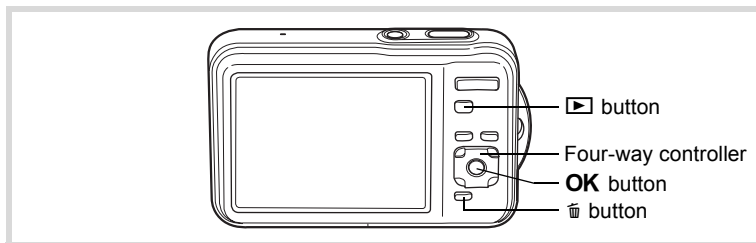

1 In  mode, use the four-way controller (◀▶) to choose the image/sound file you want to delete.

2 Press the  button.

A confirmation screen appears.

- 3** Use the four-way controller (▲▼) to select [Delete].



- 4** Press the OK button.

The image or sound file is deleted.

Recovering Deleted Images p.155

To Delete the Sound from an Image

If sound (voice memo) has been added to an image (p.188), you can delete the sound without deleting the image.

- 1** In  mode, use the four-way controller (◀▶) to choose the image with sound.

 appears on the images with sound.

- 2** Press the  button.

A confirmation screen appears.

- 3** Use the four-way controller (▲▼) to select [Delete Sound].



- 4** Press the OK button.

The sound data is deleted.



- Select [Delete] in Step 3 above to delete both the image and sound data.
- You cannot delete only the sound in a movie.

Deleting Selected Images and Sound Files

You can delete several images/sound files selected from the four-/nine-image display at once.



Protected images and sound files cannot be deleted (p.156).

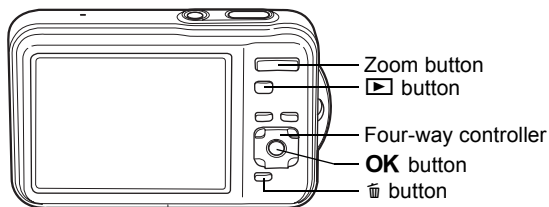

4

- 1 In ▶ mode, press the zoom button towards the left (📷) once or twice.**

Four-image display or nine-image display appears.

- 2 Press the 🗑 button.**

☐ appears on the images and sound files.



- 3 Use the four-way controller (▲▼◀▶) to choose the images and sound files that you want to delete and press the OK button.**

☑ appears on the selected images and sound files.



If you select an image and press the zoom button towards the right (Q), the selected image appears in single-image display as long as the button is pressed, enabling you to check whether you really want to delete it or not. (The display returns to four/nine-image display when you release the button.) However, protected images cannot be displayed in single-image display.

- 4 Press the  button.**

A confirmation dialog appears.

- 5 Use the four-way controller (▲▼) to select [Select & Delete].**



- 6 Press the OK button.**

The selected images and sound files are deleted.

Deleting All Images and Sound Files

You can delete all the images and sound files at once.



Protected images and sound files cannot be deleted (p.156).

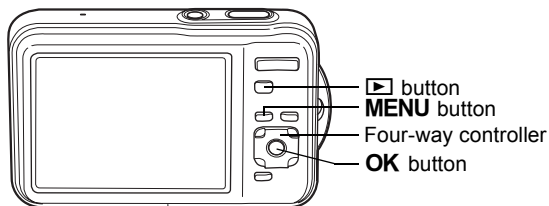

4

Playing Back and Deleting Images

1 Press the MENU button in mode.

The [Setting] menu appears.

When you press the MENU button in mode, press the four-way controller () once.

2 Use the four-way controller () to select [Delete All].

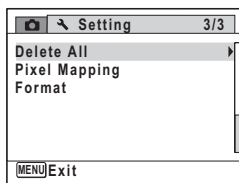

3 Press the four-way controller ().

The [Delete All] screen appears.

4 Use the four-way controller () to select [Delete All].

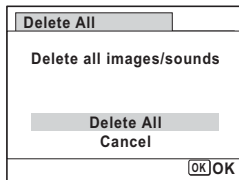

5 Press the OK button.

All the images and sound files are deleted.

Recovering Deleted Images

You can recover images or sound files that were taken with this camera and then deleted.



If any of the following operations have been performed after deleting an image, the deleted image and sound file cannot be recovered.

- Shooting
- Protect or DPOF setting/Resizing/Cropping
- Formatting
- Removing the SD Memory Card

1 After deleting a file, press the four-way controller (▼).

The Playback Mode Palette appears.

2 Use the four-way controller (▲▼◀▶) to select (Image Recovery).

When  is displayed, there are no images that can be recovered.



3 Press the OK button.

The number of recoverable images appears.

If you selected  and pressed the **OK** button, the message [No image to be processed] appears. In this case, press the **OK** button to return to the Playback Mode Palette.

- 4** Use the four-way controller (▲▼) to select [Recover].



- 5** Press the OK button.

The files are recovered.



- Recovered images and sound files have the same file name as before they were deleted.
- Up to a maximum of 999 deleted image files can be recovered.

Protecting Images and Sound Files from Deletion (Protect)

You can protect stored images and sound files from being accidentally deleted.

- 1** In mode, use the four-way controller (◀▶) to choose the image you want to protect.
- 2** Press the four-way controller (▼).
The Playback Mode Palette appears.
- 3** Use the four-way controller (▲▼◀▶) to select (Protect).



- 4** Press the OK button.

The screen for selecting [Single Image/Sound] or [All Images/Sounds] appears.

- 5** Use the four-way controller (▲▼) to select [Single Image/Sound].



- 6** Press the OK button.

The message [Protect this image/sound] appears.

To protect another image or sound file, use the four-way controller (◀▶) to select another image or sound file.

- 7** Use the four-way controller (▲▼) to select [Protect].



- 8** Press the OK button.

The selected image or sound file is protected and the screen shown in Step 5 reappears.

To protect other images or sound files, repeat Steps 5 to 8.

Select [Cancel] to exit the Protect settings.



- To cancel the protection of the image, select [Unprotect] in Step 7.
-  appears on the protected images and sound files during playback.
- The maximum number of images and sound files you can protect in succession with [Single Image/Sound] is 99.

To Protect All Images and Sound Files

- 1** Select [All Images/Sounds] in Step 5 on p.157.

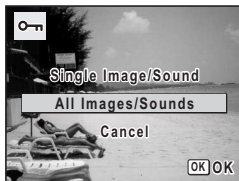

- 2** Press the OK button.

- 3** Use the four-way controller (▲▼) to select [Protect].

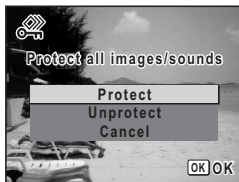

- 4** Press the OK button.

All the images and sound files are protected and the screen shown in Step 1 reappears.

- 5** Use the four-way controller (▲▼) to select [Cancel] and press the OK button.

The Playback Mode Palette reappears.



Protected images and sound files will be deleted if the SD Memory Card is formatted (p.192).



To cancel the protection of all your images and sound files, select [Unprotect] in Step 3.

Connecting the Camera to AV Equipment

By using the supplied AV cable (I-AVC7), you can capture and play back images on equipment with a video IN jack, such as a TV.

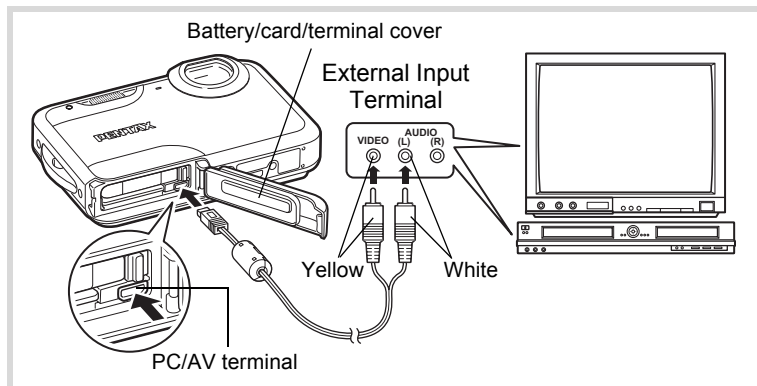

- 1 Turn the AV device and camera off.**
- 2 Open the battery/card/terminal cover of the camera and connect the AV cable to the PC/AV terminal of the camera.**

Connect the terminal of the AV cable with the arrow mark \leftarrow facing the front side of the camera.
- 3 Connect the other ends of the AV cable to the video input terminal and audio input terminal of the AV device.**

When using stereo sound equipment, insert the sound terminal into the L (white) terminal.
- 4 Turn the AV device on.**

When the device that the camera is connected to and the device that plays back images are different, turn both devices on.
When viewing images on AV equipment with multiple video input terminals (such as a TV), refer to the operation manual of the device and select the video input terminal to which the camera is connected.



- It is recommended to use the optional AC adapter kit K-AC88 if you intend to use the camera for a long time (p.40).
- Depending on the country or region, images and sound files may fail to be played back if the video output format is set differently from the one in use there. If this happens, change the video output format setting (p.201).
- The camera display turns off and the volume cannot be adjusted with the zoom button while the camera is connected to AV equipment.



When connecting to and playing back images on AV equipment, image data is output at normal screen resolution. To view movies recorded at 1280i (1280×720, 30 fps) and 1280p (1280×720, 15 fps) in HDTV, transfer the data to a computer and play it back on the computer (p.211).

5 Editing and Printing Images

Editing Images	162
Setting the Printing Service (DPOF)	179

About printing

The following options are available for printing images taken with this camera.

- 1 Use a printing service.**
- 2 Use your printer with an SD Memory Card slot to print directly from the SD Memory Card.**
- 3 Use your computer's software to print images.**

Changing the Image Size (Resize)

By changing the recorded pixels of a selected image, you can make the file size smaller than the original. You can use this function to continue taking pictures when the SD Memory Card or the built-in memory is full, by making the images smaller and overwriting the original images to make more space available.



- Images taken with **2.1M1639** (1920×1080), panoramic images and movies cannot be resized.
- You cannot select a larger resolution than that of the original image.

1 In mode, use the four-way controller (◀▶) to choose the image you want to resize.

2 Press the four-way controller (▼).
The Playback Mode Palette appears.

3 Use the four-way controller (▲▼◀▶) to select (Resize).



4 Press the **OK** button.
The screen for choosing the number of recorded pixels appears.

5 Use the four-way controller (◀▶) to select the number of recorded pixels.



6 Press the OK button.

A confirmation dialog for overwriting the image appears.
If the selected image is protected, the processed image is saved as a new image and the following confirmation dialog does not appear.

7 Use the four-way controller (▲▼) to select [Overwrite] or [Save as].



8 Press the OK button.

The resized image is saved.

Cropping Images

You can delete the unwanted part of a picture and save the cropped image as a new image.



Images taken with **2.1M16:9** (1920×1080), panoramic images and movies cannot be cropped.

1 In mode, use the four-way controller (◀▶) to choose the image you want to crop.

2 Press the four-way controller (▼).

The Playback Mode Palette appears.

3 Use the four-way controller (▲▼◀▶) to select (Cropping).

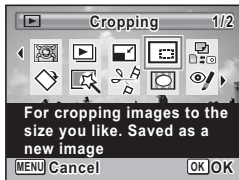

4 Press the OK button.

The cropping screen appears.

The largest size of cropped image is shown with a green frame on the screen. The cropped image cannot be larger than this cropping frame size.

5 Choose the cropping area.

The following operations move the green frame and set the area for cropping on the screen.

Zoom button	Changes the size of the cropped section.
Four-way controller (▲▼◀▶)	Moves the cropping position up, down, left and right.
Green button	Rotates the cropping frame. <ul style="list-style-type: none"> The button is displayed only when the cropping frame size can be rotated.



5 6 Press the OK button.

The cropped image is saved with a new file name.

The number of recorded pixels is selected automatically according to the size of the cropped section.

Processing Images So That Faces Look Smaller

Images are processed to reduce the size of people's faces detected with the Face Recognition function (p.76) when taking pictures so that they look smaller.

1 In mode, use the four-way controller (◀▶) to choose the image you want to edit.

2 Press the four-way controller (▼).

The Playback Mode Palette appears.

3 Use the four-way controller (▲▼◀▶) to select (Small Face Filter).



4 Press the OK button.

Face recognition frames for faces that can be corrected are displayed. Proceed to Step 6 when there is only one recognition frame.

5 Use the four-way controller (▲▼◀▶) to select a face to be processed.

A green frame indicates the face that is to be processed.

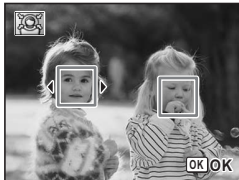
**6 Press the OK button.****7 Use the four-way controller (◀▶) to change the reduction ratio.**

- ▬ — — + Approx. 5 %
- ▬ — — + Approx. 7 %
- ▬ — — + Approx. 10 %

**8 Press the OK button.**

A confirmation dialog for overwriting the image appears. If the selected image is protected, the processed image is saved as a new image and the following confirmation dialog does not appear.

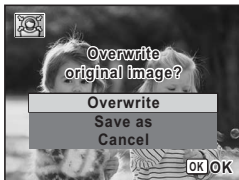
9 Use the four-way controller (▲▼) to select [Overwrite] or [Save as].**10 Press the OK button.**

The camera returns to  mode and the processed image is displayed.



You may not be able to process images in the following situations:

- When the size of face taken in relation to an image is too large or too small
- When faces are located in the edges of an image

In such cases, the face recognition frame in Step 4 will not appear.

Using the Digital Filters

This function lets you change the color tones and perform special processing on a selected image.

B&W	Processes the image into one that has the look of a black and white photograph.
Sepia	Processes the image into one that has the look of a sepia photograph.
Toy Camera	Processes the image that looks as though it was shot with a toy camera.
Retro	Processes the image into one that has the look of an old photo.
Color	Processes the image using the selected color filter. You can choose from six filters: red, pink, purple, blue, green, and yellow.
Color extraction	Extracts only a specific color and processes the rest of the image into black and white. You can choose from three filters: red, green, and blue.
Color enhancer	There are four filters: Sky Blue/Fresh Green/Delicate Pink/Autumn Leaves.
Soft	Processes the image into a soft image that appears soft overall.
Brightness	Adjusts the brightness of the image.



Panoramic images, movies or images taken with another camera cannot be edited using Digital Filter function.

1 In  mode, use the four-way controller (◀▶) to choose the image you want to edit.

2 Press the four-way controller (▼).
The Playback Mode Palette appears.

- 3** Use the four-way controller (▲▼◀▶) to select  (Digital Filter).

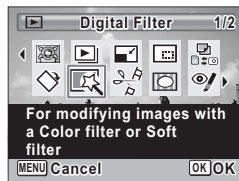

- 4** Press the OK button.

The filter selection screen appears.

- 1 B&W
- 2 Sepia
- 3 Toy Camera
- 4 Retro
- 5 Color
- 6 Color extraction
- 7 Color enhancer
- 8 Soft
- 9 Brightness



Subsequent steps vary depending on your selection.

To Select a B&W, Sepia or Soft Filter

- 5** Use the four-way controller (▲▼) to choose a filter.

The preview image of the results of the filter effect appears.

- 6** Press the OK button.

A confirmation dialog for overwriting the image appears.

If the selected image is protected, the processed image is saved as a new image and the following confirmation dialog does not appear.

- 7** Use the four-way controller (▲▼) to select [Overwrite] or [Save as].

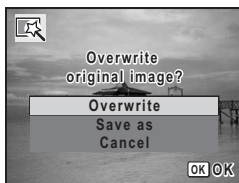

8 Press the OK button.

The image processed with the filter is saved.

To Select a Retro, Color, Color Extraction or Color Enhancer Filter

5 Use the four-way controller (▲▼) to choose a filter.

The preview image of the results of the filter effect appears.

6 Use the four-way controller (◀▶) to choose the color.

The color filter changes in the following sequence each time the four-way controller (▶) is pressed.



Retro	Original image → Amber → Blue
Color	Red → Pink → Purple → Blue → Green → Yellow
Color extraction	Red → Green → Blue
Color enhancer	Sky Blue → Fresh Green → Delicate Pink → Autumn Leaves

7 Press the OK button.

A confirmation dialog for overwriting the image appears.

If the selected image is protected, the processed image is saved as a new image and the following confirmation dialog does not appear.

8 Use the four-way controller (▲▼) to select [Overwrite] or [Save as].



9 Press the OK button.

The image processed with the filter is saved.

To Select a Toy Camera or Brightness Filter

5 Use the four-way controller (▲▼) to choose a filter.

The preview image of the results of the filter effect appears.

6 Use the four-way controller (◀▶) to adjust the effect.



	Four-way controller (◀)	Default Setting	Four-way controller (▶)
Toy Camera	Weak	Medium	Strong
Brightness	Dark	Standard	Bright

7 Press the OK button.

A confirmation dialog for overwriting the image appears.

If the selected image is protected, the processed image is saved as a new image and the following confirmation dialog does not appear.

8 Use the four-way controller (▲▼) to select [Overwrite] or [Save as].

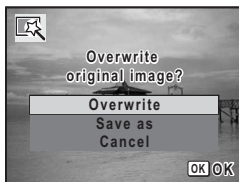

9 Press the OK button.

The image processed with the filter is saved.

Red-eye Compensation

You can correct images where the flash has caused the subject to appear with red eyes.



- The red-eye compensation function cannot be used on panoramic images, movies or on images where red eyes cannot be detected on the camera. An error message appears in Step 4.
- The red-eye compensation function can only be used with still pictures taken with this camera.

1 In mode, use the four-way controller (◀▶) to choose the image you want to correct.

2 Press the four-way controller (▼).
The Playback Mode Palette appears.

3 Use the four-way controller (▲▼◀▶) to select (Red-eye Compensation).

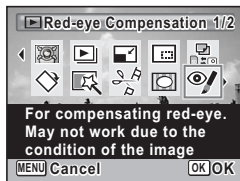

4 Press the OK button.

A confirmation dialog for overwriting the image appears.

If the selected image is protected, the processed image is saved as a new image and the following confirmation dialog does not appear.

5 Use the four-way controller (▲▼) to select [Overwrite] or [Save as].

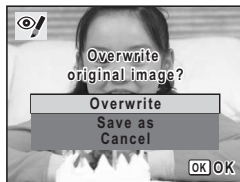

6 Press the OK button.

The edited image is saved.

Adding a Frame (Frame Composite)

This function lets you add a decorative frame to still pictures. There are 90 frames already stored in the camera.



The Frame Composite function cannot be used on images taken with **2.1MP** (1920×1080), panoramic images, movies or images of size **3M** (2048×1536) or smaller. An error message appears in Step 4.

1 In mode, use the four-way controller (◀▶) to choose the image to which you want to add a frame.

2 Press the four-way controller (▼).

The Playback Mode Palette appears.

3 Use the four-way controller (▲▼◀▶) to select (Frame Composite).

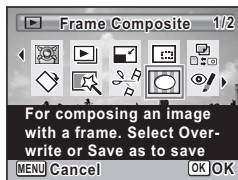

4 Press the **OK** button.

The 9-frame display of the frame selection screen appears.

5 Use the four-way controller (▲▼◀▶) to choose a frame.

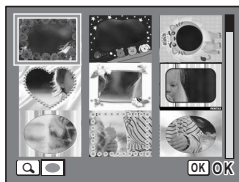

6 Press the zoom button towards the right (Q).

The selected frame appears in single-image display.

You can choose another frame using either of the following operations.

Four-way controller (◀▶)	Press to choose a different frame.
Zoom button towards the left (⊞)	Press to return to the 9-frame display of the frame selection screen, and then perform Step 5 to choose a different frame.

**7 Press the OK button.**

The frame position and size adjustment screen appears.

You can adjust the image using either of the following operations.

Four-way controller (▲▼◀▶)	Press to adjust the position of the image
Zoom button	Press to make the image larger or smaller.

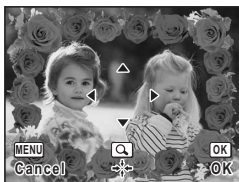
**8 Press the OK button.**

A confirmation dialog for overwriting the image appears.

If the selected image is protected, the processed image is saved as a new image and the following confirmation dialog does not appear.

9 Use the four-way controller (▲▼) to select [Overwrite] or [Save as].**10 Press the OK button.**

The edited image is saved with the recorded pixels of **3M** (2048×1536).

Optional Frames

The optional frames are stored in the built-in memory in the Optio WS80. These optional frames are deleted if the files on the built-in memory are deleted with a computer or the built-in memory is formatted. To reload the optional frames into the built-in memory, copy the files from the CD-ROM (S-SW87) supplied with the camera.

To Copy Frames

- 1 Remove the SD Memory Card from the camera.**
If you leave the SD Memory Card in the camera, the frames will be copied onto the card, not into the camera's built-in memory.
- 2 Connect the camera to the computer using the provided USB cable (I-USB7).**
Refer to "Connecting to a Computer" (p.211) for instructions on connecting the camera to a computer.
- 3 When the device detection window opens, click [Cancel].**
- 4 Insert the CD-ROM (S-SW87) into the CD-ROM drive.**
- 5 When the installer window opens, click [EXIT].**
- 6 If there is not already a "FRAME" folder in the root directory of the camera (removable disk), create the folder.**
- 7 Copy the desired files from the FRAME folder in the root directory of the CD-ROM to the FRAME folder on the camera (removable disk).**
For information on working with files on your computer, refer to the instruction manual supplied with the computer.
- 8 Disconnect the USB cable from the computer and camera.**
Refer to "Connecting to a Computer" (p.211) for instructions on disconnecting the cable.



Frames can be stored both in the built-in memory and on the SD Memory Cards, but using large numbers of frames may slow down processing times.

To Use a New Frame

The frames downloaded from the PENTAX website or other source can be used for adding a frame to pictures.



- Extract the downloaded frame and copy it to the FRAME folder in the built-in memory or the SD Memory Card.
- The FRAME folder is created when the SD Memory Card is formatted with this camera.
- For more information on downloading, refer to the PENTAX website.

Editing Movies

You can select a frame from the recorded movie to save as a still picture or divide a movie into two.

5

1 In mode, use the four-way controller (◀▶) to choose the movie you want to edit.

2 Press the four-way controller (▼).
The Playback Mode Palette appears.

3 Use the four-way controller (▲▼◀▶) to select (Movie Edit).



4 Press the OK button.
The movie edit selection screen appears. Subsequent steps vary depending on your selection.



To Save a Frame from a Movie as a Still Picture

5 Select [Save as Still Image] on the movie edit selection screen.

6 Press the OK button.

The screen appears for selecting a frame to be saved as a still picture.

7 Use the four-way controller (▲▼◀▶) to choose the frame you want to save.

- ▲ Plays or pauses the movie
- ▼ Stops the movie and returns to the first frame
- ◀ Reverses the movie frame by frame
- ▶ Advances the movie frame by frame

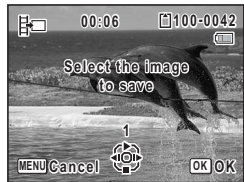

8 Press the OK button.

The selected frame is saved as a still picture.

To Divide a Movie

5 Select [Divide Movies] on the movie edit selection screen.

6 Press the OK button.

The screen for choosing the dividing position appears.

7 Use the four-way controller (▲▼◀▶) to determine the dividing position.

- ▲ Plays or pauses the movie
- ▼ Stops the movie and returns to the first frame
- ◀ Reverses the movie frame by frame
- ▶ Advances the movie frame by frame



8 Press the OK button.

A confirmation dialog appears.

- 9** Use the four-way controller (▲▼) to select [Divide].

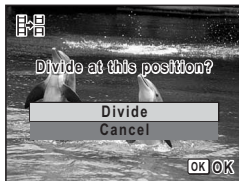

- 10** Press the OK button.

The movie is divided at the specified position, the two portions are saved as new files, and the original one is deleted.



The protected movies cannot be divided.

5

Copying Images and Sound Files

You can copy images and sound files from the built-in memory to the SD Memory Card and vice versa. This function can be selected only when an SD Memory Card has been inserted in the camera.



Make sure that the camera is turned off before inserting or removing the SD Memory Card.

- 1** Press the four-way controller (▼) in  mode.

The Playback Mode Palette appears.

- 2** Use the four-way controller (▲▼◀▶) to select  (Image/Sound Copy).



3 Press the OK button.

The copying method selection screen appears.
Subsequent steps vary depending on your selection.

To Copy Files from the Built-in Memory to the SD Memory Card

All the images and sound files in the built-in memory are copied to the SD Memory Card at once. Before copying the images, make sure that there is enough space on the SD Memory Card.

4 Use the four-way controller (▲▼) to select [→ SD].

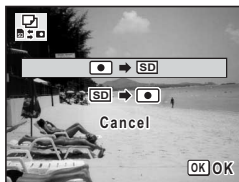

5 Press the OK button.

All the images and sound files are copied to the SD Memory Card.

To Copy Files from the SD Memory Card to the Built-in Memory

Selected images and sound files from the SD Memory Card are copied to the built-in memory one at a time.

4 Use the four-way controller (▲▼) to select [→].

5 Press the OK button.

6 Use the four-way controller (◀▶) to select the image/sound file you want to copy.



7

Press the OK button.

The selected image/sound file is copied to the built-in memory. To copy other images or sound files, repeat Steps 4 to 7. Select [Cancel] to exit the settings.



- If sound (voice memo) has been added to an image, the image is copied with the sound.
- When a file is copied from the SD Memory Card to the built-in memory, it is assigned a new file name.

Setting the Printing Service (DPOF)

DPOF (Digital Print Order Format) is the format for storing print order data on still pictures captured with a digital camera. Once the print order data has been stored, the pictures can be printed according to the DPOF settings using a DPOF-compatible printer or photo processing lab. You cannot store print order data for movies or sound-only files.



If the picture already has the date and/or time imprinted on it (p.123), do not set [Date] (On) in DPOF settings. If you select , the imprinted date and/or time may overlap.

Printing a Single Image

Set the following items for each image.

Copies	Choose the number of copies up to 99.
Date	Specify whether you want the date inserted on the print or not.

1 In mode, press the four-way controller (▼).

The Playback Mode Palette appears.

2 Use the four-way controller (▲▼◀▶) to select (DPOF).

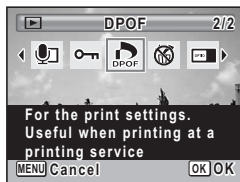

3 Press the OK button.

The DPOF setting method selection screen appears.

- 4 Use the four-way controller (▲▼) to select [Single Image].**

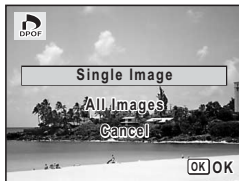

- 5 Press the OK button.**

The message [Applies DPOF settings to this image] appears.

- 6 Use the four-way controller (◀▶) to select an image.**

If DPOF settings have already been made for an image, the previous number of copies and date setting (☑ or ☐) will be displayed.

- 7 Use the four-way controller (▲▼) to choose the number of copies.**



- 8 Press the Green button to switch or for [Date] setting.**

- The date will be imprinted.
- The date will not be imprinted.

To continue setting DPOF print order data, repeat Steps 6 to 8.



- 9 Press the OK button.**

The setting is saved and the screen shown in Step 4 reappears.



Depending on the printer or printing equipment at the photo processing lab, the date may not be imprinted on the pictures even if ☑ (On) is selected for [Date] in the DPOF settings.



To cancel DPOF settings, set the number of copies to [00] in Step 7 and press the **OK** button.

Printing All Images

When you choose the number of copies and whether or not to insert the date, the settings are applied to all the images stored in the camera.

1 Select **[All Images]** in Step 4 on p.180.

2 Press the **OK** button.

The message [Applies DPOF settings to all images] appears.

3 Choose the number of copies and switch or for **[Date]** setting.

Refer to Steps 7 and 8 in “Printing a Single Image” (p.180) for details of how to make the settings.



4 Press the **OK** button.

The settings for all the images are saved and the DPOF setting method selection screen reappears.



- The number of copies specified in the [All Images] setting applies to all the images. Before printing, check that the number is correct.
- Settings for single images are canceled when settings are made with [All Images].

Memo

6 Recording and Playing Back Sound

Recording Sound (Voice Recording)	184
Adding a Voice Memo to Images	188





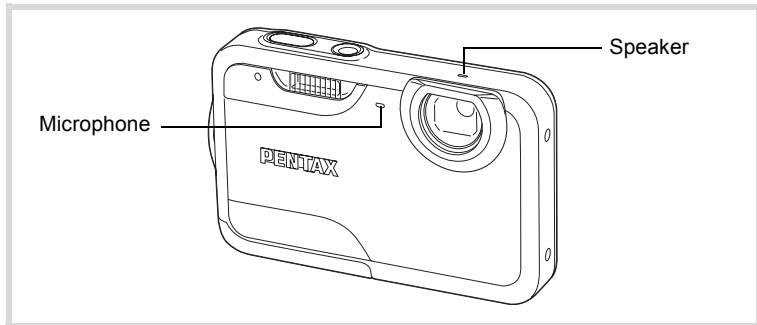

Recording Sound (Voice Recording)

You can record sound with the camera. The microphone is located on the front of the camera. When recording sound, aim the camera at the sound source to obtain the best sound quality.



Setting the Voice Recording Function

To use the Voice Recording function, assign it to the Green button first.

- 1 Press the MENU button in  mode.**
The [ Rec. Mode] menu appears.
- 2 Use the four-way controller ( ) to select [Green Button].**
- 3 Press the four-way controller () .**
A pull-down menu appears.
- 4 Use the four-way controller ( ) to select [Voice Recording] and press the OK button.**

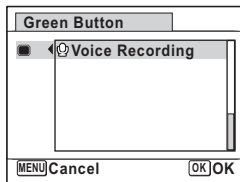

5 Press the MENU button.

The Voice Recording function is assigned to the Green button.

Recording Sound

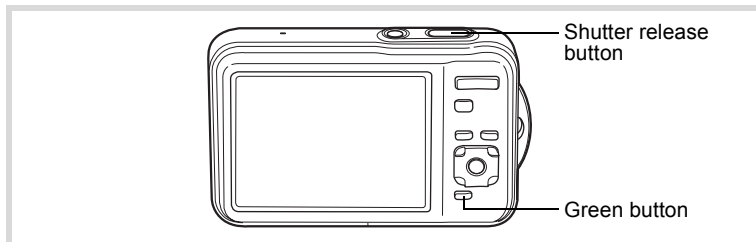

1 Press the Green button in mode.

The camera enters the Voice Recording mode. The remaining recordable time and the recording time of the current file appear on the display.

- 1 Recording time
- 2 Remaining recordable time



2 Press the shutter release button fully.

Recording starts. The self-timer lamp blinks during recording.

You can record sounds continuously for up to 24 hours.

When the Green button is pressed during recording, an index is added to the current sound file.



3 Press the shutter release button fully.

Recording stops.





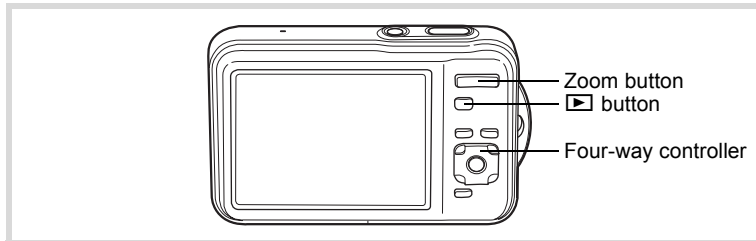

- If you press and hold down the shutter release button for more than one second in Step 2, recording continues until you take your finger off the button. This is useful for recording short sound.
- The sound is saved in WAVE monaural files.

Playing Back Sound

You can play back the sound files you made in Voice Recording.



- 1 Press the  button.**
- 2 Use the four-way controller ( ) to choose the sound file to play back.**
- 3 Press the four-way controller ().**

Playback starts.

- 1 Total file recording time
- 2 Playback time

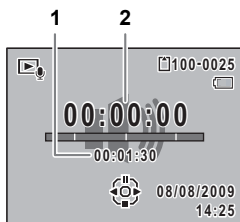

Available operations during playback

Zoom button towards the right (▲)	Increases the volume.
Zoom button towards the left (▼)	Reduces the volume.
Four-way controller (▲)	Pauses playback.
Four-way controller (▼)	(If there are no recorded indexes) Fast-reverses playback. (If there are recorded indexes) Plays back starting from the previous index.
Four-way controller (▶)	(If there are no recorded indexes) Fast-forwards playback. (If there are recorded indexes) Plays back starting from the next index.

Available operations while playback is paused

Four-way controller (▲)	Resumes playback.
Four-way controller (▼)	Rewinds approx. 5 seconds.
Four-way controller (▶)	Advances approx. 5 seconds.

4



Press the four-way controller (▼).

Playback stops.

Adding a Voice Memo to Images

You can add a voice memo to your still pictures.

Recording a Voice Memo

- 1** In  mode, use the four-way controller (◀▶) to choose the still picture to which you want to add a voice memo.
- 2** Press the four-way controller (▼).
The Playback Mode Palette appears.
- 3** Use the four-way controller (▲▼◀▶) to select  (Voice Memo).



- 4** Press the OK button.
Recording starts. You can record a voice memo continuously for up to 24 hours.



- 5** Press the OK button.
Recording stops.



- A voice memo cannot be added to the image that already has a voice memo. Delete the old voice memo (p.151) and record a new one.
- A voice memo cannot be added to protected images (p.156).

Playing Back a Voice Memo

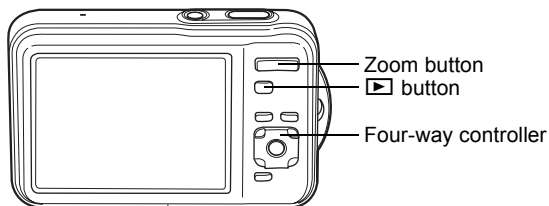

- 1** In ▶ mode, use the four-way controller (◀▶) to choose the still picture with the voice memo that you want to play back.

☐☐ appears on images with voice memos in single-image display.

- 2** Press the four-way controller (▲).

Playback starts.



Available operations during playback

Zoom button towards the right (▲)	Increases the volume.
Zoom button towards the left (▼)	Reduces the volume.

- 3** Press the four-way controller (▼).

Playback stops.

To Delete the Sound from an Image p.151

Memo

7 Settings

Camera Settings	192
Using the Clock Function	208

Formatting an SD Memory Card

Formatting deletes all the data on the SD Memory Card.



Be sure to use this camera to format (initialize) an SD Memory Card that is unused or has been used on other cameras or digital devices.

Caution

- Do not remove the SD Memory Card during formatting as this may damage the card and render it unusable.
- Formatting deletes protected images and any data recorded on the card with a computer or any camera.
- SD Memory Cards formatted on a computer or device other than this camera cannot be used. Be sure to format the card with the camera.
- The built-in memory cannot be formatted except when an error occurs.

1 Press the **MENU** button in mode.

The [ Setting] menu appears.

When you press the **MENU** button in  mode, press the four-way controller () once.

2 Use the four-way controller () to select [Format].

3 Press the four-way controller ()

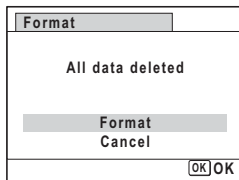

The [Format] screen appears.

4 Use the four-way controller () to select [Format].



5 Press the **OK** button.

Formatting starts.



When formatting is completed, the camera returns to  mode or  mode.

Changing the Sound Settings

You can adjust the volume of operation sounds and change the type of sound.

1 Press the **MENU** button in mode.

The [ Setting] menu appears.

When you press the **MENU** button in  mode, press the four-way controller () once.

2 Use the four-way controller () to select [Sound].

3 Press the four-way controller ()

The [Sound] screen appears.

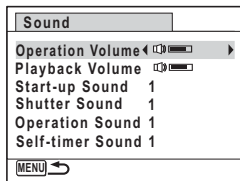

To Change the Operation Volume/Playback Volume

4 Use the four-way controller () to select [Operation Volume].

5 Use the four-way controller () to adjust the volume.

Set the volume to 0 to mute the start-up sound, shutter sound, operation sound, and self-timer sound.

6 Change [Playback Volume] in the same way as in Steps 4 and 5.

To Change the Sound Type

4 Use the four-way controller () to select [Start-up Sound].

5 Press the four-way controller ()

A pull-down menu appears.

6 Use the four-way controller (▲▼) to select the sound type.

Choose from [1], [2], [3] or [Off].

7 Press the OK button.

8 Set [Shutter Sound], [Operation Sound] and [Self-timer Sound] in the same way as in Steps 4 to 7.

9 Press the MENU button twice.

The camera returns to  mode or  mode.

Changing the Date and Time

You can change the initial date and time settings (p.52). You can also set the format in which the date appears on the camera.

1 Press the MENU button in mode.

The [ Setting] menu appears.

When you press the **MENU** button in  mode, press the four-way controller (▶) once.

2 Use the four-way controller (▲▼) to select [Date Adjustment].

3 Press the four-way controller (▶).

The [Date Adjustment] screen appears.

4 Press the four-way controller (▶).

The frame moves to [mm/dd/yy].

Depending on the initial setting or previous setting, [dd/mm/yy] or [yy/mm/dd] may be displayed.

Date Adjustment	
Date Format	▶mm/dd/yy 24h
Date	01/01/2009
Time	00:00
Settings complete	
[MENU]Cancel	

5 Use the four-way controller (▲▼) to choose the date and time display style.

Choose from [mm/dd/yy], [dd/mm/yy] or [yy/mm/dd].

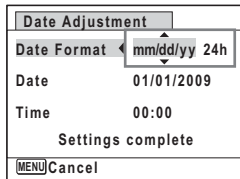

6 Press the four-way controller (▶).

The frame moves to [24h].

7 Use the four-way controller (▲▼) to select [24h] (24-hour display) or [12h] (12-hour display).

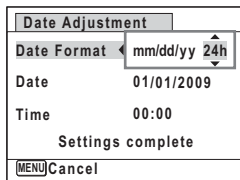

8 Press the four-way controller (▶).

The frame returns to [Date Format].

9 Press the four-way controller (▼).

The frame moves to [Date].

10 Press the four-way controller (▶).

The frame moves to one of the following items depending on the date format set in Step 5.

Month for [mm/dd/yy]

Day for [dd/mm/yy]

Year for [yy/mm/dd]

The following operations and screens use [mm/dd/yy] as an example. The operations are the same even if another date format has been selected.

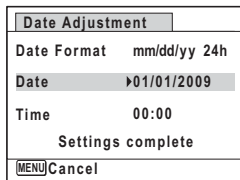

- 11 Use the four-way controller (▲▼) to change the month.**

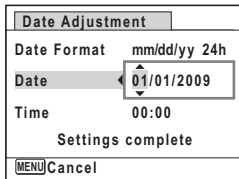

- 12 Press the four-way controller (▶).**

The frame moves to the day field. Use the four-way controller (▲▼) to change the day. After changing the day, change the year in the same manner.

- 13 Change the time in the same way as in Steps 8 to 12.**

If you selected [12h] in Step 7, the setting switches between am and pm corresponding to the time.

- 14 Press the four-way controller (▼) to select [Settings complete].**

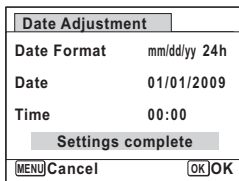

- 15 Press the OK button.**

The date and time settings are saved.



When you press the **OK** button in Step 15, the camera clock is reset to 00 seconds. To set the exact time, press the **OK** button when the time signal (on the TV, radio, etc.) reaches 00 seconds.

Setting the World Time

The date and time selected in “Setting the Date and Time” (p.52) and “Changing the Date and Time” (p.194) serve as the Hometown date and time. By using the world time function, you can display the time in a city other than the Hometown (→ Destination). This is useful when taking pictures in a different time zone.

To Set the Destination

1 Press the MENU button in mode.

The [ Setting] menu appears.

When you press the MENU button in  mode, press the four-way controller (▶) once.

2 Use the four-way controller (▲▼) to select [World Time].

3 Press the four-way controller (▶).

The [World Time] screen appears.

4 Use the four-way controller (▲▼) to select [→ Destination].

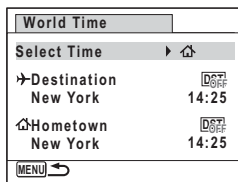

5 Press the four-way controller (▶).

The [→ Destination] screen appears. The city that is currently selected blinks on the map.

6 Use the four-way controller (◀▶) to change the Destination city.

The current time, location and time difference of the selected city appear.

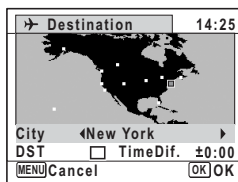

7 Use the four-way controller (▲▼) to select [DST].

8 Use the four-way controller (◀▶) to select or .
Select if the Destination city uses daylight saving time.

9 Press the OK button.
The settings are saved and the [World Time] screen reappears.

10 Press the MENU button twice.
The camera returns to capture status with the current setting.



Select [Hometown] in Step 4 to set the city and DST setting for the Hometown city.

To Display the Time of the Destination (Select Time)

1 Press the MENU button in mode.

The [Setting] menu appears.

When you press the MENU button in mode, press the four-way controller (▶) once.

2 Use the four-way controller (▲▼) to select [World Time].

3 Press the four-way controller (▶).

The [World Time] screen appears.

4 Use the four-way controller (▲▼) to select [Select Time].

World Time	
Select Time	▶
→ Destination	<input type="checkbox"/> DST London 20:25
Hometown	<input checked="" type="checkbox"/> DST New York 14:25
MENU	

5 Press the four-way controller (▶).

A pull-down menu appears.

6 Use the four-way controller (▲▼) to select ➔ or ⏪.

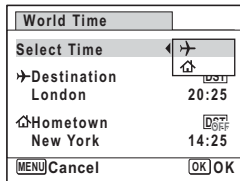

- ➔ Displays the time of the Destination city
- ⏪ Displays the time of the Hometown city



7 Press the OK button.

The setting is saved.

8 Press the MENU button twice.

The camera returns to  mode or  mode.

When ➔ (Destination) is selected in Step 6, the ➔ icon appears on the display to indicate that the destination date and time are displayed in  mode.





Changing the Display Language

You can change the language in which the menus, error messages, etc. are displayed.

The camera supports the following 20 languages: English, French, German, Spanish, Portuguese, Italian, Dutch, Japanese, Danish, Swedish, Finnish, Polish, Czech, Hungarian, Turkish, Greek, Russian, Thai, Korean and Chinese (traditional and simplified).

1 Press the MENU button in mode.

The [ Setting] menu appears.

When you press the **MENU** button in  mode, press the four-way controller (▶) once.

2 Use the four-way controller (▲▼) to select [Language/言語].

3 Press the four-way controller (▶).

The [Language/言語] screen appears.

4 Use the four-way controller (▲▼◀▶) to select the language.

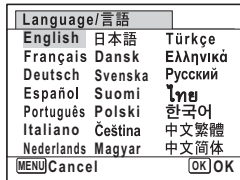

5 Press the OK button.

The menus and messages are displayed in the selected language.

Changing the Naming Rule of the Folder

You can change the naming rule of the folder for storing images. When the naming rule is set to the date, pictures are saved in separate folders by the date they were taken.

Standard	xxxPENTX (where xxx is the 3-digit folder number)
Date	xxx_mmdd (3-digit folder number_month day) * xxx_ddmm (3-digit folder number_day month) when the [Date Format] is set to [dd/mm/yy]







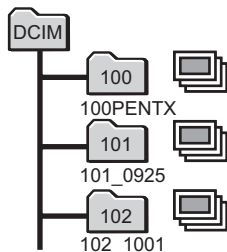
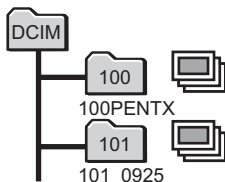
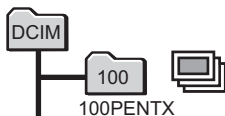

Taken with the folder name setting [Standard].
(e.g. September 25)

Taken with the folder name setting [Date].
(e.g. September 25)

Next time, taken with the folder name setting [Date] again.
(e.g. October 1)











- Up to 999 folders can be created.
- Up to 9999 images or sounds can be saved in a folder.

- 1 Press the MENU button in  mode.**
The [ Setting] menu appears.
When you press the **MENU** button in  mode, press the four-way controller () once.
- 2 Use the four-way controller ( ) to select [Folder Name].**
- 3 Press the four-way controller ().**
A pull-down menu appears.
- 4 Use the four-way controller ( ) to select [Standard] or [Date].**
- 5 Press the OK button.**
The setting is saved.

Changing the Video Output Format

When you connect the camera to AV equipment, choose the appropriate video output format (NTSC or PAL) for taking and playing back images.

- 1 Press the MENU button in  mode.**
The [ Setting] menu appears.
When you press the **MENU** button in  mode, press the four-way controller () once.
- 2 Use the four-way controller ( ) to select [Video Out].**
- 3 Press the four-way controller ().**
A pull-down menu appears.
- 4 Use the four-way controller ( ) to select a video output format.**
Choose the video output format to match the input format of the AV equipment.

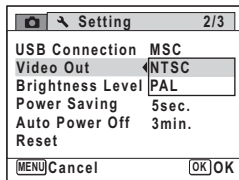

5 Press the OK button.

The setting is saved.



Depending on the country or region, images and sound files may fail to be played back if the video output format is set differently from the one in use there. If this happens, change the video output format setting.

Connecting the Camera to AV Equipment p.159

Video output format of each city p.245

Adjusting the Brightness of the Display

You can adjust the brightness of the display.

1 Press the MENU button in mode.

The [Setting] menu appears.

When you press the **MENU** button in mode, press the four-way controller () once.

2 Use the four-way controller () to select [Brightness Level].

3 Use the four-way controller () to adjust the brightness.

- Dark
- Normal
- Bright

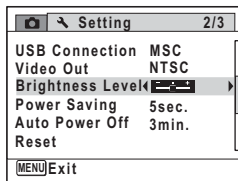

4 Press the MENU button.

The camera returns to mode or mode.



The display appears with the set brightness.

Using the Power Saving Function

You can save battery power by setting the display to dim automatically when no operation is performed for a fixed time. After the power saving function has been activated, the display returns to the ordinary brightness if any button is pressed.

1 Press the MENU button in mode.

The [ Setting] menu appears.

When you press the MENU button in  mode, press the four-way controller () once.

2 Use the four-way controller () to select [Power Saving].

3 Press the four-way controller ().

A pull-down menu appears.

4 Use the four-way controller () to select the time until the camera enters power saving mode.

Choose from [2min.], [1min.], [30sec.], [15sec.], [5sec.] or [Off].

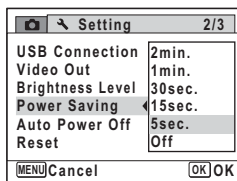

5 Press the OK button.

The setting is saved.





- Power Saving does not function in the following situations:
 - While taking pictures in  (Continuous Shooting) mode
 - In the playback mode
 - While recording a movie
 - While the camera is connected to a computer
 - When using the AC adapter
 - While a menu is being displayed
- When no operation is performed after the camera is turned on, Power Saving is activated only after 15 seconds elapse even if [5sec.] is set.

Setting Auto Power Off

You can set the camera to turn off automatically when no operation is performed for a fixed time.

1 Press the **MENU** button in mode.

The [ Setting] menu appears.

When you press the **MENU** button in  mode, press the four-way controller () once.

2 Use the four-way controller () to select [**Auto Power Off**].

3 Press the four-way controller ().

A pull-down menu appears.

4 Use the four-way controller () to select the time until the camera turns off automatically.

Choose from [5min.], [3min.] or [Off].

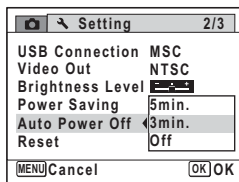

5 Press the **OK** button.

The setting is saved.



Auto Power Off does not function in the following situations:

- While recording sound in Voice Recording mode
- While taking pictures in  (Continuous Shooting) mode
- While recording a movie
- During a slideshow or movie/sound playback
- While the camera is connected to a computer

Changing the Start-up Screen

You can choose the start-up screen displayed when the camera is turned on.

You can choose any of the following images as the start-up screen:

- The Guide Display Start-up Screen showing a guide to the shooting modes and buttons
- One of the 3 Optio logos
- One of your own images (compatible images only)

1 In mode, press the four-way controller (▼).

The Playback Mode Palette appears.

2 Use the four-way controller (▲▼◀▶) to select (Start-up Screen).



3 Press the OK button.

The image selection screen appears.

4 Use the four-way controller (◀▶) to choose the image for the start-up screen.

Only images suitable for the start-up screen are displayed. You can also choose one of the 3 Optio logos or the Guide Display Start-up Screen already stored in the camera.



5 Press the OK button.

The start-up screen is set.





- Once the start-up screen has been set, it will not be deleted even if the original image is deleted or the SD Memory Card is formatted.
- Select [Off] to hide the start-up screen.
- The start-up screen is not displayed when the camera starts up in the playback mode.

Correcting Defective Pixels in the CCD Sensor (Pixel Mapping)

Pixel Mapping is a function for mapping out and correcting defective pixels in the CCD sensor. Run the Pixel Mapping function if image dots always seem to be defective in the same place.

1 Press the **MENU** button in mode, and press the four-way controller (▶).

The [ Setting] menu appears.

[Pixel Mapping] cannot be selected when the [ Setting] menu is displayed from  mode or Voice Recording mode.

2 Use the four-way controller (▲▼) to select [Pixel Mapping].

3 Press the four-way controller (▶).

The [Pixel Mapping] screen appears.

4 Use the four-way controller (▲▼) to select [Pixel Mapping].

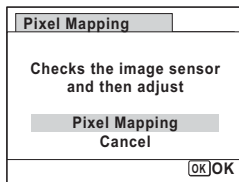

5 Press the **OK** button.

Defective pixels are mapped and corrected.





When the battery level is low, [Not enough battery power remaining to activate Pixel Mapping] is displayed on the monitor. Use the AC adapter kit K-AC88 (optional) or load a charged battery.

Resetting to Default Settings (Reset)

You can reset the camera settings to their defaults. Refer to “Default Settings” (p.240) for the reset settings.

1 Press the **MENU** button in mode.

The [ Setting] menu appears.

When you press the **MENU** button in  mode, press the four-way controller () once.

2 Use the four-way controller () to select [Reset].

3 Press the four-way controller (.

The [Reset] screen appears.

4 Use the four-way controller () to select [Reset].

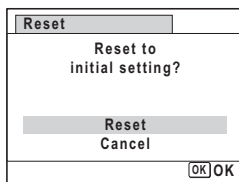

5 Press the **OK** button.

The settings return to the defaults.



The following settings are not affected by resetting:

- Date Adjustment
- World Time
- Language/ 言語
- Video Out

Using the Clock Function

Displaying the Time

You can view the time (Clock mode) on the display.

1 Make sure the power is turned off.

2 Press and hold the **OK** button.

The camera turns on and the Clock mode screen appears.

The camera turns off automatically after approximately 10 seconds. If you press the power switch while the Clock mode screen is displayed, the camera will turn off immediately.





Setting the Alarm

You can set the alarm to ring at a specified time. You can choose whether the alarm will ring only once at the set time or at the same time every day.

1 Press the **MENU** button in  mode.

The [ Setting] menu appears.

When you press the **MENU** button in  mode, press the four-way controller () once.

2 Use the four-way controller ( ) to select [**Alarm**].

3 Press the four-way controller (.

The [Alarm] screen appears.

4 Press the four-way controller (.

A pull-down menu appears.

5 Use the four-way controller (▲▼) to select [Off], [Once] or [Everyday].

Once The alarm rings only once, at the set time.

Everyday The alarm rings every day, at the set time.

To cancel the set alarm, select [Off].

6 Press the OK button.

7 Use the four-way controller (▲▼) to select [Time].

8 Press the four-way controller (▶).

9 Use the four-way controller (▲▼) to change the hour.

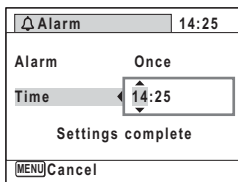

10 Change the minutes in the same way as in Steps 8 to 9.

11 Press the four-way controller (▶).

12 Press the four-way controller (▼) to select [Settings complete].

13 Press the OK button.

After the message [Alarm is set] appears, the camera turns off.

When the set time is reached, the camera turns on with the Clock mode screen displayed and the alarm will ring. The alarm will stop ringing when a button is pressed or after one minute elapses. The camera will turn off 10 seconds after the alarm is stopped.



- The alarm will not ring if the camera is on when the set time is reached.
- The alarm will not ring during interval shooting.

To Cancel an Alarm

You can cancel an alarm that is set.

- 1** Select [Off] in Step 5 on p.209.

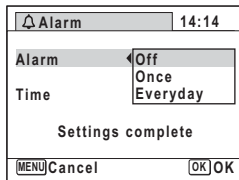

- 2** Press the **OK** button.
- 3** Press the four-way controller (▼) to select [Settings complete].
- 4** Press the **OK** button.
[Alarm] is set to (Off) and the [↖ Setting] menu reappears.
- 5** Press the **MENU** button.
The previous screen reappears.

8 Connecting to a Computer

Setting Up Your Computer	212
Connecting to a Windows PC	220
Connecting to a Macintosh	229

Setting Up Your Computer

By installing the software included on the provided CD-ROM on your computer and connecting the camera to your computer with the USB cable, you can transfer images and movies captured with your camera to the computer and then display and manage them. This section explains how to install the provided software and the other necessary preparations for enjoying the captured pictures and movies on your computer.

Provided Software

The following software is included in the provided CD-ROM (S-SW87).

Windows

- Image viewing/managing/editing software “ACDSee for PENTAX 3.0” (Nine languages: English, French, German, Spanish, Italian, Russian, Chinese [traditional and simplified], Korean, and Japanese)

Macintosh

- Image viewing/managing software “ACDSee 2 for Mac” (Six languages: English, French, German, Spanish, Italian, and Japanese)

 Caution

It is recommended to use the optional AC adapter kit K-AC88 when the camera is connected to a computer (p.40). If the battery runs out of power while images are being transmitted to a computer, the data may be lost or damaged.

System Requirements

The following system requirements must be met for you to fully enjoy the images and movies captured with the camera on your computer.

Windows

OS	Windows 2000, Windows XP or Windows Vista <ul style="list-style-type: none">The OS must be preinstalled and updated to the latest version.
CPU	Pentium III or higher (Pentium 4 or higher recommended)
Memory	256 MB minimum (1 GB or more recommended)
Hard Disk Space	100 MB minimum (1 GB or more recommended)
Others	CD-ROM drive USB port as standard equipment Internet Explorer 5.0 or later DirectX 9.0 or later and Windows Media Player 9.0 or later (for playing movies)

- * Operation is not guaranteed on all computers meeting the system requirements.
- * The system requirements describe the minimum environment for playing and editing movies.



Windows 95, Windows 98, Windows 98SE, Windows Me and Windows NT are not supported.



The versions of Internet Explorer, Windows Media Player and DirectX required for using “ACDSee for PENTAX 3.0” are not included in the provided CD-ROM. Visit the following sites to download the necessary items and install/update them on your computer.

- **Internet Explorer**
<http://www.microsoft.com/windows/products/winfamily/ie/default.msp>
- **Windows Media Player**
<http://www.microsoft.com/windows/products/winfamily/mediaplayer/default.msp>
- **DirectX**
<http://www.microsoft.com/windows/directx/default.msp>

Macintosh

OS	Mac OS X (Ver.10.3 - 10.5) <ul style="list-style-type: none">• The OS must be preinstalled and updated to the latest version.• When you connect the camera to a Macintosh without using the provided software, Mac OS X (Ver.10.1.2 - 10.5) is available.
CPU	Power Macintosh 233 MHz or higher (PowerPC G5 or higher recommended)
Memory	8 MB minimum (1 GB or more recommended)
Hard Disk Space	6 MB minimum (1 GB or more recommended)
Others	CD-ROM drive USB port as standard equipment QuickTime 4.0 or later

- * Operation is not guaranteed on all computers meeting the system requirements.
- * The system requirements describe the minimum environment for playing and editing movies.

Installing the Software

Windows

Install the image viewing/managing/editing software (ACDSee for PENTAX 3.0).



- Make sure your Windows PC meets the system requirements before installing the software.
- When multiple accounts have been set up in Windows 2000, Windows XP or Windows Vista, log on with an account that has administrative rights before installing the software.

1

Turn your Windows PC on.

2

Insert the CD-ROM (S-SW87) into the CD-ROM drive.

The language selection screen appears.

If you are using Windows Vista

When the [AutoPlay] screen appears, display the language selection screen following the steps below.

- 1) Click [Run setup.exe].
- 2) Click [Allow].

If the language selection screen does not appear

Display the language selection screen following the steps below.

- 1) Double-click [My Computer] on the desktop.
- 2) Double-click the [CD-ROM drive (S-SW87)] icon.
- 3) Double-click the [Setup.exe] icon.

3 Choose a language from the displayed screen.

The “ACDSee for PENTAX 3.0” installation screen appears.



4 Click [Install].

The setup screen appears. Follow the on-screen guidance to input registration information and install the software.



5**Click [Finish].**

“ACDSee for PENTAX 3.0” installation is complete.

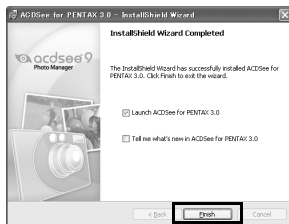
**6****Click [Exit] on the installation screen.**

The window closes.

Macintosh

Install the image viewing/managing software (ACDSee 2 for Mac).

1**Turn your Macintosh on.****2****Insert the CD-ROM (S-SW87) into the CD-ROM drive.****3****Double-click the CD-ROM (S-SW87) icon.****4****Double-click the [ACDSee Install] icon.**

The language selection screen appears.

If the [Master Installer] icon appears, double-click it to display the language selection screen.

5**Choose a language from the displayed screen.**

The “ACDSee 2 for Mac” installer screen appears.



8

6 Click [Install].

The setup screen appears. Follow the on-screen guidance to input registration information and install the software.



7 When the screen shown on the right appears, click [Yes].

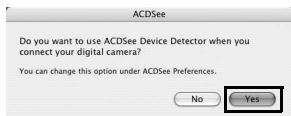

8 Click [Close].

“ACDSee 2 for Mac” installation is complete.



9 Click [Exit] on the installation screen.

The window closes.

Product Registration on the Internet

In order to better serve you, we request that you complete the product registration.

If your computer is connected to the Internet, please click [Product Registration] on the setup screen after the language selection screen is displayed. The world map screen shown on the right for Internet Product Registration is displayed. Click the displayed country or region and then follow the instructions to register your product.

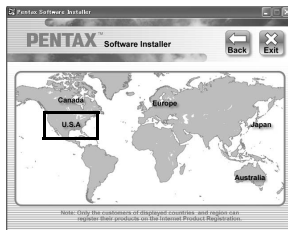

Only customers in countries and regions displayed on the software installation screen can register their products on the Internet Product Registration.

Setting the USB Connection Mode

Set the device to which the camera is connected with the USB cable.



Make sure to set the USB connection mode before connecting your camera to the computer. You cannot perform the following setting if the camera is already connected to your computer with the USB cable.

8



1

Turn your camera on.

2

Press the MENU button in  mode.

The [ Setting] menu appears.

When you press the **MENU** button in  mode, press the four-way controller () once.

3

Use the four-way controller ( ) to select [USB Connection].

4

Press the four-way controller ().

A pull-down menu appears.

- 5 Use the four-way controller (▲▼) to select [MSC].**

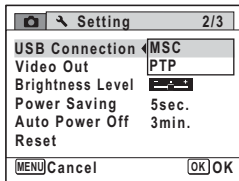

- 6 Press the OK button.**

The setting is saved.

- 7 Press the MENU button.**

The camera returns to mode or mode.

Proceed to the following pages depending on your computer.

Connecting to a Windows PC p.220

Connecting to a Macintosh p.229

MSC and PTP

MSC (Mass Storage Class)

A general-purpose driver program that handles devices connected to the computer via USB as a memory device. Also indicates a standard for controlling USB devices with this driver.

By simply connecting a device that supports USB Mass Storage Class, you can copy, read, and write files from a computer without installing a dedicated driver.

PTP (Picture Transfer Protocol)

A protocol that allows transfer of digital images and control of digital cameras via USB, standardized as ISO 15740.

You can transfer image data between devices that support PTP without installing a device driver.

Unless otherwise specified, select MSC when connecting the Optio WS80 to your computer.

Connecting to a Windows PC

Connecting the Camera and Your Windows PC

Connect your camera to the Windows PC using the provided USB cable (I-USB7).

- 1 Turn your Windows PC on.**
- 2 Turn your camera off.**
- 3 Connect your camera to the Windows PC using the USB cable.**

Connect the terminal of the USB cable with the arrow mark ← facing the front side of the camera.

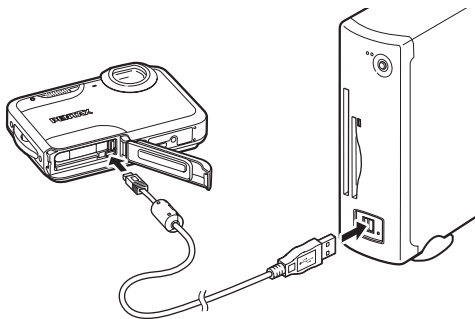

- 4 Turn your camera on.**

The "Device Detector" screen appears.

If the "Device Detector" screen does not appear, follow the steps in "When the "Device Detector" screen does not appear" (p.222).



The self-timer lamp blinks while the camera is connected to a Windows PC.

Transferring Images

Transfer the images captured with the camera to your Windows PC.



If there is no SD Memory Card in the camera, the images stored in the built-in memory will be transferred to your Windows PC.

- 5** Confirm that [Acquire images from the device with ACDSee] is checked and click [OK].



- 6** Click [Next].



- 7** Select an image to copy and click [Next].

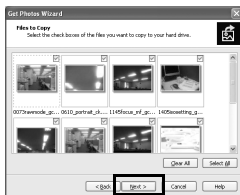

- 8** Specify [File names] and [Destination folder], and click [Next].

The images are copied to your Windows PC.

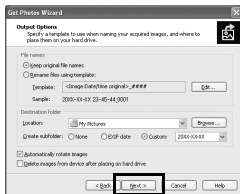

9**Click [Finish].**

The “ACDSee for PENTAX 3.0” starts.



When the “Device Detector” screen does not appear

5

Double-click the [ACDSee for PENTAX 3.0] icon on the desktop.

**6**

Click [My Computer].

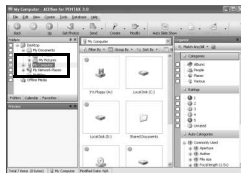
**7**

Double-click [Removable Disk].

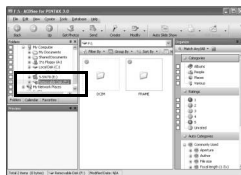
**8**

Connecting to a Computer



If the SD Memory Card has a volume label, the volume label name appears instead of [Removable Disk]. A new unformatted SD Memory Card may show the manufacturer's name or model number.

8 Double-click the [DCIM] folder.

Images are stored in folders named by the shooting date (“XXX_0808” for August 8. “XXX” is a three-digit number.).

If [Standard] is selected for [Folder Name] in the [↖ Setting] menu, a folder named “XXXPENTX” (XXX is a three-digit folder number) is displayed and images are stored here.

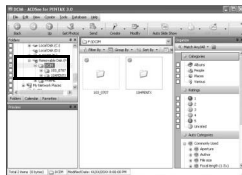

9 Select the folders you want to copy to the Windows PC.

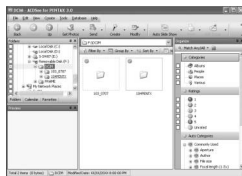

10 Select [Copy To Folder...] from the [Edit] menu.

The “Copy Files” screen appears.

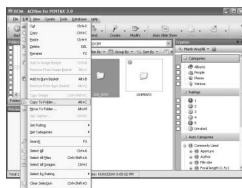

11 Specify the destination folder and click [OK].

The images are copied to your Windows PC.

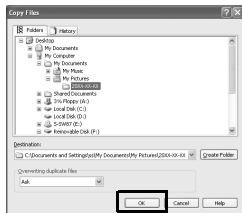

Disconnecting the Camera from Your Windows PC

- 1 Double-click the  [Safely Remove Hardware] icon in the task bar.**



The “Safely Remove Hardware” screen appears.

- 2 Select [USB Mass Storage Device] and click [Stop].**

The “Stop a Hardware device” screen appears.



- 3 Select [USB Mass Storage Device] and click [OK].**

A message appears indicating that the hardware can be safely removed.

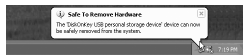
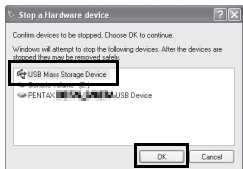

- 4 Click [Close].**



- 5 Disconnect the USB cable from your Windows PC and the camera.**



- If the camera (removable disk) is being used by an application such as “ACDSee for PENTAX 3.0”, the camera cannot be disconnected until the application is closed.
- The camera will automatically switch to the playback mode when the USB cable is disconnected from your Windows PC or the camera.

Starting “ACDSee for PENTAX 3.0”

“ACDSee for PENTAX 3.0” lets you view, edit, manage, search for, share, and print images.

1 Double-click the [ACDSee for PENTAX 3.0] icon on the desktop.

ACDSee starts and the main browser window appears.

ACDSee Browser Interface

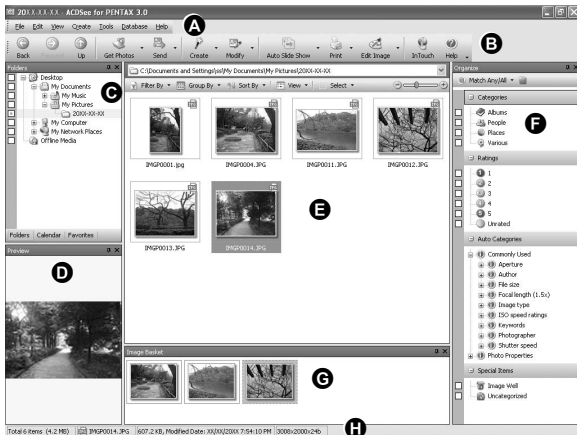

* The screen shown is an example with the default settings.

A Menu bar

Provides access to the various menu commands.

B Toolbar

Provides quick access to frequently used tasks and functions.

C Folders pane

Displays the configuration of folders in your computer. When you browse a folder, the contents of the folder appear in the File List pane.

D Preview pane

Displays a preview of the image or media file currently selected in the File List pane. You can change the size of the preview image or play back the media file.

E File List pane

Displays the contents of the selected folder or the results of the most recent search (the file or folder that matches the search item). It is the only pane that always appears in the browser and it cannot be hidden or closed.

F Category pane

Displays a list of categories and priorities. By dragging and dropping files from the File List pane to here, you can set category and priority for files.

G Image Basket pane

Displays files selected in the File List pane. By choosing images and files and putting them in the Image Basket pane, you can use the editing and creating functions on images from different folders and categories.

H Status bar

Displays information and properties for the selected file.

Viewing Images

- 1 Select and click the folder containing the image you want to view in the Folders pane of the ACDSee browser.**

Images are displayed in the File List pane.

- 2 Select and double-click the image you want to view in the File List pane.**

The selected image is displayed with the viewer.

With the viewer, you can enlarge/reduce the display size of the image or edit the image. You can also play back movies or sound files.

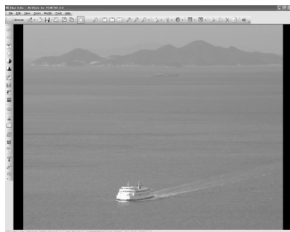

ACDSee Quick View

The image is displayed on the “ACDSee Quick View” screen if you double-click the image file directly from the browser without starting ACDSee. (You cannot play back or display the file with ACDSee Quick View even if you double-click a movie or sound file.)

You can also enlarge/reduce the display size of the image on the “ACDSee Quick View” screen.

Click [Full Viewer] on the “ACDSee Quick View” screen to switch the display to the viewer.

Click [Photo Manager] to switch the display to the ACDSee browser.



Details on How to Use “ACDSee for PENTAX 3.0”

You can find more information on how to use “ACDSee for PENTAX 3.0” by using the help pages.

1 Click the [?] icon at the top right of the screen.

The help screen appears.

2 Double-click the desired topic.

The explanation is displayed.

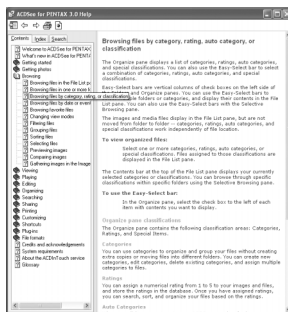

Connecting to a Macintosh

Connecting the Camera and Your Macintosh

Connect your camera to the Macintosh using the provided USB cable (I-USB7).

- 1 Turn your Macintosh on.**
- 2 Turn your camera off.**
- 3 Connect your camera to the Macintosh using the USB cable.**

Connect the terminal of the USB cable with the arrow mark  facing the front side of the camera.

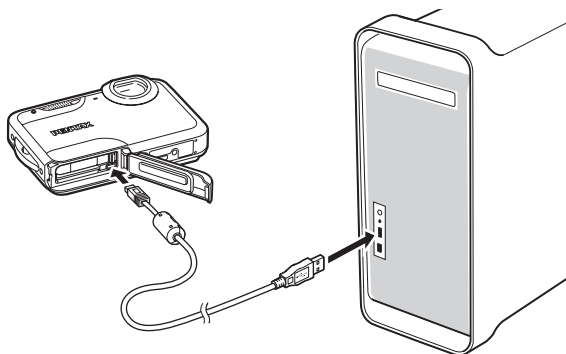

- 4 Turn your camera on.**

The camera is recognized as [NO_NAME] on the desktop.



- If the SD Memory Card has a volume label, the volume label name appears instead of [NO_NAME]. A new unformatted SD Memory Card may show the manufacturer's name or model number.
- The self-timer lamp blinks while the camera is connected to a Macintosh.

Transferring Images

Transfer the images captured with the camera to your Macintosh.



If there is no SD Memory Card in the camera, the images stored in the built-in memory will be transferred to your Macintosh.

5

Specify a save location, make sure that [Launch ACDSee] is checked, and click [Download].

After images are copied to your Macintosh, the “ACDSee 2 for Mac” starts.

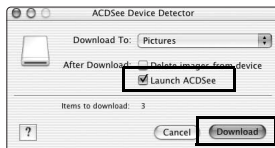

When [Delete images from device] is checked, images are deleted from the camera after transfer is complete.

Disconnecting the Camera from Your Macintosh

1

Drag [NO_NAME] on the desktop to the trash.

If the SD Memory Card has a volume label, drag the icon of that name to the trash.

2

Disconnect the USB cable from your Macintosh and the camera.



- If the camera (removable disk) is being used by an application such as “ACDSee 2 for Mac”, the camera cannot be disconnected until the application is closed.
- The camera will automatically switch to the playback mode when the USB cable is disconnected from your Macintosh or the camera.

Starting “ACDSee 2 for Mac”

“ACDSee 2 for Mac” lets you display and manage images.

1 Double-click the [ACDSee] folder inside the [Applications] folder.

2 Double-click the [ACDSee 2 for Mac] icon.
ACDSee starts and the main browser window appears.

ACDSee Browser Interface



A Menu bar

Provides access to the various menu commands.

B Toolbar

Provides quick access to frequently used tasks and functions.

C Folders pane

Displays the configuration of folders in your Macintosh. When you browse a folder, the contents of the folder appear in the File List pane.

D Preview pane

Displays a preview of the image or media file currently selected in the File List pane. You can change the size of the preview image or play back the media file.

E Favorites pane

You can add frequently used items (folders, etc.).

F File List pane

Displays the contents of the selected folder or the results of the most recent search (the file or folder that matches the search item). It is the only pane that always appears in the browser and it cannot be hidden or closed.

G Status bar

Displays information and properties for the selected file.

Viewing Images

- 1 Select and click the folder containing the image you want to view in the Folders pane of the ACDSee browser.**

Images are displayed in the File List pane.

- 2 Select and double-click the image you want to view in the File List pane.**

The selected image is displayed.
You can enlarge/reduce the display size of the image.



Details on How to Use “ACDSee 2 for Mac”

You can find more information on how to use “ACDSee 2 for Mac” by using the help pages.

- 1 Select [ACDSee 2 for Mac] from [Help] on the menu bar.**

The help screen appears.

- 2 Click the desired topic.**

The explanation is displayed.

9 Appendix

Functions Available for Each Shooting Mode	234
Messages	236
Troubleshooting	238
Default Settings	240
List of World Time Cities	245
Optional Accessories	246
Main Specifications	247
WARRANTY POLICY	251
Index	256

Functions Available for Each Shooting Mode

✓: Can be set. ×: Cannot be set.

Function		Shooting Mode						
		AUTO PICT	P	📷	📺	📽	📹	📸
Zoom button	Zoom operation	✓	✓	✓*1	✓	✓*1	✓*1	✓
📷 button	Face Priority On	✓	✓	✓	✓	✓	✓	✓
	Smile Capture	✓	✓	✓	✓	✓	✓	✓
	Face Priority Off	×	✓	✓	✓	✓	✓	✓
Flash Mode	📷 (Auto)	✓	✓	✓	×	×	×	✓
	📷 (Flash Off)	✓	✓	✓	✓	✓*3	✓*3	✓
	📷 (Flash On)	✓	✓	×	✓	×	×	✓
	📷 (Auto + Red-eye)	✓	✓	×	×	×	×	✓
	📷 (Flash On + Red-eye)	✓	✓	×	✓	×	×	✓
	📷 (Soft Flash)	✓	✓	×	✓	×	×	✓
Drive Mode	📷 (Standard)	✓	✓	✓	✓	✓	✓	✓
	📷 (Self-timer)	✓	✓	✓	✓	✓	✓	✓
	📷 (2 sec. Self-timer)	✓	✓	✓	✓	✓	✓	✓
	📷 (Continuous Shooting)	×	✓	×	×	×	×	✓
	📷 (Burst Shooting)	×	✓	×	×	×	×	✓
Focus Mode	📷 (Interval Shoot)	×	✓	✓	✓	✓	✓	✓
	AF (Standard)	✓	✓	✓	✓	✓	✓	✓
	📷 (Macro)	✓	✓	✓	✓	✓	✓	✓
	PF (Pan Focus)	✓	✓	✓	✓	✓	✓	✓
	📷 (Infinity)	✓	✓	✓	✓	✓	✓	✓
[📷 Rec. Mode] menu	MF (Manual Focus)	✓	✓	✓	✓	✓	✓	✓
	Pixel Track SR/Movie SR	✓	✓	×	✓	✓*6	✓*6	✓
	Recorded Pixels	✓	✓	×	✓	✓*6	✓*6	✓
	White Balance	×	✓	×	✓	✓	×	×
	Focusing Area	×	✓	×	✓	✓*13	✓*13	✓
	AE Metering	×	✓	×	✓	×	×	×
	Sensitivity	✓	✓	×	✓	×	×	✓
	EV Compensation	×	✓	×	✓	✓	✓	✓
	D-Range Setting	×	✓	×	✓	✓	✓	✓
	Blink Detection	✓	✓	×	✓	✓	✓	✓
	Sharpness	✓	✓	×	✓	✓	✓	✓
	Saturation	×	✓	×	✓	✓	×	×
	Contrast	×	✓	×	✓	✓	×	×
Date Imprint	✓	✓	×	✓	×	×	✓	

*1 Intelligent Zoom is not available

*2 Only optical zoom is available

*3 Fixed at 📷

*4 Fixed at 📷

*5 Fixed at 📷

*6 Set in [Movie] on the [📷 Rec. mode] menu

*7 Fixed at **10M**

*8 Fixed at **3M**

*9 Fixed at **5M**

*10 Fixed at **5M** (Fixed at **3M** for the first frame)

Shooting menu items not listed in this chart can be set in any shooting mode except for Green Mode. However, these settings may not function properly in certain shooting modes and setting conditions even if they can be selected. For further information, please refer to the pages listed below.

				WIDE			Shooting Mode		Page
							Function		
✓	✓*2	✓	✓	x	✓	✓	Zoom operation	Zoom button	p.82
✓	✓	✓	✓	✓	✓	✓	Face Priority On	☺ button	p.76
							Smile Capture		
x	✓	x	✓	✓	✓	✓	Face Priority Off		
✓	✓	✓	x	✓	✓	✓	⚡ (Auto)	Flash Mode	p.105
✓	✓	✓	✓*3	✓	✓	✓	☀ (Flash Off)		
✓	✓	✓	x	✓	✓	✓	⚡ (Flash On)		
✓	✓	✓	x	✓	✓	✓	☀ (Auto + Red-eye)		
✓	✓	✓	x	✓	✓	✓	☀ (Flash On + Red-eye)		
✓	✓	✓	x	✓	✓	✓	SOFT (Soft Flash)		
✓	✓	✓	✓	✓	✓	✓	□ (Standard)		
✓	✓	✓	✓	✓	✓	✓	⌚ (Self-timer)		
							⌚ (2 sec. Self-timer)		
✓	✓	✓	x	x	x	x	📷 (Continuous Shooting)	p.96	
✓	✓	✓	x	x	x	✓	📷 (Burst Shooting)		
							📷 (Interval Shoot)	p.98	
✓	✓	✓	x	✓	✓	✓	AF (Standard)	Focus Mode	p.107
							📷 (Macro)		
✓	✓	✓	✓*4	✓	✓	✓	PF (Pan Focus)		
✓	✓	✓	x	✓	✓	✓	MF (Manual Focus)		
✓	✓	x*5	x*5	x*5	x*5	x*5	Pixel Track SR/Movie SR	[📷 Rec. Mode] menu	p.119
✓	x*9	x*8	✓	x*10	x	x*8	Recorded Pixels		p.110
x*11	✓	x*11	x*11	✓	✓	✓	White Balance		p.114
✓	✓	✓	x*12	✓	✓	✓	Focusing Area		p.109
x*14	✓	x*14	x*14	✓	✓	✓	AE Metering		p.116
✓	x*15	✓	x*16	✓	✓	✓	Sensitivity		p.117
✓	✓	✓	✓	✓	✓	✓	EV Compensation		p.112
✓	✓	✓	✓	✓	✓	✓	D-Range Setting		p.113
✓	✓	✓	✓	x	x	✓	Blink Detection		p.73
							Sharpness		p.121
x	✓	x	x	✓	✓	✓	Saturation		p.122
							Contrast		p.122
✓	✓	✓	✓	✓	✓	✓	Date Imprint		p.123

*11 Fixed at **AWB**

*12 Fixed at [] (Multiple)

*13 (Automatic Tracking AF) is not available

*14 Fixed at (Multi-segment)

*15 Fixed at Auto

*16 The sensitivity is fixed at its minimum setting

*17 Fixed at ±0.0

*18 Fixed at

*19 Fixed at the normal setting

*20 Fixed at Off

Messages









Messages such as the following may appear on the display during camera operation.

Message	Description
Battery depleted	The battery is exhausted. Charge the battery using the battery charger (p.35).
Memory card full	The SD Memory Card is full and no more images can be saved. Insert a new SD Memory Card or delete unwanted images (p.42, p.150). Change the number of recorded pixels or quality level of recorded images and try again (p.162).
Memory card error	Shooting and playback are impossible due to a problem with the SD Memory Card. You may be able to display or copy the images on the card using a computer.
The built-in memory is not formatted	The data within the built-in memory are damaged. Format the built-in memory.
Card is not formatted	The SD Memory Card you have inserted is unformatted or has been formatted on a computer or other device and is not compatible with this camera. Format the SD Memory Card in the camera (p.192).
Card is locked	The SD Memory Card is write-protected (p.44).
Compression error	This message occurs when the camera fails to compress an image. Change the number of recorded pixels of the image and try shooting or saving it again.
No image/sound	There are no image/sound files on the SD Memory Card.
Movie recording stopped	This message appears when the internal temperature of the camera has exceeded normal operating limits while recording a movie.
The camera will turn off to prevent damage from overheating	The camera turned off because it has overheated. Wait until it cools down and then turn it back on.
Deleting	This message appears while deleting an image or sound file.
Camera cannot play this image and sound	You are trying to play back an image or sound in a format not supported by this camera. You may be able to play it back on another brand of camera or on your computer.
Image folder cannot be created	The largest file number (9999) has been assigned to an image in the largest folder number (999) and no more images can be saved. Insert a new SD Memory Card or format the card (p.192).

Message	Description
Protected	The image or sound file you are trying to delete is protected (p.156).
Data being recorded	Displayed when you try to switch to  mode while an image is still being recorded, or when the protect setting or DPOF setting is being changed. It disappears after the image is recorded or the setting is changed.
Data being processed	Displayed when the camera takes more than five seconds to display an image due to image processing, or when the SD Memory Card or the built-in memory is being formatted.
Built-in memory full	Displayed if the built-in memory is full when saving a file.
No image to be processed	Displayed when there are no images or sound files.
This image/sound cannot be processed	Displayed for files that cannot be processed.
No card in the camera	Displayed when no SD Memory Card is inserted.
The built-in memory is not enough to copy images/sounds	Displayed when there is insufficient built-in memory to perform copying.
Cannot process correctly	Displayed when Red-eye Compensation processing fails.
Display image/sound from built-in memory	Displayed when the camera enters the built-in memory display.
Not enough battery power remaining to activate Pixel Mapping	Appears during pixel mapping if the battery level is insufficient. Replace the battery with a fully charged one or use an AC adaptor kit K-AC88 (optional). (p.40)

Troubleshooting

Problem	Cause	Remedy
The camera will not turn on	The battery is not installed	Check if a battery is installed. If not, install a battery.
	The battery is installed incorrectly	Check orientation of the battery. Reinsert the battery according to the ⊕ ⊖ symbols in the battery compartment (p.36).
	The battery is exhausted	Charge the battery.
No image appears on the display	The camera is connected to a computer	The display is off when the camera is connected to a computer.
	The camera is connected to a TV	The display is off when the camera is connected to a TV.
The display is hard to see	The brightness level of the display is set too dark	Adjust the brightness level in [Brightness Level] in the [Setting] menu (p.202).
	Power Saving function is on	When the Power Saving function is on, the display automatically darkens after a certain amount of time. Press a button to return to the normal brightness level. Select [Off] in [Power Saving] in the [Setting] menu to turn the Power Saving function off (p.203).
The shutter will not release	The flash is charging	Pictures cannot be taken while the flash is charging. Wait until charging is finished.
	There is no available space on the SD Memory Card or in the built-in memory	Insert an SD Memory Card with available space or delete unwanted images (p.42, p.150).
	Recording	Wait until recording is finished.
The picture is dark when using the flash	The subject is too far away in a dark environment, such as a night scene	The picture becomes dark if the subject is too far away. Take pictures within the specified flash range.

Problem	Cause	Remedy
The subject is not in focus	The subject is difficult to focus on with autofocus	The camera may have difficulty in focusing on such subjects as: low contrast subjects (a white wall, a blue sky, etc.), dark subjects, finely-patterned objects, rapidly-moving objects. It is also difficult to get proper focus when shooting through a window or a net. Try shooting using the focus lock (p.72), or Manual Focus (p.108).
	The subject is not in the focusing area	Locate the desired subject in the focus frame (focusing area) in the center of the display. If it is difficult to do so, first lock the focus on the desired subject (focus lock), and then move the camera to recompose.
The flash does not discharge	The flash mode is set to 	Set to  (Auto) or  (Flash On) (p.105).
	The drive mode is set to  or  The focus mode is set to  The shooting mode is set to  ,  or 	The flash does not discharge in these modes.



Very occasionally, static electricity may cause camera malfunction. In this case, remove the battery and install it again. If the camera is then working properly, normal condition is restored and you can continue using the camera.

Default Settings

The table below lists the factory default settings.

The meaning of the indications for menu items with a default setting is explained below.

Last Memory Setting

Yes : The current setting (last memory) is saved when the camera is turned off.

No : The setting returns to the default setting when the camera is turned off.

* : The setting depends on the [Memory] setting (p.133).

— : N/A

Reset Setting



Yes : The setting returns to the default setting with the Reset function (p.207).

No : The setting is saved even after reset.



— : N/A

● [📷 Rec. Mode] Menu Items

Item	Default Setting	Last Memory Setting	Reset Setting	Page	
Pixel Track SR	<input type="checkbox"/> (Off)	Yes	Yes	p.119	
Recorded Pixels	10M (3648×2736)	Yes	Yes	p.110	
White Balance	AWB (Auto)	*	Yes	p.114	
Focusing Area	[] (Multiple)	Yes	Yes	p.109	
AE Metering	(Multi-segment)	*	Yes	p.116	
Sensitivity	Auto	*	Yes	p.117	
EV Compensation	±0.0	*	Yes	p.112	
Movie	Recorded Pixels	1280 (1280×720/30 fps)	Yes	Yes	p.128
	Movie SR	<input checked="" type="checkbox"/> (On)	Yes	Yes	p.129
	Interval Shoot	Interval	1 min.	Yes	p.130
		Total Time	10 min.	Yes	
Start Delay		0 hr. 0 min.	Yes		
D-Range Setting	Highlight Correction	<input type="checkbox"/> (Off)	Yes	p.113	
	Shadow Correction	<input type="checkbox"/> (Off)	Yes		

Item		Default Setting	Last Memory Setting	Reset Setting	Page
Interval Shoot	Interval	10 sec.	Yes	Yes	p.98
	Number of Shots	2 pictures	Yes	Yes	
	Start Delay	0 hr. 0 min.	Yes	Yes	
Blink Detection		<input checked="" type="checkbox"/> (On)	Yes	Yes	p.118
Digital Zoom		<input checked="" type="checkbox"/> (On)	*	Yes	p.83
Instant Review		<input checked="" type="checkbox"/> (On)	Yes	Yes	p.120
Memory	Face Priority	<input type="checkbox"/> (Off)	Yes	Yes	p.76
	Flash Mode	<input checked="" type="checkbox"/> (On)	Yes	Yes	p.105
	Drive Mode	<input type="checkbox"/> (Off)	Yes	Yes	p.95 p.96 p.98
	Focus Mode	<input type="checkbox"/> (Off)	Yes	Yes	p.107
	Zoom Position	<input type="checkbox"/> (Off)	Yes	Yes	p.82
	MF Position	<input type="checkbox"/> (Off)	Yes	Yes	p.108
	White Balance	<input type="checkbox"/> (Off)	Yes	Yes	p.114
	Sensitivity	<input type="checkbox"/> (Off)	Yes	Yes	p.117
	EV Compensation	<input type="checkbox"/> (Off)	Yes	Yes	p.112
	AE Metering	<input type="checkbox"/> (Off)	Yes	Yes	p.116
	Digital Zoom	<input checked="" type="checkbox"/> (On)	Yes	Yes	p.83
	DISPLAY	<input type="checkbox"/> (Off)	Yes	Yes	p.23
File No.	<input checked="" type="checkbox"/> (On)	Yes	Yes	—	
Green Button		Green Mode	Yes	Yes	p.124
Sharpness		 (Normal)	Yes	Yes	p.121
Saturation		 (Normal)	Yes	Yes	p.122
Contrast		 (Normal)	Yes	Yes	p.122
Date Imprint		Off	Yes	Yes	p.123













● [ Setting] Menu Items

Item		Default Setting	Last Memory Setting	Reset Setting	Page
Sound	Operation Volume	3	Yes	Yes	p.193
	Playback Volume	3	Yes	Yes	
	Start-up Sound	1	Yes	Yes	
	Shutter Sound	1	Yes	Yes	
	Operation Sound	1	Yes	Yes	
	Self-timer Sound	1	Yes	Yes	
Date Adjustment	Date Format (date)	According to initial setting	Yes	No	p.52 p.194
	Date Format (time)	24h	Yes	No	
	Date	1/1/2009	Yes	No	
	Time	According to initial setting	Yes	No	
Alarm	Alarm	<input type="checkbox"/> (Off)	Yes	Yes	p.208
	Time	0:00	Yes	Yes	
World Time	Select Time	 Hometown	Yes	Yes	p.197
	Destination (City)	According to initial setting	Yes	No	
	Destination (DST)	<input type="checkbox"/> (Off)	Yes	No	
	Hometown (City)	According to initial setting	Yes	No	
	Hometown (DST)	<input type="checkbox"/> (Off)	Yes	No	
Language/言語		According to initial setting	Yes	No	p.48 p.199
Folder Name		Date	Yes	Yes	p.200
USB Connection		MSC	Yes	Yes	p.218
Video Out		According to initial setting	Yes	No	p.201
Brightness Level			Yes	Yes	p.202
Power Saving		5 sec.	Yes	Yes	p.203
Auto Power Off		3 min.	Yes	Yes	p.204
Reset		Cancel	—	—	p.207
Delete All		Cancel	—	—	p.154
Pixel Mapping		Cancel	—	—	p.206
Format		Cancel	—	—	p.192

● Playback Mode Palette Items

Item		Default Setting	Last Memory Setting	Reset Setting	Page
Small Face Filter		Approx. 7%	No	Yes	p.164
Slideshow	Interval	3 sec.	Yes	Yes	p.143
	Screen Effect	Wipe	Yes	Yes	
	Sound Effect	<input checked="" type="checkbox"/> (On)	Yes	Yes	
Resize	Recorded Pixels	Depending on the picture taken	—	—	p.162
Cropping		Depending on the picture taken	—	—	p.163
Image/Sound Copy		Built-in memory → SD Memory Card	—	—	p.176
Image Rotation		Normal	—	—	p.145
Digital Filter		B&W	No	—	p.166
Movie Edit	Save as Still Image	—	—	—	p.174
	Divide Movies	—	—	—	
Frame Composite		Default1	Yes	Yes	p.171
Red-eye Compensation		—	—	—	p.170
Voice Memo		—	—	—	p.188
Protect	Single Image/ Sound	Depending on the recorded image/sound	—	—	p.156
	All Images/Sounds	Depending on the recorded image/sound	—	—	
DPOF	Single Image	Copies: 0	—	—	p.179
	All Images	Date: <input type="checkbox"/> (Off)	—	—	
Image Recovery		Cancel	—	—	p.155
Start-up Screen		Off	Yes	Yes	p.205

● Key Operation

Item	Function	Default Setting	Last Memory Setting	Reset Setting	Page
 button	Operation Mode	 mode	—	—	—
Zoom button	Zoom Position	Full wide-angle	*	No	p.82
Four-way controller	 Drive Mode	 (Standard)	*	Yes	p.95 p.96 p.98
	 Shooting Mode	 (Auto Picture)	Yes	Yes	p.73
	 Flash Mode	 (Auto)	*	Yes	p.105
	 Focus Mode	AF (Standard)	*	Yes	p.107
MENU button	Menu Display	Capture mode:  [Rec. Mode] menu Playback mode:  [Setting] menu	—	—	p.61
OK/DISPLAY button	Information Display	Normal	*	Yes	p.23
 button	Operation Mode	Face Priority On	*	Yes	p.76

List of World Time Cities

City: indicates cities that can be set as either the Initial Setting (p.48) or the World Time (p.197).
Video Output Format: indicates the video output format of the city set as the initial setting.

Region	City	Video Output Format	Region	City	Video Output Format
North America	Honolulu	NTSC	Africa/ West Asia	Istanbul	PAL
	Anchorage	NTSC		Cairo	PAL
	Vancouver	NTSC		Jerusalem	PAL
	San Francisco	NTSC		Nairobi	PAL
	Los Angeles	NTSC		Jeddah	PAL
	Calgary	NTSC		Tehran	PAL
	Denver	NTSC		Dubai	PAL
	Chicago	NTSC		Karachi	PAL
	Miami	NTSC		Kabul	PAL
	Toronto	NTSC		Male	PAL
	New York	NTSC		Delhi	PAL
Halifax	NTSC	Colombo		PAL	
Central and South America	Mexico City	NTSC		Kathmandu	PAL
	Lima	NTSC		Dacca	PAL
	Santiago	NTSC	East Asia	Yangon	NTSC
	Caracas	NTSC		Bangkok	PAL
	Buenos Aires	PAL		Kuala Lumpur	PAL
	Sao Paulo	PAL		Vientiane	PAL
Rio de Janeiro	NTSC	Singapore		PAL	
Europe	Lisbon	PAL		Phnom Penh	PAL
	Madrid	PAL		Ho Chi Minh	PAL
	London	PAL		Jakarta	PAL
	Paris	PAL		Hong Kong	PAL
	Amsterdam	PAL		Beijing	PAL
	Milan	PAL		Shanghai	PAL
	Rome	PAL		Manila	NTSC
	Copenhagen	PAL		Taipei	NTSC
	Berlin	PAL		Seoul	NTSC
	Prague	PAL	Tokyo	NTSC	
	Stockholm	PAL	Guam	NTSC	
	Budapest	PAL	Oceania	Perth	PAL
	Warsaw	PAL		Adelaide	PAL
	Athens	PAL		Sydney	PAL
	Helsinki	PAL		Noumea	PAL
Moscow	PAL	Wellington		PAL	
Africa/ West Asia	Dakar	PAL		Auckland	PAL
	Algiers	PAL		Pago Pago	NTSC
	Johannesburg	PAL			

Optional Accessories

A number of dedicated accessories are available for this camera. Products marked with an asterisk (*) are the same as those supplied with the camera.

- **Power supply**

- Rechargeable lithium-ion battery D-LI88 (*)**

- Battery charger kit K-BC88 (*)**

- (Battery charger D-BC88, AC plug cord)

- AC adapter kit K-AC88**

- (AC adapter D-AC64, DC coupler D-DC88, AC plug cord)

- The battery charger and AC plug cord are only sold as a set.

- **Cable**

- USB cable I-USB7 (*)**

- AV cable I-AVC7 (*)**

- **Strap**

- O-ST51 (*)**

- O-ST8** Silver chain strap

- O-ST24** Genuine leather strap

- O-ST81** Waterproof strap

- **Camera case**

- O-CC72**

- O-CC79**

- O-CC81**

Main Specifications

Type	Fully automatic compact digital still camera with built-in zoom lens	
Number of Effective Pixels	Approx. 10.0 megapixels	
Image Sensor	1/2.3 inch CCD	
Number of Recorded Pixels	Still	$\overline{10M}$ / $\overline{10M}$ (3648×2736), $\overline{7M}$ (3072×2304) $\overline{5M}$ (2592×1944), $\overline{3M}$ (2048×1536) $\overline{2.1M}$ (16:9) (1920×1080), $\overline{1024}$ (1024×768) $\overline{640}$ (640×480)
		<ul style="list-style-type: none"> * Fixed at $\overline{5M}$ in Digital Wide mode, however, the first frame uses $\overline{3M}$. * Fixed at $\overline{5M}$ in Digital SR mode. * Fixed at $\overline{3M}$ in Half-length Portrait mode. * Fixed at $\overline{2M}$ for one frame in Digital Panorama mode. * Fixed at $\overline{3M}$ in Frame Composite mode. * Fixed at $\overline{5M}$ when the sensitivity is set to 3200 or 6400. * Fixed at $\overline{5M}$ in Burst Shooting mode.
	Movie	$\overline{1280}$ (1280×720/30 fps), $\overline{1280}$ (1280×720/15 fps) $\overline{640}$ (640×480/30 fps), $\overline{640}$ (640×480/15 fps) $\overline{320}$ (320×240/30 fps), $\overline{320}$ (320×240/15 fps) (recorded pixels/frame rate)
Sensitivity (Standard Output Sensitivity)	Auto (ISO 64, 100, 200, 400, 800) Manual (ISO 64, 100, 200, 400, 800, 1600, 3200, 6400)	* The sensitivity is fixed at Auto (ISO 64 - 6400) in Digital SR mode.
File Format	Still	JPEG (Exif 2.2), DCF 2.0, DPOF, PRINT Image Matching III
	Movie	AVI (Motion JPEG), approx. 30fps/15fps, PCM system, monaural sound, Movie SR (Movie Shake Reduction)
	Sound	Voice memo, Voice recording: WAV (PCM) system, monaural
Storage Media	Built-in memory (approx. 33.6 MB), SD Memory Card, SDHC Memory Card	

Approximate Image Storage Capacity and Recording Time

Still Pictures

	Built-in Memory	512 MB SD Memory Card
10M 3648×2736	8 pictures	120 pictures
10M 3648×2736	17 pictures	239 pictures
7M 3072×2304	21 pictures	299 pictures
5M 2592×1944	26 pictures	368 pictures
3M 2048×1536	42 pictures	592 pictures
2.1M 1920×1080	61 pictures	863 pictures
1024 1024×768	126 pictures	1777 pictures
640 640×480	239 pictures	3358 pictures

- The image storage capacity is for reference only. The actual image storage capacity may vary depending on the SD Memory Card and the subject.

Movie/Sound

	Built-in Memory	512 MB SD Memory Card
1280i (1280×720/30 fps)	10 sec.	2 min. 32 sec.
1280i (1280×720/15 fps)	21 sec.	5 min. 5 sec.
640i (640×480/30 fps)	32 sec.	7 min. 31 sec.
640i (640×480/15 fps)	1 min. 3 sec.	14 min. 48 sec.
320i (320×240/30 fps)	51 sec.	11 min. 59 sec.
320i (320×240/15 fps)	1 min. 37 sec.	22 min. 53 sec.
Sound	26 min. 38 sec.	6 hr. 14 min. 15 sec.

- The above figures are based on our standard shooting conditions and may vary depending on the subject, shooting conditions and type of the SD Memory Card used.
- Recording can continue until the built-in memory or the SD Memory Card is full, or the size of the recorded movie reaches 2 GB (when using an SDHC card). If recording stops at 2 GB, start recording again to continue to record the rest of the movie in blocks of 2 GB.

White Balance	Auto, Daylight, Shade, Tungsten Light, Fluorescent Light, Manual	
Lens	Focal Length	6.2 mm - 31 mm (approx. 35 mm - 175 mm in 35 mm equivalent focal length)
	Aperture	F3.8 (W) - F4.7 (T)
	Lens Composition	10 elements in 8 groups (4 aspherical elements)
	Zoom Type	Electrically driven
Optical Zoom	5×	
Intelligent Zoom	Approx. 5.9× at 7M (3072×2304), Approx. 28.5× at 640 (640×480) (when combined with optical zoom)	

Digital Zoom	Up to approx. 5.7× (combines with 5× optical zoom to give zoom magnification equivalent to approx. 28.5×)	
Motion Blur Reduction	Still	Pixel Track SR, Hi-sensitivity shake reduction mode (Digital SR)
	Movie	Movie shake reduction (Movie SR)
Display	2.7 inch LCD, approx. 230,000 dots	
Playback Modes	Single-frame, 4-frame, 9-frame, Enlargement (max. 10×, scrollable), Face Close-up Playback, Folder Display, Calendar Display, Sound Playback, Histogram Display, Deleting Selected Images, Small Face Filter, Slideshow, Resize, Cropping, Image&Sound Copy, Image Rotation, Digital Filter, Movie Playback/Edit (Save as still images, Divide a movie), Frame Composite, Red-eye Compensation, Voice Memo, Protect, DPOF, Image Recovery, Start-up Image Setting	
Focus Modes	Autofocus, Macro, Pan Focus, Infinity, Manual Focus	
Focus	Type	TTL contrast detection system by sensor 9-point autofocus (multiple/spot/automatic tracking AF changeable)
	Focus range (From lens face)	Standard : 0.4 m - ∞ (whole zoom area) Macro : 0.1 m - 0.5 m (from wide to the middle zoom position)
		* It is possible to switch to Pan Focus, Infinity and Manual Focus. * Face Recognition AF is available only while the camera recognizes the subject's face.
	Focus Lock	By half-pressing the shutter release button
Exposure Control	Metering System	Multi-segment metering, Center-weighted metering, Spot metering
	Exposure Compensation	±2 EV (can be set in 1/3 EV steps)
Face Priority	Recognition of up to 32 people's faces (up to 31 face recognition frames on the display, or up to 30 frames in Half-length Portrait mode), Smile Capture, Blink Detection * Face Recognition AE is available only while the camera recognizes the subject's face.	
Shooting Modes	Auto Picture, Program, Night Scene, Movie, Underwater, Underwater Movie, Landscape, Flower, Portrait, Digital Wide, Surf & Snow, Digital SR, Kids, Pet, Half-length Portrait, Sport, Fireworks, Candlelight, Night Scene Portrait, Natural Skin Tone, Food, Digital Panorama, Frame Composite, Party, Green	
Digital Filters	B&W, Sepia, Toy Camera, Retro (Blue, Amber), Color (Red, Pink, Purple, Blue, Green, Yellow), Color extraction (Red, Green, Blue), Color enhancer (Sky Blue, Fresh Green, Delicate Pink, Autumn Leaves), Soft, Brightness	
Movie	Continuous Recording Time	Approx. 1 second - until built-in memory or SD Memory Card is full (however, maximum size is limited to 2 GB)
Shutter Speed	1/1500 sec. - 1/4 sec., max. 4 sec. (Night Scene mode)	

Built-in Flash	Modes	Auto, Flash Off, Flash On, Auto + Red-eye, Flash On + Red-eye, Soft Flash
	Flash Range	Wide-angle: approx. 0.4 m - 3.4 m (approx. 1.31 ft - 11.15 ft) (Sensitivity: in Auto condition) Telephoto: approx. 0.4 m - 2.8 m (approx. 1.31 ft - 9.19 ft) (Sensitivity: in Auto condition)
Drive Modes	Single-frame, Self-timer (approx. 10 sec., approx. 2 sec.), Continuous, Burst Shooting, Interval Shoot	
Self-timer	Electronic control type, control time: Approx. 10 sec., 2 sec.	
Time Function	World Time	75 cities (28 time zones)
	Clock Mode	Press and hold the OK/DISPLAY button when the camera is turned off to display the time (approximately 10 seconds).
	Alarm	At the specified time, the Clock mode screen is displayed and the alarm rings.
Power Source	Rechargeable lithium-ion battery D-LI88, AC adapter kit (optional)	
Battery Life	Number of Recordable Images approx. 200 pictures	* Recording capacity shows approximate number of shots recorded during CIPA-compliant testing (with display on, flash used for 50% of the shots, and 23 degrees centigrade). Actual performance may vary according to operating conditions.
	Playback Time approx. 240 min.	* According to the result of in-house testing. Actual time may differ depending on usage conditions.
	Movie Recording Time approx. 70 min.	
	Sound Recording Time approx. 270 min.	
Interfaces	USB 2.0 (high-speed compatible) /PC/AV terminal	
Video Output	NTSC/PAL (monaural)	
Waterproof and Dustproof Function	Comply with JIS waterproof grade 8 and JIS dustproof grade 6 (IP68) Continuous underwater picture-taking possible for 2 hours at depth of 1.5 m.	
Dimensions	Approx. 91.5 (W) × 59.5 (H) × 22 (D) mm (excluding operating or protruding parts)	
Weight	Approx. 105 g (excluding battery and SD Memory Card) Approx. 125 g (including battery and SD Memory Card)	
Accessories	Rechargeable lithium-ion battery, battery charger, AC plug cord, USB cable, AV cable, software (CD-ROM), strap, Operating Manual, Quick Guide	

WARRANTY POLICY

All PENTAX cameras purchased through authorized bona fide photographic distribution channels are guaranteed against defects of material or workmanship for a period of twelve months from date of purchase. Service will be rendered, and defective parts will be replaced without cost to you within that period, provided the equipment does not show evidence of impact, sand or liquid damage, mishandling, tampering, battery or chemical corrosion, operation contrary to operating instructions, or modification by an unauthorized repair shop. The manufacturer or its authorized representatives shall not be liable for any repair or alterations except those made with its written consent and shall not be liable for damages from delay or loss of use or from other indirect or consequential damages of any kind, whether caused by defective material or workmanship or otherwise; and it is expressly agreed that the liability of the manufacturer or its representatives under all guarantees or warranties, whether expressed or implied, is strictly limited to the replacement of parts as hereinbefore provided. No refunds will be made on repairs by non-authorized PENTAX service facilities.

Procedure During 12-month Warranty Period

Any PENTAX which proves defective during the 12-month warranty period should be returned to the dealer from whom you purchased the equipment or to the manufacturer. If there is no representative of the manufacturer in your country, send the equipment to the manufacturer, with postage prepaid. In this case, it will take a considerable length of time before the equipment can be returned to you owing to the complicated customs procedures required. If the equipment is covered by warranty, repairs will be made and parts replaced free of charge, and the equipment will be returned to you upon completion of servicing. If the equipment is not covered by warranty, regular charges of the manufacturer or of its representatives will apply. Shipping charges are to be borne by the owner. If your PENTAX was purchased outside of the country where you wish to have it serviced during the warranty period, regular handling and servicing fees may be charged by the manufacturer's representatives in that country. Notwithstanding this, your PENTAX returned to the manufacturer will be serviced free of charge according to this procedure and warranty policy. In any case, however, shipping charges and customs clearance fees to be borne by the sender. To prove the date of your purchase when required, please keep the receipt or bills covering the purchase of your equipment for at least a year. Before sending your equipment for servicing, please make sure that you are sending it to the manufacturer's authorized representatives or their approved repair shops, unless you are sending it directly to the manufacturer. Always obtain a quotation for the service charge, and only after you accept the quoted service charge, instruct the service station to proceed with the servicing.

- This warranty policy does not affect the customer's statutory rights.
- The local warranty policies available from PENTAX distributors in some countries can supersede this warranty policy. Therefore, we recommend that you review the warranty card supplied with your product at the time of purchase, or contact the PENTAX distributor in your country for more information and to receive a copy of the warranty policy.



The CE Mark is a Directive conformity mark of the European Union.

For customers in USA

STATEMENT OF FCC COMPLIANCE

This device complies with Part 15 of the FCC Rules. Operation is subject to the following two conditions: (1) This device may not cause harmful interference, and (2) this device must accept any interference received, including interference that may cause undesired operation.

Changes or modifications not approved by the party responsible for compliance could void the user's authority to operate the equipment. This equipment has been tested and found to comply with the limits for a Class B digital device, pursuant to part 15 of the FCC Rules. These limits are designed to provide reasonable protection against harmful interference in a residential installation. This equipment generates, uses and can radiate radio frequency energy and, if not installed and used in accordance with the instructions, may cause harmful interference to radio communications. However, there is no guarantee that interference will not occur in a particular installation. If this equipment does cause harmful interference to radio or television reception, which can be determined by turning the equipment off and on, the user is encouraged to try to correct the interference by one or more of the following measures:

- Reorient or relocate the receiving antenna.
Increase the separation between the equipment and receiver.
Connect the equipment into an outlet on a circuit different from that to which the receiver is connected.
- * Consult the dealer or an experienced radio/TV technician for help.

For customers in Canada

This Class B digital apparatus complies with Canadian ICES-003.

Pour les utilisateurs au Canada

Cet appareil numérique de la classe B est conforme à la norme NMB-003 du Canada.

FOR CALIFORNIA, U.S.A. ONLY

Perchlorate Material-special handling may apply. The lithium battery used in this camera contains perchlorate material, which may require special handling. See www.dtsc.ca.gov/hazardouswaste/perchlorate

Declaration of Conformity

According to 47CFR, Parts 2 and 15 for
Class B Personal Computers and Peripherals

We: PENTAX Imaging Company
A Division of PENTAX of America, Inc.

Located at: 600 12th Street, Suite 300
Golden, Colorado 80401 U.S.A.
Phone: 303-799-8000 FAX: 303-790-1131

Declare under sole responsibility that the product identified herein complies with 47CFR Parts 2 and 15 of the FCC rules as a Class B digital device. Each product marketed is identical to the representative unit tested and found to be compliant with the standards. Records maintained continue to reflect the equipment being produced can be expected to be within the variation accepted, due to quantity production and testing on the statistical basis as required by 47CFR §2.909. Operation is subject to the following two conditions: (1) This device may not cause harmful interference, and (2) This device must accept any interference received, including interference that may cause undesired operation. The above named party is responsible for ensuring that the equipment complies with the standards of 47CFR §15.101 to §15.109.

Product Name: PENTAX Digital Still Camera

Model Number: Optio WS80

Contact person: Customer Service Manager

Date and Place: August, 2009, Colorado

Information for Users on Collection and Disposal of Old Equipment and Used Batteries



1. In the European Union

These symbols on the products, packaging and/or accompanying documents mean that used electrical and electronic equipments and batteries should not be mixed with general household waste.

Used electrical/electronic equipments and batteries must be treated separately and in accordance with legislation that requires proper treatment, recovery and recycling of these products.

Following the implementation by member states, private households within the EU states may return their used electrical/electronic equipments and batteries to designated collection facilities free of charge*.

In some countries your local retailer may also take back your old product free of charge if you purchase a similar new one.

*Please contact your local authority for further details.



By disposing of this product correctly you will help ensure that the waste undergoes the necessary treatment, recovery and recycling and thus prevent potential negative effects on the environment and human health which could otherwise arise due to inappropriate waste handling.

2. In other countries outside the EU

These symbols are only valid in the European Union. If you wish to discard these items, please contact your local authorities or dealer and ask for the correct method of disposal.











































Cd

For Switzerland: Used electrical/electronic equipment can be returned free of charge to the dealer, even when you don't purchase a new product. Further collection facilities are listed on the home page of www.swico.ch or www.sens.ch.



Note for the battery symbol (bottom two symbol examples): This symbol might be used in combination with a designation for the chemical element or compound in use. In this case you have to comply with the requirement set by the Directive for the chemicals involved.

Symbols

 Mode	14, 60
 Mode	14, 60
 button	56, 58
 button	57, 59
[ Rec. Mode]	
menu	65, 240
[ Setting] menu	66, 242
 Green Mode	80
 Delete	136, 150
 Tele	82
 Wide	82
 Magnify	146
 Four-/Nine-image	
display	138
 Self-timer	95
 Continuous Shooting	96
 Burst Shooting	96
 Interval Shoot	98
 Auto Picture	78
 Program	79
 Night Scene	86
 Movie	126
 Underwater	84
 Underwater Movie	84
 Landscape	74
 Flower	74
 Portrait	88
 Digital Wide	100
 Surf & Snow	91
 Digital SR	86
 Kids	89
 Pet	90
 Half-length Portrait	88
 Sport	91
 Fireworks	86

 Candlelight	86
 Night Scene Portrait	86
 Natural Skin Tone	88
 Food	75
 Digital Panorama	102
 Frame Composite	93
 Party	92

A









AC adapter	40
ACDSee	212
Adding sound	
(Voice Memo)	188
AE Metering	116
Alarm	208
Auto + Red-eye 	105
Auto AWB	114
Auto Picture Mode	78
Auto Power Off	204
Auto 	105
Automatic Tracking	
AF	76, 109
AV cable	159
AV equipment	159

B

B&W filter	166
Basic mode	80
Battery level indicator	39
Blink Detection	73, 118
Brightness filter	166
Brightness Level	202
Built-in memory	176
Built-in memory display	60
Burst Shooting 	96

C

Calendar display	139
------------------------	-----

Camera shake	119, 129	D-Range Setting	113
Candlelight Mode	86	Drive Mode	95, 96, 98
Capture Mode Palette	73	Dustproof	6, 84
Center-weighted metering 	116	E	
Charging a battery	35	Editing movies	174
Checking the SD Memory		Error messages	236
Card	46	Exposure setting	112
City name	245	F	
Clock Mode	208	Face close-up playback ...	148
Color enhancer filter	166	Face Recognition	76
Color extraction filter	166	File number	133
Color filter	166	Filters	166
Connecting to a TV	159	Fireworks Mode	86
Continuous Shooting 	96	Flash Mode	105
Contrast	122	Flash Off 	105
Copy	176	Flash On + Red-eye 	105
Cropping	163	Flash On 	105
D		Flower Mode	74
Date and time setting	52, 194	Fluores. Light 	114
Date Imprint	123	Focus Mode	107
Daylight 	114	Focusing	107
Daylight saving time	51, 198	Focusing Area	109
Default setting	240	Folder display	139
Delete 	136, 150	Folder name	200
Delete all	154	Food Mode	75
Delete sounds (voice memo)	151	Format	192
Destination	197	Four-image display 	138
Digital Filter	166	Four-way controller	57, 59
Digital SR	86	Frame Composite	93, 171
Digital Wide Mode	100	Frame rate	128
Digital Zoom	82, 83	G	
Display brightness	202	Green Button	57, 59, 124
Display language	48, 199	Green Mode	80
Dividing movies	175	Guide indications	30
DPOF settings	179	H	
		Half-length Portrait Mode	88

Highlight Correction	113
Histogram	30
Hometown	51, 197

I

Image Recovery	155
Image Storage Capacity	248
Infinity ▲	107
Info Display	26
Initial setting	48
Installing a battery	36
Installing the software	214
Instant Review	73, 120
Intelligent Zoom	82
Interval Movie	130
Interval Shoot 	98





K

Kids Mode	89
-----------------	----

L

Landscape Mode	74
Language setting	48, 199

M

Macintosh	214
Macro 	107
Magnify 	146
Manual Focus MF	107
Manual 	114
Mass Storage Class	219
Memory	133
MENU button	56, 58
Movie	126
Movie SR (Movie Shake Reduction) Function	129
MSC	219
Multi-segment metering 	116

N









Natural Skin Tone Mode	88
Night Scene Mode	86
Night Scene Portrait Mode	86
Nine-image display 	138
NTSC	201
Number of pixels	110

O

OK/DISPLAY button ...	57, 59
Opening screen	205
Operating the menus	61
Optional accessory	246

P

PAL	201
Pan Focus PF	107
Panoramic pictures	102
Party Mode	92
Pet Mode	90
Photo processing lab	179
Picture Transfer Protocol	219
Pixel Mapping	206
Pixel Track SR	119
Playback	136, 137, 186, 189
Playback Mode	140, 243
Palette	140, 243
Playing back movies	137
Playing back sounds	186
Portrait Mode	88
Power Saving	203
Power switch	46, 47, 56, 58
Press fully (shutter release button)	72
Press halfway (shutter release button)	72
Product registration	218

Program Mode	79	Smile Capture	76
Protect 	156	Soft filter	166
Provided software	212	Soft Flash ^{SOFT} 	105
PTP	219	Sound settings	193
R		Sound types	193
Rec. Mode menu	65, 240	Specifications	247
Recorded Pixels	110, 128	Sport Mode	91
Recording movies	126	Spot AE metering 	116
Recording sounds	184	Standard AF	107
Recovering images	155	Starting-up in the playback mode	47
Red-eye Compensation ...	170	Start-up screen	205
Red-eye reduction   ...	105	Strap	34
Registering menu items ...	124	Surf & Snow Mode	91
Reset	207	System requirements	213
Resize	162	T	
Retro filter	166	Time imprint	123
Rotating	145	Toy Camera filter	166
S		Tungsten Light 	114
Saturation	122	TV	159
Saving as still picture (movie)	175	U	
Saving pictures by date ...	200	Underwater mode	84
Saving settings	133	Underwater Movie mode ...	84
Screen effect	144	Underwater shooting	84
SD Memory Card	42	USB Connection	218
Select Time	198	V	
Self-timer 	95	Video output format	201, 245
Sensitivity	117	Voice Memo	188
Sepia filter	166	Voice Recording	184
Setting menu	66, 242	Volume change	137, 187, 193
Shade 	114	W	
Shadow Correction	113	Waterproof	6, 84
Sharpness	121	White Balance	114
Shooting information	24	Windows	213
Shooting mode	73	World Time	197
Shutter release button	56, 58, 72		
Slideshow	143		
Small Face Filter	164		

Z

Zoom / ♣ / ♣♣♣	82
Zoom button	56, 58

Memo

HOYA CORPORATION

PENTAX Imaging Systems Division

2-36-9, Maeno-cho, Itabashi-ku, Tokyo 174-8639, JAPAN
(<http://www.pentax.jp>)

**PENTAX Europe GmbH
(European Headquarters)**

Julius-Vosseler-Strasse 104, 22527 Hamburg, GERMANY
(HQ - <http://www.pentaxeurope.com>)
(Germany - <http://www.pentax.de>)

PENTAX U.K. Limited

PENTAX House, Heron Drive, Langley, Slough, Berks
SL3 8PN, U.K.
(<http://www.pentax.co.uk>)

PENTAX France S.A.S.

112 Quai de Bezons, B.P. 204, 95106 Argenteuil
Cedex, FRANCE
(<http://www.pentax.fr>)

PENTAX Imaging Company

A Division of PENTAX of America, Inc.

(Headquarters)
600 12th Street, Suite 300 Golden, Colorado 80401, U.S.A.
(PENTAX Service Department)
12061 Tejon St. STE 600 Westminster, Colorado
80234, U.S.A. (<http://www.pentaximaging.com>)

PENTAX Canada Inc.

1770 Argentia Road Mississauga, Ontario L5N 3S7,
CANADA (<http://www.pentax.ca>)

**PENTAX Trading
(SHANGHAI) Limited**

23D, Jun Yao International Plaza, 789 Zhaojiabang
Road, Xu Hui District, Shanghai, 200032 CHINA
(<http://www.pentax.com.cn>)

<http://www.pentax.jp/english>

- Specifications and external dimensions are subject to change without notice.

Free Manuals Download Website

<http://myh66.com>

<http://usermanuals.us>

<http://www.somanuals.com>

<http://www.4manuals.cc>

<http://www.manual-lib.com>

<http://www.404manual.com>

<http://www.luxmanual.com>

<http://aubethermostatmanual.com>

Golf course search by state

<http://golfingnear.com>

Email search by domain

<http://emailbydomain.com>

Auto manuals search

<http://auto.somanuals.com>

TV manuals search

<http://tv.somanuals.com>