

# **IP DSLAM**

IDL-2400 / IDL-2401

IDL-4800 / IDL-4801

**User's Manual**

## Copyright

Copyright (C) 2007 PLANET Technology Corp. All rights reserved.

The products and programs described in this User's Manual are licensed products of PLANET Technology, This User's Manual contains proprietary information protected by copyright, and this User's Manual and all accompanying hardware, software, and documentation are copyrighted.

No part of this User's Manual may be copied, photocopied, reproduced, translated, or reduced to any electronic medium or machine-readable form by any means by electronic or mechanical. Including photocopying, recording, or information storage and retrieval systems, for any purpose other than the purchaser's personal use, and without the prior express written permission of PLANET Technology.

## Disclaimer

PLANET Technology does not warrant that the hardware will work properly in all environments and applications, and makes no warranty and representation, either implied or expressed, with respect to the quality, performance, merchantability, or fitness for a particular purpose.

PLANET has made every effort to ensure that this User's Manual is accurate; PLANET disclaims liability for any inaccuracies or omissions that may have occurred.

Information in this User's Manual is subject to change without notice and does not represent a commitment on the part of PLANET. PLANET assumes no responsibility for any inaccuracies that may be contained in this User's Manual. PLANET makes no commitment to update or keep current the information in this User's Manual, and reserves the right to make improvements to this User's Manual and/or to the products described in this User's Manual, at any time without notice.

If you find information in this manual that is incorrect, misleading, or incomplete, we would appreciate your comments and suggestions.

## FCC Warning

This equipment has been tested and found to comply with the limits for a Class A digital device, pursuant to Part 15 of the FCC Rules. These limits are designed to provide reasonable protection against harmful interference when the equipment is operated in a commercial environment. This equipment generates, uses, and can radiate radio frequency energy and, if not installed and used in accordance with the Instruction manual, may cause harmful interference to radio communications. Operation of this equipment in a residential area is likely to cause harmful interference in which case the user will be required to correct the interference at his own expense.

## CE mark Warning

The is a class A device, In a domestic environment, this product may cause radio interference, in which case the user may be required to take adequate measures.

## Trademarks

The PLANET logo is a trademark of PLANET Technology. This documentation may refer to numerous hardware and software products by their trade names. In most, if not all cases, these designations are claimed as trademarks or registered trademarks by their respective companies.

## WEEE Warning



To avoid the potential effects on the environment and human health as a result of the presence of hazardous substances in electrical and electronic equipment, end users of electrical and electronic equipment should understand the meaning of the crossed-out wheeled bin symbol. Do not dispose of WEEE as unsorted municipal waste and have to collect such WEEE separately.

## Revision

User's Manual for PLANET IP DSLAM

Model: IDL-2400/2401/4800/4801

Rev: 1.0

Part No.: EM-IDLv1

## Table of Contents

|  |           |
|--|-----------|
| <b>1. Introduction</b> .....           | <b>24</b> |
| 1.1 Package Contents.....              | 24        |
| 1.2 Features.....                      | 25        |
| 1.3 Application.....                   | 25        |
| 1.4 Outlook.....                       | 26        |
| 1.4.1 Front Panel.....                 | 27        |
| 1.4.2 Rear Panel.....                  | 28        |
| 1.5 Technical Specifications.....      | 29        |
| 1.5.1 Hardware Specifications.....     | 29        |
| 1.5.2 Software Specifications.....     | 30        |
| <b>2. Installation</b> .....           | <b>32</b> |
| 2.1 Safety Instruction.....            | 32        |
| 2.2 Hardware Installation.....         | 33        |
| 2.2.1 System Requirements.....         | 33        |
| 2.2.2 Rear Panel Connection.....       | 33        |
| 2.2.3 Front Panel Connection.....      | 34        |
| 2.3 IDL Manager Installation.....      | 35        |
| 2.3.1 System Requirements.....         | 35        |
| 2.3.2 Installing IDL Manager.....      | 35        |
| 2.3.3 Starting IDL Manager.....        | 37        |
| 2.4 IDL Manager Functions.....         | 38        |
| 2.4.1 Session.....                     | 38        |
| 2.4.1.1 Logout.....                    | 38        |
| 2.4.1.2 Exit.....                      | 38        |
| 2.4.2 Tools.....                       | 39        |
| 2.4.2.1 Environment Options.....       | 39        |
| 2.4.2.2 Territory Manager.....         | 42        |
| 2.4.2.3 Agent Manager.....             | 44        |
| 2.4.2.4 Telnet.....                    | 46        |
| 2.4.2.5 PING.....                      | 47        |
| 2.4.2.6 User Manager.....              | 48        |
| 2.4.3 Windows.....                     | 51        |
| 2.4.3.1 Cascade.....                   | 51        |
| 2.4.3.2 Next Window.....               | 51        |
| 2.4.3.3 Previous Window.....           | 51        |
| 2.4.3.4 Arrange Icons.....             | 52        |
| 2.4.4 Help.....                        | 52        |
| 2.4.4.1 About.....                     | 52        |
| <b>3. IDL Manager Management</b> ..... | <b>53</b> |
| 3.1 Agent Desktop.....                 | 53        |
| 3.1.1 Agent Desktop Window.....        | 53        |

|   |           |
|---|-----------|
| 3.1.2 Mounted Agent Desktop .....               | 54        |
| 3.2 Active Function Management Windows .....    | 55        |
| 3.2.1 Function List Window .....                | 55        |
| 3.2.2 Front Panel Status Window .....           | 56        |
| 3.3 Default Setting .....                       | 56        |
| 3.4 System Information .....                    | 57        |
| 3.5 Current Event .....                         | 58        |
| 3.5.1 Outstanding Event .....                   | 58        |
| 3.5.2 Closed Event .....                        | 59        |
| 3.5.3 Archived.....                             | 60        |
| 3.6 System .....                                | 61        |
| 3.6.1 Commit and Reboot.....                    | 61        |
| 3.7 Configuration.....                          | 62        |
| 3.7.1 VLAN .....                                | 62        |
| 3.7.2 Ethernet.....                             | 63        |
| 3.8 DSL .....                                   | 65        |
| 3.8.1 Profile .....                             | 65        |
| 3.8.1.1 Line Profile .....                      | 65        |
| 3.8.1.2 Alarm Profile.....                      | 66        |
| 3.8.1.3 All Line Profile .....                  | 67        |
| 3.8.2 Port Config.....                          | 67        |
| 3.9 DSL PM.....                                 | 70        |
| 3.9.1 Physical Layer Info .....                 | 70        |
| 3.9.2 Channel Layer Info .....                  | 71        |
| <b>4. Application Note .....</b>                | <b>72</b> |
| 4.1 Basic Configuration .....                   | 72        |
| 4.1.1 Create a new user .....                   | 72        |
| 4.1.2 FD.cfg Configuration.....                 | 72        |
| 4.1.2.1 Contents of FD.cfg .....                | 73        |
| 4.1.2.2 Download procedure .....                | 74        |
| 4.1.3 How to create myconfig.cfg .....          | 78        |
| 4.1.3.1 TFTP Server Configuration .....         | 78        |
| 4.1.3.2 myconfig.cfg Configuration.....         | 79        |
| 4.1.3.3 Format of myconfig.cfg.....             | 80        |
| 4.1.4 Line Rate Configuration .....             | 81        |
| 4.1.4.1 Configuration.....                      | 82        |
| 4.1.5 Set System Time .....                     | 87        |
| 4.1.5.1 Configuration.....                      | 87        |
| 4.1.6 VLAN Configuration.....                   | 91        |
| 4.1.6.1 Configuration.....                      | 91        |
| 4.1.7 Modify the Downstream/Upstream Rate ..... | 98        |

|  |            |
|--|------------|
| 4.1.7.1 Configuration.....                     | 98         |
| 4.1.8 Enable SNMP Function .....               | 105        |
| 4.1.8.1 Configuration.....                     | 105        |
| <b>5. System Administration with CLI .....</b> | <b>106</b> |
| 5.1 About CLI Administration.....              | 106        |
| 5.1.1 Notation Conventions .....               | 106        |
| 5.1.2 Command Structure.....                   | 106        |
| 5.1.3 Glossary of Terms and Acronyms .....     | 107        |
| 5.1.4 CLI Command Brief Description .....      | 108        |
| 5.1.5 Categories of the CLI commands .....     | 109        |
| 5.2 802.1p commands.....                       | 114        |
| 5.2.1 Bridge port accessprio Commands.....     | 114        |
| 5.2.1.1 Get bridge port accessprio .....       | 114        |
| 5.2.2 Bridge port prioinfo Commands .....      | 115        |
| 5.2.2.1 Get bridge port prioinfo .....         | 115        |
| 5.2.2.2 Modify bridge port prioinfo.....       | 115        |
| 5.2.3 Bridge port trfclassmap Commands .....   | 117        |
| 5.2.3.1 Get bridge port trfclassmap.....       | 117        |
| 5.2.3.2 Modify bridge port trfclassmap .....   | 117        |
| 5.2.4 Bridge port priomap Commands.....        | 119        |
| 5.2.4.1 Get bridge port priomap .....          | 119        |
| 5.2.4.2 Modify bridge port priomap .....       | 119        |
| 5.3 ABOND Commands .....                       | 121        |
| 5.3.1 ABOND group intf Commands.....           | 121        |
| 5.3.1.1 Get abond group intf .....             | 121        |
| 5.3.1.2 Create abond group intf .....          | 121        |
| 5.3.1.3 Delete abond group intf.....           | 121        |
| 5.3.1.4 Modify abond group intf.....           | 122        |
| 5.3.2 ABOND group stats Commands .....         | 126        |
| 5.3.2.1 Get abond group stats.....             | 126        |
| 5.3.2.2 Reset abond group stats .....          | 126        |
| 5.3.3 ABOND link entry Commands .....          | 128        |
| 5.3.3.1 Get abond link entry .....             | 128        |
| 5.3.3.2 Create abond link entry.....           | 128        |
| 5.3.3.3 Delete abond link entry .....          | 128        |
| 5.3.3.4 Modify abond link entry .....          | 128        |
| 5.3.4 ABOND link stats Commands.....           | 131        |
| 5.3.4.1 Get abond link stats .....             | 131        |
| 5.3.4.2 Reset abond link stats.....            | 131        |
| 5.4 Aggregation commands .....                 | 132        |
| 5.4.1 Active Standby aggr info Commands.....   | 132        |

|         |   |     |
|---------|---|-----|
| 5.4.1.1 | Get actstdby aggr info .....            | 132 |
| 5.4.1.2 | Modify actstdby aggr info .....         | 132 |
| 5.4.2   | Aggr info Commands .....                | 134 |
| 5.4.2.1 | Get aggr intf .....                     | 134 |
| 5.4.2.2 | Create aggr intf .....                  | 134 |
| 5.4.2.3 | Delete aggr intf.....                   | 134 |
| 5.4.2.4 | Modify aggr intf.....                   | 134 |
| 5.4.3   | LACP Aggr Commands.....                 | 138 |
| 5.4.3.1 | Get lacp aggr .....                     | 138 |
| 5.4.3.2 | Create lacp aggr .....                  | 138 |
| 5.4.3.3 | Delete lacp aggr.....                   | 139 |
| 5.4.3.4 | Delete lacp aggr.....                   | 139 |
| 5.4.4   | LACP AGGRPort Info Commands .....       | 142 |
| 5.4.4.1 | Get aggrport info .....                 | 142 |
| 5.4.4.2 | Modify lacp aggrport info.....          | 142 |
| 5.4.5   | LACP AGGRPort List Commands .....       | 146 |
| 5.4.5.1 | Get lacp aggrport list.....             | 146 |
| 5.4.6   | LACP AGGRPort Stats Commands .....      | 147 |
| 5.4.6.1 | Get lacp aggrport stats.....            | 147 |
| 5.4.6.2 | Reset lacp aggrport stats .....         | 147 |
| 5.4.7   | Redundancy aggr info Commands .....     | 148 |
| 5.4.7.1 | Get rdncy aggr info .....               | 148 |
| 5.4.7.2 | Create rdncy aggr info .....            | 149 |
| 5.4.7.3 | Delete rdncy aggr info .....            | 149 |
| 5.4.7.4 | Modify rdncy aggr info.....             | 149 |
| 5.4.8   | Redundancy aggrport list Commands ..... | 151 |
| 5.4.8.1 | Get aggrport list .....                 | 151 |
| 5.4.9   | Redundancy aggr stats Commands.....     | 152 |
| 5.4.9.1 | Get rdncy aggr stats.....               | 152 |
| 5.4.9.2 | Reset rdncy aggr stats .....            | 152 |
| 5.5     | ATM commands .....                      | 154 |
| 5.5.1   | AAL5 VC Statistics Commands.....        | 154 |
| 5.5.1.1 | Get atm aal5 stats .....                | 154 |
| 5.5.2   | ATM OAM CC Commands.....                | 155 |
| 5.5.2.1 | Get oam cc vc .....                     | 155 |
| 5.5.2.2 | Modify oam cc vc .....                  | 155 |
| 5.5.3   | ATM OAM Loopback Commands .....         | 157 |
| 5.5.3.1 | Get oam lpbk vc .....                   | 157 |
| 5.5.3.2 | Modify oam lpbk vc .....                | 157 |
| 5.5.4   | ATM Port Commands.....                  | 158 |
| 5.5.4.1 | Get atm port .....                      | 158 |

|  |     |
|--|-----|
| 5.5.4.2 Create atm port .....                | 158 |
| 5.5.4.3 Delete atm port .....                | 159 |
| 5.5.4.4 Modify atm port .....                | 159 |
| 5.5.5 ATM VC Commands .....                  | 163 |
| 5.5.5.1 Create atm vc intf .....             | 163 |
| 5.5.5.2 Delete atm vc intf .....             | 163 |
| 5.5.5.3 Get atm vc intf .....                | 163 |
| 5.5.5.4 Modify atm vc intf .....             | 164 |
| 5.5.6 ATM VC Statistics Commands .....       | 171 |
| 5.5.6.1 Get atm vc stats .....               | 171 |
| 5.6 Bridging Commands.....                   | 173 |
| 5.6.1 Bridge forwarding Commands .....       | 173 |
| 5.6.1.1 Get bridge forwarding .....          | 173 |
| 5.6.1.2 Delete bridge forwarding .....       | 173 |
| 5.6.2 Bridge Mode Commands .....             | 175 |
| 5.6.2.1 Get bridge mode .....                | 175 |
| 5.6.3 Bridge Port Cap Commands.....          | 176 |
| 5.6.3.1 Get bridge port cap .....            | 176 |
| 5.6.4 Bridge port forwarding Commands .....  | 177 |
| 5.6.4.1 Get bridge port forwarding .....     | 177 |
| 5.6.4.2 Delete bridge port forwarding.....   | 177 |
| 5.6.5 Bridge Port Map Commands .....         | 179 |
| 5.6.5.1 Get bridge port map .....            | 179 |
| 5.6.5.2 Create bridge port map .....         | 179 |
| 5.6.5.3 Delete bridge port map .....         | 179 |
| 5.6.6 Bridge Port Starts Table Commands..... | 181 |
| 5.6.6.1 Get bridge port stats.....           | 181 |
| 5.6.6.2 Reset bridge port stats .....        | 181 |
| 5.6.7 Bridge Port Table Commands.....        | 182 |
| 5.6.7.1 Create bridge port intf .....        | 182 |
| 5.6.7.2 Delete bridge port intf.....         | 182 |
| 5.6.7.3 Get bridge port intf .....           | 183 |
| 5.6.7.4 Modify bridge port intf.....         | 183 |
| 5.6.8 Bridge static mcast Commands .....     | 189 |
| 5.6.8.1 Get bridge static mcast .....        | 189 |
| 5.6.8.2 Create bridge static mcast .....     | 189 |
| 5.6.8.3 Delete bridge static mcast.....      | 189 |
| 5.6.8.4 Modify bridge static mcast.....      | 189 |
| 5.6.9 Bridge static ucast Commands .....     | 192 |
| 5.6.9.1 Get bridge static ucast .....        | 192 |
| 5.6.9.2 Create bridge static ucast .....     | 192 |

|   |     |
|---|-----|
| 5.6.9.3 Delete bridge static ucast.....         | 192 |
| 5.6.9.4 Modify bridge static ucast.....         | 193 |
| 5.6.10 Bridge tbg traps Commands .....          | 195 |
| 5.6.10.1 Get bridge tbg traps .....             | 195 |
| 5.6.10.2 Modify bridge tbg traps.....           | 195 |
| 5.6.11 GARP Port Info Commands .....            | 197 |
| 5.6.11.1 Get garp port info .....               | 197 |
| 5.6.11.2 Modify garp port info.....             | 197 |
| 5.6.12 STP Group Commands .....                 | 198 |
| 5.6.12.1 Get stp info.....                      | 198 |
| 5.6.12.2 Modify stp info .....                  | 198 |
| 5.6.12.3 Reset stp stats .....                  | 199 |
| 5.6.13 STP Port Commands.....                   | 202 |
| 5.6.13.1 Get stp port .....                     | 202 |
| 5.6.13.2 Modify stp port .....                  | 202 |
| 5.6.13.3 Reset stp port stats .....             | 202 |
| 5.6.14 Transparent Bridging Table Commands..... | 205 |
| 5.6.14.1 Modify bridge tbg info.....            | 205 |
| 5.6.14.2 Get Bridge tbg info .....              | 205 |
| 5.7 Bridge Multicast Commands .....             | 210 |
| 5.7.1 Bridge mcast forwarding Commands.....     | 210 |
| 5.7.1.1 Get bridge mcast forwarding .....       | 210 |
| 5.7.1.2 Modify bridge mcast fwdall.....         | 210 |
| 5.7.2 Bridge mcast forwarding Commands.....     | 212 |
| 5.7.2.1 Get bridge mcast forwarding .....       | 212 |
| 5.7.3 Bridge mcast fwdunreg Commands.....       | 214 |
| 5.7.3.1 Get bridge mcast fwdunreg .....         | 214 |
| 5.7.3.2 Modify bridge mcast fwdunreg .....      | 214 |
| 5.7.4 Bridge Static Multicast Commands .....    | 216 |
| 5.7.4.1 Create bridge static mcast .....        | 216 |
| 5.7.4.2 Delete bridge static mcast.....         | 216 |
| 5.7.4.3 Get bridge static mcast .....           | 216 |
| 5.7.4.4 Modify bridge static mcast.....         | 217 |
| 5.8 DHCP Commands.....                          | 220 |
| 5.8.1 DHCP Client Commands .....                | 220 |
| 5.8.1.1 Get dhcp client info .....              | 220 |
| 5.8.1.2 Get dhcp client stats.....              | 221 |
| 5.9 DSL Commands .....                          | 223 |
| 5.9.1 ADSL Alarm Profile Commands .....         | 223 |
| 5.9.1.1 Get adsl alarm profile .....            | 223 |
| 5.9.1.2 Modify adsl alarm profile .....         | 223 |



|   |     |
|---|-----|
| 5.9.2 ADSL Alarm Profilext Commands .....   | 229 |
| 5.9.2.1 Get adsl alarm profilext .....      | 229 |
| 5.9.2.2 Modify adsl alarm profilext .....   | 229 |
| 5.9.3 ADSL ATUC Channel Commands.....       | 236 |
| 5.9.3.1 Get adsl atuc channel .....         | 236 |
| 5.9.4 ADSL ATUC Chanperf Commands .....     | 238 |
| 5.9.4.1 Get adsl atuc chanperf.....         | 238 |
| 5.9.5 ADSL ATUC ChanIntvl Commands .....    | 241 |
| 5.9.5.1 Get adsl atuc chanintvl.....        | 241 |
| 5.9.6 ADSL ATUC Interval Commands .....     | 242 |
| 5.9.6.1 Get adsl atuc interval .....        | 242 |
| 5.9.7 ADSL ATUC Perf Commands .....         | 244 |
| 5.9.7.1 Get adsl atuc perf.....             | 244 |
| 5.9.8 ADSL ATUC Physical Commands.....      | 247 |
| 5.9.8.1 Get adsl atuc physical.....         | 247 |
| 5.9.9 ADSL ATUC Trap Commands.....          | 254 |
| 5.9.9.1 Get adsl atuc traps.....            | 254 |
| 5.9.10 ADSL ATUC Trapsext Commands .....    | 255 |
| 5.9.10.1 Get adsl atuc trapsext .....       | 255 |
| 5.9.11 ADSL ATUR ChanIntrvl Commands .....  | 256 |
| 5.9.11.1 Get adsl atuc chanintrvl.....      | 256 |
| 5.9.12 ADSL ATUR Channel Commands.....      | 257 |
| 5.9.12.1 Get adsl atur channel.....         | 257 |
| 5.9.13 ADSL ATUR Chanperf Commands .....    | 260 |
| 5.9.13.1 Get adsl atur chanperf .....       | 260 |
| 5.9.14 ADSL ATUR Interval Commands .....    | 263 |
| 5.9.14.1 Get adsl atur interval.....        | 263 |
| 5.9.15 Adsl atur intervalext Commands ..... | 264 |
| 5.9.15.1 Get adsl atur intervalext .....    | 264 |
| 5.9.16 ADSL ATUR Perf Commands .....        | 265 |
| 5.9.16.1 Get adsl atur perf .....           | 265 |
| 5.9.17 Adsl atur perfect Commands .....     | 266 |
| 5.9.17.1 Get adsl atur perfect .....        | 266 |
| 5.9.18 ADSL ATUR Physical Commands.....     | 268 |
| 5.9.18.1 Get adsl atur physical.....        | 268 |
| 5.9.19 ADSL ATUR Traps Commands .....       | 272 |
| 5.9.19.1 Get adsl atur traps.....           | 272 |
| 5.9.20 ADSL ATUR Trapsext Commands .....    | 273 |
| 5.9.20.1 Get adsl atur trapsext.....        | 273 |
| 5.9.21 ADSL Cap Commands.....               | 275 |
| 5.9.21.1 Get adsl cap.....                  | 275 |

|   |     |
|---|-----|
| 5.9.22 ADSL Line Intf Commands.....     | 276 |
| 5.9.22.1 Get adsl line intf .....       | 276 |
| 5.9.22.2 Modify adsl line intf.....     | 276 |
| 5.9.23 ADSL Line Profile Commands ..... | 280 |
| 5.9.23.1 Get adsl line profile .....    | 280 |
| 5.9.23.2 Modify adsl line profile.....  | 280 |
| 5.9.24 Dsl chip Commands .....          | 303 |
| 5.9.24.1 Get adsl chip .....            | 303 |
| 5.9.24.2 Create dsl chip.....           | 303 |
| 5.9.24.3 Delete dsl chip .....          | 304 |
| 5.9.25 Dsl dsp chip Commands.....       | 306 |
| 5.9.25.1 Get dsl dsp chip .....         | 306 |
| 5.9.25.2 Reset dsl dsp chip.....        | 306 |
| 5.9.26 Dsl dsp port Commands .....      | 307 |
| 5.9.26.1 Get dsl dsp port.....          | 307 |
| 5.9.26.2 Reset dsl dsp port .....       | 307 |
| 5.9.27 Dsl system Commands.....         | 308 |
| 5.9.27.1 Get dsl system .....           | 308 |
| 5.9.27.2 Create dsl system .....        | 308 |
| 5.9.27.3 Delete dsl system.....         | 309 |
| 5.10 EHDLC Commands.....                | 311 |
| 5.10.1 Ehdlc intf Commands.....         | 311 |
| 5.10.1.1 Get ehdlc intf.....            | 311 |
| 5.10.1.2 Create ehdlc intf.....         | 311 |
| 5.10.1.3 Delete ehdlc intf .....        | 311 |
| 5.10.1.4 Modify ehdlc intf .....        | 311 |
| 5.11 Ethernet Commands.....             | 313 |
| 5.11.1 Dot3 stats Commands .....        | 313 |
| 5.11.1.1 Get dot3 stats .....           | 313 |
| 5.11.2 Ethernet Commands .....          | 318 |
| 5.11.2.1 Create ethernet intf.....      | 318 |
| 5.11.2.2 Delete ethernet intf.....      | 318 |
| 5.11.2.3 Get ethernet intf.....         | 318 |
| 5.11.2.4 Modify ethernet intf.....      | 318 |
| 5.12 EOA Commands .....                 | 328 |
| 5.12.1 EOA Commands.....                | 328 |
| 5.12.1.1 Create eoa intf.....           | 328 |
| 5.12.1.2 Delete oea intf .....          | 328 |
| 5.12.1.3 Get eoa intf.....              | 328 |
| 5.12.1.4 Modify eoa intf.....           | 328 |
| 5.13 Filtering Commands .....           | 332 |

|   |     |
|---|-----|
| 5.13.1 ACL Global Macentry Commands.....      | 332 |
| 5.13.1.1 Get acl global macentry .....        | 332 |
| 5.13.1.2 Create acl global macentry .....     | 332 |
| 5.13.1.3 Delete acl global macentry.....      | 332 |
| 5.13.1.4 Modify acl global macentry.....      | 332 |
| 5.13.2 Clfr list genentry commands .....      | 334 |
| 5.13.2.1 Get clfr list genentry .....         | 334 |
| 5.13.2.2 Create clfr list genentry .....      | 334 |
| 5.13.2.3 Delete clfr list genentry.....       | 334 |
| 5.13.3 ACL Port Macentry Commands .....       | 336 |
| 5.13.3.1 Get acl port macentry.....           | 336 |
| 5.13.3.2 Create acl port macentry.....        | 336 |
| 5.13.3.3 Delete acl port macentry .....       | 336 |
| 5.13.4 Clfr namedlist genentry Commands ..... | 337 |
| 5.13.4.1 Get namedlist genentry .....         | 337 |
| 5.13.4.2 Create clfr namedlist genentry ..... | 337 |
| 5.13.4.3 Delete clfr namedlist genentry ..... | 338 |
| 5.13.5 Clfr namedlist info Commands.....      | 339 |
| 5.13.5.1 Get clfr namedlist info .....        | 339 |
| 5.13.5.2 Create clfr namedlist info .....     | 339 |
| 5.13.5.3 Delete clfr namedlist info.....      | 339 |
| 5.13.5.4 Delete clfr namedlist info.....      | 339 |
| 5.13.6 Clfr namedlist map Commands .....      | 341 |
| 5.13.6.1 Get clfr namedlist map .....         | 341 |
| 5.13.6.2 Create clfr namedlist map .....      | 341 |
| 5.13.6.3 Delete clfr namedlist map .....      | 341 |
| 5.13.7 Clfr profile branch Commands .....     | 342 |
| 5.13.7.1 Get clfr profile branch.....         | 342 |
| 5.13.7.2 Create clfr profile branch.....      | 342 |
| 5.13.7.3 Delete clfr profile branch .....     | 343 |
| 5.13.8 Clfr profile info Commands .....       | 344 |
| 5.13.8.1 Get clfr profile info .....          | 344 |
| 5.13.8.2 Create clfr profile info .....       | 345 |
| 5.13.8.3 Delete clfr profile info .....       | 345 |
| 5.13.8.4 Modify clfr profile info .....       | 345 |
| 5.13.9 Clfr profile node Commands.....        | 347 |
| 5.13.9.1 Get clfr profile node.....           | 347 |
| 5.13.9.2 Create clfr profile node.....        | 347 |
| 5.13.9.3 Delete clfr profile node .....       | 347 |
| 5.13.9.4 Modify clfr profile node.....        | 347 |
| 5.13.10 Clfr tree branch Commands.....        | 355 |

|           |  |     |
|-----------|--|-----|
| 5.13.10.1 | Get clfr tree branch .....               | 355 |
| 5.13.10.2 | Create clfr tree branch .....            | 355 |
| 5.13.10.3 | Delete clfr tree branch.....             | 355 |
| 5.13.11   | Clfr tree info Commands .....            | 358 |
| 5.13.11.1 | Get clfr tree info.....                  | 358 |
| 5.13.11.2 | Create clfr tree info.....               | 358 |
| 5.13.11.3 | Delete clfr tree info .....              | 358 |
| 5.13.11.4 | Modify clfr tree info.....               | 358 |
| 5.13.12   | Clfr tree map Commands.....              | 360 |
| 5.13.12.1 | Get clfr tree map .....                  | 360 |
| 5.13.12.2 | Create clfr tree map .....               | 360 |
| 5.13.12.3 | Delete clfr tree map.....                | 360 |
| 5.13.13   | Clfr tree node Commands.....             | 361 |
| 5.13.13.1 | Get clfr tree node .....                 | 361 |
| 5.13.13.2 | Modify clfr tree node.....               | 362 |
| 5.13.14   | Clfr tree profile Commands.....          | 367 |
| 5.13.14.1 | Get clfr tree profile.....               | 367 |
| 5.13.14.2 | Create clfr tree profile.....            | 367 |
| 5.13.14.3 | Delete clfr tree profile.....            | 367 |
| 5.13.14.4 | Modify clfr tree profile.....            | 368 |
| 5.13.15   | Filter expr entry Commands .....         | 369 |
| 5.13.15.1 | Get filter expr entry .....              | 369 |
| 5.13.15.2 | Create filter expr entry .....           | 369 |
| 5.13.15.3 | Delete filter expr entry .....           | 370 |
| 5.13.16   | Filter list genentry Commands .....      | 371 |
| 5.13.16.1 | Get filter list genentry .....           | 371 |
| 5.13.16.2 | Create filter list genentry .....        | 371 |
| 5.13.16.3 | Delete filter list genentry.....         | 371 |
| 5.13.17   | Filter namedlist genentry Commands ..... | 373 |
| 5.13.17.1 | Get filter namedlist genentry .....      | 373 |
| 5.13.17.2 | Create filter namedlist genentry .....   | 373 |
| 5.13.17.3 | Delete filter namedlist genentry.....    | 373 |
| 5.13.18   | Filter namedlist info Commands .....     | 375 |
| 5.13.18.1 | Get filter namedlist info .....          | 375 |
| 5.13.18.2 | Create filter namedlist info .....       | 375 |
| 5.13.18.3 | Delete filter namedlist info.....        | 375 |
| 5.13.18.4 | Modify filter namedlist info.....        | 375 |
| 5.13.19   | Filter namedlist map Commands .....      | 377 |
| 5.13.19.1 | Get filter namedlist map .....           | 377 |
| 5.13.19.2 | Create filter namedlist map .....        | 377 |
| 5.13.19.3 | Delete filter namedlist map.....         | 377 |

|  |     |
|--|-----|
| 5.13.20 Filter rule actionmap Commands .....   | 379 |
| 5.13.20.1 Get Filter rule actionmap .....      | 379 |
| 5.13.20.2 Create filter rule actionmap .....   | 379 |
| 5.13.20.3 Delete filter rule actionmap .....   | 379 |
| 5.13.20.4 Modify filter rule actionmap .....   | 379 |
| 5.13.21 Filter rule entry Commands .....       | 383 |
| 5.13.21.1 Get Filter rule entry .....          | 383 |
| 5.13.21.2 Create filter rule entry.....        | 383 |
| 5.13.21.3 Delete filter rule entry.....        | 383 |
| 5.13.21.4 Modify filter rule entry.....        | 383 |
| 5.13.22 Filter rule map Commands .....         | 389 |
| 5.13.22.1 Get Filter rule map .....            | 389 |
| 5.13.22.2 Create filter rule map .....         | 390 |
| 5.13.22.3 Delete filter rule map .....         | 390 |
| 5.13.22.4 Modify filter rule map.....          | 390 |
| 5.13.23 Filter rule stats Commands.....        | 392 |
| 5.13.23.1 Get Filter rule stats.....           | 392 |
| 5.13.24 Filter seq entry Commands.....         | 393 |
| 5.13.24.1 Get Filter seq entry .....           | 393 |
| 5.13.24.2 Create filter seq entry.....         | 393 |
| 5.13.24.3 Delete filter seq entry .....        | 393 |
| 5.13.24.4 Modify filter seq entry.....         | 393 |
| 5.13.25 Filter seq info Commands.....          | 395 |
| 5.13.25.1 Get Filter seq info.....             | 395 |
| 5.13.25.2 Create filter seq info.....          | 395 |
| 5.13.25.3 Delete filter seq info .....         | 395 |
| 5.13.25.4 Modify filter seq info .....         | 395 |
| 5.13.26 Filter subrule arp Commands .....      | 397 |
| 5.13.26.1 Get Filter subrule arp .....         | 397 |
| 5.13.26.2 Create filter subrule arp .....      | 397 |
| 5.13.26.3 Delete filter subrule arp .....      | 398 |
| 5.13.26.4 Modify filter subrule arp.....       | 398 |
| 5.13.27 Filter subrule clfrtree Commands.....  | 404 |
| 5.13.27.1 Get Filter subrule clfrtree.....     | 404 |
| 5.13.27.2 Create filter subrule clfrtree.....  | 404 |
| 5.13.27.3 Delete filter subrule clfrtree ..... | 405 |
| 5.13.27.4 Modify filter subrule clfrtree ..... | 405 |
| 5.13.28 Filter subrule ether Commands .....    | 407 |
| 5.13.28.1 Get Filter subrule ether .....       | 407 |
| 5.13.28.2 Create filter subrule ether.....     | 407 |
| 5.13.28.3 Delete filter subrule ether .....    | 408 |

|           |                                      |     |
|-----------|--------------------------------------|-----|
| 5.13.28.4 | Modify filter subrule ether.....     | 408 |
| 5.13.29   | Filter subrule generic Commands..... | 418 |
| 5.13.29.1 | Get Filter subrule generic.....      | 418 |
| 5.13.29.2 | Create filter subrule generic.....   | 418 |
| 5.13.29.3 | Delete filter subrule generic .....  | 418 |
| 5.13.29.4 | Modify filter subrule generic .....  | 418 |
| 5.13.30   | Filter subrule ICMP Commands.....    | 422 |
| 5.13.30.1 | Get Filter subrule icmp.....         | 422 |
| 5.13.30.2 | Create filter subrule icmp .....     | 422 |
| 5.13.30.3 | Delete filter subrule icmp.....      | 422 |
| 5.13.30.4 | Modify filter subrule icmp .....     | 423 |
| 5.13.31   | Filter subrule IGMP Commands.....    | 425 |
| 5.13.31.1 | Get Filter subrule igmp.....         | 425 |
| 5.13.31.2 | Create filter subrule igmp.....      | 425 |
| 5.13.31.3 | Delete filter subrule igmp .....     | 426 |
| 5.13.31.4 | Modify filter subrule igmp .....     | 426 |
| 5.13.32   | Filter subrule IP Commands .....     | 429 |
| 5.13.32.1 | Get Filter subrule ip.....           | 429 |
| 5.13.32.2 | Create filter subrule ip.....        | 430 |
| 5.13.32.3 | Delete filter subrule ip .....       | 430 |
| 5.13.32.4 | Modify filter subrule ip .....       | 430 |
| 5.13.33   | Filter subrule PPP Commands .....    | 436 |
| 5.13.33.1 | Get Filter subrule ppp.....          | 436 |
| 5.13.33.2 | Create filter subrule ppp.....       | 436 |
| 5.13.33.3 | Delete filter subrule ppp .....      | 436 |
| 5.13.33.4 | Modify filter subrule ppp.....       | 437 |
| 5.13.34   | Filter subrule TCP Commands.....     | 439 |
| 5.13.34.1 | Get Filter subrule tcp.....          | 439 |
| 5.13.34.2 | Create filter subrule tcp .....      | 439 |
| 5.13.34.3 | Delete filter subrule tcp .....      | 440 |
| 5.13.34.4 | Modify filter subrule tcp .....      | 440 |
| 5.13.35   | Filter subrule UDP Commands .....    | 443 |
| 5.13.35.1 | Get Filter subrule udp.....          | 443 |
| 5.13.35.2 | Create filter subrule udp.....       | 443 |
| 5.13.35.3 | Delete filter subrule udp .....      | 443 |
| 5.13.35.4 | Modify filter subrule udp.....       | 444 |
| 5.14      | IGMP Commands.....                   | 447 |
| 5.14.1    | Igmpsnoop cfg info Commands .....    | 447 |
| 5.14.1.1  | Get igmpsnoop cfg info .....         | 447 |
| 5.14.1.2  | Modify igmpsnoop cfg info .....      | 447 |
| 5.14.2    | Igmpsnoop mvlan config Commands..... | 451 |

|          |                                      |     |
|----------|--------------------------------------|-----|
| 5.14.2.1 | Get igmpsnoop mvlan config.....      | 451 |
| 5.14.2.2 | Create igmpsnoop mvlan config.....   | 452 |
| 5.14.2.3 | Delete igmpsnoop mvlan config.....   | 452 |
| 5.14.2.4 | Modify igmpsnoop mvlan config.....   | 452 |
| 5.14.3   | Igmpsnoop port info Commands.....    | 455 |
| 5.14.3.1 | Get igmpsnoop port info.....         | 455 |
| 5.14.3.2 | Modify igmpsnoop port info.....      | 455 |
| 5.14.4   | Igmpsnoop port stats Commands.....   | 459 |
| 5.14.4.1 | Get igmpsnoop port stats.....        | 459 |
| 5.14.4.2 | Reset igmpsnoop port stats.....      | 459 |
| 5.14.5   | Igmpsnoop querier info Commands..... | 461 |
| 5.14.5.1 | Get igmpsnoop querier info.....      | 461 |
| 5.14.5.2 | Create igmpsnoop querier info.....   | 461 |
| 5.14.5.3 | Delete igmpsnoop querier info.....   | 462 |
| 5.15     | Interface Commands.....              | 464 |
| 5.15.1   | Interface Commands.....              | 464 |
| 5.15.1.1 | Get interface stats.....             | 464 |
| 5.15.1.2 | Reset interface stats.....           | 467 |
| 5.15.1.3 | Get interface config.....            | 467 |
| 5.15.1.4 | Modify interface config.....         | 467 |
| 5.16     | IP Commands.....                     | 469 |
| 5.16.1   | IP Net to Media Table Commands.....  | 469 |
| 5.16.1.1 | Get arp.....                         | 469 |
| 5.16.1.2 | Create arp.....                      | 469 |
| 5.16.1.3 | Delete arp.....                      | 469 |
| 5.16.2   | IP Route Commands.....               | 471 |
| 5.16.2.1 | Get ip route.....                    | 471 |
| 5.16.2.2 | Create up route.....                 | 472 |
| 5.16.2.3 | Delete ip route.....                 | 472 |
| 5.16.3   | Ipoa intf Commands.....              | 475 |
| 5.16.3.1 | Get ipoa intf.....                   | 475 |
| 5.16.3.2 | Create ipoa intf.....                | 475 |
| 5.16.3.3 | Delete ipoa intf.....                | 476 |
| 5.16.3.4 | Modify ipoa intf.....                | 476 |
| 5.16.4   | Ipoe intf Commands.....              | 478 |
| 5.16.4.1 | Get ipoe intf.....                   | 478 |
| 5.16.4.2 | Create ipoe intf.....                | 478 |
| 5.16.4.3 | Delete ipoe intf.....                | 478 |
| 5.16.4.4 | Modify ipoe intf.....                | 478 |
| 5.16.5   | Rid static Commands.....             | 481 |
| 5.16.5.1 | Create rid static.....               | 481 |

|   |     |
|---|-----|
| 5.16.5.2 Delete rid static .....                  | 481 |
| 5.17 MacProfile Commands .....                    | 484 |
| 5.17.1 Macprofile globale Commands .....          | 484 |
| 5.17.1.1 Get macprofile global .....              | 484 |
| 5.17.1.2 Create macprofile global .....           | 484 |
| 5.17.1.3 Delete macprofile global .....           | 484 |
| 5.17.2 Resvdmac profile info Commands .....       | 485 |
| 5.17.2.1 Get resvdmac profile info .....          | 485 |
| 5.17.2.2 Create resvdmac profile info .....       | 485 |
| 5.17.2.3 Delete resvdmac profile info.....        | 485 |
| 5.17.3 Resvdmac profile param Commands.....       | 486 |
| 5.17.3.1 Get resvdmac profile param.....          | 486 |
| 5.17.3.2 Create resvdmac profile param.....       | 487 |
| 5.17.3.3 Delete resvdmac profile param .....      | 487 |
| 5.18 Management Traffic Commands .....            | 489 |
| 5.18.1 Ctlpkt group info Commands .....           | 489 |
| 5.18.1.1 Get ctlpkt group info .....              | 489 |
| 5.18.1.2 Create ctlpkt group info .....           | 489 |
| 5.18.1.3 Delete ctlpkt group info .....           | 489 |
| 5.18.2 Ctlpkt instance info Commands .....        | 490 |
| 5.18.2.1 Get ctlpkt instance info.....            | 490 |
| 5.18.2.2 Create ctlpkt instance info .....        | 490 |
| 5.18.2.3 Delete ctlpkt instance info .....        | 491 |
| 5.18.2.4 Modify ctlpkt instance info .....        | 491 |
| 5.18.3 Ctlpkt profile info Commands.....          | 492 |
| 5.18.3.1 Get ctlpkt profile info .....            | 492 |
| 5.18.3.2 Create ctlpkt profile info .....         | 492 |
| 5.18.3.3 Delete ctlpkt profile info.....          | 493 |
| 5.18.3.4 Modify ctlpkt profile info.....          | 493 |
| 5.19 PPPoE Tunneling Commands.....                | 495 |
| 5.19.1 PPPoE Global ACprofile Commands.....       | 495 |
| 5.19.1.1 Get pppoe global acprofile .....         | 495 |
| 5.19.1.2 Create pppoe global acprofile .....      | 495 |
| 5.19.1.3 Delete pppoe global acprofile .....      | 495 |
| 5.19.2 PPPoE Global Config Commands .....         | 496 |
| 5.19.2.1 Get pppoe global config .....            | 496 |
| 5.19.2.2 Create pppoe global config .....         | 496 |
| 5.19.3 PPPoE Global Serviceprofile Commands.....  | 499 |
| 5.19.3.1 Get pppoe global serviceprofile.....     | 499 |
| 5.19.3.2 Create pppoe global serviceprofile.....  | 499 |
| 5.19.3.3 Delete pppoe global serviceprofile ..... | 499 |



|   |     |
|---|-----|
| 5.19.4 PPPoE Global Stats Commands .....  | 500 |
| 5.19.4.1 Get pppoe global stats .....     | 500 |
| 5.19.5 Pppoe intf Commands .....          | 501 |
| 5.19.5.1 Get pppoe intf.....              | 501 |
| 5.19.5.2 Create pppoe intf.....           | 502 |
| 5.19.5.3 Delete pppoe intf .....          | 502 |
| 5.19.5.4 Modify pppoe intf.....           | 502 |
| 5.19.6 PPPoE Session Stats Commands ..... | 506 |
| 5.19.6.1 Get pppoe session stats.....     | 506 |
| 5.19.7 PPPPR Interface Commands .....     | 508 |
| 5.19.7.1 Get pppr intf .....              | 508 |
| 5.19.7.2 Create pppr intf .....           | 508 |
| 5.19.7.3 Delete pppr intf.....            | 508 |
| 5.19.7.4 Modify pppr intf.....            | 508 |
| 5.20 IA (Intermeida Agent) Commands ..... | 512 |
| 5.20.1 Dra global stats Commands .....    | 512 |
| 5.20.1.1 Get dra global stats .....       | 512 |
| 5.20.1.2 Reset dra global stats .....     | 512 |
| 5.20.2 Dra instance entry Commands .....  | 513 |
| 5.20.2.1 Get dra instance entry.....      | 513 |
| 5.20.2.2 Create dra instance entry.....   | 513 |
| 5.20.2.3 Delete dra instance entry .....  | 514 |
| 5.20.2.4 Modify dra instance entry.....   | 514 |
| 5.20.3 Dra stats entry Commands .....     | 519 |
| 5.20.3.1 Get dra stats entry.....         | 519 |
| 5.20.3.2 Reset dra stats entry .....      | 519 |
| 5.20.4 Dra global config Commands .....   | 520 |
| 5.20.4.1 Get dra global config.....       | 520 |
| 5.20.4.2 Modify dra global config.....    | 520 |
| 5.20.5 Ia profile entry Commands.....     | 521 |
| 5.20.5.1 Get ia profile entry.....        | 521 |
| 5.20.5.2 Create ia profile entry.....     | 521 |
| 5.20.5.3 Delete ia profile entry .....    | 522 |
| 5.20.5.4 Modify ia profile entry.....     | 522 |
| 5.20.6 Pia instance entry Commands.....   | 525 |
| 5.20.6.1 Get pia instance entry .....     | 525 |
| 5.20.6.2 Create pia instance entry .....  | 525 |
| 5.20.6.3 Delete pia instance entry.....   | 526 |
| 5.20.6.4 Modify pia instance entry .....  | 526 |
| 5.20.7 Pia stats entry Commands.....      | 531 |
| 5.20.7.1 Get pia stats entry.....         | 531 |

|          |  |     |
|----------|--|-----|
| 5.20.7.2 | Reset pia stats entry .....            | 531 |
| 5.20.8   | Pia global config Commands .....       | 532 |
| 5.20.8.1 | Get pia global config .....            | 532 |
| 5.20.8.2 | Modify pia global config.....          | 533 |
| 5.21     | QoS Commands.....                      | 534 |
| 5.21.1   | IRL Map Commands.....                  | 534 |
| 5.21.1.1 | Get irl map .....                      | 534 |
| 5.21.1.2 | Create irl map .....                   | 534 |
| 5.21.1.3 | Delete irl map.....                    | 534 |
| 5.21.2   | IRL Profile Commands.....              | 535 |
| 5.21.2.1 | Get irl profile.....                   | 535 |
| 5.21.2.2 | Create irl profile.....                | 535 |
| 5.21.2.3 | Delete irl profile .....               | 536 |
| 5.21.2.4 | Modify irl profile .....               | 536 |
| 5.21.3   | IRL Stats Commands.....                | 539 |
| 5.21.3.1 | Get irl stats .....                    | 539 |
| 5.21.4   | Bridge rlin stance map Commands.....   | 540 |
| 5.21.4.1 | Get bridge rlinstance map .....        | 540 |
| 5.21.4.2 | Create bridge rlinstance map .....     | 540 |
| 5.21.4.3 | Delete bridge rlinstance map .....     | 540 |
| 5.21.4.4 | Modify bridge rlinstance map .....     | 540 |
| 5.21.5   | RI actionprofile info Commands.....    | 542 |
| 5.21.5.1 | Get rl actionprofile info .....        | 542 |
| 5.21.5.2 | Create rl actionprofile info .....     | 542 |
| 5.21.5.3 | Delete rl actionprofile info .....     | 542 |
| 5.21.5.4 | Modify rl actionprofile info .....     | 543 |
| 5.21.6   | RI instance info Commands.....         | 546 |
| 5.21.6.1 | Get rl instance info .....             | 546 |
| 5.21.6.2 | Create rl instance info .....          | 546 |
| 5.21.6.3 | Delete rl instance info.....           | 546 |
| 5.21.7   | RI profile info Commands .....         | 548 |
| 5.21.7.1 | Get rl profile info.....               | 548 |
| 5.21.7.2 | Create rl profile info.....            | 548 |
| 5.21.7.3 | Delete rl profile info .....           | 548 |
| 5.21.7.4 | Modify rl profile info .....           | 549 |
| 5.21.8   | Scheduling profile class Commands..... | 552 |
| 5.21.8.1 | Get sched profile class.....           | 552 |
| 5.21.8.2 | Modify sched profile class .....       | 552 |
| 5.21.9   | Scheduling profile info Commands ..... | 555 |
| 5.21.9.1 | Get sched profile info .....           | 555 |
| 5.21.9.2 | Create sched profile info .....        | 555 |

|   |     |
|---|-----|
| 5.21.9.3 Delete sched profile info .....      | 556 |
| 5.21.10 Trfclass profile class Commands ..... | 557 |
| 5.21.10.1 Get trfclass profile class .....    | 557 |
| 5.21.10.2 Modify trfclass profile class ..... | 558 |
| 5.21.11 Trfclass profile info Commands .....  | 559 |
| 5.21.11.1 Get trfclass profile info.....      | 559 |
| 5.21.11.2 Create trfclass profile info.....   | 559 |
| 5.21.11.3 Delete trfclass profile info .....  | 559 |
| 5.21.12 Trfclass stats Commands .....         | 560 |
| 5.21.12.1 Get trfclass stats .....            | 560 |
| 5.21.12.2 Reset trfclass stats .....          | 561 |
| 5.22 RMON Commands.....                       | 562 |
| 5.22.1 RMON Statistics Group Commands .....   | 562 |
| 5.22.1.1 Create srmon probe .....             | 562 |
| 5.22.1.2 Delete srmon probe .....             | 562 |
| 5.22.1.3 Get srmon probe .....                | 562 |
| 5.22.2 RMON Task Info Commands .....          | 564 |
| 5.22.2.1 Get rmon task.....                   | 564 |
| 5.22.3 RMON Memory Pool Info Commands .....   | 566 |
| 5.22.3.1 Get rmon mpool .....                 | 566 |
| 5.22.3.2 Get rmon mpool threshold.....        | 570 |
| 5.22.3.3 Reset rmon mpool.....                | 572 |
| 5.22.4 RMON Queue Info Commands.....          | 572 |
| 5.22.4.1 Get rmon queue .....                 | 572 |
| 5.22.4.2 Get rmon queue threshold .....       | 575 |
| 5.22.4.3 Reset rmon queue .....               | 576 |
| 5.22.5 RMON Net buffers Info Commands .....   | 576 |
| 5.22.5.1 Get rmon netbuf .....                | 576 |
| 5.22.5.2 Get rmon netbuf threshold .....      | 578 |
| 5.22.5.3 Reset rmon netbuf .....              | 579 |
| 5.22.6 RMON Semaphore Info Commands.....      | 579 |
| 5.22.6.1 Get rmon semaphore .....             | 579 |
| 5.22.7 RMON Event Group Info Commands .....   | 580 |
| 5.22.7.1 Get rmon eventgrp .....              | 580 |
| 5.23 SNMP Commands .....                      | 582 |
| 5.23.1 SNMP Comm Commands .....               | 582 |
| 5.23.1.1 Get snmp comm.....                   | 582 |
| 5.23.1.2 Create snmp comm.....                | 582 |
| 5.23.1.3 Delete snmp comm .....               | 582 |
| 5.23.2 SNMP Host Commands.....                | 583 |
| 5.23.2.1 Get snmp host.....                   | 583 |

|   |     |
|---|-----|
| 5.23.2.2 Create snmp host.....                              | 583 |
| 5.23.2.3 Delete snmp host.....                              | 584 |
| 5.23.3 SNMP Stats Commands .....                            | 585 |
| 5.23.3.1 Snmp stats .....                                   | 585 |
| 5.23.3.2 Modify snmp stats .....                            | 585 |
| 5.23.4 SNMP Traphost Commands .....                         | 588 |
| 5.23.4.1 Get snmp traphost .....                            | 588 |
| 5.23.4.2 Create snmp traphost.....                          | 588 |
| 5.23.4.3 Delete snmp traphost.....                          | 589 |
| 5.23.4.4 Modify snmp traphost.....                          | 589 |
| 5.24 SNTP Commands .....                                    | 591 |
| 5.24.1 SNTP Cfg Commands .....                              | 591 |
| 5.24.1.1 Get sntp cfg.....                                  | 591 |
| 5.24.1.2 Modify sntp cfg.....                               | 591 |
| 5.24.2 SNTP servaddr Commands.....                          | 592 |
| 5.24.2.1 Get sntp servaddr .....                            | 592 |
| 5.24.2.2 Create sntp servaddr .....                         | 592 |
| 5.24.3 SNTP Stats Commands.....                             | 593 |
| 5.24.3.1 Get sntp stats.....                                | 593 |
| 5.24.3.2 Reset sntp stats .....                             | 593 |
| 5.25 System Commands.....                                   | 594 |
| 5.25.1 Cbuftrace cfg Commands .....                         | 594 |
| 5.25.1.1 Get cbuftrace cfg.....                             | 594 |
| 5.25.1.2 Reset cbuftrace cfg .....                          | 594 |
| 5.25.2 System Configuration Save and Restore Commands ..... | 595 |
| 5.25.2.1 Commit.....  | 595 |
| 5.25.2.2 Reboot .....                                       | 595 |
| 5.25.3 System Control Table Commands .....                  | 597 |
| 5.25.3.1 Create user .....                                  | 597 |
| 5.25.3.2 Delete user.....                                   | 597 |
| 5.25.3.3 Get user .....                                     | 597 |
| 5.25.3.4 Passwd .....                                       | 599 |
| 5.25.4 System crash info Commands.....                      | 600 |
| 5.25.4.1 Get system crash info .....                        | 600 |
| 5.25.4.2 Get system crash configinfo.....                   | 608 |
| 5.25.4.3 Modify system crash configinfo.....                | 608 |
| 5.25.5 System info Commands.....                            | 609 |
| 5.25.5.1 Get system info .....                              | 609 |
| 5.25.5.2 Modify system info .....                           | 609 |
| 5.25.5.3 Get rmon idletime.....                             | 613 |
| 5.25.6 System manu info Commands.....                       | 614 |

|           |  |     |
|-----------|--|-----|
| 5.25.6.1  | Get system manuf info .....            | 614 |
| 5.25.7    | System reboot info Commands .....      | 616 |
| 5.25.7.1  | Get system reboot info .....           | 616 |
| 5.25.8    | Nbize Commands .....                   | 618 |
| 5.25.8.1  | Get nbize .....                        | 618 |
| 5.25.8.2  | Modify nbize .....                     | 618 |
| 5.25.9    | System Stats Commands .....            | 627 |
| 5.25.9.1  | Get system stats .....                 | 627 |
| 5.25.9.2  | Reset system stats .....               | 627 |
| 5.25.10   | System Traps Commands .....            | 629 |
| 5.25.10.1 | Reset traps .....                      | 629 |
| 5.25.11   | System Traps Log Table Commands .....  | 629 |
| 5.25.11.1 | Get traps .....                        | 629 |
| 5.25.12   | System Version Commands .....          | 637 |
| 5.25.12.1 | Get system version .....               | 637 |
| 5.25.13   | Trace Log Configuration Commands ..... | 638 |
| 5.25.13.1 | Get trace cfg .....                    | 638 |
| 5.25.13.2 | Modify trace cfg .....                 | 638 |
| 5.25.14   | Trace Log Statistics Commands .....    | 640 |
| 5.25.14.1 | Get trace stats .....                  | 640 |
| 5.26      | VC Aggregation Commands .....          | 642 |
| 5.26.1    | Atm vcaggr intf Commands .....         | 642 |
| 5.26.1.1  | Get atm vcaggr intf .....              | 642 |
| 5.26.1.2  | Create atm vcaggr intf .....           | 642 |
| 5.26.1.3  | Delete atm vcaggr intf .....           | 642 |
| 5.26.1.4  | Modify atm vcaggr intf .....           | 642 |
| 5.26.2    | Atm vcaggr map Commands .....          | 644 |
| 5.26.2.1  | Get atm vcaggr map .....               | 644 |
| 5.26.2.2  | Create atm vcaggr map .....            | 645 |
| 5.26.2.3  | Delete atm vcaggr map .....            | 645 |
| 5.26.2.4  | Modify atm vcaggr map .....            | 645 |
| 5.27      | VLAN Commands .....                    | 648 |
| 5.27.1    | GVRP Info Commands .....               | 648 |
| 5.27.1.1  | Get gvrp info .....                    | 648 |
| 5.27.1.2  | Modify gvrp info .....                 | 648 |
| 5.27.2    | GVRP Port Info Commands .....          | 649 |
| 5.27.2.1  | Get gvrp port info .....               | 649 |
| 5.27.2.2  | Modify gvrp port info .....            | 649 |
| 5.27.3    | GVRP Port Stats Commands .....         | 654 |
| 5.27.3.1  | Get gvrp port stats .....              | 654 |
| 5.27.3.2  | Reset gvrp port stats .....            | 654 |

|  |            |
|--|------------|
| 5.27.4 Vlan curr info Commands .....                           | 655        |
| 5.27.4.1 Get vlan curr info.....                               | 655        |
| 5.27.5 VLAN mapprofile info Commands .....                     | 657        |
| 5.27.5.1 Get vlan mapprofile info .....                        | 657        |
| 5.27.5.2 Create vlan mapprofile info .....                     | 658        |
| 5.27.5.3 Delete vlan mapprofile info .....                     | 658        |
| 5.27.6 Vlan mapprofile param Commands .....                    | 659        |
| 5.27.6.1 Get vlan mapprofile param.....                        | 659        |
| 5.27.6.2 Create vlan mapprofile param.....                     | 659        |
| 5.27.6.3 Delete vlan mapprofile param .....                    | 659        |
| 5.27.7 VLAN Static Commands .....                              | 661        |
| 5.27.7.1 Get vlan static .....                                 | 661        |
| 5.27.7.2 Create vlan static .....                              | 661        |
| 5.27.7.3 Modify vlan static.....                               | 662        |
| 5.27.7.4 Delete vlan static.....                               | 662        |
| 5.28 Miscellaneous Commands .....                              | 672        |
| 5.28.1 File Commands .....                                     | 672        |
| 5.28.1.1 Apply .....   | 672        |
| 5.28.1.2 Download .....  | 674        |
| 5.28.1.3 List .....  | 676        |
| 5.28.1.4 Permission .....                                      | 681        |
| 5.28.1.5 Ping.....   | 682        |
| 5.28.1.6 Remove.....   | 683        |
| 5.28.1.7 Upgrade .....   | 684        |
| 5.28.1.8 Upload.....   | 685        |
| 5.28.2 Other Commands .....                                    | 687        |
| 5.28.2.1 Unalias .....   | 688        |
| 5.28.2.2 Help.....   | 689        |
| 5.28.2.3 Logout .....  | 690        |
| 5.28.2.4 Prompt .....  | 690        |
| 5.28.2.5 Traceroute.....                                       | 691        |
| 5.28.2.6 Verbose .....   | 692        |
| <b>Appendix A --- FD.cfg in detail .....</b>                   | <b>693</b> |
| <b>Appendix B --- Supported mibs .....</b>                     | <b>698</b> |
| PropMib (Conexant) .....                                       | 698        |
| StdMib (Standard) .....  | 699        |
| <b>Appendix C --- IEEE 802.1x protocol over IP DSLAM .....</b> | <b>700</b> |
| Understanding How 802.1X Authentication Works.....             | 700        |
| Device Roles .....   | 701        |
| Authenticcation Initiation and Message Exchange .....          | 702        |
| 802.1X CLI commands.....                                       | 703        |
| Specifying RADIUS Servers .....                                | 703        |

|   |            |
|---|------------|
| Specifying the RADIUS Key .....                                       | 703        |
| Configuring 802.1X Authentication .....                               | 703        |
| Enabling 802.1X globally .....  | 704        |
| Disabling 802.1X globally.....  | 704        |
| Enabling and Initializing 802.1X Authentication Individual Ports..... | 704        |
| Enabling Multiple Hosts.....  | 705        |
| Disabling Multiple Hosts.....   | 705        |
| 802.1X Protocol over IP DSLAM .....                                   | 705        |
| <b>Appendix D --- What's IP DSLAM.....</b>                            | <b>706</b> |

# 1. Introduction

With built-in POTS splitter 24 / 48 ADSL/ADSL2/ADSL2+ Subscriber ports, the PLANET IDL series are advanced IP based DSLAM which is designed for Network Service Provider to offer excellent services to multiple subscribers. The replaceable 1000Base-T or 1000Base-LX uplink interfaces, and stackable support other units that provide the flexibility of the network implementation.

The PLANET IDL series support local and remote management capabilities of CLI, SNMP and Telnet via RS-232 CID and Ethernet MGNT ports, Microsoft Windows based GUI Management system provides Network Service Provider a centrally management capability.

The PLANET IP DSLAM provides many features such as QoS, VLAN, Bandwidth Management, Traffic Prioritization, and Data Flow Security Control. The IDL series offer Network Service Provider the most suitable solution and makes subscribers an efficient way to meet triple play (data, voice, and video).

## 1.1 Package Contents

---

Please inspect your package. The following items should be included in the package:

### **IDL-2400/2401**

- IDL-2400/2401 unit x 1
- AC Power Cord x 1
- CD (Containing User's Manual, QIG, IDL Manager) x 1
- Quick Installation Guide x 1
- RJ-45 Cable x 1
- RS-232 Cable x 1
- Telco-50 Cable x 1

### **IDL-4800/4801**

- IDL-4800/4801 unit x 1
- AC Power Cord x 1
- CD (Containing User's Manual, QIG, IDL Manager) x 1
- Quick Installation Guide x 1
- RJ-45 Cable x 1
- RS-232 Cable x 1
- Telco-50 Cable x 2



## 1.2 Features

---

- 24-Port or 48-Port ADSL/ADSL2/ADSL2+ subscriber interface with built-in POTS splitter
- DMT data rate: Downstream 32 kbps up to 25 Mbps / Upstream 32 kbps up to 1Mbps
- 1000Base-T (IDL-2400/IDL-4800) or 1000Base-LX (IDL-2401/IDL-4801) uplink interface
- Stackable support
- Microsoft Windows based GUI management
- Local RS-232 CLI and Ethernet SNMP/Telnet management
- Firmware upgradeable via FTP or TFTP
- 6K MAC address & 256 Multicast MAC address support
- Static VLAN and Port based VLAN
- VLAN / MAC / IP filtering
- Access Control List by MAC and IP address
- Traffic prioritization (802.1p)
- Traffic bandwidth management by MAC and IP address

## 1.3 Application

---

The PLANET IDL series offer the benefit of high performance to central office co-location and MTU (Multi-Tenant Unit) / MDU (Multi-Dwelling Unit) markets. It provides broadband data service over existing copper wires without affecting the conventional voice service by 24/48 subscriber ports with built-in POTS splitter. A PLANET IP DSLAM is the perfect solution for NSP a cost-effective but high-value centrally management capability.

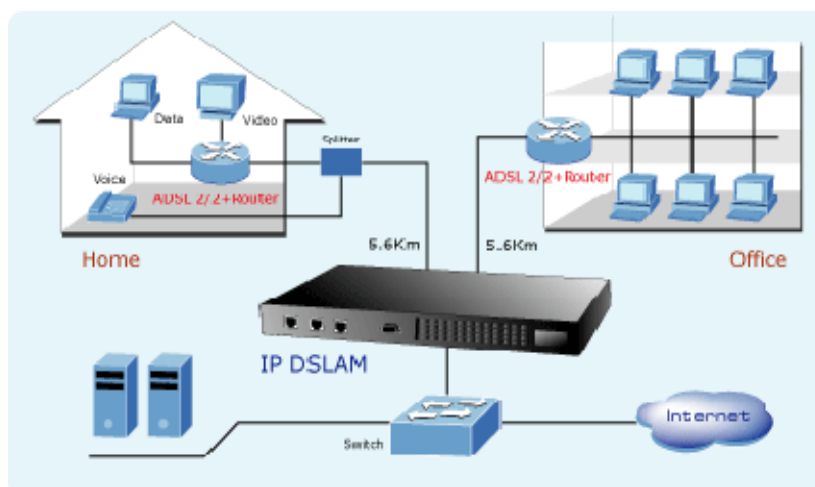

## 1.4 Outlook

---



**IDL-2400**



**IDL-4800**

### IDL-2401 / IDL-4801 with 1000Base-LX UPLINK



1 x 1000Base-LX UPLINK1  
1 x 1000Base-T UPLINK2  
1 x 1000Base-T MGNT

## 1.4.1 Front Panel

The front panels of IDL series are shown below.

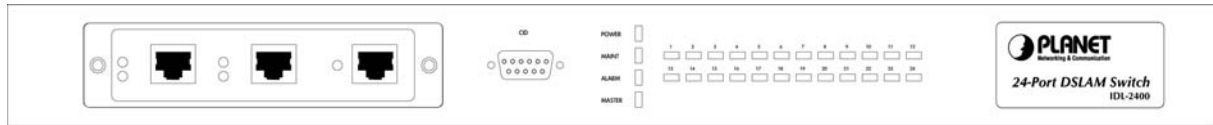

**IDL-2400**

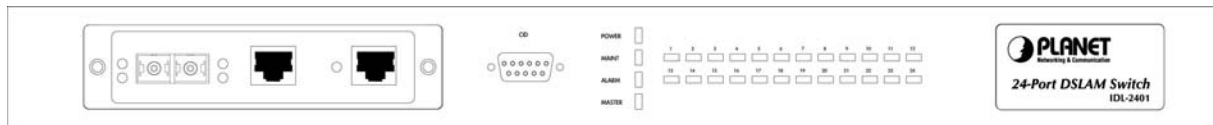

**IDL-2401**

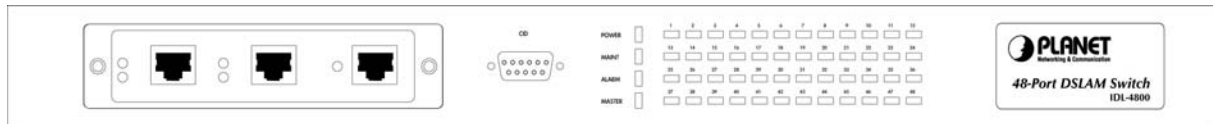

**IDL-4800**

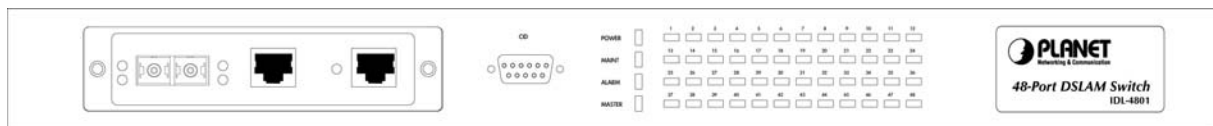

**IDL-4801**

## LED Definition

| LED                                   | Color                              | LED Description  |
|---------------------------------------|------------------------------------|--|
| <b>POWER</b>                          | Green                              | Lit when power on  |
| <b>MAINT</b>                          | Yellow                             | Lit when maintenance commands were issued  |
| <b>ALARM</b>                          | Red                                | Lit when MJ/MN events happen   |
| <b>MASTER</b>                         | Green                              | Lit when system was acted as management master for stacking application (* Future feature)   |
| <b>ADSL 1~24<br/>or<br/>ADSL 1~48</b> | Green<br>Orange<br>No Light<br>Red | Lit when ADSL link is in a active state<br>When the specified ADSL link is in connection training stat<br>When ADSL link is not in service<br>Lit when loss of signal occurs |
| <b>1000/ACT</b>                       | Green                              | Blinking when information action is transmitted  |
| <b>100/ACT</b>                        | Green                              | Blinking when information is transmitted   |
| <b>GIGA</b>                           | Green                              | Blinking when information is transmitted (* IDL-2401/4801)   |
| <b>ACT</b>                            | Green                              | When uplink is activated (* IDL-2401/4801)   |

## 1.4.2 Rear Panel

The rear panels of IDL series are shown below.

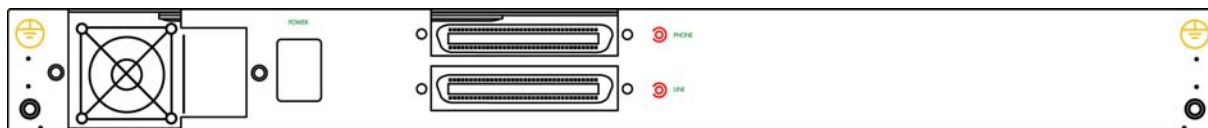

**IDL-2400/2401**

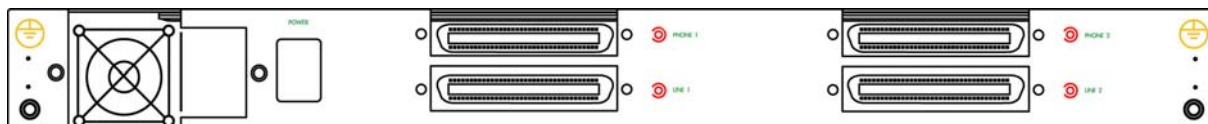

**IDL-4800/4801**

### Port Definition

| Port    | Port Description   |
|---------|--|
| AC IN   | AC Power cord in   |
| POWER   | Power switch   |
| PHONE 1 | 24 port ADSL module with built-in POTS                       |
| LINE 1  |  |
| PHONE 2 | 24 port ADSL module with built-in POTS<br>(* IDL-4800/4801 ) |
| LINE 2  |  |

## 1.5 Technical Specifications

### 1.5.1 Hardware Specifications

| Model          |          | IDL-2400   | IDL-2401  |
|----------------|----------|--|---|
| Ports          | Uplink 1 | 1 x RJ-45 (10/100/1000Base-T)  | 1 x SC (1000Base-LX)  |
|                | Uplink 2 | 1 x RJ-45 (10/100/1000Base-T)  |   |
|                | MGNT     | 1 x RJ-45 (10/100/1000Base-T)  |   |
|                | Console  | 1 x RS-232   |   |
|                | Line     | 1 x Telco-50   |   |
|                | Phone    | 1 x Telco-50   |   |
| LED Indicators |          | 1 x POWER LED<br>1 x MAINT LED<br>1 x ALARM LED<br>1 x MASTER LED<br>24 x ADSL LEDs<br>2 x 1000/ACT LEDs<br>3 x 100/ACT LEDs | 1 x POWER LED<br>1 x MAINT LED<br>1 x ALARM LED<br>1 x MASTER LED<br>24 x ADSL LEDs<br>1 x 1000/ACT LEDs<br>2 x 100/ACT LEDs<br>1 x GIGA LED<br>1 x ACT LED |

| Model          |          | IDL-4800   | IDL-4801  |
|----------------|----------|--|---|
| Ports          | Uplink 1 | 1 x RJ-45 (10/100/1000Base-T)  | 1 x SC (1000Base-LX)  |
|                | Uplink 2 | 1 x RJ-45 (10/100/1000Base-T)  |   |
|                | MGNT     | 1 x RJ-45 (10/100/1000Base-T)  |   |
|                | Console  | 1 x RS-232   |   |
|                | Line     | 2 x Telco-50   |   |
|                | Phone    | 2 x Telco-50   |   |
| LED Indicators |          | 1 x POWER LED<br>1 x MAINT LED<br>1 x ALARM LED<br>1 x MASTER LED<br>48 x ADSL LEDs<br>2 x 1000/ACT LEDs<br>3 x 100/ACT LEDs | 1 x POWER LED<br>1 x MAINT LED<br>1 x ALARM LED<br>1 x MASTER LED<br>48 x ADSL LEDs<br>1 x 1000/ACT LEDs<br>2 x 100/ACT LEDs<br>1 x GIGA LED<br>1 x ACT LED |

## 1.5.2 Software Specifications

|           |  |
|-----------|--|
| Standard  | <p>Compliant with ADSL standard</p> <ul style="list-style-type: none"> <li>- ANSI T1.413 issue 2</li> <li>- G.dmt (ITU G.992.1)</li> <li>- G.lite (ITU G.992.2)</li> <li>- G.hs (ITU G.994.1)</li> </ul> <p>Capable of ADSL2 standard</p> <ul style="list-style-type: none"> <li>- G.dmt.bis (ITU G.992.3)</li> </ul> <p>Capable of ADSL2+ standard</p> <ul style="list-style-type: none"> <li>- G.dmt.bisplus (ITU G.992.5)</li> </ul>  |
| Protocol  | <p>STP</p> <p>IGMP snooping</p> <p>GMRP</p> <p>GVRP</p> <p>LACP</p> <p>SNMP / UDP / IP / MAC / Ethernet</p>  |
| Multicast | <p>Up to 256 multicast addresses</p> <p>IGMP v1, v2, v3</p> <p>Multicast VLAN mapping: Independent VLAN multicast (IVM)</p> <p>Multicast VLAN mapping: Shared VLAN Multicast (SVM)</p> <p>Handle PPPoE Encapsulated IGMP packets</p>   |
| System    | <p>Subscriber interface with built-in POTS splitter</p> <p>Downstream DMT data rate 32 kbps up to 25 Mbps</p> <p>Upstream DMT data rate 32 kbps up to 1Mbps</p> <p>Extended power management capabilities to optimize power consumption for each application</p> <p>Distance up to 18 kft</p> <p>1000Base-T / 1000Base-LX uplink interface via model</p> <p>Stackable support</p> <p>Centronic 50 pin connector for Telco line in and out</p> <p>8 VCs per xDSL port</p> <p>128 MAC address per x DSL port</p> <p>6K MAC address</p> <p>Ethernet Bridging: Broadcast, Flooding / Dropping</p> <p>VLAN Bridging: 512 VLAN, Static VLAN, VLAN Stacking / Trunking</p> <p>Packet size 64 byte to 1522byte</p> <p>PPPoE Intermediate Agent</p> <p>DHCP Relay Agent</p> <p>IPOA to IPOE Tunneling</p> <p>PPPoA to PPPoE inter-working</p> |

|            |  |
|------------|--|
|            | Input Rate Limiting (IRL) on a per-AAL5 interface<br>Output Rate Limiting (ORL) on a per ATM-port and Ethernet basis<br>Rate Limiting<br>Multiple mechanisms of prioritizing traffic                 |
| Security   | VLAN filtering<br>MAC filtering<br>IP filtering<br>Access Control List by MAC address<br>Access Control List by IP address<br>Throttling Control<br>Sticky Bridge Ports                              |
| Management | Microsoft Windows based GUI management<br>Local RS-232 CLI, and Ethernet SNMP / Telnet management<br>Remote in-band SNMP / Telnet management<br>Firmware upgradeable via FTP or TFTP<br>SNMP v1, v2c |

## 2. Installation

The followings are instructions for setting up the IDL series IP DSLAM. Refer to the illustration and follow the simple steps below to quickly install your IP DSLAM.

### 2.1 Safety Instruction

---

The following is the safety instructions for IP DSLAM before installing.

>> The maximum recommended operating temperature is 50°C. Care must be taken to allow sufficient air circulation or space between units when the IP DSLAM is installed inside a closed rack assembly and racks should safely support the combined weight of all IP DSLAM.

>> The connections and equipment that supply power to the IP DSLAM should be capable of operating safely with the maximum power requirements of the IP DSLAM. In the event of a power overload, the supply circuits and supply wiring should not become hazardous.

>> The AC power cord must plug into the right supply voltage. Make sure that the supplied AC voltage is correct and stable. If the input AC voltage is over 10% lower than the standard may cause the IP DSLAM to malfunction.

>> Generally, when installed after the final configuration, the product must comply with the applicable safety standards and regulatory requirements of the country in which it is installed. If necessary, consult for technical support.

>> A rare condition can create a voltage potential between the earth grounds of two or more buildings. If products installed in separate building are interconnected, the voltage potential can cause a hazardous condition. Consult a qualified electrical consultant to determine whether or not this phenomenon exists and, if necessary, implement corrective action before interconnecting the products. If the equipment is to be used with telecommunications circuit, take the following precautions:

- Never install telephone wiring during a lightning storm.
  - Never install telephone jacks in wet location unless the jack is specially - designed for wet location.
  - Never touch uninsulated telephone wires or terminals unless the telephone line has been disconnected at the network interface.
  - Use caution when installing or modifying telephone lines (other than a cordless telephone) during an electrical storm. There is a remote risk of electric shock from lightning.
  - Do not use a telephone or other equipment connected to telephone lines to report a gas leak in the vicinity of the leak.



## 2.2 Hardware Installation

The PLANET IDL series can be installed in a standard 19-inch rack by using the mounting brackets provided. Mount the shelf on the rack using the large screws provided. The procedure to connect and wire the system is as follows.

### 2.2.1 System Requirements

- Workstation with Windows NT/2000/XP
- RJ-45 cables
- RJ-11 cables
- Telco-50 cables
- RS-232 cables
- <Optional> MDF Patch Panel (Model No.: IDL-PAN-48).

### 2.2.2 Rear Panel Connection

The following figure shows the rear panel connection of IDL series:

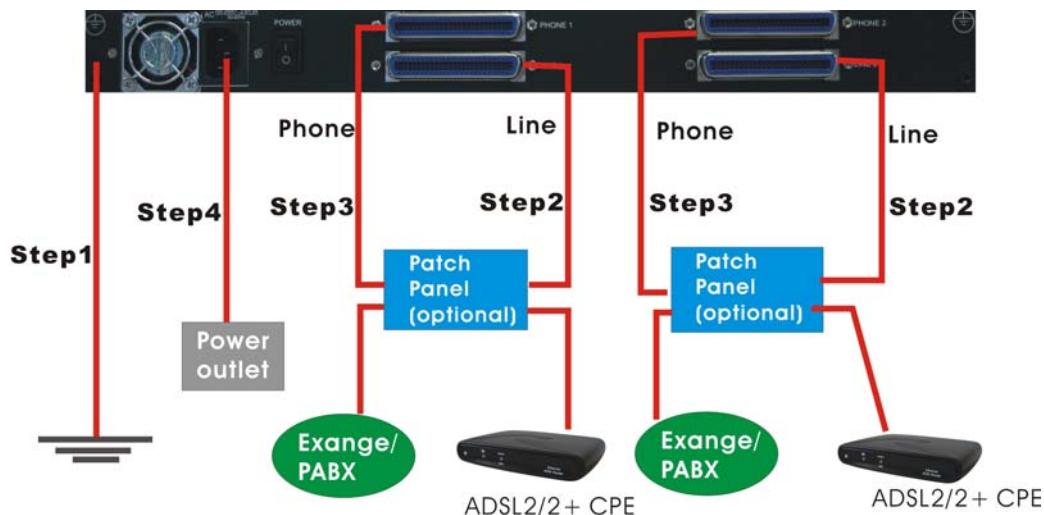

**Step 1:** Ground the IP DSLAM by connecting a grounded wire (Optional).

**Step 2:** Connect the ADSL line connector, a 50-pin centronic connector, of IP DSLAM to CPE by using telco cable. Each line connector supports 24 ports of ADSL/ADSL2/ADSL2+ for Data path from MDF (Main Distribution Frame).

**Step 3:** Connect the Phone connector, a 50-pin centronic connector, of IP DSLAM to Exchange/PBX by using telco cable. Phone connector is an optional module supporting Voic path to Exchange/PBX; it must be along with Line Connector.

---

**Note:**

1. The MDF Patch panel is optional to standard package.

---

**Step 4:** Hook power cord and apply the power.

### 2.2.3 Front Panel Connection

The following figure shows the front panel connection of IDL series:



**UPLINK:** Connect to Internet or downlink to the other IDL-series for stacking by RJ-45 cable.

**MGNT:** Connect to PC by RJ-45 cable in order to administer your IP DSLAM through IDL Manager.

**CID:** Connect to PC by RS-232 cable in order to administer your IP DSLAM through CLI.

## 2.3 IDL Manager Installation

---

This following shows how to prepare the system to perform basic communication functions through IDL Manager.

### 2.3.1 System Requirements

- Windows NT/2000/XP
- CD-ROM
- Ethernet card
- 2GB Hard disk with a minimum of 650MB of free space
- Super VGA (800x600 resolution) or higher with 256 colors
- Manual CD

### 2.3.2 Installing IDL Manager

Perform initial configuration procedures as follows:

1. Insert CD into CD-ROM.
2. From the autorun screen, click the “IDL Manager” hyperlink to download the file. And then click “setup.exe” to start the installation process.
3. The welcome window appears. Click on “**Next**” to continue.

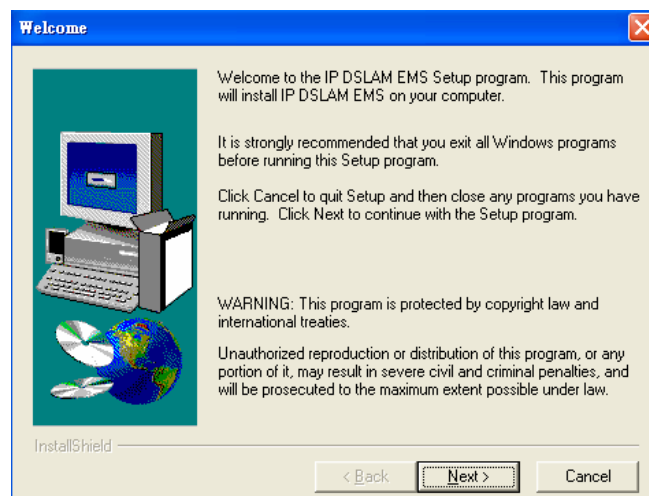

4. When the Start Copying Files window appears, you can confirm the current settings. Click on “**Next**” to start copying files.

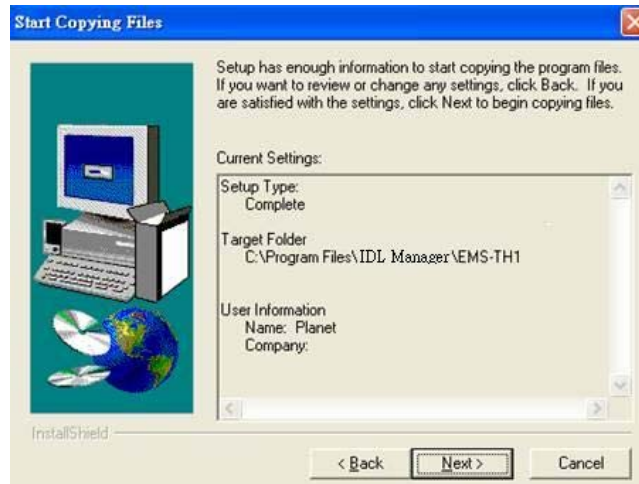

5. When Setup Process Status window appears, the installation process is now in progress. This window displays a bar indicating the percentage of completion for the current installation. In addition, the names of the files being installed appear above the bar until the installation is complete.

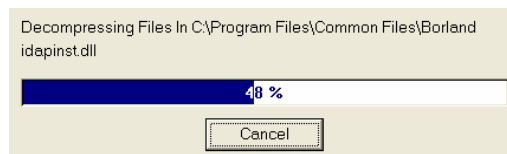

6. At the end of the installation process, the following Setup Complete window presents. Simply click on “**Finish**” to complete setup. Now the installation of IDL Manager is completed.

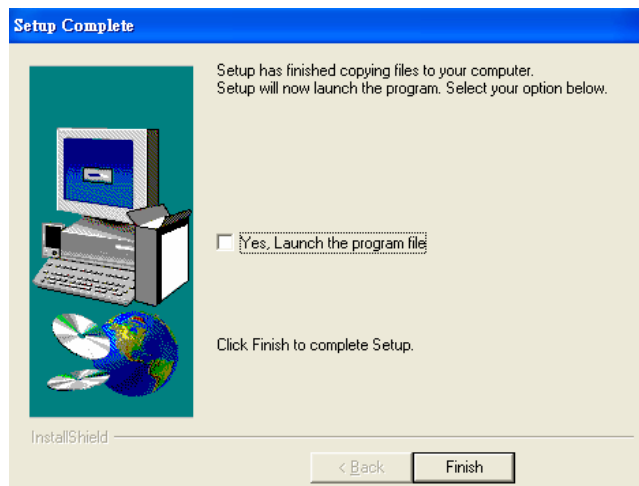

### 2.3.3 Starting IDL Manager

Perform basic communication functions through IDL Manager, procedures as follows:

1. Users can activate the IDL Manager either from Program manager or clicking the shortcut icon on the desktop as below.



2. Before starting to IDL Manager, it is necessary that your PC's IP and IP DSLAM's IP are in the same subnet.

---

**Note:**

Default IP address of Management port is **192.168.200.111**.

---

3. To enable SNMP for accessing, one needs to issue commands below to IDL series by Telnet to management port or connecting to console port (9600, N, 8,1) and then log in with default username and password that both are "**admin**".
  - a. "\$create snmp comm community public rw".
  - b. "\$create snmp host ip 192.168.200. xxx community public", where 192.168.200.xxx is the IP of your PC.
  - c. "\$create snmp trap host ip 192.168.200.xxx community public version v1", where 192.168.200.xxx is the IP of your PC.
4. Launch the IDL Manager and then log in with the user name and password.

Click on "OK" to enter the IDL Manager system.

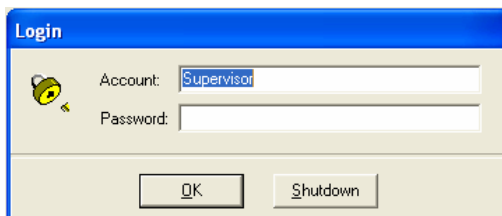

---

**Note:**

Default Username is "**Supervisor**" and password is blank.

---

5. After launching IDL Manager and logging in, the main window appears as below.

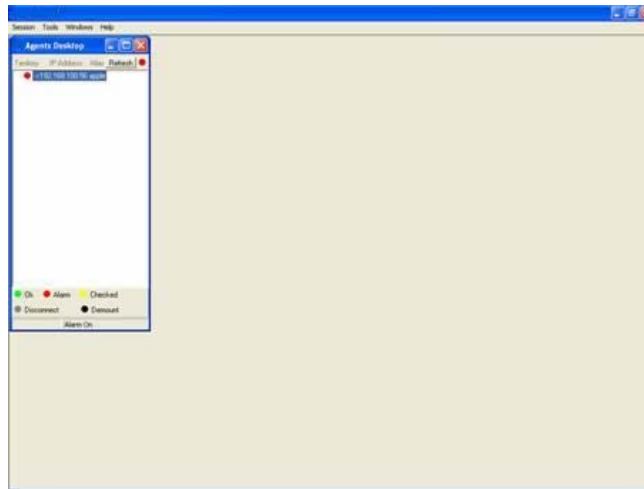

## 2.4 IDL Manager Functions

---

IDL Manager is divided into the task-oriented functional groups as follows.

### 2.4.1 Session

Allow you to start and to terminate a session as well as to shutdown the system.

#### 2.4.1.1 Logout

To terminate the current session, choose Logout command from Session Menu. The user account, then, is logged out and Login window prompts for a new login. Normally, this is used when a user wants to re-login in order to gain a higher level of authority for certain operations.

#### 2.4.1.2 Exit

To terminate the system at any time, simply choose the Exit command from Session Menu. The system then terminates.

## 2.4.2 Tools

This chapter describes how to use tools in the IDL Manager, including Environmental options, Territory manager, Agent manager, User Manager and Telnet, which are detailed in the following sections.



### 2.4.2.1 Environment Options

Choose Environmental Options from Tools Menu, user can define SNMP, Desktop and Surveillance respectively.

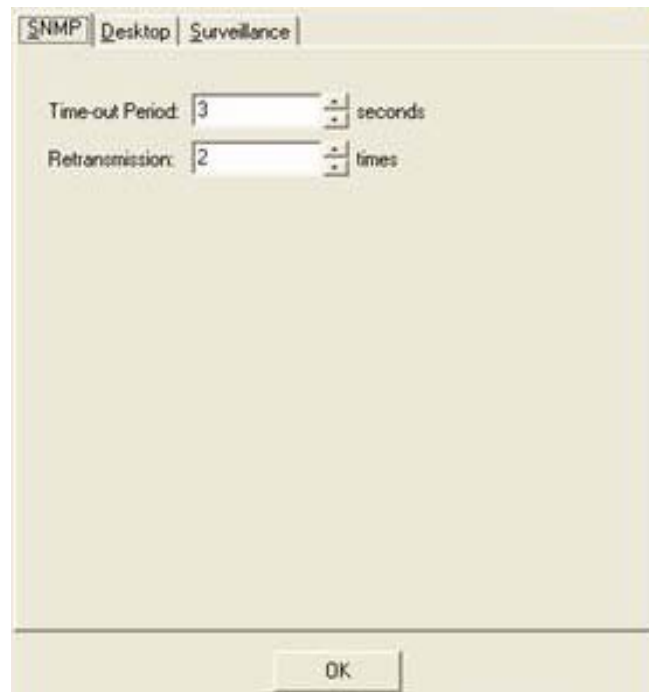
#### 1. SNMP Configuration

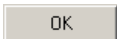

The SNMP Time-out Period and Retransmission times can be configured as shown in the following steps:

- a. Click on the TabControl of "SNMP" that will bring SNMP dialogue box to front.
- b. Click on  /  to change the Time-out Period seconds and Retransmission times.
- c. Click on  to submit your changes.

#### 2. Desktop Configuration



The Desktop is user for setting the map of a required territory.

- a. Click on the tab of “Desktop” that will bring Desktop dialogue box to front.
- b. Click on  to quick start territory manager in which users can define a desired territory. Please refer to “Territory Manager Configuration” for more details.
- c. Click on  to load the map of a territory or click on  to clear a loaded map.



---

**Note:**

The format of map is limited to \*.bmp, \*.emf and \*.wmf.



---

- d. Click on  to submit your setting, and then the map will apply to the Mounted Agent.



### 3. Surveillance Configuration





- a. Click on the tab of “Surveillance” that will bring the Surveillance dialogue box to front.
- b. Click on  or  to change the monitor period.
- c. Select the checkbox of **Save expired records** to save surveillance archive, which can be browsed by clicking on the tab of **Achieved** in the Event Log window as shown in the following figure.

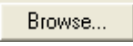

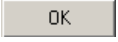
- d. Clicking on  to choose the directory to record surveillance data and press  or  to define expired period.
- e. Click on  to submit your settings.

## 2.4.2.2 Territory Manager

Territory manager help users to build up monitoring territories and agents could be categorized into different territories by users. Territory manager can be activated either from menu bar or from environmental options.

### Territory Manager Window

Choose Territory Manager via Tools Menu, or Environmental option, and then the Territory Management window appears.

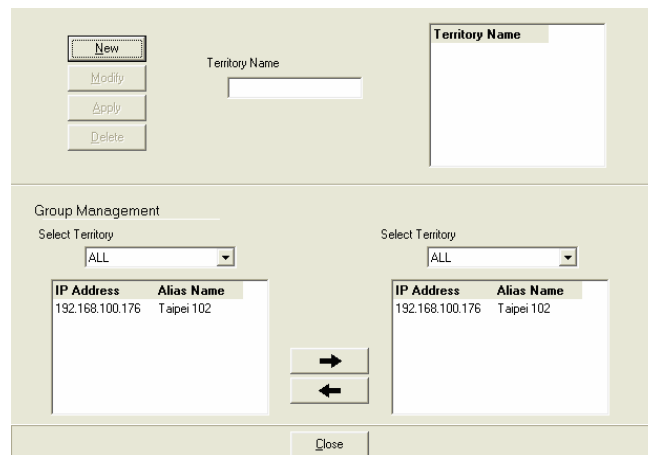

If to add a territory to the system,

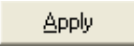
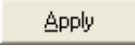
- Click on , the Territory Name fields then cleared to blank for entering the data.
- Enter Territory Name and  then become enable.
- Click on  to apply the territory to the system. After that, you can proceed to group management by Territory Management dialog box.

As the following figure shown, the agent, 192.168.100.176 is available in the territory named ALL on the left. Users can shift the monitoring territory from ALL to Taipei simply by selecting Taipei in the Drop-down list on the right.

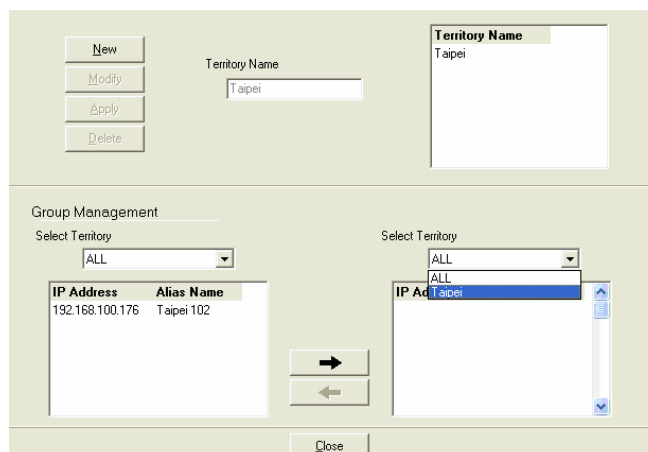

- d. Choose the agent, 192.168.100.176 on the left and then click on . The agent IP will appear on the right and will be monitored under the territory, Taipei.

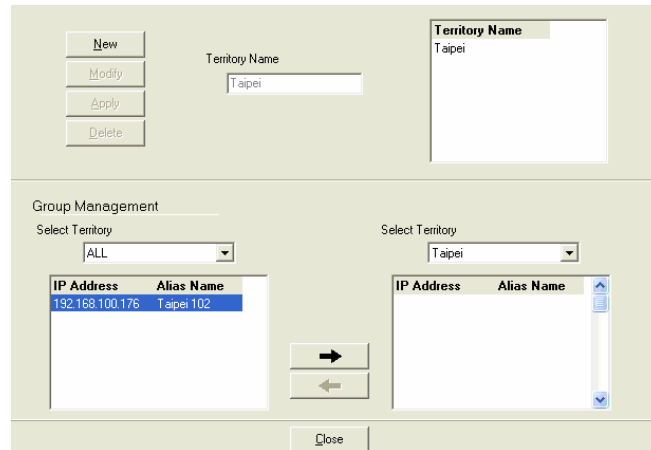

- e. If users want to move the agent IP from Taipei to other territory, select a desired agent IP and click on  to shift it to the left.

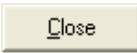
- f. Click on  to exit the window or continue to perform other operations in the same window.

Correspondently, the Agent Desktop displays that Agent IP 192.168.100.176 has been monitored under the territory, Taipei.



### 2.4.2.3 Agent Manager

All of the IP DSLAM agents that are to be managed by the IDL Manager must be “registered” to the system. The “registration” process is to make the system aware of agent’s IP address and alias name. Once an agent is registered, it is put into the “demount” agent pool, which is still “inactive” for the network monitor. You then have to activate it if you want it to be monitored. An active agent can also be deactivated from the monitor for certain operational purpose when necessary. Agent Manager is designed for you to perform these operations.

#### Agent Manager Window

Choose Agent Manager from Tools Menu, this window then appears.

| Field       | Definition       |
|-------------|------------------|
| IP Address  | ***.***.***.***  |
| Alias name  | Name of IP DSLAM |
| Description | Note             |



If to add an agent to the system,

- Select a territory that a new agent belongs to. Click on to activate territory manager.
- Click on , the data fields then cleared to blank for entering the data. Enter values in fields, IP Address, Alias Name and Description. The Apply buttons to the left of these fields then become enable.
- Click on to apply the agent to the system.
- If to activate (so-called “Mount”) the system’s monitoring of an agent, click on the required agent entry in the Demount agent list, then click on . The agent will appear on the Mount agent list on the right.
- Click on to exit the window or continue to perform other operations.

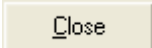
If to remove an agent to the system,

- a. Click the required agent in the Demount agent list, and then click on . The agent will disappear.
- b. Click on  to exit the window or continue to perform other operations in the same window.

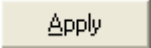
If to change the information of an agent,

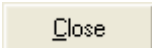
- a. Select the required agent in the Demount agent list. The information of the selected agent will then presented on the data fields.
- b. Click on  to Change IP, Alias Name, and Description and then  becomes enable.
- c. Click on  to apply the change to the system.
- d. Click on  to exit the window.

---

**Note:**

User can only change alias and description of the agent in the Mount agent list and changing IP is prohibited.

---

If to activate the system's monitoring of an agent,

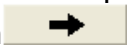
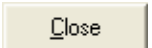
- a. Select the required agent in the Demount agent list, and then click on the Mount button . The agent will appear on the Mount agent list.
- b. Click on  to exit the window or continue to perform other operations in the same window.

If to de-activate the system's monitoring of an agent,

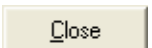
- a. Select the required agent in the Mount agent list, and then click on the Demount button . The agent will then disappears from the Mount agent list and appears on the Demount agent list on the left.
- b. Click on  to exit the window.

## 2.4.2.4 Telnet

Users can use the Telnet to connect to a specific IP DSLAM, and then monitor and interact with the system.

How to activate Telnet from Agent Desktop?

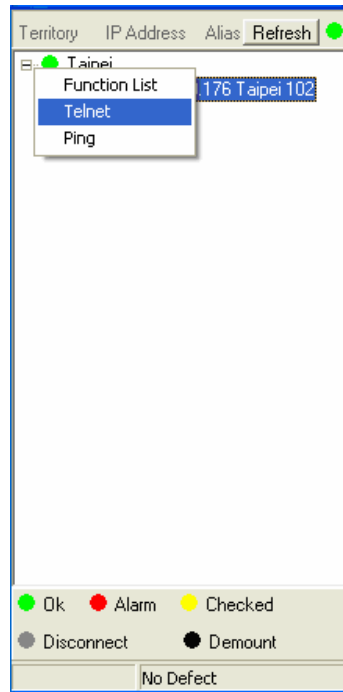

- a. Select an agent IP on the Agent desktop.
- b. Click on the right button of mouse and then select Telnet or choose Telnet from tool menu in the IDL Manager window's menu bar. Then Telnet screen will come up immediately.

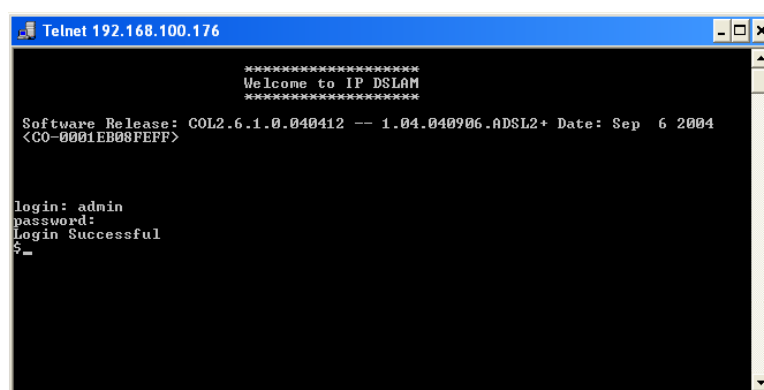

- c. Enter user name and password to access the CID screen.

---

### Note:

The default login and password are admin.

---

## 2.4.2.5 PING

Ping is a command used to determine whether a particular IP DSLAM is currently connected to the agent. It works by sending a packet to the specific IP address and waiting for reply.

How to activate PING from Agent Desktop?

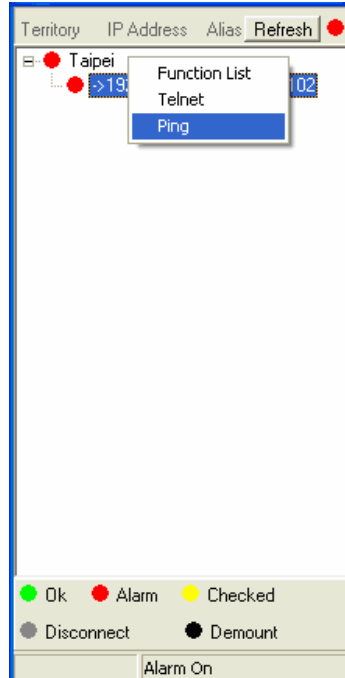

- a. Select an agent IP on the Agent desktop.
- b. Click on the right button of mouse and then select Ping or choose it from tool menu in the IDL Manager window's menu bar. Ping screen will come up immediately and then starts to send packets to check the connection with the IP DSLAM.

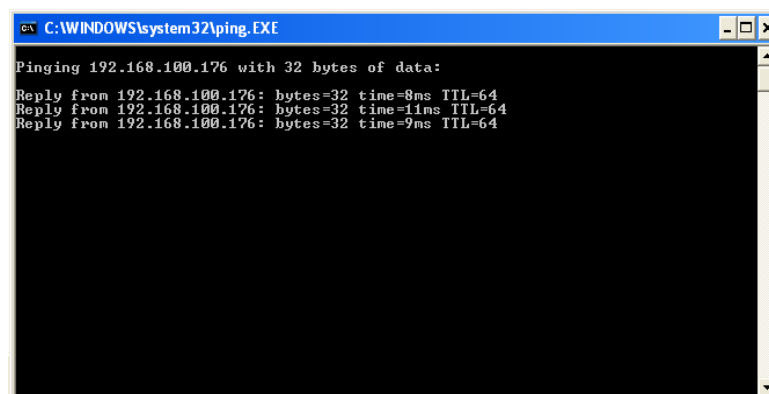

- c. After showing the connection status, the screen will be closed automatically.

## 2.4.2.6 User Manager

The IDL Manager uses user accounts, password as well as power level (system privileges) to control access and log in. There are three types of privileges, Supervisor, Constructor and Tester.

### **Supervisor:**

The highest level user with this privilege can access ANY functions and data.

### **Constructor:**

User can set and modify the configuration of network equipments.

### **Tester:**

User can run maintenance test, such as loop back function.

To perform user manager, proceed as follows,

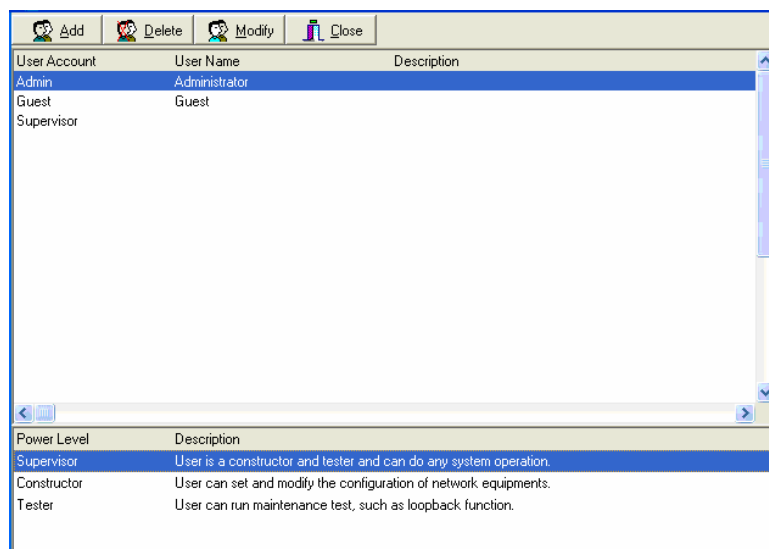

Choose User Manager from Tools Menu to access this window. From the following window, User Manager, you can add and remove users as well as change passwords, which are used to control the login.





| Field        | Definition                           |
|--------------|--------------------------------------|
| User Account | an ID to be used for login           |
| User Name    | The full name of a user              |
| Description  | Remarks for note purpose             |
| Power Level  | Privileges; Administrator and Tester |





If to add a User Account to the system,

- a. Click on , the Security window then prompts.
- b. Enter the account information as described in Security window below.
- c. Click on  to exit the window or continue to perform other operations.

If to remove a User Account from the system,

- a. Select a user account by clicking on the desired entry in User Account selection list. After selection, the designated one will be highlighted.
- b. Click on  to delete it.
- c. Click on  to exit the window or continue to perform other operations.

If to change User Account information,

- a. Select a user account by clicking on the desired entry in User Account selection list. After selection, the designated one will be highlighted.
- b. Click on  button, the Security window then prompts.
- c. Change the account information as described in Security window below.
- d. Click on  button to exit the window or continue to perform other operations. Or click on  button, the Security window then prompts.

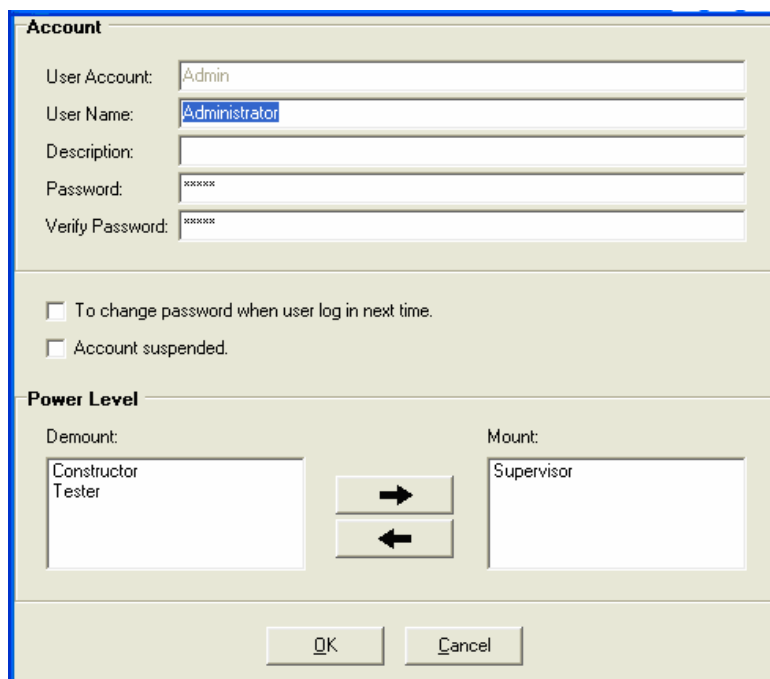





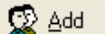

The screenshot shows a window titled "Account" with the following fields and options:

- User Account: Admin
- User Name: Administrator
- Description: (empty)
- Password: (masked with xxxxxx)
- Verify Password: (masked with xxxxxx)
- To change password when user log in next time.
- Account suspended.
- Power Level**
- Demount: Constructor, Tester
- Mount: Supervisor
- Buttons: OK, Cancel

| Field                              | Definition  |
|------------------------------------|---|
| User Account                       | An ID to be used for login  |
| User Name                          | The full name of a user   |
| Description                        | Remark for note purpose   |
| Password                           | Any character string, including blank   |
| Verify Password                    | Re-enter the password as a confirmation   |
| To change password when next login | If this is checked, the associated user needs to change their password at the next login. |
| Account Suspended                  | Suspend the account.  |
| Power Level                        | Privileges; Administrator and tester  |

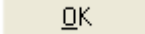
This window is a daughter window of User Manager Window, and is used when adding a user account or changing account information.

- a. Either  Add or  Modify is selected, this window appears.
- b. Enter data in the fields, User Account, User Name, Description, and Password as required. Re-enter the password in field, Verify Password, for purpose of verification.
- c. If to force the user to change their password at the next login, click on the checkbox to the left of the field, To Change Password When Login Next Time.
- d. If to suspend a user account, click on the checkbox to the left of the field, Account Suspended.
- e. If to assign a new Power Level to the user, click on the desired entry in the Demount list, then click on the Mount button, . The selected Power Level entry will then be added to the Mount list on the right.
- f. If to remove a Power Level from the user, click on the desired entry in the Mount list on the right, then click on the Demount button, . The selected Power Level entry will then be removed.
- g. Click on  OK to complete the operation or  Cancel to abort the change. Either one is selected; the window is exited to User Manager Window.

## 2.4.3 Windows

Users may open many daughter windows in the IDL Manager. To benefit user's viewing every Window, Commands of the Windows menu is designed to arrange daughter windows. Those commands will be introduced separately.

### 2.4.3.1 Cascade

Choose **Cascade** from Windows menu in the IDL Manager menu bar. The cascade command can cascade those opened windows as follows. User can select a window to perform operations or view status simply by clicking on a specified window.

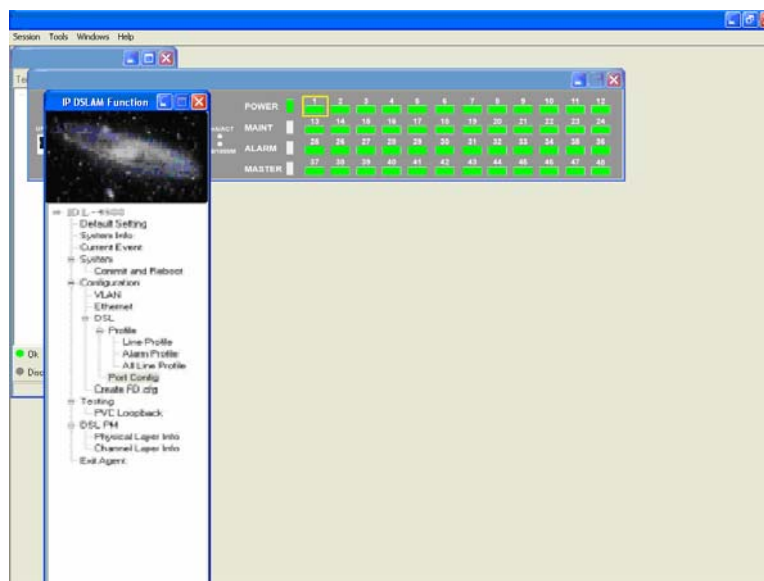

### 2.4.3.2 Next Window

Next Window helps user to view next window so that it will bring the window in the second layer to front.

### 2.4.3.3 Previous Window

Previous Window command can help user to bring the previous window to front.

### 2.4.3.4 Arrange Icons

By selecting Arrange Icons of Windows Menu in the menu bar, it will locate those minimized daughter windows in the bottom left of IDL Manager Window as the following figure shown. User can select a required icon to perform IDL Manager Management.

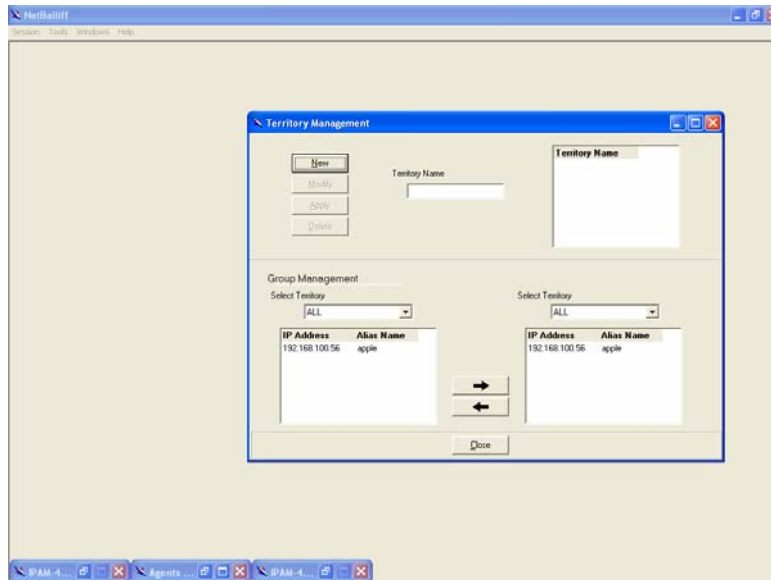

## 2.4.4 Help

Allow users to view the software version.

### 2.4.4.1 About

To view the version of IDL Manager, choose “About” command via Help menu, as shown in the following figure. Click on  to exit the window.



## 3. IDL Manager Management

After successfully setting up the environment of IDL Manager, you can manage different IP DSLAM via your IDL Manager remotely. This chapter will tell you how to interact with a specified IP DSLAM.





### 3.1 Agent Desktop

Agent Desktop is the main window for the network administrators in performing their day-to-day network monitoring jobs. Like the standard desktop of MS Windows, Agent Desktop appears once the system is started. First appears on the Agent Desktop is the status of agents by an array of colors. By which you may monitor the status of agents, and judge if they are normal or in situations of alarms. You may then double click on the required agent IP to activate the event log window. Similarly, the Mounted Agents Desktop can be started up by double clicking on the icon of territory.

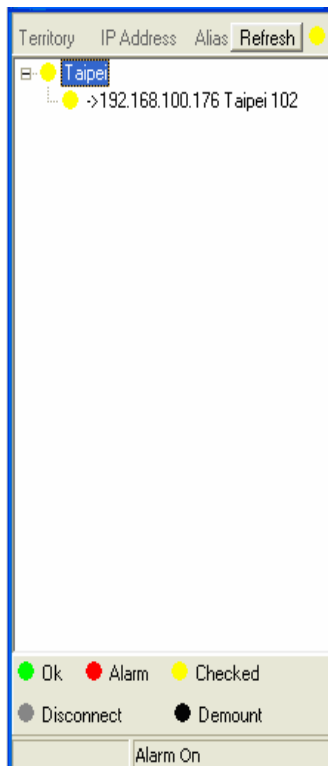
#### 3.1.1 Agent Desktop Window

In the Agents Desktop, press **Refresh** to refresh the status of all agents.



|   |   |
|---|---|
|  | Gray icon indicates that the agent is disconnected.   |
|  | Green icon indicates that the agent is in normal condition.   |
|  | Red icon indicates that "Major Alarm" is occurred to the agent and requires network administrator's attention. Network administrator pays attention to alarms by looking into the alarms using Event Log – Outstanding. |
|  | The red icon will turn into a yellow icon after the network administrator has looked into the alarms. However, this does not mean the situation is released. If any new alarm happens, yellow will turn red.            |
|  | Black icon indicated that the agent is demounted.   |

### 3.1.2 Mounted Agent Desktop

Mounted agent desktop provides users with flexibility in viewing your network using graphical presentation of network elements. Mounted agent desktop can be easily activated by double clicking the icon of territory in the agent desktop and appears promptly as shown in the following figure. By the mounted agent desktop, the location of agents and overall network status of a specific territory is presented.

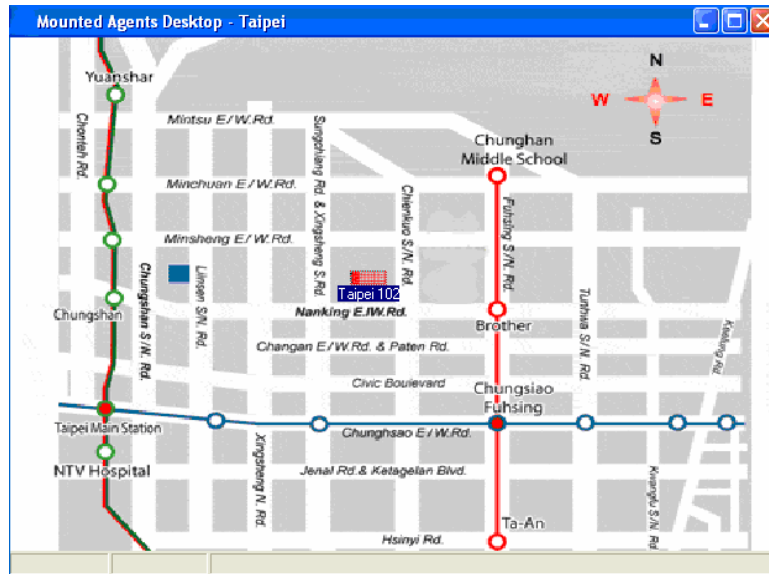

**Taipei 102**: This icon can be moved to where the agent is located in the map. In addition, its color also changes with the status of the agent. For example, the icon in red means that alarm is occurred to the agent and requires network administrator's attention.

## 3.2 Active Function Management Windows

Via IDL Manager, users can remotely monitor the current status of a specified IP DSLAM, and then proceeding advanced configuration. To activate the function management windows, choose a specified agent that you want to manage, and then double click the agent. After that, the function management windows, including Function window and Front panel status window, will prompt as shown in the following figure.

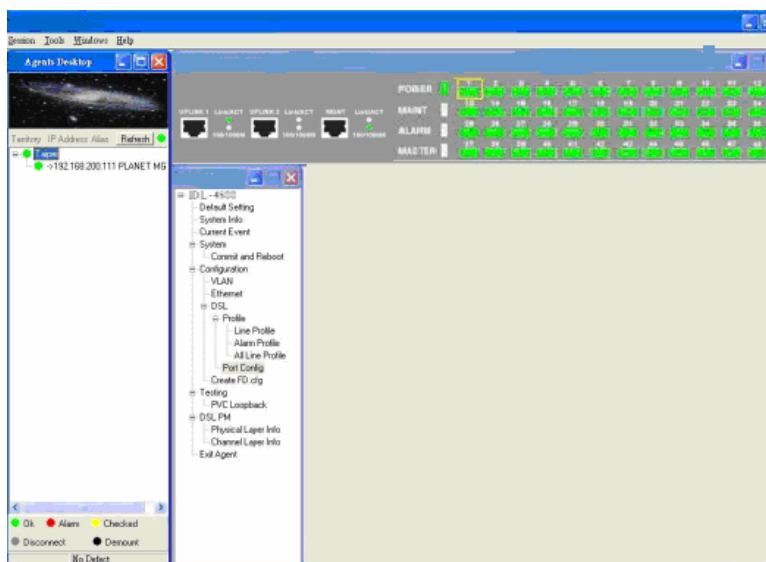

The Function management windows include Function List Window and Front Panel Status Window which are provided to monitor the status in real time and configure related settings.

### 3.2.1 Function List Window

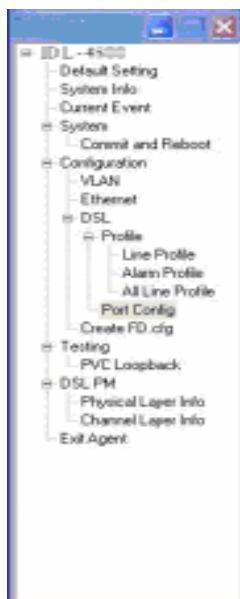

From the Function List Window, users can activate a specified function immediately by double clicking a specified item.

### 3.2.2 Front Panel Status Window

After choosing a specified agent, the Front Panel Status Window, together with the Function Window, will come out immediately to present the current status of front panel of the IP DSLAM.

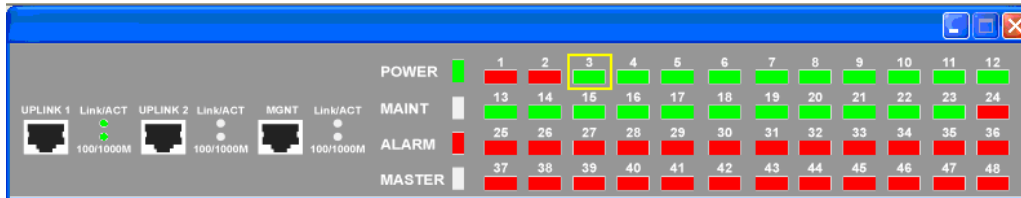

### 3.3 Default Setting

This section describes how to get the information of the default setting of the IP DSLAM. Click on "Default Setting" from the Function List window. The window appears as follows.

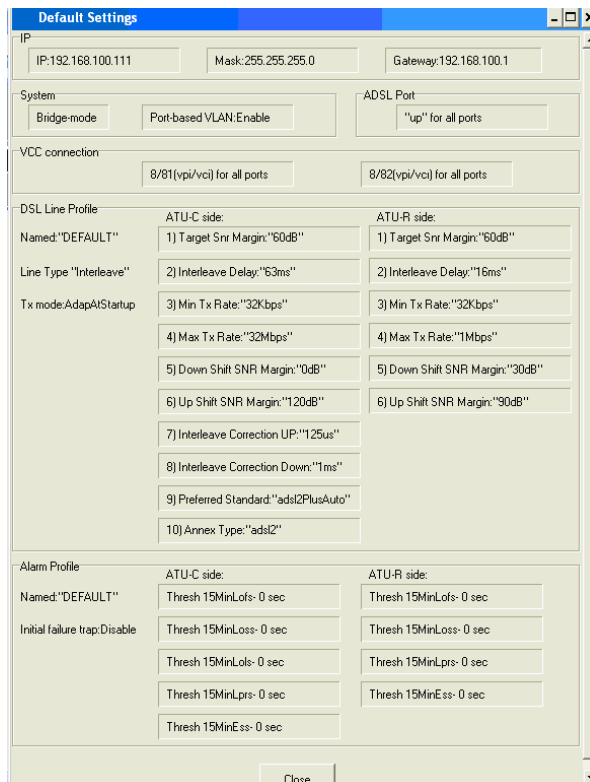

In the default setting window, the status of, IP, System, VCC connection, DSL line profile and Alarm profile are displayed clearly. How to modify them will be introduced in the following sections.



### 3.4 System Information

This section describes how to get and input the information of the IP DSLAM. Double Click on “System Information” from the Function List Window. The window appears as follows.

| Field                               | Definition   |                                     |                                     |           |                        |                       |                             |                      |           |                               |                       |                      |                       |                          |                          |                           |                       |                          |                       |                          |                                 |                        |                                     |                             |          |                   |                                  |                      |                       |            |                       |                   |                                     |                      |                                    |                               |                                    |                        |                                    |                        |                                     |                     |                             |                       |                   |                               |                                 |                      |                              |
|-------------------------------------|--|-------------------------------------|-------------------------------------|-----------|------------------------|-----------------------|-----------------------------|----------------------|-----------|-------------------------------|-----------------------|----------------------|-----------------------|--------------------------|--------------------------|---------------------------|-----------------------|--------------------------|-----------------------|--------------------------|---------------------------------|------------------------|-------------------------------------|-----------------------------|----------|-------------------|----------------------------------|----------------------|-----------------------|------------|-----------------------|-------------------|-------------------------------------|----------------------|------------------------------------|-------------------------------|------------------------------------|------------------------|------------------------------------|------------------------|-------------------------------------|---------------------|-----------------------------|-----------------------|-------------------|-------------------------------|---------------------------------|----------------------|------------------------------|
| Name                                | Alias name of the IP DSLAM   |                                     |                                     |           |                        |                       |                             |                      |           |                               |                       |                      |                       |                          |                          |                           |                       |                          |                       |                          |                                 |                        |                                     |                             |          |                   |                                  |                      |                       |            |                       |                   |                                     |                      |                                    |                               |                                    |                        |                                    |                        |                                     |                     |                             |                       |                   |                               |                                 |                      |                              |
| Location                            | Location of the IP DSLAM   |                                     |                                     |           |                        |                       |                             |                      |           |                               |                       |                      |                       |                          |                          |                           |                       |                          |                       |                          |                                 |                        |                                     |                             |          |                   |                                  |                      |                       |            |                       |                   |                                     |                      |                                    |                               |                                    |                        |                                    |                        |                                     |                     |                             |                       |                   |                               |                                 |                      |                              |
| Contact                             | The contact person of the IP DSLAM   |                                     |                                     |           |                        |                       |                             |                      |           |                               |                       |                      |                       |                          |                          |                           |                       |                          |                       |                          |                                 |                        |                                     |                             |          |                   |                                  |                      |                       |            |                       |                   |                                     |                      |                                    |                               |                                    |                        |                                    |                        |                                     |                     |                             |                       |                   |                               |                                 |                      |                              |
| Vendor                              | The vendor of the IP DSLAM   |                                     |                                     |           |                        |                       |                             |                      |           |                               |                       |                      |                       |                          |                          |                           |                       |                          |                       |                          |                                 |                        |                                     |                             |          |                   |                                  |                      |                       |            |                       |                   |                                     |                      |                                    |                               |                                    |                        |                                    |                        |                                     |                     |                             |                       |                   |                               |                                 |                      |                              |
| Object ID                           | Vendor ID  |                                     |                                     |           |                        |                       |                             |                      |           |                               |                       |                      |                       |                          |                          |                           |                       |                          |                       |                          |                                 |                        |                                     |                             |          |                   |                                  |                      |                       |            |                       |                   |                                     |                      |                                    |                               |                                    |                        |                                    |                        |                                     |                     |                             |                       |                   |                               |                                 |                      |                              |
| DST                                 | Daylight Savings Time has been enabled or not.   |                                     |                                     |           |                        |                       |                             |                      |           |                               |                       |                      |                       |                          |                          |                           |                       |                          |                       |                          |                                 |                        |                                     |                             |          |                   |                                  |                      |                       |            |                       |                   |                                     |                      |                                    |                               |                                    |                        |                                    |                        |                                     |                     |                             |                       |                   |                               |                                 |                      |                              |
| UpTime                              | System up time   |                                     |                                     |           |                        |                       |                             |                      |           |                               |                       |                      |                       |                          |                          |                           |                       |                          |                       |                          |                                 |                        |                                     |                             |          |                   |                                  |                      |                       |            |                       |                   |                                     |                      |                                    |                               |                                    |                        |                                    |                        |                                     |                     |                             |                       |                   |                               |                                 |                      |                              |
| HwVersion                           | Hardware version of the IP DSLAM.  |                                     |                                     |           |                        |                       |                             |                      |           |                               |                       |                      |                       |                          |                          |                           |                       |                          |                       |                          |                                 |                        |                                     |                             |          |                   |                                  |                      |                       |            |                       |                   |                                     |                      |                                    |                               |                                    |                        |                                    |                        |                                     |                     |                             |                       |                   |                               |                                 |                      |                              |
| CPSwVersion                         | Control plant version  |                                     |                                     |           |                        |                       |                             |                      |           |                               |                       |                      |                       |                          |                          |                           |                       |                          |                       |                          |                                 |                        |                                     |                             |          |                   |                                  |                      |                       |            |                       |                   |                                     |                      |                                    |                               |                                    |                        |                                    |                        |                                     |                     |                             |                       |                   |                               |                                 |                      |                              |
| Log Threshold                       | The severity level of the trap equal to or lower than that shall be logged. 0 represents log threshold is disabled. 1 is the lowest and represents critical traps. <b>Valid values:</b> 0-4  |                                     |                                     |           |                        |                       |                             |                      |           |                               |                       |                      |                       |                          |                          |                           |                       |                          |                       |                          |                                 |                        |                                     |                             |          |                   |                                  |                      |                       |            |                       |                   |                                     |                      |                                    |                               |                                    |                        |                                    |                        |                                     |                     |                             |                       |                   |                               |                                 |                      |                              |
| Time Zone                           | <p><b>Valid values:</b> Given below, are the valid values, followed by their descriptions.</p> <table border="0"> <tr> <td>IDLW - International Date Line West</td> <td>EET - Eastern Europe, Russia Zone 1</td> </tr> <tr> <td>NT - Nome</td> <td>IST - Israeli Standard</td> </tr> <tr> <td>HST - Hawaii Standard</td> <td>BT - Baghdad, Russia Zone 2</td> </tr> <tr> <td>CAT - Central Alaska</td> <td>IT - Iran</td> </tr> <tr> <td>AHST - Alaska-Hawaii Standard</td> <td>ZP4 - "Russia Zone 3"</td> </tr> <tr> <td>YST - Yukon Standard</td> <td>ZP5 - "Russia Zone 4"</td> </tr> <tr> <td>PST- US Pacific Standard</td> <td>INST - "Indian Standard"</td> </tr> <tr> <td>MST- US Mountain Standard</td> <td>ZP6 - "Russia Zone 5"</td> </tr> <tr> <td>CST- US Central Standard</td> <td>NST - "North Sumatra"</td> </tr> <tr> <td>EST- US Eastern Standard</td> <td>WAST - West Australian Standard</td> </tr> <tr> <td>AST- Atlantic Standard</td> <td>SSMT - South Sumatra, Russia Zone 6</td> </tr> <tr> <td>NFST- Newfoundland Standard</td> <td>JT- Java</td> </tr> <tr> <td>NFT- Newfoundland</td> <td>CCT - China Coast, Russia Zone 7</td> </tr> <tr> <td>BRST-Brazil Standard</td> <td>ROK - Korean Standard</td> </tr> <tr> <td>AT- Azores</td> <td>KST - Korean Standard</td> </tr> <tr> <td>WAT - West Africa</td> <td>JST - Japan Standard, Russia Zone 8</td> </tr> <tr> <td>GMT - Greenwich Mean</td> <td>CAST - Central Australian Standard</td> </tr> <tr> <td>UTC - Universal (Coordinated)</td> <td>EAST - Eastern Australian Standard</td> </tr> <tr> <td>WET - Western European</td> <td>GST - Guam Standard, Russia Zone 9</td> </tr> <tr> <td>CET - Central European</td> <td>IDLE - International Date Line East</td> </tr> <tr> <td>FWT - French Winter</td> <td>NZST - New Zealand Standard</td> </tr> <tr> <td>MET - Middle European</td> <td>NZT - New Zealand</td> </tr> <tr> <td>MEWT - Middle European Winter</td> <td>Example: IDLW , that stands for</td> </tr> <tr> <td>SWT - Swedish Winter</td> <td>International Date Line West</td> </tr> </table> | IDLW - International Date Line West | EET - Eastern Europe, Russia Zone 1 | NT - Nome | IST - Israeli Standard | HST - Hawaii Standard | BT - Baghdad, Russia Zone 2 | CAT - Central Alaska | IT - Iran | AHST - Alaska-Hawaii Standard | ZP4 - "Russia Zone 3" | YST - Yukon Standard | ZP5 - "Russia Zone 4" | PST- US Pacific Standard | INST - "Indian Standard" | MST- US Mountain Standard | ZP6 - "Russia Zone 5" | CST- US Central Standard | NST - "North Sumatra" | EST- US Eastern Standard | WAST - West Australian Standard | AST- Atlantic Standard | SSMT - South Sumatra, Russia Zone 6 | NFST- Newfoundland Standard | JT- Java | NFT- Newfoundland | CCT - China Coast, Russia Zone 7 | BRST-Brazil Standard | ROK - Korean Standard | AT- Azores | KST - Korean Standard | WAT - West Africa | JST - Japan Standard, Russia Zone 8 | GMT - Greenwich Mean | CAST - Central Australian Standard | UTC - Universal (Coordinated) | EAST - Eastern Australian Standard | WET - Western European | GST - Guam Standard, Russia Zone 9 | CET - Central European | IDLE - International Date Line East | FWT - French Winter | NZST - New Zealand Standard | MET - Middle European | NZT - New Zealand | MEWT - Middle European Winter | Example: IDLW , that stands for | SWT - Swedish Winter | International Date Line West |
| IDLW - International Date Line West | EET - Eastern Europe, Russia Zone 1  |                                     |                                     |           |                        |                       |                             |                      |           |                               |                       |                      |                       |                          |                          |                           |                       |                          |                       |                          |                                 |                        |                                     |                             |          |                   |                                  |                      |                       |            |                       |                   |                                     |                      |                                    |                               |                                    |                        |                                    |                        |                                     |                     |                             |                       |                   |                               |                                 |                      |                              |
| NT - Nome                           | IST - Israeli Standard   |                                     |                                     |           |                        |                       |                             |                      |           |                               |                       |                      |                       |                          |                          |                           |                       |                          |                       |                          |                                 |                        |                                     |                             |          |                   |                                  |                      |                       |            |                       |                   |                                     |                      |                                    |                               |                                    |                        |                                    |                        |                                     |                     |                             |                       |                   |                               |                                 |                      |                              |
| HST - Hawaii Standard               | BT - Baghdad, Russia Zone 2  |                                     |                                     |           |                        |                       |                             |                      |           |                               |                       |                      |                       |                          |                          |                           |                       |                          |                       |                          |                                 |                        |                                     |                             |          |                   |                                  |                      |                       |            |                       |                   |                                     |                      |                                    |                               |                                    |                        |                                    |                        |                                     |                     |                             |                       |                   |                               |                                 |                      |                              |
| CAT - Central Alaska                | IT - Iran  |                                     |                                     |           |                        |                       |                             |                      |           |                               |                       |                      |                       |                          |                          |                           |                       |                          |                       |                          |                                 |                        |                                     |                             |          |                   |                                  |                      |                       |            |                       |                   |                                     |                      |                                    |                               |                                    |                        |                                    |                        |                                     |                     |                             |                       |                   |                               |                                 |                      |                              |
| AHST - Alaska-Hawaii Standard       | ZP4 - "Russia Zone 3"  |                                     |                                     |           |                        |                       |                             |                      |           |                               |                       |                      |                       |                          |                          |                           |                       |                          |                       |                          |                                 |                        |                                     |                             |          |                   |                                  |                      |                       |            |                       |                   |                                     |                      |                                    |                               |                                    |                        |                                    |                        |                                     |                     |                             |                       |                   |                               |                                 |                      |                              |
| YST - Yukon Standard                | ZP5 - "Russia Zone 4"  |                                     |                                     |           |                        |                       |                             |                      |           |                               |                       |                      |                       |                          |                          |                           |                       |                          |                       |                          |                                 |                        |                                     |                             |          |                   |                                  |                      |                       |            |                       |                   |                                     |                      |                                    |                               |                                    |                        |                                    |                        |                                     |                     |                             |                       |                   |                               |                                 |                      |                              |
| PST- US Pacific Standard            | INST - "Indian Standard"   |                                     |                                     |           |                        |                       |                             |                      |           |                               |                       |                      |                       |                          |                          |                           |                       |                          |                       |                          |                                 |                        |                                     |                             |          |                   |                                  |                      |                       |            |                       |                   |                                     |                      |                                    |                               |                                    |                        |                                    |                        |                                     |                     |                             |                       |                   |                               |                                 |                      |                              |
| MST- US Mountain Standard           | ZP6 - "Russia Zone 5"  |                                     |                                     |           |                        |                       |                             |                      |           |                               |                       |                      |                       |                          |                          |                           |                       |                          |                       |                          |                                 |                        |                                     |                             |          |                   |                                  |                      |                       |            |                       |                   |                                     |                      |                                    |                               |                                    |                        |                                    |                        |                                     |                     |                             |                       |                   |                               |                                 |                      |                              |
| CST- US Central Standard            | NST - "North Sumatra"  |                                     |                                     |           |                        |                       |                             |                      |           |                               |                       |                      |                       |                          |                          |                           |                       |                          |                       |                          |                                 |                        |                                     |                             |          |                   |                                  |                      |                       |            |                       |                   |                                     |                      |                                    |                               |                                    |                        |                                    |                        |                                     |                     |                             |                       |                   |                               |                                 |                      |                              |
| EST- US Eastern Standard            | WAST - West Australian Standard  |                                     |                                     |           |                        |                       |                             |                      |           |                               |                       |                      |                       |                          |                          |                           |                       |                          |                       |                          |                                 |                        |                                     |                             |          |                   |                                  |                      |                       |            |                       |                   |                                     |                      |                                    |                               |                                    |                        |                                    |                        |                                     |                     |                             |                       |                   |                               |                                 |                      |                              |
| AST- Atlantic Standard              | SSMT - South Sumatra, Russia Zone 6  |                                     |                                     |           |                        |                       |                             |                      |           |                               |                       |                      |                       |                          |                          |                           |                       |                          |                       |                          |                                 |                        |                                     |                             |          |                   |                                  |                      |                       |            |                       |                   |                                     |                      |                                    |                               |                                    |                        |                                    |                        |                                     |                     |                             |                       |                   |                               |                                 |                      |                              |
| NFST- Newfoundland Standard         | JT- Java   |                                     |                                     |           |                        |                       |                             |                      |           |                               |                       |                      |                       |                          |                          |                           |                       |                          |                       |                          |                                 |                        |                                     |                             |          |                   |                                  |                      |                       |            |                       |                   |                                     |                      |                                    |                               |                                    |                        |                                    |                        |                                     |                     |                             |                       |                   |                               |                                 |                      |                              |
| NFT- Newfoundland                   | CCT - China Coast, Russia Zone 7   |                                     |                                     |           |                        |                       |                             |                      |           |                               |                       |                      |                       |                          |                          |                           |                       |                          |                       |                          |                                 |                        |                                     |                             |          |                   |                                  |                      |                       |            |                       |                   |                                     |                      |                                    |                               |                                    |                        |                                    |                        |                                     |                     |                             |                       |                   |                               |                                 |                      |                              |
| BRST-Brazil Standard                | ROK - Korean Standard  |                                     |                                     |           |                        |                       |                             |                      |           |                               |                       |                      |                       |                          |                          |                           |                       |                          |                       |                          |                                 |                        |                                     |                             |          |                   |                                  |                      |                       |            |                       |                   |                                     |                      |                                    |                               |                                    |                        |                                    |                        |                                     |                     |                             |                       |                   |                               |                                 |                      |                              |
| AT- Azores                          | KST - Korean Standard  |                                     |                                     |           |                        |                       |                             |                      |           |                               |                       |                      |                       |                          |                          |                           |                       |                          |                       |                          |                                 |                        |                                     |                             |          |                   |                                  |                      |                       |            |                       |                   |                                     |                      |                                    |                               |                                    |                        |                                    |                        |                                     |                     |                             |                       |                   |                               |                                 |                      |                              |
| WAT - West Africa                   | JST - Japan Standard, Russia Zone 8  |                                     |                                     |           |                        |                       |                             |                      |           |                               |                       |                      |                       |                          |                          |                           |                       |                          |                       |                          |                                 |                        |                                     |                             |          |                   |                                  |                      |                       |            |                       |                   |                                     |                      |                                    |                               |                                    |                        |                                    |                        |                                     |                     |                             |                       |                   |                               |                                 |                      |                              |
| GMT - Greenwich Mean                | CAST - Central Australian Standard   |                                     |                                     |           |                        |                       |                             |                      |           |                               |                       |                      |                       |                          |                          |                           |                       |                          |                       |                          |                                 |                        |                                     |                             |          |                   |                                  |                      |                       |            |                       |                   |                                     |                      |                                    |                               |                                    |                        |                                    |                        |                                     |                     |                             |                       |                   |                               |                                 |                      |                              |
| UTC - Universal (Coordinated)       | EAST - Eastern Australian Standard   |                                     |                                     |           |                        |                       |                             |                      |           |                               |                       |                      |                       |                          |                          |                           |                       |                          |                       |                          |                                 |                        |                                     |                             |          |                   |                                  |                      |                       |            |                       |                   |                                     |                      |                                    |                               |                                    |                        |                                    |                        |                                     |                     |                             |                       |                   |                               |                                 |                      |                              |
| WET - Western European              | GST - Guam Standard, Russia Zone 9   |                                     |                                     |           |                        |                       |                             |                      |           |                               |                       |                      |                       |                          |                          |                           |                       |                          |                       |                          |                                 |                        |                                     |                             |          |                   |                                  |                      |                       |            |                       |                   |                                     |                      |                                    |                               |                                    |                        |                                    |                        |                                     |                     |                             |                       |                   |                               |                                 |                      |                              |
| CET - Central European              | IDLE - International Date Line East  |                                     |                                     |           |                        |                       |                             |                      |           |                               |                       |                      |                       |                          |                          |                           |                       |                          |                       |                          |                                 |                        |                                     |                             |          |                   |                                  |                      |                       |            |                       |                   |                                     |                      |                                    |                               |                                    |                        |                                    |                        |                                     |                     |                             |                       |                   |                               |                                 |                      |                              |
| FWT - French Winter                 | NZST - New Zealand Standard  |                                     |                                     |           |                        |                       |                             |                      |           |                               |                       |                      |                       |                          |                          |                           |                       |                          |                       |                          |                                 |                        |                                     |                             |          |                   |                                  |                      |                       |            |                       |                   |                                     |                      |                                    |                               |                                    |                        |                                    |                        |                                     |                     |                             |                       |                   |                               |                                 |                      |                              |
| MET - Middle European               | NZT - New Zealand  |                                     |                                     |           |                        |                       |                             |                      |           |                               |                       |                      |                       |                          |                          |                           |                       |                          |                       |                          |                                 |                        |                                     |                             |          |                   |                                  |                      |                       |            |                       |                   |                                     |                      |                                    |                               |                                    |                        |                                    |                        |                                     |                     |                             |                       |                   |                               |                                 |                      |                              |
| MEWT - Middle European Winter       | Example: IDLW , that stands for  |                                     |                                     |           |                        |                       |                             |                      |           |                               |                       |                      |                       |                          |                          |                           |                       |                          |                       |                          |                                 |                        |                                     |                             |          |                   |                                  |                      |                       |            |                       |                   |                                     |                      |                                    |                               |                                    |                        |                                    |                        |                                     |                     |                             |                       |                   |                               |                                 |                      |                              |
| SWT - Swedish Winter                | International Date Line West   |                                     |                                     |           |                        |                       |                             |                      |           |                               |                       |                      |                       |                          |                          |                           |                       |                          |                       |                          |                                 |                        |                                     |                             |          |                   |                                  |                      |                       |            |                       |                   |                                     |                      |                                    |                               |                                    |                        |                                    |                        |                                     |                     |                             |                       |                   |                               |                                 |                      |                              |
| Current Time                        | The current time.  |                                     |                                     |           |                        |                       |                             |                      |           |                               |                       |                      |                       |                          |                          |                           |                       |                          |                       |                          |                                 |                        |                                     |                             |          |                   |                                  |                      |                       |            |                       |                   |                                     |                      |                                    |                               |                                    |                        |                                    |                        |                                     |                     |                             |                       |                   |                               |                                 |                      |                              |

## 3.5 Current Event

Describes the facility for the network administrators to track and trace the history of events happened and released. Current Event window can be activated from Function List Window. There are three daughter windows provided to accomplish above tasks.

### 3.5.1 Outstanding Event

Allow you to view the outstanding events or status and system information. If to view the event log of a specific agent, click “**Current Event**” from Function List Window. The Event Log window appears as follow.

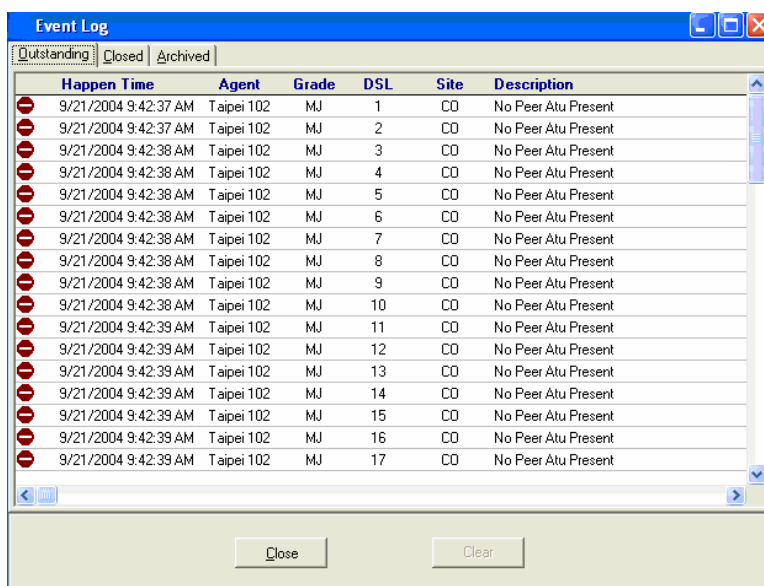

| Field       | Description                               |
|-------------|---|
| Happen Time | The date/time when the event is occurred. |
| Agent       | The IP address of the agent associated    |
| Grade       | Severity level of event or status.        |
| DSL         | DSL Port                                  |
| Site        | Down stream or upstream                   |
| Description | The description of the event or status.   |

### 3.5.2 Closed Event

This window allows you to browse the closed alarms and events of specified agents. Click on the tab of “**Closed**“, that will bring the closed screen to front as the following figure

shown. Click on  to clear all records or  to exit the window.

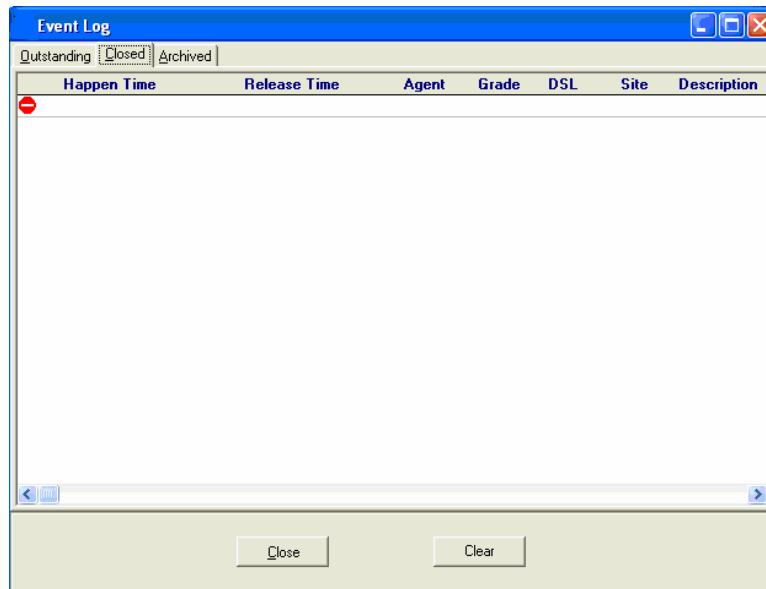

| Field        | Description                               |
|--------------|---|
| Happen Time  | The date/time when the event is occurred. |
| Release Time | The date/time when the event is closed.   |
| Agent        | The IP address of the agent associated    |
| Grade        | Severity level of event or status.        |
| DSL          | DSL Port                                  |
| Site         | Down stream or upstream                   |
| Description  | The description of the event or status.   |

### 3.5.3 Archived

This window allows you to browse the expired records, which can be configured in the Environment window. Click on the tab of “**Archived**”, that will bring the archived screen to front as the following figure shown. Click on  to clear all records or  to exit the window.

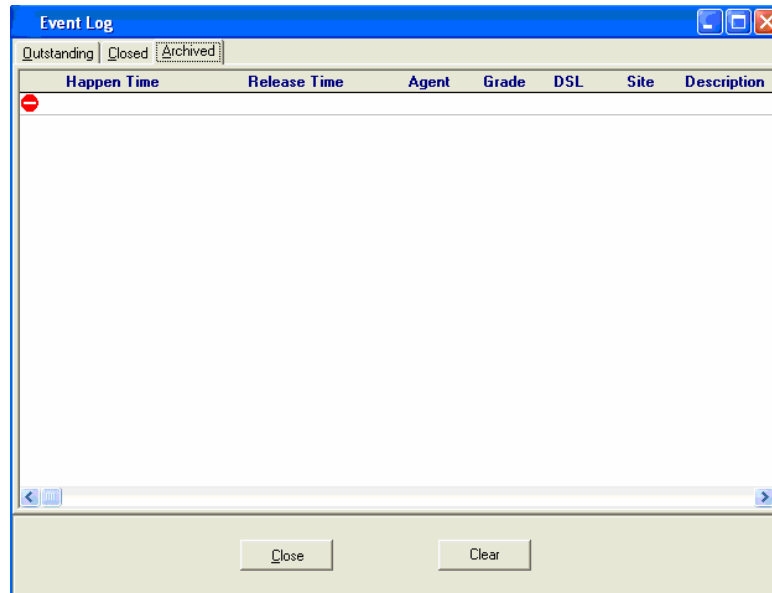

| Field        | Description                               |
|--------------|---|
| Happen Time  | The date/time when the event is occurred. |
| Release Time | The date/time when the event is closed.   |
| Agent        | The IP address of the agent associated    |
| Grade        | Severity level of event or status.        |
| DSL          | DSL Port                                  |
| Site         | Down stream or upstream                   |
| Description  | The description of the event or status.   |

## 3.6 System



---

This section allows users to perform commit and reboot that will be introduced as follows.

### 3.6.1 Commit and Reboot

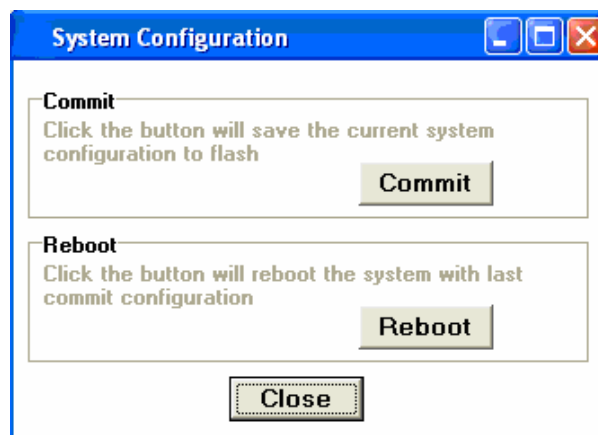
This section describes how to commit the current configuration to flash or reboot the IP DSLAM. Double Click on “**Commit and Reboot**” from the Function List Window. The System Information screen appears as follows.

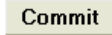

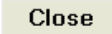
- a. If to commit the active configuration to the flash, click on .
- b. If to reboot the system and to set the boot configuration, click on .
- c. Click on  to close the window.

## 3.7 Configuration

This section describes how to configure the IP DSLAM by selecting Configuration from Function List window.

### 3.7.1 VLAN

Allow user to view and modify VLAN configuration. Double Click on “VLAN” from the Function List Window. The VLAN configuration window appears as follows.

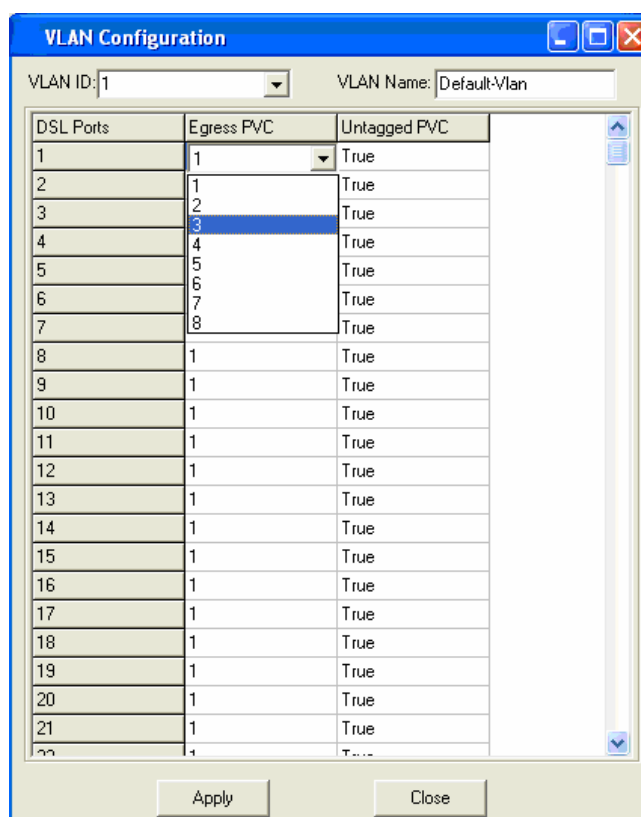

| Field        | Definition   |
|--------------|--|
| VLAN ID      | The VLAN id for this VLAN. In devices supporting "Shared Vlan for multicast" capability, the information for a multicast mac addr is shared across vlans hence vlan id is an optional parameter. In devices supporting "Independent Vlan for multicast" capability each vlan can have its own information for a multicast mac addr hence vlanid is a mandatory parameter in all the commands other than - get. For No Vlan case vlan id is not required. |
| VLAN Name    | Name of the VLAN   |
| Egress PVC   | The set of ports, which are permanently assigned to the egress list for this VLAN by management.   |
| Untagged PVC | The set of ports, which should transmit egress packets for this VLAN, as untagged.   |

- a. Select the VLAN to view or modify by using the VLAN ID drop-down list.
- b. Use Egress PVC and Untagged PVC drop-down list to set the specified DSL port's Egress PVC and Untagged PVC.
- c. Click on  to submit your settings or click on  to close the VLAN Configuration window.

### 3.7.2 Ethernet

Allow user to view and modify Ethernet configuration. Double Click on “**Ethernet**” from the Function List Window. The Ethernet Configuration window appears as follows.

| Field            | Definition  |
|------------------|---|
| DHCP             | DHCP client enabled or disabled   |
| Type             | Uplink or Downlink  |
| Admin Status     | The desired state of UPLINK (enable/disable)  |
| Operation Status | System is enabled or not.   |
| IP address       | IP address of the UPLINK  |
| Mask             | The network mask of the UPLINK.   |
| Gateway          | Gateway IP  |
| Mgmt Vlan Index  | VLAN for management traffic on this interface. Nonzero value of this field is valid only if either 'ip' field is non-zero or 'usedhcp' field is true. If no Management Vlanid is specified (in the create operation) or its value is set to zero (either in create or modify operation) then the system shall use the value of 'portvlanid' associated with the bridge port created on this interface as the Management Vlan Index. In case the management vlan (i.e. 'mgmtvlanid' or the associated 'portvlanid', if 'mgmtvlanid' is zero) doesn't exist on the system then management shall not happen on this interface till the corresponding VLAN is created with the Net side port as its member. |

- a. To view the Ethernet Configuration of UPLINK1, UPLINK2, or MGNT by using the Select Ethernet drop-down list.
- b. If to modify the Ethernet Configuration, click on  first and then proceeding advanced configurations as shown in the following figure.

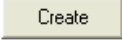
- c. If to create a new Ethernet configuration, click on  and then select a new Ethernet configuration by using Select Ethernet drop-down list. After that, users can set related parameters as follows.

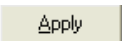
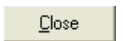
- d. Click on  to submit your settings or click on  to close the Ethernet Configuration window.



## 3.8 DSL

This section describes how to configure DSL settings by selecting **DSL** from Function List Window.

### 3.8.1 Profile

Allow users to configure Line Profile and Alarm Profile.

#### 3.8.1.1 Line Profile

If to configure Line Profile, double click on “**Line Profile**” from the Function List Window. The Line Profile configuration window appears.

| Field                  | Definition   |
|------------------------|--|
| Line Type              | The ADSL line type, Fast or Interleaved.   |
| Transmit Rate Mode     | Defines what form of transmitting rate, Fixed or adaptAtStartup.   |
| Target SNR (dB/10)     | Target Signal / Noise Margin. (0-310).   |
| Min Tx Rate(bps)       | The minimum transmitting rate of ATU-C side or ATU-R side.   |
| Down Shift SNR (dB/10) | Configured Signal/ Noise Margin for rate downshift. If the noise margin falls below this level, the modem should attempt to decrease its transmit rate. In the case that RADSL mode is not present, the value will be 0. |
| IntCorrectionUP        | Sets the correction time for the upstream interleaved buffer. RS can also be disabled.   |
| Preferred Standard     | Preferred standard compliance. Outcome is dependent upon standard support of the remote unit. GlobespanVirata High Speed ADSL DMT (ADSL+) applications only.   |
| Maximum Transmit Rate  | The maximum transmitting rate of ATU-C side or ATU-R side.   |
| Interleave Delay (ms)  | The value of Interleave Delay for this channel.  |
| UP Shift SNR (dB/10)   | Configured Signal/ Noise Margin for rate upshift. If the noise margin rises above this level, the modem should attempt to increase its transmit rate. In the case that RADSL is not present, the value will be 0.        |
| IntCorrectionDown      | This parameter sets the correction time for the downstream interleaved buffer. RS can also be disabled.  |
| Annex Type             | This parameter is set as per Annex compliance of the code release. GlobespanVirata High Speed ADSL DMT (ADSL+) applications only.  |

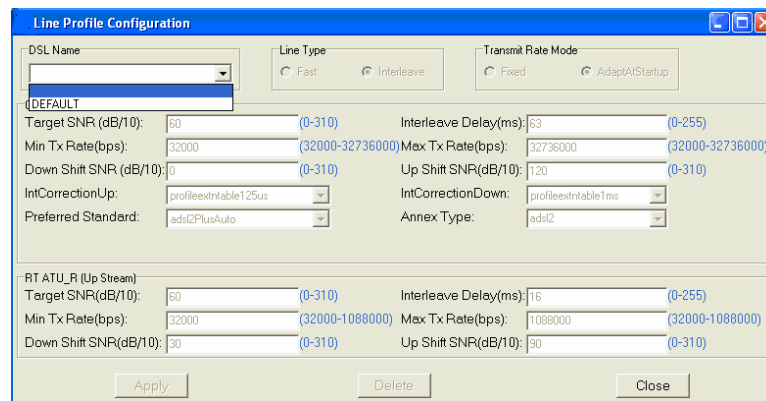

- a. To create up a new line profile, click the DSL Name drop-down list and then select the blank.



The image shows the 'Line Profile Configuration' dialog box. It has a title bar with standard window controls. The main area is divided into several sections:

- DSL Name:** A drop-down menu currently showing 'DEFAULT'.
- Line Type:** Radio buttons for 'Fast', 'Interleave', and 'AdaptAIStartup'.
- Transmit Rate Mode:** Radio buttons for 'Fixed' and 'AdaptAIStartup'.
- RT ATU\_R (Up Stream):** A section with several input fields:
  - Target SNR (dB/10): 50 (range 0-310)
  - Min Tx Rate (bps): 32000 (range 32000-32736000)
  - Down Shift SNR (dB/10): 0 (range 0-310)
  - IntCorrectionUp: profilexntable125us
  - Preferred Standard: adsl2PlusAuto
  - Interleave Delay (ms): 63 (range 0-255)
  - Max Tx Rate (bps): 32736000 (range 32000-32736000)
  - Up Shift SNR (dB/10): 120 (range 0-310)
  - IntCorrectionDown: profilexntable1ms
  - Annex Type: adsl2
- RT ATU\_C (Down Stream):** A section with several input fields:
  - Target SNR (dB/10): 50 (range 0-310)
  - Min Tx Rate (bps): 32000 (range 32000-1088000)
  - Down Shift SNR (dB/10): 30 (range 0-310)
  - Interleave Delay (ms): 16 (range 0-255)
  - Max Tx Rate (bps): 1088000 (range 32000-1088000)
  - Up Shift SNR (dB/10): 30 (range 0-310)

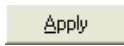
At the bottom, there are three buttons: 'Apply', 'Delete', and 'Close'.

- b. After that, the fields become enable. Input the values in those fields and then name the new line profile.
- c. Click on  to submit your setting or click on  to delete a line profile.

### 3.8.1.2 Alarm Profile

If to configure Alarm Profile, double click on “**Alarm Profile**” from the Function List Window. The Alarm Profile Configuration window appears.

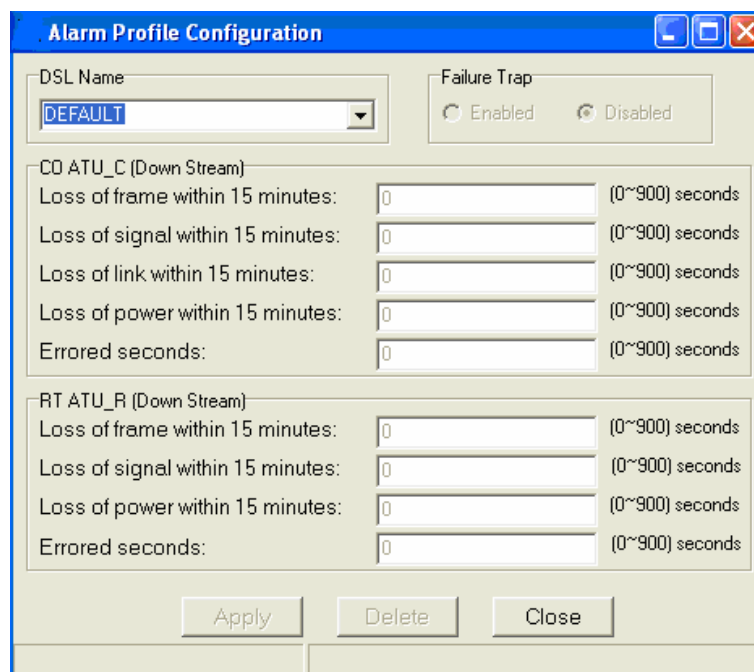

The image shows the 'Alarm Profile Configuration' dialog box. It has a title bar with standard window controls. The main area is divided into several sections:

- DSL Name:** A drop-down menu currently showing 'DEFAULT'.
- Failure Trap:** Radio buttons for 'Enabled' and 'Disabled'.
- CO ATU\_C (Down Stream):** A section with five input fields:
  - Loss of frame within 15 minutes: 0 (range 0~900) seconds
  - Loss of signal within 15 minutes: 0 (range 0~900) seconds
  - Loss of link within 15 minutes: 0 (range 0~900) seconds
  - Loss of power within 15 minutes: 0 (range 0~900) seconds
  - Errored seconds: 0 (range 0~900) seconds
- RT ATU\_R (Down Stream):** A section with four input fields:
  - Loss of frame within 15 minutes: 0 (range 0~900) seconds
  - Loss of signal within 15 minutes: 0 (range 0~900) seconds
  - Loss of power within 15 minutes: 0 (range 0~900) seconds
  - Errored seconds: 0 (range 0~900) seconds

At the bottom, there are three buttons: 'Apply', 'Delete', and 'Close'.

| Field                            | Definition  |
|----------------------------------|---|
| Loss of frame within 15 minutes  | The threshold of the number of "Loss of Frame Seconds" within 15 minutes performance data collection period.                      |
| Loss of signal within 15 minutes | The threshold of the number of "Loss of Signal Seconds" within 15 minutes performance data collection period.                     |
| Loss of link within 15 minutes   | The threshold of the number of "Loss of Link Seconds" within 15 minutes performance data collection period. (But only ATU-C side) |
| Loss of power within 15 minutes  | The threshold of the number of "Loss of Power Seconds" within 15 minutes performance data collection period.                      |
| Errored seconds                  | The threshold of the number of "Errored Seconds" within 15 minutes performance data collection period.                            |

- To create a new alarm profile, click the DSL Name drop-down list and then select the blank.
- After that, the fields become enable. Input the values in those fields and then name the new alarm profile.
- Click on  to submit or click on  to delete a alarm profile.

### 3.8.1.3 All Line Profile



Display all the Line Profile Configuration.

## 3.8.2 Port Config



Allow users to configure port configuration. Double Click on "Port Config" from the Function List Window. The Port Configuration window appears.

| PVC | VPI | VCI | Admin Status | Learning Status | Sticky Status | Pvid | Accepted Frame Type | Ingress Filter | Priority |
|-----|-----|-----|--------------|-----------------|---------------|------|---------------------|----------------|----------|
| 1   | 8   | 81  | enabled      | enabled         | disabled      | 1    | admintall           | false          | 0        |

| Field               | Definition  |
|---------------------|---|
| DSL Port            | Port No. of the IP DSLAM  |
| VPI                 | Virtual Path Identifier   |
| VCI                 | Virtual Channel Identifier  |
| Learning Status     | The state of learning on this bridge port. The value <b>enable (1)</b> indicates that unicast Mac address learning is enabled and the value <b>disable</b> indicates that unicast Mac address learning is disabled on this bridge port.   |
| Sticky Status       | Indicates if the port has been set as sticky. The value <b>enable (1)</b> indicates that the entries learned on this port will not be aged out. It also indicates that the entries learned on this port shall not be learned on any other port. The entries learned on this port can only be removed by management action or by making the value as <b>disable (2)</b> , so that the entries can be aged out. |
| Pvid                | Port VID  |
| Accepted Frame Type | Used to up/down connection.   |
| Ingress Filter      | When this is <b>true</b> , the device will discard incoming frames for VLANs, which do not include this Port in its Member set. When <b>false</b> , the port will accept all incoming frames.   |
| Priority            | Optional Connection priority. No VLAN tag, no priority.   |

- a. Choose the port to configure from the DSL Port drop-down list.
- b. Configure the Administration status as “Up” or “Down”.
- c. Choose a Line Profile from the Line Profile Name drop-down list. If to configure a Line Profile, Click on  to activate the Line Profile Configuration window.
- d. Choose an Alarm Profile from the Alarm Profile Name drop-down list. If to configure an Alarm Profile, Click on  to activate the Alarm Profile Configuration window.

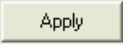
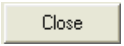
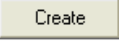
If necessary, modify values of specified PVC, including VPI, VCI, Admin Status, Learning Status, Sticky Status, Pvid, Accepted Frame Type and Ingress Filter, and priority.

- e. Click on  to submit or click on  to close the fmBridgeport window.
- f. If to create new PVC, click on  and then PVC2 appears and then users can set perimeters via PVC2. after that, click on  to submit your setting.

Port Configuration

DSL Port: 1 Admin Status: Up Operation Status: Up

Line Profile Name: DEFAULT Alarm Profile Name: DEFAULT

| PVC | VPI | VCI | Admin Status | Learning Status | Sticky Status | Pvid | Accepted Frame Type | Ingress Filter | Priority |
|-----|-----|-----|--------------|-----------------|---------------|------|---------------------|----------------|----------|
| 1   | 8   | 81  | enabled      | enabled         | disabled      | 1    | admitall            | false          | 0        |
| 2   | 8   | 82  | disabled     | enabled         | disabled      | 1    | admitall            | false          | 0        |

Apply Create Delete Close

## 3.9 DSL PM

This section describes how to utilize DSL Performance Management by selecting “**DSL PM**” from Function List window.

### 3.9.1 Physical Layer Info

Allow users to view the physical layer information of a specified DSL port from the IP DSLAM. Double Click on “**Physical Layer Info**” from the Function List Window. The Physical Layer Info window appears.

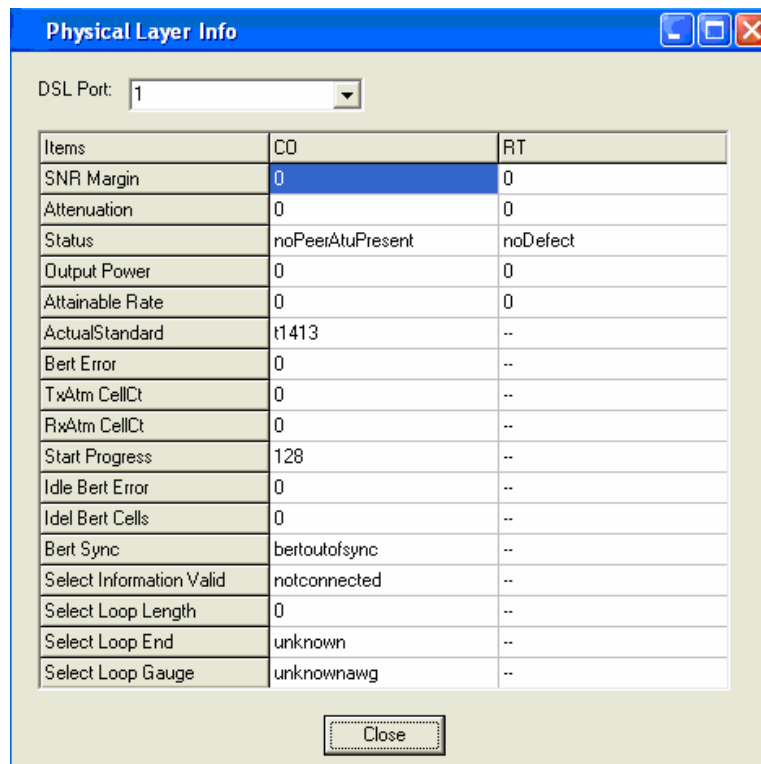

| Field           | Definition  |
|-----------------|---|
| SNR margin      | Noise margin value. (dB)  |
| Attenuation     | Difference in the total power transmitted and the total power received by the peer atu. (db)  |
| Status          | Current status of the ATU line.   |
| output power    | Total output power transmitted by atu. (dBm)  |
| attainable rate | The maximum currently attainable data rate by the atu. (kbps)   |
| ActualStandard  | Actual standard used for connection, based on the outcome of the negotiation with the Remote Unit.  |
| Bert Error      | Provides the number of bit errors detected during BERT.   |
| TxAtm CellCt    | Provides Tx ATM cell counter.   |
| RxAtm CellCt    | Provides Rx ATM cell counter.   |
| Start Progress  | Defines the current detailed start up state of Xcvr.<br>0x0 – startup not in progress; 0x0 – 0x0FFF Handshake/Training/ Profile Management/ Fast Retrain in progress; 0x8000 – 0x8FFF DSP firmware Down-Load in progress; 0xF000 – 0xFFFF illegal Parameter |
| Idle Bert Error | Number of bit errors.   |
| Idle Bert Cells | Number of idle cells.   |

|                          |  |
|--------------------------|--|
| Bert Sync                | Indicates whether the Signal is in Sync or not.  |
| Select Information Valid | Indicates the information validity for the SELT operation conducted on the Xcvr.                 |
| Select Loop Length       | Indicates the LOOP Length in Feet once when the SELT information is valid on the Xcvr.           |
| Select Loop End          | Indicates whether the loop is short or open once when the SELT information is valid on the Xcvr. |
| Select Loop Gauge        | Indicates the LOOP wire gauge information once, when the SELT information is valid on the Xcvr.  |

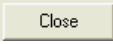
Select the port ID from the DSL Port drop-down list to view a specified DSL's physical Layer Info. Click on  to close the window.

### 3.9.2 Channel Layer Info

Allow users to view the Channel layer information of a specified DSL port from the IP DSLAM. Double Click on “**Channel Layer Info**” from the Function List Window. The Channel Layer Info window appears.

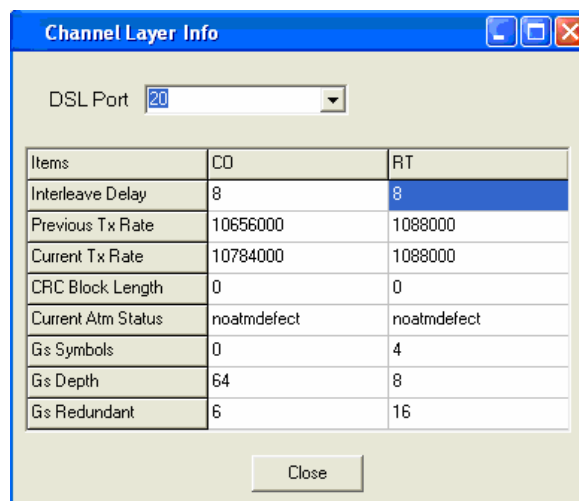

| Field              | Definition   |
|--------------------|--|
| Interleave delay   | Interleave delay for this channel. (milli-seconds)   |
| Previous TX rate   | Previous actual transmit rate on this channel if ADSL loop retain. (kbps)                        |
| Current TX rate    | Actual transmit rate on this channel. (kbps)   |
| CRC block length   | The length of the channel data-block on which the CRC operates.                                  |
| Current Atm Status | Indicates the current ATM Status.  |
| Rs Symbols         | Indicates the number of DMT symbols per Reed-Solomon code word (S), in the downstream direction. |
| Rs Depth           | Indicates interleaving depth (D), in the downstream direction.                                   |
| Rs Redundancy      | Indicates the number of redundant bytes (R), per Reed-Solomon code in the downstream direction   |

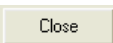
Select the port ID from the DSL Port drop-down list view a specified DSL's channel Layer Info. Click on  to close the window.

## 4. Application Note

### 4.1 Basic Configuration

---

The IP DSLAM provides multiple services to users according to the demand of application scenarios. To reduce time consuming in deployment, this document provides simple and easy configuration procedure according different applications.

#### 4.1.1 Create a new user

Users can create a root user whose user name and password are “admin” as follow.

```
$create user name admin passwd admin root

Entry Created
Privilege      UserName
-----
admin          admin
Verbose Mode Off
Entry Created
$
```

#### 4.1.2 FD.cfg Configuration

Fd.cfg is a useful tool that contains a set of default configuration commands for IP DSLAM. Using FD.cfg, you can do as follow.

- Restore the default configuration
- Modify FD.cfg
- Upload FD.cfg
- Create new services



### 4.1.2.1 Contents of FD.cfg

Use WordPad or Word to open FD.cfg. (See the following figure)

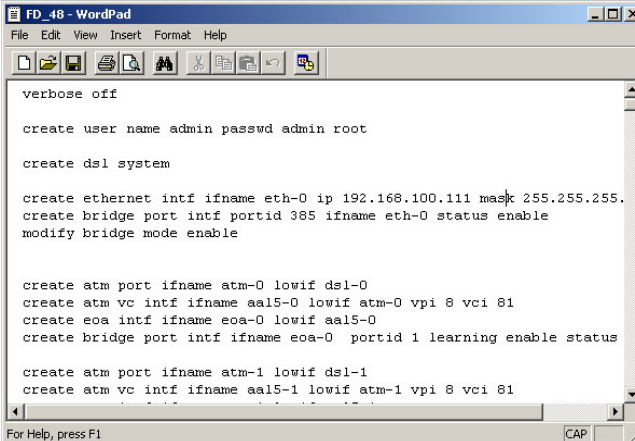

```
verbose off

create user name admin passwd admin root

create dsl system

create ethernet intf ifname eth-0 ip 192.168.100.111 mask 255.255.255.
create bridge port intf portid 385 ifname eth-0 status enable
modify bridge mode enable

create atm port ifname atm-0 lowif dsl-0
create atm vc intf ifname aal5-0 lowif atm-0 vpi 8 vci 81
create eoa intf ifname eoa-0 lowif aal5-0
create bridge port intf ifname eoa-0 portid 1 learning enable status

create atm port ifname atm-1 lowif dsl-1
create atm vc intf ifname aal5-1 lowif atm-1 vpi 8 vci 81
```

The default configuration in FD.cfg summarized as follows.

- Default IP: 192.168.100.111
- SNTP: disable
- RFC-1483 Bridge mode only
- One PVC (8/81) for each ADSL port
- Bridge port numbering 1 to 48 mapping to PVC 8/81 for ADSL port1 to port 48/24
- VLAN feature Disable
- Eth0 enable (for uplink), its bridge port number is 385
- Eth1 disable (for downlink)
- MGMT interface disable

---

**Note:**

To view the detailed contents, please refer to the Appendix A.

---

### 4.1.2.2 Download procedure

This section describes how to upload FD.cfg to IP DSLAM by tftp server. The configuration procedure is shown as follows.

Step 1:

Prepare FD.cfg and tftp server. (Including file\_id.diz, tftpd32.exe;TFTPD32.HLP and uninst.exe)

Step 2:

Put the “FD.cfg” and “tftpd32” at the same folder on your PC.

Step 3:

Activate tftpd32 and then tftpd32 window appears.

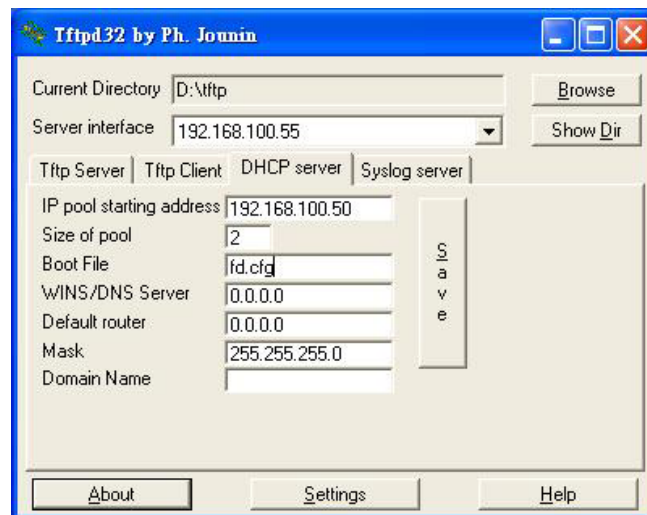

Step 4:

Click on  to set the current directory where FD.cfg located.

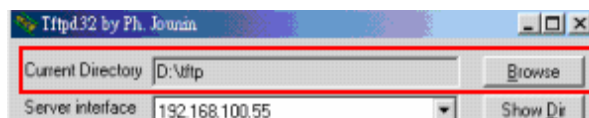

Step 5:

Click Sever interface drop-down list to select the DHCP Server’s IP.

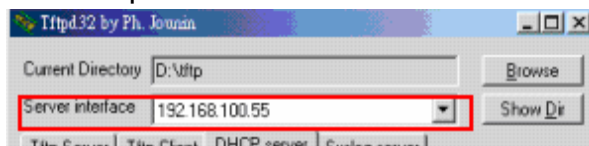

Step 6:

Assign an IP pool starting address.

|                          |                |             |               |
|--------------------------|----------------|-------------|---------------|
| Tftp Server              | Tftp Client    | DHCP server | Syslog server |
| IP pool starting address | 192.168.100.50 |             |               |
| Size of pool             | 2              |             | S             |

Step 7:

Rename the boot file as FD.cfg.

|                 |         |      |
|-----------------|---------|------|
| Size of pool    | 2       | Save |
| Boot File       | fd.cfg  |      |
| WINS/DNS Server | 0.0.0.0 |      |
| Default router  | 0.0.0.0 |      |

Step 8:

Input the mask

|                   |               |      |
|-------------------|---------------|------|
| WINS/DNS Server   | 0.0.0.0       | Save |
| Default router    | 0.0.0.0       |      |
| Mask              | 255.255.255.0 |      |
| Domain Name       |               |      |
| Additional Option | 0             |      |

Step 9:

Save the configuration.

|                          |                |      |
|--------------------------|----------------|------|
| IP pool starting address | 192.168.100.50 | Save |
| Size of pool             | 2              |      |
| Boot File                | fd.cfg         |      |
| WINS/DNS Server          | 0.0.0.0        |      |
| Default router           | 0.0.0.0        |      |
| Mask                     | 255.255.255.0  |      |
| Domain Name              |                |      |

Step 10:

If needed, click the settings button to re-configure your setting.

|       |          |      |
|-------|----------|------|
| About | Settings | Help |
|-------|----------|------|

Step 11:

Activate Telnet and login IP DSLAM.

Step 12:

Input 'list' to show the path and s/w information

```
$list
Name                               Ver      Time                               Size
Acc  State
-----
/nvram/bin/bootptftp/
TftpBootp.bin                      1 Wed Jun 30 14:12:36 2004  111064  RO  active
/nvram/bin/control/
CP.bin.gz                          1 Wed Jun 30 14:12:36 2004  1280744 RW  active
/nvram/bin/dataplane/
DP.bin.gz                          1 Wed Jun 30 14:12:36 2004   231572 RW  active
/nvram/bin/decompressor/
Decompressor.bin                   1 Wed Jun 30 14:12:36 2004    81928  RO  active
/nvram/bin/dslphy/
gsv_dsl_AD_DM_3C00000C.bin.gz      1 Wed Jun 30 14:12:36 2004   155220  RW  active
/nvram/cfg/factorydef/
FD.cfg                             1 Wed Jun 30 14:12:36 2004    19136  RW  active
$
```

Step 13:

Input 'remove fname /nvram/cfg/factorydef/FD.cfg version 1' to remove the obsolete FD.cfg file.

```
$remove fname /nvram/cfg/factorydef/FD.cfg version 1

FLASH program starts at ADDR 20008
File Removed
$
```

Step 14:

Input 'download src FD.cfg dest /nvram/cfg/factorydef/FD.cfg ip 192.168.100.66' to download config file "fd.cfg" from Server PC to IP DSLAM.

---

**Note:**

The file name to download could be different from FD.cfg but do not change the path. dest /nvram/cfg/factorydef/**FD.cfg** is the path of firmware file located on IP DSLAM.

---

```
$download src FD.cfg dest /nvram/cfg/factorydef/FD.cfg ip 192.168.100.66
```

```
Downloading the File...
```

```
.....
```

```
Block 1 erase in progress
```

```
.....Flash block 1 erase successful...
```

```
FLASH program starts at ADDR 20000
```

```
#####
```

Step 15:

Input 'upgrade fname /nvram/cfg/factorydef/FD.cfg' to upgrade and activate the access state.

```
$upgrade fname /nvram/cfg/factorydef/FD.cfg version 2
```

```
FLASH program starts at ADDR 2000c
```

```
$
```

Step 16:

Input 'commit' to store your new configuration before rebooting.

```
$commit
```

Step 17:

Input 'reboot config default' to let your new configuration take effect.

```
$reboot config default
```

### 4.1.3 How to create myconfig.cfg

- myconfig.cfg is a txt file that ensures all commands be executed at once.
- 4.1.3.3 shows the format of myconfig.cfg.
- If there are many configurations you would like to execute then you can write all commands into myconfig.cfg and then execute it at once.
- Be note to save (\$commit) to IP DSLAM if this would be executed after rebooting.
- Required of equipment: TFTP Server (Tftpd32).

#### 4.1.3.1 TFTP Server Configuration

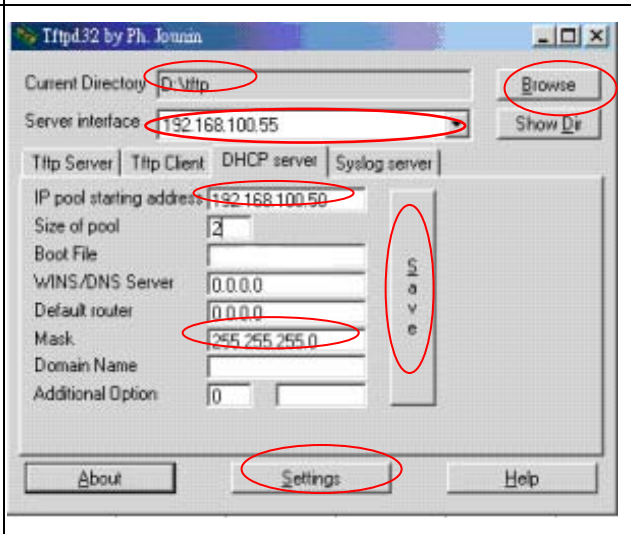
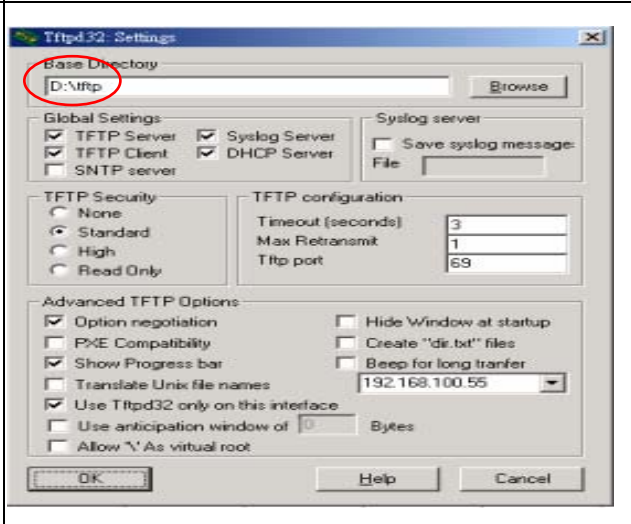
| Step | Image   | Usage   |
|------|---|---|
| 1    |   | <ol style="list-style-type: none"> <li>1. Click "Browse" button to indicate current directory of firmware.</li> <li>2. Click down-arrow button to indicate IP of DHCP Server.</li> <li>3. Assign starting address for IP pool.</li> <li>4. Input subnet mask</li> <li>5. Save input parameters.</li> <li>6. Press "Settings" button to configure more details (option)</li> </ol> |
| 2    |  | <ol style="list-style-type: none"> <li>7. After assigned this parameter and reboot Tftpd32 that "Current Directory" at previous step will follow it.</li> </ol>   |

### 4.1.3.2 myconfig.cfg Configuration

| Step | Image  | Usage   |
|------|--|---|
| 1    | Enable TFTP server (tftpd32)   | 1. Enable TFTP Server and direct the myconfig.cfg path for it.  |
| 2    | <pre> \$!list Name                Ver  Time                Size Acc State ----- /nvram/bin/bootptftp/ TftpBootp.bin        1   Fri Oct 08 09:46:22 2004  111064 RO active /nvram/bin/control/ CP.bin.gz            1   Fri Oct 08 09:46:22 2004  1293028 RW active /nvram/bin/dataplane/ DP.bin.gz            1   Fri Oct 08 09:46:22 2004   231572 RW active /nvram/bin/decompressor/ Decompressor.bin     1   Fri Oct 08 09:46:22 2004   81928 RO active /nvram/bin/dslphy/ gsv_dsl_AD_DM_3C0000C.bin.gz1   Fri Oct 08 09:46:22 2004  155220 RW active /nvram/cfg/factorydef/ FD.cfg               1   Fri Oct 08 09:46:22 2004   18973 RW active </pre> | 2. List the table and verify that myconfig.cfg had not created.   |
| 3    | <pre> \$download src myconfig.cfg dest /nvram/user/myconfig.cfg ip 192.168.100.188 Downloading the File... ..... Block 30 erase in progress .....Flash block 30 erase successful...  FLASH program starts at ADDR 3c0000 #####  FLASH program starts at ADDR 3c0000  Download session Completed,Bytes received 18180... \$ </pre>  | 3. Download myconfig.cfg to NVRAM.<br>4. 192.168.100.188 is the PC of TFTP Server..                     |
| 4    | <pre> \$apply fname /nvram/user/myconfig.cfg  \$create atm vc intf ifname aal5-71 lowif atm-23 vpi 8 vci 82 Entry Created \$create eoa intf ifname eoa-71 lowif aal5-71 : : \$create atm vc intf ifname aal5-145 lowif atm-47 vpi 8 vci 83 Entry Created \$create eoa intf ifname eoa-145 lowif aal5-145 Entry Created \$create bridge port intf ifname eoa-145 portid 146 learning enable status enable Entry Created \$ </pre>   | 5. Apply to execute the commands step by step.  |
| 5    | <pre> \$commit </pre>  | 6. If this myconfig.cfg will be running after<br>7. It will be disappear after "reboot config default". |

### 4.1.3.3 Format of myconfig.cfg

```
verbose off

create atm vc intf ifname aal5-48 lowif atm-0 vpi 8 vci 82
create eoa intf ifname eoa-48 lowif aal5-48
create bridge port intf ifname eoa-48 portid 49 learning enable status enable

create atm vc intf ifname aal5-49 lowif atm-1 vpi 8 vci 82
create eoa intf ifname eoa-49 lowif aal5-49
create bridge port intf ifname eoa-49 portid 50 learning enable status enable
:
:

create atm vc intf ifname aal5-94 lowif atm-46 vpi 8 vci 82
create eoa intf ifname eoa-94 lowif aal5-94
create bridge port intf ifname eoa-94 portid 95 learning enable status enable

create atm vc intf ifname aal5-95 lowif atm-47 vpi 8 vci 82
create eoa intf ifname eoa-95 lowif aal5-95
create bridge port intf ifname eoa-95 portid 96 learning enable status enable

create atm vc intf ifname aal5-96 lowif atm-0 vpi 8 vci 83
create eoa intf ifname eoa-96 lowif aal5-96
create bridge port intf ifname eoa-96 portid 97 learning enable status enable

create atm vc intf ifname aal5-97 lowif atm-1 vpi 8 vci 83
create eoa intf ifname eoa-97 lowif aal5-97
create bridge port intf ifname eoa-97 portid 98 learning enable status enable
:
:

create atm vc intf ifname aal5-145 lowif atm-47 vpi 8 vci 83
create eoa intf ifname eoa-145 lowif aal5-145
create bridge port intf ifname eoa-145 portid 146 learning enable status enable
```



#### 4.1.4 Line Rate Configuration

This section describes how to configure the transmission rate manually via CLI. Before configuration, see follows.

1. Input the line rate by using hexadecimal values. Following tables shows the hexadecimal values that are frequently used.

|                    |           |          |          |         |         |        |        |
|--------------------|-----------|----------|----------|---------|---------|--------|--------|
| <b>Hexadecimal</b> | 0x1f38300 | 0x177000 | 0x109a00 | 0x7d000 | 0x1f400 | 0xfa00 | 0x7d00 |
| <b>Decimal</b>     | 32M       | 1.5M     | 1M       | 512K    | 128K    | 64K    | 32K    |

2. Be noted that GsStandard, GsTxPowerAtten and GsAnnexType must be modified at the same time.

3. Frequently used commands are listed below for your reference:

- aturintlmaxtxrate 0x7d000 atucgsannextype adsl2 atucgsstandard adsl2plus atucgstxpoweratten 0 atucmaxintldelay 1
- atucfastmintxrate 0xfa00 aturfastmintxrate 0x7d00 atucgsannextype annexa atucgsstandard glite atucgstxpoweratten 0 type fastonly atucrateadaptation fixed

|             | <b>RATE</b>     | <b>type</b>             | <b>Standard</b>                  | <b>Annex type</b> |
|-------------|-----------------|-------------------------|----------------------------------|-------------------|
| <b>ATUC</b> | Fixed/ Adaptive | Interleaved / fast only | Adsl2+ / G.dmt / G.lite / T1.413 | Adsl2 / annex A   |
| <b>ATUR</b> | Fixed/ Adaptive | Interleaved / fast only | Adsl2+ / G.dmt / G.lite / T1.413 | Adsl2 / annex A   |

## 4.1.4.1 Configuration

Step 1:

Disable the DSL port that you want to re-configure its transmission rate.

```
$modify adsl line intf ifname dsl-0 disable
```

```
IfName           : dsl-0
Line Type        : interleavedOnly   Coding Type      : dmt
GsUtopia L2TxAddr : 0                GsUtopia L2RxAddr : 0
Gs Clock Type    : oscillator        Gs Action       : startup
Admin Status     : Up                Oper Status     : Down
Trans Atuc Cap   : ansit1413 q9921PotsNonOverlapped q9921PotsOverlapped q9921IsdnNonOverlapped
q9921isdnOverlapped q9922potsOverlapped q9923Readsl2PotsNonOverlapped
q9925Adsl2PlusPotsNonOverlapped q9925Adsl2PlusPotsOverlapped q9923Adsl2P
otsNonOverlapped
Trans Atuc Actual : -
Trans Atuc Config : q9921PotsNonOverlapped q9925Adsl2PlusPotsNonOverlapped
q9923Adsl2PotsNonOverlapped
GsDmtTrellis    : trellisOn
Trans Atur Cap   : ansit1413                q9921PotsOverlapped
q9923Readsl2PotsNonOverlapped q9925Adsl2PlusPotsNonOverlappedq9925Adsl2PlusPotsOverlapped
q9923Adsl2PotsNonOverlapped
PM Conf PMSF     : -
Line DELT Conf LDSF : inhibit

Set Done

IfName           : dsl-0
Line Type        : interleavedOnly   Coding Type      : dmt
GsUtopia L2TxAddr : 0                GsUtopia L2RxAddr : 0
Gs Clock Type    : oscillator        Gs Action       : startup
Admin Status     : Down              Oper Status     : Down
Trans Atuc Cap   : ansit1413 q9921PotsNonOverlapped q9921PotsOverlapped q9921IsdnNonOverlapped
q9921isdnOverlapped q9922potsOverlapped q9923Readsl2PotsNonOverlapped
q9925Adsl2PlusPotsNonOverlapped q9925Adsl2PlusPotsOverlapped q9923Adsl2P
otsNonOverlapped
Trans Atuc Actual : -
Trans Atuc Config : q9921PotsNonOverlapped q9925Adsl2PlusPotsNonOverlapped
q9923Adsl2PotsNonOverlapped
GsDmtTrellis    : trellisOn
Trans Atur Cap   : -
```

PM Conf PMSF : -

Line DELT Conf LDSF : inhibit

\$

Thu Jan 01 00:01:49 1970 : STATUS ALARM : ADSL ATUC Up : Interface - dsl-1

Step 2:

Set the line rate you need.

**\$modify adsl line profile ifname dsl-0 atucintlmaxtxrate 0x177000 aturintlmaxtxrate 0x7d000 atucgsannextype annexa atucgsstandard glite atucgstxpoweratten 0 atucmaxintldelay 1**

IfName : dsl-0

ADSL ATUC Configuration :

-----

|                          |                               |                          |                 |
|--------------------------|-------------------------------|--------------------------|-----------------|
| Rate Adaptation          | : adaptAtStartup              |                          |                 |
| Target Snr Margin(dB/10) | : 60                          | Max Snr Margin(dB/10)    | : 310           |
| GsRsIntCorrectionUp      | : 125us                       | Dnshift SnrMargin(dB/10) | : 0             |
| Upshift SnrMargin(dB/10) | : 120                         | Min Upshift Time(sec)    | : 0             |
| Min Dnshift Time(sec)    | : 0                           | Fast Min Tx Rate(bps)    | : 0x7d00        |
| Intl Min Tx Rate(bps)    | : 0x7d00                      | Fast Max Tx Rate(bps)    | : 0x1f38300     |
| Intl Max Tx Rate(bps)    | : 0x1f38300                   | Max Intl Delay(ms)       | : 63            |
| GsTxStartBin             | : 0x6                         | GsTxEndBin               | : 0x1ff         |
| GsRxStartBin             | : 0x6                         | GsRxEndBin               | : 0x1f          |
| GsMaxBitsPerBin          | : 15                          | GsMaxDCo                 | : 256           |
| GsRxBinAdjust            | : Disable                     | GsEraseProfiles          | : Disable       |
| GsAdi2x                  | : standard                    | GsStandard               | : adsl2PlusAuto |
| GsInitiate               | : -                           | GsTxPowerAtten           | : 0             |
| GsCodingGain             | : Auto                        | GsRsFastOvrhdDown        | : Disable       |
| GsRsIntCorrectionDown    | : 1Ms                         | GsRsFastOvrhdUp          | : Disable       |
| GsDrStby                 | : Disable                     | GsExpandedExchange       | : Expanded      |
| GsEscapeFastRetrain      | : Disable                     | GsFastRetrain            | : Disable       |
| GsBitSwap                | : Enable                      | GsNtr                    | : LocalOcs      |
| GsAnnexType              | : adsl2                       | GsAlctlUsVer             | : Unknown       |
| GsUseCustomBin           | : Disable                     | GsFullRetrain            | : Enable        |
| GsPsdMaskType            | : Adsl2NonovlpFlatDmtConfMode |                          | : ecMode        |
| GsExtRsMemory            | : notpresent                  | ParamHybridLossTestStart | : 0x2           |
| GsParamHybridLossTestEnd | : 0x40                        | GsDmtTrellis             | : on            |
| GsAdvertisedCapabilities | : AnnexA                      |                          |                 |
| GsITriggerMode           | : Disable                     |                          |                 |
| Type                     | : interleavedOnly             |                          |                 |

```
GsDnBinUsage      : 0xFFFFFFFFFFFFFFFFFFFFFFFFFFFFFFFFFFFFFFFFFFFFFFFFFFFFFFFFFFFF
FFFFFFFFFFFFFFFFFFFFFFFFFFFFFFFFFFFFFFFFFFFFFFFFFFFFFFFFFFFFFFFFFFFFFFFFFFFFFFFF
ParametricTestInputFile  :-
Data Boost        : Enable           Upstream PSD          : Standard
Conf PM Mode      :
Conf PML0 Time(sec)  : 180
Conf PML2 Time(sec)  : 60           Conf PML2 ATPR (dB/10) : 30
Conf PML2 Min Rate(bps) : 0xfa000
MSG Min Ds        : 4000           Minimum Snr Margin(dB/10) : 0
FrontEnd H/W Design : EI1508
H/W Pwr Reduction  : Disable
GsUsBitSwap       : Enable           Minimum INP           : InpAuto
PML2 Entry Thresh Rate : 0x3e800       PML2 Exit Thresh Rate : 0x7d000
PML2 Entry Rate Min Time : 1800

ADSL ATUR Configuration :
-----
Target Snr Margin(dB/10) : 60           Dnshift SnrMargin(dB/10) : 30
Upshift SnrMargin(dB/10) : 90           Min Upshift Time(sec)    : 30
Min Dnshift Time(sec)    : 30           Fast Min Tx Rate(bps)    : 0x7d00
Intl Min Tx Rate(bps)    : 0x7d00       Fast Max Tx Rate(bps)    : 0x109a00
Intl Max Tx Rate(bps)    : 0x109a00     Max Intl Delay(ms)       : 16
MSG Min Us              : 4000           Minimum Snr Margin(dB/10) : 310
Maximum Snr Margin(dB/10) : 310

-----
Set Done
IfName                : dsl-0

ADSL ATUC Configuration :
-----
Rate Adaptation       : adaptAtStartup
Target Snr Margin(dB/10) : 60           Max Snr Margin(dB/10)    : 310
GsRsIntCorrectionUp    : 125us          Dnshift SnrMargin(dB/10) : 0
Upshift SnrMargin(dB/10) : 120         Min Upshift Time(sec)    : 0
Min Dnshift Time(sec)  : 0             Fast Min Tx Rate(bps)    : 0x7d00
Intl Min Tx Rate(bps)  : 0x7d00       Fast Max Tx Rate(bps)    : 0x1f38300
Intl Max Tx Rate(bps)  : 0x177000     Max Intl Delay(ms)       : 1
GsTxStartBin           : 0x6           GsTxEndBin               : 0x1ff
GsRxStartBin           : 0x6           GsRxEndBin               : 0x1ff
GsMaxBitsPerBin        : 15           GsMaxDCo                 : 256
GsRxBinAdjust          : Disable       GsEraseProfiles          : Disable
```

```

GsAdi2x : standard GsStandard : gLite
GsInitiate : - GsTxPowerAtten : 0
GsCodingGain : Auto GsRsFastOvrhdDown : Disable
GsRsIntCorrectionDown : 1Ms GsRsFastOvrhdUp : Disable
GsDrStby : Disable GsExpandedExchange : Expanded
GsEscapeFastRetrain : Disable GsFastRetrain : Disable
GsBitSwap : Enable GsNtr : LocalOcs
GsAnnexType : AnnexA GsAlctlUsVer : Unknown
GsUseCustomBin : Disable GsFullRetrain : Enable
GsPsdMaskType : Adsl2NonovlpFlatDmtConfMode : ecMode
GsExtRsMemory : notpresent ParamHybridLossTestStart : 0x2
GsParamHybridLossTestEnd : 0x40 GsDmtTrellis : on
GsAdvertisedCapabilities : AnnexA
GslTriggerMode : Disable
Type : interleavedOnly
GsDnBinUsage : 0xFFFFFFFFFFFFFFFFFFFFFFFFFFFFFFFFFFFFFFFFFFFFFFFFFFFFFFFF
FFFFFFFFFFFFFFFFFFFFFFFFFFFFFFFFFFFFFFFFFFFFFFFFFFFFFFFFFFFFFFFFFFFFFFFF
ParametricTestInputFile : -
Data Boost : Enable Upstream PSD : Standard
Conf PM Mode :
Conf PML0 Time(sec) : 180
Conf PML2 Time(sec) : 60 Conf PML2 ATPR (dB/10) : 30
Conf PML2 Min Rate(bps) : 0xfa000
MSG Min Ds : 4000 Minimum Snr Margin(dB/10) : 0
FrontEnd H/W Design : EI1508
H/W Pwr Reduction : Disable
GsUsBitSwap : Enable Minimum INP : InpAuto
PML2 Entry Thresh Rate : 0x3e800 PML2 Exit Thresh Rate : 0x7d000
PML2 Entry Rate Min Time : 1800

ADSL ATUR Configuration :
-----
Target Snr Margin(dB/10) : 60 Dnshift SnrMargin(dB/10) : 30
Upshift SnrMargin(dB/10) : 90 Min Upshift Time(sec) : 30
Min Dnshift Time(sec) : 30 Fast Min Tx Rate(bps) : 0x7d00
Intl Min Tx Rate(bps) : 0x7d00 Fast Max Tx Rate(bps) : 0x109a00
Intl Max Tx Rate(bps) : 0x7d000 Max Intl Delay(ms) : 16
MSG Min Us : 4000 Minimum Snr Margin(dB/10) : 310
Maximum Snr Margin(dB/10) : 310

```

### Step 3:

#### Enable the port

**\$modify adsl line intf ifname dsl-0 enable**

IfName : dsl-0  
Line Type : interleavedOnly Coding Type : dmt  
GsUtopia L2TxAddr : 0 GsUtopia L2RxAddr : 0  
Gs Clock Type : oscillator Gs Action : startup  
Admin Status : Down Oper Status : Down  
Trans Atuc Cap : ansit1413 q9921PotsNonOverlapped q9921PotsOverlapped q9921IsdnNonOverlapped  
q9921IsdnOverlapped q9922potsOverlapped q9923Readsl2PotsNonOverlapped  
q9925Adsl2PlusPotsNonOverlapped q9925Adsl2PlusPotsOverlapped q9923Adsl2P  
otsNonOverlapped  
Trans Atuc Actual : -  
Trans Atuc Config : q9921PotsNonOverlapped q9925Adsl2PlusPotsOverlapped  
GsDmtTrellis : trellisOn  
Trans Atur Cap : -  
PM Conf PMSF : -  
Line DELT Conf LDSF : inhibit

Set Done

IfName : dsl-0  
Line Type : interleavedOnly Coding Type : dmt  
GsUtopia L2TxAddr : 0 GsUtopia L2RxAddr : 0  
Gs Clock Type : oscillator Gs Action : startup  
Admin Status : Up Oper Status : Down  
Trans Atuc Cap : ansit1413 q9921PotsNonOverlapped q9921PotsOverlapped q9921IsdnNonOverlapped  
q9921IsdnOverlapped q9922potsOverlapped q9923Readsl2PotsNonOverlapped  
q9925Adsl2PlusPotsNonOverlapped q9925Adsl2PlusPotsOverlapped q9923Adsl2P  
otsNonOverlapped  
Trans Atuc Actual : -  
Trans Atuc Config : q9921PotsNonOverlapped q9925Adsl2PlusPotsOverlapped  
GsDmtTrellis : trellisOff  
Trans Atur Cap : -  
PM Conf PMSF : -  
Line DELT Conf LDSF : inhibit

## 4.1.5 Set System Time

IDL series support SNTP (Simple Network Time Protocol), used to synchronize its clocks in the Internet. IP DSLAM will get the system time via SNTP server while a SNTP sever is created.

### 4.1.5.1 Configuration

Follow the steps below to set the SNTP server.

---

**Note:**

System time will lost while the system is powered off.

---

Step 1:

Set the IP DSLAM as the SNTP client

```
$create sntp?
```

| Command | Description |
|---------|-------------|
|---------|-------------|

|       |       |
|-------|-------|
| ----- | ----- |
|-------|-------|

|          |                     |
|----------|---------------------|
| servaddr | SNTP Server address |
|----------|---------------------|

```
$create sntp servaddr 192.168.100.253
```

Entry Created

Server Addr : 192.168.100.253 Status : active

Step 2:

Enable SNTP client

```
$modify sntp cfg enable
```

Status : Disable

Set Done

Status : Enable

```
$
```

Step 3:

Confirm the status of SNTP client

```
$get sntp stats
```

```
Requests count      : 1      Response count      : 1
Invalid Response count : 0      Lost Response count : 0
Last Time Stamp [MM/DD/YYYY::HH:MM:SS] : Thu Apr 29 10:24:36 2004
```

## Option 2: Set up the system time manually.

Step 1:

View the system information

```
$get system info
```

```
Description      :
Name             :
Location        :
Contact         :
Vendor          :
LogThreshold     : 0
Object-id       : 1.3.6.1.4.1.3278.1.12
Up Time(HH:MM:SS) : 0:4:46
HwVersion       : ADSL-1.0
CPLDVersion     : 1.4
CPSwVersion     : COL2.6.1.0.040412
CPSwVersion(Build) : 1.00.040407-ADSL
DPSwVersion     : DP_B02_06_22_05
System Time     : Thu Jan 01 00:04:46 1970
Time Zone       : GMT
DST             : off
Services        : physical datalink internet end-to-end end-to-end end-to-end applications
$
```



## Step 2:

### Get SNTP parameter definitions

#### **\$modify system info?**

| Parameter                 | Description                            |
|---------------------------|--|
| [ contact "<name>" ]      | Identification of the contact person   |
| [ name "<name>" ]         | Name of the system                     |
| [ location "<name>" ]     | The physical location of this node     |
| [ vendor "<name>" ]       | Vendor-specific information            |
| [ logthresh <decvalue> ]  | The severity level of trap             |
| [ systime "<sys-time>" ]  | SysTime in format mon dd hh:mm:ss year |
| [ dst <on   off> ]        | Daylight Saving Time                   |
| [ timezone "<timezone>" ] | Time Zone                              |

Valid System Time Zone : IDLW|NT|HST|CAT|AHST|YST|PST|MST|CST|EST|AST|NFST|  
NFT|BRST|AT|WAT|GMT|UTC|WET|CET|FWT|MET|MEWT|SWT|  
EET|IST|BT|IT|ZP4|ZP5|INST|ZP6|NST|WAST|SSMT|JT|  
CCT|ROK|KST|JST|CAST|EAST|GST|IDLE|NZST|NZT

## Step 3:

### Set up system time and time zone

#### **\$modify system info systime " May 10 10:17:00 2004" timezone "CCT"**

Description :  
Name :  
Location :  
Contact :  
Vendor :  
LogThreshold : 0  
Object-id : 1.3.6.1.4.1.3278.1.12  
Up Time(HH:MM:SS) : 0:13:18  
HwVersion : ADSL-1.0  
CPLDVersion : 1.4  
CPSwVersion : COL2.6.1.0.040412  
CPSwVersion(Build): 1.00.040407-ADSL  
DPSwVersion : DP\_B02\_06\_22\_05  
System Time : Mon May 10 10:17:23 2004  
Time Zone : GMT  
DST : off  
Services : physical datalink internet end-to-end end-to-end end-to-end applications

**Set Done**

**Description** :  
**Name** :  
**Location** :  
**Contact** :  
**Vendor** :  
**LogThreshold** : 0  
**Object-id** : 1.3.6.1.4.1.3278.1.12  
**Up Time(HH:MM:SS)** : 0:13:18  
**HwVersion** : ADSL-1.0  
**CPLDVersion** : 1.4  
**CPSwVersion** : COL2.6.1.0.040412  
**CPSwVersion(Build)** : 1.00.040407-ADSL  
**DPSwVersion** : DP\_B02\_06\_22\_05  
**System Time** : Mon May 10 10:17:00 2004  
**Time Zone** : CCT  
**DST** : off  
**Services** : physical datalink internet end-to-end end-to-end end-to-end applications

## 4.1.6 VLAN Configuration

IP series support port-based VLAN, and Group VLAN. This section describes how to create two VLAN groups (VLAN ID = 2, and 3). ADSL ports 1 & 2 (PVC 8/81) will join in VLAN group 2, and create new PVC (8/82) for ADSL1, and assign this PVC to VLAN group 3. Besides, uplink interface ETH-0 will join VLAN group 2 & 3 as trunk interface.

### 4.1.6.1 Configuration

Step 1:

Create a VLAN group No.2, and assign to Bridge port 1(ADSL port 1 PVC 8/81), and 385(Eth-0)

```
$create vlan static vlanname vlan2 vlanid 2 egressports 1 385 untaggedports 1
```

Entry Created

```
VLAN Name          : vlan2
VLAN Index         : 2
Egress ports       : 1    385
Forbidden Egress Ports : None
Untagged Ports     : 1
Bridging Mode      : Residential
Flood support Status : enable
Broadcast support Status : enable
$
```

Step 2:

Set Bridge port 1(ADSL port 1 PVC 8/81) as PVID 2

```
$modify gvrp port info portid 1 portvlanid 2 acceptframetypes all ingressfiltering true
```

```
Port Id           : 1
Port VLAN Index   : 1      Accept Frame Types: All
Ingress Filtering : False   Gvrp Status       : Disable
Failed Registrations : 0      Last Pdu Origin    : 00:00:00:00:00:00
Restricted Vlan Registration : False
```

Set Done

```
Port Id           : 1
Port VLAN Index   : 2      Accept Frame Types: All
```

```

Ingress Filtering      : True      Gvrp Status      : Disable
Failed Registrations  : 0        Last Pdu Origin   : 00:00:00:00:00:00
Restricted Vlan Registration : False
$

```

Step 3:  
Show current VLAN status

```

$get vlan curr info

VLAN Index      : 1
VLAN Status     : Other
Egress ports    : 1  2  3  4  5  6  7  8  9  10  11  12  13
14  15  16  17  18  19  20  21  22  23  24  25  26  27  28  29  30
31  32  33  34  35  36  37  38  39  40  41  42  43  44  45  46
4
7  48  385
Untagged Ports  : 1  2  3  4  5  6  7  8  9  10  11  12  13
14  15  16  17  18  19  20  21  22  23  24  25  26  27  28  29  30
31  32  33  34  35  36  37  38  39  40  41  42  43  44  45  46
4
7  48  385
Bridging Mode   : Residential
Flood support Status : enable
Broadcast support Status : enable

VLAN Index      : 2
VLAN Status     : permanent
Egress ports    : 1  385
Untagged Ports  : 1
Bridging Mode   : Residential
Flood support Status : enable
Broadcast support Status : enable

VLAN Index      : 3
VLAN Status     : permanent
Egress ports    : 2  385
Untagged Ports  : 2
Bridging Mode   : Residential
Flood support Status : enable
Broadcast support Status : enable

```

Step 4:

Create new PVC (8/82) in ADSL port 1

- Create atm vc and aal5 interface

```
$create atm vc intf ifname aal5-48 lowif atm-0 vpi 8 vci 82
```

Entry Created

|              |               |                   |                  |
|--------------|---------------|-------------------|------------------|
| VC IfName    | : aal5-48     | Low IfName        | : atm-0          |
| VPI          | : 8           | VCI               | : 82             |
| Admin Status | : Up          | Oper Status       | : Up             |
| Aal5 Tx Size | : 1536        | Aal5 Rx Size      | : 1536           |
| AAL Type     | : AAL5        | AAL5 Encap        | : LLC Mux        |
| Channel      | : Interleaved | Last Change (sec) | : 0              |
| MgmtMode     | : Data        | Row Status        | : active         |
| VC Type      | : PVC         | VC Topology       | : Point to Point |

- Create eoa interface

```
$create eoa intf ifname eoa-48 lowif aal5-48
```

Entry Created

|             |          |              |           |
|-------------|----------|--------------|-----------|
| IfName      | : eoa-48 | LowIfName    | : aal5-48 |
| FCS         | : False  |              |           |
| Pkt Type    | : ALL    |              |           |
| Oper Status | : Up     | Admin Status | : Up      |

Step 5:

Create a new bridge port 49, and maps to new created PVC 8/82 in ADSL port 1.

```
$create bridge port intf ifname eoa-48 portid 49 learning enable status enable
```

Entry Created

|                                |           |                    |          |
|--------------------------------|-----------|--------------------|----------|
| Port Id                        | : 49      | IfName             | : eoa-48 |
| Max Unicast Addresses          | : 16      | Learning Status    | : Enable |
| Port Oper Status               | : Enable  | Port Admin Status: | Enable   |
| Sticky Status                  | : Disable | FDB Modify         | : Enable |
| Acl Global Deny Apply : Enable |           |                    |          |
| Acl Global Track Apply: Enable |           |                    |          |

Step 6:

Create a new VLAN group No.3, and assign to Bridge port 49(ADSL port 1 PVC 8/82), and 385(Eth-0)

```
$create vlan static vlanname vlan3 vlanid 3 egressports 49 385 untaggedports 49
```

Entry Created

VLAN Name : vlan3  
VLAN Index : 3  
Egress ports : 49 385  
Forbidden Egress Ports : None  
Untagged Ports : 49  
Bridging Mode : Residential  
Flood support Status : enable  
Broadcast support Status : enable

Step 7:

Set Bridge port 49(ADSL port 1 PVC 8/82) as PVID 3

```
$modify gvrp port info portid 49 portvlanid 3 acceptframetypes all ingressfiltering true
```

Port Id : 49  
Port VLAN Index : 1 Accept Frame Types: All  
Ingress Filtering : False Gvrp Status : Disable  
Failed Registrations : 0 Last Pdu Origin : 00:00:00:00:00:00  
Restricted Vlan Registration: False

Set Done

Port Id : 49  
Port VLAN Index : 3 Accept Frame Types: All  
Ingress Filtering : True Gvrp Status : Disable  
Failed Registrations : 0 Last Pdu Origin : 00:00:00:00:00:00  
Restricted Vlan Registration: False

Step 8:

Modify the VLAN group 2, and add Bridge port 2 (ADSL port 2 PVC 8/81)

```
$modify vlan static vlanname vlan2 egressports 1 2 385 untaggedports 1 2
```

```
VLAN Name          : vlan2
VLAN Index         : 2
Egress ports      : 1    385
Forbidden Egress Ports : None
Untagged Ports    : 1
Bridging Mode     : Residential
Flood support Status : enable
Broadcast support Status : enable
```

Set Done

```
VLAN Name          : vlan2
VLAN Index         : 2
Egress ports      : 1    2    385
Forbidden Egress Ports : None
Untagged Ports    : 1    2
Bridging Mode     : Residential
Flood support Status : enable
Broadcast support Status : enable
```

Step 9:

Add port3 to vlan2 use vlanid index

```
$modify vlan static vlanid 2 egressports 1 2 3 385 untaggedports 1 2 3
```

```
VLAN Name          : vlan2
VLAN Index         : 2
Egress ports      : 1    2    385
Forbidden Egress Ports : None
Untagged Ports    : 1    2
Bridging Mode     : Residential
Flood support Status : enable
Broadcast support Status : enable
```

Set Done

```
VLAN Name          : vlan2
VLAN Index         : 2
```

|                          |                    |
|--------------------------|--------------------|
| <b>Egress ports</b>      | <b>: 1 2 3 385</b> |
| Forbidden Egress Ports   | : None             |
| Untagged Ports           | : 1 2 3            |
| Bridging Mode            | : Residential      |
| Flood support Status     | : enable           |
| Broadcast support Status | : enable           |

Step 10:

Modify the VLAN from 8/81 to 0/35

- Set the AAL5 strat number is 0

**\$modify atm vc intf ifname aal5-1 disable**

|                     |               |                    |                  |
|---------------------|---------------|--------------------|------------------|
| VC IfName           | : aal5-1      | Low IfName         | : atm-1          |
| VPI                 | : 8           | VCI                | : 81             |
| <b>Admin Status</b> | <b>: Up</b>   | <b>Oper Status</b> | <b>: Down</b>    |
| Aal5 Tx Size        | : 1536        | Aal5 Rx Size       | : 1536           |
| AAL Type            | : AAL5        | AAL5 Encap         | : LLC Mux        |
| Channel             | : Interleaved | Last Change (sec)  | : 0              |
| MgmtMode            | : Data        | Row Status         | : active         |
| VC Type             | : PVC         | VC Topology        | : Point to Point |
| <b>Set Done</b>     |               |                    |                  |
| VC IfName           | : aal5-1      | Low IfName         | : atm-1          |
| VPI                 | : 8           | VCI                | : 81             |
| <b>Admin Status</b> | <b>: Down</b> | <b>Oper Status</b> | <b>: Down</b>    |
| Aal5 Tx Size        | : 1536        | Aal5 Rx Size       | : 1536           |
| AAL Type            | : AAL5        | AAL5 Encap         | : LLC Mux        |
| Channel             | : Interleaved | Last Change (sec)  | : 0              |
| MgmtMode            | : Data        | Row Status         | : active         |
| VC Type             | : PVC         | VC Topology        | : Point to Point |

- (Set VPI / VCI is 0 / 35)

**\$modify atm vc intf ifname aal5-1 vpi 0 vci 35**

|                     |               |                    |               |
|---------------------|---------------|--------------------|---------------|
| VC IfName           | : aal5-1      | Low IfName         | : atm-1       |
| <b>VPI</b>          | <b>: 8</b>    | <b>VCI</b>         | <b>: 81</b>   |
| <b>Admin Status</b> | <b>: Down</b> | <b>Oper Status</b> | <b>: Down</b> |
| Aal5 Tx Size        | : 1536        | Aal5 Rx Size       | : 1536        |
| AAL Type            | : AAL5        | AAL5 Encap         | : LLC Mux     |
| Channel             | : Interleaved | Last Change (sec)  | : 0           |



```

MgmtMode      : Data          Row Status    : active
VC Type       : PVC           VC Topology   : Point to Point

Set Done

VC IfName     : aal5-1       Low IfName    : atm-1
VPI          : 0             VCI          : 35
Admin Status  : Down         Oper Status   : Down
Aal5 Tx Size  : 1536        Aal5 Rx Size : 1536
AAL Type     : AAL5         AAL5 Encap   : LLC Mux
Channel      : Interleaved   Last Change (sec) : 0
MgmtMode     : Data          Row Status    : active
VC Type      : PVC           VC Topology   : Point to Point

```

Step 11:

Set AAL5 as enable

```

$modify atm vc intf ifname aal5-1 enable

VC IfName     : aal5-1       Low IfName    : atm-1
VPI          : 0             VCI          : 35
Admin Status  : Down         Oper Status   : Down
Aal5 Tx Size  : 1536        Aal5 Rx Size : 1536
AAL Type     : AAL5         AAL5 Encap   : LLC Mux
Channel      : Interleaved   Last Change (sec) : 0
MgmtMode     : Data          Row Status    : active
VC Type      : PVC           VC Topology   : Point to Point

Set Done

VC IfName     : aal5-1       Low IfName    : atm-1
VPI          : 0             VCI          : 35
Admin Status  : Up           Oper Status   : Down
Aal5 Tx Size  : 1536        Aal5 Rx Size : 1536
AAL Type     : AAL5         AAL5 Encap   : LLC Mux
Channel      : Interleaved   Last Change (sec) : 0
MgmtMode     : Data          Row Status    : active
VC Type      : PVC           VC Topology   : Point to P

```

## 4.1.7 Modify the Downstream/Upstream Rate

### 4.1.7.1 Configuration

Step 1:

Set ADSL port12 disable

```
$modify adsl line intf disable ifname dsl-11
```

```
IfName          : dsl-11
Line Type       : interleavedOnly   Coding Type      : dmt
GsUtopia L2TxAddr : 26             GsUtopia L2RxAddr : 26
Gs Clock Type   : oscillator        Gs Action       : startup
Admin Status    : Up                Oper Status     : Up
Trans Atuc Cap  : ansit1413         q9921PotsNonOverlapped
q9921PotsOverlapped      q9921IsdnNonOverlapped      q9921isdnOverlapped
q9922potsOverlapped      q9922Adsl2PlusPotsNonOverlappedq9922Ads
l2PlusPotsOverlapped q9922Adsl2PotsNonOverlapped
Trans Atuc Actual : q9922Adsl2PlusPotsNonOverlapped
GsDmtTrellis     : trellisOn
Trans Atur Cap    : q9922Adsl2PlusPotsNonOverlappedq9922Adsl2PlusPotsOverlapped
d q9922Adsl2PotsNonOverlapped
PM Conf PMSF     : idleop
Line DELT Conf LDSF : inhibit
```

Set Done

Thu Jan 01 07:19:36 1970 : MAJOR ALARM : ADSL ATUC Down : Interface - dsl-11

```
IfName          : dsl-11
Line Type       : interleavedOnly   Coding Type      : dmt
GsUtopia L2TxAddr : 26             GsUtopia L2RxAddr : 26
Gs Clock Type   : oscillator        Gs Action       : startup
Admin Status    : Down              Oper Status     : Down
Trans Atuc Cap  : ansit1413         q9921PotsNonOverlapped
q9921PotsOverlapped      q9921IsdnNonOverlapped      q9921isdnOverlapped
q9922potsOverlapped      q9922Adsl2PlusPotsNonOverlappedq9922Ads
l2PlusPotsOverlapped q9922Adsl2PotsNonOverlapped
Trans Atuc Actual : -
GsDmtTrellis     : trellisOn
Trans Atur Cap    : -
PM Conf PMSF     : idleop
```

Step 2:

Set ADSL port 12 interleave mode Downstream 512K. The value is hex so you must conversion to decimal.

**\$modify adsl line profile atucintlmaxtxrate 0x7d000 ifname dsl-11**

```
IfName : dsl-11
ADSL ATUC Configuration :
-----
Rate Adaptation : adaptAtStartup
Target Snr Margin(dB/10) : 60 Max Snr Margin(dB/10) : 310
GsRsIntCorrectionUp : 125us Dnshift SnrMargin(dB/10): 0
Upshift SnrMargin(dB/10) : 120 Min Upshift Time(sec) : 0
Min Dnshift Time(sec) : 0 Fast Min Tx Rate(bps) : 0x7d00
Intl Min Tx Rate(bps) : 0x7d00 Fast Max Tx Rate(bps) : 0x1f38300
Intl Max Tx Rate(bps) : 0x1f38300 Max Intl Delay(ms) : 0
GsTxStartBin : 0x20 GsTxEndBin : 0x1ff
GsRxStartBin : 0x6 GsRxEndBin : 0x1f
GsMaxBitsPerBin : 15 GsMaxDCo : 256
GsRxBinAdjust : Disable GsEraseProfiles : Disable
GsAdi2x : standard GsStandard : adsl2Plus
GsInitiate : - GsTxPowerAtten : -
GsCodingGain : Auto GsRsFastOvrhdDown : 1
GsRsIntCorrectionDown : 1Ms GsRsFastOvrhdUp : 1
GsDrStby : Disable GsExpandedExchange : Expanded
GsEscapeFastRetrain : Disable GsFastRetrain : Disable
GsBitSwap : Enable GsNtr : LocalOcs
GsAnnexType : adsl2 GsAlctlUsVer : Unknown
GsUseCustomBin : Disable GsFullRetrain : Enable
GsPsdMaskType : - DmtConfMode : fdmMode
GsExtRsMemory : notpresent ParamHybridLossTestStart : 0x2
GsParamHybridLossTestEnd : 0x40 GsDmtTrellis : on
GsAdvertisedCapabilities : AnnexA
GslTriggerMode : Disable
Type : interleavedOnly
GsDnBinUsage : 0xFFFFFFFFFFFFFFFFFFFFFFFFFFFFFFFFFFFFFFFFFFFFFFFFFFFFFFFFFFFFFFFF
FFFFFFFFFFFFFFFFFFFFFFFFFFFFFFFFFFFFFFFFFFFFFFFFFFFFFFFFFFFFFFFFFFFFFFFFFFFFFFFF
ParametricTestInputFile : -
Data Boost : Enable Upstream PSD : Standard
Conf PM Mode : pmstatal3enable pmstatal2enable
```

Conf PML0 Time(sec) : 180  
 Conf PML2 Time(sec) : 180                      Conf PML2 ATPR (dB/10) : 30  
 Conf PML2 Rate(bps) : 0x10000  
 Conf GsREADSL2 Enable : disable

ADSL ATUR Configuration :

-----  
 Target Snr Margin(dB/10): 60                      Dnshift SnrMargin(dB/10): 0  
 Upshift SnrMargin(dB/10): 120                      Min Upshift Time(sec) : 0  
 Min Dnshift Time(sec) : 0                      Fast Min Tx Rate(bps) : 0x7d00  
 Intl Min Tx Rate(bps) : 0x7d00                      Fast Max Tx Rate(bps) : 0x109a00  
 Intl Max Tx Rate(bps) : 0x109a00                      Max Intl Delay(ms) : 16

Set Done

IfName : dsl-11

ADSL ATUC Configuration :

-----  
 Rate Adaptation : adaptAtStartup  
 Target Snr Margin(dB/10): 60                      Max Snr Margin(dB/10) : 310  
 GsRsIntCorrectionUp : 125us                      Dnshift SnrMargin(dB/10) : 0  
 Upshift SnrMargin(dB/10): 120                      Min Upshift Time(sec) : 0  
 Min Dnshift Time(sec) : 0                      Fast Min Tx Rate(bps) : 0x7d00  
 Intl Min Tx Rate(bps) : 0x7d00                      Fast Max Tx Rate(bps) : 0x1f38300  
 Intl Max Tx Rate(bps) : 0x7d000                      Max Intl Delay(ms) : 0  
 GsTxStartBin : 0x20                      GsTxEndBin : 0x1ff  
 GsRxStartBin : 0x6                      GsRxEndBin : 0x1f  
 GsMaxBitsPerBin : 15                      GsMaxDCo : 256  
 GsRxBinAdjust : Disable                      GsEraseProfiles : Disable  
 GsAdi2x : standard                      GsStandard : adsl2Plus  
 GsInitiate : -                      GsTxPowerAtten : -  
 GsCodingGain : Auto                      GsRsFastOvrhdDown : 1  
 GsRsIntCorrectionDown : 1Ms                      GsRsFastOvrhdUp : 1  
 GsDrStby : Disable                      GsExpandedExchange : Expanded  
 GsEscapeFastRetrain : Disable                      GsFastRetrain : Disable  
 GsBitSwap : Enable                      GsNtr : LocalOcs  
 GsAnnexType : adsl2                      GsAlctlUsVer : Unknown  
 GsUseCustomBin : Disable                      GsFullRetrain : Enable  
 GsPsdMaskType : -                      DmtConfMode : fdmMode  
 GsExtRsMemory : notpresent                      ParamHybridLossTestStart : 0x2

```

GsParamHybridLossTestEnd : 0x40          GsDmtTrellis          : on
GsAdvertisedCapabilities  : AnnexA
GslTriggerMode           : Disable
Type                     : interleavedOnly
GsDnBinUsage             : 0xFFFFFFFFFFFFFFFFFFFFFFFFFFFFFFFFFFFFFFFF
FFFFFFFFFFFFFFFFFFFFFFFFFFFFFFFFFFFFFFFFFFFFFFFFFFFFFFFFFFFFFFFF
ParametricTestInputFile : -
Data Boost               : Enable          Upstream PSD          : Standard
Conf PM Mode             : pmstatel3enable pmstatel2enable
Conf PML0 Time(sec)      : 180
Conf PML2 Time(sec)      : 180            Conf PML2 ATPR (dB/10) : 30
Conf PML2 Rate(bps)      : 0x10000
Conf GsREADSL2 Enable    : disable

ADSL ATUR Configuration :
-----
Target Snr Margin(dB/10) : 60              Dnshift SnrMargin(dB/10) : 0
Upshift SnrMargin(dB/10) : 120             Min Upshift Time(sec)    : 0
Min Dnshift Time(sec)    : 0               Fast Min Tx Rate(bps)    : 0x7d00
Intl Min Tx Rate(bps)    : 0x7d00          Fast Max Tx Rate(bps)    : 0x109a00
Intl Max Tx Rate(bps)    : 0x109a00        Max Intl Delay(ms)       : 16

```

### Step 3:

Set ADSL port12 interleave mode upstream 512K. The value is hex so you must conversion to decimal.

```

$modify adsl line profile aturintlmaxtxrate 0x7d000 ifname dsl-11

IfName                   : dsl-11
ADSL ATUC Configuration :
-----
Rate Adaptation         : adaptAtStartup
Target Snr Margin(dB/10) : 60              Max Snr Margin(dB/10)    : 310
GsRsIntCorrectionUp      : 125us           Dnshift SnrMargin(dB/10) : 0
Upshift SnrMargin(dB/10) : 120             Min Upshift Time(sec)    : 0
Min Dnshift Time(sec)    : 0               Fast Min Tx Rate(bps)    : 0x7d00
Intl Min Tx Rate(bps)    : 0x7d00          Fast Max Tx Rate(bps)    : 0x1f38300
Intl Max Tx Rate(bps)    : 0x1f38300       Max Intl Delay(ms)       : 0
GsTxStartBin             : 0x20            GsTxEndBin               : 0x1ff
GsRxStartBin             : 0x6            GsRxEndBin               : 0x1f
GsMaxBitsPerBin          : 15             GsMaxDCo                 : 256
GsRxBinAdjust            : Disable         GsEraseProfiles          : Disable

```



```

Target Snr Margin(dB/10): 60           Max Snr Margin(dB/10) : 310
GsRsIntCorrectionUp      : 125us       Dnshift SnrMargin(dB/10): 0
Upshift SnrMargin(dB/10): 120         Min Upshift Time(sec) : 0
Min Dnshift Time(sec)    : 0           Fast Min Tx Rate(bps) : 0x7d00
Intl Min Tx Rate(bps)   : 0x7d00      Fast Max Tx Rate(bps) : 0x1f38300
Intl Max Tx Rate(bps)   : 0x1f38300   Max Intl Delay(ms)    : 0
GsTxStartBin            : 0x20         GsTxEndBin           : 0x1ff
GsRxStartBin            : 0x6          GsRxEndBin           : 0x1f
GsMaxBitsPerBin         : 15           GsMaxDCo             : 256
GsRxBinAdjust           : Disable      GsEraseProfiles      : Disable
GsAdi2x                 : standard     GsStandard            : adsl2Plus
GsInitiate              : -            GsTxPowerAtten       : -
GsCodingGain            : Auto          GsRsFastOvrhdDown   : 1
GsRsIntCorrectionDown   : 1Ms          GsRsFastOvrhdUp     : 1
GsDrStby                : Disable      GsExpandedExchange   : Expanded
GsEscapeFastRetrain     : Disable      GsFastRetrain        : Disable
GsBitSwap               : Enable        GsNtr                 : LocalOcs
GsAnnexType             : adsl2        GsAlctlUsVer         : Unknown
GsUseCustomBin          : Disable       GsFullRetrain        : Enable
GsPsdMaskType           : -            DmtConfMode          : fdmMode
GsExtRsMemory           : notpresent    ParamHybridLossTestStart: 0x2
GsParamHybridLossTestEnd: 0x40         GsDmtTrellis         : on
GsAdvertisedCapabilities: AnnexA
GslTriggerMode          : Disable
Type                    : interleavedOnly
GsDnBinUsage            : 0xFFFFFFFFFFFFFFFFFFFFFFFFFFFFFFFFFFFFFFFFFFFFFFFF
FFFFFFFFFFFFFFFFFFFFFFFFFFFFFFFFFFFFFFFFFFFFFFFFFFFFFFFFFFFFFFFFFFFFFFFF
ParametricTestInputFile : -
Data Boost              : Enable        Upstream PSD          : Standard
Conf PM Mode            : pmstatal3enable pmstatal2enable
Conf PML0 Time(sec)     : 180
Conf PML2 Time(sec)     : 180          Conf PML2 ATPR (dB/10) : 30
Conf PML2 Rate(bps)     : 0x10000
Conf GsREADSL2 Enable   : disable

ADSL ATUR Configuration :
-----
Target Snr Margin(dB/10): 60           Dnshift SnrMargin(dB/10): 0
Upshift SnrMargin(dB/10): 120         Min Upshift Time(sec) : 0
Min Dnshift Time(sec)    : 0           Fast Min Tx Rate(bps) : 0x7d00
Intl Min Tx Rate(bps)   : 0x7d00      Fast Max Tx Rate(bps) : 0x109a00

```

**Intl Max Tx Rate(bps) : 0x7d000**

**Max Intl Delay(ms) : 16**

Step 4:

Set ADSL port12 enable.

**\$modify adsl line intf enable ifname dsl-11**

IfName : dsl-11

Line Type : interleavedOnly Coding Type : dmt

GsUtopia L2TxAddr : 26 GsUtopia L2RxAddr : 26

Gs Clock Type : oscillator Gs Action : startup

**Admin Status : Down** Oper Status : Down

Trans Atuc Cap : ansit1413 q9921PotsNonOverlapped

q9921PotsOverlapped q9921IsdnNonOverlapped q9921isdnOverlapped

q9922potsOverlapped q9922Adsl2PlusPotsNonOverlappedq9922Ads

I2PlusPotsOverlapped q9922Adsl2PotsNonOverlapped

Trans Atuc Actual : -

GsDmtTrellis : trellisOn

Trans Atur Cap : -

PM Conf PMSF : idleop

Line DELT Conf LDSF : inhibit

Set Done

IfName : dsl-11

Line Type : interleavedOnly Coding Type : dmt

GsUtopia L2TxAddr : 26 GsUtopia L2RxAddr : 26

Gs Clock Type : oscillator Gs Action : startup

**Admin Status : Up** Oper Status : Down

Trans Atuc Cap : ansit1413 q9921PotsNonOverlapped

q9921PotsOverlapped q9921IsdnNonOverlapped q9921isdnOverlapped

q9922potsOverlapped q9922Adsl2PlusPotsNonOverlappedq9922Ads

I2PlusPotsOverlapped q9922Adsl2PotsNonOverlapped

Trans Atuc Actual : -

GsDmtTrellis : trellisOn

Trans Atur Cap : -

PM Conf PMSF : idleop

Line DELT Conf LDSF : inhibit



## 4.1.8 Enable SNMP Function

### 4.1.8.1 Configuration

Step 1:

Create SNMP community

```
$create snmp comm community public rw
```

Entry Created

| Community | Access |
|-----------|--------|
|-----------|--------|

|        |    |
|--------|----|
| public | RW |
|--------|----|

Setp 2:

Create SNMP host

```
$create snmp host ip 192.168.100.55 community public
```

Entry Created

| Host Address | Community |
|--------------|-----------|
|--------------|-----------|

|                |        |
|----------------|--------|
| 192.168.100.55 | public |
|----------------|--------|

\$

Setp 3:

Create SNMP traphost

```
$create snmp traphost ip 192.168.100.55 community public
```

Entry Created

Ip Address : 192.168.100.55

Community : public

Port : 162 Version : v2c

### 5.1 About CLI Administration

---

Command Line Interface (CLI) is the primary user interface to administrate the system. CLI can be accessed either from the CID port or telnet session. All CLI commands are simple strings designed for the Administrator to manage your IP DSLAM easily.

#### 5.1.1 Notation Conventions

- Keywords in a command that you must enter exactly as shown are presented in bold.
- User specified values in a command are presented in regular typeface, i.e., not bold or italic.
- Parameter values enclosed in < > must be specified.
- Parameters enclosed in [ ] are optional. All modify parameters are shown as optional in CLI commands even if there exists only a single parameter.
- Parameter values are separated by a vertical bar | only when one of the specified values can be used.
- Parameter values are enclosed in { } when you must use one of the values specified.
- Parameters are enclosed in [ ] + when you can specify the parameter one or more times, in the command line.

#### 5.1.2 Command Structure

CLI commands conform to the following structure except for some basic service commands such as ping, traceroute etc.

##### <Action>:

This is the first keyword of a CLI command. It indicates the type of operation to be performed. "create" is an example of this keyword. However, if no action is specified it will mean "modify". For example, modify bridge port intf portid portid status enable and bridge port intf portid portid status enable mean the same.

##### <Group>:

This is the second keyword of a CLI command. It indicates the group of a CLI command. "Bridge" is an example of this keyword.

### <Sub group>:

This is the third keyword of a CLI command. It indicates the sub group of a CLI command. "Port" is an example of this keyword.

### <Sub sub group>:

This is the fourth keyword of a CLI command. It indicates the sub group of a CLI command. "intf" is an example of this keyword.

### <tag1 value1> <tagN valueN>:

These are <tag value> pairs and can vary from 0 to N. They indicate the parameter values passed to a CLI command. "ifname aal5-0", "portid 20", are examples of tag value pairs.

## 5.1.3 Glossary of Terms and Acronyms

This section contains a brief list of selected acronyms.

| Abbreviation           | Description  |
|------------------------|--|
| AAL5                   | ATM Adaptation Layer 5   |
| ACL                    | Access Control list  |
| ADSL                   | Asymmetric Digital Subscriber Line   |
| Attribute              | An element of an MO  |
| ATM                    | Asynchronous Transmission Mode   |
| CLI                    | Command Line Interface   |
| CP                     | Control Plane  |
| DHCP                   | Dynamic Host Configuration Protocol  |
| DP                     | Data Plane   |
| DRA                    | DHCP Relay Agent   |
| DSL                    | Digital Subscriber Line  |
| EOA                    | Ethernet over ATM  |
| GARP                   | Generic Attribute Registration Protocol  |
| GMRP                   | GARP Multicast Registration Protocol   |
| GVRP                   | GARP VLAN Regenration Protocol   |
| IGMP                   | InternetGroup Management Protocol  |
| Index                  | An element of a tabular MO that uniquely identifies an entry   |
| IP                     | Internet protocol  |
| IRL                    | Input Rate Limiting  |
| IVL                    | Individual VLAN Learning   |
| IVM                    | Individual VLAN for Multicast  |
| LACP                   | Link Aggregation Control Protocol  |
| LAN                    | Local Area Network   |
| ME - Management Entity | The entity, modified, controlled and monitored through MOs.  |
| MO ID - MO Identifier  | A unique number that identifies an MO. Interpretation of the information passed to GenAg for an MO depends upon this identifier                          |
| MO - Managed Object    | Logical unit of manageable information. It is similar to a MIB. An ME is visible to the outside world in the form of one or more MOs that constitute it. |
| Operations             | GAG supports five operations - Create, Delete, Modify, Get, Get-Next   |
| ORL                    | Output Rate Limiting   |

|                |   |
|----------------|---|
| OAM            | Operations Administration and Management                |
| PIA            | PPPoE Intermediate Agent                                |
| RMON           | Remote Monitoring                                       |
| STP            | Spanning Tree Protocol                                  |
| SNTP           | Simple Network Time Protocol                            |
| SVL            | Shared VLAN Learning                                    |
| SVM            | Shared VLAN for Multicast                               |
| Specific Agent | Entities that use GenAg interfaces to manage the system |
| TEA            | Target Engine Agent                                     |
| VC             | Virtual Channel   |
| VLAN           | Virtual LAN   |

## 5.1.4 CLI Command Brief Description

### CLI Command - Action List

| <action>   | Description   |
|------------|---|
| alias      | Used to create an alias for any CLI command.  |
| apply      | Used to apply a configuration file stored on the system   |
| climode    | Modes of cli/Prio change of CLI task  |
| commit     | Used to commit the active configuration to the flash.   |
| Create     | Used to create configuration of objects corresponding to the identifier and parameters.   |
| delete     | Used to delete configuration of objects corresponding to the identifier and parameters. If the delete action is confirmed, the configuration of objects will no longer exist. |
| defragment | Defragment the compact blocks in flash  |
| download   | Used to download a binary, configuration or user specific file from the remote host.  |
| get        | Used to view information of the selected identifier and parameters.   |
| help       | Used to view the detailed usage of CLI commands.  |
| list       | Used to list the Configuration or binary files stored on the unit   |
| logout     | Used to terminate the CLI.  |
| memset     | Specify the length of memory set  |
| modify     | Used to set or modify existing configuration of objects corresponding to the identifier and parameters.   |
| passwd     | Used to change the password associated with a user login.   |
| permission | Use this command to change the permission of the files stored on flash  |
| Ping       | Used to send one or more ICMP messages to another host for a reply.   |
| prompt     | Used to set the new CLI prompt.   |
| rdf        | Used to read Flash  |
| rdm        | Used to read Memory   |
| reboot     | Used to restart the system.   |
| remove     | Used to remove a configuration or binary file stored on the unit  |
| reset      | Used to reset a port of system.   |
| save       | Used to save the configuration to Flash RAM.  |
| Sync       | Used to Sync  |
| traceroute | Used to trace the route to the specified destination.   |
| unalias    | Used to delete an alias.  |
| upgrade    | Used to upgrade a configuration or binary file stored on the system.  |
| verbose    | Using this command, a user can view the status of entries before and after the execution of a command (create, delete, modify, get).  |
| wrm        | Used to write Memory  |

## 5.1.5 Categories of the CLI commands

| Command                             | Implemented by | Recommend for end-users   |
|-------------------------------------|----------------|---|
| <b>802.1p Commands</b>              |                |   |
| Bridge port accessprio Commands     | Conexant       | Yes   |
| Bridge port prioinfo Commands       | Conexant       | Yes   |
| Bridge port trfclassmap Commands    | Conexant       | Yes   |
| Bridge port priomap commands        | Conexant       | Yes   |
| <b>ABOND</b>                        |                |   |
| ABOND group intf Commands           | Conexant       | Yes, but this is a legacy command and you should contact KEYMILE support personal when you plan to use. |
| ABOND group stats Commands          | Conexant       | Yes   |
| Abond link entry Commands           | Conexant       | Yes   |
| Abond link stats Commands           | Conexant       | Yes   |
| <b>Aggregation Commands</b>         |                |   |
| Active Standby aggr info Commands   | Conexant       | Yes   |
| Aggr intf Commands                  | Conexant       | Yes   |
| LACP Aggr Commands                  | Conexant       | Yes   |
| LACP AGGRPort Info Commands         | Conexant       | Yes   |
| LACP AGGRPort List Command          | Conexant       | Yes   |
| LACP AGGRPort Stats Commands        | Conexant       | Yes   |
| Redundancy aggr info Commands       | Conexant       | Yes   |
| Redundancy aggrport list Commands   | Conexant       | Yes   |
| Redundancy aggr stats Commands      | Conexant       | Yes   |
| <b>ATM Commands</b>                 |                |   |
| AAL5 VC Statistics Commands         | Conexant       | Yes   |
| ATM OAM CC Commands                 | Conexant       | Yes   |
| ATM OAM Loopback Commands           | Conexant       | Yes   |
| ATM Port Commands                   | Conexant       | Yes   |
| ATM VC Commands                     | Conexant       | Yes   |
| ATM VC Statistics Commands          | Conexant       | Yes   |
| <b>Bridging Commands</b>            |                |   |
| Bridge forwarding Commands          | Conexant       | Yes   |
| Bridge Mode Commands                | Conexant       | Yes   |
| Bridge Port Cap Commands            | Conexant       | Yes   |
| Bridge port forwarding Commands     | Conexant       | Yes   |
| Bridge Port Map Commands            | Conexant       | Yes   |
| Bridge Port Stats Table Commands    | Conexant       | Yes   |
| Bridge Port Table Commands          | Conexant       | Yes   |
| Bridge static mcast Commands        | Conexant       | Yes   |
| Bridge static ucast Commands        | Conexant       | Yes   |
| Bridge tbg traps Commands           | Conexant       | Yes   |
| GARP Port Info Commands             | Conexant       | Yes   |
| STP Group Commands                  | Conexant       | Yes   |
| STP Port Commands                   | Conexant       | Yes   |
| Transparent Bridging Table Commands | Conexant       | Yes   |
| <b>Bridge Multicast Commands</b>    |                |   |
| Bridge mcast forwarding Commands    | Conexant       | Yes   |
| Bridge mcast forwarding Commands    | Conexant       | Yes   |
| Bridge mcast fwdunreg Commands      | Conexant       | Yes   |
| Bridge Static Multicast Commands    | Conexant       | Yes   |
| <b>DHCP Commands</b>                |                |   |
| DHCP Client Commands                | Conexant       | Yes   |
| <b>DSL Commands</b>                 |                |   |
| ADSL Alarm Profile Commands         | Conexant       | Yes   |
| ADSL Alarm Profilext Commands       | Conexant       | Yes   |
| ADSL ATUC Channel Commands          | Conexant       | Yes   |

|                                    |          |     |
|------------------------------------|----------|-----|
| ADSL ATUC Chanperf Commands        | Conexant | Yes |
| ADSL ATUC ChanIntvl Commands       | Conexant | Yes |
| ADSL ATUC Interval Commands        | Conexant | Yes |
| ADSL ATUC Perf Commands            | Conexant | Yes |
| ADSL ATUC Physical Commands        | Conexant | Yes |
| ADSL ATUC Trap Commands            | Conexant | Yes |
| ADSL ATUC Trapsext Commands        | Conexant | Yes |
| ADSL ATUR ChanIntvl Commands       | Conexant | Yes |
| ADSL ATUR Channel Commands         | Conexant | Yes |
| ADSL ATUR Chanperf Commands        | Conexant | Yes |
| ADSL ATUR Interval Commands        | Conexant | Yes |
| Adsl atur intervalex Commands      | Conexant | Yes |
| ADSL ATUR Perf Commands            | Conexant | Yes |
| Adsl atur perfoext Commands        | Conexant | Yes |
| ADSL ATUR Physical Commands        | Conexant | Yes |
| ADSL ATUR Traps Commands           | Conexant | Yes |
| DSL ATUR Trapsext Commands         | Conexant | Yes |
| ADSL Cap Commands                  | Conexant | Yes |
| ADSL Line Intf Commands            | Conexant | Yes |
| ADSL Line Profile Commands         | Conexant | Yes |
| Dsl chip Commands                  | Conexant | Yes |
| Dsl dsp chip Commands              | Conexant | Yes |
| Dsl dsp port Commands              | Conexant | Yes |
| Dsl system Commands                | Conexant | Yes |
| <b>EHDLC Commands</b>              |          |     |
| Ehdlc intf Commands                | Conexant | Yes |
| <b>Ethernet Commands</b>           |          |     |
| Dot3 stats Commands                | Conexant | Yes |
| Ethernet Commands                  | Conexant | Yes |
| <b>Filtering Commands</b>          |          |     |
| ACL Global Macentry Commands       | Conexant | Yes |
| Clfr list genentry commands        | Conexant | Yes |
| ACL Port Macentry Commands         | Conexant | Yes |
| Clfr namedlist genentry Commands   | Conexant | Yes |
| Clfr namedlist info Commands       | Conexant | Yes |
| Clfr namedlist map Commands        | Conexant | Yes |
| Clfr profile branch Commands       | Conexant | Yes |
| Clfr profile info Commands         | Conexant | Yes |
| Clfr profile node Commands         | Conexant | Yes |
| Clfr tree branch Commands          | Conexant | Yes |
| Clfr tree info Commands            | Conexant | Yes |
| Clfr tree map Commands             | Conexant | Yes |
| Clfr tree node Commands            | Conexant | Yes |
| Clfr tree profile Commands         | Conexant | Yes |
| Filter expr entry Commands         | Conexant | Yes |
| Filter list genentry Commands      | Conexant | Yes |
| Filter namedlist genentry Commands | Conexant | Yes |
| Filter namedlist info Commands     | Conexant | Yes |
| Clfr tree node Commands            | Conexant | Yes |
| Clfr tree profile Commands         | Conexant | Yes |
| Filter expr entry Commands         | Conexant | Yes |
| Filter list genentry Commands      | Conexant | Yes |
| Filter namedlist genentry Commands | Conexant | Yes |
| Filter namedlist info Commands     | Conexant | Yes |
| Filter namedlist map Commands      | Conexant | Yes |
| Create filter namedlist map        | Conexant | Yes |
| Filter rule actionmap Commands     | Conexant | Yes |
| Filter rule entry Commands         | Conexant | Yes |
| Filter rule map Commands           | Conexant | Yes |
| Filter rule stats Commands         | Conexant | Yes |
| Filter seq entry Commands          | Conexant | Yes |

|                                       |          |     |
|---------------------------------------|----------|-----|
| Filter seq info Commands              | Conexant | Yes |
| Filter subrule arp Commands           | Conexant | Yes |
| Filter subrule cflrtree Commands      | Conexant | Yes |
| Filter subrule ether Commands         | Conexant | Yes |
| Filter subrule generic Commands       | Conexant | Yes |
| Filter subrule ICMP Commands          | Conexant | Yes |
| Filter subrule IGMP Commands          | Conexant | Yes |
| Filter subrule IP Commands            | Conexant | Yes |
| Filter subrule PPP Commands           | Conexant | Yes |
| Filter subrule TCP Commands           | Conexant | Yes |
| Filter subrule UDP Commands           | Conexant | Yes |
| <b>EOA Commands</b>                   |          |     |
| EOA Commands                          | Conexant | Yes |
| <b>IGMP Commands</b>                  |          |     |
| Igmpsnoop cfg info Commands           | Conexant | Yes |
| Igmpsnoop cfg info Commands           | Conexant | Yes |
| Igmpsnoop mvlan config Commands       | Conexant | Yes |
| Igmpsnoop port info Commands          | Conexant | Yes |
| Igmpsnoop port stats Commands         | Conexant | Yes |
| Igmpsnoop querier info Commands       | Conexant | Yes |
| <b>Interface Commands</b>             |          |     |
| Interface Commands                    | Conexant | Yes |
| <b>IP Commands</b>                    |          |     |
| IP Net to Media Table Commands        | Conexant | Yes |
| IP Route Commands                     | Conexant | Yes |
| Ipoa intf Commands                    | Conexant | Yes |
| ipoe intf Commands                    | Conexant | Yes |
| Rid static Commands                   | Conexant | Yes |
| <b>MacProfile Commands</b>            |          |     |
| Macprofile global Commands            | Conexant | Yes |
| Resvdmac profile info Commands        | Conexant | Yes |
| Resvdmac profile param Commands       | Conexant | Yes |
| <b>Management Traffic Commands</b>    |          |     |
| Ctlpkt group info Commands            | Conexant | Yes |
| Ctlpkt instance info Commands         | Conexant | Yes |
| Ctlpkt profile info Commands          | Conexant | Yes |
| <b>PPPoE Tunneling Commands</b>       |          |     |
| PPPoE Global ACprofile Commands       |          |     |
| PPPoE Global Config Commands          |          |     |
| PPPoE Global Serviceprofile Commands  |          |     |
| PPPoE Global Stats Commands           |          |     |
| Pppoe intf Commands                   |          |     |
| PPPoE Session Stats Commands          |          |     |
| PPPR Interface Commands               |          |     |
| <b>IA (Intermeida Agent) Commands</b> |          |     |
| Dra global stats Commands             |          |     |
| Dra instance entry Commands           |          |     |
| Dra stats entry Commands              |          |     |
| Dra global config Commands            |          |     |
| Ia profile entry Commands             |          |     |
| Pia instance entry Commands           |          |     |
| Pia stats entry Commands              |          |     |
| Pia global config Commands            |          |     |
| <b>QoS Commands</b>                   |          |     |
| IRL Map Commands                      |          |     |
| IRL Profile Commands                  |          |     |
| IRL Stats Commands                    |          |     |
| Bridge rinstance map Commands         |          |     |
| RI actionprofile info Commands        |          |     |
| RI instance info Commands             |          |     |
| RI profile info Commands              |          |     |

|  |  |  |
|--|--|--|
| Scheduling profile class Commands              |  |  |
| Scheduling profile info Commands               |  |  |
| Trfclass profile class Commands                |  |  |
| Trfclass profile info Commands                 |  |  |
| Trfclass stats Commands                        |  |  |
| <b>RMON Commands</b>                           |  |  |
| RMON Statistics Group Commands                 |  |  |
| RMON Task Info Commands                        |  |  |
| RMON Memory Pool info Commands                 |  |  |
| RMON Queue info Commands                       |  |  |
| RMON Net buffers info Commands                 |  |  |
| RMON Semaphore info Commands                   |  |  |
| RMON Event Group info Commands                 |  |  |
| <b>SNMP Commands</b>                           |  |  |
| SNMP Comm Commands                             |  |  |
| SNMP Host Commands                             |  |  |
| SNMP Stats Commands                            |  |  |
| SNMP Traphost Commands                         |  |  |
| <b>SNTP Commands</b>                           |  |  |
| SNTP Cfg Commands                              |  |  |
| SNTP servaddr Commands                         |  |  |
| SNTP Stats Commands                            |  |  |
| <b>System Commands</b>                         |  |  |
| Cbuftace cfg Commands                          |  |  |
| System Configuration Save and Restore Commands |  |  |
| System Control Table Commands                  |  |  |
| System crash info commands                     |  |  |
| System Info Commands                           |  |  |
| System manu info Commands                      |  |  |
| System reboot info command                     |  |  |
| Nbize Commands                                 |  |  |
| System Stats Commands                          |  |  |
| System Traps Commands                          |  |  |
| System Trap Log Table Commands                 |  |  |
| System version commands                        |  |  |
| Trace Log Configuration Commands               |  |  |
| Trace Log Statistics Commands                  |  |  |
| <b>VC Aggregation Commands</b>                 |  |  |
| Atm vcaggr intf Commands                       |  |  |
| Atm vcaggr map Commands                        |  |  |
| <b>VLAN Commands</b>                           |  |  |
| GVRP Info Commands                             |  |  |
| GVRP Port Info Commands                        |  |  |
| GVRP Port Stats Commands                       |  |  |
| Vlan curr info Commands                        |  |  |
| VLAN mapprofile info Commands                  |  |  |
| Vlan mapprofile param Commands                 |  |  |
| VLAN Static Commands                           |  |  |
| <b>Miscellaneous Commands</b>                  |  |  |
| File Commands                                  |  |  |
| Other Commands                                 |  |  |
| <b>PLANET CLI Commands</b>                     |  |  |
| System ADSL Port Operation Status Commands     |  |  |
| System Alarm Commands                          |  |  |
| System Control Commands                        |  |  |
| System Hardware Inventory Commands             |  |  |
| System ivmconfig Commands                      |  |  |
| System SFP Commands                            |  |  |
| System Version Commands                        |  |  |
| System Debug Commands                          |  |  |



|                                    |        |  |
|------------------------------------|--------|--|
| Configuration FD Commands          |        |  |
| Configuration USER Commands        |        |  |
| Temperature Configuration Commands |        |  |
| Temperature State Commands         |        |  |
| Temperature Supervision Commands   |        |  |
| Temperature Configuration Commands |        |  |
| Temperature State Commands         |        |  |
| Temperature Supervision Commands   |        |  |
| <b>System Commands</b>             |        |  |
| System Hardware Inventory Commands | PLANET | Yes  |
| System ivmconfig Commands          | PLANET | Yes  |
| System Debug Commands              | PLANET | No, for KEYMILE and PLANET support personal only |

## 5.2 802.1p commands

---

### 5.2.1 Bridge port accessprio Commands

#### 5.2.1.1 Get bridge port accessprio

**Description:**

Use this command to get.

**Command Syntax:**

**get bridge port accessprio** [**portid** <portid-val>] [**regenprio** <regenprio-val >]

**Parameters:**

| Name                              | Description  |
|-----------------------------------|--|
| <b>portid</b> <portid-val >       | Port number of the port for which this entry contains bridge management information.<br><b>Type</b> : Get—Optional<br><b>Valid values:</b> 1-386 |
| <b>regenprio</b> <regenprio-val > | Regenerated user priority from which the access priority is mapped.<br><b>Type</b> : Get —Optional<br><b>Valid values:</b> 0 - 7                 |

**Example:**

```
$ get bridge port accessprio portid 1 regenPrio 1
```

**Output:**

```
PortId      : 1          regenPrio : 1  
AccessPriority : 0
```

**Output field:**

| Field                 | Description  |
|-----------------------|--|
| <b>PortId</b>         | Port number of the port for which this entry contains bridge management information. |
| <b>regenPrio</b>      | Regenerated user priority from which the access priority is mapped.                  |
| <b>AccessPriority</b> | The Outbound Access Priority the received frame is mapped to.                        |

**References:**

Bridge port commands

## 5.2.2 Bridge port prioinfo Commands

### 5.2.2.1 Get bridge port prioinfo

**Description:**

Use this command to get.

**Command Syntax:**

**get bridge port prioinfo [portid <portid-val >]**

### 5.2.2.2 Modify bridge port prioinfo

**Description:**

Use this command to modify.

**Command Syntax:**

**modify bridge port prioinfo portid portid [defprio <defprio-val>] [numtrfclass <numtrfclass-val>] [defsvprio <defsvprio-val>]**

**Parameters:**

| Name                                    | Description   |
|---|---|
| <b>portid</b> <portid>                  | Port number of the port for which this entry contains bridge management information.<br><b>Type:</b> Modify -- Mandatory<br>Get -- Optional<br><b>Valid values:</b> 1 - 386 |
| <b>defprio</b> <defprio-val>            | The default ingress User Priority which can be configured by the user.<br><b>Type:</b> Modify -- Optional<br><b>Valid values:</b> 0 - 7                                     |
| <b>numtrfclass</b><br><numtrfclass-val> | The number of egress traffic classes supported on this port.<br><b>Type:</b> Modify -- Optional<br><b>Valid values:</b> 1 - 8   |
| <b>defsvprio</b><br><defsvprio-val>     | Not supported<br><b>Type:</b> Modify Optional<br><b>Valid values:</b> 0 - 7   |

**Example:**

\$ get bridge port prioinfo portid 1

**Output:**

PortId : 1

DefaultPriority : 1 NumTrafficClass : 3

DefaultSVPriority : 1

**Output field:**

| Field             | Description  |
|-------------------|--|
| PortId            | Port number of the port for which this entry contains bridge management information.   |
| DefaultPriority   | The default ingress User Priority which can be configured by the user. The default value of this attribute can be 0 or 0 depending on interface over which the bridge port is created. The default value is 0 for bridge port created over ethernet or aggregator interface. And the default value is 0 if the interface over which the bridge port has been created is one of EOA, PPPoE and IPoE.  |
| NumTrafficClass   | The number of egress traffic classes supported on this port. It depends on whether bridge port is over EOA, in which case, the max number of queues is value of maxnumeoaprioQs in gsvSystemSizingGroup and default value is also value of maxnumeoaprioQs in nbsize or over Ethernet / aggregated interface, in which case, the max number of queues is value of MaxNumEthPrioQs in nbsize and default value is also value of MaxNumEthPrioQs in nbsize. It is modifiable only when the bridge port is in disabled state. |
| DefaultSVPriority | Not supported  |

**References:**

Bridge port commands

## 5.2.3 Bridge port trfclassmap Commands

### 5.2.3.1 Get bridge port trfclassmap

**Description:**

Use this command to get.

**Command Syntax:**

**get bridge port trfclassmap** [**portid** <portid-val >] [**regenprio** <regenprio-val >]

### 5.2.3.2 Modify bridge port trfclassmap

**Description:**

Use this command to modify.

**Command Syntax:**

**modify bridge port trfclassmap portid** <portid-val > **regenprio** <regenprio-val >  
[**trfclass** <trfclass-val>]

**Parameters:**

| Name                                 | Description   |
|--------------------------------------|---|
| <b>portid</b> <portid-val >          | Port number of the port for which this entry contains bridge management information.<br><b>Type:</b> Modify – Mandatory<br>Get – Optional<br><b>Valid values:</b> 1-386   |
| <b>regenprio</b><br><regenprio-val > | The Priority value evaluated for the received frame. In our case, it is the regenerated user priority. This regenerated priority is mapped from user priority determined by a) packet classifier rule indicating user priority for that port b) user priority received in the tag header and c) default source priority of the port, in that order. It lies in the range 0-7<br><b>Type:</b> Modify – Mandatory<br>Get – Optional<br><b>Valid values:</b> 0 - 7 |
| <b>trfclass</b> <trfclass-val >      | The Traffic Class the received frame is mapped to. The maximum value of trafficClass is defined by numTrfClass parameter of Bridge Port PriInfo. The default value of this field shall be determined according to table 7-2 described in ANSI/IEEE Std 802.1d 1998 Edition  |

|  |   |
|--|---|
|  | <p>Document. This mapping is modifiable only when the bridge port is in disabled state.</p> <p><b>Type:</b> Modify — Optional</p> |
|--|---|

**Example:**

```
$ get bridge port trfclassmap portid 1 regenPrio 1
```

**Output:**

```
PortId      : 1          regenPrio : 1
TrafficClass : 2
```

**Output field:**

| Field               | Description  |
|---------------------|--|
| <b>PortId</b>       | Port number of the port for which this entry contains bridge management information.   |
| <b>regenPrio</b>    | The Priority value evaluated for the received frame. In our case, it is the regenerated user priority. This regenerated priority is mapped from user priority determined by a) packet classifier rule indicating user priority for that port b) user priority received in the tag header and c) default source priority of the port, in that order. It lies in the range 0-7 |
| <b>TrafficClass</b> | The Traffic Class the received frame is mapped to. The maximum value of trafficClass is defined by numTrfClass parameter of Bridge Port Prioinfo. The default value of this field shall be determined according to table 7-2 described in ANSI/IEEE Std 802.1d 1998 Edition Document. This mapping is modifiable only when the bridge port is in disabled state.             |

**References:**

Bridge port commands

## 5.2.4 Bridge port priomap Commands

### 5.2.4.1 Get bridge port priomap

**Description:**

Use this command to get.

**Command Syntax:**

**get bridge port priomap** [**portid** <portid-val >] [**usrprio** <usrprio-val >]

### 5.2.4.2 Modify bridge port priomap

**Description:**

Use this command to modify.

**Command Syntax:**

**modify bridge port priomap portid** <portid-val > **usrprio** <usrprio-val>  
[**regenprio** <regenprio-val >]

**Parameters:**

| Name                                 | Description  |
|--------------------------------------|--|
| <b>portid</b> <portid-val >          | Port number of the port for which this entry contains bridge management information.<br><b>Type:</b> Modify -- Mandatory<br>Get --Optional<br><b>Valid values:</b> 1-386                             |
| <b>usrprio</b> <usrprio-val >        | The User Priority for a frame received on this port. Since it can arrive in a tag header, it can have range 0-7.<br><b>Type:</b> Modify -- Mandatory<br>Get --Optional<br><b>Valid values:</b> 0 - 7 |
| <b>regenprio</b><br><regenprio-val > | The priority to which the incoming User priority is mapped for this port.<br><b>Type:</b> Modify --Optional<br><b>Valid values:</b> 0 - 7  |

**Example:**

```
$ get bridge port priomap portid 1 usrPrio 1
```

**Output:**

PortId : 1 UserPriority : 1

RegenUserPrio : 1

**Output field:**

| Field         | Description  |
|---------------|--|
| PortId        | Port number of the port for which this entry contains bridge management information.                             |
| UserPriority  | The User Priority for a frame received on this port. Since it can arrive in a tag header, it can have range 0-7. |
| RegenUserPrio | The priority to which the incoming User priority is mapped for this port.  |

**References:**

Bridge port commands



## 5.3 ABOND Commands

---

### 5.3.1 ABOND group intf Commands

#### 5.3.1.1 Get abond group intf

**Description:**

Use this command to get.

**Command Syntax:**

**get abond group intf [ifname <interface-name>]**

#### 5.3.1.2 Create abond group intf

**Description:**

Use this command to create.

**Command Syntax:**

**create abond group intf ifname<interface-name> groupid <groupid-val>**  
[ **minaggrrateupstrm <minaggrrateupstrm-val>** ] [ **minaggrratednstrm**  
**<minaggrratednstrm-val>** ] [ **diffdelaytolupstrm <diffdelaytolupstrm-val>** ]  
[ **diffdelaytoldnstrm <diffdelaytoldnstrm-val>** ] [ **asmprotocol Enable | Disable** ]  
[ **sidformat EightBitSid | TwelveBitSid** ] [ **maxrxbitrateratio**  
**<maxrxbitrateratio-val>** ] [ **linkhecthrshld <linkhecthrshld-val>** ]  
[ **numoflinksupforgrpup One | All** ] [ **asmirlthreshold <asmirlthreshold-val>** ]  
[ **maxatmportusrate <maxatmportusrate-val>** ]

#### 5.3.1.3 Delete abond group intf

**Description:**

Use this command to delete.

**Command Syntax:**

**delete abond group intf ifname <interface-name>**

### 5.3.1.4 Modify abond group intf

#### Description:

Use this command to modify.

#### Command Syntax:

```

modify abond group intf ifname <interface-name> [ groupid <groupid-val> ]
[ minaggrateupstrm <minaggrateupstrm-val> ] [ minaggratednstrm
<minaggratednstrm-val> ] [ diffdelaytolupstrm <diffdelaytolupstrm-val> ]
[ diffdelaytoldnstrm <diffdelaytoldnstrm-val> ] [ asmprotocol Enable | Disable ]
[ sidformat EightBitSid | TwelveBitSid ] [ maxrxbitrateratio
<maxrxbitrateratio-val> ] [ linkhecthrshld <linkhecthrshld-val> ]
[ numoflinksupforgrup One | All ] [ asmirlthreshold <asmirlthreshold-val> ]
[ maxatmportusrate <maxatmportusrate-val> ] [ enable | disable ]

```

#### Parameters:

| Name  | Description  |
|---|--|
| <b>ifname</b><br><interface-name>                 | This specifies the interface index used for the ATM Based Multi pair Bonding type of interfaces. Valid Value is abond-X. Modification and deletion is not possible if interface is enabled<br><br><b>Type:</b> Create – Mandatory<br>Delete -- Mandatory<br>Modify – Mandatory<br>Get – Optional<br><br><b>Valid values:</b> 0 - 31  |
| <b>groupid</b> <groupid-val>                      | This specifies the group id configured for this interface. This field is configured statically when the bonded group is provisioned and must not be changed while the group is in service. These fields may be used by an operator to help identify mis-configuration or to assist in management or debugging of the link.<br><br><b>Type:</b> Create – Mandatory<br>Modify – Optional |
| <b>minaggrateupstrm</b><br><minaggrateupstrm-val> | Minimum Aggregate Data Rate in bits per second in Upstream direction.<br><br><b>Type:</b> Create – Optional<br>Modify – Optional<br><br><b>Default value:</b> 0  |
| <b>minaggratednstrm</b><br><minaggratednstrm-val> | Minimum Aggregate Data Rate in bits per second in Downstream direction.<br><br><b>Type:</b> Create – Optional<br>Modify – Optional<br><br><b>Default value:</b> 0  |

|   |  |
|---|--|
| <b>diffdelaytolupstrm</b><br><diffdelaytolupstrm-val> | The maximum differential delay among member links in a bonding group in Upstream direction. <b>Type:</b> Create – Optional<br>Modify – Optional<br><b>Valid values:</b> 0 -4<br><b>Default value:</b> 4  |
| <b>diffdelaytoldnstrm</b><br><diffdelaytoldnstrm-val> | The maximum differential delay among member links in a bonding group in downstream direction. <b>Type:</b> Create – Optional<br>Modify – Optional<br><b>Valid values:</b> 0 -24<br><b>Default value:</b> 4   |
| <b>asmprotocol Enable</b><br> Disable                 | This parameter specifies whether Autonomous Status Messages will be exchanged between CO and CPE. If it is disabled then the group would be bonded statically and CO would assume CPE to know all the configuration parameters like SID format, number of links in the bonded group and the links participating in bonding. If it is enabled then CO would inform all these parameters to CPE using Autonomous Status Messages.<br><b>Type:</b> Create – Optional<br>Modify – Optional<br><b>Default value:</b> enable |
| <b>sidformat EightBitSid</b><br> TwelveBitSid         | SID Format: 8 bit or 12 bit SID. Only 8 bit format is being supported<br><b>Type:</b> Create – Optional<br>Modify – Optional<br><b>Default value:</b> 1  |
| <b>maxrxbitrateratio</b><br><maxrxbitrateratio-val>   | The maximum bit rate ratio among member links in a bonding group in upstream direction.<br><b>Type:</b> Create – Optional<br>Modify – Optional<br><b>Valid values:</b> 1 -4<br><b>Default value:</b> 4   |
| <b>linkhecthrshld</b><br><linkhecthrshld-val>         | HEC Error percentage of the link upstream rate which will act as Threshold for link to be part of group in Rx direction<br><b>Type:</b> Create – Optional<br>Modify – Optional<br><b>Valid values:</b> 1 -10<br><b>Default value:</b> 2  |
| <b>numoflinksupforgrpup</b><br>One   All              | This field specifies the number of links required to be up for bonding to start ASM protocol<br><b>Type:</b> Create – Optional<br>Modify – Optional<br><b>Default value:</b> 0   |

|   |  |
|---|--|
| <b>asmirlthreshold</b><br><asmirlthreshold-val>   | IRL Threshold for ASM messages<br><b>Type:</b> Create — Optional<br>Modify — Optional<br><b>Valid values:</b> 1 -8<br><b>Default value:</b> 8                          |
| <b>maxatmportusrate</b><br><maxatmportusrate-val> | Maximum ATM port Upstream Rate<br><b>Type:</b> Create — Optional<br>Modify — Optional<br><b>Valid values:</b> 0 -8000<br><b>Default value:</b> 4000                    |
| <b>enable   disable</b>                           | Administrative status of the interface.<br><b>Type:</b> Create — Optional<br>Modify — Optional<br><b>Valid values:</b> enable, disable<br><b>Default value:</b> enable |

**Example:**

```
$ create abond group intf ifname abond-0 groupid 1 minaggrrateupstrm 5
minaggrratednstrm 5 diffdelaytolupstrm 0 diffdelaytoldnstrm 0 asmprotocol Disable
sidformat EightBitSID maxrxbitrateratio 2 linkhecthrshld 1 numoflinksupforgrpup
One asmirlthreshold 0 maxatmportusrate 0
```

**Output:**

```
Verbose Mode On
Entry Created
ifname           : abond-0      GroupId          : 1
MinAggrRateUpstrm : 5          MinAggrRateDnstrm : 5
DiffDelayTolUpstrm : 4          DiffDelayTolDnstrm : 4
AsmProtocol       : Disable     SidFormat         : EightBitSID
MaxRxBitRateRatio : 2          LinkHecThreshold : 1
CtrlVpi           : 0          CtrlVci           : 0
NoOfLinksUpForGrpUp : One       AsmIrlThreshold  : 0
MaxAtmPortUsRate  : 0
Oper Status       : Up          Admin Status      : Enable
Verbose Mode Off:
```

## Output Fields:

| Field                      | Description   |
|----------------------------|---|
| <b>ifname</b>              | This specifies the interface index used for the ATM Based Multi pair Bonding type of interfaces. Valid Value is abond-X. Modification and deletion is not possible if interface is enabled  |
| <b>GroupId</b>             | This specifies the group id configured for this interface. This field is configured statically when the bonded group is provisioned and must not be changed while the group is in service. These fields may be used by an operator to help identify mis-configuration or to assist in management or debugging of the link.  |
| <b>MinAggrRateUpstrm</b>   | Minimum Aggregate Data Rate in bits per second in Upstream direction.   |
| <b>MinAggrRateDnstrm</b>   | Minimum Aggregate Data Rate in bits per second in Downstream direction.   |
| <b>DiffDelayToUpstrm</b>   | The maximum differential delay among member links in a bonding group in Upstream direction.   |
| <b>DiffDelayToDnstrm</b>   | The maximum differential delay among member links in a bonding group in downstream direction.   |
| <b>AsmProtocol</b>         | This parameter specifies whether Autonomous Status Messages will be exchanged between CO and CPE. If it is disabled then the group would be bonded statically and CO would assume CPE to know all the configuration parameters like SID format, number of links in the bonded group and the links participating in bonding. If it is enabled then CO would inform all these parameters to CPE using Autonomous Status Messages. |
| <b>SidFormat</b>           | SID Format: 8 bit or 12 bit SID. Only 8 bit format is being supported   |
| <b>MaxRxBitRateRatio</b>   | The maximum bit rate ratio among member links in a bonding group in upstream direction.   |
| <b>LinkHecThreshold</b>    | HEC Error percentage of the link upstream rate which will act as Threshold for link to be part of group in Rx direction   |
| <b>CtrlVpi</b>             | Control Channel VPI: VPI value being used for Sending and Receiving ASM Messages  |
| <b>CtrlVci</b>             | Control Channel VCI: VCI value being used for Sending and Receiving ASM Messages  |
| <b>NoOfLinksUpForGrpUp</b> | This field specifies the number of links required to be up for bonding to start ASM protocol  |
| <b>AsmIrlThreshold</b>     | IRL Threshold for ASM messages  |
| <b>MaxAtmPortUsRate</b>    | Maximum ATM port Upstream Rate  |
| <b>Oper Status</b>         | The actual/current state of the interface. It can be either up or down.   |

## 5.3.2 ABOND group stats Commands

### 5.3.2.1 Get abond group stats

**Description:**

Use this command to get.

**Command Syntax:**

**get abond group stats [ifname <interface-name>]**

### 5.3.2.2 Reset abond group stats

**Description:**

Use this command to reset.

**Command Syntax:**

**reset abond group stats ifname <interface-name>**

**Parameters:**

| Name                              | Description   |
|-----------------------------------|---|
| <b>ifname</b><br><interface-name> | This specifies the interface index used for the ATM based Multi pair Bonding type of interfaces. Valid value is abond-X<br><b>Type:</b> Reset — Mandatory<br>Get — Optional<br><b>Valid values:</b> abond-0-abond-1 |

**Example:**

\$ get abond group stats ifname abond-0

**Output:**

```
ifname : abond-0
AchievedAggrRateUpstrm : 10      AchievedAggrRateDnstrm : 12
CellLossUpstrmCurrent : 12      CellLossDnstrmCurrent : 20
CellLossUpstrmPrv15min : 12     CellLossDnstrmPrev15Min : 20
CellLossUpstrmCurrentDay : 12   CellLossDnstrmCurrentDay : 20
CellLossUpstrmPrevDay : 12     CellLossDnstrmPrevDay : 20
GroupFailureCntCurrent : 15     GroupFailureCntPrev15Min : 15
GrpFailureCntCurrentDay : 15    GrpFailureCntPrevDay : 15
GrpUnavailableSecCurrent : 15   GrpUnavailableSecPrev15Min : 15
GrpUnavailblSecCurrentDay : 15  GrpUnavailblSecPrevDay : 15
ASMTxCnt : 10                 ASMRxCnt : 10
```

GrpFailureReason : MinRateNotAchievedUpAndDn  
 AsmRxCrcErrorCount : 10

### Output Fields:

| Field                             | Description   |
|-----------------------------------|---|
| <b>ifname</b>                     | This specifies the interface index used for the ATM Based Multi pair Bonding type of interfaces. Valid Value is abond-X |
| <b>AchievedAggrRateUpstrm</b>     | Achieved aggregate data rate in bits per sec in upstream direction.   |
| <b>AchievedAggrRateDnstrm</b>     | Achieved aggregate data rate in bits per sec in downstream direction.   |
| <b>CellLossUpstrmCurrent</b>      | Group cell loss count upstream for current 15 minutes.  |
| <b>CellLossDnstrmCurrent</b>      | Group Rx cell loss count downstream for current 15 minutes.   |
| <b>CellLossUpstrmPrv15min</b>     | Group cell loss count upstream for Last 15 minutes.   |
| <b>CellLossDnstrmPrev15Min</b>    | Group cell loss count downstream for Last 15 minutes.   |
| <b>CellLossUpstrmCurrentDay</b>   | Group cell loss count upstream for current Day.   |
| <b>CellLossDnstrmCurrentDay</b>   | Group Rx cell loss count downstream for current Day.  |
| <b>CellLossUpstrmPrevDay</b>      | Group Rx cell loss count upstream for previous Day.   |
| <b>CellLossDnstrmPrevDay</b>      | Group Rx cell loss count downstream for Previous Day.   |
| <b>GroupFailureCntCurrent</b>     | Group failure count for current 15 minutes.   |
| <b>GroupFailureCntPrev15Min</b>   | Group failure count for previous 15 minutes.  |
| <b>GrpFailureCntCurrentDay</b>    | Group failure count for current Day.  |
| <b>GrpFailureCntPrevDay</b>       | Group failure count for previous Day.   |
| <b>GrpUnavailableSecCurrent</b>   | Group unavailable second current.   |
| <b>GrpUnavailableSecPrev15Min</b> | Group unavailable second previous 15 Min.   |
| <b>GrpUnavailblSecCurrentDay</b>  | Group unavailable second current Day.   |
| <b>GrpUnavailblSecPrevDay</b>     | Group unavailable second for previous Day.  |
| <b>ASMTxCnt</b>                   | Group ASM Tx count.   |
| <b>ASMRxCnt</b>                   | Group ASM Rx count.   |
| <b>GrpFailureReason</b>           | Failure reason for the abond Group.   |
| <b>AsmRxCrcErrorCount</b>         | group Asm Rx crc error count.   |

## 5.3.3 ABOND link entry Commands

### 5.3.3.1 Get abond link entry

**Description:**

Use this command to get.

**Command Syntax:**

**get abond link entry [ifname <interface-name>] [lowif <lowif-val>]**

### 5.3.3.2 Create abond link entry

**Description:**

Use this command to create.

**Command Syntax:**

**create abond link entry ifname <interface-name> lowif <lowif-val>  
[txlinkadminstatus Enable | Disable] [rxlinkadminstatus Enable | Disable]  
[asmrxgroupintf <asmrxgroupintf>] [asmrxlinkindex <asmrxlinkindex>]**

### 5.3.3.3 Delete abond link entry

**Description:**

Use this command to delete.

**Command Syntax:**

**delete abond link entry ifname <interface-name> lowif <lowif-val>**

### 5.3.3.4 Modify abond link entry

**Description:**

Use this command to modify.

**Command Syntax:**

**modify abond link entry ifname <interface-name> lowif <lowif-val>  
[txlinkadminstatus Enable | Disable] [rxlinkadminstatus Enable | Disable]**



## Parameters:

| Name   | Description  |
|--|--|
| <b>ifname</b><br><interface-name>            | This specifies the interface index used for the ATM Based Multi pair Bonding type of interfaces. Valid Value is abond-X. Link can not be created, deleted or modified if associated abond group interface is enabled.<br><b>Type:</b> Create – Mandatory<br>Delete – Mandatory<br>Modify – Mandatory<br>Get – Optional<br><b>Valid values:</b> abond-0-abond-1 |
| <b>lowif</b> <lowif-val>                     | This specifies the interface index used for the abond link (DSL) entry. Valid Value is dsl-X ,dsl-X , dslf-X<br><b>Type:</b> Create – Mandatory<br>Delete – Mandatory<br>Modify – Mandatory<br>Get – Optional  |
| <b>txlinkadminstatus</b><br>Enable   Disable | This specifies the Tx Status for the link in a Group. <b>Type:</b><br>Create – Optional<br>Modify – Optional<br><b>Default value:</b> enable   |
| <b>rxlinkadminstatus</b><br>Enable   Disable | This specifies the Rx Status for the link in a Group. <b>Type:</b><br>Create – Optional<br>Modify – Optional<br><b>Default value:</b> enable   |
| <b>asmrxgroupintf</b><br><asmrxgroupintf>    | Abond group Interface Index of proxy link.<br><b>Type:</b> Create -- Optional<br><b>Valid values:</b> abond-0_ABONDGR_MAX_IFINDEX<br><b>Default value:</b> 0xffffffff  |
| <b>asmrxlinkindex</b><br><asmrxlinkindex>    | Lower Interface Index of Proxy link.<br><b>Type:</b> Create -- Optional<br><b>Default value:</b> 0xffffffff  |

## Example:

```
$ create abond link entry ifname abond-0 lowif dsl-0 txlinkadminstatus enable
rxLinkadminstatus enable asmrXgroupintf abond-0 asmrXlinkindex dsl-0
```

**Output:**

Verbose Mode On

Entry Created

```

ifname          : abond-0    lowif           : dsl-0
AsmRxGroupIntf : abond-0    AsmRxLinkIndex : dsl-0
TxLinkAdminStatus : enable    RxLinkAdminStatus : enable
TxLinkOperStatus : Disable    RxLinkOperStatus  : Disable
AsmTxLinkStatus  : SelectedToCarryBondingTraffic
AsmRxLinkStatus  : SelectedToCarryBondingTraffic

```

Verbose Mode Off:

Entry Created

**Output Fields:**

| Field                    | Description  |
|--------------------------|--|
| <b>ifname</b>            | This specifies the interface index used for the ATM Based Multi pair Bonding type of interfaces. Valid Value is abond-X. Link can not be created , deleted or modified if associated abond group interface is enabled. |
| <b>lowif</b>             | This specifies the interface index used for the abond link (DSL) entry. Valid Value is dsl-X ,dsl-X , dsif-X   |
| <b>AsmRxGroupIntf</b>    | Abond group Interface Index of proxy link.   |
| <b>AsmRxLinkIndex</b>    | Lower Interface Index of Proxy link.   |
| <b>TxLinkAdminStatus</b> | This specifies the Tx Status for the link in a Group.  |
| <b>RxLinkAdminStatus</b> | This specifies the Rx Status for the link in a Group.  |
| <b>TxLinkOperStatus</b>  | The current operational status of the abond link in Tx direction.  |
| <b>RxLinkOperStatus</b>  | This specifies the rx operational Status for the link in a Group.  |
| <b>AsmTxLinkStatus</b>   | The current Tx Link status of the abond link as reflected in ASM Messages.   |
| <b>AsmRxLinkStatus</b>   | The current Rx Link status of the abond link as reflected in ASM Messages.   |

## 5.3.4 ABOND link stats Commands

### 5.3.4.1 Get abond link stats

**Description:**

Use this command to get.

**Command Syntax:**

**get abond link stats [ifname <interface-name>] [lowif <lowif-val>]**

### 5.3.4.2 Reset abond link stats

**Description:**

Use this command to reset.

**Command Syntax:**

**reset abond link stats ifname<interface-name> lowif <lowif-val>**

**Parameters:**

| Name                              | Description  |
|-----------------------------------|--|
| <b>ifname</b><br><interface-name> | This specifies the interface index used for the ATM Based Multi pair Bonding type of interfaces. Valid Value is abond-X<br><b>Type:</b> Reset – Mandatory<br>Get – Optional<br><b>Valid values:</b> 0 – 30 |
| <b>lowif &lt;lowif-val&gt;</b>    | This specifies the interface index used for the abond link (DSL) interfaces. Valid Value is dsl-X, dsli-X, dslf-X<br><b>Type:</b> Reset – Mandatory<br>Get – Optional                                      |

**Example:**

```
$ get abond link stats ifname abond-0 lowif dsl-0
```

**Output**

```
ifname           : abond-0    lowif           : dsl-0
ASMTxCount       : 10          ASMRxCount      : 10
TxLinkFailureReason : HecLimitExceeded
RxLinkFailureReason : HecLimitExceeded
```

## Output Fields:

| Field                      | Description   |
|----------------------------|---|
| <b>ifname</b>              | This specifies the interface index used for the ATM Based Multi pair Bonding type of interfaces. Valid Value is abond-X |
| <b>lowif</b>               | This specifies the interface index used for the abond link (DSL) interfaces. Valid Value is dsl-X, dsli-X, dslf-X       |
| <b>ASMTxCount</b>          | Per-link ASM Tx count. These are not exact counts and have been kept for debugging.                                     |
| <b>ASMRxCount</b>          | Per-link ASM Rx count. These are not exact counts and have been kept for debugging.                                     |
| <b>TxLinkFailureReason</b> | Failure reason for the abond link in Tx direction.  |
| <b>RxLinkFailureReason</b> | Failure reason for the abond link in Rx direction.  |

## 5.4 Aggregation commands

---

### 5.4.1 Active Standby aggr info Commands

#### 5.4.1.1 Get actstdby aggr info

**Description:**

Use this command to get.

**Command Syntax:**

**get actstdby aggr info [ifname <interface-name>]**

#### 5.4.1.2 Modify actstdby aggr info

**Description:**

Use this command to create.

**Command Syntax:**

**modify actstdby aggr info ifname <interface-name> [status Enable | Disable]**

### Parameters:

| Name                              | Description  |
|-----------------------------------|--|
| <b>ifname</b> ifname              | This specifies the aggregator interface index on which active standby is to be enabled. Valid Value is aggr-0.<br><b>Type:</b> Modify -- Mandatory<br>Get -- Optional<br><b>Valid values:</b> aggr-0 |
| <b>Status</b><br>enable   disable | This specifies whether active standby mode is to be enabled or not.<br><b>Type:</b> Modify -- Optional   |

### Example:

```
$ get actstdby aggr info IfName aggr-0
```

### Output:

Interface Index : aggr-0

Status : Enable

### Output Fields:

| Field                  | Description  |
|------------------------|--|
| <b>Interface Index</b> | This specifies the aggregator interface index on which active standby is to be enabled. Valid Value is aggr-0. |
| <b>Status</b>          | This specifies whether active standby mode is to be enabled or not.  |

### Caution:

- Active Standby mode shall not be enabled, if aggregator interface and redundancy aggregator are not created, or if LACP aggregator is created for the aggregator interface.
- If only Active Standby is desired and no load sharing is expected then bridge port shall be created over the aggregator only after Active Standby has been enabled for redundancy aggregator. If the bridge port is created over aggregator before enabling Active Standby for it, the load sharing shall start and continue till Active Standby is enabled.
- 

### References:

Redundancy commands.

## 5.4.2 Aggr info Commands

### 5.4.2.1 Get aggr intf

**Description:**

Use this command to get.

**Command Syntax:**

**get aggr intf** [ifname <interface-name>]

### 5.4.2.2 Create aggr intf

**Description:**

Use this command to create.

**Command Syntax:**

**create aggr intf ifname** <interface-name> [ **ip** <ip-val> ] [ **mask** <mask-val> ]  
[ **usedhcp** **False** | **True** ] [ **mgmtvlanid** <mgmtvlanid-val> ] [ **mgmtsvlanid**  
<mgmtsvlanid-val> ] [ **priority** <priority-val> ] [ **enable** | **disable** ]

### 5.4.2.3 Delete aggr intf

**Description:**

Use this command to delete.

**Command Syntax:**

**get aggr intf** [ifname <interface-name>]

### 5.4.2.4 Modify aggr intf

**Description:**

Use this command to create.

**Command Syntax:**

**create aggr intf ifname** <interface-name> [ **ip** <ip-val> ] [ **mask** <mask-val> ]  
[ **usedhcp** **False** | **True** ] [ **mgmtvlanid** <mgmtvlanid-val> ] [ **mgmtsvlanid**  
<mgmtsvlanid-val> ] [ **priority** <priority-val> ] [ **enable** | **disable** ]

## Parameters:

| Name                                  | Description   |
|---------------------------------------|---|
| <b>ifname</b> <interface-name>        | <p>This specifies the interface index used for the Aggregator type of interfaces. Valid Value is aggr-0 <b>Type:</b> Create – Mandatory</p> <p>Delete – Mandatory</p> <p>Modify – Mandatory</p> <p>Get – Optional</p> <p><b>Valid values:</b> 0</p>   |
| <b>ip</b> <ip-val>                    | <p>This specifies the IP address configured for the interface.</p> <p><b>Type:</b> Create – Optional</p> <p>Modify – Optional</p> <p><b>Default value:</b> 0.0.0.0</p>  |
| <b>mask</b> <mask-val>                | <p>This specifies the network mask configured for the interface. If either of 'IP Address' or 'mask' is non-null the other must also be non-null and vice versa. <b>Type:</b> Create – Optional</p> <p>Modify – Optional</p> <p><b>Default value:</b> 0.0.0.0</p>   |
| <b>usedhcp</b> False   True           | <p>This specifies whether a DHCP client is to be triggered to obtain an IP address for this interface from a DHCP server.</p> <p><b>Type:</b> Create – Optional</p> <p>Modify – Optional</p> <p><b>Valid values:</b> False, True</p> <p><b>Default value:</b> false</p>   |
| <b>mgmtvlanid</b><br><mgmtvlanid-val> | <p>VLAN(C-Vlan) for management traffic on this interface. Non-zero value of this field is valid only if either 'ip' field is non-zero or 'usedhcp' field is true. If no Management Vlanid is specified (in the create operation) or it's value is set to zero (either in create or modify operation) then the system shall use the value of 'portvlanid' associated with the bridge port created on this interface as the Management Vlan Index. In case the management vlan (i.e. 'mgmtvlanid' or the associated 'portvlanid', if 'mgmtvlanid' is zero) doesn't exist on the system then IP based management on this management VLAN shall not happen on the interface till the corresponding VLAN is created with the Net side port as its member.</p> <p><b>Type:</b> Create – Optional</p> <p>Modify – Optional</p> <p><b>Valid values:</b> 0 – 4095</p> <p><b>Default value:</b> 0</p> |

|   |  |
|---|--|
| <b>mgmtsvlanid</b><br><mgmtsvlanid-val> | <p>Applicable only in stacked vlan mode, this is S-Vlan for management traffic on this interface. Non-zero value of this field is valid only if either 'ip' field is nonzero or 'usedhcp' field is true. If no management Svlanid is specified (in the create operation) or it's value is set to zero (either in create or modify operation) then the system shall use the value of 'psvlanid' associated with the bridge port created on this interface as the management vlan id. In case the management vlan (virtual vlan mapped to S-VLAN and C-VLAN for the frame) doesn't exist (ie. Virtual vlan mapped to 'mgmtsvlanid' or the associated 'psvlanid ', if 'mgmtsvlanid' is zero) on the system then IP based management shall not happen on the interface till the corresponding virtual-VLAN is created with the Net side port as its member.</p> <p><b>Type:</b> Create – Optional<br/>         Modify – Optional</p> <p><b>Valid values:</b> 0 – 4095</p> <p><b>Default value:</b> 0</p> |
| <b>priority</b> <priority-val>          | <p>Priority to be set in Tagged Ethernet PDUs sent on Management VLAN over this interface. This field is valid only if either 'ip' field is non-zero or 'usedhcp' field is true. In Native Vlan mode this priority shall be used for C-Vlan tag while in stacked vlan mode it shall be used for S-Vlan tag.</p> <p><b>Type:</b> Create – Optional<br/>         Modify – Optional</p> <p><b>Valid values:</b> 0 - 7</p> <p><b>Default value:</b> 7</p>  |
| <b>enable   disable</b>                 | <p>Administrative status of the interface.</p> <p><b>Type:</b> Create -- Optional<br/>         Modify -- Optional</p> <p><b>Valid values:</b> enable, disable</p> <p><b>Default value:</b> enable</p>  |

**Example:**

```
$ create aggr intf IfName aggr-0 ip 172.25.100.100 mask 255.255.0.0 usedhcp
False mgmtvlanid 2 mgmtsvlanid 2 priority 2 enable
```



**Output:**

Verbose Mode On

Entry Created

Interface Index : aggr-0

IP Address : 172.25.100.100 Mask : 255.255.0.0

UseDhcp : False

Mgmt VLAN Index : 2

Mgmt S-VLAN Index : 2

Tagged Mgmt PDU Prio : 2

Oper Status : Up Admin Status : Enable

Verbose Mode Off:

Entry Created

**Output Fields:**

| Field                    | Description   |
|--------------------------|---|
| <b>Interface Index</b>   | This specifies the interface index used for the Aggregator type of interfaces. Valid Value is aggr-0  |
| <b>IP Address</b>        | This specifies the IP address configured for the interface.   |
| <b>Mask</b>              | This specifies the network mask configured for the interface. If either of 'IP Address' or 'mask' is non-null the other must also be non-null and vice versa.   |
| <b>UseDhcp</b>           | This specifies whether a DHCP client is to be triggered to obtain an IP address for this interface from a DHCP server.  |
| <b>Mgmt VLAN Index</b>   | VLAN(C-Vlan) for management traffic on this interface. Non-zero value of this field is valid only if either 'ip' field is non-zero or 'usedhcp' field is true. If no Management Vlanid is specified (in the create operation) or it's value is set to zero (either in create or modify operation) then the system shall use the value of 'portvlanid' associated with the bridge port created on this interface as the Management Vlan Index. In case the management vlan (i.e. 'mgmtvlanid' or the associated 'portvlanid', if 'mgmtvlanid' is zero) doesn't exist on the system then IP based management on this management VLAN shall not happen on the interface till the corresponding VLAN is created with the Net side port as its member. |
| <b>Mgmt S-VLAN Index</b> | Applicable only in stacked vlan mode, this is S-Vlan for management traffic on this interface. Non-zero value of this field is valid only if either 'ip' field is nonzero or 'usedhcp' field is true. If no management Svlanid is specified (in the create operation) or it's value is set to zero (either in create or modify operation) then the system shall use the value of 'psvlanid' associated with the bridge port created on this   |

|                             |   |
|-----------------------------|---|
|                             | interface as the management vlan id. In case the management vlan (virtual vlan mapped to S-VLAN and C-VLAN for the frame) doesn't exist (ie. Virtual vlan mapped to 'mgmtsvlanid' or the associated 'psvlanid', if 'mgmtsvlanid' is zero) on the system then IP based management shall not happen on the interface till the corresponding virtual-VLAN is created with the Net side port as its member. |
| <b>Tagged Mgmt PDU Prio</b> | Priority to be set in Tagged Ethernet PDUs sent on Management VLAN over this interface. This field is valid only if either 'ip' field is non-zero or 'usedhcp' field is true. In Native Vlan mode this priority shall be used for C-Vlan tag while in stacked vlan mode it shall be used for S-Vlan tag.  |
| <b>Oper Status</b>          | The actual/current state of the interface. It can be either up or down.   |
| <b>Admin Status</b>         | The desired state of the interface. It may be either Up or Down.  |

### Cautions:

- If an aggregator interface is being created, all configurations of aggregated links (layer2 Ethernet interfaces), should be same.

## 5.4.3 LACP Aggr Commands

### 5.4.3.1 Get lacp aggr

#### Description:

Use this command to get.

#### Command Syntax:

```
gets lacp aggr [aggrifname <aggrifname-val >]
```

### 5.4.3.2 Create lacp aggr

#### Description:

Use this command to create.

#### Command Syntax:

```
create lacp aggr aggrifname <aggrifname-val> [actorsystemprio
<actorsystemprio-val>] [actoradminkey <actoradminkey-val>]
[collectormaxdelay <collectormaxdelay-val>] [aggrtype Static | LACP]
```

### 5.4.3.3 Delete lACP aggr

**Description:**

Use this command to delete.

**Command Syntax:**

**delete lACP aggr aggrifname** <aggrifname-val>

### 5.4.3.4 Delete lACP aggr

**Description:**

Use this command to modify.

**Command Syntax:**

**modify lACP aggr aggrifname** <aggrifname-val> [**actorsystemprio** <actorsystemprio-val>] [**actoradminkey** <actoradminkey-val>] [**collectormaxdelay** <collectormaxdelay-val>] [**aggrtype Static | LACP**]

**Parameters:**

| Name  | Description  |
|---|--|
| <b>aggrifname</b><br><aggrifname-val>               | The Aggregator interface name.<br><b>Type:</b> Create --- Mandatory<br>Delete — Mandatory<br>Modify — Mandatory<br>Get — Optional<br><b>Valid values:</b> aggr-0   |
| <b>actorsystemprio</b><br><actorsystemprio-val>     | A 2-octet read-write value indicating the priority value associated with the Actor's System ID.<br><b>Type:</b> Create — Optional<br>Modify — Optional<br><b>Valid values:</b> 0 - 255<br><b>Default value:</b> 10 |
| <b>actoradminkey</b><br><actoradminkey-val>         | The current administrative value of the Key for the Aggregator<br><b>Type:</b> Create Optional<br>Modify Optional<br><b>Valid values:</b> 0 - 65535<br><b>Default value:</b> 0                                     |
| <b>collectormaxdelay</b><br><collectormaxdelay-val> | The value of this 16-bit read-write attribute defines the maximum delay, in tens of microseconds, that may be imposed by the   |

|                               |  |
|-------------------------------|--|
|                               | <p>Frame Collector between receiving a frame from an Aggregator Parser, and either delivering the frame to its MAC Client or discarding the frame.</p> <p><b>Type:</b> Create — Optional<br/> Modify — Optional</p> <p><b>Valid values:</b> 0 - 65535</p> <p><b>Default value:</b> 0</p> |
| <b>aggrtype Static   LACP</b> | <p>Aggregation type. It can be either static or lacp</p> <p><b>Type:</b> Create — Optional<br/> Modify — Optional</p> <p><b>Default value:</b> Static</p>  |

**Example:**

```
$ create lacp aggr aggrifname aggr-0 actorsystemprio 2 actoradminkey 1000
collectormaxdelay 2 aggrtype Static
```

**Output:**

```
Verbose Mode On
Entry Created
Aggr IfName      : aggr-0
Mac Address      : 23:45:67:89:00:01 Aggregate           : true
Actor Sys Priority : 2                               Partner Sys Priority : 2
Actor Sys ID     : 23:45:67:89:00:01
Partner Sys ID   : 23:45:67:89:00:01
Actor Oper Key   : 10                               Partner Oper Key     : 2
Actor Admin Key  : 1000                             Collector Max Delay  : 2
Aggregation Type : Static
Verbose Mode Off:
Entry Created
```

**Output Fields:**

| Field                     | Description   |
|---------------------------|---|
| <b>Aggr IfName</b>        | The Aggregator interface name.  |
| <b>Mac Address</b>        | A 6-octet read-only value carrying the individual MAC address assigned to the Aggregator.                                 |
| <b>Aggregate</b>          | A read-only Boolean value indicating whether the Aggregator represents an Aggregate (TRUE) or an Individual link (FALSE). |
| <b>Actor Sys Priority</b> | A 2-octet read-write value indicating the priority value  |

|                             |   |
|-----------------------------|---|
|                             | associated with the Actor's System ID.  |
| <b>Partner Sys Priority</b> | A 2-octet read-only value that indicates the priority value associated with the Partners SystemID.  |
| <b>Actor Sys ID</b>         | A 6-octet read only MAC address value used as a unique identifier for the System that contains this Aggregator.   |
| <b>Partner Sys ID</b>       | A 6-octet read-only MAC address value consisting of the unique identifier for the current protocol Partner of this Aggregator.A value of zero indicates that there is no known Partner.   |
| <b>Actor Oper Key</b>       | The current operational value of the Key for the Aggregator.  |
| <b>Partner Oper Key</b>     | The current operational value of the Key for the Aggregator is current protocol Partner.  |
| <b>Actor Admin Key</b>      | The current administrative value of the Key for the Aggregator  |
| <b>Collector Max Delay</b>  | The value of this 16-bit read-write attribute defines the maximum delay,in tens of microseconds,that may be imposed by the Frame Collector between receiving a frame from an Aggregator Parser,and either delivering the frame to its MAC Client or discarding the frame. |
| <b>Aggregation Type</b>     | Aggregation type. It can be either static or lacp   |

### Cautions:

- LACP aggregator creation shall fail, if aggregator interface is not created.
- LACP aggregator shall not be created, if Redundancy aggregator is created for an aggregator interface.

### References:

- create aggr intf
- get aggr intf

## 5.4.4 LACP AGGRPort Info Commands

### 5.4.4.1 Get aggrport info

**Description:**

Use this command to get a LACP aggregator port information.

**Command Syntax:**

**get lacp aggrport info** [ifname <interface-name>]

### 5.4.4.2 Modify lacp aggrport info

**Description:**

Use this command to modify LACP aggregator port information.

**Command Syntax:**

**modify lacp aggrport info ifname** <interface-name> [**actoradminkey** <actoradminkey-val>] [**partadminkey** <partadminkey-val>] [**actorportprio** <actorportprio-val>] [**partadminportprio** <partadminportprio-val>] [**actorsysprio** <actorsysprio-val>] [**partadminsysprio** <partadminsysprio-val>] [**partadminsysid** <partadminsysid-val>] [**partadminport** <partadminport-val>] [**actoradminstate activity | timeout | aggr**] [**partadminstate activity | timeout | aggr**] [**aggrstatus enable|disable**] [**pktpriority** <pktpriority-val>]

**Parameters:**

| Name  | Description   |
|---|---|
| <b>ifname</b><br><interface-name>           | The <b>IfName</b> of the Ethernet interface for the aggregator.<br><b>Type</b> : Modify – Mandatory<br>Get – Optional<br><b>Valid values</b> : eth-*, eoa-*           |
| <b>actoradminkey</b><br><actoradminkey-val> | The current administrative value of the Key for the Aggregator.<br><b>Type</b> : Optional<br><b>Valid values</b> : 1 - 2 <sup>16</sup> – 1                            |
| <b>partadminkey</b><br><partadminkey-val>   | The current administrative value of the Key for the Aggregator's current protocol Partner.<br><b>Type</b> : Optional<br><b>Valid values</b> : 1 - 2 <sup>16</sup> – 1 |
| <b>actorportprio</b>                        | The priority value assigned to this Aggregation   |

|  |   |
|--|---|
| <actorportprio-val>  | Port <b>Type</b> : Optional<br><b>Valid values</b> : 0 - 2 <sup>8</sup> – 1   |
| <b>partadminportprio</b><br><partadminportprio-val<br>>              | The current administrative value of the port priority,<br>for the protocol Partner.<br><b>Type</b> : Optional<br><b>Valid values:</b> 0 – 255   |
| <b>actorsysprio</b><br><actorsysprio-val>                            | A 2-octet read-write value indicating the priority<br>value associated with the Actor's System ID.<br><b>Type</b> : Optional<br><b>Valid values:</b> 0 – 255  |
| <b>partadminsysprio</b><br><partadminsysprio-val>                    | A 2-octet read-only value that indicates the priority<br>value associated with the Partner's System ID.<br><b>Type</b> : Optional<br><b>Valid values:</b> 0 - 255   |
| <b>partadminsysid</b><br><partadminsysid-val>                        | A 6-octet read-write MACAddress value<br>representing the administrative value of the<br>Aggregation Port's protocol Partner's SystemID<br><b>Type</b> : Optional<br><b>Valid values:</b> 00:00:00:00:00:00 - ff:ff:ff:ff:ff:ff |
| <b>partadminport</b><br><partadminport-val>                          | The current administrative value of the port<br>number for the protocol Partner.<br><b>Type</b> : Optional<br><b>Valid values:</b> 0 - 65535  |
| <b>actoradminstate</b><br><b>activity   timeout  </b><br><b>aggr</b> | Administrative state of actor<br><b>Type:</b> Optional  |
| <b>partadminstate</b><br><b>activity   timeout  </b><br><b>aggr</b>  | Administrative state of Partner.<br><b>Type:</b> Optional   |
| <b>aggrstatus</b><br><b>enable disable</b>                           | Specifies whether aggregation(bonding) is to be<br>enabled over this Aggregation Port.<br><b>Type</b> : Optional<br><b>Valid values:</b> enable disable   |
| <b>pktpriority</b><br><pktpriority-val>                              | For LACP PDUs, this priority shall be used for<br>choice of traffic class/Queue on outgoing interface.<br><b>Type:</b> Modify Optional<br><b>Valid values:</b> 0 - 7  |

**Example:**

```
$ get lacp aggrport info ifname eth-0
```

**Output:**

```
Interface                : eth-0                Port Is Aggregate        : true
Actor Oper Key           : 10                 Partner Oper Key         : 2
Actor Admin Key          : 1000              Partner Admin Key        : 2
Actor Port Priority       : 1                     Partner Admin Port Priority : 1
Actor System Priority     : 2                     Partner Oper Port Priority  : 1
Actor System ID          : 23:45:67:89:00:01 Partner Admin Sys Priority : 2
Actor Port               : 2                     Partner Oper Sys Priority  : 2
Partner Admin Sys Id     : 23:45:67:89:00:01 Partner Admin Port        : 1
Partner Oper Sys Id      : 23:45:67:89:00:01 Partner Oper Port         : 1
Port Actor Admin State   : distrib
Port Partner Admin State : activity
Port Actor Oper State    : default
Port Partner Oper State  : default
Attached Agg ID          : aggr-0             Selected Agg ID          : aggr-0
Aggregation Status       : Enable              LACP PacketsPrio        : 2
```

**Output Fields:**

| Field                              | Description  |
|------------------------------------|--|
| <b>Interface</b>                   | The <b>IfName</b> of the Ethernet interface for the aggregator.  |
| <b>Port Is Aggregate</b>           | Boolean value indicating whether the Aggregation Port is able to Aggregate ('TRUE'), or is only able to operate as an Individual link ('FALSE'). |
| <b>Actor Oper Key</b>              | The current operational value of the Key for the Aggregator.   |
| <b>Partner Oper Key</b>            | The current operational value of the Key for the Aggregator's current protocol Partner.  |
| <b>Actor Admin Key</b>             | The current administrative value of the Key for the Aggregator.  |
| <b>Partner Admin Key</b>           | The current administrative value of the Key for the Aggregator's current protocol Partner.   |
| <b>Actor Port Priority</b>         | The priority value assigned to this Aggregation Port.  |
| <b>Partner Admin Port Priority</b> | The current administrative value of the port priority for the protocol Partner.  |
| <b>Actor System Priority</b>       | A 2-octet, read-write value indicating the priority value associated with the Actor's System ID.   |
| <b>Partner Oper Port Priority</b>  | The current operational value of the port priority for the protocol Partner.   |
| <b>Actor System ID</b>             | A 6-octet, read-write MAC address value, used as a unique identifier for the System that contains this Aggregator.                               |



|                                   |   |
|-----------------------------------|---|
| <b>Partner Admin Sys Priority</b> | A 2-octet, read-only value that indicates the priority value associated with the Partner's System ID.                               |
| <b>Actor Port</b>                 | The port number locally assigned to the Aggregation Port.   |
| <b>Partner Oper Sys Priority</b>  | A 2-octet read-only value that indicates the priority value associated with the Partner's System ID.                                |
| <b>Partner Admin Sys Id</b>       | A 6-octet read-write MACAddress value representing the administrative value of the Aggregation Port's protocol Partner's System ID. |
| <b>Partner Admin Port</b>         | The current administrative value of the port number for the protocol Partner.   |
| <b>Partner Oper Sys Id</b>        | A 6-octet read-write MACAddress value representing the operational value of the Aggregation Port's protocol Partner's System ID.    |
| <b>Partner Oper Port</b>          | The current operational value of the port number for the protocol Partner.  |
| <b>Port Actor Admin State</b>     | Administrative state of Actor.  |
| <b>Port Partner Admin State</b>   | Administrative state of Partner.  |
| <b>Port Actor Oper State</b>      | Operational state of Actor.   |
| <b>Port Partner Oper State</b>    | Operational state of Partner.   |
| <b>Attached Agg ID</b>            | The identifier value of the Aggregator that this Aggregation Port has currently selected.   |
| <b>Selected Agg ID</b>            | The identifier value of the Aggregator that this Aggregation Port has currently selected.   |
| <b>Aggregation Status</b>         | Whether or not aggregation(bonding) is to be enabled over this Aggregation Port..   |
| <b>LACP PacketsPrio</b>           | For LACP PDUs, this priority shall be used for choice of traffic class/Queue on outgoing interface.                                 |

### References:

- lACP aggrport list
- lACP aggrport stats

## 5.4.5 LACP AGGRPort List Commands

### 5.4.5.1 Get lacp aggrport list

**Description:**

Use this command to get a LACP aggregator port list.

**Command Syntax:**

```
get lacp aggrport list [aggrifname <aggrifname-val>]
```

**Parameters:**

| Name                                  | Description  |
|---------------------------------------|--|
| <b>Aggrifname</b><br><aggrifname-val> | The Aggregator interface name.<br><b>Type</b> : Optional<br><b>Valid values</b> : <i>aggr</i> -* |

**Mode:**

Super-User, User

**Example:**

```
$ get lacp aggrport list
```

**Output:**

```
Aggr IfName : aggr-0  
Port List   : eth-0 eth-1
```

**Output Fields:**

| Field              | Description  |
|--------------------|--|
| <b>Aggr IfName</b> | The Aggregator interface name.                             |
| <b>Port List</b>   | List of the ports corresponding to given aggregator index. |

**References:**

- lacp aggr
- lacp aggrport info
- lacp aggrport stats.

## 5.4.6 LACP AGGRPort Stats Commands

### 5.4.6.1 Get lacp aggrport stats

**Description:**

Use this command to get LACP aggregator port statistics.

**Command Syntax:**

**get lacp aggrport stats [ifname <interface-name>]**

### 5.4.6.2 Reset lacp aggrport stats

**Description:**

Use this command to reset LACP aggregator port statistics.

**Command Syntax:**

**reset lacp aggrport stats ifname <interface-name>**

---

**Note:**

This command is not supported in this release.

---

**Parameters:**

| Name                              | Description   |
|-----------------------------------|---|
| <b>Ifname</b><br><interface-name> | The <b>IfName</b> of the Ethernet interface for the aggregator.<br><b>Type</b> : Modify – Mandatory<br>Get – Optional<br><b>Valid values</b> : eth-*, eoa-* |

**Example :**

```
$ get lacp aggrport stats ifname eth-0
```

**Output:**

```
Interface           : eth-0
LACPDU Rx           : 1           LACPDU Tx           : 1
MarkerPDU Rx        : 1           MarkerPDU Tx         : 1
Marker Response PDU Rx : 1       Marker Response PDU Tx : 1
Unknown Rx           : 1           Illegal Rx           : 1
```

## Output Fields:

| Field                   | Description  |
|-------------------------|--|
| Interface               | The Interface name of the Ethernet interface for the aggregator.   |
| LACPDUs Rx              | The number of valid LACP PDUs received on this Aggregation Port.   |
| LACPDUs Tx              | The number of LACP PDUs transmitted on this Aggregation Port.  |
| MarkerPDUs Rx           | The number of valid Marker PDUs received on this Aggregation Port.   |
| MarkerPDUs Tx           | The number of Marker PDUs transmitted on this Aggregation Port.  |
| Marker Response PDUs Rx | The number of valid Marker Response PDUs received on this Aggregation Port.  |
| Marker Response PDUs Tx | The number of Marker Response PDUs transmitted on this Aggregation Port.   |
| Unknown Rx              | The number of frames received, that either carry the Slow Protocols Ethernet Type value, but contain an unknown PDU, or, are addressed to the Slow Protocols group MAC Address, but do not carry the Slow Protocols Ethernet Type. |
| Illegal Rx              | The number of frames received, that carry the Slow Protocols Ethernet Type value, but contain a badly formed PDU or an illegal value of Protocol Subtype.  |

## References:

- lacp aggr
- lacp aggrport list
- lacp aggrport info.

## 5.4.7 Redundancy aggr info Commands

### 5.4.7.1 Get rdncy aggr info

#### Description:

Use this command to get.

#### Command Syntax:

```
get rdncy aggr info [ifname <interface-name>]
```

### 5.4.7.2 Create rdncy aggr info

**Description:**

Use this command to create.

**Command Syntax:**

**create rdncy aggr info ifname ifname [revdistrib Enable | Disable] [fallback Enable | Disable]**

### 5.4.7.3 Delete rdncy aggr info

**Description:**

Use this command to delete

**Command Syntax:**

**delete rdncy aggr info ifname <interface-name>**

### 5.4.7.4 Modify rdncy aggr info

**Description:**

Use this command to modify

**Command Syntax:**

**modify rdncy aggr info ifname <interface-name> [revdistrib Enable | Disable] [fallback Enable | Disable]**

**Parameters:**

| Name                               | Description   |
|------------------------------------|---|
| <b>ifname</b><br><interface-name>  | This specifies the interface index used for the Redundancy Aggregator type of interfaces. Valid Value is aggr-0<br><b>Type:</b> Create -- Mandatory<br>Delete -- Mandatory<br>Modify -- Mandatory<br>Get -- Optional<br><b>Valid values:</b> aggr-0   |
| <b>revdistrib</b> Enable   Disable | It denotes whether reverse distribution filtering is to be enforced for traffic in the receiving direction, when both the links are active, for this aggregator interface. If duplicate packets are expected on the redundant links (if uplink aggregating device is layer2 switch), Reverse distribution filtering may be enabled. |

|  |  |
|--|--|
|  | <p>But if there is no chance of such duplicate packets, or the duplicate packets need not have a special handling, reverse distribution filtering may be disabled.</p> <p><b>Type:</b> Create -- Optional<br/> Modify -- Optional</p> <p><b>Default value:</b> enable</p>  |
| <p><b>fallback</b> Enable  <br/> Disable</p> | <p>This specifies whether fallback is to happen for aggregator interface, when a link goes down. As fallback trigger leads to re-propagation of protocol PDUs to the links based on the state of the links, this may be enabled if re-propagation of protocol PDUs is required for immediate restoration of peer protocol state on uplink devices. If such a treatment is not required and Protocol time out may only be triggered for re-propagation, Fallback trigger should be disabled.</p> <p><b>Type:</b> Create -- Optional<br/> Modify -- Optional</p> <p><b>Default value:</b> enable</p> |

**Example:**

```
$ create rdncy aggr info IfName aggr-0 revdistrib disable fallback disable
```

**Output:**

Verbose Mode On

Entry Created

Interface Index : aggr-0

Reverse Distribution : disable                      FallBack : disable

Verbose Mode Off:

Entry Created

**Output Fields:**

| Field                       | Description  |
|-----------------------------|--|
| <b>Interface Index</b>      | This specifies the interface index used for the Redundancy Aggregator type of interfaces. Valid Value is aggr-0  |
| <b>Reverse Distribution</b> | It denotes whether reverse distribution filtering is to be enforced for traffic in the receiving direction, when both the links are active, for this aggregator interface. If duplicate packets are expected on the redundant links (if uplink aggregating device is layer2 switch) Reverse distribution filtering may be enabled. But if there is no chance of such duplicate packets or the duplicate packets need not have a special handling reverse distribution filtering may be disabled. |

|                 |  |
|-----------------|--|
| <b>FallBack</b> | This specifies whether fallback is to happen for aggregator interface, when a link goes down. As fallback trigger leads to re-propagation of protocol PDUs to the links based on the state of the links, this may be enabled if re-propagation of protocol PDUs is required for immediate restore of peer protocol state on uplink devices. If such a treatment is not required and Protocol time out may only be trigger for re-propagation, Fallback trigger should be disabled. |
|-----------------|--|

**Caution:**

- Redundancy aggregator shall not be created, if aggregator interface is not created or if LACP aggregator is created for the aggregator interface.

**References:**

- create aggr intf command
- get aggr intf command

## 5.4.8 Redundancy aggrport list Commands

### 5.4.8.1 Get aggrport list

**Description:**

Use this command to get.

**Command Syntax:**

**get rdncy aggrport list [aggrifname <interface-name>]**

**Parameters:**

| Name                                  | Description  |
|---------------------------------------|--|
| <b>aggrifname</b><br><interface-name> | Index of the redundancy aggregator, for which layer2 interfaces are associated. Valid Value is aggr-0<br><br><b>Type:</b> Get -- Optional<br><br><b>Valid values:</b> aggr-0 |

**Example:**

\$ get rdncy aggrport list aggrifname aggr-0

**Output:**

Aggr IfName : aggr-0  
 PortList : eth-0 eth-1  
 Port List Interface type : None

**Output Fields:**

| Field                           | Description   |
|---------------------------------|---|
| <b>Aggr IfName</b>              | Index of the redundancy aggregator, for which layer2 interfaces are associated. Valid Value is aggr-0   |
| <b>PortList</b>                 | The complete list of active layer2 interfaces associated with the aggregator interface by virtue of redundancy. Each bit set represents the Ethernet interface, that is actively associated with redundancy based aggregation. An interface is actively associated with aggregator interface, if data for the aggregator interface can be transmitted/received over it. |
| <b>Port List Interface type</b> | It denotes what type of interfaces (Physical ethernet) are present in Port List. If no interface are present in port list the value shall be None   |

**5.4.9 Redundancy aggr stats Commands****5.4.9.1 Get rdncy aggr stats****Description:**

Use this command to get.

**Command Syntax:**

**get rdncy aggr stats [ifname <interface-name>]**

**5.4.9.2 Reset rdncy aggr stats****Description:**

Use this command to reset.

**Command Syntax:**

**reset rdncy aggr stats ifname <interface-name>**



## Parameters:

| Name                           | Description   |
|--------------------------------|---|
| <b>ifname</b> <interface-name> | This specifies the interface index used for the Aggregator type of interfaces for which the redundancy stats are desired. Valid Value is aggr-0<br><b>Type:</b> Reset -- Optional<br>Get -- Optional<br><b>Valid values:</b> aggr-0 |

## Example:

```
$ get rdncy aggr stats IfName aggr-0
```

## Output:

Interface Index : aggr-0

Collapse Count : 1

DeCollapse Count : 1

Last Collapse Time [MM/DD/YYYY::HH:MM:SS] : 04/21/2003:12:23:34

Last De-Collapse Time [MM/DD/YYYY::HH:MM:SS] : 04/21/2003:12:23:34

## Output Fields:

| Field  | Description  |
|--|--|
| <b>Interface Index</b>                                 | This specifies the interface index used for the Aggregator type of interfaces for which the redundancy stats are desired. Valid Value is aggr-0                    |
| <b>Collapse Count</b>                                  | This specifies the number of times one of the redundant interfaces has gone down and the traffic had to be moved on to the other redundant interface, which is up. |
| <b>DeCollapse Count</b>                                | This specifies the number of times one of the failed redundant interfaces has come up and the traffic had to be redistributed among mutually redundant interfaces. |
| <b>Last Collapse Time</b><br>[MM/DD/YYYY::HH:MM:SS]    | This specifies time at which the last collapse (one of the redundant interface has gone down) occurred. The display format shall be mm/dd/yyyy:hr:min:sec.         |
| <b>Last De-Collapse Time</b><br>[MM/DD/YYYY::HH:MM:SS] | This specifies time at which the last de-collapse (one of the failed redundant interface has come up) occurred. The display format shall be mm/dd/yyyy:hr:min:sec. |

## 5.5 ATM commands

---

### 5.5.1 AAL5 VC Statistics Commands

#### 5.5.1.1 Get atm aal5 stats

**Description:**

Use this command to get AAL5 VC statistics.

**Command Syntax:**

**get atm aal5 stats [ifname <interface-name>]**

**Parameters:**

| Name                              | Description   |
|-----------------------------------|---|
| <b>ifname</b><br><interface-name> | This parameter specifies the interface for which information is desired<br><br><b>Type</b> : Get - Optional<br><b>Valid values</b> : aal5-0 - |

**Example:**

```
$ get atm aal5 stats ifname aal5-0
```

**Output:**

```
Low IfName          : atm-0   VC IfName          : aal5-0
VPI                 : 0       VCI                 : 1
Tx Frames count    : 100     Rx Frames count    : 85
Tx Bytes count     : 1535    Rx Bytes count     : 1200
CRC Errors count   : 0       Oversized SDU      : 0
```

**Output Fields:**

| Field                  | Description   |
|------------------------|---|
| <b>VC IfName</b>       | The name of the <b>aal5</b> (aal5-0 etc) interface, for which statistics needs to be retrieved. |
| <b>Low IfName</b>      | This specifies the ATM port name. It can be : atm-0   |
| <b>VPI</b>             | This is the Virtual Port Identifier.  |
| <b>VCI</b>             | This is the Virtual Circuit Identifier.   |
| <b>Tx Frames count</b> | The number of AAL5 CPCS PDUs transmitted on this AAL5 VCC.                                      |
| <b>Rx Frames count</b> | The number of AAL5 CPCS PDUs received on this AAL5 VCC.   |
| <b>Tx Bytes count</b>  | The number of octets contained in AAL5 CPCS PDUs received on this AAL5 VCC.                     |
| <b>Rx Bytes count</b>  | The number of octets contained in AAL5 CPCS PDUs received on this AAL5 VCC.                     |

|                         |   |
|-------------------------|---|
| <b>CRC Errors count</b> | This specifies the number of CRC errors encountered.  |
| <b>Oversized SDU</b>    | This specifies the number of oversized SDUs received. |

### References:

- atm vc related commands
- atm port and statistics related commands
- atm vc statistics commands.

## 5.5.2 ATM OAM CC Commands

### 5.5.2.1 Get oam cc vc

#### Description:

Use this command to get.

#### Command Syntax:

**get oam cc vc** [ifname <interface-name>]

### 5.5.2.2 Modify oam cc vc

#### Description:

Use this command to modify.

#### Command Syntax:

**modify oam cc vc ifname** <interface-name> [**action** act | deact] [**dir** sink | src | both] [**mode** auto | manual]

#### Parameters:

| Name                              | Description  |
|-----------------------------------|--|
| <b>ifname</b><br><interface-name> | This parameter specifies the interface, for which information is desired.<br>In case the field is not specified, then the information for all valid interfaces should be displayed.<br><b>Type:</b> Modify -- Mandatory<br>Get -- Optional |
| <b>action</b> act   deact         | This field specifies the CC action to be taken. This is used along with CC direction field.<br><b>Type:</b> Modify -- Optional   |
| <b>dir</b> sink   src   both      | This field specifies the direction for CC activation/Deactivation.Direction could be source (src), sink or both.   |

|                           |  |
|---------------------------|--|
|                           | <b>Type:</b> Modify -- Optional  |
| <b>mode</b> auto   manual | This specifies the activation/deactivation capability at a VCC.<br><b>Type:</b> Modify -- Optional |

**Example:**

```
$ get oam cc vc ifname aal5-0
```

**Output:**

```
ifName      Mode      SourceOperStatus SinkOperStatus Initiator
-----
aal5-0      Manual activated      LOC              Self
```

**Output Fields:**

| Field                   | Description  |
|-------------------------|--|
| <b>ifName</b>           | This parameter specifies the interface, for which information is desired. In case the field is not specified, then the information for all valid interfaces should be displayed. |
| <b>Mode</b>             | This specifies the activation/deactivation capability at a VCC.  |
| <b>SourceOperStatus</b> | This field specifies the current operational state of source point of the VCC.   |
| <b>SinkOperStatus</b>   | This field specifies the current operational state of sink point of the VCC.   |
| <b>Initiator</b>        | This field is valid only in auto mode and it specifies the current initiator of CC Activation/Deactivation.  |

**References:**

- atm vc related commands.
- atm port and statistics related commands.
- atm oam loopback commands.

## 5.5.3 ATM OAM Loopback Commands

### 5.5.3.1 Get oam lpbk vc

**Description:**

Use this command to get.

**Command Syntax:**

**get oam lpbk vc [ifname <interface-name>]**

### 5.5.3.2 Modify oam lpbk vc

**Description:**

Use this command to modify.

**Command Syntax:**

**modify oam lpbk vc ifname <interface-name> [e2e | seg] [lbid <lbid-val>]**

**Parameters:**

| Name                              | Description  |
|-----------------------------------|--|
| <b>ifname</b><br><interface-name> | Interface Index of the ATM port, on which this VC is getting configured.<br><b>Type:</b> Modify – Mandatory<br>Get – Mandatory |
| <b>e2e   seg</b>                  | This specifies the loop back type used. It may be: e2e or segment.<br><b>Type:</b> Modify – Optional                           |
| <b>Lbid &lt;lbid-val&gt;</b>      | This defines the loopback site, which will loopback the cell.<br><b>Type:</b> Modify – Optional                                |

**Example:**

```
$ get oam lpbk vc ifname aal5-0
```

**Output:**

```
IfName           : aal5-0      VPI : 1      VCI : 1
LB Type          : e2e
OAM Location Id  : 0xffffffffffffffff
OAM LB Result    : E2e Succeeded
```

## Output Fields:

| Field           | Description   |
|-----------------|---|
| IfName          | Interface Index of the ATM port, on which this VC is getting configured.  |
| VPI             | This is the Virtual Circuit Identifier.   |
| VCI             | This is the Virtual Port Identifier.  |
| LB Type         | This specifies the loop back type used. It may be e2e or segment.   |
| OAM Location Id | This defines the loopback site, which will loopback the cell.   |
| OAM LB Result   | This specifies the result of the loop back test. It may be Result Unavailable, Seg Succeeded, Seg Failed, E2e Succeeded, E2e Failed, Test Aborted, or Test In Progress. |

## References:

- atm vc related commands.
- atm port and statistics related commands.

## 5.5.4 ATM Port Commands

### 5.5.4.1 Get atm port

#### Description:

Use this command to get.

#### Command Syntax:

```
get atm port [ifname <interface-name>]
```

### 5.5.4.2 Create atm port

#### Description:

Use this command to create.

#### Command Syntax:

```
create atm port ifname <interface-name> lowif <lowif-val> [ maxvc <maxvc-val> ]  
[ maxvpibits <maxvpibits-val> ] [ maxvcibits <maxvcibits-val> ] [ oamsrc  
<oamsrc-val> ] [ orl <orl-val> ] [ trfclassprofileid <trfclassprofileid-val> ]  
[ profilename <profilename-val> ] [ ctlpktinstid <ctlpktinstid-val> ]  
[ atmtransporttype cell | packet ] [ mirrormode data | mirror ] [ enable |  
disable ]
```

### 5.5.4.3 Delete atm port

#### Description:

Use this command to delete.

#### Command Syntax:

```
delete atm port ifname <interface-name>
```

### 5.5.4.4 Modify atm port

#### Description:

Use this command to modify.

#### Command Syntax:

```
modify atm port ifname <interface-name> [ maxvc <maxvc-val> ] [ maxvpibits  
<maxvpibits-val> ] [ maxvcibits <maxvcibits-val> ] [ oamsrc <oamsrc-val> ] [ orl  
<orl-val> ] [ trfclassprofileid <trfclassprofileid-val> ] [ profilename  
<profilename-val> ] [ atmtransporttype cell | packet ] [ enable | disable ]
```

#### Parameters:

| Name                                  | Description   |
|---------------------------------------|---|
| <b>ifname</b><br><interface-name>     | Physical interface index<br><b>Type:</b> Create – Mandatory<br>Delete – Mandatory<br>Modify – Mandatory<br>Get – Optional   |
| <b>lowif</b> <lowif-val>              | This is the IfIndex of the low interface on which this ATM port is configured. Lower interface can be of type dsl-* or dsli-* or dslf-* or aband-*<br><b>Type:</b> Create – Mandatory   |
| <b>maxvc</b> <maxvc-val>              | This specifies the maximum number of VCCs (PVCCs), supported at this ATM interface. This field is not valid if the atmtransporttype has the value packet<br><b>Type:</b> Create – Optional<br>Modify – Optional<br><b>Valid values:</b> 1 -8<br><b>Default value:</b> 8 |
| <b>maxvpibits</b><br><maxvpibits-val> | The maximum number of active VPI bits configured for use at the ATM interface.<br><b>Type:</b> Create – Optional  |

|  |  |
|--|--|
|  | <p>Modify — Optional</p> <p><b>Valid values:</b> 1 - 8</p> <p><b>Default value:</b> 8</p>  |
| <p><b>maxvcibits</b></p> <p>&lt;maxvcibits-val&gt;</p>               | <p>This specifies the maximum number of active VCI bits configured for use at this ATM interface.</p> <p><b>Type:</b> Create — Optional</p> <p>Modify — Optional</p> <p><b>Valid values:</b> 1 - 16</p> <p><b>Default value:</b> 16</p>  |
| <p><b>oamsrc</b> &lt;oamsrc-val&gt;</p>                              | <p>Loopback source id assigned to the ATM port. The ATM port will respond to all loopback cells, which carry this OAM id. This field is not valid if the atmtransporttype has the value packet.</p> <p><b>Type:</b> Create — Optional</p> <p>Modify — Optional</p> <p><b>Default value:</b> 0xffffffffffffffffffffffff</p>   |
| <p><b>orl</b> &lt;orl-val&gt;</p>                                    | <p>This parameter specifies the output rate limiting value in KBPS to be applied on this interface.</p> <p><b>Type:</b> Create — Optional</p> <p>Modify — Optional</p> <p><b>Valid values:</b> 64 - 6000</p> <p><b>Default value:</b> 54000</p>  |
| <p><b>trfclassprofileid</b></p> <p>&lt;trfclassprofileid-val&gt;</p> | <p>This specifies the traffic class profile to be associated with the ATM port.</p> <p><b>Type:</b> Create — Optional</p> <p>Modify — Optional</p> <p><b>Valid values:</b> 1 -8</p> <p><b>Default value:</b> 1</p>   |
| <p><b>profilename</b></p> <p>&lt;profilename-val&gt;</p>             | <p>This specifies the scheduling profile to be associated with the ATM port.</p> <p><b>Type:</b> Create — Optional</p> <p>Modify — Optional</p> <p><b>Default value:</b> "SPPROFILE"</p>   |
| <p><b>ctlpktinstid</b></p> <p>&lt;ctlpktinstid-val&gt;</p>           | <p>This specifies the control packet instance identifier associated with this interface. If the user does not provide any instance identifier while creating an interface an instance is created internally from the default profile governed by the macro 1 and associated to the interface. This will reduce the total number to instances that can be now created by one. The default instance is governed by macro 0. <b>Type:</b> Create — Optional</p> <p><b>Valid values:</b> 1 -146</p> <p><b>Default value:</b> 0</p> |
| <p><b>atmtransporttype</b> cell<br/><b> packet</b></p>               | <p>This specifies the transport type of the atm interface. This can be either Cell which means that actual Atm Cells shall be received over the</p>  |



|                                 |  |
|---------------------------------|--|
|                                 | <p>UTOPIA interface, or Packet , which means that Pseudo Cells corresponding to Packet VDSL shall be received over this ATM interface. This is not modifiable if any ATM VC is created on top of this ATM port.</p> <p><b>Type:</b> Create — Optional<br/> Modify — Optional</p> <p><b>Default value:</b> 1</p>    |
| <b>mirrormode data   mirror</b> | <p>This field configures ATM port in data mode or mirror mode. In mirror mode, only the mirrored packets are allowed to go out of the port and regular customer data is forbidden. Scheduling profile field is ignored in mirror mode.</p> <p><b>Type:</b> Create — Optional</p> <p><b>Default value:</b> data</p> |
| <b>enable   disable</b>         | <p>Administrative status of the interface.</p> <p><b>Type:</b> Create — Optional<br/> Modify — Optional</p> <p><b>Valid values:</b> enable, disable</p> <p><b>Default value:</b> enable</p>  |

**Example:**

```
$ create atm port ifname atm-0 lowif dsl-0 maxvc 5 maxvpibits 6 maxvcibits 12S
oamsrc 0xffffffffffffffffffffffffffffffff orl 3000 trfclassprofileid 3 profilename gold
ctlpktinstid 1 atmtransporttype Cell mirrormode mirror enable
```

**Output:**

Verbose Mode On

Entry Created

```
IfName           : atm-0      LowIfName       : dsl-0
MaxVccs          : 5
MaxVpiBits      : 6
MaxVciBits      : 12
OAMSrc          : 0xffffffffffffffffffffffffffffffff
ORL(kbps)        : 3000
UnknownVPI      : 35         UnknownVCI     : 35
ProfileName     : gold
Current Output Rate : 64
trfclassprofileid : 3
Ctl Pkts Instance Id : 1
ATM Transport Type : Cell
Mirror Mode     : mirror
Oper Status     : Up        Admin Status : Enable
```

Verbose Mode Off:

Entry Created

### Output Fields:

| Field                       | Description  |
|-----------------------------|--|
| <b>IfName</b>               | Physical interface index   |
| <b>LowIfName</b>            | This is the IfIndex of the low interface on which this ATM port is configured.<br>Lower interface can be of type 94 or 124 or 125 or 0xffffffff9   |
| <b>MaxVccs</b>              | This specifies the maximum number of VCCs (PVCCs), supported at this ATM interface. This field is not valid if the atmtransporttype has the value packet   |
| <b>MaxConfVccs</b>          | This specifies the current number of VCCs configured on this port.   |
| <b>MaxVpiBits</b>           | The maximum number of active VPI bits configured for use at the ATM interface.   |
| <b>MaxVciBits</b>           | This specifies the maximum number of active VCI bits configured for use at this ATM interface.   |
| <b>OAMSrc</b>               | Loopback source id assigned to the ATM port. The ATM port will respond to all loopback cells, which carry this OAM id. This field is not valid if the atmtransporttype has the value packet.   |
| <b>ORL(kbps)</b>            | This parameter specifies the output rate limiting value in KBPS to be applied on this interface.   |
| <b>UnknownVPI</b>           | This parameter specifies the last seen unknown VPI on this ATM interface.<br>This field is not valid if the atmtransporttype has the value packet.   |
| <b>UnknownVCI</b>           | This parameter specifies the last seen unknown VCI on this ATM interface.<br>This field is not valid if the atmtransporttype has the value packet.   |
| <b>ProfileName</b>          | This specifies the scheduling profile to be associated with the ATM port.  |
| <b>Current Output Rate</b>  | This parameter specifies the current output rate value in KBPS that is available on this interface, based on the minimum of DSL trained rate and OutPut Rate limit configured for the ATM port.  |
| <b>trfclassprofileid</b>    | This specifies the traffic class profile to be associated with the ATM port.   |
| <b>Ctl Pkts Instance Id</b> | This specifies the control packet instance identifier associated with this interface. If the user does not provide any instance identifier while creating an interface an instance is created internally from the default profile governed by the macro 1 and associated to the interface. This will reduce the total number to instances that can be now created by one. The default instance is governed by macro 0. |
| <b>ATM Transport Type</b>   | This specifies the transport type of the atm interface. This can be either Cell which means that actual Atm Cells shall be received over the UTOPIA interface, or Packet , which means that Pseudo Cells corresponding to Packet VDSL shall be received over this ATM interface. This is not modifiable  |

|                     |   |
|---------------------|---|
|                     | if any ATM VC is created on top of this ATM port.   |
| <b>Mirror Mode</b>  | This field configures ATM port in data mode or mirror mode. In mirror mode, only the mirrored packets are allowed to go out of the port and regular customer data is forbidden. Scheduling profile field is ignored in mirror mode. |
| <b>Oper Status</b>  | The actual/current state of the interface. It can be either up or down.   |
| <b>Admin Status</b> | The desired state of the interface. It may be either Up or Down.  |

## 5.5.5 ATM VC Commands

### 5.5.5.1 Create atm vc intf

#### Description:

Use this command to create a new ATM Virtual Circuit (VC).

#### Command Syntax :

```
create atm vc intf ifname <interface-name> vpi <vpi-val> vci <vci-val> lowif
<atm-port-interface-name> [enable | disable] [aal5] [a5txsize
<aal5-cpcs-tx-sdu-size>] [a5rxsize <aal5-cpcs-rx-sdu-size>] [vcmux | llcmux | auto
| ethernet] [pvc] [channel fast|interleaved] [ mgmtmode
data|mgmt|DataAndMgmt| raw] [ maxnumproto <maxnumproto-val> ]
[ autostatus Enable|Disable ] [ autosupportedprot none|{pppoa | eoa | ipoa}+]
[ autovcmuxforcedprot None | pppoa | eoa | ipoa] [ autosensetriggertype
dynamic | opstatechange ] [ ctlpktgroupid <ctlpktgroupid> | none ]
```

### 5.5.5.2 Delete atm vc intf

#### Description:

Use this command to delete an existing ATM Virtual Circuit (VC).

#### Command Syntax:

```
delete atm vc intf ifname <interface-name>
```

### 5.5.5.3 Get atm vc intf

#### Description:

Use this command to display information corresponding to a single VC, or for all VCs.

```
Command Syntax: get atm vc intf [ifname <interface-name>]
```

## 5.5.5.4 Modify atm vc intf

### Description:

Use this command to modify ATM VC parameters.

### Command Syntax:

```
modify atm vc intf ifname <interface-name> [vpi <vpi-val>] [vci <vci-val>]
{enable | disable} [a5txsize <aal5-cpcs-tx-sdu-size>] [a5rxsize
<aal5-cpcs-rx-sdu-size>] [vcmux | llcmux | auto | ethernet] [ mgmtmode data |
mgmt | DataAndMgmt | raw] [ autosupportedprot none{|pppoa | eoa | ipoa}+]
[ autovcmuxforcedprot None | pppoa | eoa | ipoa] [ autosensetriggertype
dynamic | opstatechange ]
```

### Parameters:

| Name   | Description   |
|--|---|
| <b>ifname</b><br><interface-name>            | This specifies name of VC Interface.<br><b>Type:</b> Create – Mandatory<br>Delete – Mandatory<br>Get – Optional<br>Modify – Mandatory<br><b>Valid values :</b> aal5-0 - *   |
| <b>lowif</b><br><atm-port-interfacenam<br>e> | Interface Index of the ATM port, on which this VC is getting configured.<br><b>Type:</b> Mandatory<br><b>Valid values :</b> atm-0 - *   |
| <b>vpi</b> <vpi-val>                         | Virtual Path Identifier. In order to modify, the VPI value shall be the new VPI value and the admin status of VC interface shall be disabled. Also, the VPI and VCI value cannot be modified along with admin status in one command. If encaps type is Ethernet than value of this field has to be 0.<br><b>Type :</b> Create – Mandatory<br>Modify – Optional<br><b>Valid values :</b> 0-2 <sup>8</sup>    |
| <b>vci</b> <vci-val>                         | Virtual Circuit Identifier. In order to modify, the VCI value shall be the new VCI value and the admin status of VC interface shall be disabled. Also, the VPI and VCI value cannot be modified along with admin status in one command. If encaps type is Ethernet than value of this field has to be 0.<br><b>Type:</b> Create – Mandatory<br>Modify – Optional<br><b>Valid values :</b> 1-2 <sup>16</sup> |

|   |  |
|---|--|
| <b>mgmtmode Data   Mgmt   DataAndMgmt   Raw</b> | <p>It denotes the Management Mode of the ATM VC. If it is Data, then only data transmission can take place. If it is Mgmt, then management of remote CPE device can happen on that ATM VC and packets on that ATM VC shall start coming to Control Plane. In DataAndMgmt mode, data transmission as well as remote CPE management can happen on the same ATM VC interface. In DataAndMgmt mode, the acceptable values for atmVCCAAL5EncapType are <b>llcmux</b> and <b>auto</b>. In Mgmt mode, EoA interface cannot be created on the ATM VC and both Ethernet as well as non-ethernet packets on that ATM VC shall be received at the Control Plane. In DataAndMgmt mode, if EoA is created, then only non-ethernet packets on that ATM VC shall be received at the Control Plane. However, if EoA is not created then all the packets on that ATM VC shall be received at the Control Plane. However, to configure ATM VC in DataAndMgmt mode, a good practice is to create ATM VC in disable mode till EoA is created on it, to prevent flooding at Control Plane. In order to run STP, the mode has to be DataAndMgmt. If the mode is RawATM(4), ATM cells are given to Control Plane. In this mode, EoA interface cannot be created on the ATM VC. If EoA interface is already created on the ATM VC, its mode cannot be changed to either Mgmt(2) or RawATM(4). This field is not valid if encapsType is Ethernet.</p> <p><b>Type:</b> Create – Optional<br/> <b>Default value:</b> Data</p> |
| <b>enable disable</b>                           | <p>This specifies the Admin Status of the VC.</p> <p><b>Type:</b> Optional<br/> <b>Default Value:</b> enable</p>   |
| <b>aal5</b>                                     | <p>This specifies the AAL type in use for this VC. The only type of AAL supported in Columbia Packet is AAL5. This field is not valid for an ATM VC with encapsType as Ethernet.</p> <p><b>Type:</b> Create Optional<br/> <b>Default value:</b> aal5</p>   |
| <b>a5txsize</b><br><aal5-cpcs-txsdu-size >      | <p>This specifies the maximum transmit CPCS SDU size to be used.</p> <p><b>Type:</b> Optional<br/> <b>Valid values :</b> 1-1536<br/> <b>Default Value:</b> 1536</p>  |
| <b>a5rxsize</b><br><aal5-cpcs-rxsdu-size>       | <p>This specifies the maximum receive CPCS SDU size to be used</p> <p><b>Type:</b> Optional<br/> <b>Valid values :</b> 1-1536<br/> <b>Default Value:</b> 1536</p>  |
| <b>vcmux llcmux auto ethernet</b>               | <p>This specifies the data encapsulation method to be used over the AAL5 SSCS layer. "auto" means autosense the muxType(llc/vc). Auto mode</p>   |

|  |   |
|--|---|
|  | <p>is only used to sense the llc/vcmux. Atm VC with encapsype as ethernet can be created only over an ATM port which has value of atmtransporttype as packet. The VPI/VCI values for this atm vc shall be 0/0. aaltype, mgmtmode and oam related parameters are not valid for an ATM VC with encapsype as Ethernet.</p> <p><b>Type:</b> Optional</p> <p><b>Default Value:</b> llcmux</p>  |
| <b>Pvc</b>   | <p>This specifies the type of VC. The only value supported is PVC.</p> <p><b>Type:</b> Optional</p> <p><b>Default Value:</b> pvc</p>  |
| <b>channel<br/>fast interleaved</b>                            | <p>This extension specifies the type of channel on which the ATM VC's cells have to be transmitted/ received. This field is deprecated and currently not in use.</p> <p><b>Type:</b> Optional</p> <p><b>Default Value:</b> Interleaved</p>  |
| <b>Maxnumproto</b><br><maxnumproto-val>                        | <p>This field specifies the maximum number of simultaneous active protocol stacks supported on this interface. Currently, only one protocol stack is supported.</p> <p><b>Type:</b> Create — Optional</p> <p><b>Default value:</b> 1</p>  |
| <b>Autostatus</b><br><b>Enable Disable</b>                     | <p>This field specifies whether the Auto mode is to be enabled or not. In the Auto mode, the stack above this interface will be determined and created based on the protocol packets sensed on this interface. For example, if the protocol packet sensed above this interface is an EoA packet, then the corresponding EoA stack will be created above this interface. However, the corresponding EoA interface must have been created with the config status field set as config mode. This field is not valid if encapsype is Ethernet.</p> <p><b>Type:</b> Create — Optional</p> <p><b>Default value:</b> disable</p> |
| <b>autosupportedprot</b><br><b>none {pppoa   eoa   ipoa}+</b>  | <p>This field specifies Higher layer protocols which are supported for auto detection on the given ATM VC. Only the packets if the protocols mentioned in this field can lead to Auto detection. This field is meaningful only when autostatus flag as enable.</p> <p><b>Type:</b> Create — Optional</p> <p>Modify — Optional</p> <p><b>Default value:</b> 1</p>  |
| <b>autovcmuxforcedprot</b><br><b>None   pppoa   eoa   ipoa</b> | <p>This field specifies that if the encap type detected is VCMux, the user can configure to build a specific protocol stack automatically. It can only be present with the autostatus flag as enable. In case of a conflict with</p>  |

|  |   |
|--|---|
|  | <p>autoSupportedProtocols, its value will override.</p> <p><b>Type:</b> Create — Optional<br/>Modify — Optional</p> <p><b>Default value:</b> none</p>   |
| <p><b>autosensetriggertype</b><br/><b>dynamic  </b><br/><b>opstatechange</b></p> | <p>This field specifies at what time autodetection of Encapsulation type or higher protocol layers is to be done - all the time or only when Operational Status of ATM VC is changed to UP. If its value is 'dynamic', then detection can happen anytime a packet is received. If its value is 'opstatechange', then autodetection happens only when Operational status of ATM VC changes to UP. This field is not valid if encaptype is Ethernet.</p> <p><b>Type:</b> Create — Optional<br/>Modify — Optional</p> <p><b>Default value:</b> dynamic</p>   |
| <p><b>ctlpktgroupid</b><br/><b>ctlpktgroupid   none</b></p>                      | <p>The Control packet instance group associated with this VC. The flows for this interface shall be mapped to control packet instances as mapped for the flows corresponding to the groupid configured in ctrlpkt group info command. If this group does not have entries for some of the flows, then those flows shall be mapped to the ctlpktinstid of ATM port, for which this VC is being created. If the group id is 0, then all the flows shall be mapped to ctlpktinstid of ATM port, for which this VC is being created.</p> <p><b>Type:</b> Create — Optional</p> <p><b>Valid values:</b> 0 -50</p> <p><b>Default value:</b> 0</p> |

### Example:

```
$ create atm vc intf ifname aal5-0 lowif atm-0 vpi 10 vci 10 enable aal5 pvc
a5txsize 1536 a5rxsize 1536 llcmux mgmtmode data autosupportedprot pppoa
eoa autovcmuxforcedprot pppoa autosensetriggertype dynamic ctlpktgroupid none
```

### Output:

Verbose Mode On

Entry Created

```
VC IfName      : aal5-0          Low IfName     : atm-0
VPI            : 0              VCI           : 35
Admin Status   : Up            Oper Status    : Down
Aal5 Tx Size   : 1536          Aal5 Rx Size  : 1536
AAL Type       : AAL5          AAL5 Encap    : llcmux
channel        : Interleaved   Last Change(sec) : 0
MgmtMode       : Data          Row Status     : active
```

VC Type : PVC VC Topology : Point to Point  
 Max simultaneous protocol : 1  
 Auto Status : Disable  
 Auto Supported Protocol : pppoa eoa  
 Auto VC Mux Forced Protocol : None  
 Auto Sense Trigger Type : dynamic  
 Auto Curr Sensed Encaps Typee : none  
 Ctl Pkts Group Id : none  
 Auto Supported Protocol : pppoa eoa

### Output Fields:

| Field               | Description   |
|---------------------|---|
| <b>VC IfName</b>    | VC Interface Name. It can be : aal5-0 - *   |
| <b>Low IfName</b>   | Interface Index of the ATM port, on which this VC is getting configured.  |
| <b>VPI</b>          | Virtual Path Identifier. In order to modify, the VPI value shall be the new VPI value and the admin status of VC interface shall be disabled. Also, the VPI and VCI value cannot be modified along with admin status in one command. If encaps type is Ethernet than value of this field has to be 0.   |
| <b>VCI</b>          | Virtual Circuit Identifier. In order to modify, the VCI value shall be the new VCI value and the admin status of VC interface shall be disabled. Also, the VPI and VCI value cannot be modified along with admin status in one command. If encaps type is Ethernet than value of this field has to be 0.  |
| <b>Oper Status</b>  | This specifies the actual/current state of the interface. It can be either Up or Down   |
| <b>Admin Status</b> | This specifies the desired state of the interface. It may be either Up/Down.  |
| <b>Aal5 Tx Size</b> | This specifies the transmit CPCS SDU size to be used.   |
| <b>Aal5 Rx Size</b> | This specifies the receive CPCS SDU size to be used.  |
| <b>Aal Type</b>     | This specifies the AAL type in use for this VC. The only type of AAL supported in Columbia Packet is AAL5. This field is not valid for an ATM VC with encaps type as Ethernet.  |
| <b>Aal5 Encap</b>   | This specifies the data encapsulation method to be used over the AAL5 SSCS layer. "auto" means autosense the muxType(llc/vc). Auto mode is only used to sense the llc/vcmux . Atm VC with encaps type as ethernet can be created only over an ATM port which has value of atmtransporttype as packet. The VPI/VCI values for this atm vc shall be 0/0. aaltype, mgmtmode and oam related parameters are not valid for an ATM VC with encaps type as Ethernet. |
| <b>channel</b>      | This extension specifies the type of channel on which the ATM VC's cells have to be transmitted/received. This field is deprecated and currently not in use.  |



|                                  |  |
|----------------------------------|--|
| <b>Last Change</b>               | The value of sysUpTime at the time this VC entered its current operational state.  |
| <b>MgmtMode</b>                  | It denotes the Management Mode of the ATM VC. If it is Data, then only data transmission can take place. If it is Mgmt, then management of remote CPE device can happen on that ATM VC and packets on that ATM VC shall start coming to Control Plane. In DataAndMgmt mode, data transmission as well as remote CPE management can happen on the same ATM VC interface. In DataAndMgmt mode, the only acceptable value for atmVCCAAL5EncapType is Ilc. In Mgmt mode, EoA interface can't be created on the ATM VC and both Ethernet as well as non-Ethernet packets on that ATM VC shall be received at Control Plane. In DataAndMgmt mode, if EoA is created then only non-Ethernet packets on that ATM VC shall be received at Control Plane. However, if EoA is not created then all the packets on that ATM VC shall be received at Control Plane. However, to configure ATM VC in DataAndMgmt mode, good practice is to create ATM VC in disable mode till EoA is created on it, to prevent flooding at Control Plane. In order to run STP, the mode has to be DataAndMgmt. If the mode is RawATM(4), ATM cells are given to Control Plane. In this mode, EoA interface cannot be created on the ATM VC. If EoA interface is already created on the ATM VC, its mode cannot be changed to either Mgmt(2) or RawATM(4). This field is not valid if encap type is Ethernet. |
| <b>RowStatus</b>                 | This defines the row-status of the interface entry   |
| <b>VC Type</b>                   | This field specifies whether VC type is PVC or SVC.  |
| <b>VC Topology</b>               | This field specifies the VC connection topology type.  |
| <b>Max simultaneous protocol</b> | This field specifies the maximum number of simultaneous active protocol stacks supported on this interface. Currently, only one protocol stack is supported.   |
| <b>Auto Status</b>               | This field specifies whether the Auto mode is to be enabled or not. In the Auto mode, the stack above this interface will be determined and created based on the protocol packets sensed on this interface. For example, if the protocol packet sensed above this interface is an EoA packet, then the corresponding EoA stack will be created above this interface. However, the corresponding EoA interface must have been created with the gsvEoaConfigMode field's bit corresponding to the 'Auto' set.  |
| <b>Auto Supported Protocol</b>   | This field specifies Higher layer protocols which are supported for auto detection on the given ATM VC. Only the packets if the protocols mentioned in this field can lead to Auto detection. This field is meaningful only when autostatus flag is enable.  |
| <b>Auto VC Mux Forced</b>        | This field specifies if the encap type detected is VCMux, the user can   |

|                                     |   |
|-------------------------------------|---|
| <b>Protocol</b>                     | configure to build a specific protocol stack automatically. This field is meaningful only when autostatus flag as enable. In case of conflict with autoSupportedProtocols, its value will override.   |
| <b>Auto Sense Trigger Type</b>      | This field specifies at what time autodetection of Encapsulation type or higher protocol layers is to be done - all the time or only when Operational Status of ATM VC is changed to UP. If its value is 'dynamic', then detection can happen anytime a packet is received. If its value is 'opstatechange', then autodetection happens only when Operational status of ATM VC changes to UP. This field is not valid if encapsype is Ethernet.   |
| <b>Auto Curr Sensed Encaps Type</b> | This field specifies the current sensed Encapsulation type in case the Encapsulation type is being autodetected. The value of this field will be the same as the field 'AAL5 Encapsulation Type' if the Encapsulation type is preconfigured. This is a read only field for all agents, except for the Auto Sense Agent.   |
| <b>Ctl Pkts Group Id</b>            | The Control packet instance group associated with this VC. The flows for this interface shall be mapped to control packet instances as mapped for the flows corresponding to the groupid configured in ctrlpkt group info command. If this group does not have entries for some of the flows, then those flows shall be mapped to the ctlpktinstid of ATM port, for which this VC is being created. If the group id is 0, then all the flows shall be mapped to ctlpktinstid of ATM port, for which this VC is being created. |

**Caution:**

The specified lower interface should exist. Please refer to the create atm port command.

**References:**

- ATM interface commands
- ATM statistics commands
- ATM OAM commands
- ATM VC statistics commands.

## 5.5.6 ATM VC Statistics Commands

### 5.5.6.1 Get atm vc stats

#### Description:

Use this command to get statistical information about a specific or all ATM virtual circuits.

#### Command Syntax:

```
get atm vc stats [ifname <interface-name>]
```

#### Parameters:

| Name                       | Description  |
|----------------------------|--|
| ifname<br><interface-name> | This specifies the Virtual Circuit. If this is not specified, then information for all VCs is displayed.<br><br><b>Type</b> : Get – Optional<br><b>Valid values</b> : aal5-0 - * |

#### Example:

```
$ get atm vc stats ifname aal5-0
```

#### Output:

```
Low IfName      : atm-0      VC IfName      : aal5-0
VPI             : 1          VCI            : 1
Total Tx Cells count : 250    Total Rx Cells count : 20
CLPI 0 Rx Cells count : 10    Rx Pkts Rejected count : 0
```

#### Output Fields:

| Field                  | Description  |
|------------------------|--|
| LowIf                  | This specifies the ATM port name. It can be : atm-0                                      |
| VPI                    | It is the Virtual Port Identifier.   |
| VCI                    | It is the Virtual Circuit Identifier.  |
| VC IfName              | The name of the aal5 (aal5-0 etc) interface, for which statistics needs to be retrieved. |
| Total Tx Cells count   | The total number of valid ATM cells transmitted by this interface.                       |
| Total Rx Cells count   | The total number of valid ATM cells received by this interface.                          |
| CLPI 0 Rx Cells        | The number of valid ATM cells received by this interface with CLP=0.                     |
| Rx Pkts Rejected count | The total number of valid ATM cells discarded by the interface.                          |

**References:**

- Other atm vc related commands
- oam lpbk command
- atm port related commands
- atm statistics related commands

## 5.6 Bridging Commands

---

### 5.6.1 Bridge forwarding Commands

#### 5.6.1.1 Get bridge forwarding

**Description:**

Use this command to get.

**Command Syntax:**

**get bridge forwarding** [vlanid <vlanid-val>] [macaddr <macaddr-val>]

#### 5.6.1.2 Delete bridge forwarding

**Description:**

Use this command to delete.

**Command Syntax:**

**delete bridge forwarding** [vlanid <vlanid-val>] [macaddr <macaddr-val>]

**Parameters:**

| Name                            | Description   |
|---------------------------------|---|
| <b>vlanid</b> <vlanid-val>      | <p>Vlan Id to uniquely identify the entry for which the bridge has forwarding and/or filtering information. To delete an individual learnt entry or all learnt entries, the FdbId should be set to a valid value in case of IVL. In SVL case, this value is ignored except when the value is 4097 which is the value of a special Vlan Id used for managing the traffic for those VLANs that are neither created nor learnt in the system. When Vlan transparency feature is supported, the valid range for this also includes 4097. VLAN here means the 802.1q Vlan in case of Native Vlan mode and Virtual Vlan in case of Stacked Vlan Mode.</p> <p><b>Type:</b> Delete — Optional<br/>Get — Optional</p> <p><b>Valid values:</b> 0 - 4095</p> |
| <b>macaddr</b><br><macaddr-val> | <p>A unicast MAC address for which the bridge has forwarding and/or filtering information. In the case of "delete all" entries in a given FDB; the MacAddr shall have INVALID value specified by FF: FF: FF: FF: FF: FF. To delete an individual entry, valid value of Mac address has to be specified.</p> <p><b>Type:</b> Delete — Optional<br/>Get — Optional</p>  |

**Example:**

```
$ get bridge forwarding vlanid 10 macaddr 02:2e:22:3d:44:56
```

**Output:**

```
MAC Addr                PortId    VlanId    Status
-----
02:2e:22:3d:44:56      10        10        learned
```

**Output Fields:**

| Field           | Description  |
|-----------------|--|
| <b>MAC Addr</b> | A unicast MAC address for which the bridge has forwarding and/or filtering information. In the case of "delete all" entries in a given FDB; the MacAddr shall have INVALID value specified by FF: FF: FF: FF: FF: FF. To delete an individual entry, valid value of Mac address has to be specified.   |
| <b>VlanId</b>   | Vlan Id to uniquely identify the entry for which the bridge has forwarding and/or filtering information. To delete an individual learnt entry or all learnt entries, the FdbId should be set to a valid value in case of IVL. In SVL case, this value is ignored except when the value is 4097 which is the value of a special Vlan Id used for managing the traffic for those VLANs that are neither created nor learnt in the system. When Vlan transparency feature is supported, the valid range for this also includes 4097. VLAN here means the 802.1q Vlan in case of Native Vlan mode and Virtual Vlan in case of Stacked Vlan Mode.   |
| <b>PortId</b>   | Port number of the port on which a frame having a source address equal to the value of the corresponding instance of dot1qTpFdbAddress, has been seen. This may have a value of "0" if the statically configured address has a dynamic port binding and the port has not been learnt yet.  |
| <b>Status</b>   | The status of this entry. The value learned (3), indicates that the value of the corresponding instance of dot1qTpFdbPort was learned, and is being used. mgmt (5) - the value of the corresponding instance of dot1qTpFdbAddress is also the value of an existing instance of dot1qStaticAddress. The value internal (6) indicates that the entry is an internal entry and cannot be deleted by the user. This entry gets created for the IPOE/PPPOE interfaces when the bridge port over those IPOE/PPOE interfaces gets admin enabled. The mac address in this entry shall be the one specified in the mac address profile and VlanId shall be the PortVlanId of the Bridge Port. The value other (1) indicates that this is associated with a sticky port. |

**References:**

- bridge port related commands
- bridge port stats command
- bridge static related commands
- bridge mode related commands.

## 5.6.2 Bridge Mode Commands

### 5.6.2.1 Get bridge mode

**Description:**

Use this command to get the current bridging mode.

**Command Syntax:**

**get bridge mode**

**Parameters:**

None

**Example:**

```
$ get bridge mode
```

**Output:**

Bridging Mode is Enabled

**Output Fields:**

None

**References:**

- modify bridge mode command
- bridge port command
- bridge port stats command
- bridge static command
- bridge forwarding command
- DHCP Client commands.

## 5.6.3 Bridge Port Cap Commands

### 5.6.3.1 Get bridge port cap

**Description:**

Use this command is used to get.

**Command Syntax:**

**get bridge port cap [portid <portid-val>]**

**Parameters:**

| Name                | Description   |
|---------------------|---|
| portid <portid-val> | The index of base port<br><b>Type</b> :Optional<br><b>Valid values:</b> 1 - 386<br><b>Default value:</b> None |

**Mode:**

Super-User, User

**Example:**

```
$get bridge port cap
```

**Output:**

Portid : 45

Port Capabilities : Tagging FrameTypes IngressFiltering

**Output Fields:**

| Field            | Description  |
|------------------|--|
| portid           | The index of base port.                            |
| Port Capabilites | Capabilities that are allowed on a per-port basis. |



## 5.6.4 Bridge port forwarding Commands

### 5.6.4.1 Get bridge port forwarding

**Description:**

Use this command to get.

**Command Syntax:**

```
get bridge port forwarding [portid <portid-val>] [vlanid <vlanid-val>] [macaddr <macaddr-val>]
```

### 5.6.4.2 Delete bridge port forwarding

**Description:**

Use this command to delete.

**Command Syntax:**

```
delete bridge port forwarding portid <portid-val> [vlanid <vlanid-val>] [macaddr <macaddr-val>]
```

**Parameters:**

| Name                       | Description  |
|----------------------------|--|
| <b>portid</b> <portid-val> | Port number of the port on which a frame having a source address equal to the value of the corresponding instance of dot1qTpFdbAddress, has been seen. This may have a value of "0" if the statically configured address has a dynamic port binding and the port has not been learnt yet.<br><b>Type:</b> Delete — Mandatory<br>Get — Optional<br><b>Valid values:</b> 1 - 386   |
| <b>vlanid</b> <vlanid-val> | Vlan Id to uniquely identify the entry for which the bridge has forwarding and/or filtering information. To delete an individual learned entry or all learned entries, the FdbId should be set to a valid value in case of IVL. In SVL case, this value is ignored except when the value is 4097, which is the value of a special Vlan Id used for managing the traffic for those VLANs that are neither created nor learned in the system. When Vlan transparency feature is supported, the valid range for this also includes 4097. VLAN here means the 802.1q Vlan in case of Native Vlan mode and Virtual Vlan in case of Stacked Vlan Mode.<br><b>Type:</b> Delete — Optional<br>Get — Optional |

|                                 |  |
|---------------------------------|--|
|                                 | <b>Valid values:</b> 0 -4096   |
| <b>macaddr</b><br><macaddr-val> | In the case of "delete all" entries corresponding to a port in a given FDB; the MacAddr shall have INVALID value specified by FF: FF: FF: FF: FF: FF. To delete an individual entry, valid value of Mac address has to be specified.<br><b>Type:</b> Delete — Optional<br>Get — Optional |

**Example:**

\$ get bridge port forwarding portid 10 vlanid 10 macaddr 02:03: ee: 34:55:66

**Output :**

Port Id : 10                   vlan id : 10

Mac Addr : 02:03:ee:34:55:66

Status : Mgmt

**Output Fields:**

| Field           | Description  |
|-----------------|--|
| <b>Port Id</b>  | Port number of the port on which a frame having a source address equal to the value of the corresponding instance of dot1qTpFdbAddress, has been seen. This may have a value of "0" if the statically configured address has a dynamic port binding and the port has not been learnt yet.  |
| <b>vlan id</b>  | Vlan Id to uniquely identify the entry for which the bridge has forwarding and/or filtering information. To delete an individual learned entry or all learned entries, the FdbId should be set to a valid value in case of IVL. In SVL case, this value is ignored except when the value is 4097, which is the value of a special Vlan Id used for managing the traffic for those VLANs that are neither created nor learned in the system. When Vlan transparency feature is supported, the valid range for this also includes 4097. VLAN here means the 802.1q Vlan in case of Native Vlan mode and Virtual Vlan in case of Stacked Vlan Mode. |
| <b>Mac Addr</b> | In the case of "delete all" entries corresponding to a port in a given FDB; the MacAddr shall have INVALID value specified by FF: FF: FF: FF: FF: FF. To delete an individual entry, valid value of Mac address has to be specified.   |
| <b>Status</b>   | The status of this entry. The value learned (3), indicates that the value of the corresponding instance of dot1qTpFdbPort was learned, and is being used. mgmt (5) - the value of the  |

|  |   |
|--|---|
|  | <p>corresponding instance of dot1qTpFdbAddress is also the value of an existing instance of dot1qStaticAddress. The value internal (6) indicates that the entry is a internal entry and cannot be deleted by the user. This entry gets created for the IPOE/PPPOE interfaces when the bridge port over those IPOE/PPPOE interfaces gets admin enabled. The mac address in this entry shall be the one specified in the mac address profile and VlanId shall be the PortVlanId of the Bridge Port. The value other (1) indicates that this is associated with a sticky port.</p> |
|--|---|

## 5.6.5 Bridge Port Map Commands

### 5.6.5.1 Get bridge port map

**Description:**

Use this command to get.

**Command Syntax:**

**get bridge port map** [**portid** <portid-val>] [**ifname** <interface-name>]

### 5.6.5.2 Create bridge port map

**Description:**

Use this command to create.

**Command Syntax:**

**create bridge port map portid** <portid-val> **ifname** <interface-name>

### 5.6.5.3 Delete bridge port map

**Description:**

Use this command to delete.

**Command Syntax:**

**delete bridge port map portid** <portid-val> **ifname** <interface-name>

## Parameters:

| Name                              | Description  |
|-----------------------------------|--|
| <b>portid</b> <portid-val>        | The bridge port with which a lower interface is being associated in the autosensing scenario.<br><b>Type:</b> Create – Mandatory<br>Delete – Mandatory<br>Get – Optional<br><b>Valid values:</b> eoa-*, pppoe-*, ipoe-*  |
| <b>ifname</b><br><interface-name> | 'ifname' associated with 'portid'. Only the indices of interfaces belonging the types eoa, pppoe or ipoe, are valid values for this interface.<br><b>Type:</b> Create – Mandatory<br>Delete – Mandatory<br>Get – Optional<br><b>Values:</b> eoa-*, pppoe-*, ipoe-* |

## Example:

```
$ create bridge port map portid 2 ifname eoa-0
```

## Output:

Verbose Mode On

Entry Created

Port Id : 2                      Interface Index : eoa-0

Verbose Mode Off:

Entry Created

## Output Fields:

| Field                  | Description   |
|------------------------|---|
| <b>Port Id</b>         | The bridge port with which a lower interface is being associated in the autosensing scenario.   |
| <b>Interface Index</b> | 'ifname' associated with 'portid'. Only the indices of interfaces belonging the types eoa, pppoe or ipoe, are valid values for this interface.. |

## 5.6.6 Bridge Port Stats Table Commands

### 5.6.6.1 Get bridge port stats

**Description:**

Use this command to get the statistics of a single port, or all the ports.

**Command Syntax:**

**get bridge port stats [portid <portid-val>]**

### 5.6.6.2 Reset bridge port stats

**Description:**

Use this command to reset bridge port statistics.

**Command Syntax:**

**reset bridge port stats portid <portid-val>**

**Parameters:**

| Name                          | Description   |
|-------------------------------|---|
| <b>portid</b><br><portid-val> | This is the bridge port identifier. If this is not specified in the <b>get</b> command, then information for all ports is displayed.<br><b>Type</b> : Get — Optional<br>Reset — Mandatory<br><b>Valid values</b> : 1- 578 |

**Example:**

\$ get bridge port stats portid 1

**Output:**

Verbose Mode On

```
PortId           : 1           Max Info Size    : 1500
Out Frames       : 138          In Frames        : 129
In Discards      : 3
HC In Frames     : 300
HC Out Frames    : 350
HC In Discards   : 400
```

## Output Fields:

| Field                 | Description  |
|-----------------------|--|
| <b>PortId</b>         | This is the bridge port identifier. It can be : 1- 386   |
| <b>Max Info Size</b>  | The maximum size of the INFO (non-MAC) field that this port will receive or transmit.  |
| <b>Out Frames</b>     | The number of frames that have been transmitted by this port to its segment.   |
| <b>In Frames</b>      | The number of frames that have been received by this port from its segment.  |
| <b>In Discards</b>    | Count of valid frames received, which were discarded (i.e., filtered) by the Forwarding Process.                                   |
| <b>HC In Frames</b>   | Number of frames that have been received by this port from its segment. This is valid only for Ethernet interfaces.                |
| <b>HC Out Frames</b>  | Number of frames that have been transmitted by this port to its segment. This is valid only for Ethernet interfaces.               |
| <b>HC In Discards</b> | Count of valid frames received and discarded (i.e filtered) by the Forwarding Process. This is valid only for Ethernet interfaces. |

## 5.6.7 Bridge Port Table Commands

### 5.6.7.1 Create bridge port intf

#### Description:

Use this command to create a new bridge port.

#### Command Syntax:

```
create bridge port intf portid <portid-val> ifname <interface-name> [maxucast <max-ucast-addresses> ] [learning enable|disable][status enable|disable] [stickystatus enable | disable] [FdbModify enable | disable][ acIglbdenyapply Enable | Disable ] [ acIglbtrackapply Enable | Disable ] [ proxyarpstatus enable | disable ] [ arptstatus Enable | Disable ] [ darptstatus Enable | Disable ] [ porttype trusted | untrusted ]
```

### 5.6.7.2 Delete bridge port intf

#### Description:

This command is used to delete an existing bridge port.

#### Command Syntax:

```
delete bridge port intf portid <portid-val>
```

### 5.6.7.3 Get bridge port intf

#### Description:

Use this command to get.

#### Command Syntax:

```
get bridge port intf [portid <portid-val>]
```

### 5.6.7.4 Modify bridge port intf

#### Description:

Use this command to modify.

#### Command Syntax:

```
modify bridge port intf portid <portid-val> [ maxucast <maxucast-val> ]  
[ learning enable | disable ] [ status enable | disable ] [ stickystatus enable |  
disable ] [ fdbmodify enable | disable ] [ aclglbdenyapply Enable | Disable ]  
[ aclglbtrackapply Enable | Disable ] [ proxyarpstatus enable | disable ]  
[ arptstatus Enable | Disable ] [ darpstatus Enable | Disable ] [ porttype trusted |  
untrusted ]
```

#### Parameters:

| Name                       | Description   |
|----------------------------|---|
| portid <portid-val>        | The bridge port id<br><b>Type:</b> Modify – Mandatory<br>Get – Optional<br><b>Valid values:</b> 1 - 578   |
| ifname<br><interface-name> | Interface name associated with the Port,<br><b>Type:</b> mandatory,<br><b>Values:</b> eth-*, eoa-*, pppoe-*, ipoe-*, vir-*  |
| maxucast<br><maxucast-val> | This specifies the maximum number of unicast addresses, which can be learnt from this port. This is modifiable when the admin status of bridge port is disabled. Max of number of unicast entries that can be learnt/configured on a birdge port on CPE side is 128. The default value for number of unicast entries that can be learnt or configured on a CPE side bridge port is 16. Max of number of unicast entries that can be learnt/configured on a birdge port on NET side is 4096. The default value for number of unicast entries that can be learnt or configured on a bridge port is 4096. Max of number of unicast entries that can be learnt/configured on a birdge port on downlink side is 256. The default value for number of unicast entries that can be learnt or configured on a |

|  |  |
|--|--|
|  | <p>bridge port is 256. This field is unused if the bridge port is created over an PPPOE/IPOE interface or PPPOE/ IPOE is sensed. Any value of this field shall be ignored for a bridge port created over a PPPOE/IPOE interface.</p> <p><b>Type:</b> Modify – Optional</p>   |
| <b>learning</b> enable   disable           | <p>The State of Learning on this bridge port. The value enable (1) indicates that unicast Mac address learning is enabled and the value disable indicates that unicast Mac address learning is disabled on this bridge port. The default value of learning status for CPE/Downlink side bridge ports shall be enable and for NET side bridge port default value shall be enable. This field is unused if the bridge port is created over a PPPOE/IPOE interface or PPPOE/IPOE is sensed. Any value of this field shall be ignored for a bridge port created over a PPPOE/IPOE interface.</p> <p><b>Type:</b> Modify – Optional</p>           |
| <b>status</b> enable   disable             | <p>The desired state of the bridge port. On creation the bridge port shall be created in enabled AdminStatus by default.</p> <p><b>Type:</b> Modify – Optional</p>   |
| <b>stickystatus</b> enable  disable        | <p>Indicates if the port has been set as sticky. The value enable(1) indicates that the entries learnt on this port won't be aged out. It also indicates that the entries learnt on this port shall not be learnt on any other port. The entries learnt on this port can only be removed by management action or by making the value as disable (2) so that the entries can be aged out. This field is unused if the bridge port is created over an PPPOE/ IPOE interface or PPPOE/IPOE is sensed. Any value of this field shall be ignored for a bridge port created over a PPPOE/IPOE interface.</p> <p><b>Type:</b> Modify – Optional</p> |
| <b>fdbmodify</b> enable   disable          | <p>This specifies whether this port can overwrite an existing forwarding database entry. This field is unused if the bridge port is created over an PPPOE/ IPOE interface or PPPOE/IPOE is sensed. Any value of this field shall be ignored for a bridge port created over a PPPOE/IPOE interface.</p> <p><b>Type:</b> Modify – Optional</p>   |
| <b>acIglbdenyapply</b><br>Enable  Disable  | <p>This specifies whether the global acl macency deny list represented by MO AclGlobalMacList is to be applied to this port or not. The default value of this parameter shall depend on the port type. For Net side ports, the default value shall be disable and for the cpe side ports the default value shall be enable. This field is unused if the bridge port is created over an PPPOE/IPOE interface or PPPOE/IPOE is sensed. Any value of this field shall be ignored for a bridge port created over a PPPOE/IPOE interface.</p> <p><b>Type:</b> Modify – Optional</p>   |
| <b>acIglbtrackapply</b><br>Enable  Disable | <p>This specifies whether the global acl macency track list represented by MO AclGlobalMacList is to be applied to this port or not. The default value</p>   |



|   |  |
|---|--|
|   | <p>of this parameter shall depend on the port type. For Net side ports, the default value shall be disable and for the cpe side ports the default value shall be enable. This field is unused if the bridge port is created over an PPPOE/IPOE interface or PPPOE/ IPOE is sensed. Any value of this field shall be ignored for a bridge port created over a PPPOE/IPOE interface.</p> <p><b>Type:</b> Modify – Optional</p>   |
| <p><b>proxyarpstatus</b> enable   disable</p> | <p>The Proxy Arp Status on this bridge port. The value enable of this field indicates that Proxy Arp request can be received through this port. This field can be enabled only on bridge port created over ethernet or aggregator interface. Before enabling this field user should create a filter rule with rule action as Copy to Control and rule description as IPOE_CONTROL and map it to all those interfaces through which user wants to receive proxy arp requests.</p> <p><b>Type:</b> Modify – Optional</p>   |
| <p><b>arptstatus</b> Enable   Disable</p>     | <p>This specifies whether ARP translation will be done on the ARP packets received/transmitted on this port. When enabled, ARP source MAC address of the incoming ARP packets (both request/reply) will be changed to virtual MAC address (if applicable) and the ARP target MAC address of the outgoing ARP reply packets will be changed to the original host MAC address (if applicable).</p> <p><b>Type:</b> Modify -- Optional</p>  |
| <p><b>darptstatus</b> Enable   Disable</p>    | <p>This specifies whether the ARP packets received on this bridge port are to be directed to a single port using (VLANId, IP address) to bridge port mapping learnt using DRA. This field can be enabled only on the NET side bridge port. This attribute is effective in conjunction with the attribute 'gsv dot1qVlanStaticDirectedARP' of 'Dot1qVlanStatic' MO. ARP packets are to be directed as mentioned above, only if both the flags are enabled. If any of the two is disabled, the ARP packets will be forwarded as per the normal bridging flow.</p> <p><b>Type:</b> Modify -- Optional</p> |
| <p><b>porttype</b> trusted   untrusted</p>    | <p>This field specifies whether the port is trusted or not. This information is used by some of the control plane applications to send packet on trusted ports, in case the application fails to uniquely determine a port.</p> <p><b>Type:</b> Modify -- Optional</p>   |

### Example:

```
$ create bridge port intf ifname eth-0 portid 10 maxucast 10 learning enable
stickystatus enable status enable fdbmodify disable aclglbdenyapply Disable
aclglbtrackapply Disable proxyarpstatus enable arptstatus enable darptstatus
enable porttype trusted
```

**Output:**

```

Port Id                : 10
Max Unicast Addresses : 10           Learning Status      : enable
Port Oper Status      : Disable      Port Admin Status    : Disable
Sticky Status         : enable        FDB Modify           : Disable
Acl Global Deny Apply : Disable
Acl Global Track Apply : Disable
ProxyArpStatus        : enable        Sensed IfIndex       : eoa-1
ArpTStatus            : enable        Directed ARP status  : enable
Port Type              : trusted

```

**Output Fields:**

| Field                        | Description  |
|------------------------------|--|
| <b>Port Id</b>               | The bridge port id   |
| <b>If Name</b>               | The interface name associated with the given port.   |
| <b>Max Unicast Addresses</b> | This specifies the maximum number of unicast addresses, which can be learnt from this port. This is modifiable when the admin status of bridge port is disabled. Max of number of unicast entries that can be learnt/configured on a birdge port on CPE side is 4096. The default value for number of unicast entries that can be learnt or configured on a CPE side bridge port is 4096. Max of number of unicast entries that can be learnt/configured on a birdge port on NET side is 4096. The default value for number of unicast entries that can be learnt or configured on a bridge port is 4096. Max of number of unicast entries that can be learnt/configured on a birdge port on downlink side is 256. The default value for number of unicast entries that can be learnt or configured on a bridge port is 256. This field is unused if the bridge port is created over an PPPOE/IPOE interface or PPPOE/ IPOE is sensed. Any value of this field shall be ignored for a bridge port created over a PPPOE/IPOE interface. |
| <b>Learning Status</b>       | The State of Learning on this bridge port. The value enable (1) indicates that unicast Mac address learning is enabled and the value disable indicates that unicast Mac address learning is disabled on this bridge port. The default value of learning status for CPE/Downlink side bridge ports shall be enable and for NET side bridge port default value shall be disable. This field is unused if the bridge port is created over an PPPOE/IPOE interface or PPPOE/IPOE is sensed. Any value of this field shall be ignored for a bridge port created over a PPPOE/IPOE interface.  |
| <b>Port Oper Status</b>      | The current operational state of the bridge port. If AdminStatus of the  |

|                               |   |
|-------------------------------|---|
|                               | bridge port is disable (2), then OperStatus of the port should be disable (2). If AdminStatus of the bridge port is changed to enable(1), then OperStatus of the port should change to enable(1) if the bridge port is ready to transmit and receive network traffic. The bridge port will have the OperStatus value as dormant (5) if the 'configstatus' of the bridge port is 'config' and it is waiting for a packet to be sensed, on its lower interface index, to get activated.   |
| <b>Port Admin Status</b>      | The desired state of the bridge port. On creation the bridge port shall be created in enabled AdminStatus by default.   |
| <b>Sticky Status</b>          | Indicates if the port has been set as sticky. The value enable(1) indicates that the entries learnt on this port won't be aged out. It also indicates that the entries learnt on this port shall not be learnt on any other port. The entries learnt on this port can only be removed by management action or by making the value as disable (2) so that the entries can be aged out. This field is unused if the bridge port is created over an PPPOE/ IPOE interface or PPPOE/IPOE is sensed. Any value of this field shall be ignored for a bridge port created over a PPPOE/IPOE interface. |
| <b>FDB Modify</b>             | This specifies whether this port can overwrite an existing forwarding database entry. This field is unused if the bridge port is created over an PPPOE/ IPOE interface or PPPOE/IPOE is sensed. Any value of this field shall be ignored for a bridge port created over a PPPOE/IPOE interface.   |
| <b>AcI Global Deny Apply</b>  | This specifies whether the global acI macentry deny list represented by MO AcIGlobalMacList is to be applied to this port or not. The default value of this parameter shall depend on the port type. For Net side ports, the default value shall be disable and for the cpe side ports the default value shall be enable. This field is unused if the bridge port is created over an PPPOE/IPOE interface or PPPOE/IPOE is sensed. Any value of this field shall be ignored for a bridge port created over a PPPOE/IPOE interface.  |
| <b>AcI Global Track Apply</b> | This specifies whether the global acI macentry track list represented by MO AcIGlobalMacList is to be applied to this port or not. The default value of this parameter shall depend on the port type. For Net side ports, the default value shall be disable and for the cpe side ports the default value shall be enable. This field is unused if the bridge port is created over an PPPOE/IPOE interface or PPPOE/ IPOE is sensed. Any value of this field shall be ignored for a bridge port created over a PPPOE/IPOE interface.  |
| <b>ProxyArpStatus</b>         | The Proxy Arp Status on this bridge port. The value enable of this field  |

|                            |  |
|----------------------------|--|
|                            | <p>indicates that Proxy Arp request can be received through this port.</p> <p>This field can be enabled only on bridge port created over ethernet or aggregator interface. Before enabling this field user should create a filter rule with rule action as Copy to Control and rule description as IPOE_CONTROL and map it to all those interfaces through which user wants to receive proxy arp requests.</p>   |
| <b>Sensed IfIndex</b>      | <p>This specifies the sensed interface index corresponding to the bridge port. This field is used to determine the stack sensed for this bridge port in the auto sensing scenario. This field cannot be modified. If the oper status of the bridge port is 'enable' or 'disable' then the value of this field gives the interface index on which the bridge port is currently stacked. If the oper status is 'dormant' and the value of this field is other than '-', then it represents the last interface index on which the bridge port had been stacked.</p> |
| <b>ArpStatus</b>           | <p>This specifies whether ARP translation will be done on the ARP packets received/transmitted on this port. When enabled, ARP source MAC address of the incoming ARP packets (both request/reply) will be changed to virtual MAC address (if applicable) and the ARP target MAC address of the outgoing ARP reply packets will be changed to the original host MAC address (if applicable).</p>   |
| <b>Directed ARP status</b> | <p>This specifies whether the ARP packets received on this bridge port are to be directed to a single port using (VLANId, IP address) to bridge port mapping learnt using DRA. This field can be enabled only on the NET side bridge port. This attribute is effective in conjunction with the attribute 'gsv dot1qVlanStaticDirectedARP' of 'Dot1qVlanStatic' MO. ARP packets are to be directed as mentioned above, only if both the flags are enabled. If any of the two is disabled, the ARP packets will be forwarded as per the normal bridging flow.</p>  |
| <b>Port Type</b>           | <p>This field specifies whether the port is trusted or not. This information is used by some of the control plane applications to send packet on trusted ports, in case the application fails to uniquely determine a port.</p>  |

## 5.6.8 Bridge static mcast Commands

### 5.6.8.1 Get bridge static mcast

**Description:**

Use this command to get.

**Command Syntax:**

```
get bridge static mcast [vlanid <vlanid-val>] [mcastaddr <mcastaddr-val>]
```

### 5.6.8.2 Create bridge static mcast

**Description:**

Use this command to create.

**Command Syntax:**

```
create bridge static mcast vlanid <vlanid-val> mcastaddr <mcastaddr-val>  
[egressports egressports | none] [forbidegressports <forbidegressports-val> |  
none]
```

### 5.6.8.3 Delete bridge static mcast

**Description:**

Use this command to delete.

**Command Syntax:**

```
delete bridge static mcast vlanid <vlanid-val> mcastaddr <mcastaddr-val>
```

### 5.6.8.4 Modify bridge static mcast

**Description:**

Use this command to modify.

**Command Syntax:**

```
modify bridge static mcast vlanid <vlanid-val> mcastaddr <mcastaddr-val>  
[egressports <egressports-val> | none | none] [forbidegressports  
<forbidegressports-val>> | none]
```

## Parameters:

| Name  | Description   |
|---|---|
| <b>vlanid</b> <vlanid-val>                                    | <p>The VLAN id for this VLAN. In devices supporting "Shared Vlan for multicast" capability, the information for a multicast MAC address is shared across VLANS. Hence, vlanid is optional and can be passed as zero or a valid vlanid value. In devices supporting "Independent Vlan for multicast" capability, each vlan can have its own information for a multicast MAC address. Hence, VLAN id is a mandatory parameter and a valid value of vlanid must be passed. For the case when the attribute "McastDeviceCapabilities" of MO "sysSizingTable" has value "none", VLAN id is not required. This feature is not supported for VLAN with vlanid as 4097.VLAN here means the 802.1q Vlan in case of Native Vlan mode and Virtual Vlan in case of Stacked Vlan Mode.</p> <p><b>Type:</b> Create – Mandatory<br/> Delete – Mandatory<br/> Modify – Mandatory<br/> Get – Optional</p> <p><b>Valid values:</b> 0 - 4095</p> |
| <b>mcastaddr</b><br><mcastaddr-val>                           | <p>The destination multicast MAC address in a frame, to which the filtering information of this entry applies.</p> <p><b>Type:</b> Create – Mandatory<br/> Delete – Mandatory<br/> Modify – Mandatory<br/> Get – Optional</p>   |
| <b>egressports</b><br><egressports-val><br> none              | <p>The set of ports, to which frames received from a specific port and destined for a specific Multicast MAC address must be forwarded. A port may not be added in this set if it is already a member of the set of ports in ForbiddenEgressPorts.</p> <p><b>Type:</b> Create – Optional<br/> Modify – Optional</p> <p><b>Valid values:</b> 0<br/> <b>Default value:</b> 0</p>  |
| <b>Forbidegressports</b><br><forbidegressports-val><br>  none | <p>The set of ports, to which frames received from a specific port and destined for a specific Multicast MAC address must not be forwarded, regardless of any dynamic information. A port may not be added in this set if it is already a member of the set of ports in EgressPorts.</p> <p><b>Type:</b> Create – Optional<br/> Modify – Optional</p> <p><b>Valid values:</b> 0<br/> <b>Default value:</b> 0</p>  |

**Example:**

```
$ create bridge static mcast vlanid 7 mcastaddr 00:30:4F:00:00:01 rcvport 0
egressports 10 forbidegressports 20 SKIP 1
```

**Output:**

Verbose Mode On

Entry Created

Vlan Index : 7 Mcast Address : 00:30:4F:00:00:01

Egress ports : 10

Forbidden Egress ports : 20

Verbose Mode Off:

Entry Created

**Output Fields:**

| Field                         | Description  |
|-------------------------------|--|
| <b>Vlan Index</b>             | The VLAN id for this VLAN. In devices supporting "Shared Vlan for multicast" capability, the information for a multicast MAC address is shared across VLANS. Hence, vlanid is optional and can be passed as zero or a valid vlanid value. In devices supporting "Independent Vlan for multicast" capability, each vlan can have its own information for a multicast MAC address. Hence, VLAN id is a mandatory parameter and a valid value of vlanid must be passed. For the case when the attribute "McastDeviceCapabilities" of MO "sysSizingTable" has value "none", VLAN id is not required. This feature is not supported for VLAN with vlanid as GS_UNREGISTERED_VLANID.VLAN here means the 802.1q Vlan in case of Native Vlan mode and Virtual Vlan in case of Stacked Vlan Mode. |
| <b>Mcast Address</b>          | The destination multicast MAC address in a frame, to which the filtering information of this entry applies.  |
| <b>Egress ports</b>           | The set of ports, to which frames received from a specific port and destined for a specific Multicast MAC address must be forwarded. A port may not be added in this set if it is already a member of the set of ports in ForbiddenEgressPorts.  |
| <b>Forbidden Egress ports</b> | The set of ports, to which frames received from a specific port and destined for a specific Multicast MAC address must not be forwarded, regardless of any dynamic information. A port may not be added in this set if it is already a member of the set of ports in EgressPorts.  |

**Cautions:**

- An entry in this table shall not be applicable for a bridge port created over PPPOE/IPOE interface.

**References:**

- Bridge Commands

## 5.6.9 Bridge static ucast Commands

### 5.6.9.1 Get bridge static ucast

**Description:**

Use this command to get.

**Command Syntax:**

```
get bridge static ucast [vlanid <vlanid-val>] [ucastaddr <ucastaddr-val>]
```

### 5.6.9.2 Create bridge static ucast

**Description:**

Use this command to create.

**Command Syntax:**

```
create bridge static ucast vlanid <vlanid-val> ucastaddr <ucastaddr-val>  
[portid <portid-val>]
```

### 5.6.9.3 Delete bridge static ucast

**Description:**

Use this command to delete.

**Command Syntax:**

```
delete bridge static ucast vlanid <vlanid-val> ucastaddr <ucastaddr-val>
```



## 5.6.9.4 Modify bridge static ucast

### Description:

Use this command to modify.

### Command Syntax:

```
modify bridge static ucast vlanid <vlanid-val> ucastaddr <ucastaddr-val>  
[portid <portid-val>]
```

### Parameters:

| Name                                | Description   |
|-------------------------------------|---|
| <b>vlanid</b> <vlanid-val>          | <p>The VLAN index referring to this VLAN. In case of device capability not supporting vlans, vlan id "0" is a valid value. VLAN here means the 802.1q Vlan in case of Native Vlan mode and Virtual Vlan in case of Stacked Vlan Mode.</p> <p><b>Type:</b> Create — Mandatory<br/>Delete — Mandatory<br/>Modify — Mandatory<br/>Get — Optional</p> <p><b>Valid values:</b> 0 - 4095</p>                                  |
| <b>ucastaddr</b><br><ucastaddr-val> | <p>The destination unicast MacAddr to which filtering info applies.</p> <p><b>Type:</b> Create — Mandatory<br/>Delete — Mandatory<br/>Modify — Mandatory<br/>Get — Optional</p>   |
| <b>portid</b> <portid-val>          | <p>The set of ports, for which a frame with a specific unicast address will be flooded in the event that it has not been learned. It also specifies the set of ports a specific unicast address may be dynamically learnt on. This list shall have only the CPE side ports. Currently only one port can be set in this list. <b>Type:</b> Create — Optional<br/>Modify — Optional</p> <p><b>Valid values:</b> 1-386</p> |

### Example:

```
$create bridge static ucast vlanid 1 ucastaddr 1:1:1:1:1:1 rcvport 0 portid 2 status  
1 cfgmode Config
```

**Output:**

Verbose Mode On

Entry Created

Vlan Index : 1                      Ucast Address : 1:1:1:1:1:1

Port Id        : 2

Verbose Mode Off:

Entry Created

**Output Fields:**

| Field                | Description   |
|----------------------|---|
| <b>Vlan Index</b>    | The VLAN index referring to this VLAN. In case of device capability not supporting vlans, vlan id "0" is a valid value. VLAN here means the 802.1q Vlan in case of Native Vlan mode and Virtual Vlan in case of Stacked Vlan Mode.  |
| <b>Ucast Address</b> | The destination unicast MacAddr to which filtering info applies.  |
| <b>Port Id</b>       | The set of ports, for which a frame with a specific unicast address will be flooded in the event that it has not been learned. It also specifies the set of ports a specific unicast address may be dynamically learnt on. This list shall have only the CPE side ports. Currently only one port can be set in this list. Type - optional, Valid values:1-386 |

**Cautions:**

- An entry in this table shall not be applicable for a bridge port created over PPPOE/IPOE interface.

**References:**

- Bridge Commands.

## 5.6.10 Bridge tbg traps Commands

### 5.6.10.1 Get bridge tbg traps

**Description:**

Use this command to get.

**Command Syntax:**

**get bridge tbg traps**

### 5.6.10.2 Modify bridge tbg traps

**Description:**

Use this command to modify.

**Command Syntax:**

**modify bridge tbg traps [bindingstatus enable | disable] [fdbtrapstatus enable | disable] [vmactrapstatus enable | disable] [traploss Ok | Notok]**

**Parameters:**

| Name                                     | Description  |
|--|--|
| <b>bindingstatus</b> enable<br> disable  | This parameter allows the user to enable or disable the generation of 'binding status changed' trap. This trap is sent when the port binding of a unicast entry changes, i.e. the same address is learnt on a different port in the same Forwarding Database.<br><b>Type:</b> Modify — Optional  |
| <b>fdbtrapstatus</b> enable<br> disable  | This parameter allows the user to enable or disable the generation of forwarding table trap. This trap is sent when an entry in the forwarding table is learnt/ created/modified/deleted or aged out. These traps shall be given by the packet filter module to the applications registered for these traps.<br><b>Type:</b> Modify — Optional           |
| <b>vmactrapstatus</b><br>enable  disable | This parameter allows the user to enable or disable the generation of trap when MAC to Virtual MAC mapping for the MAC address is not found in the M2VMac database associated with the corresponding interface. These traps shall be given by the packet filter module to the applications registered for these traps.<br><b>Type:</b> Modify — Optional |
| <b>traploss</b> Ok   Notok               | This parameter tells whether the loss of binding status and forwarding table trap is acceptable or not. Such a trap can be lost because of the unavailability of resources. 'OK' means trap loss is acceptable. In this case, when the trap is lost an indication shall be given to the application, which can then                                      |

|  |  |
|--|--|
|  | <p>synchronize its database with the forwarding table. 'NotOK' means trap loss is not acceptable. In this case, if it is not possible to raise the trap for any forwarding table entry getting learnt/modified/deleted, that entry shall not get learnt/modified/delete.</p> <p><b>Type:</b> Modify — Optional</p> |
|--|--|

**Example:**

```
$ get bridge tbg traps
```

**Output:**

```
Binding Status Changed Trap : enable      Forwarding Table Trap : enable
Virtual Mac Trap           : enable
Forwarding Table Trap Loss  : OK
```

**Output Fields:**

| Field                              | Description   |
|------------------------------------|---|
| <b>Binding Status Changed Trap</b> | This parameter allows the user to enable or disable the generation of 'binding status changed' trap. This trap is sent when the port binding of a unicast entry changes, i.e. the same address is learnt on a different port in the same Forwarding Database.   |
| <b>Forwarding Table Trap</b>       | This parameter allows the user to enable or disable the generation of forwarding table trap. This trap is sent when an entry in the forwarding table is learnt/created/modified/deleted or aged out. These traps shall be given by the packet filter module to the applications registered for these traps.   |
| <b>Virtual Mac Trap</b>            | This parameter allows the user to enable or disable the generation of trap when MAC to Virtual MAC mapping for the MAC address is not found in the M2VMac database associated with the corresponding interface. These traps shall be given by the packet filter module to the applications registered for these traps.  |
| <b>Forwarding Table Trap Loss</b>  | This parameter tells whether the loss of binding status and forwarding table trap is acceptable or not. Such a trap can be lost because of the unavailability of resources. OK means trap loss is acceptable. In this case, when the trap is lost an indication shall be given to the application, which can then synchronize its database with the forwarding table. NotOK means trap loss is not acceptable. In this case, if it is not possible to raise the trap for any forwarding table entry getting learnt/modified/deleted, that entry shall not get learnt/modified/delete. |

**References:**

- Bridge Commands

## 5.6.11 GARP Port Info Commands

### 5.6.11.1 Get garp port info

**Description:**

Use this command to get.

**Command Syntax:**

**get garp port info** [**portid** <portid-val>]

### 5.6.11.2 Modify garp port info

**Description:**

Use this command to modify.

**Command Syntax:**

**modify garp port info portid** <portid-val> [**jointimer** <jointimer-val>] [**leavetimer** <leavetimer-val>] [**leavealltimer** <leavealltimer-val>]

**Parameters:**

| Name  | Description  |
|---|--|
| <b>portid</b> <portid-val>                  | Index of the Bridge Port<br><b>Type</b> : Get - Optional<br>Modify - Mandatory<br><b>Valid values:</b> 1 - 386   |
| <b>jointimer</b><br><jointimer-val>         | The GARP Join time, in centiseconds. Join time value should be less than half the Leave time value<br><b>Type</b> : Optional<br><b>Valid values:</b> 10-255                                |
| <b>leavetimer</b><br><leavetimer-val>       | The GARP Leave time, in centiseconds. Leave time value should be greater than 2 times Join time value.<br><b>Type</b> : Optional<br><b>Valid values:</b> 10-255                            |
| <b>leavealltimer</b><br><leavealltimer-val> | The GARP LeaveAll time, in centiseconds. LeaveAll time value should be large (more than 15 times) relative to Leave time value.<br><b>Type</b> : Optional<br><b>Valid values:</b> 10-65535 |

**Example:**

\$ get garp port info

**Output:**

```
PortId      Join Timer Leave Timer LeaveAll Timer
-----
```

```
6           30           90           5000
```

**Output Fields:**

| Field          | Description   |
|----------------|---|
| PortId         | Index of the Bridge Port.   |
| Join Timer     | The GARP Join time, in centiseconds. Join time value should be less than half the Leave time value.                             |
| Leave Timer    | The GARP Leave time, in centiseconds. Leave time value should be greater than 2 times Join time value.                          |
| LeaveAll Timer | The GARP LeaveAll time, in centiseconds. LeaveAll time value should be large (more than 15 times) relative to Leave time value. |

**References:**

- GVRP Commands

**5.6.12 STP Group Commands****5.6.12.1 Get stp info****Description:**

Use this command to display the current status of the Spanning Tree Protocol Group.

**Command Syntax:**

```
get stp info
```

**5.6.12.2 Modify stp info****Description:**

Use this command to alter the configuration for the spanning tree protocol group.

**Command Syntax:**

```
modify stp info [priority <priority-val>] [maxage <maximum-age>] [htime <hello-time>] [fdelay <forward-delay>] [enable|disable]
```

### 5.6.12.3 Reset stp stats

#### Description:

Use this command to reset STP global statistics.

#### Command Syntax:

**reset stp stats**

#### Parameters:

| Name                           | Description  |
|--------------------------------|--|
| <b>Priority</b> <priority-val> | The value of the write-able portion of the Bridge ID, i.e., the first two octets of the (8 octet long) Bridge ID. The other (last) 6 octets of the Bridge ID are given by the value of dot1dBaseBridgeAddress.<br><br><b>Type</b> : Optional<br><b>Valid values:</b> 0 - 65535.  |
| <b>Maxage</b><br><maximum-age> | The maximum age of Spanning Tree Protocol information learned from the network on any port before it is discarded, in units of seconds. This is the actual value that this bridge is currently using.<br><br><b>Type</b> : Optional<br><b>Valid values:</b> 6 - 40.  |
| <b>htime</b> <hello-time>      | The amount of time between the transmission of Configuration bridge PDUs by this node on any port when it is the root of the spanning tree or trying to become so, in units of second. This is the actual value that this bridge is currently using.<br><br><b>Type</b> : Optional<br><b>Valid values:</b> 1 - 10  |
| <b>Fdelay</b> <forward-delay>  | This is the actual time value, measured in units of seconds, controls how fast a port changes its spanning state when moving towards the Forwarding state. The value determines how long the port stays in each of the Listening and Learning states, which precede the Forwarding state. This value is also used, when a topology change has been detected and is underway, to age all dynamic entries in the Forwarding Database.<br><br><b>Type</b> : Optional<br><b>Valid values:</b> 4 - 30 |
| Enable disable                 | Spanning Tree Protocol to be enabled on the Bridge or not. Spanning Tree Protocol can not be enabled in Stacked Vlan   |

|  |  |
|--|--|
|  | mode.<br><b>Type :</b> Optional<br><b>Valid values:</b> disable   enable |
|--|--|

**Example:**

```
$ modify stp info priority 0x20 maxage 25 htime 5 fdelay 20 enable
```

**Output:**

```
Protocol Spec. : IEEE 8021D          Priority : 0x20
Top. Changes   : 1                   Curr Top. Age(sec) : 35.0
Desig Root    : 00:30:4F:10:5A:6C:DB:20 Root Cost : 0
Root Port     : None                 Hold Time (sec) : 1.0
Br Max Age(sec) : 25                 Curr Max Age (sec) : 20.0
Br Hello Time(sec) : 5               Curr Hello Time(sec) :2.0
Br Fwd Delay(sec) : 20              Curr Fwd Delay (sec) :15.0
STP status    : enable
Verbose Mode Off
Set Done
```

**Output Fields:**

| Field                     | Description  |
|---------------------------|--|
| <b>Protocol Spec</b>      | An indication of what version of the Spanning Tree Protocol is being run.  |
| <b>Priority</b>           | The value of the write-able portion of the Bridge ID,i.e.,the first two octets of the (8 octet long) Bridge ID. The other (last) 6 octets of the Bridge ID are given by the value of dot1dBaseBridgeAddress.                               |
| <b>Top. Changes</b>       | The total number of topology changes detected by this bridge since the management entity was last reset or initialized.  |
| <b>Curr Top. Age(Sec)</b> | The time (in second) since the last time a topology change was detected by the bridge entity.  |
| <b>Desig Root</b>         | The bridge identifier of the root of the spanning tree as determined by the Spanning Tree Protocol as executed by this node. This value is used as the Root Identifier parameter in all Configuration Bridge PDUs originated by this node. |
| <b>Root Cost</b>          | The cost of the path to the root as seen from this bridge.   |
| <b>Root Port</b>          | The port number of the port which offers the lowest cost path from this bridge to the root bridge.   |
| <b>Hold Time (Sec)</b>    | This time value determines the interval length during which no more than two Configuration bridge PDUs shall be transmitted by   |



|                             |   |
|-----------------------------|---|
|                             | this node, in units of seconds.   |
| <b>Br Max Age(Sec)</b>      | The maximum age of Spanning Tree Protocol information learned from the network on any port before it is discarded, in units of seconds, when this bridge is the root of the spanning tree. Note that IEEE-802.1D specifies that the range for this parameter is related to the value of dot1dStpBridgeHelloTime.  |
| <b>Curr Max Age (Sec)</b>   | The maximum age of Spanning Tree Protocol information learned from the network on any port before it is discarded, in units of seconds. This is the actual value that this bridge is currently using.   |
| <b>Br Hello Time(Sec)</b>   | The value that all bridges use for HelloTime when this bridge is acting as the root.  |
| <b>Curr Hello Time(Sec)</b> | The amount of time between the transmission of Configuration bridge PDUs by this node on any port when it is the root of the spanning tree or trying to become so, in units of second. This is the actual value that this bridge is currently using.  |
| <b>Br Fwd Delay(Sec)</b>    | The value that all bridges use for ForwardDelay when this bridge is acting as the root. Note that IEEE-802.1D specifies that the range for this parameter is related to the value of dot1dStpBridgeMaxAge.  |
| <b>Curr Fwd Delay (Sec)</b> | This is the actual time value, measured in units of seconds, controls how fast a port changes its spanning state when moving towards the Forwarding state. The value determines how long the port stays in each of the Listening and Learning states, which precede the Forwarding state. This value is also used, when a topology change has been detected and is underway, to age all dynamic entries in the Forwarding Database. |
| <b>STP status</b>           | Spanning Tree Protocol to be enabled on the Bridge or not. Spanning Tree Protocol can not be enabled in Stacked Vlan mode.  |

### References:

- get stp info command
- stp port related commands.

## 5.6.13 STP Port Commands

### 5.6.13.1 Get stp port

**Description:**

Use this command to display port specific information for the Spanning Tree Protocol, for all ports, or for the specified port.

**Command Syntax:**

**get stp port info portid** <portid-val>

### 5.6.13.2 Modify stp port

**Description:**

Use this command to alter the configuration for the spanning tree protocol.

**Command Syntax:**

**modify stp port info portid** <portid-val> [enable|disable] [**pcost** <pcost-val>]  
[**priority** <priority-val>] [**pktpriority** <pktpriority-val>]

### 5.6.13.3 Reset stp port stats

**Description:**

Use this command to reset the STP port stats for a specific interface.

**Command Syntax:**

**reset stp port stats portid** <portid-val>

**Parameters:**

| Name                           | Description   |
|--------------------------------|---|
| <b>portid</b> <portid-val>     | The port number of the port for which this entry contains Spanning Tree Protocol management information.<br><b>Type</b> : Mandatory<br><b>Valid values</b> : 1 to 386;        |
| <b>enable disable</b>          | Spanning Tree Protocol to be enabled on the Port or not<br><b>Type</b> : Optional<br><b>Valid values</b> : enable, disable  |
| <b>pcost</b> <pcost-val>       | The contribution of this port to the path cost of paths towards the spanning tree root, which include this port.<br><b>Type</b> : Optional<br><b>Valid values</b> : 1 - 65535 |
| <b>priority</b> <priority-val> | The value of the priority field which is contained in the most  |

|   |   |
|---|---|
|   | <p>significant 6 bits of the more significant octet of the (2 octet long) Port ID. The least significant 2 bits of the more significant octet and the less significant octet (total 10 bits) of the Port ID is given by the value of dot1dStpPort.</p> <p><b>Type:</b> Optional</p> <p><b>Valid values:</b> 0 -255.</p> |
| <p><b>pktpriority</b><br/>&lt;pktpriority-val&gt;</p> | <p>For STP PDUs, this priority shall be used for choice of traffic class/ Queue on outgoing interface. In case the bridge port is over an Aggregated ATM VC, this will also be used to identify the VC, on which the packet is to be sent.</p> <p><b>Type:</b> Modify — Optional</p> <p><b>Valid values:</b> 0 - 7</p>  |

**Example:**

```
$ modify stp port portid 1 disable pcost 1000 priority 0x10
```

**Output:**

Verbose Mode On

```
Port ID : 1                Priority      : 0x0
State : Forwarding        PortStatus   : Enable
Path Cost : 100           Desig Cost   : 0
Desig Root:00:30:4F0:10:5A:6C  Desig Bridge:00:30:4F:10:5A:6C
Desig Port : 0x8000       Fwd Transitions : 1
STP Status : Enable
```

Set Done

```
Port ID : 1                Priority      : 0x0
State : Forwarding        PortStatus   : Enable
Path Cost : 100           Desig Cost   : 0
Desig Root:00:30:4F:10:5A:6C  Desig Bridge:00:30:4F:10:5A:6C
Desig Port : 0x8000       Fwd Transitions : 1
STP Status : Enable       STP PacketsPrio : 2
Verbose Mode Off
Set Done
```

## Output Fields:

| Field                  | Description  |
|------------------------|--|
| <b>Port Id</b>         | The port number of the port for which this entry contains Spanning Tree Protocol management information.   |
| <b>Priority</b>        | The value of the priority field which is contained in the most significant 6 bits of the more significant octet of the (2 octet long) Port ID. The least significant 2 bits of the more significant octet and the less significant octet (total 10 bits) of the Port ID is given by the value of dot1dStpPort. |
| <b>State</b>           | The port's current state as defined by application of the Spanning Tree Protocol. This state controls what action a port takes on reception of a frame.  |
| <b>Port Status</b>     | The enabled/disabled status of the port.   |
| <b>Path Cost</b>       | The contribution of this port to the path cost of paths towards the spanning tree root which include this port.  |
| <b>Desig Cost</b>      | The path cost of the Designated Port of the segment connected to this port. This value is compared to the Root Path Cost field in received bridge PDUs.  |
| <b>Desig Root</b>      | The unique Bridge Identifier of the Bridge recorded as the Root in the Configuration BPDUs transmitted by the Designated Bridge for the segment to which the port is attached.   |
| <b>Desig Bridge</b>    | The Bridge Identifier of the bridge which this port considers to be the Designated Bridge for this port's segment.   |
| <b>Desig Port</b>      | The Port Identifier of the port on the Designated Bridge for this port's segment.  |
| <b>Fwd Transitions</b> | The number of times this port has transitioned from the Learning state to the Forwarding state.  |
| <b>STP status</b>      | Spanning Tree Protocol to be enabled on the Bridge or not.   |
| <b>STP PacketsPrio</b> | For STP PDUs, this priority shall be used for choice of traffic class/ Queue on outgoing interface. In case the bridge port is over an Aggregated ATM VC, this will also be used to identify the VC, on which the packet is to be sent   |

## Caution:

- The specified interface should be an existing bridge interface.

## References:

- bridge port intf command.

## 5.6.14 Transparent Bridging Table Commands

### 5.6.14.1 Modify bridge tbg info

#### Description:

Use this command to modify.

#### Command Syntac:

```
modify bridge tbg info [aging <aging-timeout> ] [slaveaging <aging-timeout> ]  
[netaging <aging-timeout> ] [ floodsupport enable | disable ] [ bcastsupport  
enable | disable] [ mcastsupport enable | disable ] [ mcastdrop enable | disable ]  
[ dropifdbfull <dropifdbfull-val> ] [ resnetlearning <resnetlearning-val> ]  
[resvmacprofileid <resvmacprofileid-val> ]
```

### 5.6.14.2 Get Bridge tbg info

#### Description:

Use this command to get bridging related global information.

#### Command Syntax:

```
get bridge tbg info
```

#### Parameters:

| Name                                 | Description   |
|--------------------------------------|---|
| <b>Aging</b> <aging-timeout>         | The timeout period, in seconds, for aging out dynamically learned forwarding information from CPEs. The value 0 can be configured when aging is to be stopped.<br><b>Type:</b> Modify Optional<br><b>Valid values:</b> 10 -1000000  |
| <b>slaveaging</b><br><aging-timeout> | The timeout period, in seconds, for aging out dynamically learned forwarding information learned from the slave device. The recommended value for this is more than or equal to the value for dot1dTpAgingTimeOut. The value 0 can be configured when aging is to be stopped.<br><b>Valid values:</b> 10 -1000000   |
| <b>netaging</b> <aging –<br>timeout> | The timeout period, in seconds, for aging out dynamically learned forwarding information from NET side port. This is used only for full bridge configuration. The recommended value of net aging timeout should be greater than that of the ìAgingî parameter. The value 0 can be configured when aging is to be stopped.<br><b>Valid values:</b> 10 -1000000 |

|  |  |
|--|--|
| <b>floodsupport</b> enable   disable   | <p>This is used to specify whether the unknown unicast packets are to be flooded or not. The value for this is used along with per vlan configuration for flood support to determine if flooding has to be done for unknown unicast packet.</p> <p><b>Type</b> : Optional</p> <p><b>Valid Values:</b> enable   disable</p>   |
| <b>bcastsupport</b> enable disable     | <p>This is used to specify whether the broadcasting is supported or not. The value for this is used along with per vlan configuration broadcast support, to determine if broadcasting has to be done for the broadcast packet.</p>   |
| <b>mcastsupport</b> enable disable     | <p>Used to specify whether the multicast is supported or not.</p> <p><b>Type</b> : Optional</p> <p><b>Valid Values:</b> enable  disable</p>  |
| <b>mcastdrop</b> enable disable        | <p>Used to specify whether the multicast packets are to be dropped, or to be forwarded, if multicast is not supported. This is only valid if <b>dot1dTpMcastSupport</b> is false.</p> <p><b>Type</b> : Optional</p> <p><b>Valid Values:</b> enable disable</p>   |
| <b>dropifdbfull</b> enable   disable   | <p>This specifies if the frame for which learning could not be done because of forwarding table limit being reached, is to be dropped. If this is enabled the frame for which learning could not be done because of limit exceeded shall be dropped, else forwarded based on bridge forwarding logic. This being enabled shall reduce flooding, as when a response to such a frame from which learning could not be done shall come the frame shall be flooded, as the entry for that unicast address, shall not be found in forwarding table.</p> <p><b>Type</b> : Optional</p> <p><b>Valid Values:</b> enable or disable</p> <p><b>Default value:</b> enable</p> |
| <b>resnetlearning</b> enable   disable | <p>This specifies if learning can be done over net side port for residential bridging. Learning shall be done on Net port in case of vlan with residential bridging if 'dot1dPortGsLearningStatus' and 'dot1dTpGsResidentialNetLearning' is enabled. In case of vlan with 'unrestricted' or 'restricted' bridging the learning is governed only by per port configuration i.e. 'dot1dBasePortTable'. Currently the modification of this parameter is not supported.</p> <p><b>Type</b> : Optional</p> <p><b>Valid Values:</b> enable or disable</p> <p><b>Default value:</b> enable</p>  |
| <b>resvmacprofileid</b>                | <p>The Profile is used to determine the behavior for Reserved Mac</p>  |

|                        |  |
|------------------------|--|
| <resvmacprofileid-val> | <p>destined frames on the bridge. Reserved Mac addresses are the multicast addresses defined as reserved in IEEE 802.1Q and IEEE 802.1ad. If it does not contain any valid value then the behavior for Reserved Mac destined frames is determined based on Resvd Mac profile associated with the VLAN in which the frame belongs to. VLAN here means the 802.1q Vlan in case of Native Vlan mode and Virtual Vlan in case of Stacked Vlan Mode.</p> <p><b>Type:</b> Modify — Optional</p> <p><b>Valid values:</b> 1 -4</p> |
|------------------------|--|

**Example:**

```
$ modify bridge tbg info aging 20 slaveaging 100
```

**Output:**

Verbose Mode On

```
MacAddress          : 00:BB:CC:DD:EE:FF
No. of Ports       : 0
Base Type          : Transparent
Aging Timeout(sec) : 300                Slaveaging TimeOut(sec) : 600
Netaging TimeOut(sec) : 600            Flood Support           : Disable
BroadCast Support  : Enable            MultiCast Support      : Enable
MultiCast Drop    : Disable            Full Bridging Status   :
Unrestricted
Drop If FDB full status: Enable        ResidentialNetLearning : Enable
Reserved Mac Profile Id: 1
```

Set Done

```
MacAddress          : 00:BB:CC:DD:EE:FF
No. of Ports       : 0
Base Type          : Transparent
Aging Timeout(sec) : 20                Slaveaging TimeOut(sec) : 100
Netaging TimeOut(sec) : 600            Flood Support           : Disable
BroadCast Support  : Enable            MultiCast Support      : Enable
MultiCast Drop    : Disable            Full Bridging Status   :
Unrestricted
Drop If FDB full status: Enable        ResidentialNetLearning : Enable
Reserved Mac Profile Id: 1
```

## Output Fields:

| Field                       | Description  |
|-----------------------------|--|
| <b>MacAddress</b>           | The MAC address used by this bridge, when it must be referred to, in a unique fashion. It is the address of one of the Ethernet ports.   |
| <b>No. of Ports</b>         | The maximum number of ports that can be controlled by this bridge.   |
| <b>Base Type</b>            | Indicates what type of bridging this bridge can perform. It is always Transparent Bridging or STP.   |
| <b>Aging TimeOut</b>        | The timeout period, in seconds, for aging out dynamically learned forwarding information from CPEs. The value 0 can be configured when aging is to be stopped.   |
| <b>Slaveaging TimeOut</b>   | The timeout period, in seconds, for aging out dynamically learned forwarding information learned from the slave device. The recommended value for this is more than or equal to the value for dot1dTpAgingTimeOut. The value 0 can be configured when aging is to be stopped.  |
| <b>Floodsupport</b>         | This is used to specify whether the unknown unicast packets are to be flooded or not. The value for this is used along with per vlan configuration for flood support to determine if flooding has to be done for unknown unicast packet.   |
| <b>Bcastsupport</b>         | This is used to specify whether the broadcasting is supported or not. The value for this is used along with per vlan configuration broadcast support, to determine if broadcasting has to be done for the broadcast packet.  |
| <b>Mcastsupport</b>         | Used to specify whether the multicast is supported or not.   |
| <b>Mcastdrop</b>            | Used to specify whether the multicast packets are to be dropped, or to be forwarded, if multicast is not supported. This is only valid if <b>dot1dTpMcastSupport</b> is <b>false</b> .   |
| <b>NetAgingTimeout</b>      | The timeout period, in seconds, for aging out dynamically learned forwarding information from NET side port. This is used only for full bridge configuration. The recommended value of net aging timeout should be greater than that of dot1dTpAgingTimeOut.   |
| <b>Full Bridging Status</b> | This specifies the current state of full bridging on the bridge. Thebridge can be set to residential bridging, restricted full bridging or unrestricted full bridging. In residential bridging, all packets from a CPE side port are sent to Net side port without doing a lookup in the forwarding table. In restricted full bridging, there is a lookup and a packet coming from a CPE |



|                                |   |
|--------------------------------|---|
|                                | port destined for another CPE port is dropped. Hence, CPE-CPE switching is not permitted. In unrestricted full bridging, all traffic is forwarded based on lookup.  |
| <b>Drop If FDB full status</b> | This specifies if the frame for which learning could not be done because of forwarding table limit being reached, is to be dropped. If this is enabled the frame for which learning could not be done because of limit exceeded shall be dropped, else forwarded based on bridge forwarding logic. This being enabled shall reduce flooding, as when a response to such a frame from which learning could not be done shall come the frame shall be flooded, as the entry for that unicast address, shall not be found in forwarding table. |
| <b>ResidentialNetLearning</b>  | This specifies if learning can be done over net side port for residential bridging. Learning shall be done on Net port in case of vlan with residential bridging if 'dot1dPortGsLearningStatus' and 'dot1dTpGsResidentialNetLearning' is enabled. In case of vlan with 'unrestricted' or 'restricted' bridging the learning is governed only by per port configuration i.e. 'dot1dBasePortTable'. <b>Currently the modification of this parameter is not supported.</b>   |
| <b>Reserved Mac Profile Id</b> | The Profile is used to determine the behavior for Reserved Mac destined frames on the bridge. Reserved Mac addresses are the multicast addresses defined as reserved in IEEE 802.1Q and IEEE 802.1ad. If it does not contain any valid value then the behavior for Reserved Mac destined frames is determined based on Resvd Mac profile associated with the VLAN in which the frame belongs to. VLAN here means the 802.1q Vlan in case of Native Vlan mode and Virtual Vlan in case of Stacked Vlan Mode.                                 |

### References:

- Bridge Port commands
- Bridge Port stats commands
- Ethernet commands

## 5.7 Bridge Multicast Commands

---

### 5.7.1 Bridge mcast forwarding Commands

#### 5.7.1.1 Get bridge mcast forwarding

**Description:**

Use this command to get.

**Command Syntax:**

**get bridge mcast fwdall [vlanid <vlanid-val>]**

#### 5.7.1.2 Modify bridge mcast fwdall

**Description:**

Use this command to modify.

**Command Syntax:**

**modify bridge mcast fwdall [vlanid <vlanid-val>] [egressports <egressports-val> | none] [forbidegressports <forbidegressports-val> | none]**

**Parameters:**

| Name   | Description   |
|--|---|
| <b>vlanid</b> <vlanid-val>                     | The VLAN id for this VLAN. In devices supporting "Shared Vlan for multicast" capability, the information for a multicast MAC address is shared across vlans. Hence vlan id is an optional parameter. In devices supporting "Independent Vlan for multicast" capability, each vlan can have its own information for a multicast MAC address. Hence vlanid is a mandatory parameter in all the commands other than - get. For No Vlan case, vlan id is not required. VLAN here means the 802.1q Vlan in case of Native Vlan mode and Virtual Vlan in case of Stacked Vlan Mode.<br><b>Type:</b> Get — Optional<br><b>Valid values:</b> 0 - 4095 |
| <b>egressports</b><br><egressports-val>   none | The set of ports, configured by management in this VLAN, to which all multicast group-addressed frames are to be forwarded. More than one value can be given, separated by spaces.<br><b>Type:</b> Modify -- Optional<br><b>Valid values:</b> 0   |
| <b>forbidegressports</b>                       | The set of ports configured by management in this VLAN, for   |

|                                   |   |
|-----------------------------------|---|
| <forbidegressports-val>  <br>none | which the Service Requirement attributes Forward All Multicast Groups, may not be dynamically registered by GMRP. More than one value can be given, separated by spaces.<br><b>Type:</b> Modify -- Optional<br><b>Valid values:</b> 0 |
|-----------------------------------|---|

**Example:**

```
$ get bridge mcast fwdall vlanid 1
```

**Output:**

```
VLAN Index                : 1
Forward All Ports         : 34
Forward All Static Ports  : 1 2 3 5
Forward All Forbidden Ports : 4 9 10 11
```

**Output Fields:**

| Field                              | Description   |
|------------------------------------|---|
| <b>Vlan Index</b>                  | The VLAN id for this VLAN. In devices supporting "Shared Vlan for multicast" capability, the information for a multicast MAC address is shared across vlans. Hence vlan id is an optional parameter. In devices supporting "Independent Vlan for multicast" capability, each vlan can have its own information for a multicast MAC address. Hence vlanid is a mandatory parameter in all the commands other than - get. For No Vlan case, vlan id is not required. VLAN here means the 802.1q Vlan in case of Native Vlan mode and Virtual Vlan in case of Stacked Vlan Mode. |
| <b>Forward All Ports</b>           | The complete set of ports in this VLAN, to which all multicast group-addressed frames are to be forwarded. This includes ports for which this need has been determined dynamically by GMRP, or configured statically by management.   |
| <b>Forward All Static Ports</b>    | The set of ports, configured by management in this VLAN, to which all multicast group-addressed frames are to be forwarded. More than one value can be given, separated by spaces.  |
| <b>Forward All Forbidden Ports</b> | The set of ports configured by management in this VLAN, for which the Service Requirement attribute Forward All Multicast Groups, may not be dynamically registered by GMRP. More than one value can be given, separated by spaces.   |

**Cautions:**

- An entry in this table shall not be applicable for a bridge port created over PPPOE/IPOE interface.

**References:**

- bridge static multicast

**5.7.2 Bridge mcast forwarding Commands****5.7.2.1 Get bridge mcast forwarding****Description:**

Use this command to get.

**Command Syntax:**

**get bridge mcast forwarding [vlanid <vlanid-val>] [macaddr <macaddr-val>]**

**Parameters:**

| Name                            | Description   |
|---------------------------------|---|
| <b>vlanid</b> <vlanid-val>      | <p>The VLAN id for this VLAN. In devices supporting "Shared Vlan for multicast" capability, the information for a multicast MAC address is shared across VLANS. Hence, vlanid is not required and is passed as zero. In devices supporting "Independent Vlan for multicast" capability. Each vlan can have its own information for a multicast MAC address. Hence, VLAN id is a mandatory parameter and a valid value of vlanid must be passed. For No Vlan case VLAN id is not required. When Vlan transparency feature is supported, the valid range for vlanid also includes 4097. In case of "Shared Vlan Multicast also there shall always be a seperate entry for 4097 if the VLAN with that VLAN Id is created. VLAN here means the 802.1q Vlan in case of Native Vlan mode and Virtual Vlan in case of Stacked Vlan Mode.</p> <p><b>Type:</b> Modify — Optional<br/>Get — Optional</p> <p><b>Valid values:</b> 0 - 4095</p> |
| <b>macaddr</b><br><macaddr-val> | <p>The destination Group MAC address in a frame, to which this entry's filtering information applies</p> <p><b>Type:</b> Get -- Optional</p>  |

**Example:**

```
$ get bridge mcast forwarding vlanid 1 macaddr 00:30:4F:00:08:01
```

**Output:**

```
Vlan Index      : 1                Mac Address : 00:30:4F:00:08:01
Egress ports   : 1 2
Group Learnt   : 1
```

**Output Fields:**

| Field               | Description  |
|---------------------|--|
| <b>VLAN Index</b>   | The VLAN id for this VLAN. In devices supporting "Shared Vlan for multicast" capability, the information for a multicast MAC address is shared across VLANS. Hence, vlanid is not required and is passed as zero. In devices supporting "Independent Vlan for multicast" capability. Each vlan can have its own information for a multicast MAC address. Hence, VLAN id is a mandatory parameter and a valid value of vlanid must be passed. For No Vlan case VLAN id is not required. When Vlan transparency feature is supported, the valid range for vlanid also includes 4097. In case of "Shared Vlan Multicast also there shall always be a separate entry for 4097 if the VLAN with that VLAN Id is created. VLAN here means the 802.1q Vlan in case of Native Vlan mode and Virtual Vlan in case of Stacked Vlan Mode. |
| <b>Mac Address</b>  | The destination Group MAC address in a frame, to which this entry's filtering information applies  |
| <b>Egress ports</b> | The complete set of bridge ports, in this VLAN, to which frames destined for this Group MAC address are currently being explicitly forwarded. This does not include ports for which this address is only implicitly forwarded, in the dot1qForwardAllPorts list.   |
| <b>Group Learnt</b> | The subset of bridge ports in EgressPorts, which were learned by GMRP or some other dynamic mechanism, in this Filtering database.   |

**References:**

- bridge static multicast

## 5.7.3 Bridge mcast fwdunreg Commands

### 5.7.3.1 Get bridge mcast fwdunreg

**Description:**

Use this command to get.

**Command Syntax:**

**get bridge mcast fwdunreg [vlanid <vlanid-val>]**

### 5.7.3.2 Modify bridge mcast fwdunreg

**Description Syntax:**

Use this command to modify.

**Command Syntax:**

**modify bridge mcast fwdunreg [vlanid <vlanid-val>] [egressports <egressports-val> | none] [forbidegressports <forbidegressports-val> | none]**

**Parameters:**

| Name   | Description   |
|--|---|
| <b>vlanid</b> <vlanid-val>                     | The VLAN id for this VLAN. In devices supporting "Shared Vlan for multicast" capability, the information for a multicast MAC address is shared across VLANS. Hence, vlanid is not required and is passed as zero. In devices supporting "Independent Vlan for multicast" capability. Each vlan can have its own information for a multicast MAC address. Hence, VLAN id is a mandatory parameter and a valid value of vlanid must be passed. For No Vlan case VLAN id is not required. When Vlan transparency feature is supported, the valid range for vlanid also includes 4097. In case of "Shared Vlan Multicast also there shall always be a seperate entry for 4097 if the VLAN with that VLAN Id is created. VLAN here means the 802.1q Vlan in case of Native Vlan mode and Virtual Vlan in case of Stacked Vlan Mode.<br><b>Type:</b> Modify — Optional<br>Get — Optional<br><b>Valid values:</b> 0 - 4095 |
| <b>egressports</b><br><egressports-val>   none | The set of ports, configured by management, in this VLAN, to which multicast group-addressed frames for which there is no more specific forwarding information, are to be forwarded. More than one value can be given, separated by spaces.   |

|   |   |
|---|---|
|   | <b>Type:</b> Modify — Optional<br><b>Valid values:</b> 0  |
| <b>forbidegressports</b><br><forbidegressports-val>  <br>none | The set of ports, configured by management in this VLAN, for which the Service Requirement attribute Forward Unregistered Multicast Groups, may not be dynamically registered by GMRP. More than one value can be given, separated by spaces.<br><b>Type:</b> Modify — Optional<br><b>Valid values:</b> 0 |

**Example:**

```
$ get bridge mcast fwdunreg vlanid 1
```

**Output:**

```
VLAN Index : 1
Forward Unregistered Ports : 45
Forward Unregistered Static Ports : 1 2 3 6
Forward Unregistered Forbidden Ports : 4 9 10
```

**Output Fields:**

| Field                                    | Description  |
|--|--|
| <b>VLAN Index</b>                        | The VLAN id for this VLAN. In devices supporting "Shared Vlan for multicast" capability, the information for a multicast MAC address is shared across VLANs. Hence, vlanid is not required and is passed as zero. In devices supporting "Independent Vlan for multicast" capability. Each vlan can have its own information for a multicast MAC address. Hence, VLAN id is a mandatory parameter and a valid value of vlanid must be passed. For No Vlan case VLAN id is not required. When Vlan transparency feature is supported, the valid range for vlanid also includes 4097. In case of "Shared Vlan Multicast also there shall always be a separate entry for 4097 if the VLAN with that VLAN Id is created. VLAN here means the 802.1q Vlan in case of Native Vlan mode and Virtual Vlan in case of Stacked Vlan Mode. |
| <b>Forward Unregistered Ports</b>        | The complete set of ports in this VLAN, to which multicast group-addressed frames for which there is no more specific forwarding information, will be forwarded. This includes ports, for which this need has been determined dynamically by GMRP, or configured statically by management.   |
| <b>Forward Unregistered Static Ports</b> | The set of ports, configured by management, in this VLAN, to which multicast group-addressed frames for which there is no more specific forwarding information, are to be forwarded. More than one value can   |

|   |   |
|---|---|
|   | be given, separated by spaces.  |
| <b>Forward Unregistered Forbidden Ports</b> | The set of ports, configured by management in this VLAN, for which the Service Requirement attribute Forward Unregistered Multicast Groups, may not be dynamically registered by GMRP. More than one value can be given, separated by spaces. |

**Cautions:**

- An entry in this table shall not be applicable for a bridge port created over PPPOE/IPOE interface.

**References:**

- Bridge commands.

## 5.7.4 Bridge Static Multicast Commands

### 5.7.4.1 Create bridge static mcast

**Description:**

Use this command is used to create.

**Command Syntax:**

**create bridge static mcast** [**vlanid** <vlanid-val>] **mcastaddr** <mcastaddr-val> [**egressports** <egressports-val>] [**forbidegressports** <forbidegressports-val>]

### 5.7.4.2 Delete bridge static mcast

**Description:**

Use this command is used to delete.

**Command Syntax:**

**delete bridge static mcast** [**vlanid** <vlanid-val>] **mcastaddr** <mcastaddr-val>

### 5.7.4.3 Get bridge static mcast

**Description:**

Use this command is used to get.

**Command Syntax:**

**get bridge static mcast** [**vlanid** <vlanid-val>] [**mcastaddr** <mcastaddr-val>]



## 5.7.4.4 Modify bridge static mcast

### Description:

Use this command is used to modify

### Command Syntax:

```
modify bridge static mcast [vlanid <vlanid-val>] mcastaddr <mcastaddr-val>
[egressports <egressports-val>] [forbidegressports <forbidegressports-val>]
```

### Parameters:

| Name   | Description   |
|--|---|
| <b>Vlanid</b> <vlanid-val>                   | <p>The VLAN ID for this VLAN. In devices supporting "Shared Vlan for multicast" capability, the information for a multicast MAC address is shared across VLANs. Hence vlan id is an optional parameter. In devices supporting "Independent Vlan for multicast" capability, each vlan can have its own information for a multicast MAC address. Hence vlanid is a mandatory parameter in all the commands other than - get. For No Vlan case, vlan id is not required. This feature is not supported for VLAN with vlanid as 4097.</p> <p><b>Type:</b> Optional for all commands</p> <p><b>Valid values:</b> 0 - 4095</p> <p><b>Default value:</b></p> |
| <b>mcastaddr</b><br><mcastaddr-val>          | <p>The destination multicast MAC address in a frame, to which this entry's filtering information applies. Bit <b>0</b> of the first octet of the MAC address indicates a group (multicast) MAC address, if the bit is SET. For example, 01:00:00:00:00:00,03:FF:FF:FF:FF.</p> <p>Addresses in the range 01:80:C2:00:00:00 -01:80:C2:00:00:0f and 01:80:C2:00:00:20 -01:80:C2:00:00:2f have been blocked as value of this index, as these are reserved GARP addresses.</p> <p><b>Type</b> : Create — Mandatory<br/>Modify — Mandatory<br/>Delete — Mandatory<br/>Get — Optional</p> <p><b>Default value:</b></p>                                       |
| <b>egressports</b><br><egressports-val> none | <p>The set of ports, to which frames received from a specific port and destined for a specific Multicast MAC address must be forwarded. A port may not be added in this set, if it is already a member of the set of ports in <b>ForbidEgressPorts</b>. More than one value can be given, separated by spaces.</p> <p><b>Type</b> :Optional for all commands</p>  |

|   |   |
|---|---|
|   | <p><b>Valid values:</b> 1 – 386</p> <p><b>Default value:</b> none</p>   |
| <p><b>forbidegressports</b></p> <p>&lt;forbidegressports-val&gt;</p> <p> none</p> | <p>The set of ports, to which frames received from a specific port and destined for a specific Multicast MAC address must not be forwarded, regardless of any dynamic information. A port may not be added in this set if it is already a member of the set of ports in <b>EgressPorts</b>. <b>Type</b> :Optional for all commands</p> <p><b>Valid values</b> : 1 – 386</p> <p><b>Default value:</b> none</p> |

**Example:**

```
$ create bridge static mcast vlanid 7 mcastaddr 00:30:4F:00:00:01 egressports 10
forbidegressports 20
```

**Output:**

Verbose Mode On:

Entry Created

Vlan Index : 7 Mcast Address : 00:30:4F:00:00:01

Egress ports : 10

Forbidden Egress ports : 20

Verbose Mode Off:

Entry Created

**Output Fields:**

| Field                | Description   |
|----------------------|---|
| <b>Vlan Index</b>    | The VLAN ID for this VLAN. In devices supporting "Shared Vlan for multicast" capability, the information for a multicast MAC address is shared across vlans. Hence vlan id is an optional parameter. In devices supporting "Independent Vlan for multicast" capability, each vlan can have its own information for a multicast MAC address. Hence vlanid is a mandatory parameter in all the commands other than - get. For No Vlan case, vlan id is not required. This feature is not supported for VLAN with vlanid as 4097 |
| <b>Mcast Address</b> | The destination multicast MAC address in a frame, to which the filtering information of this entry applies.   |
| <b>Egress ports</b>  | The set of ports, to which frames received from a specific port and destined for a specific Multicast MAC address must be forwarded. A port may not be added in this set if it is already a member of the set of ports in ForbiddenEgressPorts.   |

|                               |   |
|-------------------------------|---|
| <b>Forbidden Egress ports</b> | The set of ports, to which frames received from a specific port and destined for a specific Multicast MAC address must not be forwarded, regardless of any dynamic information. A port may not be added in this set if it is already a member of the set of ports in EgressPorts. |
|-------------------------------|---|

**Cautions:**

- An entry in this table shall not be applicable for a bridge port created over PPPOE/IPOE interface.

**References:**

- Bridge commands.

## 5.8 DHCP Commands

---

### 5.8.1 DHCP Client Commands

#### 5.8.1.1 Get dhcp client info

**Description:**

Use this command to get DHCP client information for clients, on the specified interface, or for all the interfaces.

**Command Syntax:**

**get dhcp client info [ifname <interface-name>]**

**Parameters:**

| Name                               | Description   |
|------------------------------------|---|
| <b>Ifname</b><br><interface-namef> | This specifies the interface name on which DHCP is running. If this is not specified, then information for clients on all such interfaces will be displayed.<br><b>Type</b> : Optional<br><b>Valid values</b> : eth-*, aggr-* |

**Mode:**

Super-User, User

**Example:**

```
$get dhcp client info ifname eth-0
```

**Output:**

```
If-name      Server      Status      Lease Start Date  Lease Time (sec)
-----
eth-0        1.1.1.1     Bound       Thu Jan 01 00:00:38 1970 500
```

**Output Fields:**

| FIELD          | Description  |
|----------------|--|
| <b>If-Name</b> | This is an interface on which DHCP is running: It can be :<br><i>eth-*, aggr-*</i>                                       |
| <b>Server</b>  | This specifies the address of the DHCP server with whom the client has obtained the IP address and other configurations. |
| <b>Status</b>  | This specifies the current state of the client. It may be: <i>Init,</i>  |

|                         |   |
|-------------------------|---|
|                         | <i>Selecting, Bound, Requesting, Renew or Bind.</i>   |
| <b>Lease Start Date</b> | This signifies the date on which the DHCP server leased out the IP address to the client.   |
| <b>Lease Time</b>       | This specifies the time period, (in seconds), for which an IP address was leased out by the server.<br><br>The client is expected to renew the lease before the expiry of this timer or release the IP Address. |

**References:**

- dhcp client stats related commands

**5.8.1.2 Get dhcp client stats**

**Description:**

Use this command to get DHCP client statistics on an interface on which the DHCP client is running, or on all such interfaces.

**Command Syntax:**

**get dhcp client stats [ifname <interface-name>]**

**Parameters:**

| FIELD                          | Description   |
|--------------------------------|---|
| <b>Ifname</b> <interface-name> | This specifies the interface name on which DHCP is running. If this is not specified then information for clients on all such interfaces will be displayed.<br><br><b>Type:</b> Optional<br><b>Valid values :</b> <i>eth-0- *</i> |

**Mode:**

Super-User, User

**Example:**

\$get dhcp client stats ifname eth-0

**Output:**

```
If-name           : eth-0
Msgs Sent         : 4
Decline Sent      : 0
Discover Msgs Sent : 4
Req Sent          : 0
Msgs Rcvd         : 0
Offer Msgs Rcvd  : 0
Acks Rcvd        : 0
```

Rel Sent : 0 Nacks Rcvd : 0  
Inform Sent : 0 Invalid Rcvd : 0

### Output Fields:

| FIELD              | Description  |
|--------------------|--|
| If-Name            | This is an interface on which DHCP is running: It can be : <i>eth-0</i>    |
| Msgs Sent          | This specifies number of DHCP messages received sent on this interface.    |
| Msgs Rcvd          | This specifies number of DHCP messages sent received on this interface.    |
| Decline Sent       | This specifies number of DHCP decline messages sent on this interface.     |
| Offer Msgs Rcvd    | This specifies number of DHCP offer messages received on this interface.   |
| Discover Msgs Sent | This specifies number of DHCP discover messages sent on this interface.    |
| Req Sent           | This specifies number of DHCP request messages sent on this interface.     |
| Acks Rcvd          | This specifies number of DHCP acks received on this interface.             |
| Rel Sent           | This specifies number of DHCP release messages sent on this interface.     |
| Nacks Rcvd         | This specifies number of DHCP nacks received on this interface.            |
| Inform Sent        | This specifies number of DHCP inform messages sent on this interface.      |
| Invalid Rcvd       | This specifies number of invalid dhcp messages received on this interface. |

### References:

- dhcp client info related commands

## 5.9 DSL Commands

---

### 5.9.1 ADSL Alarm Profile Commands

#### 5.9.1.1 Get adsl alarm profile

**Description:**

Use this command to get.

**Command Syntax:**

**get adsl alarm profile** [ifname <interface-name>]

#### 5.9.1.2 Modify adsl alarm profile

**Description:**

Use this command to modify.

**Command Syntax:**

**modify adsl alarm profile ifname** <interface-name> [ **atucthresh15minlofs** <atucthresh15minlofs-val> ] [ **atucthresh15minloss** <atucthresh15minloss-val> ] [ **atucthresh15minlols** <atucthresh15minlols-val> ] [ **atucthresh15minlprs** <atucthresh15minlprs-val> ] [ **atucthresh15miness** <atucthresh15miness-val> ] [ **atucthreshfastrateup** <atucthreshfastrateup-val> ] [ **atucthreshintlrteup** <atucthreshintlrteup-val> ] [ **atucthreshfastratedn** <atucthreshfastratedn-val> ] [ **atucthreshintlratedn** <atucthreshintlratedn-val> ] [ **atucinitfailtrap** False | True ] [ **atucoptrapenable** False | True ] [ **aturthresh15minlofs** <aturthresh15minlofs-val> ] [ **aturthresh15minloss** <aturthresh15minloss-val> ] [ **aturthresh15minlprs** <aturthresh15minlprs-val> ] [ **aturthresh15miness** <aturthresh15miness-val> ] [ **aturthreshfastrateup** <aturthreshfastrateup-val> ] [ **aturthreshintlrteup** <aturthreshintlrteup-val> ] [ **aturthreshfastratedn** <aturthreshfastratedn-val> ] [ **aturthreshintlratedn** <aturthreshintlratedn-val> ] [ **atucgspmstatetrapenable** False | True ] [ **linealarmgscntrsreset** False | True ]

**Parameters:**

| Name   | Description   |
|--|---|
| <b>ifname</b> <fname-val>                            | The ADSL alarm interface name, whose profile is to be modified or viewed<br><b>Type:</b> Modify – Mandatory<br>Get – Optional |
| <b>atucthresh15minlofs</b> <atucthresh15minlofs-val> | The number of Loss of Frame Seconds encountered by an ADSL interface, within any given 15 minutes performance data collection |

|   |   |
|---|---|
|   | <p>period, which causes the SNMP agent to send an 'adslAtucPerfLofsThreshTrap'.</p> <p><b>Type:</b> Modify -- Optional</p> <p><b>Valid values:</b> 0 - 900</p>  |
| <p><b>atucthresh15minloss</b><br/>&lt;atucthresh15minloss-val&gt;</p>   | <p>The number of Loss of Signal Seconds encountered by an ADSL interface within any given 15 minute performance data collection period, which causes the SNMP agent to send an 'adslAtucPerfLossThreshTrap'.</p> <p><b>Type:</b> Modify -- Optional</p> <p><b>Valid values:</b> 0 - 900</p> |
| <p><b>atucthresh15minlols</b><br/>&lt;atucthresh15minlols-val&gt;</p>   | <p>The number of Loss of Link Seconds encountered by an ADSL interface within any given 15 minute performance data collection period, which causes the SNMP agent to send an 'adslAtucPerfLolsThreshTrap'.</p> <p><b>Type:</b> Modify -- Optional</p> <p><b>Valid values:</b> 0 - 900</p>   |
| <p><b>atucthresh15minlprs</b><br/>&lt;atucthresh15minlprs-val&gt;</p>   | <p>The number of Loss of Power Seconds encountered by an ADSL interface within any given 15 minute performance data collection period, which causes the SNMP agent to send an 'adslAtucPerfLprsThreshTrap'.</p> <p><b>Type:</b> Modify -- Optional</p> <p><b>Valid values:</b> 0 - 900</p>  |
| <p><b>atucthresh15miness</b><br/>&lt;atucthresh15miness-val&gt;</p>     | <p>The number of Errored Seconds encountered by an ADSL interface within any given 15 minute performance data collection period, which causes the SNMP agent to send an 'adslAtucPerfESsThreshTrap'.</p> <p><b>Type:</b> Modify -- Optional</p> <p><b>Valid values:</b> 0 - 900</p>         |
| <p><b>atucthreshfastrateup</b><br/>&lt;atucthreshfastrateup-val&gt;</p> | <p>Applies to 'Fast' channels only. Configured change in rate causing an adslAtucRateChangeTrap. A trap is produced when:<br/>ChanCurrTxRate &gt;= ChanPrevTxRate plus the value of this object.</p> <p><b>Type:</b> Modify -- Optional</p>   |
| <p><b>atucthreshintlrateup</b><br/>&lt;atucthreshintlrateup-val&gt;</p> | <p>Applies to 'Interleave' channels only. Configured change in rate causing an adslAtucRateChangeTrap. A trap is produced when:<br/>ChanCurrTxRate &gt;= ChanPrevTxRate plus the value of this object.</p> <p><b>Type:</b> Modify -- Optional</p>   |
| <p><b>atucthreshfastratedn</b><br/>&lt;atucthreshfastratedn-val&gt;</p> | <p>Applies to 'Fast' channels only. Configured change in rate causing an adslAtucRateChangeTrap. A trap is produced when:<br/>ChanCurrTxRate &lt;= ChanPrevTxRate minus the value of this object.</p>   |



|   |  |
|---|--|
|   | <b>Type:</b> Modify -- Optional  |
| <b>atucthreshintratedn</b><br><atucthreshintratedn-val>   | Applies to 'Interleave' channels only. Configured change in rate causing an adslAtucRateChangeTrap. A trap is produced when:<br>ChanCurrTxRate <= ChanPrevTxRate minus the value of this object.<br><b>Type:</b> Modify -- Optional  |
| <b>atucinitfailtrap</b> False   True                      | Enables and disables the InitFailureTrap. This object is defaulted disable.<br><b>Type:</b> Modify -- Optional<br><b>Valid values:</b> False, True   |
| <b>atucoptrapenable</b> False   True                      | Enables/disables the OpStateChangeTrap<br><b>Type:</b> Modify -- Optional<br><b>Valid values:</b> False, True  |
| <b>aturthresh15minlofs</b><br><aturthresh15minlofs-val>   | The number of Loss of Frame Seconds encountered by an ADSL interface within any given 15 minutes performance data collection period, which causes the SNMP agent to send an 'adslAturPerfLofsThreshTrap'<br><b>Type:</b> Modify -- Optional<br><b>Valid values:</b> 0 - 900  |
| <b>aturthresh15minloss</b><br><aturthresh15minloss-val>   | The number of Loss of Signal Seconds encountered by an ADSL interface within any given 15 minutes performance data collection period, which causes the SNMP agent to send an 'adslAturPerfLossThreshTrap'<br><b>Type:</b> Modify -- Optional<br><b>Valid values:</b> 0 - 900 |
| <b>aturthresh15minlprs</b><br><aturthresh15minlprs-val>   | The number of Loss of Power Seconds encountered by an ADSL interface within any given 15 minutes performance data collection period, which causes the SNMP agent to send an 'adslAturPerfLprsThreshTrap'<br><b>Type:</b> Modify -- Optional<br><b>Valid values:</b> 0 - 900  |
| <b>aturthresh15miness</b><br><aturthresh15miness-val>     | The number of Errored Seconds encountered by an ADSL interface within any given 15 minutes performance data collection period, which causes the SNMP agent to send an 'adslAturPerfESsThreshTrap'<br><b>Type:</b> Modify -- Optional<br><b>Valid values:</b> 0 - 900         |
| <b>aturthreshfastrateup</b><br><aturthreshfastrateup-val> | Applies to 'Fast' channels only. Configured change in rate causing an adslAturRateChangeTrap A trap is produced when:<br>ChanCurrTxRate > ChanPrevTxRate plus the value of this object.  |

|   |   |
|---|---|
|   | <b>Type:</b> Modify -- Optional   |
| <b>aturthreshintlrateup</b><br><aturthreshintlrateup-val> | Applies to 'Interleave' channels only. Configured change in rate causing an adslAturRateChangeTrap A trap is produced when:<br>ChanCurrTxRate > ChanPrevTxRate plus the value of this object.<br><b>Type:</b> Modify -- Optional  |
| <b>aturthreshfastratedn</b><br><aturthreshfastratedn-val> | Applies to 'Fast' channels only. Configured change in rate causing an adslAturRateChangeTrap A trap is produced when:<br>ChanCurrTxRate < ChanPrevTxRate minus the value of this object.<br><b>Type:</b> Modify -- Optional       |
| <b>aturthreshintlratedn</b><br><aturthreshintlratedn-val> | Applies to 'Interleave' channels only. Configured change in rate causing an adslAturRateChangeTrap A trap is produced when:<br>ChanCurrTxRate < ChanPrevTxRate minus the value of this object.<br><b>Type:</b> Modify -- Optional |
| <b>atucgspmstatetrappable</b><br>False   True             | This indicates change in power mangement state<br><b>Type:</b> Modify -- Optional<br><b>Valid values:</b> False, True   |
| <b>linealarmgscntrsreset</b> False<br>  True              | This parameter resets performance counters at runtime<br><b>Type:</b> Modify -- Optional<br><b>Valid values:</b> False, True  |

### Example:

```
$ get adsl alarm profile ifname dsl-0
```

### Output:

```
IfName : dsl-0
```

```
ADSL ATUC Configuration :
```

```
-----
```

```
Thresh 15Min Lofs(sec) : 10   Thresh 15Min Loss(sec) : 20
Thresh 15Min Lols(sec) : 30   Thresh 15Min Lprs(sec) : 50
Thresh 15Min Ess(sec) : 40   Thresh Fast Rate Up(bps): 70
Thresh Intl Rate Up(bps) : 30   Thresh Fast Rate Down(bps):10
Thresh Intl Rate Down(bps) : 30   Init Fail Trap : true
OpStateTrapEnable : false   PowerMgmtTrapEnable : True
```

```
ADSL ATUR Configuration :
```

```
-----
```

```
Thresh 15Min Lofs(sec) : 10
Thresh 15Min Loss(sec) : 10   Thresh 15Min Lprs(sec) : 10
Thresh 15Min Ess(sec) : 10   Thresh Fast Rate Up(bps: 10
Thresh Intl Rate Up(bps) : 10   Thresh Fast Rate Down(bps):10
Thresh Intl Rate Down(bps) : 10
```

## Output Fields:

| FIELD                             | Description  |
|-----------------------------------|--|
| <b>IfName</b>                     | The ADSL alarm interface name, whose profile is to be modified or viewed   |
| <b>Thresh 15Min Lofs(sec)</b>     | The number of Loss of Frame Seconds encountered by an ADSL interface, within any given 15 minutes performance data collection period, which causes the SNMP agent to send an 'adslAtucPerfLofsThreshTrap'. |
| <b>Thresh 15Min Loss(sec)</b>     | The number of Loss of Signal Seconds encountered by an ADSL interface within any given 15 minute performance data collection period, which causes the SNMP agent to send an 'adslAtucPerfLossThreshTrap'.  |
| <b>Thresh 15Min Lols(sec)</b>     | The number of Loss of Link Seconds encountered by an ADSL interface within any given 15 minute performance data collection period, which causes the SNMP agent to send an 'adslAtucPerfLolsThreshTrap'.    |
| <b>Thresh 15Min Lprs(sec)</b>     | The number of Loss of Power Seconds encountered by an ADSL interface within any given 15 minute performance data collection period, which causes the SNMP agent to send an 'adslAtucPerfLprsThreshTrap'.   |
| <b>Thresh 15Min Ess(sec)</b>      | The number of Errored Seconds encountered by an ADSL interface within any given 15 minute performance data collection period, which causes the SNMP agent to send an 'adslAtucPerfESsThreshTrap'.          |
| <b>Thresh Fast Rate Up(bps)</b>   | Applies to 'Fast' channels only. Configured change in rate causing an adslAtucRateChangeTrap. A trap is produced when: ChanCurrTxRate >= ChanPrevTxRate plus the value of this object.                     |
| <b>Thresh Intl Rate Up(bps)</b>   | Applies to 'Interleave' channels only. Configured change in rate causing an adslAtucRateChangeTrap. A trap is produced when: ChanCurrTxRate >= ChanPrevTxRate plus the value of this object.               |
| <b>Thresh Fast Rate Down(bps)</b> | Applies to 'Fast' channels only. Configured change in rate causing an adslAtucRateChangeTrap. A trap is produced when: ChanCurrTxRate <= ChanPrevTxRate minus the value of this object.                    |
| <b>Thresh Intl Rate Down(bps)</b> | Applies to 'Interleave' channels only. Configured change in rate causing an adslAtucRateChangeTrap. A trap is produced when: ChanCurrTxRate <= ChanPrevTxRate minus the value of this object.              |

|                                   |   |
|-----------------------------------|---|
| <b>Init Fail Trap</b>             | Enables and disables the InitFailureTrap. This object is defaulted disable.   |
| <b>OpStateTrapEnable</b>          | Enables/disables the OpStateChangeTrap  |
| <b>PowerMgmtTrapEnable</b>        | This indicates change in power mangement state  |
| <b>Thresh 15Min Lofs(sec)</b>     | The number of Loss of Frame Seconds encountered by an ADSL interface within any given 15 minutes performance data collection period, which causes the SNMP agent to send an 'adslAturPerfLofsThreshTrap'  |
| <b>Thresh 15Min Loss(sec)</b>     | The number of Loss of Signal Seconds encountered by an ADSL interface within any given 15 minutes performance data collection period, which causes the SNMP agent to send an 'adslAturPerfLossThreshTrap' |
| <b>Thresh 15Min Lprs(sec)</b>     | The number of Loss of Power Seconds encountered by an ADSL interface within any given 15 minutes performance data collection period, which causes the SNMP agent to send an 'adslAturPerfLprsThreshTrap'  |
| <b>Thresh 15Min Ess(sec)</b>      | The number of Errored Seconds encountered by an ADSL interface within any given 15 minutes performance data collection period, which causes the SNMP agent to send an 'adslAturPerfESsThreshTrap'         |
| <b>Thresh Fast Rate Up(bps)</b>   | Applies to 'Fast' channels only. Configured change in rate causing an adslAturRateChangeTrap A trap is produced when: ChanCurrTxRate > ChanPrevTxRate plus the value of this object.                      |
| <b>Thresh Intl Rate Up(bps)</b>   | Applies to 'Interleave' channels only. Configured change in rate causing an adslAturRateChangeTrap A trap is produced when: ChanCurrTxRate > ChanPrevTxRate plus the value of this object.                |
| <b>Thresh Fast Rate Down(bps)</b> | Applies to 'Fast' channels only. Configured change in rate causing an adslAturRateChangeTrap A trap is produced when: ChanCurrTxRate < ChanPrevTxRate minus the value of this object.                     |
| <b>Thresh Intl Rate Down(bps)</b> | Applies to 'Interleave' channels only. Configured change in rate causing an adslAturRateChangeTrap A trap is produced when: ChanCurrTxRate < ChanPrevTxRate minus the value of this object.               |

## References:

- ADSL Commands

## 5.9.2 ADSL Alarm Profilext Commands

### 5.9.2.1 Get adsl alarm profilext

**Description:**

Use this command to get.

**Command Syntax:**

**get adsl alarm profilext** [ifname <interface-name>]

### 5.9.2.2 Modify adsl alarm profilext

**Description:**

Use this command to modify.

**Command Syntax:**

**modify adsl alarm profilext ifname** <interface-name> [ **atucthresh15minffstr** <atucthresh15minffstr-val> ] [ **atucthresh15minsese** <atucthresh15minsese-val> ] [ **atucthresh15minuas** <atucthresh15minuas-val> ] [ **atucthresh15minfecsl** <atucthresh15minfecsl-val> ] [ **atucthresh1daylofs** <atucthresh1daylofs-val> ] [ **atucthresh1dayloss** <atucthresh1dayloss-val> ] [ **atucthresh1daylols** <atucthresh1daylols-val> ] [ **atucthresh1daylprs** <atucthresh1daylprs-val> ] [ **atucthresh1dayess** <atucthresh1dayess-val> ] [ **atucthresh1daysese** <atucthresh1daysese-val> ] [ **atucthresh1dayuas** <atucthresh1dayuas-val> ] [ **atucthresh1dayfecsl** <atucthresh1dayfecsl-val> ] [ **aturthresh15minsese** <aturthresh15minsese-val> ] [ **aturthresh15minuas** <aturthresh15minuas-val> ] [ **aturthresh15minfecsl** <aturthresh15minfecsl-val> ] [ **aturthresh1daylofs** <aturthresh1daylofs-val> ] [ **aturthresh1dayloss** <aturthresh1dayloss-val> ] [ **aturthresh1daylprs** <aturthresh1daylprs-val> ] [ **aturthresh1dayess** <aturthresh1dayess-val> ] [ **aturthresh1daysese** <aturthresh1daysese-val> ] [ **aturthresh1dayuas** <aturthresh1dayuas-val> ] [ **aturthresh1dayfecsl** <aturthresh1dayfecsl-val> ]

**Parameters:**

| Name   | Description  |
|--|--|
| <b>ifname</b> <fname-val>                              | The ADSL alarm interface name, whose profile is to be modified or viewed<br><b>Type:</b> Modify – Mandatory<br>Get – Optional                  |
| <b>atucthresh15minffstr</b> <atucthresh15minffstr-val> | The number of failed retrains encountered by an ADSL interface within any giving 15 minute performance data collection period, which cause the |

|   |  |
|---|--|
|   | SNMP agent to send an adslAtucFailedFastRTrap.<br><b>Type:</b> Modify — Optional<br><b>Valid values:</b> 0 - 900   |
| <b>atucthresh15minsesl</b><br><atucthresh15minsesl-val>   | The number of Severe errored seconds encountered by an ADSL interface within any giving 15 minute performance data collection period, which cause the SNMP to send an adslAtucSesLTrap.<br><b>Type:</b> Modify — Optional<br><b>Valid values:</b> 0 - 900                      |
| <b>atucthresh15minuasl</b><br><atucthresh15minuasl-val>   | The number of unavailable errored seconds encountered by an ADSL interface within any giving 15 minutes performance data collection period, which cause the SNMP agent to send an adslAtucUasLThreshTrap<br><b>Type:</b> Modify — Optional<br><b>Valid values:</b> 0 - 900     |
| <b>atucthresh15minfecsl</b><br><atucthresh15minfecsl-val> | The number of Forward error correction seconds encountered by an ADSL interface within any giving 15 Minutes performance data collection period, which causes adslAtucPerfFecslThreshTrap.<br><b>Type:</b> Modify — Optional<br><b>Valid values:</b> 0 - 900                   |
| <b>atucthresh1daylofs</b><br><atucthresh1daylofs-val>     | The number of Loss of Frame Seconds encountered by an ADSL interface, within any given 1 day performance data collection period, which causes the SNMP agent to send an 'adslAtucPerfLofsThresh1DayTrap'.<br><b>Type:</b> Modify — Optional<br><b>Valid values:</b> 0 - 86400  |
| <b>atucthresh1dayloss</b><br><atucthresh1dayloss-val>     | The number of Loss of Signal Seconds encountered by an ADSL interface, within any given 1 day performance data collection period, which causes the SNMP agent to send an 'adslAtucPerfLossThresh1DayTrap'.<br><b>Type:</b> Modify — Optional<br><b>Valid values:</b> 0 - 86400 |
| <b>atucthresh1daylols</b><br><atucthresh1daylols-val>     | The number of Loss of Link Seconds encountered by an ADSL interface, within any given 1 day performance data collection period, which causes the SNMP agent to send an 'adslAtucPerfLolsThresh1DayTrap'.<br><b>Type:</b> Modify — Optional<br><b>Valid values:</b> 0 - 86400   |
| <b>atucthresh1daylprs</b><br><atucthresh1daylprs-val>     | The number of Loss of Power Seconds encountered by an ADSL interface, within any given 1 day performance data collection period, which causes the SNMP agent to send an 'adslAtucPerfLprsThresh1DayTrap'.<br><b>Type:</b> Modify — Optional                                    |

|   |  |
|---|--|
|   | <b>Valid values:</b> 0 - 86400   |
| <b>atucthresh1dayess</b><br><atucthresh1dayess-val>       | The number of Errored Seconds encountered by an ADSL interface, within any given 1 day performance data collection period, which causes the SNMP agent to send an 'adslAtucPerfESsThresh1DayTrap'.<br><b>Type:</b> Modify — Optional<br><b>Valid values:</b> 0 - 86400             |
| <b>atucthresh1daysesl</b><br><atucthresh1daysesl-val>     | The number of Severe errored Seconds encountered by an ADSL interface, within any given 1 day performance data collection period, which causes the SNMP agent to send an 'adslAtucPerfSesLThresh1DayTrap'.<br><b>Type:</b> Modify — Optional<br><b>Valid values:</b> 0 - 86400     |
| <b>atucthresh1dayuasl</b><br><atucthresh1dayuasl-val>     | The number of unavailable errored seconds encountered by an ADSL interface within any giving 1 day performance data collection period, which cause the SNMP agent to send an adslAtucPerfUasLThresh1DayTrap<br><b>Type:</b> Modify — Optional<br><b>Valid values:</b> 0 - 86400    |
| <b>atucthresh1dayfecsl</b><br><atucthresh1dayfecsl-val>   | The number of Forward error correction seconds encountered by an ADSL interface within any giving 1 day performance data collection period, which causes atucPerfFecslThresh1DayTrap.<br><b>Type:</b> Modify — Optional<br><b>Valid values:</b> 0 - 86400                          |
| <b>aturthresh15minsesl</b><br><aturthresh15minsesl>       | The number of Severe errored seconds encountered by an ADSL interface within any giving 15 minute performance data collection period, which cause the SNMP to send an adslAturPerfSesLThresh15MinTrap.<br><b>Type:</b> Modify — Optional<br><b>Valid values:</b> 0 - 900           |
| <b>aturthresh15minuasl</b><br><aturthresh15minuasl>       | The number of unavailable errored seconds encountered by an ADSL interface within any giving 15 Minutes performance data collection period, which cause the SNMP agent to send an adslAturPerfUasLThresh1DayTrap<br><b>Type:</b> Modify — Optional<br><b>Valid values:</b> 0 - 900 |
| <b>aturthresh15minfecsl</b><br><aturthresh15minfecsl-val> | The number of Forward error correction seconds encountered by an ADSL interface within any giving 15 Minutes performance data collection period, which causes adslAturPerfFecslThreshTrap.<br><b>Type:</b> Modify — Optional<br><b>Valid values:</b> 0 - 900                       |
| <b>aturthresh1daylofs</b>                                 | The number of Loss of Frame Seconds encountered by an ADSL   |

|  |  |
|--|--|
| <p>&lt;aturthresh1daylofs-val&gt;</p>                                    | <p>interface, within any given 1 day performance data collection period, which causes the SNMP agent to send an 'adslAturPerfLofsThresh1DayTrap'.</p> <p><b>Type:</b> Modify — Optional</p> <p><b>Valid values:</b> 0 - 86400</p>  |
| <p><b>aturthresh1dayloss</b></p> <p>&lt;aturthresh1dayloss-val&gt;</p>   | <p>The number of Loss of Signal Seconds encountered by an ADSL interface, within any given 1 day performance data collection period, which causes the SNMP agent to send an 'adslAturPerfLossThresh1DayTrap'.</p> <p><b>Type:</b> Modify — Optional</p> <p><b>Valid values:</b> 0 - 86400</p>  |
| <p><b>aturthresh1daylprs</b></p> <p>&lt;aturthresh1daylprs-val&gt;</p>   | <p>The number of Loss of Power Seconds encountered by an ADSL interface, within any given 1 day performance data collection period, which causes the SNMP agent to send an 'adslAturPerfLprsThresh1DayTrap'.</p> <p><b>Type:</b> Modify — Optional</p> <p><b>Valid values:</b> 0 - 86400</p>   |
| <p><b>aturthresh1dayess</b></p> <p>&lt;aturthresh1dayess-val&gt;</p>     | <p>The number of Errored Seconds encountered by an ADSL interface, within any given 1 day performance data collection period, which causes the SNMP agent to send an 'adslAturPerfESsThresh1DayTrap'.</p> <p><b>Type:</b> Modify — Optional</p> <p><b>Valid values:</b> 0 - 86400</p>          |
| <p><b>aturthresh1daysesl</b></p> <p>&lt;aturthresh1daysesl-val&gt;</p>   | <p>The number of Severe errored Seconds encountered by an ADSL interface, within any given 1 day performance data collection period, which causes the SNMP agent to send an 'adslAturPerfSesLThresh1DayTrap'.</p> <p><b>Type:</b> Modify — Optional</p> <p><b>Valid values:</b> 0 - 86400</p>  |
| <p><b>aturthresh1dayuasl</b></p> <p>&lt;aturthresh1dayuasl-val&gt;</p>   | <p>The number of unavailable errored seconds encountered by an ADSL interface within any giving 1 day performance data collection period, which cause the SNMP agent to send an adslAturPerfUasLThresh1DayTrap</p> <p><b>Type:</b> Modify — Optional</p> <p><b>Valid values:</b> 0 - 86400</p> |
| <p><b>aturthresh1dayfecsl</b></p> <p>&lt;aturthresh1dayfecsl-val&gt;</p> | <p>The number of Forward error correction seconds encountered by an ADSL interface within any given 1 day performance data collection period, which causes aturPerfFecslThresh1DayTrap.</p> <p><b>Type:</b> Modify — Optional</p> <p><b>Valid values:</b> 0 - 86400</p>                        |



**Example:**

```
$ get adsl alarm profilext ifname dsl-0
```

**Output:**

```
IfName : dsl-0
Atuc Thresh 15Min Fail FastR(sec) : 10
Atuc Thresh 15Min SesL(sec) : 14
Atuc Thresh 15Min UasL(sec) : 10
Atuc Thresh 15Min FecsL(sec) : 10
Atuc Thresh 1 Day Lofs(sec) : 10
Atuc Thresh 1 Day Loss(sec) : 10
Atuc Thresh 1 Day Lols(sec) : 10
Atuc Thresh 1 Day Lprs(sec) : 10
Atuc Thresh 1 Day ESs(sec) : 10
Atuc Thresh 1 Day SesL(sec) : 10
Atuc Thresh 1 Day UasL(sec) : 10
Atuc Thresh 1 Day FecsL(sec) : 10
Atur Thresh 15Min Sesi(sec) : 10
Atur Thresh 15Min UasL(sec) : 10
Atur Thresh 15Min FecsL(sec) : 10
Atur Thresh 1 Day Lofs(sec) : 10
Atur Thresh 1 Day Loss(sec) : 10
Atur Thresh 1 Day Lprs(sec) : 10
Atur Thresh 1 Day ESs(sec) : 10
Atur Thresh 1 Day SesL(sec) : 10
Atur Thresh 1 Day UasL(sec) : 10
Atur Thresh 1 Day FecsL(sec) : 10
```

**Output Fields:**

| FIELD                                    | Description   |
|--|---|
| <b>IfName</b>                            | The ADSL alarm interface name, whose profile is to be modified or viewed  |
| <b>Atuc Thresh 15Min Fail FastR(sec)</b> | The number of failed retrains encountered by an ADSL interface within any given 15 minute performance data collection period, which causes adslAtucFailedFastRTrap. |
| <b>Atuc Thresh 15Min SesL(sec)</b>       | The number of Severe errored seconds encountered by an ADSL interface within any given 15 minute performance data collection period, which causes adslAtucSesLTrap. |
| <b>Atuc Thresh 15Min UasL(sec)</b>       | The number of unavailable errored seconds encountered by an ADSL interface within any given 15 Minute   |

|                                     |   |
|-------------------------------------|---|
|                                     | performance data collection period, which causes<br>adslAtucUasLThreshTrap.   |
| <b>Atuc Thresh 15Min FecsL(sec)</b> | The number of Forward error correction seconds encountered by an ADSL interface within any given 15 Minute performance data collection period, which causes<br>adslAtucPerfFecsLThreshTrap. |
| <b>Atuc Thresh 1 Day Lofs(sec)</b>  | The number of Loss of Frame Seconds encountered by an ADSL interface, within any given 1 day performance data collection period, which causes<br>adslAtucPerfLofsThresh1DayTrap.            |
| <b>Atuc Thresh 1 Day Loss(sec)</b>  | The number of Loss of Signal Seconds encountered by an ADSL interface, within any given 1 day performance data collection period, which causes<br>adslAtucPerfLossThresh1DayTrap.           |
| <b>Atuc Thresh 1 Day Lols(sec)</b>  | The number of Loss of Link Seconds encountered by an ADSL interface, within any given 1 day performance data collection period, which causes<br>adslAtucPerfLolsThresh1DayTrap.             |
| <b>Atuc Thresh 1 Day Lprs(sec)</b>  | The number of Loss of Power Seconds encountered by an ADSL interface, within any given 1 day performance data collection period, which causes<br>adslAtucPerfLprsThresh1DayTrap.            |
| <b>Atuc Thresh 1 Day SesL(sec)</b>  | The number of Severe errored Seconds encountered by an ADSL interface, within any given 1 day performance data collection period, which causes<br>adslAtucPerfSesLThresh1DayTrap.           |
| <b>Atuc Thresh 1 Day UasL(sec)</b>  | The number of unavailable errored seconds encountered by an ADSL interface within any given 1 day performance data collection period, which causes<br>adslAtucPerfUasLThresh1DayTrap.       |
| <b>Atuc Thresh 1 Day FecsL(sec)</b> | The number of Forward error correction seconds encountered by an ADSL interface within any given 1 day performance data collection period, which causes<br>atucPerfFecsLThresh1DayTrap.     |
| <b>Atur Thresh 15Min Sesl(sec)</b>  | The number of Severe errored seconds encountered by an ADSL interface within any given 15 minute performance data collection period, which causes<br>adslAturPerfSesLThresh15MinTrap.       |
| <b>Atur Thresh 15Min UasL(sec)</b>  | The number of unavailable errored seconds encountered by an ADSL interface within any given 15 Minute   |

|                                     |   |
|-------------------------------------|---|
|                                     | performance data collection period, which causes<br>adslAturPerfUasLThresh1DayTrap.   |
| <b>Atur Thresh 15Min Fecsl(sec)</b> | The number of Forward error correction seconds encountered by an ADSL interface within any given 15 Minute performance data collection period, which causes<br>adslAturPerfFecslThreshTrap. |
| <b>Atur Thresh 1 Day Lofs(sec)</b>  | The number of Loss of Frame Seconds encountered by an ADSL interface, within any given 1 day performance data collection period, which causes<br>adslAturPerfLofsThresh1DayTrap.            |
| <b>Atur Thresh 1 Day Loss(sec)</b>  | The number of Loss of Signal Seconds encountered by an ADSL interface, within any given 1 day performance data collection period, which causes<br>adslAturPerfLossThresh1DayTrap.           |
| <b>Atur Thresh 1 Day Lprs(sec)</b>  | The number of Loss of Power Seconds encountered by an ADSL interface, within any given 1 day performance data collection period, which causes<br>adslAturPerfLprsThresh1DayTrap.            |
| <b>Atur Thresh 1 Day ESs(sec)</b>   | The number of Errored Seconds encountered by an ADSL interface, within any given 1 day performance data collection period, which causes<br>adslAturPerfESsThresh1DayTrap.                   |
| <b>Atur Thresh 1 Day SesL(sec)</b>  | The number of Severe errored Seconds encountered by an ADSL interface, within any given 1 day performance data collection period, which causes<br>adslAturPerfSesLThresh1DayTrap.           |
| <b>Atur Thresh 1 Day UasL(sec)</b>  | The number of unavailable errored seconds encountered by an ADSL interface within any given 1 day performance data collection period, which causes<br>adslAturPerfUasLThresh1DayTrap.       |
| <b>Atur Thresh 1 Day Fecsl(sec)</b> | The number of Forward error correction seconds encountered by an ADSL interface within any given 1 day performance data collection period, which causes<br>aturPerfFecslThresh1DayTrap.     |

## References:

- ADSL Commands

## 5.9.3 ADSL ATUC Channel Commands

### 5.9.3.1 Get adsl atuc channel

#### Description:

Use this command to get.

#### Command Syntax:

```
get adsl atuc channel [ifname <interface-name>]
```

#### Parameters:

| Name                      | Description   |
|---------------------------|---|
| <b>ifname</b> <fname-val> | The ADSL ATUC channel interface name.<br><b>Type:</b> Get – Optional<br><b>Valid values:</b> dsli-0 - dsli-23 |

#### Example:

```
$ get adsl atuc channel ifname dsli-0
```

#### Output:

```
Ifname : dsli-0
Interleave Delay(ms) : 20          Curr Tx Rate(bps) : 80
Prev Tx Rate(bps) : 40          Crc Block Length(byte) : 90
Gs Curr Atm Status : NoAtmDefect GsSymbolsPerRsWord : 10
GsRsDepth : 20          GsRedundantBytesPerRsCode: 100
AtucChanPerfAtmCD : 10          AtucChanPerfAtmCU : 10
AtucChanGsINPdn : 10          AtucChanGsL0dn : 10
AtucChanGsM0dn : 10          AtucChanGsT0dn : 10
AtucChanGsB0dn : 10
```

#### Output Fields:

| FIELD                         | Description  |
|-------------------------------|--|
| <b>Ifname</b>                 | The ADSL ATUC channel interface name.                                      |
| <b>Interleave Delay(ms)</b>   | Interleave delay for this channel.   |
| <b>Curr Tx Rate(bps)</b>      | Actual transmit rate on this channel.                                      |
| <b>Prev Tx Rate(bps)</b>      | The rate at the time of the last adslAtucRateChangeTrap event.             |
| <b>Crc Block Length(byte)</b> | Indicates the length of the channel data-block, on which the CRC operates. |
| <b>Gs Curr Atm Status</b>     | Indicates the current ATM Status.  |

|                                  |  |
|----------------------------------|--|
| <b>GsSymbolsPerRsWord</b>        | Indicates the number of DMT symbols per Reed-Solomon code word (S), in the downstream direction.   |
| <b>GsRsDepth</b>                 | Indicates interleaving depth (D), in the downstream direction.   |
| <b>GsRedundantBytesPerRsCode</b> | Indicates the number of redundant bytes (R), per Reed-Solomon code in the downstream direction.  |
| <b>AtucChanPerfAtmCD</b>         | Provides a count of the total number of cells passed through the cell delineation and HEC function process operating on the ATM Data Path while in the SYNC state.(length = 4 bytes).            |
| <b>AtucChanPerfAtmCU</b>         | Provides a count of the total number of cells in the ATM Data Path delivered at the logical interface between the ATU-C and a digital network element, such as one or more switching systems.    |
| <b>AtucChanGsINPdn</b>           | The actual number of Impulse Noise Protection(INP) symbols for the downstream interleaved channel. One symbol equals 250 $\mu$ s, so an INP of 1 correlates to a correction time of 250 $\mu$ s. |
| <b>AtucChanGsL0dn</b>            | The number of bits from the upstream latency path function #0 included per DMT symbol.(length = 4 bytes). It is not available for ADSL.  |
| <b>AtucChanGsM0dn</b>            | The number of Mux Data Frames per FEC Data Frame in upstream latency path function #0.(length = 4 bytes). It is not available for ADSL.  |
| <b>AtucChanGsT0dn</b>            | The ratio of the number of Mux Data Frames to the number of sync octets in the upstream latency path function #0.(length = 4 bytes). It is not available for ADSL.                               |
| <b>AtucChanGsB0dn</b>            | The nominal number of octets from frame bearer #0 per Mux Data Frame at Reference Point A in upstream latency path function #0.(length = 4 bytes). It is not available for ADSL.                 |

## 5.9.4 ADSL ATUC Chanperf Commands

### 5.9.4.1 Get adsl atuc chanperf

#### Description:

Use this command to get.

#### Command Syntax:

```
get adsl atuc chanperf [ifname <interface-name>]
```

#### Parameters:

| Name                      | Description   |
|---------------------------|---|
| <b>ifname</b> <fname-val> | The ADSL ATUC channel interface name, for which performance is to be viewed.<br><b>Type</b> : Get — Optional<br><b>Valid values</b> : <i>dsli-0 - *</i> , <i>dslf-0 - *</i> |

#### Example:

```
$ get adsl atuc chanperf ifname dsli-0
```

#### Output:

```
Ifname                      : dsli-0
Perf Valid Intervals        : 20
Perf Invalid Intervals     : 30
Perf Valid 1Day Intvl      : 20
Perf Invalid 1Day Intvl    : 20

                                PerfData  Curr15Min  Curr1Day  Prev1Day
Time Elapsed
/Monitored(sec)           15         10         20         45
Rx Blocks                   10         45         30         89
Tx Blocks                    20         65         70         48
Corrected Blocks            25         35         35         25
Uncorrected Blocks          30         95         80         30
NCD Count                   90         86         35         20
OCD Count                   60         42         15         20
HEC Count                   45         21         75         35
NCD Failure Count           20         20         20         20
LCD Failure Count           20         20         20         20
```

## Output Fields:

| FIELD                                | Description   |
|--------------------------------------|---|
| <b>Ifname</b>                        | IfIndex of the interface of type adslfast and adslInterleave.   |
| <b>Perf Valid Intervals</b>          | The number of previous 15-minute intervals in the interval table for which data was collected. (length = 4 bytes)   |
| <b>Perf Invalid Intervals</b>        | The number of intervals in the range from 0 to the value of "adslAtucChanPerfValidIntervals" for which no data is available. This object will typically be zero except in cases where the data for some intervals are not available (e.g., in proxy situations). (length = 4 bytes)                   |
| <b>Perf Valid 1Day Intvl</b>         | The number of previous 1-Day intervals in the interval table for which data was collected.(length = 4 bytes)  |
| <b>Perf Invalid 1Day Intvl</b>       | The number of intervals in the range from 0 to the value of adslAtucChanPerfValid1DayIntervals for which no data is available. This object will typically be zero except in cases where the data for some intervals are not available (e.g., in proxy situations).(length = 4 bytes)                  |
| <b>Time Elapsed/Monitored(see c)</b> | Total elapsed seconds in the intervals – Curr15Min, Curr1Day and Monitored seconds in Prev1Day.   |
| <b>Rx Blocks</b>                     | Performance Data :<br>Count of all encoded blocks received on this channel since agent was reset .<br>Curr15Min/Curr1Day/Prev1Day :<br>Count of all encoded blocks received on this channel in the current 15 minute/ current 1 day/ previous 1 day interval.   |
| <b>Tx Blocks</b>                     | Performance Data :<br>Count of all encoded blocks transmitted on this channel since agent reset.<br>Curr15Min/Curr1Day/Prev1Day :<br>Count of all encoded blocks transmitted on this channel in the current 15-minute/ current 1-day/ previous 1-day interval.  |
| <b>Corrected Blocks</b>              | Performance Data :<br>Count of all encoded blocks received with corrected errors on this channel since agent reset.<br>Curr15Min/Curr1Day/Prev1Day :<br>Count of all encoded blocks received with corrected errors on this channel, in the current 15 minute/ current 1 day/ previous 1 day interval. |
| <b>Uncorrected Blocks</b>            | Performance Data :<br>Count of all encoded blocks received with uncorrected errors on this channel since agent was reset.<br>Curr15Min/Curr1Day/Prev1Day :<br>Count of all encoded blocks received with uncorrected errors on this  |

|                          |  |
|--------------------------|--|
|                          | channel in the current 15 minute/ current 1 day/ previous 1 day interval.  |
| <b>NCD Count</b>         | <p>Performance Data :</p> <p>Number of packets with NCD (No Cell Delineation) error.</p> <p>Curr15Min/Curr1Day/Prev1Day :</p> <p>Number of packets with NCD error received in the current 15-minute/ current 1-day/ previous 1-day interval.</p>   |
| <b>OCD Count</b>         | <p>Performance Data :</p> <p>Number of packets with OCD (Out of Cell Delineation) error.</p> <p>Curr15Min/Curr1Day/Prev1Day :</p> <p>Number of packets with OCD error received in the current 15-minute/ current 1-day/ previous 1-day interval.</p>   |
| <b>HEC Count</b>         | <p>Performance Data :</p> <p>Number of packets with HEC error.</p> <p>Curr15Min/Curr1Day/Prev1Day :</p> <p>Number of packets with HEC error received in the current 15 minute/ current 1 day/ previous 1 day interval.</p>   |
| <b>NCD Failure Count</b> | <p>Performance Data :</p> <p>Count of all blocks received with no cell delineation(NCD) failures since agent reset. An NCD failure is declared when an NCD defect is present for 2-3 seconds after SHOWTIME. (length = 4 bytes).</p> <p>Curr15Min/Curr1Day/Prev1Day :</p> <p>Count of all blocks received with no cell delineation(NCD) failures in the current 15 minute/ current 1 day/ previous 1 day interval.</p>     |
| <b>LCD Failure Count</b> | <p>Performance Data :</p> <p>Count of all blocks received with loss of cell delineation(LCD) failures since agent reset. An LCD failure is declared when an LCD defect persists for more than 2 - 3 seconds.(length = 4 bytes).</p> <p>Curr15Min/Curr1Day/Prev1Day :</p> <p>Count of all blocks received with loss of cell delineation(LCD) failures in the current 15 minute/ current 1 day/ previous 1 day interval.</p> |



## 5.9.5 ADSL ATUC ChanIntvl Commands

### 5.9.5.1 Get adsl atuc chanintvl

#### Description:

Use this command to get.

#### Command Syntax:

```
get adsl atuc chanintvl [ifname <interface-name>] [nintrvl <nintrvl-val>]
```

#### Parameters:

| Name                         | Description  |
|------------------------------|--|
| <b>ifname</b> <fname-val>    | The ADSL ATUC channel interface name.<br><b>Type:</b> Get — Mandatory<br><b>Valid values:</b> dsli-0 – dsli-23 |
| <b>nintrvl</b> <nintrvl-val> | Performance Data Interval number.<br><b>Type:</b> Get — Mandatory<br><b>Valid values:</b> 1 - 96               |

#### Example:

```
$ get adsl atuc chanintvl ifname dsli-0 nintrvl 1
```

#### Output:

```
Ifname           : dsli-0      IntervalNumber    : 1
Rx Blocks        : 10          Tx Blocks         : 45
Corrected Blocks : 20          Uncorrected Blocks : 1
Gs Time Elapsed(sec) : 30      Valid Data       : true
GsNoCellDelineation : 20      GsHeaderErrorCheck : 0
GsOutOfCellDelineation : 0      AtucChanIntvlNcDs : 20
AtucChanIntvlLcDs  : 20
```

#### Output Fields:

| FIELD                   | Description  |
|-------------------------|--|
| <b>Ifname</b>           | The ADSL ATUC channel interface name.  |
| <b>IntervalNumber</b>   | Performance Data Interval number.  |
| <b>Rx Blocks</b>        | Count of all encoded blocks received on this channel during this interval.                                 |
| <b>Tx Blocks</b>        | Count of all encoded blocks transmitted on this channel during this interval.                              |
| <b>Corrected Blocks</b> | Count of all encoded blocks received with errors that were corrected on this channel during this interval. |

|                               |  |
|-------------------------------|--|
| <b>Uncorrected Blocks</b>     | Count of all encoded blocks received with uncorrected errors on this channel during this interval.                         |
| <b>Gs Time Elapsed(sec)</b>   | Total time elapsed (in seconds) in this interval.  |
| <b>Valid Data</b>             | Indicates if the data for this interval is valid.  |
| <b>GsNoCellDelineation</b>    | Count of no cell delineation on this channel for this interval.  |
| <b>GsHeaderErrorCheck</b>     | GlobespanVirata parameter. Header error check counter (hec) on this channel during this interval (length = 4 bytes).       |
| <b>GsOutOfCellDelineation</b> | GlobespanVirata parameter. Count of out of cell delineation (ocd) on this channel during this interval (length = 4 bytes). |
| <b>AtucChanIntvlNcDs</b>      | Count of all blocks received with NCD errors on this channel during this interval.(length = 4 bytes).                      |
| <b>AtucChanIntvlLcDs</b>      | Count of all blocks received with LCD errors on this channel during this interval.(length = 4 bytes).                      |

## 5.9.6 ADSL ATUC Interval Commands

### 5.9.6.1 Get adsl atuc interval

#### Description:

This command is used to get.

#### Command Syntax:

```
get adsl atuc interval ifname <interface-name> [nintrvl <num-of-intervals>]
```

#### Parameters:

| Name                                 | Description   |
|--------------------------------------|---|
| <b>ifname</b><br><interface-name>    | The ADSL ATUC channel interface name.<br><b>Type:</b> Get -- Mandatory<br><b>Valid values:</b> dsl-0 – dsl-23   |
| <b>nintrvl</b><br><num-of-intervals> | Number of intervals.<br><b>Type:</b> Get – Optional<br><b>Valid values :</b> 1- 96<br><b>Default Value :</b> 12 |

#### Example:

```
$ get adsl atuc interval ifname dsl-0 sintrvl 1 nintrvl 1
```

**Output:**

```

Ifname                : dsl-0
IntervalNumber        : 12          IntervalValidData    : False
IntervalLofs(sec)     : 83          IntervalLoss(sec)    : 84
IntervalLols(sec)     : 85          IntervalLprs(sec)    : 86
IntervalESs(sec)      : 87          Intervallnits        : 88
IntervalFastR         : 191         IntervalFailedFastR  : 192
IntervalSesL(sec)     : 193         IntervalUasL(sec)    : 194
IntervalFecsL(sec)    : 15          GsTimeElapsed(sec)   : 1001
IntervallnitsFailed   : 15

```

**Output Fields:**

| FIELD                      | Description  |
|----------------------------|--|
| <b>Ifname</b>              | The ADSL ATUC channel interface name.  |
| <b>IntervalNumber</b>      | Count from 1 through 96 of 15-minute intervals. Performance Data Interval number 1 is the most recent previous interval; interval 96 is 24 hours ago (length = 4 bytes). |
| <b>IntervalValidData</b>   | This indicates if the data for this interval is valid.   |
| <b>IntervalLofs(sec)</b>   | Count of seconds in the interval when there was Loss of Framing.   |
| <b>IntervalLoss(sec)</b>   | Count of seconds in the interval when there was Loss of Signal.  |
| <b>IntervalLols(sec)</b>   | Count of seconds in the interval when there was Loss of Link.  |
| <b>IntervalLprs(sec)</b>   | Count of seconds in the interval when there was Loss of Power.   |
| <b>IntervalESs(sec)</b>    | Count of Errored Seconds in the interval.  |
| <b>Intervallnits</b>       | Count of the line initialization attempts during the interval.   |
| <b>IntervalFastR</b>       | Count of seconds in the interval when there was Fast Retrans.  |
| <b>IntervalFailedFastR</b> | Count of seconds in the interval when there was Failed Fast Retrans.   |
| <b>IntervalSesL(sec)</b>   | Count of seconds in the interval when there was severely errored seconds.  |
| <b>IntervalUasL(sec)</b>   | Count of seconds in the interval when there was unavailable errored seconds.   |
| <b>IntervalFecsL(sec)</b>  | Count of seconds in the interval when there was Forward error correction seconds (length = 4 bytes).   |
| <b>GsTimeElapsed(sec)</b>  | Total elapsed seconds in this interval.  |
| <b>IntervallnitsFailed</b> | Count of the failed full line initialization attempts during the interval (length = 4 bytes).  |

## 5.9.7 ADSL ATUC Perf Commands

### 5.9.7.1 Get adsl atuc perf

#### Description:

Use this command to get ADSL ATUC interface performance.

#### Command Syntax:

**get adsl atuc perf [ifname <interface-name>]**

#### Parameters:

| Name                              | Description  |
|-----------------------------------|--|
| <b>ifname</b><br><interface-name> | The ADSL ATUC interface name, for which performance is to be viewed.<br><b>Type</b> : Get – Optional<br><b>Valid values</b> : <i>dsl-0 - dsl-*</i> |

#### Example:

```
$ get adsl atuc perf ifname dsl-0
```

#### Output:

```
Ifname                : dsl-0
Perf Valid Intervals  : 20
Perf Invalid Intervals : 30
AtucPerfStatLossL    : 10
                       PerfData   Curr15Min  Curr1Day  Prev1Day
Time Elapsed
/Monitored(sec)      30          10         20         30
LOFS (sec)           40          45         35         50
LOSS (sec)           30          65         75         20
LOLS (sec)           30          35         65         10
LPRS (sec)           10          95         30         80
ES (sec)              90          85         32         90
INITS                 60          42         15         20
Perf Stat FastR       45          21         75         35
Perf Stat Failed FastR 43          46         40         45
Perf Stat SESL        41          48         67         65
Perf Stat UASL        37          49         90         50
Perf Stat Fecsl       10          16         11         11
Perf Stat InitsFailed 10          16         11         11
```

## Output Fields:

| FIELD                                 | Description   |
|---------------------------------------|---|
| <b>lfname</b>                         | Ifindex of the type Adsl port Count of the number of Loss of Framing failures since agent reset.  |
| <b>Perf Valid Intervals</b>           | The number of previous 15-minute intervals in the interval table, for which data was collected. (length = 4 bytes)  |
| <b>Perf Invalid Intervals</b>         | The number of intervals in the range from 0 to the value of "adslAtucPerfValid-Intervals", for which no data is available. This object will typically be zero except in cases where the data for some intervals are not available (e.g., in proxy situations). (length = 4 bytes) |
| <b>AtucPerfStatLossL</b>              | Count of 1-second intervals containing one or more loss of signal (LOS) defects. (Not available for ADSL)   |
| <b>Time Elapsed/Monitored(second)</b> | <b>Performance Data</b> : Total time elapsed in seconds<br>Total elapsed seconds in the intervals – Curr15Min, Curr1Day and Monitored seconds in Prev1Day   |
| <b>LOFS (sec)</b>                     | <b>Performance Data</b> : Count of number of Loss of Framing failures since agent was reset.<br><b>Curr15Min/Curr1Day/Prev1Day</b> : Count of seconds in the current 15-minute/ current 1-day/ previous 1-day interval, when there was Loss of Framing.                           |
| <b>LOSS (sec)</b>                     | <b>Performance Data</b> : Count of number of Loss of signal failures since agent was reset.<br><b>Curr15Min/Curr1Day/Prev1Day</b> : Count of seconds in the current 15-minute/ current 1-day/ previous 1-day interval, when there was Loss of signals.                            |
| <b>LOLS (sec)</b>                     | <b>Performance Data</b> : Count of number of Loss of link failures since agent reset.<br><b>Curr15Min/Curr1Day/Prev1Day</b> : Count of seconds in the current 15-minute/ current 1-day/ previous 1-day interval, when there was Loss of link.                                     |
| <b>LPRS (sec)</b>                     | <b>Performance Data</b> : Count of number of Loss of power failures since agent was reset.<br><b>Curr15Min/Curr1Day/Prev1Day</b> : Count of seconds in the current 15-minute/ current 1-day/ previous 1-day interval, when there was Loss of power.                               |
| <b>ES (sec)</b>                       | <b>Performance Data</b> : Count of number of errored seconds since agent was reset.<br><b>Curr15Min/Curr1Day/Prev1Day</b> : Count of errored seconds in the current 15-minute/ current 1-day/ previous 1-day interval.  |

|                               |   |
|-------------------------------|---|
| <b>INITS</b>                  | <p><b>Performance Data</b> : Count of line initialization attempts since agent was reset.</p> <p><b>Curr15Min/Curr1Day/Prev1Day</b> : Count of line initialization attempts in the current 15-minute/ current 1-day/ previous 1-day interval.</p> <p>Includes both successful and failed attempts.</p>  |
| <b>Perf Stat FastR</b>        | <p><b>Performance Data</b> : Count of fast retrain.</p> <p><b>Curr15Min/Curr1Day/Prev1Day</b> : Count of seconds in the current 15-minute/ current 1-day/ previous 1-day interval, when there was Fast Retrain.</p>   |
| <b>Perf Stat Failed FastR</b> | <p><b>Performance Data</b> : Count of failed fast retrain.</p> <p><b>Curr15Min/Curr1Day/Prev1Day</b> : Count of seconds in the current 15-minute/ current 1-day/ previous 1-day interval when there was Failed Fast Retrain.</p>  |
| <b>Perf Stat SESL</b>         | <p><b>Performance Data</b> : Count of severely errored second line.</p> <p><b>Curr15Min/Curr1Day/Prev1Day</b> : Count of seconds in the current 15-minute/ current 1-day/ previous 1-day interval when there was severely errored second.</p>   |
| <b>Perf Stat UASL</b>         | <p><b>Performance Data</b> : Count of unavailable errored seconds.</p> <p><b>Curr15Min/Curr1Day/Prev1Day</b> : Count of seconds in the current 15-minute/ current 1-day/ previous 1-day interval when there was unavailable errored seconds.</p>  |
| <b>Perf Stat Fecsl</b>        | <p><b>Performance Data:</b></p> <p>Count of 1-second intervals, with one or more forward error correction (FEC) anomalies, since agent reset. (Not available for ADSL)</p> <p><b>Curr15Min/Curr1Day/Prev1Day:</b></p> <p>Count of 1-second intervals, in the current 15-minute/current 1-day/previous 1-day interval, with one or more forward error correction (FEC) anomalies. (Not available for ADSL)</p> |
| <b>Perf Stat InitsFailed</b>  | <p><b>Performance Data:</b></p> <p>Count of the failed full initialization attempts in current 15-minute/current 1-day/previous 1-day interval. A failed full initialization is when showtime is not reached at the end of the full initialization procedure.</p>   |

## 5.9.8 ADSL ATUC Physical Commands

### 5.9.8.1 Get adsl atuc physical

**Description:**

Use this command to get.

**Command Syntax:**

**get adsl atuc physical [ifname <interface-name>]**

**Parameters:**

| Name                              | Description  |
|-----------------------------------|--|
| <b>ifname</b><br><interface-name> | The ADSL ATUC physical interface name.<br><b>Type:</b> Get – Optional<br><b>Valid values:</b> dsl-0 – dsl-23 |

**Example:**

```
$ get adsl atuc physical ifname dsl-0
```

**Output:**

```
Ifname : dsl-0

Serial Number : Conexant 1.0
Vendor ID : 0039
Version Number : 1.0
Curr Status : NoDefect
Curr Snr Margin(dB/10) : 20 Curr Atn(dB/10) : 80
CurrAttainable Rate(bps) : 40 Curr Output Pwr(dB/10):90
GsOpState : Data
GsActualStandard : T1_413
GsTxAtmCellCounter : 214 GsRxAtmCellCounter : 215
GsStartProgress : 213
GsIdleBertError : 200 GsIdleBertCells : 100
GsBertSync : BertOutOfSync
GsBertError : 0
Data Boost Status : Enable Chan Perf CD : 2
```

Chan Perf BE : 5  
 PM State : L2 Chan Perf Cu : 10  
 Extended PSD Status : True Chip Version : 2  
 Pilot Tone : 21 Overhead Channel : 4000  
 Psd Mask : FlatMsk  
 System Vendor ID : 12345678  
 ATU-C Self Test Result : 10 Atuc G9941 Vendor ID:12345678  
 Atuc ACTPSDus (dB/10) : 90 AtucStartBin(GSpan++):90  
 StartUp Error Code : StartupErrorCodeMAXNOMATPus  
 BitSwapCount : 90  
 ModPhase : FlatRateCheck

Transmit Spectrum Shaping info

-----

[ 0] 90

UpStream Gains per bin

-----

[ 0] 15

GsSeltInfoValid : NotConnected

GsSeltLoopLen (in Feet) : 20

GsSeltLoopEnd : open

GsSeltLoopGauge : greater\_26awg

GsSeltUpShannonCap (in bps) : 10

GsSeltDownShannonCap (in bps) : 20

Selt InbandNoise Len (dBm/Hz)

-----

[ 0] 0110030607

Selt Termination Resp (0-18Kft ms)

-----

[ 0] 0110030607

Selt UpMgnAtRate (dB/10)

-----

[ 0] 0110030607



Selt DownMgnAtRate (dB/10)

-----

[ 0] 0110030607

Delt HLINSCus : 2

Delt HLOGMTus : 2 Delt LNMTus : 2

DELT Last Tx State : dmtatucg9941

Delt ShrmtUs : 100 DELT Curr Status: FailedUnknown

Delt HLINpsus

-----

[ 0] 5

Delt HLOGpsus

-----

[ 0] 20

Delt QLNPpsus

-----

[ 0] 12

Delt DMT Bin SNR

-----

[ 0] 16

Signal Atn(dB/10) : 40

GsParametricTestResult : Ok

Parametric Info

-----

Bin Number      Number of bits/bin

---

### Output Fields:

| FIELD          | Description   |
|----------------|---|
| Ifname         | The ADSL ATUC physical interface name.  |
| Serial Number  | The vendor specific string that identifies the vendor equipment.                            |
| Vendor ID      | Vendor ID Code.   |
| Version Number | The vendor specific version number sent by this ATU as part of the initialization messages. |

|                                 |  |
|---------------------------------|--|
| <b>Curr Status</b>              | Indicates current state of the ATUC line. This is a bit-map of possible conditions.  |
| <b>Curr Snr Margin(dB/10)</b>   | Noise Margin as seen by this ATU with respect to its received signal in tenth dB.  |
| <b>Curr Atn(dB/10)</b>          | Measured difference in the total power transmitted by the peer ATU and the total power received by this ATU.   |
| <b>CurrAttainable Rate(bps)</b> | Indicates the maximum currently attainable data rate by the ATU. This value will be equal to, or greater than the current line rate.   |
| <b>Curr Output Pwr(dB/10)</b>   | Measured total output power transmitted by this ATU. This is the measurement that was reported during the last activation sequence.  |
| <b>GsOpState</b>                | Operational state of the Xcvr.   |
| <b>GsActualStandard</b>         | Actual standard used for connection, based on the outcome of the negotiation with the Remote Unit.   |
| <b>GsTxAtmCellCounter</b>       | Provides Tx ATM cell counter.  |
| <b>GsRxAtmCellCounter</b>       | Provides Rx ATM cell counter.  |
| <b>GsStartProgress</b>          | Defines the current detailed start up state of Xcvr. 0x0ñ startup not in progress; 0x0 ñ 0x0FFF Handshake/Training/ Profile Management/ Fast Retrain inprogress; 0x8000 ñ 0x8FFF DSP firmware DownLoad in progress; 0xF000 ñ 0xFFFF illegal Parameter  |
| <b>GsIdleBertError</b>          | Number of bit errors.  |
| <b>GsIdleBertCells</b>          | Number of idle cells.  |
| <b>GsBertSync</b>               | Indicates whether the Signal is in Sync or not.  |
| <b>GsBertError</b>              | Provides the number of bit errors detected during BERT.  |
| <b>Data Boost Status</b>        | Conexant parameter that indicates whether DataBoost is utilized for the connection.  |
| <b>Chan Perf CD</b>             | The near-end delineated total cell count performance parameter is a count of the total number of cells passed through the cell delineation and HEC function process, operating on the ATM Data Path, while in the SYNC state. (Not available for ADSL) |
| <b>Chan Perf BE</b>             | The near-end idle bit error count performance parameter is a count of the number of bit errors in the idle cell payload received in the ATM Data Path at the near-end. (Not available for ADSL)  |
| <b>PM State</b>                 | The Line Power Management state. (Not available for ADSL)  |
| <b>Chan Perf Cu</b>             | The total number of data-only cells received by ATUC.  |

|                               |   |
|-------------------------------|---|
| <b>Extended PSD Status</b>    | Conexant parameter that indicates whether an extended upstream PSD is used - for G.Span Plus mode of operation only. Only supported for G.Span Plus, therefore this parameter is not valid for ADSL2/ADSL2plus modes of operation.  |
| <b>Chip Version</b>           | The DSP version number.   |
| <b>Pilot Tone</b>             | Conexant parameter that indicates the Pilot Tone Index.   |
| <b>Overhead Channel</b>       | Indicates the Overhead Channel. This feature is not supported by DSLPHY as yet.   |
| <b>Psd Mask</b>               | Conexant parameter that indicates the actual Psd Mask currently being used.   |
| <b>System Vendor ID</b>       | Indicates the Vendor ID as inserted by the ATU-C in the Overhead Messages(ADSL2). Typically identifies the ATU-C system integrator which usually refers to the vendor of the smallest field-replaceable unit. ATU-C System Vendor ID may not be the same as ATU-C Vendor ID. It is not available for ADSL. This is string of 8 octets containing 2 octet country code , 4 octet vendor id and 2 octet vendor revision number. |
| <b>ATU-C Self Test Result</b> | Defines the ATU-C selftest result. The most significant octet is: 00 hex if the self-test passed or 01 hex if the self-test failed. Interpretation of the other octets is vendor discretionary and can be interpreted in combination with G.994.1 and system Vendor IDs.  |
| <b>Atuc G.994.1 Vendor ID</b> | Indicates the Vendor ID as inserted by the ATU-C in the G.994.1 CL message. Typically identifies the vendor of the ATU-C G.994.1 functionality. This is string of 8 octets containing 2 octet country code , 4 octet vendor id and 2 octet vendor revision number.  |
| <b>Atuc ACTPSDus (dB/10)</b>  | This parameter defines the average upstream transmit power spectrum density over the used subcarriers delivered by the ATU-C at the U-C reference point, at the instant of measurement. It's value ranges from -90 to 0, in 0.1 dB/Hz steps. It is available only for ADSL2/ADSL2plus.  |
| <b>AtucStartBin (GSpan++)</b> | This Gspan++ parameter indicates the start bin of the bit loading up array.   |
| <b>StartUp Error Code</b>     | Conexant parameter which indicates the startup error code.  |
| <b>BitSwapCount</b>           | This Conexant parameter indicates the bit swap count. It can read only in data mode   |

|                                      |  |
|--------------------------------------|--|
| <b>ModPhase</b>                      | Conexant parameter to monitor the status of MoD  |
| <b>Atuc TSSpsUs</b>                  | This parameter provides the Upstream Transmit Spectrum Shaping parameter expressed as the set of break points exchanged during G994.1. Each breakpoint consists in a subcarrier index and the associated shaping parameter. Value of this parameter is in range 0 - 127, in multiples of -0.5 dB. 127 is a special value indicating the subcarrier is not transmitted. It is available only for ADSL2/ADSL2plus. |
| <b>GainspsUs</b>                     | This parameter defines the upstream gains allocation table per subcarrier. It is an array of integer values in the 0 to 4093 range for subcarriers 0 to NSCus-1. The gain value is represented as a multiple of 1/512 on linear scale. It is supported for ADSL2/ADSL2plus only.   |
| <b>GsSeltInfoValid</b>               | Indicates the information validity for the SELT operation conducted on the Xcvr.   |
| <b>GsSeltLoopLen (in Feet)</b>       | Indicates the LOOP Length in Feet once when the SELT information is valid on the Xcvr.   |
| <b>GsSeltLoopEnd</b>                 | Indicates whether the loop is short or open once when the SELT information is valid on the Xcvr.   |
| <b>GsSeltLoopGauge</b>               | Indicates the LOOP wire gauge information once, when the SELT information is valid on the Xcvr.  |
| <b>GsSeltUpShannonCap (in bps)</b>   | Indicates the upstream shannon capacity once, when the SELT information is valid on the Xcvr.  |
| <b>GsSeltDownShannonCap (in bps)</b> | Indicates the downstream shannon capacity once, when the SELT information is valid on the Xcvr.  |
| <b>AtucGsSeltInbandNoise</b>         | 512 values that indicate inband noise length in dBm/Hz, covering both bands from 0 to 1.1 MHz.   |
| <b>AtucGsSeltTerminationResp</b>     | 180 discrete values that indicate termination response magnitude from 0 to 18Kft.  |
| <b>AtucGsSeltUpMgnAtRate</b>         | 300 values that indicate SNR margin in dB/10 at a particular rate are provided, at 100K increments, up to 15 Mbps.   |
| <b>AtucGsSeltDownMgnAtRate</b>       | 300 values that indicate SNR margin in dB/10 at a particular rate are provided, at 100K increments, up to 15 Mbps.   |
| <b>Delt HLINSCus</b>                 | The DELT-related parameter that provides the scale factor to be applied to the upstream Hlin (f) values. (Not available for ADSL and ADSL2plus)  |
| <b>Delt HLOGMTus</b>                 | The DELT-related parameter that provides the number of symbols used to measure the upstream Hlog (f). (Not   |

|                               |   |
|-------------------------------|---|
|                               | available for ADSL and ADSL2plus)   |
| <b>Delt QLNMTus</b>           | The DELT-related parameter that provides the number of symbols used to measure the upstreamQLN (f) values.<br>(Not available for ADSL and ADSL2plus)  |
| <b>DELT Last Tx State</b>     | The DELT-related parameter that provides the last successful transmitted initialization state by the ATUC.<br>(Not available for ADSL and ADSL2plus)  |
| <b>Delt SnrmtUs</b>           | DELT-related parameter that provides the number of symbols used to measure the upstream SNR(f) values.<br>(Not available for ADSL and ADSL2plus).   |
| <b>DELT Curr Status</b>       | Current Status of Atuc Line in DELT Mode  |
| <b>Delt HLINpsus</b>          | The DELT-related parameter that provides an array of complex upstream Hlin (f) values in linear scale. (Not available for ADSL and ADSL2plus)   |
| <b>Delt HLOGpsus</b>          | The DELT-related parameter that provides an array of real upstream Hlog (f) values in dB. (Not available for ADSL and ADSL2plus)  |
| <b>Delt QLNpsus</b>           | The DELT-related parameter that provides an array of real upstream QLN (f) values in dB. (Not available for ADSL and ADSL2plus)   |
| <b>Delt DMT Bin SNR</b>       | The DELT-related parameter that provides an array of real upstream SNR (f) values in dB. (Not available for ADSL and ADSL2plus)   |
| <b>Signal Atn(dB/10)</b>      | DELT-related parameter that provides the upstream signal attenuation (length = 4 bytes). (Not available for ADSL and ADSL2plus).  |
| <b>GsParametricTestResult</b> | Indicates the Result of the Parametric Test conducted on the Xcvr.  |
| <b>Parametric Info</b>        | Conexant parameter that indicates the Parametric Test Array.  |
| <b>AtucDMTBinBits</b>         | Number of bits per bin for the bin indexed by this element of the string. The 0th element contains the number of bits for bin 0 through to the 31st element, which contains the number of bits for bin 31. The range of expected values is from 0 to 15 bits per bin. |

## 5.9.9 ADSL ATUC Trap Commands

### 5.9.9.1 Get adsl atuc traps

**Description:**

This command is used to get.

**Command Syntax:**

```
get adsl atuc traps [ifname <interface-name>
```

**Example:**

```
$ get adsl atuc traps ifname dsl-0
```

**Output:**

```
Ifname           : dsl-0
Lofs Thresh Trap : 0           Loss Thresh Trap   : 1
Lols Thresh Trap : 0           Lprs Thresh Trap   : 1
ESs Thresh Trap  : 1           Init Failure Trap   : 1
Rate Change Trap : 0           Gs OpState Trap     : 1
PM State Trap    : 2           Command Failure Trap : 2
```

**Output Fields :**

| FIELD                | Description   |
|----------------------|---|
| Ifname               | The IfIndex of DSL port.  |
| Lofs Thresh Trap     | Loss of Framing 15-minute interval threshold reached (length = 4 bytes).  |
| Loss Thresh Trap     | Loss of Signal 15-minute interval threshold reached (length = 4 bytes).   |
| Lols Thresh Trap     | Loss of Link 15-minute interval threshold reached (length = 4 bytes).   |
| Lprs Thresh Trap     | Loss of Power 15-minute interval threshold reached (length = 4 bytes).  |
| ESs Thresh Trap      | Errored Second 15-minute interval threshold reached (length = 4 bytes).   |
| Init Failure Trap    | ATU-C initialization failed. Refer to adslAtucCurrStatus for potential reasons (length = 4 bytes).                                      |
| Rate Change Trap     | The ATU-Cs transmit rate has changed (RADSL mode only) (length = 4 bytes).  |
| Gs OpState Trap      | Op State change (length = 4 bytes).   |
| PM State Trap        | PM state change trap used for ADSL2/ADSL2plus PM operation. This trap is not valid for ADSL mode.                                       |
| Command Failure Trap | When the APIs fail to send a customer command to the DSP, the customer is notified by a new trap and they need to re-issue the command. |

## 5.9.10 ADSL ATUC Trapsext Commands

### 5.9.10.1 Get adsl atuc trapsext

#### Description:

Use this command to get.

#### Command Syntax:

**get adsl atuc trapsext [ifname <interface-name>]**

#### Parameters:

| Name                       | Description   |
|----------------------------|---|
| ifname<br><interface-name> | The IfIndex of DSL port.<br><b>Type:</b> Get -- Optional<br><b>Valid values:</b> dsl-0 – dsl-23 |

#### Example:

```
$ get adsl atuc trapsext ifname dsl-0
```

#### Output:

```
Ifname : dsl-0
Failed FastR Thresh 15Min Trap : 1 SesL Thresh 15Min Trap:1
UasL Thresh 15Min Trap : 1 Fecsl Thresh 15Min Trap:0
Lofs Thresh 1Day Trap : 0 Loss Thresh 1Day Trap : 1
Lols Thresh 1Day Trap : 1 Lprs Thresh 1Day Trap: 1
ESs Thresh 1Day Trap : 0 SesL Thresh 1Day Trap: 0
UasL Thresh 1Day Trap : 1 Fecsl Thresh 1Day Trap: 0
```

#### Output Fields:

| FIELD                                 | Description  |
|---------------------------------------|--|
| <b>Ifname</b>                         | The IfIndex of DSL port.   |
| <b>Failed FastR Thresh 15Min Trap</b> | Failed retrains 15-minute interval threshold reached.                  |
| <b>SesL Thresh 15Min Trap</b>         | Severely Errored Seconds 15-minute interval threshold reached.         |
| <b>UasL Thresh 15Min Trap</b>         | Unavailable Error Seconds 15-minute interval threshold reached.        |
| <b>Fecsl Thresh 15Min Trap</b>        | Forward error correction Seconds 15-minute interval threshold reached. |
| <b>Lofs Thresh 1Day Trap</b>          | Loss of Frames 1-day interval threshold reached.                       |

|                               |  |
|-------------------------------|--|
| <b>Loss Thresh 1Day Trap</b>  | Loss of Signal 1-day interval threshold reached.                   |
| <b>Lols Thresh 1Day Trap</b>  | Loss of Link 1-day interval threshold reached.                     |
| <b>Lprs Thresh 1Day Trap</b>  | Loss of Power 1-day interval threshold reached.                    |
| <b>ESs Thresh 1Day Trap</b>   | Errored Seconds 1-day interval threshold reached.                  |
| <b>SesL Thresh 1Day Trap</b>  | Severely Errored Seconds 1-day interval threshold reached.         |
| <b>UasL Thresh 1Day Trap</b>  | Unavailable Errored Seconds 1-day interval threshold reached.      |
| <b>FecsL Thresh 1Day Trap</b> | Forward error correction Seconds 1-day interval threshold reached. |

## 5.9.11 ADSL ATUR ChanIntrvl Commands

### 5.9.11.1 Get adsl atur chanintrvl

#### Description:

Use this command to get.

#### Command Syntax:

**get adsl atur chanintrvl [ifname <interface-name>] [nintrvl <nintrvl-val>]**

#### Parameters:

| Name                              | Description   |
|-----------------------------------|---|
| <b>ifname</b><br><interface-name> | The ADSL interface name<br><b>Type:</b> Get — Mandatory<br><b>Valid values:</b> dsli-0 - dsli-23                |
| <b>nintrvl</b> <nintrvl-val>      | Count from 1 through 96, of 15 minute intervals.<br><b>Type:</b> Get — Mandatory<br><b>Valid values:</b> 1 - 96 |

#### Example:

```
$ get adsl atur chanintrvl ifname dsli-0 nintrvl 2
```

#### Output:

```
Ifname           : dsli-0      IntervalNumber    : 2
Rx Blocks        : 10          Tx Blocks        : 10
Corrected Blocks : 10          Uncorrected Blocks : 10
GsNoCellDelineation : 10      GsHeaderErrorCheck : 10
Valid Data       : true        AturChanIntvlNcds : 20
AturChanIntvlLcads : 20
```



## Output Fields:

| FIELD                      | Description   |
|----------------------------|---|
| <b>Ifname</b>              | The ADSL interface name   |
| <b>IntervalNumber</b>      | Count from 1 through 96, of 15 minute intervals.  |
| <b>Rx Blocks</b>           | Count of all encoded blocks received on this channel, during this interval.                                       |
| <b>Tx Blocks</b>           | Count of all encoded blocks transmitted on this channel, during this interval.                                    |
| <b>Corrected Blocks</b>    | Count of all encoded blocks received with errors that were corrected on this channel, during this interval.       |
| <b>Uncorrected Blocks</b>  | Count of all encoded blocks received with errors that cannot be corrected, on this channel, during this interval. |
| <b>GsNoCellDelineation</b> | GlobespanVirata parameter. Count of no cell delineation (ncd) on this channel during this interval.               |
| <b>GsHeaderErrorCheck</b>  | Conexant parameter. Header error check counter (HEC) on this channel, during this interval.                       |
| <b>Valid Data</b>          | This indicates if the data for this interval is valid.  |
| <b>AturChanIntvINcds</b>   | Count of all blocks received with NCD errors on this channel during this interval.(length = 4 bytes).             |
| <b>AturChanIntvLCds</b>    | Count of all blocks received with LCD errors on this channel during this interval.(length = 4 bytes).             |

## References:

- atur interval related commands

## 5.9.12 ADSL ATUR Channel Commands

### 5.9.12.1 Get adsl atur channel

#### Description:

Use this command to get.

#### Command Syntax:

```
get adsl atur channel [ifname <interface-name>]
```

#### Parameters:

| Name                              | Description  |
|-----------------------------------|--|
| <b>ifname</b><br><interface-name> | The ADSL interface name<br><b>Type:</b> Get – Mandatory<br><b>Valid values:</b> dsli-0 - dsli-23 |

**Example:**

```
$ get adsl atur channel ifname dsli-0
```

**Output:**

```

Ifname                : dsli-0
Interleave Delay(ms) : 10      Curr Tx Rate(bps)      : 10
Prev Tx Rate(bps)    : 10      Crc Block Length(byte) : 10
Gs Curr Atm Status   : 1       GsSymbolsPerRsWord     : 10
GsRsDepth            : 10      GsRedundantBytesPerRsCode : 10
AturChanPerfAtmCD    : 10      AturChanPerfAtmCU      : 10
AturChanGsINPup      : 10      AturChanGsL0up         : 10
AturChanGsM0up       : 10      AturChanGsT0up         : 10
AturChanGsB0up       : 10

```

**Output Fields:**

| FIELD                         | Description  |
|-------------------------------|--|
| <b>Ifname</b>                 | The ADSL Interface Name  |
| <b>Interleave Delay(ms)</b>   | Interleave delay for this channel. Interleave delay applies only to the interleave channel and defines the mapping (relative spacing) between subsequent input bytes at the interleaver input and their placement in the bit stream at the interleaver output. Larger numbers provide greater separation between consecutive input bytes in the output bit stream, allowing for improved impulse noise immunity at the expense of payload latency. |
| <b>Curr Tx Rate(bps)</b>      | Actual transmit rate on this channel   |
| <b>Prev Tx Rate(bps)</b>      | The rate at the time of the last adslAturRateChangeTrap event.   |
| <b>Crc Block Length(byte)</b> | Indicates the length of the channel data-block on which the CRC operates.  |
| <b>Gs Curr Atm Status</b>     | Indicates an ncd or lcd failure if the counter surpasses 127. If neither ATM counter surpasses 127, the return value will be NoAtmDefect.  |
| <b>GsSymbolsPerRsWord</b>     | Indicates number of DMT symbols per Reed- Solomon code word (S) in the upstream direction Note that S is not restricted to interleaved mode only. Even in fast mode, S is a valid constant value and is equal to 1.  |
| <b>GsRsDepth</b>              | Indicates interleaving depth (D) in the upstream direction Note that D is not restricted to interleaved mode only. Even in fast mode, D is a valid constant value and is   |

|                                  |  |
|----------------------------------|--|
|                                  | equal to 1.  |
| <b>GsRedundantBytesPerRsCode</b> | Indicates number of redundant bytes (R) per Reed-Solomon code in the upstream direction  |
| <b>AturChanPerfAtmCD</b>         | Provides a count of the total number of cells passed through the cell delineation and HEC function process operating on the ATM Data Path while in the SYNC state.(length = 4 bytes).          |
| <b>AturChanPerfAtmCU</b>         | Provides a count of the total number of cells in the ATM Data Path delivered at the interface(s) between ATU-R and ATM switching layer.(length = 4 bytes).                                     |
| <b>AturChanGsINPup</b>           | The actual number of Impulse Noise Protection(INP) symbols for the upstream interleaved channel. One symbol equals 250 $\mu$ s, so an INP of 1 correlates to a correction time of 250 $\mu$ s. |
| <b>AturChanGsL0up</b>            | The number of bits from the upstream latency path function #0 included per DMT symbol.(length = 4 bytes). It is not available for ADSL.  |
| <b>AturChanGsM0up</b>            | The number of Mux Data Frames per FEC Data Frame in upstream latency path function #0.(length = 4 bytes). It is not available for ADSL.  |
| <b>AturChanGsT0up</b>            | The ratio of the number of Mux Data Frames to the number of sync octets in the upstream latency path function #0.(length = 4 bytes). It is not available for ADSL.                             |
| <b>AturChanGsB0up</b>            | The nominal number of octets from frame bearer #0 per Mux Data Frame at Reference Point A in upstream latency path function #0.(length = 4 bytes). It is not available for ADSL.               |

### References:

- ADSL commands

## 5.9.13 ADSL ATUR Chanperf Commands

### 5.9.13.1 Get adsl atur chanperf

**Description:**

This command is used to get.

**Command Syntax:**

```
get adsl atur chanperf [ifname <interface-name>]
```

**Parameters:**

| Name                       | Description  |
|----------------------------|--|
| ifname<br><interface-name> | The ADSL interface name.<br><b>Type</b> : Get – Optional<br><b>Valid values</b> : dsli-0 – dsli-23 |

**Example:**

```
$ get adsl atur chanperf ifname dsli-0
```

**Output:**

```
ifname                : dsli-0
Perf Valid Intervals  : 10
Perf Invalid Intervals : 10
Perf valid 1Day Intvl : 20
Perf Invalid 1Day Intvl : 20

                PerfData  Curr15Min  Curr1Day  Prev1Day
Time Elapsed
/Monitored(sec)  -         10         10         10
Rx Blocks        10         10         10         10
Tx Blocks        10         10         10         10
Corrected Blocks 10         10         10         10
Uncorrected Blocks 10        10         10         10
NCD Count        10         10         10         10
HEC Count        10         10         10         10
NCD Failure Count 20         20         20         20
LCD Failure Count 20         20         20         20
```

## Output Fields:

| FIELD                              | Description  |
|------------------------------------|--|
| <b>Ifname</b>                      | The ADSL interface name.   |
| <b>Perf Valid Intervals</b>        | Number of previous 15-minute intervals, for which the data was collected.  |
| <b>Perf Invalid Intervals</b>      | Number of previous 15- minute intervals, for which no data is available.   |
| <b>Perf valid 1Day Intvl</b>       | The number of previous 1-day intervals in the interval table for which data was collected.(length = 4 bytes).  |
| <b>Perf Invalid 1Day Intvl</b>     | The number of intervals in the range from 0 to the value of adslAturChanPerfValid1DayIntervals for which no data is available. This object will typically be zero except in cases where the data for some intervals are not available (e.g., in proxy situations).(length = 4 bytes).                  |
| <b>Time Elapsed/Monitored(sec)</b> | Total elapsed seconds in the intervals – Curr15Min, Curr1Day and Monitored seconds in Prev1Day.  |
| <b>Rx Blocks</b>                   | Performance Data :<br>Count of all encoded blocks received on this channel, since agent was reset.<br>Curr15Min/Curr1Day/Prev1Day :<br>Count of all encoded blocks received on this channel in the current 15 minute/ current 1 day/ previous 1 day interval.  |
| <b>Tx Blocks</b>                   | Performance Data :<br>Count of all encoded blocks transmitted on this Channel, since agent reset.<br>Curr15Min/Curr1Day/Prev1Day :<br>Count of all encoded blocks transmitted on this channel in the current 15-minute/ current 1-day/ previous 1-day interval.  |
| <b>Corrected Blocks</b>            | Performance Data :<br>Count of all encoded blocks received with corrected errors on this channel, since agent reset.<br>Curr15Min/Curr1Day/Prev1Day :<br>Count of all encoded blocks received with corrected errors on this channel, in the current 15 minute/ current 1 day/ previous 1 day interval. |
| <b>Uncorrected Blocks</b>          | Performance Data :<br>Count of all encoded blocks received with uncorrected errors on this channel, since agent was reset.   |

|                          |   |
|--------------------------|---|
|                          | <p>Curr15Min/Curr1Day/Prev1Day :</p> <p>Count of all encoded blocks received with uncorrected errors on this channel, in the current 15 minute/ current 1 day/ previous 1 day interval.</p>   |
| <b>NCD Count</b>         | <p>Performance Data :</p> <p>Number of packets with NCD (No Cell Delineation) errors.</p> <p>Curr15Min/Curr1Day/Prev1Day :</p> <p>Number of packets with NCD error, received in the current 15-minute/ current 1-day/ previous 1-day interval.</p>  |
| <b>HEC Count</b>         | <p>Performance Data :</p> <p>Number of packets with HEC error.</p> <p>Curr15Min/Curr1Day/Prev1Day :</p> <p>Number of packets with HEC error received in the current 15 minute/ current 1 day/ previous 1 day interval.</p>  |
| <b>NCD Failure Count</b> | <p>Performance Data :</p> <p>Count of all blocks received with no cell delineation (NCD) failures since agent reset. An NCD failure is declared when an NCD defect is present for 2-3 seconds after SHOWTIME.(length = 4 bytes).</p> <p>Curr15Min/Curr1Day/Prev1Day :</p> <p>Count of all blocks received with no cell delineation(NCD) failures in the current 15 minute/ current 1 day/ previous 1 day interval.</p>      |
| <b>LCD Failure Count</b> | <p>Performance Data :</p> <p>Count of all blocks received with loss of cell delineation (LCD) failures since agent reset. An LCD failure is declared when an LCD defect persists for more than 2 - 3 seconds.(length = 4 bytes)</p> <p>Curr15Min/Curr1Day/Prev1Day :</p> <p>Count of all blocks received with loss of cell delineation (LCD) failures in the current 15 minute/ current 1 day/ previous 1 day interval.</p> |

**References:**

- ADSL commands

## 5.9.14 ADSL ATUR Interval Commands

### 5.9.14.1 Get adsl atur interval

#### Description:

This command is used to get.

#### Command Syntax:

```
get adsl atur interval ifname <interface-name> [nintrvl <nintrvl-val>]
```

#### Parameters:

| Name                              | Description   |
|-----------------------------------|---|
| <b>ifname</b><br><interface-name> | The ADSL interface name.<br><b>Type</b> : Get – Mandatory<br><b>Valid values</b> : dsl-0 – dsl-23 |
| <b>nintrvl</b> <nintrvl-val>      | Number of 15 minutes intervals.<br><b>Type</b> : Get – Optional<br><b>Valid values</b> : 1 - 96   |

#### Example:

```
$ get adsl atur interval ifname dsl-0 nintrvl 1
```

#### Output:

```
ifname           : dsl-0
IntervalNumber   : 1           IntervalValidData : true
IntervalLofs(sec) : 10        IntervalLoss(sec) : 10
IntervalLprs(sec) : 10
IntervalLEs(sec) : 10
```

#### Output Fields:

| FIELD                    | Description  |
|--------------------------|--|
| <b>ifname</b>            | The IfIndex of DSL port  |
| <b>IntervalNumber</b>    | Count from 1 through 96 of 15 minute intervals. Performance Data Interval number 1 is the most recent previous interval; interval 96 is 24 hours ago.                              |
| <b>IntervalValidData</b> | This variable indicates if the data for this interval is valid.  |
| <b>IntervalLofs(sec)</b> | Count of seconds in the interval when there was Loss of Framing.   |
| <b>IntervalLoss(sec)</b> | Count of seconds in the interval when there was Loss of Signal.  |
| <b>IntervalLprs(sec)</b> | Count of seconds in the interval when there was Loss of Power.   |
| <b>IntervalESs(sec)</b>  | Count of Errored Seconds in the interval. The errored second parameter is a count of one-second intervals containing one or more crc anomalies, or one or more los or sef defects. |

## 5.9.15 Adsl atur intervalext Commands

### 5.9.15.1 Get adsl atur intervalext

#### Description:

This command is used to get.

#### Command Syntax:

```
get adsl atur intervalext [ifname <interface-name>] [nintrvl <nintrvl-val>]
```

#### Parameters:

| Name                       | Description  |
|----------------------------|--|
| ifname<br><interface-name> | The ADSL interface name.<br><b>Type</b> : Get – Mandator<br><b>Valid values</b> : dsl-0 – dsl-23                   |
| nintrvl <nintrvl-val>      | Count from 1 through 96, of 15 minute intervals.<br><b>Type</b> : Get -- Mandatory<br><b>Valid values</b> : 1 - 96 |

#### Example:

```
$ get adsl atur intervalext IFNAME dsl-0 NINTRVL 1
```

#### Output:

```
ifname           : dsl-0
IntervalNumber   : 1
IntervalSesl(sec) : 10          IntervalUasL(sec) : 10
IntervalFecsl(sec) : 10
```

#### Output Fields:

| FIELD              | Description   |
|--------------------|---|
| ifname             | The ADSL interface name.  |
| IntervalNumber     | Count from 1 through 96, of 15 minute intervals.                                  |
| IntervalSesl(sec)  | Count of seconds in the interval when there was severely errored seconds.         |
| IntervalUasL(sec)  | Count of seconds in the interval when there was unavailable errored seconds.      |
| IntervalFecsl(sec) | Count of seconds in the interval when there was Forward error correction seconds. |

#### References

- atur interval related commands



## 5.9.16 ADSL ATUR Perf Commands

### 5.9.16.1 Get adsl atur perf

#### Description:

This command is used to get.

#### Command Syntax:

```
get adsl atur perf [ifname <interface-name>]
```

#### Parameters:

| Name                       | Description  |
|----------------------------|--|
| ifname<br><interface-name> | The ADSL interface name.<br><b>Type</b> : Get – Mandatory<br><b>Valid values</b> : dsl-0 – dsl-23. |

#### Example:

```
$ get adsl atur perf ifname dsl-0
```

#### Output:

```
ifname                : dsl-0
Perf Valid Intervals  : 10
Perf Invalid Intervals : 10

                PerfData  Curr15Min  Curr1Day  Prev1Day
Time Elapsed/Monitored(sec) -      10        10        10
LOFS (sec)          10          10        10        10
LOSS (sec)          10          10        10        10
LPRS (sec)          10          10        10        10
ES (sec)            10          10        10        10
```

#### Output Fields:

| FIELD                  | Description   |
|------------------------|---|
| ifname                 | Index of the type Adsl port   |
| Perf Valid Intervals   | The number of previous 15-minute intervals in the interval table for which data was collected.  |
| Perf Invalid Intervals | The number of intervals in the range from 0 to the value of 'adslAturPerfValid-Intervals' for which no data is available. This object will typically be zero except in cases where the data for some intervals are not available (e.g., in proxy situations). |
| Time                   | Total elapsed seconds in the intervals – Curr15Min,   |

|                               |   |
|-------------------------------|---|
| <b>Elapsed/Monitored(sec)</b> | Curr1Day and Monitored seconds in Prev1Day.   |
| <b>LOFS (sec)</b>             | <b>Performance Data :</b> Count of number of Loss of Framing failures since agent was reset.<br><b>Curr15Min/Curr1Day/Prev1Day :</b> Count of seconds in the current 15-minute/ current 1-day/ previous 1-day interval, when there was Loss of Framing. |
| <b>LOSS (sec)</b>             | <b>Performance Data :</b> Count of number of Loss of signal failures since agent was reset.<br><b>Curr15Min/Curr1Day/Prev1Day :</b> Count of seconds in the current 15-minute/ current 1-day/ previous 1-day interval, when there was Loss of signals.  |
| <b>LPRS (sec)</b>             | <b>Performance Data:</b> Count of number of Loss of power failures, since agent was reset.<br><b>Curr15Min/Curr1Day/Prev1Day :</b> Count of seconds in the current 15-minute/ current 1-day/ previous 1- day interval, when there was Loss of power.    |
| <b>ES (sec)</b>               | <b>Performance Data :</b> Count of number of errored seconds since agent was reset.<br><b>Curr15Min/Curr1Day/Prev1Day :</b> Count of errored seconds in the current 15-minute/ current 1-day/ previous 1-day interval.                                  |

## 5.9.17 Adsl atur perfixt Commands

### 5.9.17.1 Get adsl atur perfixt

#### Description:

Use this command to get.

#### Command Syntax:

**get adsl atur perfixt [ifname <interface-name>]**

#### Parameters:

| Name                           | Description   |
|--------------------------------|---|
| <b>ifname</b> <interface-name> | Ifindex of the type Adsl port<br><b>Type:</b> Get -- Mandatory<br><b>Valid values:</b> dsl-0 – dsl-23 |

#### Example:

\$ get adsl atur perfixt ifname dsl-0

**Output:**

lfname : dsl-0

AturPerfStatLossL : 14

|                 | PerfData | Curr15Min | Curr1Day | Prev1Day |
|-----------------|----------|-----------|----------|----------|
| Perf Stat SESL  | 10       | 10        | 10       | 10       |
| Perf Stat UASL  | 10       | 10        | 10       | 10       |
| Perf Stat Fecsl | 11       | 13        | 19       | 21       |

**Output Fields:**

| FIELD             | Description  |
|-------------------|--|
| lfname            | lfindex of the type Adsl port  |
| AturPerfStatLossL | Count of 1-second intervals containing one or more far end loss of signal (LOS) defects (Not available for ADSL)   |
| Perf Stat SESL    | <b>Performance Data</b> : Count of severely errored second line.<br><b>Curr15Min/Curr1Day/Prev1Day</b> : Count of seconds in the current 15-minute/ current 1-day/ previous 1- day interval, when there was severely errored second.   |
| Perf Stat UASL    | <b>Performance Data</b> : Count of unavailable errored seconds.<br><b>Curr15Min/Curr1Day/Prev1Day</b> : Count of seconds in the current 15-minute/ current 1-day/ previous 1- day interval, when there was unavailable errored seconds.  |
| Perf Stat Fecsl   | <b>Performance Data:</b><br>Count of 1-second intervals, with one or more forward error correction (FEC) anomalies, since agent reset. (Not available for ADSL)<br><b>Curr15Min/Curr1Day/Prev1Day:</b><br>Count of 1-second intervals, in the current 15-minute/current 1-day/previous 1-day interval, with one or more forward error correction (FEC) anomalies. (Not available for ADSL) |

**References:**

- atur perfddata related commands

## 5.9.18 ADSL ATUR Physical Commands

### 5.9.18.1 Get adsl atur physical

#### Description:

Use this command to get.

#### Command Syntax:

**get adsl atur physical [ifname <interface-name>]**

#### Parameters:

| Name                              | Description   |
|-----------------------------------|---|
| <b>ifname</b><br><interface-name> | The ADSL interface name.<br><b>Type</b> : Get – Mandatory<br><b>Valid values</b> : dsl-0 – dsl-23 |

#### Example:

```
$ get adsl atur physical ifname dsl-0
```

#### Output:

```
Ifname                               : dsl-0

Serial Number                         : CO123456
Vendor ID                             : Vendor123
Version Number                       : VerNo98114
Curr Status                           : LossOfFraming
Curr Snr Margin(dB/10)                : 10           Curr
Atn(dB/10)                            : 10
CurrAttainable Rate(bps)              : 10           Curr Output Pwr(dB/10) :
10
AturGsConfig                         : 0x0121020203
Chan Perf CD                          : 5           Chan Perf
CU                                    : 5
Chan Perf BE                          : 5
Overhead Channel                      : 4000        System Vendor
ID                                    : 12345678
ATU-R Self Test Result                 : 0x10        ATUR G9941 Vendor
ID                                    : 12345678
Atur ACTPSDs (dB/10)                  : 90
BitSwapCount                          : 90
PSDMaskMode                           : CoMsk2
```

DownStream Gains per bin

-----

[ 0] 15

Transmit Spectrum Shaping info

-----

[ 0] 90

Delt HLINSCds : 2  
 Delt HLOGMTds : 8 Delt

QLNMTds : 5  
 DELT Last Tx State : dmtaturg9941 Delt

SnrmtDs : 100

Delt HLINpsds

-----

[ 0] 18

Delt HLOGpsds

-----

[ 0] 20

Delt QLNpsds

-----

[ 0] 22

Delt DMT Bin SNR

-----

[ 0] 22

Signal Atn(dB/10) : 40

Bin Number Number of bits/bin

-----

[ 0] 0110030607

**Output Fields:**

| FIELD                 | Description   |
|-----------------------|---|
| <b>Ifname</b>         | The ADSL Interface Name   |
| <b>Serial Number</b>  | The vendor specific string that identifies the vendor equipment (EOC - read 5 seconds after data mode).   |
| <b>Vendor ID</b>      | Vendor ID code (EOC - read 5 seconds after data mode).  |
| <b>Version Number</b> | The vendor specific version number sent by this ATU, as part of the initialization messages (EOC - read 5 seconds after data mode).   |
| <b>Curr Status</b>    | Indicates current State of ATUR Line. This is a bitmap of possible conditions. Due to the isolation of the ATU-R when line problems occur, many state conditions such as loss of power, loss of quality |

|                                 |   |
|---------------------------------|---|
|                                 | signal, and initialization errors, cannot be determined.  |
| <b>Curr Snr Margin(dB/10)</b>   | Noise Margin as seen by this ATU, with respect to its received signal, in tenth dB.   |
| <b>Curr Atn(dB/10)</b>          | Measured difference in the total power transmitted by the peer ATU, and the total power received by this ATU.   |
| <b>CurrAttainable Rate(bps)</b> | Indicates the maximum currently attainable data rate by the ATU. This value will be equal to, or greater than, the current line rate.   |
| <b>Curr Output Pwr(dB/10)</b>   | Measured total output power transmitted by this ATU.This is the measurement that was reported during the last activation sequence.  |
| <b>AturGsConfig</b>             | The upstream and downstream ATU-R configuration data (EOC - read 5 sec after data mode).  |
| <b>Chan Perf CD</b>             | The far-end delineated total cell count performance parameter is a count of the total number of cells passed through the cell delineation and HEC function process, operating on the ATM Data Path, while in the SYNC state. (Not available for ADSL)   |
| <b>Chan Perf CU</b>             | The far-end user total cell count performance parameter is a count of the total number of cells in the ATM Data Path delivered at the V-C (for ATU-C) or TR (for ATUR) interface. (Not available for ADSL)  |
| <b>Chan Perf BE</b>             | The far-end idle bit error count performance parameter is a count of the number of bit errors in the idle cell payload received in the ATM Data Path at the far-end. (Not available for ADSL)   |
| <b>Overhead Channel</b>         | Indicates the Overhead Channel. This feature is not supported by DSLPHY as yet.   |
| <b>System Vendor ID</b>         | Indicates the Vendor ID as inserted by the ATU-R in the Embedded Operations Channel(ADSL). Typically identifies the ATU-R system integrator which usually refers to the vendor of the smallest field-replaceable unit. ATU-R System Vendor ID may not be the same as ATU-R G.994.1 Vendor ID. For ADSL2, provides the Vendor ID as inserted by the ATU-R in the Overhead Messages. It is not available for ADSL. This is string of 8 octets containing 2 octet country code , 4 octet vendor id and 2 octet vendor revision number. |
| <b>ATU-R Self Test Result</b>   | Defines the ATU-R selftest result. The most significant octet is: 00 hex if the self-test passed or 01 hex if the self-test failed.<br><br>Interpretation of the other octets is vendor discretionary and can be interpreted in combination with G.994.1 and system Vendor IDs.   |
| <b>ATUR G9941 Vendor ID</b>     | Indicates the Vendor ID as inserted by the ATU-R in the G.994.1 CLR message.The G.994.1 Vendor ID typically identifies the  |

|                             |   |
|-----------------------------|---|
|                             | vendor of the ATU-R G.994.1 functionality. This is string of 8 octets containing 2 octet country code , 4 octet vendor id and 2 octet vendor revision number.   |
| <b>Atur ACTPSDs (dB/10)</b> | This parameter defines the average downstream transmit power spectrum density over the used subcarriers delivered by the ATU-C at the U-C reference point, at the instant of measurement. It's value ranges from -90 to 0, in 0.1 dB/Hz steps. It is available only for ADSL2/ADSL2plus.                                      |
| <b>BitSwapCount</b>         | This Conexant parameter indicates the bit swap count. It can read only in data mode   |
| <b>PSDMaskMode</b>          | This conexant parameter that indicates the actual PSD Mask currently being used by ATU-R  |
| <b>Gain Spsds</b>           | This parameter defines the downstream gains allocation table per bin. It is supported for ADSL2/ADSL2plus only.   |
| <b>Atur TSSpsds</b>         | This parameter provides the Downstream Transmit Spectrum Shaping parameter expressed as the set of break points exchanged during G994.1. Value of this parameter is in range 0 - 127, in multiples of -0.5 dB. 127 is a special value indicating the subcarrier is not transmitted. It is available only for ADSL2/ADSL2plus. |
| <b>Delt HLINSCds</b>        | The DELT-related parameter that provides the scale factor to be applied to the downstream Hlin (f) values. (Not available for ADSL and ADSL2plus)   |
| <b>Delt HLOGMTds</b>        | The DELT-related parameter that provides the number of symbols used to measure the downstream Hlog (f). (Not available for ADSL and ADSL2plus)  |
| <b>Delt QLNMtds</b>         | The DELT-related parameter that provides the number of symbols used to measure the downstream QLN (f) values. (Not available for ADSL and ADSL2plus)  |
| <b>DELT Last Tx State</b>   | The DELT-related parameter that provides the last successful transmitted initialization state by ATU-R. (Not available for ADSL and ADSL2plus)  |
| <b>Delt SnrmtDs</b>         | DELT-number of symbols to measure DS SNR  |
| <b>Delt HLINpsds</b>        | The DELT-related parameter that provides an array of complex downstream Hlin (f) values in linear scale. (Not available for ADSL and ADSL2plus)   |
| <b>Delt HLOGpsds</b>        | The DELT-related parameter that provides an array of real downstream Hlog (f) values in dB. (Not available for ADSL and ADSL2plus)  |
| <b>Delt QLNpsds</b>         | The DELT-related parameter that provides an array of real   |

|                          |   |
|--------------------------|---|
|                          | downstream QLN (f) values in dB. (Not available for ADSL and ADSL2plus)   |
| <b>DMT Bin SNR</b>       | The DELT-related parameter that provides an array of real downstream SNR (f) values in dB (Not available for ADSL and ADSL2plus)  |
| <b>Signal Atn(dB/10)</b> | DELT-related parameter that provides the downstream signal attenuation (length = 4 bytes). (Not available for ADSL and ADSL2plus).  |
| <b>AturDMTBinBits</b>    | Number of bits per bin for the bin indexed by this element of the string. The 0th element contains the number of bits for bin 0 through to the 255th element, which contains the number of bits for bin 255. The range of expected values is from 0 to 15 bits per bin (256 bytes for Annex A and Annex B, 512 bytes for G.Span/Adsl+, 1024 bytes for G.Span Plus). |

#### References:

- ADSL commands

## 5.9.19 ADSL ATUR Traps Commands

### 5.9.19.1 Get adsl atur traps

#### Description:

This command is used to get.

#### Command Syntax:

```
get adsl atur traps [ifname <interface-name>]
```

#### Parameters:

| Name                              | Description   |
|-----------------------------------|---|
| <b>ifname</b><br><interface-name> | The ADSL interface name.<br><b>Type</b> : Get – Mandatory<br><b>Valid values</b> : dsl-0 – dsl-23 |

#### Example:

```
$ get adsl atur traps ifname dsl-0
```



**Output:**

```

Ifname           : dsl-0
Lofs Thresh Trap : 1           Loss Thresh Trap : 1
Lprs Thresh Trap : 1           ESs Thresh Trap  : 0
Rate Change Trap : 0

```

**Output Fields:**

| FIELD            | Description   |
|------------------|---|
| Ifname           | The ADSL Interface Name                                 |
| Lofs Thresh Trap | Loss of Framing 15-minute interval threshold reached    |
| Loss Thresh Trap | Loss of Signal 15-minute interval threshold reached     |
| Lprs Thresh Trap | Loss of Power 15-minute interval threshold reached      |
| ESs Thresh Trap  | Errored Second 15-minute interval threshold reached     |
| Rate Change Trap | The ATU-Rs transmit rate has changed (RADSL mode only). |

**References**

- ADSL Commands

**5.9.20 ADSL ATUR Trapsext Commands****5.9.20.1 Get adsl atur trapsext****Description:**

Use this command to get.

**Command Syntax:**

```
get adsl atur trapsext [ifname <interface-name>]
```

**Parameters:**

| Name                       | Description  |
|----------------------------|--|
| ifname<br><interface-name> | The ADSL Interface Name<br><b>Type:</b> Get -- Optional<br><b>Valid values:</b> dsl-0 – dsl-23 |

**Example:**

```
$ get adsl atur trapsext ifname dsl-0
```

**Output:**

```

Ifname                : dsl-0
SesL Thresh 15Min Trap : 1          UasL Thresh 15Min Trap : 0
FecsL Thresh 15Min Trap: 0
Lofs Thresh 1Day Trap  : 1          Loss Thresh 1Day Trap  : 0
Lprs Thresh 1Day Trap  : 1          ESs Thresh 1Day Trap   : 1
SesL Thresh 1Day Trap  : 1          UasL Thresh 1Day Trap : 0
FecsL Thresh 1Day Trap : 0

```

**Output Fields:**

| FIELD                          | Description  |
|--------------------------------|--|
| <b>Ifname</b>                  | The ADSL Interface Name.   |
| <b>SesL Thresh 15Min Trap</b>  | Severely Error Seconds 15-minute interval threshold reached.           |
| <b>UasL Thresh 15Min Trap</b>  | Unavailable Error Seconds 15-minute interval threshold reached.        |
| <b>FecsL Thresh 15Min Trap</b> | Forward error correction Seconds 15-minute interval threshold reached. |
| <b>Lofs Thresh 1Day Trap</b>   | Loss of Frames 1-day interval threshold reached.                       |
| <b>Loss Thresh 1Day Trap</b>   | Loss of Signal 1-day interval threshold reached.                       |
| <b>Lprs Thresh 1Day Trap</b>   | Loss of Power 1-day interval threshold reached.                        |
| <b>ESs Thresh 1Day Trap</b>    | Error Seconds 1-day interval threshold reached.                        |
| <b>SesL Thresh 1Day Trap</b>   | Severely Error Seconds 1-day interval threshold reached.               |
| <b>UasL Thresh 1Day Trap</b>   | Unavailable Error Seconds 1-day interval threshold reached.            |
| <b>FecsL Thresh 1Day Trap</b>  | Forward error correction Seconds 1-day interval threshold reached.     |

**References:**

- ADSL Commands

## 5.9.21 ADSL Cap Commands

### 5.9.21.1 Get adsl cap

**Description:**

Use this command to view DSL transmission capability.

**Command Syntax:**

```
get adsl cap
```

**Parameters:**

None

**Example:**

```
$ get adsl cap
```

**Output:**

```
Tx Capability : q9921potsOverlapped q9921potsNonOverlapped
```

**Output Fields:**

| Field                | Description  |
|----------------------|--|
| <b>Tx Capability</b> | This bitmap specifies which all transmission modes, which the ATU-C is capable of supporting. Right now support for Annex A, Annex B, G.Span/ADSL+ and G.Span Plus is present. This value depends on the DSL PHY firmware present on Columbia MxU. |

**References:**

- create dsl system
- get dsl system

## 5.9.22 ADSL Line Intf Commands

### 5.9.22.1 Get adsl line intf

**Description:**

Use this command to view ADSL line configuration.

**Command Syntax:**

**get adsl line intf** [ifname <interface-name>]

### 5.9.22.2 Modify adsl line intf

**Description:**

Use this command to modify.

**Command Syntax:**

**modify adsl line intf ifname** <interface-name> [ **lineconfgsaction** startup | spectrumReverb | analogLb | digitalLb | atmLp | spectrumMedley | spectrumPilot | spectrumCMtpr | spectrumRMtpr | hybridLossTest | rcvLinearityTest | rcvFilterTest | rcvPowerPerBinTest | idleNoisePerBinTest | totalIdleNoiseTest | selt | shutdown | wakeup | AbortReq ] [ **linepmconfpmsf** L3ToL0StateForce | L0ToL2StateForce | L3StateForce | L2ToL0StateForce ] [ **linedeltconfldsf** inhibit | force ] [ **linetransatucconfig** ansit1413 | etsi | q9921PotsNonOverlapped | q9921PotsOverlapped | q9921IsdnNonOverlapped | q9921IsdnOverlapped | q9921tcmlsdnNonOverlapped | q9921tcmlsdnOverlapped | q9922potsNonOverlapped | q9922potsOverlapped | q9922tcmlsdnNonOverlapped | q9922tcmlsdnOverlapped | q9921tcmlsdnSymmetric | adslPlusPotsNonOverlapped | q9921GspanPlusPotsNonOverlapped | q9921GspanPlusPotsOverlapped | q9923Adsl2PotsOverlapped | q9923Adsl2PotsNonOverlapped | q9925Adsl2PlusPotsOverlapped | q9925Adsl2PlusPotsNonOverlapped | q9923Readsl2PotsOverlapped | q9923Readsl2PotsNonOverlapped | adslPlusPotsOverlapped | q9921GspanPlusPlusPotsNonOverlapped | q9921GspanPlusPlusPotsOverlapped | q9923IsdnNonOverlapped | q9923IsdnOverlapped | q9925IsdnNonOverlapped | q9925IsdnOverlapped | q9923AnnexMPotsExtUsNonOverlapped | q9923AnnexMPotsExtUsOverlapped | q9925AnnexMPotsExtUsNonOverlapped | q9925AnnexMPotsExtUsOverlapped ] [ **dsbinsnrupdate** Disable | Enable ] [ enable | disable ]

## Parameters:

| Name  | Description   |
|---|---|
| <b>ifname</b> <interface-name>  | The interface name of the DSL port.<br><b>Type:</b> Modify -- Mandatory<br>Get -- Optional<br><b>Valid values:</b> dsl-0 – dsl-23   |
| <b>lineconfgsaction</b> startup   spectrumReverb   analogLb   digitalLb   atmLp   spectrumMedley   spectrumPilot   spectrumCMtpr   spectrumRMtpr   hybridLossTest   rcvLinearityTest   rcvFilterTest   rcvPowerPerBinTest   idleNoisePerBinTest   totalIdleNoiseTest   selt   shutdown   wakeup   AbortReq  | Allows action on per-line basis.<br><b>Type:</b> Modify -- Optional   |
| <b>linepmconfpmsf</b> L3ToL0StateForce   L0ToL2StateForce   L3StateForce   L2ToL0StateForce   | PM-related parameter used by ATU-C to force a change in the line state. (Not available for ADSL/ADSL2Plus)<br><b>Type:</b> Modify -- Optional   |
| <b>linedeltconfldsf</b> inhibit   force   | The DELT-related parameter used by ATU-C to force the line into the loop diagnostics mode. (Not available for ADSL and ADSL2plus)<br><b>Type:</b> Modify -- Optional  |
| <b>linetransatucconfig</b> ansit1413   etsi   q9921PotsNonOverlapped   q9921PotsOverlapped   q9921IsdnNonOverlapped   q9921isdnOverlapped   q9921tcmlsdnNonOverlapped   q9921tcmlsdnOverlapped   q9922potsNonOverlapped   q9922potsOverlapped   q9922tcmlsdnNonOverlapped   q9922tcmlsdnOverlapped   q9921tcmlsdnSymmetric   adslPlusPotsNonOverlapped   q9921GspanPlusPotsNonOverlapped   q9921GspanPlusPotsOverlapped   q9923Adsl2PotsOverlapped   q9923Adsl2PotsNonOverlapped   q9925Adsl2PlusPotsOverlapped | The transmission modes that the ATU-C is capable of supporting. The modes available are limited by the design of the equipment. REFERENCE"Section 7.3.2 ITU G.997.1" (length = 4 bytes).<br><b>Type:</b> Modify -- Optional |

|   |  |
|---|--|
| q9925Adsl2PlusPotsNonOverlapped  <br>q9923Readsl2PotsOverlapped  <br>q9923Readsl2PotsNonOverlapped  <br>adslPlusPotsOverlapped  <br>q9921GspanPlusPlusPotsNonOverlapped  <br>q9921GspanPlusPlusPotsOverlapped  <br>q9923IsdnNonOverlapped  <br>q9923IsdnOverlapped  <br>q9925IsdnNonOverlapped  <br>q9925IsdnOverlapped  <br>q9923AnnexMPotsExtUsNonOverlapped  <br>q9923AnnexMPotsExtUsOverlapped  <br>q9925AnnexMPotsExtUsNonOverlapped  <br>q9925AnnexMPotsExtUsOverlapped |  |
| <b>dsbinsrupdate</b> Disable   Enable   | Conexant parameter to enable or disable collection of downstream SNR bin status<br><b>Type:</b> Modify -- Optional   |
| enable   disable  | Administrative status of the interface.<br><b>Type:</b> Create -- Optional<br>Modify -- Optional<br><b>Valid values:</b> enable, disable<br><b>Default value:</b> enable |

**Example:**

```
$ get adsl line intf ifname dsl-0
```

**Output:**

```

IfName                : dsl-0
Line Type              : noChannel          Coding Type           :
dmt
GsUtopia L2TxAddr     : 23                GsUtopia
L2RxAddr              : 10
GsUtopia L2RxAddr2nd : 11                GsUtopia
L2TxAddr2nd          : 11
Gs Clock Type         : oscillator        Gs Action             :
analoglb
Trans Atuc Cap        : ansit1413
Trans Atuc Actual     : q9921PotsNonOverlapped
Trans Atuc Config    : ansit1413
GsDmtTrellis         : trellisOn
Trans Atur Cap        : ansit1413

```

PM Conf PMSF : idleop  
 Line DELT Conf LDSF : inhibit  
 Curr Output Pwr(dBm/10) : 10 DS Bin SNR Update :  
 Enable  
 Bin Number SNR Margin/bin

-----  
 [ 0] 16

Oper Status : Up Admin Status :  
 Enable

### Output Fields:

| FIELD                | Description  |
|----------------------|--|
| IfName               | The interface name of the DSL port.  |
| Line Type            | Line type used by the DSL port.  |
| Coding Type          | Line coding type used by the port.   |
| GsUtopia L2TxAddr    | UTOPIA Level 2 Tx address for a line.  |
| GsUtopia L2RxAddr    | UTOPIA Level 2 Rx address.   |
| GsUtopia L2RxAddr2nd | Conexant parameter to set UTOPIA Level 2 Rx address for the secondary bearer channel in case of Dual Latency. (length = 4 bytes)   |
| GsUtopia L2TxAddr2nd | Conexant parameter to set UTOPIA Level 2 Tx address for the secondary bearer channel in case of Dual Latency. (length = 4 bytes)   |
| Gs Clock Type        | Indicates use of crystal or oscillator.  |
| Gs Action            | Allows action on per-line basis.   |
| Trans Atuc Cap       | Transmission modes that ATU-C is capable of.   |
| Trans Atuc Actual    | Transmission modes   |
| Trans Atuc Config    | The transmission modes that the ATU-C is capable of supporting. The modes available are limited by the design of the equipment. REFERENCE"Section 7.3.2 ITU G.997.1" (length = 4 bytes). |
| GsDmtTrellis         | Indicates whether trellis coding has been enabled or not.  |
| Trans Atur Cap       | The transmission modes that the ATU-R is capable of supporting. The modes available are limited by the design of the equipment (length = 4 bytes).                                       |
| PM Conf PMSF         | PM-related parameter used by ATU-C to force a change in the line state. (Not available for ADSL/ADSL2Plus)   |
| Line DELT Conf LDSF  | The DELT-related parameter used by ATU-C to force the line into the loop diagnostics mode. (Not available for ADSL and ADSL2plus)  |

|                                |   |
|--------------------------------|---|
| <b>Curr Output Pwr(dBm/10)</b> | This conexant parameter indicates the measure of total output power transmitted by this ATU. The value of this parameter is dynamic and will also show the change in Tx power due to Power Management. For example, the value will decrease in L2 low power mode. This value can be negative. |
| <b>DS Bin SNR Update</b>       | Conexant parameter to enable or disable collection of downstream SNR bin status   |
| <b>Bin SNR Margin(dB/10)</b>   | Bin SNR margin for particular sub carrier   |
| <b>Oper Status</b>             | The actual/current state of the interface. It can be either up or down.   |
| <b>Admin Status</b>            | The desired state of the interface. It may be either Up or Down.  |

## 5.9.23 ADSL Line Profile Commands

### 5.9.23.1 Get adsl line profile

**Description:**

Use this command to get.

**Command Syntax:**

**get adsl line profile [ifname <interface-name>]**

### 5.9.23.2 Modify adsl line profile

**Description:**

Use this command to modify.

**Command Syntax:**

**modify adsl line profile ifname <interface-name> [ atucrateadaptation fixed | adaptAtStartup | adaptAtRuntime ] [ gsparmtestinputfile <gsparmtestinputfile-val> ] [ atuctargetsnr <atuctargetsnr-val> ] [ atucmaxsnrmargin <atucmaxsnrmargin-val> ] [ atucgrsintcorrectionup 125us | 250us | 500us | 1ms | 2ms | 4ms | disable ] [ atucdnshiftsnrmargin <atucdnshiftsnrmargin-val> ] [ atucupshiftsnrmargin <atucupshiftsnrmargin-val> ] [ atucminupshifftime <atucminupshifftime-val> ] [ atucmindnshifftime <atucmindnshifftime-val> ] [ atucfastmintxrate <atucfastmintxrate-val> ] [ atucintlmintxrate <atucintlmintxrate-val> ] [ atucfastmaxtxrate <atucfastmaxtxrate-val> ] [ atucintlmaxtxrate <atucintlmaxtxrate-val> ] [ atucmaxintldelay <atucmaxintldelay-val> ] [ type noChannel | fastOnly | interleavedOnly | fastOrInterleaved | fastAndInterleaved ] [ atucgstxendbin <atucgstxendbin-val> ] [ atucgstxstartbin <atucgstxstartbin-val> ]**



**[ atucgsmaxbitsperbin <atucgsmaxbitsperbin-val> ] [ atucgsrxstartbin <atucgsrxstartbin-val> ] [ atucgsrxendbin <atucgsrxendbin-val> ]**  
**[ atucgsrxbinadjust disable ] [ atucgsltriggermode locCrc | rmtCrc | snrlnc | snrDec | disable ] [ atucgsadi2x standard ] [ atucgsinitiate waitPn | ctone | initiatePn ] [ atucgstxpoweratten 0 | point1 | point2 | point3 | point4 | point5 | point6 | point7 | point8 | point9 | 1 | 2 | 3 | 4 | 5 | 6 | 7 | 8 | 9 | 10 | 11 | 12 | 13 | 14 | 15 | 16 | 17 | 18 | 19 | 20 | 21 | 22 | 23 | 24 | 25 | 26 | 27 | 28 | 29 | 30 | 31 | 32 | 33 | 34 | 35 | 36 | 37 | 38 | 39 | 40 ] [ atucgscodinggain Auto | 0 | 1 | 2 | 3 | 4 | 5 | 6 | 7 | 256 ] [ atucgsrsfastovrhddn 50 | 25 | 12 | 6 | 3 | 1 | Disable ] [ atucgsrsintcorrectiondn 125Us | 250Us | 500Us | 1Ms | 2Ms | 4Ms | Disable ] [ atucgsrsfastovrhdup 50 | 25 | 12 | 6 | 3 | 1 | Disable ] [ atucgsdrstby Disable | Enable ] [ atucgsexpexch Expanded | Short ] [ atucgsescfastretrain Enable | Disable ] [ atucgsfastretrain Enable | Disable ] [ atucgsbitswap Disable | Enable ] [ atucgsntr LocalOcs | Refck8K ] [ atucgsalctlusver Unknown ] [ atucgsusecustombin Enable | Disable ] [ atucgsdnbinusage <atucgsdnbinusage-val> ] [ atucgsmaxdco 64 | 128 | 256 | 511 ] [ atucgsfullretrain Enable | Disable ] [ atucgspsdmasktype CoMsk2 | FlatMsk | CabMsk2 | CoMsk2Rfi | FlatMskRfi | CabMsk2Rfi | CoMsk2Rfi0 | Adsl2NonovlpM1 | Adsl2NonovlpM2 | Adsl2NonovlpFlat ] [ atucgseraseprofs enable | disable ] [ atucgsextrsmemory notpresent | present ] [ paramhybridlossteststart <paramhybridlossteststart-val> ] [ paramhybridlosstestend <paramhybridlosstestend-val> ] [ dmttrellis on | off ] [ aturtargetsnrmargin <aturtargetsnrmargin-val> ] [ aturdnshiftsnrmargin <aturdnshiftsnrmargin-val> ] [ aturupshiftsnrmargin <aturupshiftsnrmargin-val> ] [ aturminupshifttime <aturminupshifttime-val> ] [ aturmindnshifttime <aturmindnshifttime-val> ] [ aturfastmintxrate <aturfastmintxrate-val> ] [ aturintlmintxrate <aturintlmintxrate-val> ] [ aturfastmaxtxrate <aturfastmaxtxrate-val> ] [ aturintlmaxtxrate <aturintlmaxtxrate-val> ] [ aturmaxintldelay <aturmaxintldelay-val> ] [ databoost Enable | Disable ] [ upstreampsd Extended | Standard | Jj100 ] [ atucconfpmmode pmstatal3enable | pmstatal2enable | disable ] [ atucconfpml0time <atucconfpml0time-val> ] [ atucconfpml2time <atucconfpml2time-val> ] [ atucconfpml2atpr <atucconfpml2atpr-val> ] [ atucconfpml2minrate <atucconfpml2minrate-val> ] [ atucconfmsgminds <atucconfmsgminds-val> ] [ aturconfmsgminus <aturconfmsgminus-val> ] [ atucminsrmgn <atucminsrmgn-val> ] [ aturminsrmgn <aturminsrmgn-val> ] [ atucfrontenddesigntype E11508 | E11528 | Le87213 ] [ atuchwppwrreduction Disable | Enable ] [ atucgsusbitswap Disable | Enable ] [ aturmaxsnrmgn <aturmaxsnrmgn-val> ] [ atucconfmininp Inp0 | InpPoint5 | Inp1 | Inp2 | InpAuto | Inp4 | Inp8 | Inp16 ] [ atucpml2entrythreshrate atucpml2entrythreshrate ] [ atucpml2exitthreshrate <atucpml2exitthreshrate-val> ] [ atucpml2entryratemintime**

<atucpml2entryratemintime-val> ] [ **atucgscabinethsenable** Disable | Enable ]  
 [ **atucgsseltlooptype** RealCable | Dls90 | Dls400 ] [ **atucgsrxstartbinu1**  
 <atucgsrxstartbinu1-val> ] [ **atucgsrxendbinu1** <atucgsrxendbinu1-val> ]  
 [ **gpspsdmaskdsenable** PsdMaskDisable | PsdMaskEnable | PsdMaskEnableMod ]  
 [ **gpspsdmaskusenable** PsdMaskDisable | PsdMaskEnable | PsdMaskEnableMod ]  
 [ **psdmaskdsfallbackenable** False | True ] [ **psdmaskusfallbackenable** False |  
 True ] [ **atucconfmaxnompsdds** <atucconfmaxnompsdds-val> ]  
 [ **aturconfmaxnompsdus** <aturconfmaxnompsdus-val> ]  
 [ **atucconfmaxnomatpds** <atucconfmaxnomatpds-val> ]  
 [ **aturconfmaxnomatpus** <aturconfmaxnomatpus-val> ] [ **atucconfpsdmaskds**  
 <atucconfpsdmaskds-val> ] [ **aturconfpsdmaskus** <aturconfpsdmaskus-val> ]  
 [ **aturratemode** fixed | adaptAtStartup | adaptAtRuntime ] [ **aturconfmininp** Inp0 |  
 InpPoint5 | Inp1 | Inp2 | InpAuto | Inp4 | Inp8 | Inp16 ] [ **gsannexcoltocxswitch**  
 CxSwitch19DB | CxSwitch20DB | CxSwitch21DB | CxSwitch22DB | CxSwitch23DB  
 | CxSwitch24DB | CxSwitch25DB | CxSwitch26DB | CxSwitch27DB |  
 CxSwitch28DB | CxSwitch29DB | CxSwitch30DB ] [ **atucconfgsannexcswitch**  
 Gspan19DB | Gspan20DB | Gspan21DB | Gspan22DB | Gspan23DB |  
 Gspan24DB | Gspan25DB | GspanPlus7DB | GspanPlus8DB | GspanPlus9DB |  
 GspanPlus10DB | GspanPlus11DB | GspanPlus12DB | GspanPlus13DB |  
 GspanPlus14DB | GspanPlus15DB ] [ **gsannexctouqswitch** CUqSwitch6DB |  
 CUqSwitch6\_5DB | CUqSwitch7DB | CUqSwitch8DB | CUqSwitch9DB |  
 CUqSwitch10DB | CUqSwitch11DB | CUqSwitch12DB | CUqSwitch13DB |  
 CUqSwitch14DB | CUqSwitch15DB ] [ **atucminsrmgntime**  
 <atucminsrmgntime-val> ] [ **atucustomerid** WorldWide | France | China |  
 Portugal ] [ **atucmpsdmasktype** Adsl2MEu64 | Adsl2MEu60 | Adsl2MEu56 |  
 Adsl2MEu52 | Adsl2MEu48 | Adsl2MEu44 | Adsl2MEu40 | Adsl2MEu36 |  
 Adsl2MEu32 | Adsl2MAI ] [ **atucgsseltloopgauge** 26awg | 24awg ]  
 [ **atucconfrateratio** <atucconfrateratio-val> ]

### Parameters:

| Name  | Description   |
|---|---|
| <b>ifname</b> <interface-name>  | The ADSL line interface name, whose profile is to be modified or viewed<br><b>Type:</b> Modify – Mandatory<br>Get – Optional  |
| <b>atucrateadaptation</b> fixed  <br>adaptAtStartup  <br>adaptAtRuntime | Defines what form of transmit rate adaptation is configured on this<br>modem. Refer to ADSL Forum TR-005 for more information.<br><b>Type:</b> Modify -- Optional                 |
| <b>gsparamtestinputfile</b><br><gsparamtestinputfile-val>               | Indicates Name of the Input file from which to take the Mask Array Size,<br>lower and upper mask Array. Null string means no file is specified<br><b>Type:</b> Modify -- Optional |

|  |  |
|--|--|
| <b>atuctargetsnr</b><br><atuctargetsnr-val>  | Configured Target Signal/Noise Margin. This is the Noise Margin the modem must achieve with a BER of 10 to the power -7, or better, to successfully complete initialization.<br><b>Type:</b> Modify -- Optional<br><b>Valid values:</b> 0 - 310  |
| <b>atucmaxsnrmargin</b><br><atucmaxsnrmargin-val>                                      | Configured Maximum acceptable Signal/Noise Margin. If the Noise Margin is above this, the modem should attempt to reduce its power output to optimize its operation.<br><b>Type:</b> Modify -- Optional<br><b>Valid values:</b> 0 - 310  |
| <b>atucgrrsintcorrectionup</b><br>125us   250us   500us   1ms  <br>2ms   4ms   disable | Sets the correction time for the upstream interleaved buffer. RS can also be disabled.<br><b>Type:</b> Modify -- Optional  |
| <b>atucdnshiftsnrmargin</b><br><atucdnshiftsnrmargin-val>                              | Configured Signal/Noise Margin for rate downshift. If the noise margin falls below this level, the modem should attempt to decrease its transmit rate. In the case that RADSL mode is not present, the value will be 0.<br><b>Type:</b> Modify -- Optional<br><b>Valid values:</b> 0 - 310 |
| <b>atucupshiftsnrmargin</b><br><atucupshiftsnrmargin-val>                              | Configured Signal/Noise Margin for rate upshift. If the noise margin rises above this level, the modem should attempt to increase its transmit rate. In the case that RADSL is not present, the value will be 0.<br><b>Type:</b> Modify -- Optional<br><b>Valid values:</b> 0 - 310        |
| <b>atucminupshifttime</b><br><atucminupshifttime-val>                                  | Minimum time that the current margin is above UpshiftSnrMgn before an upshift occurs. In the case that RADSL is not present, the value will be 0.<br><b>Type:</b> Modify -- Optional<br><b>Valid values:</b> 0 - 16383   |
| <b>atucmindnshifttime</b><br><atucmindnshifttime-val>                                  | Minimum time that the current margin is above UpshiftSnrMgn before an upshift occurs. In the case that RADSL is not present, the value will be 0.<br><b>Type:</b> Modify -- Optional<br><b>Valid values:</b> 0 - 16383   |
| <b>atucfastmintxrate</b><br><atucfastmintxrate-val>                                    | Configured Minimum Transmit rate for 'Fast' channels, in bps. Also refer to 'adslAtucConfRateChanRatio' for information regarding RADSL mode and refer to ATU-R transmit rate for ATU-C receive rates.<br><b>Type:</b> Modify -- Optional<br><b>Valid values:</b> 0 - 0xffffffff           |
| <b>atucintlmintxrate</b>   | Configured Minimum Transmit rate for 'Interleave' channels, in bps.  |

|  |   |
|--|---|
| <atucintlmintxrate-val>  | <p>Also refer to 'adslAtucConfRateChanRatio' for information regarding RADSL mode and refer to ATU-R transmit rate for ATU-C receive rates.</p> <p><b>Type:</b> Modify -- Optional</p> <p><b>Valid values:</b> 0 - 0xffffffff</p>   |
| <p><b>atucfastmaxtxrate</b></p> <p>&lt;atucfastmaxtxrate-val&gt;</p>                               | <p>Configured Maximum Transmit rate for 'Fast' channels, in bps. Also refer to 'adslAtucConfRateChanRatio' for information regarding RADSL mode and ATU-R transmit rate for ATU-C receive rates.</p> <p><b>Type:</b> Modify -- Optional</p> <p><b>Valid values:</b> 0 - 0xffffffff</p>  |
| <p><b>atucintlmmaxtxrate</b></p> <p>&lt;atucintlmmaxtxrate-val&gt;</p>                             | <p>Configured Maximum Transmit rate for 'Interleave' channels, in bps. Also refer to 'adslAtucConfRateChanRatio' for information regarding RADSL mode and ATU-R transmit rate for ATU-C receive rates.</p> <p><b>Type:</b> Modify -- Optional</p> <p><b>Valid values:</b> 0 - 0xffffffff</p>  |
| <p><b>atucmaxintldelay</b></p> <p>&lt;atucmaxintldelay-val&gt;</p>                                 | <p>Configured maximum Interleave Delay for this channel. Interleave delay applies only to the interleave channel and defines the mapping (relative spacing) between subsequent input bytes at the interleaver input and their placement in the bit stream at the interleaver output. Larger numbers provide greater separation between consecutive input bytes in the output bit stream, allowing for improved impulse noise immunity at the expense of payload latency.</p> <p><b>Type:</b> Modify -- Optional</p> <p><b>Valid values:</b> 0 - 255</p> |
| <p><b>type</b> noChannel   fastOnly   interleavedOnly   fastOrInterleaved   fastAndInterleaved</p> | <p>This object is used to configure the ADSL physical line mode.</p> <p><b>Type:</b> Modify -- Optional</p>   |
| <p><b>atucgstxendbin</b></p> <p>&lt;atucgstxendbin-val&gt;</p>                                     | <p>The highest bin number allowed for Tx signal.</p> <p><b>Type:</b> Modify -- Optional</p> <p><b>Valid values:</b> 0x06 - 0xff</p>   |
| <p><b>atucgstxstartbin</b></p> <p>&lt;atucgstxstartbin-val&gt;</p>                                 | <p>The lowest bin number allowed for Tx signal.</p> <p><b>Type:</b> Modify -- Optional</p> <p><b>Valid values:</b> 0x06 - 0xff</p>  |
| <p><b>atucgsmaxbitsperbin</b></p> <p>&lt;atucgsmaxbitsperbin-val&gt;</p>                           | <p>The maximum Rx number of bits per bin.</p> <p><b>Type:</b> Modify -- Optional</p> <p><b>Valid values:</b> 0 - 15</p>   |
| <p><b>atucgrxstartbin</b></p> <p>&lt;atucgrxstartbin-val&gt;</p>                                   | <p>The lowest bin number allowed for Rx signal.</p> <p><b>Type:</b> Modify -- Optional</p> <p><b>Valid values:</b> 0x01 - 0x1ff</p>   |
| <p><b>atucgrxendbin</b></p>  | <p>The highest bin number allowed for Rx signal.</p>  |

|   |  |
|---|--|
| <atucgsrxendbin-val>  | <b>Type:</b> Modify -- Optional<br><b>Valid values:</b> 0x06 - 0x1ff   |
| <b>atucgsrxbinadjust</b> disable  | This parameter employs Rx Start/End bin settings<br><b>Type:</b> Modify -- Optional  |
| <b>atucgsltriggermode</b> locCrc   rmtCrc   snrInc   snrDec   disable   | The type of event that triggers a fast retrain<br><b>Type:</b> Modify -- Optional  |
| <b>atucgsadi2x</b> standard   | For non-standard compliant ADI CPE<br><b>Type:</b> Modify -- Optional  |
| <b>atucgsinitiate</b> waitPn   ctone   initiatePn   | Specifies which end initiates startup. It is also used to send a C-tone to the remote unit.<br><b>Type:</b> Modify -- Optional             |
| <b>atucgstxpoweratten</b> 0   point1   point2   point3   point4   point5   point6   point7   point8   point9   1   2   3   4   5   6   7   8   9   10   11   12   13   14   15   16   17   18   19   20   21   22   23   24   25   26   27   28   29   30   31   32   33   34   35   36   37   38   39   40 | The value in dB of Tx power attenuation<br><b>Type:</b> Modify -- Optional   |
| <b>atucgscodinggain</b> Auto   0   1   2   3   4   5   6   7   256  | Sets the coding gain in dB increments<br><b>Type:</b> Modify -- Optional   |
| <b>atucgsrsfastovrhddn</b> 50   25   12   6   3   1   Disable   | This parameter sets the percentage overhead for the downstream fast buffer. RS can also be disabled.<br><b>Type:</b> Modify -- Optional    |
| <b>atucgsrsintcorrectiondn</b> 125Us   250Us   500Us   1Ms   2Ms   4Ms   Disable  | This parameter sets the correction time for the downstream interleaved buffer. RS can also be disabled.<br><b>Type:</b> Modify -- Optional |
| <b>atucgsrsfastovrhdup</b> 50   25   12   6   3   1   Disable   | This parameter sets the percentage overhead for the upstream fast buffer. RS can also be disabled.<br><b>Type:</b> Modify -- Optional      |
| <b>atucgsdrstby</b> Disable   Enable  | This parameter provides the ability to disable power to the line driver<br><b>Type:</b> Modify -- Optional                                 |
| <b>atucgsexpexch</b> Expanded   Short   | T1.413 parameter that Enables/Disables EES<br><b>Type:</b> Modify -- Optional  |
| <b>atucgsescfastretrain</b> Enable   Disable  | This parameter enables/disables escape to the fast retrain capability<br><b>Type:</b> Modify -- Optional                                   |
| <b>atucgsfastretrain</b> Enable   Disable   | This parameter enables/disables the fast retrain capability. Currently supported only in G.lite mode.                                      |

|  |   |
|--|---|
|  | <b>Type:</b> Modify -- Optional   |
| <b>atucgsbitswap</b> Disable   Enable  | This parameter enables/disables bit swapping<br><b>Type:</b> Modify -- Optional   |
| <b>atucgsntr</b> LocalOcs   Refck8K  | This parameter enables/disables NTR on a per chip basis<br><b>Type:</b> Modify -- Optional  |
| <b>atucgsalctlusver</b> Unknown  | For T1.413 demo purposes only<br><b>Type:</b> Modify -- Optional  |
| <b>atucgsusecustombin</b> Enable   Disable   | This parameter enables/disables user selection which of the 511 bins will be enabled for upstream and downstream transmission.<br><b>Type:</b> Modify -- Optional   |
| <b>atucgsdnbinusage</b><br><atucgsdnbinusage-val>  | '1' in bit position indicates usage of corresponding bin, whereas a '0' disables usage of corresponding bin.<br><b>Type:</b> Modify -- Optional   |
| <b>atucgsmaxdco</b> 64   128   256   511   | Maximum interleaving depth supported by the customer's hardware<br><b>Type:</b> Modify -- Optional  |
| <b>atucgsfullretrain</b> Enable   Disable  | Indicates enable/disable of auto retrain capability<br><b>Type:</b> Modify -- Optional  |
| <b>atucgspsdmasktype</b><br>CoMsk2   FlatMsk   CabMsk2   CoMsk2Rfi   FlatMskRfi   CabMsk2Rfi   CoMsk2Rfi0   Adsl2NonovlpM1   Adsl2NonovlpM2   Adsl2NonovlpFlat | This parameter selects the PSD mask option to be used<br><b>Type:</b> Modify -- Optional  |
| <b>atucgseraseprofs</b> enable   disable   | This parameter enables/disables the ability to erase all fast retrain profiles at startup<br><b>Type:</b> Modify -- Optional  |
| <b>atucgsextrsmemory</b><br>notpresent   present   | Indicates whether customer's Hardware uses external RS RAM<br><b>Type:</b> Modify -- Optional   |
| <b>paramhybridlossteststart</b><br><paramhybridlossteststart-val>  | Start bin for range of bins to be measured. The default value mentioned is an indicative value only, for exact value refer to document number DO-400523-AN and DO-401163-AN.<br><b>Type:</b> Modify -- Optional<br><b>Valid values:</b> 0x0 - 0x1ff |
| <b>paramhybridlosstestend</b><br><paramhybridlosstestend-val>  | End bin for range of bins to be measured.<br><b>Type:</b> Modify -- Optional<br><b>Valid values:</b> 0x0 - 0x1ff  |
| <b>dmntrellis</b> on   off   | This parameter enables/disables trellis coding. Trellis coding should always be enabled for its clear performance advantage.<br><b>Type:</b> Modify -- Optional   |

|   |   |
|---|---|
| <b>aturtargetsnrmargin</b><br><aturtargetsnrmargin-val>   | <p>Noise Margin the modem must achieve with a BER of 10<sup>-7</sup> to the power 7 or better to successfully complete initialization</p> <p><b>Type:</b> Modify -- Optional</p> <p><b>Valid values:</b> 0 - 0xffffffff</p>   |
| <b>aturdnshiftsnrmargin</b><br><aturdnshiftsnrmargin-val> | <p>Configured Signal/ Noise Margin for rate downshift. If the noise margin falls below this level, the modem should attempt to decrease its transmit rate. In the case that RADSL mode is not present, the value will be 0.</p> <p><b>Type:</b> Modify -- Optional</p> <p><b>Valid values:</b> 0 - 0xffffffff</p> |
| <b>aturupshiftsnrmargin</b><br><aturupshiftsnrmargin-val> | <p>Configured Signal/ Noise Margin for rate upshift. If the noise margin rises above this level, the modem should attempt to increase its transmit rate. In the case that RADSL is not present, the value will be 0.</p> <p><b>Type:</b> Modify -- Optional</p> <p><b>Valid values:</b> 0 - 0xffffffff</p>        |
| <b>aturminupshifttime</b><br><aturminupshifttime-val>     | <p>Minimum time that the current margin is above UpshiftSnrMgn, before an upshift occurs. In the case that RADSL is not present, the value will be 0.</p> <p><b>Type:</b> Modify -- Optional</p> <p><b>Valid values:</b> 0 - 0xffffffff</p>   |
| <b>aturmindnshifttime</b><br><aturmindnshifttime-val>     | <p>Minimum time that the current margin is below DownshiftSnrMgn, before a downshift occurs. In the case that RADSL mode is not present, the value will be 0.</p> <p><b>Type:</b> Modify -- Optional</p> <p><b>Valid values:</b> 0 - 0xffffffff</p>   |
| <b>aturfastmintxrate</b><br><aturfastmintxrate-val>       | <p>Configured Minimum Transmit rate for 'Fast' channels, in bps. Also refer to 'adslAturConfRateChanRatio' for information regarding RADSL mode and ATU-C transmit rate for ATU-R receive rates.</p> <p><b>Type:</b> Modify -- Optional</p> <p><b>Valid values:</b> 0 - 0xffffffff</p>                            |
| <b>aturintlmintxrate</b><br><aturintlmintxrate-val>       | <p>Configured Minimum Transmit rate for 'Interleave' channels, in bps. Also refer to 'adslAturConfRateChanRatio' for information regarding RADSL mode and to ATU-C transmit rate for ATUR receive rates.</p> <p><b>Type:</b> Modify -- Optional</p> <p><b>Valid values:</b> 0 - 0xffffffff</p>                    |
| <b>aturfastmaxtxrate</b><br><aturfastmaxtxrate-val>       | <p>Configured Maximum Transmit rate for 'Fast' channels, in bps. Also refer to 'adslAturConfRateChanRatio' for information regarding RADSL mode and to ATU-C transmit rate for ATUR receive rates.</p> <p><b>Type:</b> Modify -- Optional</p> <p><b>Valid values:</b> 0 - 0xffffffff</p>                          |

|  |   |
|--|---|
| <p><b>aturintlmaxtxrate</b><br/>&lt;aturintlmaxtxrate-val&gt;</p>            | <p>Configured Maximum Transmit rate for 'Interleave' channels, in bps. Also refer to 'adslAturConfRateChanRatio' for information regarding RADSL mode and to ATU-C transmit rate for ATU-R receive rates.</p> <p><b>Type:</b> Modify -- Optional</p> <p><b>Valid values:</b> 0 - 0xffffffff</p>   |
| <p><b>aturmaxintldelay</b><br/>&lt;aturmaxintldelay-val&gt;</p>              | <p>Configured maximum Interleave Delay for this channel. Interleave delay applies only to the interleave channel and defines the mapping (relative spacing) between subsequent input bytes at the interleaver input and their placement in the bit stream at the interleaver output. Larger numbers provide greater separation between consecutive input bytes in the output bit stream, allowing for improved impulse noise immunity at the expense of payload latency</p> <p><b>Type:</b> Modify -- Optional</p> <p><b>Valid values:</b> 0 - 0xffffffff</p> |
| <p><b>databoost</b> Enable   Disable</p>                                     | <p>Conexant parameter that enables/disables DataBoost option.</p> <p><b>Type:</b> Modify -- Optional</p>  |
| <p><b>upstreampsd</b> Extended   Standard   Jj100</p>                        | <p>Conexant parameter that sets the upstream PSD to be either extended or standard. Used for GSpan Plus only.</p> <p><b>Type:</b> Modify -- Optional</p>  |
| <p><b>atucconfpmmode</b><br/>pmstatal3enable   pmstatal2enable   disable</p> | <p>PM-related parameter used by the ATU-C to set the allowed link states. Both bit values can be given simultaneously in the input. Additional value to disable pmmode is disable, which is equal to 0.</p> <p><b>Type:</b> Modify -- Optional</p>  |
| <p><b>atucconfpml0time</b><br/>&lt;atucconfpml0time-val&gt;</p>              | <p>PM configuration parameter, related to the L2 low power state. This parameter represents the minimum time (in seconds) between an exit from the L2 state and the next entry into the L2 state. It ranges from 0 to 255 seconds.</p> <p><b>Type:</b> Modify -- Optional</p> <p><b>Valid values:</b> 0 - 255</p>   |
| <p><b>atucconfpml2time</b><br/>&lt;atucconfpml2time-val&gt;</p>              | <p>PM configuration parameter, related to the L2 low power state. This parameter represents the minimum time (in seconds) between an Entry into the L2 state and the first Power Trim in the L2 state and between two consecutive Power Trims in the L2 State. It ranges from 0 to 255 seconds.</p> <p><b>Type:</b> Modify -- Optional</p> <p><b>Valid values:</b> 0 - 255</p>  |
| <p><b>atucconfpml2atpr</b><br/>&lt;atucconfpml2atpr-val&gt;</p>              | <p>PM configuration parameter, related to the L2 low power state. This parameter represents the maximum aggregate transmit power reduction (in dB) that can be performed through a single Power Trim in the L2 state. It ranges from 0 dB/10 to 310 dB/10.</p>  |



|  |   |
|--|---|
|  | <p><b>Type:</b> Modify -- Optional</p> <p><b>Valid values:</b> 0 - 310</p>  |
| <p><b>atucconfpml2minrate</b></p> <p>&lt;atucconfpml2minrate-val&gt;</p> | <p>PM configuration parameter, related to the L2 low power state. This parameter specifies the minimum net data rate during the low power state (L2). The data rate is coded in bit/s, and can range from 0x1F40 (8000) bps to 0xFA000 (1024000) bps.</p> <p><b>Type:</b> Modify -- Optional</p> <p><b>Valid values:</b> 0x1F40 - 0xFA000</p> |
| <p><b>atucconfmsgminds</b></p> <p>&lt;atucconfmsgminds-val&gt;</p>       | <p>Configures downstream overhead channel bandwidth. This feature is not supported by DSLPHY as yet.</p> <p><b>Type:</b> Modify -- Optional</p> <p><b>Valid values:</b> 4000 - 64000</p>  |
| <p><b>aturconfmsgminus</b></p> <p>&lt;aturconfmsgminus-val&gt;</p>       | <p>Configures upstream overhead channel bandwidth. This feature is not supported by DSLPHY as yet.</p> <p><b>Type:</b> Modify -- Optional</p> <p><b>Valid values:</b> 4000 - 64000</p>  |
| <p><b>atucminsnrmgm</b></p> <p>&lt;atucminsnrmgm-val&gt;</p>             | <p>Atuc Configured Minimum Signal/Noise Margin. This is the Noise Margin, the modem must achieve with a BER of 10 to the power -7 or better, to successfully complete initialization. The default value mentioned is an indicative value only.</p> <p><b>Type:</b> Modify -- Optional</p> <p><b>Valid values:</b> 0 - 310</p>                 |
| <p><b>aturminsnrmgm</b></p> <p>&lt;aturminsnrmgm-val&gt;</p>             | <p>Atuc Configured Minimum Signal/Noise Margin. This is the Noise Margin, the modem must achieve with a BER of 10 to the power -7 or better, to successfully complete initialization. The default value mentioned is an indicative value only.</p> <p><b>Type:</b> Modify -- Optional</p> <p><b>Valid values:</b> 0 - 310</p>                 |
| <p><b>atucfrontenddesigntype</b></p> <p>E11508   E11528   Le87213</p>    | <p>Front end hardware reference design</p> <p><b>Type:</b> Modify -- Optional</p>   |
| <p><b>atuchwppwrreduction</b> Disable   Enable</p>                       | <p>Hardware configuration parameter</p> <p><b>Type:</b> Modify -- Optional</p>  |
| <p><b>atucgsusbitswap</b> Disable   Enable</p>                           | <p>This parameter enables/disables upstream bit swapping</p> <p><b>Type:</b> Modify -- Optional</p>   |
| <p><b>aturmaxsnrmgn</b></p> <p>&lt;aturmaxsnrmgn-val&gt;</p>             | <p>Configured Maximum acceptable downstream Signal/Noise Margin. If the Noise Margin is above this the modem attempts to reduce its power output to optimize its operation. The value set by the user is in dB/10, and ranges from 0 to 31 dB in 1 dB steps.</p> <p><b>Type:</b> Modify -- Optional</p> <p><b>Valid values:</b> 0 - 310</p>   |

|  |  |
|--|--|
| <b>atucconfmininp</b> Inp0   InpPoint5   Inp1   Inp2   InpAuto   Inp4   Inp8   Inp16 | Parameter used to specify the minimum impulse noise protection for the downstream bearer channel.<br><b>Type:</b> Modify -- Optional   |
| <b>atucpml2entrythresrate</b><br><atucpml2entrythresrate-val>                        | PM config param. L2 state entry data rate.<br><b>Type:</b> Modify -- Optional<br><b>Valid values:</b> 0 - 0xffffffff   |
| <b>atucpml2exitthresrate</b><br><atucpml2exitthresrate-val>                          | PM config param. L2 state exit data rate.<br><b>Type:</b> Modify -- Optional<br><b>Valid values:</b> 0 - 0xffffffff  |
| <b>atucpml2entryratemintime</b><br><atucpml2entryratemintime-val>                    | PM config param.Min L2 entry rate time<br><b>Type:</b> Modify -- Optional<br><b>Valid values:</b> 900 - 65535  |
| <b>atucgscabinethsenable</b><br>Disable   Enable                                     | Enable/Disable HS tones in Cabinet mode<br><b>Type:</b> Modify -- Optional   |
| <b>atucgsseltlooptype</b><br>RealCable   Dis90   Dis400                              | Conexant parameter that is used to specify the loop type for SELT. The default value mentioned is an indicative value only.<br><b>Type:</b> Modify -- Optional   |
| <b>atucgsrxstartbinu1</b><br><atucgsrxstartbinu1-val>                                | Conexant parameter that specifies lowest bin number allowed for Rx signal in G.Span Plus SUQ mode. By selecting the receive start and end bin numbers, the user can limit the bins for special configurations.(length = 4 bytes)<br><b>Type:</b> Modify -- Optional  |
| <b>atucgsrxendbinu1</b><br><atucgsrxendbinu1-val>                                    | Conexant parameter that specifies highest bin number allowed for Rx signal in G.Span Plus SUQ mode. By selecting the receive start and end bin numbers, the user can limit the bins for special configurations.(length = 4 bytes)<br><b>Type:</b> Modify -- Optional |
| <b>gspsdmaskdsenable</b><br>PsdMaskDisable   PsdMaskEnable   PsdMaskEnableMod        | Conexant parameter that is used to configure the switching point between DBM-OL and XOL.(length = 4 bytes)<br><b>Type:</b> Modify -- Optional  |
| <b>gspsdmaskusenable</b><br>PsdMaskDisable   PsdMaskEnable   PsdMaskEnableMod        | Conexant parameter used to enable the Mask on Demand(MoD) feature in the upstream direction. It is available only for ADSL2 Annex A ONLY.(length = 4 bytes)<br><b>Type:</b> Modify -- Optional   |
| <b>psdmaskdsfallbackenable</b><br>False   True                                       | Conexant parameter used to enable Mask on Demand (MoD) fallback mode. When enabled, the system chooses MoD or the base ADSL2 depending upon the downstream rate. It is available only for ADSL2 Annex A.(length = 4 bytes)<br><b>Type:</b> Modify -- Optional        |

|   |  |
|---|--|
|   | <b>Valid values:</b> False, True   |
| <b>psdmaskusfallbackenable</b><br>False   True          | Conexant parameter used to enable Mask on Demand (MoD) fallback mode. When enabled, the system chooses MoD or the base ADSL2 depending upon the upstream rate. It is available only for ADSL2 Annex A.(length = 4 bytes)<br><b>Type:</b> Modify -- Optional<br><b>Valid values:</b> False, True  |
| <b>atucconfmaxnompsdds</b><br><atucconfmaxnompsdds-val> | This parameter specifies the maximum nominal transmit PSD(MAXNOMPSD) level during initialization and showtime. Value depends on CO MIB element settings and near end transmitter capabilities and is exchanged in the G.994.1 Phase. It is available only for ADSL2/ADSL2plus. Value ranges from -60 to -40 in steps of 0.1 dBm/Hz.(length = 4 bytes)<br><b>Type:</b> Modify -- Optional<br><b>Valid values:</b> (-600) - (-400) |
| <b>aturconfmaxnompsdus</b><br><aturconfmaxnompsdus-val> | This parameter specifies the maximum nominal transmit PSD(MAXNOMPSD) level during initialization and showtime. Value depends on CO MIB element settings and near end transmitter capabilities and is exchanged in the G.994.1 Phase. It is available only for ADSL2/ADSL2plus. Value ranges from -60 to -38 in steps of 0.1 dBm/Hz.(length = 4 bytes)<br><b>Type:</b> Modify -- Optional<br><b>Valid values:</b> (-600) - (-380) |
| <b>atucconfmaxnomatpds</b><br><atucconfmaxnomatpds-val> | This parameter specifies the maximum nominal aggregate transmit power(MAXNOMATP) level during initialization and showtime. Value depends on CO MIB element settings and local capabilities and is exchanged in the G.994.1 Phase. It is available only for ADSL2/ADSL2plus. Value ranges from 0 to 25.5 in steps of 0.1 dBm.(length = 4 bytes)<br><b>Type:</b> Modify -- Optional<br><b>Valid values:</b> 0 - 255                |
| <b>aturconfmaxnomatpus</b><br><aturconfmaxnomatpus-val> | This parameter specifies the maximum nominal aggregate transmit power(MAXNOMATP) level during initialization and showtime. Value depends on CO MIB element settings and local capabilities and is exchanged in the G.994.1 Phase. It is available only for ADSL2/ADSL2plus. Value ranges from 0 to 25.5 in steps of 0.1 dBm.(length = 4 bytes)<br><b>Type:</b> Modify -- Optional<br><b>Valid values:</b> 0 - 255                |
| <b>atucconfpsdmaskds</b>                                | This configuration parameter defines that the downstream PSD mask  |

|   |  |
|---|--|
| <aturconfpsdmaskds-val>   | <p>applicable at the U-C2 reference point. This MIB PSD mask may impose PSD restrictions in addition to the Limit PSD mask defined in the relevant Recommendation (e.g., G.992.5). (length = 4 bytes).</p> <p><b>Type:</b> Modify -- Optional</p>  |
| <p><b>aturconfpsdmaskus</b><br/>&lt;aturconfpsdmaskus-val&gt;</p>   | <p>This configuration parameter defines that the upstream PSD mask applicable at the U C2 reference point. This MIB PSD mask may impose PSD restrictions in addition to the Limit PSD mask defined in the relevant Recommendation (e.g., G.992.5). It is available only for Annexes J and M of ADSL2/ADSL2plus.(length = 4 bytes)</p> <p><b>Type:</b> Modify -- Optional</p> |
| <p><b>aturratemode</b> fixed  <br/>adaptAtStartup  <br/>adaptAtRuntime</p>  | <p>Defines what form of transmit rate adaptation is configured on this modem. The default value mentioned is an indicative value only.</p> <p><b>Type:</b> Modify -- Optional</p>  |
| <p><b>aturconfmininp</b> Inp0  <br/>InpPoint5   Inp1   Inp2  <br/>InpAuto   Inp4   Inp8   Inp16</p>   | <p>Parameter used to specify the minimum impulse noise protection for the upstream bearer channel. Supported for ADSL2/ADSL2plus ONLY</p> <p><b>Type:</b> Modify -- Optional</p>   |
| <p><b>gsannexcoltocswitch</b><br/>CxSwitch19DB  <br/>CxSwitch20DB  <br/>CxSwitch21DB  <br/>CxSwitch22DB  <br/>CxSwitch23DB  <br/>CxSwitch24DB  <br/>CxSwitch25DB  <br/>CxSwitch26DB  <br/>CxSwitch27DB  <br/>CxSwitch28DB  <br/>CxSwitch29DB  <br/>CxSwitch30DB</p>                               | <p>Conexant parameter that is used to configure the switching point between DBM-OL and XOL.(length = 4 bytes)</p> <p><b>Type:</b> Modify -- Optional</p>   |
| <p><b>aturconfgsannexcswitch</b><br/>Gspan19DB   Gspan20DB  <br/>Gspan21DB   Gspan22DB  <br/>Gspan23DB   Gspan24DB  <br/>Gspan25DB   GspanPlus7DB<br/>  GspanPlus8DB  <br/>GspanPlus9DB  <br/>GspanPlus10DB  <br/>GspanPlus11DB  <br/>GspanPlus12DB  <br/>GspanPlus13DB  <br/>GspanPlus14DB  </p> | <p>Conexant parameter that is used to configure the switching point between Annex C and G.Span (IFM) and between Annex C and G.Span Plus.(length = 4 bytes)</p> <p><b>Type:</b> Modify -- Optional</p>   |

|   |   |
|---|---|
| GspanPlus15DB   |   |
| <b>gsannexctouqswitch</b><br>CUqSwitch6DB  <br>CUqSwitch6_5DB  <br>CUqSwitch7DB  <br>CUqSwitch8DB  <br>CUqSwitch9DB  <br>CUqSwitch10DB  <br>CUqSwitch11DB  <br>CUqSwitch12DB  <br>CUqSwitch13DB  <br>CUqSwitch14DB  <br>CUqSwitch15DB | Conexant parameter that is used to configure the switching point between Annex C and G.Span Plus SUQ.(length = 4 bytes)<br><br><b>Type:</b> Modify -- Optional  |
| <b>atucminsnrmgntime</b><br><atucminsnrmgntime-val>   | This parameter indicates the time when the snr margin violation is allowed. After this time expires and current snr is less than min snr, the DSL line is dropped by the APIs.<br><br><b>Type:</b> Modify -- Optional<br><br><b>Valid values:</b> 0 - 255     |
| <b>atucustomerid</b> WorldWide  <br>France   China   Portugal   | This parameter indicates the customer ID.<br><br><b>Type:</b> Modify -- Optional  |
| <b>atucmpsdmasktype</b><br>Adsl2MEu64   Adsl2MEu60  <br>Adsl2MEu56   Adsl2MEu52  <br>Adsl2MEu48   Adsl2MEu44  <br>Adsl2MEu40   Adsl2MEu36  <br>Adsl2MEu32   Adsl2MAII   | Conexant parameter that selects the PSD mask option to be used for Adsl2M.<br><br><b>Type:</b> Modify -- Optional   |
| <b>atucgsseltloopgauge</b> 26awg<br>  24awg   | This parameter should be set to the expected loop gauge.<br><br><b>Type:</b> Modify -- Optional   |
| <b>atuconfrateratio</b><br><atuconfrateratio-val>   | This parameter specifies the latency rate for both channels in a dual latency configuration. This parameter must be set the parameter to a value greater than 0 and less than 100.<br><br><b>Type:</b> Modify -- Optional<br><br><b>Valid values:</b> 0 - 100 |

### Example:

```
$ get adsl line profile ifname dsl-0
```

## Output:

IfName : dsl-0

### ADSL ATUC Configuration :

-----

|                          |                                    |                          |            |
|--------------------------|------------------------------------|--------------------------|------------|
| Rate Adaptation          | : fixed                            |                          |            |
| Target Snr Margin(dB/10) | : 20                               | Max Snr Mgn(dB/10)       | : 40       |
| GsRsIntCorrectionUp      | : 1ms                              | Dnshift SnrMargin(dB/10) | : 35       |
| Upshift SnrMargin(dB/10) | : 50                               | Min Upshift Time(sec)    | : 70       |
| Min Dnshift Time(sec)    | : 10                               | Fast Min Tx Rate(bps)    | : 0x20     |
| Intl Min Tx Rate(bps)    | : 0x40                             | Fast Max Tx Rate(bps)    | : 0x50     |
| Intl Max Tx Rate(bps)    | : 0x60                             | Max Intl Delay(ms)       | : 10       |
| GsTxStartBin             | : 0x20                             | GsTxEndBin               | : 0x06     |
| GsRxStartBin             | : 0x06                             | GsRxEndBin               | : 0x1f     |
| GsMaxBitsPerBin          | : 15                               | GsMaxDCo                 | : 64       |
| GsRxBinAdjust            | : enable                           | GsAdi2x                  | : standard |
| GsInitiate               | : waitPn                           | GsTxPowerAtten           | : point6   |
| GsCodingGain             | : Auto                             | GsRsFastOvrhdDown        | : 1        |
| GsRsIntCorrectionDown    | : 125Us                            | GsRsFastOvrhdUp          | : 50       |
| GsDrStby                 | : Disable                          | GsExpandedExchange       | : Short    |
| GsEscapeFastRetrain      | : Enable                           | GsFastRetrain            | : Enable   |
| GsBitSwap                | : Enable                           | GsNtr                    | : LocalOcs |
| GsAlctlUsVer             | : Unknown                          |                          |            |
| GsUseCustomBin           | : Enable                           | GsFullRetrain            | : Enable   |
| GsPsdMaskType            | : FlatMsk                          | GsEraseProfiles          | : enable   |
| GsExtRsMemory            | : ExtRsMemory                      | ParamHybridLossTestStart | : 0x10     |
| GsParamHybridLossTestEnd | : 0x23                             | GsDmtTrellis             | : on       |
| GsITriggerMode           | : rmtCrc                           |                          |            |
| Type                     | : noChannel                        |                          |            |
| GsDnBinUsage             | : 0xff                             |                          |            |
| ParametricTestInputFile  | : TestFile                         |                          |            |
| Data Boost               | : Enable                           |                          |            |
| Upstream PSD             | : Extended                         |                          |            |
| Conf PM Mode             | : pmstatal3enable pmstatal3disable |                          |            |

|                           |                     |                           |           |
|---------------------------|---------------------|---------------------------|-----------|
| Conf PML0 Time(sec)       | : 120               | Conf PML2 Time(sec)       | : 255     |
| Conf PML2 ATPR (dB/10)    | : 30                | Conf PML2 Min Rate(bps)   | : 0xFA00  |
| MSG Min Ds                | : 4000              | Min Snr Mrg(dB/10)        | : 20      |
| FrontEnd H/W Design       | : EI1508            |                           |           |
| H/W Pwr Reduction         | : Enable            |                           |           |
| GsUsBitSwap               | : Enable            | Minimum INP               | : Inp0    |
| PML2 Entry Thresh Rate    | : 0x1000            | PML2 Exit Thresh Rate     | : 0x1000  |
| PML2 Entry Rate Min Time  | : 1800              | CabinetHsEnable           | : Disable |
| GsSeltLoopType            | : Real Cable        |                           |           |
| GsRxStartBinU1            | : 0x3aa             |                           |           |
| GsRxEndBinU1              | : 0x4a6             | PSD MoD Enable            | :         |
| PsdMaskEnable             |                     |                           |           |
| PsdMod FallBackEnable     | : Enable            | Max Nom PSD(dB/10)        | : -40     |
| Max Nom AtpPsd(dB/10)     | : 204               |                           |           |
| Downstream PSD Mask :     |                     |                           |           |
| -----                     |                     |                           |           |
| [ 0] 0                    |                     |                           |           |
| GsAnnexCOIToCxSwitch      | : CxSwitch19DB      |                           |           |
| GsAnnexCSwitch            | : Gspan19DB         | GsAnnexCToUqSwitch        | :         |
| CUqSwitch6_5DB            |                     |                           |           |
| Min SnrMgnTime(sec)       | : 20                |                           |           |
| Customer ID               | : WorldWide         |                           |           |
| GsMPsdMaskType            | : Adsl2MEu32        | GsSeltLoopGauge           | : 26awg   |
| Rate Ratio                | : 30                |                           |           |
| ADSL ATUR Configuration : |                     |                           |           |
| -----                     |                     |                           |           |
| Target Snr Margin(dB/10)  | : 20                | Dnshift SnrMargin(dB/10)  | : 35      |
| Upshift SnrMargin(dB/10)  | : 50                | Min Upshift Time(sec)     | : 70      |
| Min Dnshift Time(sec)     | : 10                | Fast Min Tx Rate(bps)     | : 0x20    |
| Intl Min Tx Rate(bps)     | : 0x10              | Fast Max Tx Rate(bps)     | : 0x40    |
| Intl Max Tx Rate(bps)     | : 0x60              | Max Intl Delay(ms)        | : 10      |
| MSG Min Us                | : 4000              | Minimum Snr Margin(dB/10) | : 20      |
| Maximum Snr Margin(dB/10) | : 20                |                           |           |
| PSD MoD Enable            | : Enable            |                           |           |
| PsdMod FallBackEnable     | : PSDFallbackEnable | Max Nom PSD(dB/10)        | : -38     |

Max Nom AtpPsd(dB/10) : 125                      Rate Adaptation : fixed  
 Min INP : Inp0  
 Upstream PSD Mask :  
 -----  
 [ 0]      0

**Output Fields:**

| FIELD                           | Description   |
|---------------------------------|---|
| <b>IfName</b>                   | The ADSL line interface name, whose profile is to be modified or viewed   |
| <b>Rate Adaptation</b>          | Defines what form of transmit rate adaptation is configured on this modem. Refer to ADSL Forum TR-005 for more information.   |
| <b>Target Snr Margin(dB/10)</b> | Configured Target Signal/Noise Margin. This is the Noise Margin the modem must achieve with a BER of 10 to the power -7, or better, to successfully complete initialization.  |
| <b>Max Snr Mgn(dB/10)</b>       | Configured Maximum acceptable Signal/Noise Margin. If the Noise Margin is above this, the modem should attempt to reduce its power output to optimize its operation.  |
| <b>GsRsIntCorrectionUp</b>      | Sets the correction time for the upstream interleaved buffer. RS can also be disabled.  |
| <b>Dnshift SnrMargin(dB/10)</b> | Configured Signal/Noise Margin for rate downshift. If the noise margin falls below this level, the modem should attempt to decrease its transmit rate. In the case that RADSL mode is not present, the value will be 0. |
| <b>Upshift SnrMargin(dB/10)</b> | Configured Signal/Noise Margin for rate upshift. If the noise margin rises above this level, the modem should attempt to increase its transmit rate. In the case that RADSL is not present, the value will be 0.        |
| <b>Min Upshift Time(sec)</b>    | Minimum time that the current margin is above UpshiftSnrMgn before an upshift occurs. In the case that RADSL is not present, the value will be 0.   |
| <b>Min Dnshift Time(sec)</b>    | Minimum time that the current margin is above UpshiftSnrMgn before an upshift occurs. In the case that RADSL is not present, the value will be 0.   |
| <b>Fast Min Tx Rate(bps)</b>    | Configured Minimum Transmit rate for 'Fast' channels, in bps. Also refer to 'adslAtucConfRateChanRatio' for information regarding RADSL mode and refer to ATU-R transmit rate for ATU-C receive rates.                  |
| <b>Intl Min Tx Rate(bps)</b>    | Configured Minimum Transmit rate for 'Interleave' channels, in  |



|                              |   |
|------------------------------|---|
|                              | bps. Also refer to 'adslAtucConfRateChanRatio' for information regarding RADSL mode and refer to ATU-R transmit rate for ATU-C receive rates.   |
| <b>Fast Max Tx Rate(bps)</b> | Configured Maximum Transmit rate for 'Fast' channels, in bps. Also refer to 'adslAtucConfRateChanRatio' for information regarding RADSL mode and ATU-R transmit rate for ATU-C receive rates.   |
| <b>Intl Max Tx Rate(bps)</b> | Configured Maximum Transmit rate for 'Interleave' channels, in bps. Also refer to 'adslAtucConfRateChanRatio' for information regarding RADSL mode and ATU-R transmit rate for ATU-C receive rates.   |
| <b>Max Intl Delay(ms)</b>    | Configured maximum Interleave Delay for this channel. Interleave delay applies only to the interleave channel and defines the mapping (relative spacing) between subsequent input bytes at the interleaver input and their placement in the bit stream at the interleaver output. Larger numbers provide greater separation between consecutive input bytes in the output bit stream, allowing for improved impulse noise immunity at the expense of payload latency. |
| <b>GsTxStartBin</b>          | The lowest bin number allowed for Tx signal.  |
| <b>GsTxEndBin</b>            | The highest bin number allowed for Tx signal.   |
| <b>GsRxStartBin</b>          | The lowest bin number allowed for Rx signal.  |
| <b>GsRxEndBin</b>            | The highest bin number allowed for Rx signal.   |
| <b>GsMaxBitsPerBin</b>       | The maximum Rx number of bits per bin.  |
| <b>GsMaxDCo</b>              | Maximum interleaving depth supported by the customer's hardware   |
| <b>GsRxBinAdjust</b>         | This parameter employs Rx Start/End bin settings  |
| <b>GsAdi2x</b>               | For non-standard compliant ADI CPE  |
| <b>GsInitiate</b>            | Specifies which end initiates startup. It is also used to send a C-tone to the remote unit.   |
| <b>GsTxPowerAtten</b>        | The value in dB of Tx power attenuation   |
| <b>GsCodingGain</b>          | Sets the coding gain in dB increments   |
| <b>GsRsFastOvrhdDown</b>     | This parameter sets the percentage overhead for the downstream fast buffer. RS can also be disabled.  |
| <b>GsRsIntCorrectionDown</b> | This parameter sets the correction time for the downstream interleaved buffer. RS can also be disabled.   |
| <b>GsRsFastOvrhdUp</b>       | This parameter sets the percentage overhead for the upstream fast buffer. RS can also be disabled.  |
| <b>GsDrStby</b>              | This parameter provides the ability to disable power to the line driver   |

|                                 |   |
|---------------------------------|---|
| <b>GsExpandedExchange</b>       | T1.413 parameter that Enables/Disables EES  |
| <b>GsEscapeFastRetrain</b>      | This parameter enables/disables escape to the fast retrain capability   |
| <b>GsFastRetrain</b>            | This parameter enables/disables the fast retrain capability. Currently supported only in G.lite mode.   |
| <b>GsBitSwap</b>                | This parameter enables/disables bit swapping  |
| <b>GsNtr</b>                    | This parameter enables/disables NTR on a per chip basis   |
| <b>GsAlctUsVer</b>              | For T1.413 demo purposes only   |
| <b>GsUseCustomBin</b>           | This parameter enables/disables user selection which of the 511 bins will be enabled for upstream and downstream transmission.  |
| <b>GsFullRetrain</b>            | Indicates enable/disable of auto retrain capability   |
| <b>GsPsdMaskType</b>            | This parameter selects the PSD mask option to be used   |
| <b>GsEraseProfiles</b>          | This parameter enables/disables the ability to erase all fast retrain profiles at startup   |
| <b>GsExtRsMemory</b>            | Indicates whether customer's Hardware uses external RS RAM  |
| <b>ParamHybridLossTestStart</b> | Start bin for range of bins to be measured. The default value mentioned is an indicative value only, for exact value refer to document number DO-400523-AN and DO-401163-AN.  |
| <b>GsParamHybridLossTestEnd</b> | End bin for range of bins to be measured.   |
| <b>GsDmtTrellis</b>             | This parameter enables/disables trellis coding. Trellis coding should always be enabled for its clear performance advantage.  |
| <b>GsITriggerMode</b>           | The type of event that triggers a fast retrain  |
| <b>Type</b>                     | This object is used to configure the ADSL physical line mode.   |
| <b>GsDnBinUsage</b>             | '1' in bit position indicates usage of corresponding bin, whereas a '0' disables usage of corresponding bin.  |
| <b>ParametricTestInputFile</b>  | Indicates Name of the Input file from which to take the Mask Array Size, lower and upper mask Array. Null string means no file is specified   |
| <b>Data Boost</b>               | Conexant parameter that enables/disables DataBoost option.  |
| <b>Upstream PSD</b>             | Conexant parameter that sets the upstream PSD to be either extended or standard. Used for GSpan Plus only.  |
| <b>Conf PM Mode</b>             | PM-related parameter used by the ATU-C to set the allowed link states. Both bit values can be given simultaneously in the input. Additional value to disable pmmode is disable, which is equal to 0.                            |
| <b>Conf PML0 Time(sec)</b>      | PM configuration parameter, related to the L2 low power state. This parameter represents the minimum time (in seconds) between an exit from the L2 state and the next entry into the L2 state. It ranges from 0 to 255 seconds. |
| <b>Conf PML2 Time(sec)</b>      | PM configuration parameter, related to the L2 low power state. This parameter represents the minimum time (in seconds)  |

|                                 |   |
|---------------------------------|---|
|                                 | between an Entry into the L2 state and the first Power Trim in the L2 state and between two consecutive Power Trims in the L2 State. It ranges from 0 to 255 seconds.   |
| <b>Conf PML2 ATPR (dB/10)</b>   | PM configuration parameter, related to the L2 low power state. This parameter represents the maximum aggregate transmit power reduction (in dB) that can be performed through a single Power Trim in the L2 state. It ranges from 0 dB/10 to 310 dB/10. |
| <b>Conf PML2 Min Rate(bps)</b>  | PM configuration parameter, related to the L2 low power state. This parameter specifies the minimum net data rate during the low power state (L2). The data rate is coded in bit/s, and can range from 0x1F40 (8000) bps to 0xFA000 (1024000) bps.      |
| <b>MSG Min Ds</b>               | Configures downstream overhead channel bandwidth. This feature is not supported by DSLPHY as yet.   |
| <b>Min Snr Mrg(dB/10)</b>       | Atuc Configured Minimum Signal/Noise Margin. This is the Noise Margin, the modem must achieve with a BER of 10 to the power -7 or better, to successfully complete initialization. The default value mentioned is an indicative value only.             |
| <b>FrontEnd H/W Design</b>      | Front end hardware reference design   |
| <b>H/W Pwr Reduction</b>        | Hardware configuration parameter  |
| <b>GsUsBitSwap</b>              | This parameter enables/disables upstream bit swapping   |
| <b>Minimum INP</b>              | Parameter used to specify the minimum impulse noise protection for the downstream bearer channel.   |
| <b>PML2 Entry Thresh Rate</b>   | PM config param. L2 state entry data rate.  |
| <b>PML2 Exit Thresh Rate</b>    | PM config param. L2 state exit data rate.   |
| <b>PML2 Entry Rate Min Time</b> | PM config param.Min L2 entry rate time  |
| <b>CabinetHsEnable</b>          | Enable/Disable HS tones in Cabinet mode   |
| <b>GsSeltLoopType</b>           | Conexant parameter that is used to specify the loop type for SELT. The default value mentioned is an indicative value only.   |
| <b>GsRxStartBinU1</b>           | Conexant parameter that specifies lowest bin number allowed for Rx signal in G.Span Plus SUQ mode. By selecting the receive start and end bin numbers, the user can limit the bins for special configurations.(length = 4 bytes)                        |
| <b>GsRxEndBinU1</b>             | Conexant parameter that specifies highest bin number allowed for Rx signal in G.Span Plus SUQ mode. By selecting the receive start and end bin numbers, the user can limit the bins for special configurations.(length = 4 bytes)                       |
| <b>PSD MoD Enable</b>           | Conexant parameter that is used to configure the switching point between DBM-OL and XOL.(length = 4 bytes)  |
| <b>PsdMod FallBackEnable</b>    | Conexant parameter used to enable Mask on Demand (MoD) fallback mode. When enabled, the system chooses MoD or the   |

|                                 |   |
|---------------------------------|---|
|                                 | base ADSL2 depending upon the downstream rate. It is available only for ADSL2 Annex A.(length = 4 bytes)  |
| <b>Max Nom PSD(dB/10)</b>       | This parameter specifies the maximum nominal transmit PSD(MAXNOMPSD) level during initialization and showtime. Value depends on CO MIB element settings and near end transmitter capabilities and is exchanged in the G.994.1 Phase. It is available only for ADSL2/ADSL2plus. Value ranges from -60 to -40 in steps of 0.1 dBm/Hz.(length = 4 bytes) |
| <b>Max Nom AtpPsd(dB/10)</b>    | This parameter specifies the maximum nominal aggregate transmit power(MAXNOMATP) level during initialization and showtime. Value depends on CO MIB element settings and local capabilities and is exchanged in the G.994.1 Phase. It is available only for ADSL2/ADSL2plus. Value ranges from 0 to 25.5 in steps of 0.1 dBm.(length = 4 bytes)        |
| <b>DS PSD Mask</b>              | This configuration parameter defines that the downstream PSD mask applicable at the U-C2 reference point. This MIB PSD mask may impose PSD restrictions in addition to the Limit PSD mask defined in the relevant Recommendation (e.g., G.992.5). (length = 4 bytes).   |
| <b>GsAnnexCOIToCxSwitch</b>     | Conexant parameter that is used to configure the switching point between DBM-OL and XOL.(length = 4 bytes)  |
| <b>GsAnnexCSwitch</b>           | Conexant parameter that is used to configure the switching point between Annex C and G.Span (IFM) and between Annex C and G.Span Plus.(length = 4 bytes)  |
| <b>GsAnnexCToUqSwitch</b>       | Conexant parameter that is used to configure the switching point between Annex C and G.Span Plus SUQ.(length = 4 bytes)   |
| <b>Min SnrMgnTime(sec)</b>      | This parameter indicates the time when the snr margin violation is allowed. After this time expires and current snr is less than min snr, the DSL line is dropped by the APIs.  |
| <b>Customer ID</b>              | This parameter indicates the customer ID.   |
| <b>GsMPsdMaskType</b>           | Conexant parameter that selects the PSD mask option to be used for Adsl2M.  |
| <b>GsSeltLoopGauge</b>          | This parameter should be set to the expected loop gauge.  |
| <b>Rate Ratio</b>               | This parameter specifies the latency rate for both channels in a dual latency configuration. This parameter must be set the parameter to a value greater than 0 and less than 100.  |
| <b>Target Snr Margin(dB/10)</b> | Noise Margin the modem must achieve with a BER of 10 <sup>-7</sup> to the power 7 or better to successfully complete initialization   |
| <b>Dnshift SnrMargin(dB/10)</b> | Configured Signal/ Noise Margin for rate downshift. If the noise margin falls below this level, the modem should attempt to   |

|                                  |  |
|----------------------------------|--|
|                                  | decrease its transmit rate. In the case that RADSL mode is not present, the value will be 0.   |
| <b>Upshift SnrMargin(dB/10)</b>  | Configured Signal/ Noise Margin for rate upshift. If the noise margin rises above this level, the modem should attempt to increase its transmit rate. In the case that RADSL is not present, the value will be 0.  |
| <b>Min Upshift Time(sec)</b>     | Minimum time that the current margin is above UpshiftSnrMgn, before an upshift occurs. In the case that RADSL is not present, the value will be 0.   |
| <b>Min Dnshift Time(sec)</b>     | Minimum time that the current margin is below DownshiftSnrMgn, before a downshift occurs. In the case that RADSL mode is not present, the value will be 0.   |
| <b>Fast Min Tx Rate(bps)</b>     | Configured Minimum Transmit rate for 'Fast' channels, in bps. Also refer to 'adslAturConfRateChanRatio' for information regarding RADSL mode and ATU-C transmit rate for ATU-R receive rates.  |
| <b>Intl Min Tx Rate(bps)</b>     | Configured Minimum Transmit rate for 'Interleave' channels, in bps. Also refer to 'adslAturConfRateChanRatio' for information regarding RADSL mode and to ATU-C transmit rate for ATUR receive rates.  |
| <b>Fast Max Tx Rate(bps)</b>     | Configured Maximum Transmit rate for 'Fast' channels, in bps. Also refer to 'adslAturConfRateChanRatio' for information regarding RADSL mode and to ATU-C transmit rate for ATUR receive rates.  |
| <b>Intl Max Tx Rate(bps)</b>     | Configured Maximum Transmit rate for 'Interleave' channels, in bps. Also refer to 'adslAturConfRateChanRatio' for information regarding RADSL mode and to ATU-C transmit rate for ATU-R receive rates.   |
| <b>Max Intl Delay(ms)</b>        | Configured maximum Interleave Delay for this channel. Interleave delay applies only to the interleave channel and defines the mapping (relative spacing) between subsequent input bytes at the interleaver input and their placement in the bit stream at the interleaver output. Larger numbers provide greater separation between consecutive input bytes in the output bit stream, allowing for improved impulse noise immunity at the expense of payload latency |
| <b>MSG Min Us</b>                | Configures upstream overhead channel bandwidth. This feature is not supported by DSLPHY as yet.  |
| <b>Minimum Snr Margin(dB/10)</b> | Atuc Configured Minimum Signal/Noise Margin. This is the Noise Margin, the modem must achieve with a BER of 10 to the power -7   |

|                                  |   |
|----------------------------------|---|
|                                  | or better, to successfully complete initialization. The default value mentioned is an indicative value only.  |
| <b>Maximum Snr Margin(dB/10)</b> | Configured Maximum acceptable downstream Signal/Noise Margin. If the Noise Margin is above this the modem attempts to reduce its power output to optimize its operation. The value set by the user is in dB/10, and ranges from 0 to 31 dB in 1 dB steps.   |
| <b>PSD MoD Enable</b>            | Conexant parameter used to enable the Mask on Demand(MoD) feature in the upstream direction. It is available only for ADSL2 Annex A ONLY.(length = 4 bytes)   |
| <b>PsdMod FallBackEnable</b>     | Conexant parameter used to enable Mask on Demand (MoD) fallback mode. When enabled, the system chooses MoD or the base ADSL2 depending upon the upstream rate. It is available only for ADSL2 Annex A.(length = 4 bytes)  |
| <b>Max Nom PSD(dB/10)</b>        | This parameter specifies the maximum nominal transmit PSD(MAXNOMPSD) level during initialization and showtime. Value depends on CO MIB element settings and near end transmitter capabilities and is exchanged in the G.994.1 Phase. It is available only for ADSL2/ADSL2plus. Value ranges from -60 to -38 in steps of 0.1 dBm/Hz.(length = 4 bytes) |
| <b>Max Nom AtpPsd(dB/10)</b>     | This parameter specifies the maximum nominal aggregate transmit power(MAXNOMATP) level during initialization and showtime. Value depends on CO MIB element settings and local capabilities and is exchanged in the G.994.1 Phase. It is available only for ADSL2/ADSL2plus. Value ranges from 0 to 25.5 in steps of 0.1 dBm.(length = 4 bytes)        |
| <b>Rate Adaptation</b>           | Defines what form of transmit rate adaptation is configured on this modem. The default value mentioned is an indicative value only.   |
| <b>Min INP</b>                   | Parameter used to specify the minimum impulse noise protection for the upstream bearer channel. Supported for ADSL2/ADSL2plus ONLY  |
| <b>US PSD Mask</b>               | This configuration parameter defines that the upstream PSD mask applicable at the U C2 reference point. This MIB PSD mask may impose PSD restrictions in addition to the Limit PSD mask defined in the relevant Recommendation (e.g., G.992.5). It is available only for Annexes J and M of ADSL2/ADSL2plus.(length = 4 bytes)                        |

## References:

- ADSL Commands

## 5.9.24 Dsl chip Commands

### 5.9.24.1 Get adsl chip

**Description:**

Use this command to get.

**Command Syntax:**

```
get dsl chip [chipid <chipid-val>]
```

### 5.9.24.2 Create dsl chip

**Description:**

Use this command to get.

**Command Syntax:**

```
create dsl chip chipid <chipid-val> [ dsctype Adsl | Sdsl | Shdsl | Vdsl ]  
[ linecoding Other | Dmt | Cap | Qam | Mcm | Scm ] [ adsltxcfg ansit1413 | etsi |  
q9921PotsNonOverlapped | q9921PotsOverlapped | q9921IsdnNonOverlapped |  
q9921IsdnOverlapped | q9921TcmIsdnNonOverlapped |  
q9921TcmIsdnOverlapped | q9922PotsNonOverlapped | q9922PotsOverlapped |  
q9922TcmIsdnNonOverlapped | q9922TcmIsdnOverlapped |  
q9921TcmIsdnSymmetric | adslPlusPotsNonOverlapped |  
q9921GspanPlusPotsNonOverlapped | q9921GspanPlusPotsOverlapped |  
q9923Adsl2PotsOverlapped | q9923Adsl2PotsNonOverlapped |  
q9925Adsl2PlusPotsOverlapped | q9925Adsl2PlusPotsNonOverlapped |  
q9923Readsl2PotsOverlapped | q9923Readsl2PotsNonOverlapped |  
adslPlusPotsOverlapped | q9921GspanPlusPlusPotsNonOverlapped |  
q9921GspanPlusPlusPotsOverlapped | q9923IsdnNonOverlapped |  
q9923IsdnOverlapped | q9925IsdnNonOverlapped | q9925IsdnOverlapped |  
q9923AnnexMPotsExtUsNonOverlapped | q9923AnnexMPotsExtUsOverlapped |  
q9925AnnexMPotsExtUsNonOverlapped | q9925AnnexMPotsExtUsOverlapped ]  
[ shdsltxmode Region1 | Region2 ]
```

### 5.9.24.3 Delete dsl chip

#### Description:

Use this command to get.

#### Command Syntax:

**delet dsl chip chipid <chipid-val>**

#### Parameters:

| Name   | Description   |
|--|---|
| <b>chipid</b> <chipid-val>   | Identifies the chip to be build and initialized.<br><b>Type:</b> Create -- Mandatory<br>Delete -- Mandatory<br>Get -- Optional<br><b>Valid values:</b> 1 - 9                      |
| <b>dsltype</b> Adsl   Sdsl   Shdsl   Vdsl  | Identifies the firmware to be downloaded.<br><b>Type:</b> Create -- Optional  |
| <b>linecoding</b> Other   Dmt   Cap   Qam   Mcm   Scm  | ADSL line coding type. Not valid for SHDSL.<br><b>Type:</b> Create -- Optional  |
| <b>adsltxcfg</b> ansit1413   etsi   q9921PotsNonOverlapped   q9921PotsOverlapped   q9921IsdnNonOverlapped   q9921IsdnOverlapped   q9921TcmIsdnNonOverlapped   q9921TcmIsdnOverlapped   q9922PotsNonOverlapped   q9922PotsOverlapped   q9922TcmIsdnNonOverlapped   q9922TcmIsdnOverlapped   q9921TcmIsdnSymmetric   adslPlusPotsNonOverlapped   q9921GspanPlusPotsNonOverlapped   q9921GspanPlusPotsOverlapped   q9923Adsl2PotsOverlapped   q9923Adsl2PotsNonOverlapped   q9925Adsl2PlusPotsOverlapped   q9925Adsl2PlusPotsNonOverlapped   q9923Readsl2PotsOverlapped | Transmission capabilities with which the DSL system is configured. Its default value depends on the Annex Type supported. Not valid for SHDSL.<br><b>Type:</b> Create -- Optional |



|  |   |
|--|---|
| q9923Readsl2PotsNonOverlapped   adslPlusPotsOverlapped  <br>q9921GspanPlusPlusPotsNonOverlapped  <br>q9921GspanPlusPlusPotsOverlapped   q9923IsdnNonOverlapped   q9923IsdnOverlapped  <br>q9925IsdnNonOverlapped   q9925IsdnOverlapped  <br>q9923AnnexMPotsExtUsNonOverlapped  <br>q9923AnnexMPotsExtUsOverlapped  <br>q9925AnnexMPotsExtUsNonOverlapped  <br>q9925AnnexMPotsExtUsOverlapped |   |
| <b>shdsltxmode</b> Region1   Region2   | Annexure Type, specifies the regional settings for the SHDSL line. Only valid for SHDSL.<br><br><b>Type:</b> Create -- Optional |

**Example:**

```
$ create dsl chip chipid 1 dsctype Adsl linecoding Dmt adsltxcfg ansit1413
q9921PotsOverlapped q9921PotsNonOverlapped shdsltxmode region1 Region2
```

**Output:**

```
Verbose Mode On
Entry Created
```

```
Chip Id      : 1
DSL Type    : Adsl
Line coding  : Dmt
Adsl Tx Config : ansit1413 q9921PotsOverlapped q9921PotsNonOverlapped
Shdsl Tx Mode : region1 Region2
Verbose Mode Off:
Entry Created
```

## Output Fields:

| FIELD          | Description  |
|----------------|--|
| Chip Id        | Identifies the chip to be build and initialized.   |
| DSL Type       | Identifies the firmware to be downloaded.  |
| Line coding    | ADSL line coding type. Not valid for SHDSL.  |
| Adsl Tx Config | Transmission capabilities with which the DSL system is configured. Its default value depends on the Annex Type supported. Not valid for SHDSL. |
| Shdsl Tx Mode  | Annexure Type, specifies the regional settings for the SHDSL line. Only valid for SHDSL.   |

## 5.9.25 Dsl dsp chip Commands

### 5.9.25.1 Get dsl dsp chip

#### Description:

Use this command to get.

#### Command Syntax:

```
get dsl dsp chip [chipid <chipid-val>]
```

### 5.9.25.2 Reset dsl dsp chip

#### Description:

Use this command to get.

#### Command Syntax:

```
reset dsl dsp chip
```

#### Parameters:

| Name          | Description   |
|---------------|---|
| chipid chipid | This object is the Index of Dsl Chip for which reset is to be done.<br><b>Type:</b> Reset -- Mandatory<br>Get -- Optional<br><b>Valid values:</b> 1 - 9 |

#### Example:

```
$ get dsl dsp chip chipid 1
```

**Output:**

ChipId

-----

1

**Output Fields:**

| FIELD  | Description   |
|--------|---|
| ChipId | This object is the Index of Dsl Chip for which reset is to be done. |

**5.9.26 Dsl dsp port Commands****5.9.26.1 Get dsl dsp port****Description:**

Use this command to get.

**Command Syntax:**

**get dsl dsp port [ifname <interface-name>]**

**5.9.26.2 Reset dsl dsp port****Description:**

Use this command to get.

**Command Syntax:**

**reset dsl dsp port ifname <interface-name>**

**Parameters:**

| Name                              | Description  |
|-----------------------------------|--|
| <b>ifname</b><br><interface-name> | This object is the Index of Dsl Port for which reset is to be done.<br><b>Type:</b> Reset -- Mandatory<br>Get -- Optional<br><b>Valid values:</b> dsl-0 – dsl-23 |

**Example:**

\$ get dsl dsp port ifname dsl-0

**Output:**

Ifname

-----

dsl-0

## Output Fields:

| FIELD  | Description   |
|--------|---|
| lfname | This object is the Index of Dsl Port for which reset is to be done. |

## 5.9.27 Dsl system Commands

### 5.9.27.1 Get dsl system

#### Description:

Use this command to get.

#### Command Syntax:

**get dsl system**

### 5.9.27.2 Create dsl system

#### Description:

Use this command to create.

#### Command Syntax:

**create dsl system** [dsltype Adsl | Sdsl | Shdsl | Vdsl] [linecoding Other | Dmt | Cap | Qam | Mcm | Scm] [adsltxcfg ansit1413 | etsi | q9921PotsNonOverlapped | q9921PotsOverlapped | q9921IsdnNonOverlapped | q9921IsdnOverlapped | q9921TcmIsdnNonOverlapped | q9921TcmIsdnOverlapped | q9922PotsNonOverlapped | q9922PotsOverlapped | q9922TcmIsdnNonOverlapped | q9922TcmIsdnOverlapped | q9921TcmIsdnSymmetric | adslPlusPotsNonOverlapped | q9921GspanPlusPotsNonOverlapped | q9921GspanPlusPotsOverlapped | q9923Adsl2PotsOverlapped | q9923Adsl2PotsNonOverlapped | q9925Adsl2PlusPotsOverlapped | q9925Adsl2PlusPotsNonOverlapped | q9923Readsl2PotsOverlapped | q9923Readsl2PotsNonOverlapped | adslPlusPotsOverlapped | q9921GspanPlusPlusPotsNonOverlapped | q9921GspanPlusPlusPotsOverlapped | q9923IsdnNonOverlapped | q9923IsdnOverlapped | q9925IsdnNonOverlapped | q9925IsdnOverlapped | q9923AnnexMPotsExtUsNonOverlapped | q9923AnnexMPotsExtUsOverlapped | q9925AnnexMPotsExtUsNonOverlapped | q9925AnnexMPotsExtUsOverlapped ] [ shdsltxmode Region1 | Region2 ]

### 5.9.27.3 Delete dsl system

#### Description:

Use this command to get.

#### Command Syntax:

**delet dsl system**

#### Parameters:

| Name   | Description  |
|--|--|
| <b>dslype</b> Adsl   Sdsl   Shdsl   Vdsl   | Identifies the firmware to be downloaded.<br><b>Type:</b> Create — Optional<br><b>Default value:</b> Adsl  |
| <b>linecoding</b> Other   Dmt   Cap   Qam   Mcm   Scm  | ADSL line code type.<br><b>Type:</b> Create — Optional<br><b>Default value:</b> Dmt  |
| <b>adsltxcfg</b> ansit1413   etsi  q9921PotsNonOverlapped   q9921PotsOverlapped  q9921IsdnNonOverlapped  q9921IsdnOverlapped  q9921TcmIsdnNonOverlapped  q9921TcmIsdnOverlapped   q9922PotsNonOverlapped  q9922PotsOverlapped  q9922TcmIsdnNonOverlapped  q9922TcmIsdnOverlapped   q9921TcmIsdnSymmetric  adslPlusPotsNonOverlapped q9921GspanPlusPotsNonOverlapped  q9921GspanPlusPotsOverlapped  q9923Adsl2PotsOverlapped q9923Adsl2PotsNonOverlapped  q9925Adsl2PlusPotsOverlapped  q9925Adsl2PlusPotsNonOverlapped  q9923Readsl2PotsOverlapped  q9923Readsl2PotsNonOverlapped  adslPlusPotsOverlapped  q9921GspanPlusPlusPotsNonOverlapped  q9921GspanPlusPlusPotsOverlapped  q9923IsdnNonOverlapped | Transmission capabilities with which the DSL system is configured. Its default value depends on the Annex Type supported. Not valid for SHDSL.<br><b>Type:</b> Create — Optional |

|  |   |
|--|---|
| q9923IsdnOverlapped<br> q9925IsdnNonOverlapped<br> q9925IsdnOverlapped<br> q9923AnnexMPotsExtUsNonOverlapped<br> q9923AnnexMPotsExtUsOverlapped<br> q9925AnnexMPotsExtUsNonOverlapped<br> q9925AnnexMPotsExtUsOverlapped |   |
| <b>shdsltxmode</b> Region1  Region2  | Annexure Type specifies the regional settings for the SHDSL line. Only valid for SHDSL.<br><br><b>Type:</b> Create — Optional<br><br><b>Default value:</b> Region1  Region2 |

**Example:**

```
$ create dsl system dslype Adsl linecoding Dmt adsltxcfg ansit1413 shdsltxmode region1 Region2
```

**Output:**

```
Verbose Mode On  
Entry Created
```

```
DSL Type      : Adsl  
Line coding   : Dmt  
Adsl Tx Config : ansit1413  
Shdsl Tx Mode : region1 Region2  
Verbose Mode Off:  
Entry Created
```

**Output Fields:**

| FIELD                 | Description  |
|-----------------------|--|
| <b>DSL Type</b>       | Identifies the firmware to be downloaded.  |
| <b>Line coding</b>    | ADSL line code type.   |
| <b>Adsl Tx Config</b> | Transmission capabilities with which the DSL system is configured. Its default value depends on the Annex Type supported. Not valid for SHDSL. |
| <b>Shdsl Tx Mode</b>  | Annexure Type specifies the regional settings for the SHDSL line. Only valid for SHDSL.  |

## 5.10 EHDLC Commands

---

### 5.10.1 Ehdlc intf Commands

#### 5.10.1.1 Get ehdlc intf

**Description:**

Use this command to get.

**Command Syntax:**

**get ehdlc intf [ifname <interface-name>]**

#### 5.10.1.2 Create ehdlc intf

**Description:**

Use this command to create.

**Command Syntax:**

**create ehdlc intf ifname <interface-name>lowif <lowif-val> [sarstatus Enable | Disable] [enable | disable]**

#### 5.10.1.3 Delete ehdlc intf

**Description:**

Use this command to delete

**Command Syntax:**

**delete ehdlc intf [ifname <interface-name>]**

#### 5.10.1.4 Modify ehdlc intf

**Description:**

Use this command to modify

**Command Syntax:**

**modify ehdlc intf ifname <interface-name>lowif <lowif-val> [sarstatus Enable | Disable] [enable | disable]**

## Parameters:

| Name                              | Description   |
|-----------------------------------|---|
| <b>ifname</b><br><interface-name> | This parameter specifies the name assigned to this interface.<br>Valid Values starts from ehdlc-0 and continues to ehdlc-*<br><b>Type:</b> Create -- Mandatory<br>Delete -- Mandatory<br>Modify -- Mandatory<br>Get -- Optional<br><b>Valid values:</b> IAD_MIN_EHDLC_IFINDEX - IAD_MAX_EHDLC_IFINDEX             |
| <b>lowif</b> <lowif-val>          | This specifies the lower interface index. This is the ifindex of the DSL port on which EHDLC is being created. Valid Values start from dsl-0 and continues to dsl-*<br><b>Type:</b> Create -- Mandatory<br><b>Valid values:</b> dsl-0 – dsl-23  |
| <b>sarstatus</b> Enable   Disable | This defines the segmentation and reassembly status of the hdlc/dsl interface. HDLC supports only 508 as frame size, to support longer snmp messages, it should be turn off. By default, the option taken is 'disable'.<br><b>Type:</b> Create -- Optional<br>Modify -- Optional<br><b>Default value:</b> disable |
| <b>enable   disable</b>           | Administrative status of the Ehdlc interface<br><b>Type:</b> Optional   |

## Example:

```
$ create ehdlc intf ifname ehdlc-0 lowif dsl-0 SarStatus Enable enable
```

## Output:

```
Verbose Mode On  
Entry Created
```

```
IfName           : ehdlc-0      LowIfName        : dsl-0  
EHDLC Sar Status : enable      Admin Status     : Enable
```

```
Verbose Mode Off:  
Entry Created
```



## Output field:

| Field            | Description   |
|------------------|---|
| IfName           | This parameter specifies the name assigned to this interface. Valid Values starts from ehdlc-0 and continues to ehdlc-*   |
| LowIfName        | This specifies the lower interface index. This is the ifindex of the DSL port on which EHDLC is being created. Valid Values start from dsl-0 and continues to dsl-*   |
| EHDLC Sar Status | This defines the segmentation and reassembly status of the hdlc/dsl interface. HDLC supports only 508 as frame size, to support longer snmp messages, it should be turned off. By default, the option taken is 'disable'. |
| Admin Status     | Administrative status of the Ehdlc interface  |

## 5.11 Ethernet Commands

---

### 5.11.1 Dot3 stats Commands

#### 5.11.1.1 Get dot3 stats

##### Description:

Use this command to get.

##### Command Syntax:

```
get dot3 stats [ifname <interface-name>]
```

##### Parameters:

| Name                       | Description   |
|----------------------------|---|
| ifname<br><interface-name> | An index name that uniquely identifies an interface to an ethernet-like medium.<br><b>Type:</b> Get -- Optional<br><b>Valid values:</b> eth-0 – eth01 |

##### Example

```
$ get dot3 stats ifname eth-0
```

##### Output

```
IfName : eth-0
Alignment Errors : 11 FCS Errors : 12
Single Collision Frames : 13 Multiple Collision Frames : 14
Deferred Tx Frames : 15 Late Collisions : 16
Excess Collisions Frames : 17 Mac Tx Errors Frames : 18
```

Carrier Sense Errors : 18 Too Long Frames : 19  
 Mac Rx Error Frames : 20 Duplex Status :  
 FullDuplex

**Output field:**

| Field                   | Description  |
|-------------------------|--|
| <b>IfName</b>           | An index name that uniquely identifies an interface to an ethernet-like medium.  |
| <b>Alignment Errors</b> | A count of frames received on a particular interface that are not an integral number of octets in length and do not pass the FCS check. The count represented by an instance of this object is incremented when the alignmentError status is returned by the MAC service to the LLC (or other MAC user). Received frames for which multiple error conditions pertain are, according to the conventions of IEEE 802.3 Layer Management, counted exclusively according to the error status presented to the LLC. This counter does not increment for group encoding schemes greater than 4 bits per group. For interfaces operating at 10 Gb/s, this counter can roll over in less than 5 minutes if it is incrementing at its maximum rate. Since that amount of time could be less than a management station's poll cycle time, in order to avoid a loss of information, a management station is advised to poll the dot3HCStatsAlignmentErrors object for 10 Gb/s or faster interfaces. Discontinuities in the value of this counter can occur at re-initialization of the management system, and at other times as indicated by the value of ifCounterDiscontinuityTime. |
| <b>FCS Errors</b>       | A count of frames received on a particular interface that are an integral number of octets in length but do not pass the FCS check. This count does not include frames received with frame-too-long or frame-too-short error. The count represented by an instance of this object is incremented when the frameCheckError status is returned by the MAC service to the LLC (or other MAC user). Received frames for which multiple error conditions pertain are, according to the conventions of IEEE 802.3 Layer Management, counted exclusively according to the error status presented to the LLC. For interfaces operating at 10 Gb/s, this counter can roll over in less than 5 minutes if it is incrementing at its maximum rate. Since that amount of time could be less than a management station's poll cycle time, in  |

|   |   |
|---|---|
|   | <p>order to avoid a loss of information, a management station is advised to poll the dot3HCStatsFCSErrors object for 10 Gb/s or faster interfaces. Discontinuities in the value of this counter can occur at e-initialization of the management system, and at other times as indicated by the value of ifCounterDiscontinuityTime.</p>   |
| <p><b>Single Collision Frames</b></p>   | <p>A count of frames that are involved in a single collision, and are subsequently transmitted successfully. A frame that is counted by an instance of this object is also counted by the corresponding instance of the ifOutUcastPkts, ifOutMulticastPkts, or ifOutBroadcastPkts, and is not counted by the corresponding instance of the dot3StatsMultipleCollisionFrames object. This counter does not increment when the interface is operating in full-duplex mode. Discontinuities in the value of this counter can occur at re-initialization of the management system, and at other times as indicated by the value of ifCounterDiscontinuityTime.</p>          |
| <p><b>Multiple Collision Frames</b></p> | <p>A count of frames that are involved in more than one collision and are subsequently transmitted successfully. A frame that is counted by an instance of this object is also counted by the corresponding instance of either the ifOutUcastPkts, ifOutMulticastPkts, or ifOutBroadcastPkts, and is not counted by the corresponding instance of the dot3StatsSingleCollisionFrames object. This counter does not increment when the interface is operating in full-duplex mode. Discontinuities in the value of this counter can occur at re-initialization of the management system, and at other times as indicated by the value of ifCounterDiscontinuityTime.</p> |
| <p><b>Deferred Tx Frames</b></p>        | <p>A count of frames for which the first transmission attempt on a particular interface is delayed because the medium is busy. The count represented by an instance of this object does not include frames involved in collisions. This counter does not increment when the interface is operating in full-duplex mode. Discontinuities in the value of this counter can occur at re-initialization of the management system, and at other times as indicated by the value of ifCounterDiscontinuityTime.</p>   |
| <p><b>Late Collisions</b></p>           | <p>The number of times that a collision is detected on a particular interface later than one slotTime into the transmission of a packet. A (late) collision included in a count represented by an instance of this object is also considered as a (generic) collision for purposes of other collision-related statistics. This counter does not increment when the interface is operating in full-duplex mode. Discontinuities in the value of this counter can occur at</p>  |

|                                 |  |
|---------------------------------|--|
|                                 | re-initialization of the management system, and at other times as indicated by the value of ifCounterDiscontinuityTime.  |
| <b>Excess Collisions Frames</b> | <p>A count of frames for which transmission on a particular interface fails due to excessive collisions. This counter does not increment when the interface is operating in full-duplex mode.</p> <p>Discontinuities in the value of this counter can occur at re-initialization of the management system, and at other times as indicated by the value of ifCounterDiscontinuityTime.</p>   |
| <b>Mac Tx Errors Frames</b>     | <p>A count of frames for which transmission on a particular interface fails due to an internal MAC sublayer transmit error. A frame is only counted by an instance of this object if it is not counted by the corresponding instance of either the dot3StatsLateCollisions object, the dot3StatsExcessiveCollisions object, or the dot3StatsCarrierSenseErrors object. The precise meaning of the count represented by an instance of this object is implementation-specific. In particular, an instance of this object may represent a count of transmission errors on a particular interface that are not otherwise counted. For interfaces operating at 10 Gb/s, this counter can roll over in less than 5 minutes if it is incrementing at its maximum rate. Since that amount of time could be less than a management station's poll cycle time, in order to avoid a loss of information, a management station is advised to poll the dot3HCStatsInternalMacTransmitErrors object for 10 Gb/s or faster interfaces. Discontinuities in the value of this counter can occur at re-initialization of the management system, and at other times as indicated by the value of ifCounterDiscontinuityTime.</p> |
| <b>Carrier Sense Errors</b>     | <p>The number of times that the carrier sense condition was lost or never asserted when attempting to transmit a frame on a particular interface. The count represented by an instance of this object is incremented at most once per transmission attempt, even if the carrier sense condition fluctuates during a transmission attempt. This counter does not increment when the interface is operating in full-duplex mode. Discontinuities in the value of this counter can occur at re-initialization of the management system, and at other times as indicated by the value of ifCounterDiscontinuityTime.</p>   |
| <b>Too Long Frames</b>          | <p>A count of frames received on a particular interface that exceed the maximum permitted frame size. The count represented by an instance of this object is incremented when the frameTooLong status is returned by the MAC service to the LLC (or other MAC</p>  |

|                            |  |
|----------------------------|--|
|                            | <p>user). Received frames for which multiple error conditions pertain are, according to the conventions of IEEE 802.3 Layer Management, counted exclusively according to the error status presented to the LLC. For interfaces operating at 10 Gb/s, this counter can roll over in less than 80 minutes if it is incrementing at its maximum rate. Since that amount of time could be less than management station's poll cycle time, in order to avoid a loss of information, a management station is advised to poll the dot3HCStatsFrameTooLongs object for 10 Gb/s or faster interfaces. Discontinuities in the value of this counter can occur at re-initialization of the management system, and at other times as indicated by the value of ifCounterDiscontinuityTime.</p>   |
| <b>Mac Rx Error Frames</b> | <p>A count of frames for which reception on a particular interface fails due to an internal MAC sublayer receive error. A frame is only counted by an instance of this object if it is not counted by the corresponding instance of either the dot3StatsFrameTooLongs object, the dot3StatsAlignmentErrors object, or the dot3StatsFCSErrors object. The precise meaning of the count represented by an instance of this object is implementation-specific. In particular, an instance of this object may represent a count of receive errors on a particular interface that are not otherwise counted. For interfaces operating at 10 Gb/s, this counter can roll over in less than 5 minutes if it is incrementing at its maximum rate. Since that amount of time could be less than a management station's poll cycle time, in order to avoid a loss of information, a management station is advised to poll the dot3HCStatsInternalMacReceiveErrors object for 10 Gb/s or faster interfaces. Discontinuities in the value of this counter can occur at re-initialization of the management system, and at other times as indicated by the value of ifCounterDiscontinuityTime.</p> |
| <b>Duplex Status</b>       | <p>The current mode of operation of the MAC entity. 'unknown' indicates that the current duplex mode could not be determined. Management control of the duplex mode is accomplished through 'duplexmode' in ethernet command. Note that this object provides redundant information with etherActualDuplexMode inetherIfTable.</p>  |

## 5.11.2 Ethernet Commands

### 5.11.2.1 Create ethernet intf

**Description:**

Use this command to create a physical Ethernet interface.

**Command Syntax:**

```
create ethernet intf ifname <interface-name> [ip <ip-address>] [mask <net-mask>][usedhcp true|false] [speed {auto|100BT|1000BT}] [type uplink|downlink][enable | disable] [pkttype Mcast|Bcast|UnknownUcast|All|None] [orl decvalue][duplex half| full|auto] [profilename <profilename-val>] [mgmtvlanid <mgmtvlanid-val>] [priority <priority-val>] [trfclassprofileid <trfclassprofileid-val> ] [Ctlpktinstid <ctlpktinstid-val>] [ctlpktgroupid <ctlpktgroupid-val> | none ] [mgmtsvlanid <mgmtsvlanid-val>] [m2vmacdbid <m2vmacdbid-val> |none] [mgmtvlanid <mgmtvlanid-val> ]
```

### 5.11.2.2 Delete ethernet intf

**Description:**

Use this command to delete a physical Ethernet interface.

**Command Syntax:**

```
delete ethernet intf ifname <interface-name>
```

### 5.11.2.3 Get ethernet intf

**Description:**

Use this command to get information about a particular physical Ethernet interface, or about all the interfaces.

**Command Syntax:**

```
get ethernet intf [ifname <interface-name>]
```

### 5.11.2.4 Modify ethernet intf

**Description:**

Use this command to modify physical Ethernet interface configuration.

**Command Syntax:**

```
modify ethernet intf ifname <interface-name> [ip <ip-address>] [mask <net-mask>][usedhcp true|false] [speed {auto|100BT|1000BT}] [type uplink|downlink][enable | disable] [pkttype Mcast|Bcast|UnknownUcast|All|None] [orl decvalue][duplex half| full|auto] [profilename <profilename-val>]
```

[**mgmtvlanid** <mgmtvlanid-val>] [**priority** <priority-val>] [**trfclassprofileid** <trfclassprofileid-val> ] [**Ctlpktinstid** <ctlpktinstid-val>] [ **ctlpktgroupid** <ctlpktgroupid-val> | none ] [**mgmtsvlanid** <mgmtsvlanid-val>] [**m2vmacdbid** <m2vmacdbid-val> |none] [ **mgmtvlanid** <mgmtvlanid-val> ]

### Parameters:

| Name                              | Description  |
|-----------------------------------|--|
| <b>ifname</b><br><interface-name> | <p>This parameter specifies the interface index used for the Ethernet type of interfaces. Valid Values starts from eth-0 and continues to eth-*</p> <p><b>Type</b> : Create – Mandatory<br/>           Delete – Mandatory<br/>           Get – Optional<br/>           Modify – Mandatory</p> <p><b>Valid values</b> : eth-0 - *</p>   |
| <b>ip</b> <ip-address>            | <p>This parameter specifies the IP address configured for the interface. This is required to be configured only if this interface is used for management IP traffic. If it is not configured and 'etherUseDhcp' is configured as GS_FALSE, then management IP traffic will not flow through this interface. 'Modify' of IP Address for an Ethernet interface shall be supported only if some IP address is configured on the interface or 'etherUseDhcp' was configured to "GS_TRUE" previously. If Usedhcp is GS_TRUE and 'modify' is done for this field, then Usedhcp field shall be set to GS_FALSE. Both 'Usedhcp' and this field shall not be specified together.</p> <p><b>Type</b> : Create - Optional.<br/>           Modify - Optional</p> <p><b>Valid Values:</b> Any valid class A/B/C / Classless IP address.</p> <p><b>Default Value:</b> None</p> |

|                                      |  |
|--------------------------------------|--|
| <b>Mask</b> <net-mask>               | <p>This parameter specifies the network mask configured for the interface.</p> <p>This is given in conjunction with IP Address configured and shall be given only if IP address has been given. This shall be removed whenever IP Address is removed. 'Modify' of network mask for an Ethernet interface shall be supported only if some IP address is configured on the interface or 'etherUseDhcp' was configured to "GS_TRUE" previously. If Usedhcp is GS_TRUE and 'modify' is done for this field, then usedhcp field shall be set to GS_FALSE. Both usedhcp and this field shall not be specified together.</p> <p><b>Type</b> : This field is not allowed when a physical interface is specified and IP is 0.0.0.0. In all other cases the field is mandatory.</p> <p><b>Valid Values</b> : 255.0.0.0 - 255.255.255.255</p> <p><b>Default Value:</b> None</p> |
| <b>usedhcp</b> true   false          | <p>This parameter specifies whether a DHCP client is to be triggered to obtain an IP address for this interface. If this is configured as GS_FALSE and 'etherIfIpAddress' is not configured, then management IP traffic will not flow through the interface. If an IP address is configured and 'modify' is done for this field, then 'tEtherIfIpAddress' and 'tAggrIfNetMask' fields shall be set to Zero (0.0.0.0). Both Usedhcp and 'tEtherIfIpAddress' shall not be specified together. In case lftype is 'slave', then this field can not be set to GS_TRUE.</p> <p><b>Type</b> : Optional</p> <p><b>Valid value</b> : true or false</p> <p><b>Default value:</b> false</p>   |
| <b>speed</b> {auto  100 BT  1000BT}+ | <p>The Ethernet speed for the net-side interfaces.</p> <p><b>Type</b> : Optional.</p> <p><b>Valid Values</b> : auto, 100BT, 1000BT.</p> <p><b>Default Value</b> : auto.</p>  |
| <b>type</b> uplink downink           | <p>This parameter specifies the type of the Ethernet interfaces. The Net is towards the NET side (2 at most) and slave means the physical interface connected to the slave device.</p> <p><b>Type</b> : Optional.</p> <p><b>Valid Values</b> : uplink, downlink.</p> <p><b>Default Value</b> : uplink.</p>   |
| <b>enable disable</b>                | <p>Administrative status of the Ethernet interface.</p> <p><b>Type</b> : Modify - Mandatory</p> <p><b>Valid values</b> : enable or disable</p> <p><b>Default value:</b> enable</p>   |



|  |   |
|--|---|
| <p><b>Duplex</b> auto half full</p>                          | <p>This parameter defines the modes, in which the Ethernet Interface can come up. It can be configured as 'auto', 'half', 'full duplex' or a combination of these. Based on the values configured, the Ethernet interface negotiates with the peer entity.</p> <p><b>Type</b> : optional</p> <p><b>Valid values:</b> auto, half, full</p> <p><b>Default value:</b> auto</p>   |
| <p><b>Pktype</b><br/>Mcast Bcast UnknownUcast   All None</p> | <p>This parameter defines the packet type supported by the interface. 'etherPktTypeSupported' shall be configured for every Ethernet interface. By default, all packets will be transmitted. The interface shall not transmit any other packet type than that configured.</p> <p><b>Type:</b> Create - optional<br/>Modify - optional</p> <p><b>Valid values</b> : Mcast, Ucast, UnknownUcast, All</p> <p><b>Default Value:</b> All</p>   |
| <p><b>Orl decvalue</b></p>                                   | <p>This parameter specifies the output rate limiting value to be applied on this Interface. The unit for the same is in Mbits/sec.</p> <p><b>Type:</b> Create - Optional<br/>Modify - Optional</p> <p><b>Valid Values:</b> 1 -100</p> <p><b>Default Value:</b> 100</p>  |
| <p><b>ProfileName</b><br/>&lt;profilename-val&gt;</p>        | <p>This parameter specifies the scheduling profile to be associated with the Ethernet interface.</p> <p><b>Type</b> : Optional.</p> <p><b>Default Value</b> : SPROFILE</p>  |
| <p><b>mgmtvlanid</b><br/>&lt;mgmtvlanid&gt;</p>              | <p>This parameter specifies the VLAN (C-Vlan) for management traffic on this interface. Non-zero value of this field is valid only if either 'ip' field is non-zero or 'usedhcp' field is true. If no Management VLAN id is specified (in the create operation) or its value is set to zero (either in create or modify operation), then the system shall use the value of 'portvlanid' associated with the bridge port created on this interface as the Management VLAN Index. In case the management VLAN (i.e. 'mgmtvlanid' or the associated 'portvlanid', if 'mgmtvlanid' is zero) does not exist on the system, then IP-based management on this management VLAN shall not happen on the interface till the corresponding VLAN is created with the Net-side port as its member. In stacked-VLAN mode, the VLAN filtering mentioned above is based on virtual-VLAN mapped to C-Vlan and S-Vlan for the frame.</p> <p><b>Type</b> : Create - optional<br/>Modify - optional</p> <p><b>Valid values:</b> 0 -4095</p> |

|  |  |
|--|--|
| <p><b>priority</b> &lt;priority-val&gt;</p>                            | <p>This parameter specifies the priority to be set in Tagged Ethernet PDUs sent on Management VLAN over this interface. This field is valid only if either 'ip' field is non-zero or 'usedhcp' field is true. In Native-VLAN mode, this priority shall be used for C-Vlan tag, while in stacked-VLAN mode it shall be used for S-Vlan tag.</p> <p><b>Type:</b> Create - optional<br/> Modify - optional</p> <p><b>Valid values:</b> 0 -7</p>   |
| <p><b>trfclassprofileid</b></p>  | <p>This parameter specifies the traffic class profile identifier to be associated with the Ethernet interface.</p> <p><b>Type:</b> Optional</p> <p><b>Valid values:</b> 1 to 10</p> <p><b>Default Value:</b> 1</p>   |
| <p><b>Ctlpktinstid</b></p>   | <p>This specifies the control packet instance identifier associated with this interface. If the user does not provide any instance identifier while creating an interface, an instance is created internally from the default profile governed by the macro 2 and associated to the interface. This will reduce the total number to instances that can be now created by one. The default instance is governed by the macro 0.</p> <p><b>TYPE:</b> Create -- Optional</p> <p><b>Valid Values:</b> 1 - 26</p> <p><b>Default Value:</b> 0</p>                                    |
| <p><b>ctlpktgroupid</b><br/> &lt;ctlpktgroupid-val&gt;  <br/> none</p> | <p>This parameter specifies the Control packet instance group associated with this Ethernet interface. The flows for this interface shall be mapped to control packet instances as mapped for the flows corresponding to the groupid configured in ctlpkt group info command. If this group does not have entries for all of the flows, then those flows shall be mapped to the ctlpktinstid. If groupid is 0, then all the flows shall be mapped to ctlpktinstid.</p> <p><b>Type:</b> Create -- Optional</p> <p><b>Valid values:</b> 0 -50</p> <p><b>Default value:</b> 0</p> |

|   |  |
|---|--|
| <b>mgmtsvlanid</b>                      | <p>This parameter specifies the S-VLAN for management traffic on this interface. It is applicable only in stacked-VLAN Mode. Non-zero value of this field is valid only if either 'etherIfIpAddress' field is non-zero or 'etherUseDhcp' field is true. If no management S-Vlan id is specified (in the create operation) or its value is set to zero (either in create or modify operation), then the system shall use the value of 'psvlanid' associated with the bridge port created on this interface as the management VLAN id. In case the management VLAN (virtual VLAN mapped to S-VLAN and C-VLAN for the frame) does not exist (ie. Virtual VLAN mapped to 'mgmtsvlanid' or the associated 'psvlanid', if 'mgmtsvlanid' is zero) on the system, then IP-based management shall not happen on the interface till the corresponding virtual-VLAN is created with the Net-side port as its member.</p> <p><b>Type :</b> Create - optional<br/> Modify - optional</p> <p><b>Valid values:</b> 0 - 4095</p> |
| <b>m2vmacdbid</b>                       | <p>This field specifies the M2VMac Database Id associated with this interface. The value 0 means Virtual MAC feature is disabled on this interface. This field can be modified only when the interface is disabled.</p> <p><b>Type:</b> Create - optional<br/> Modify - optional</p> <p><b>Valid values:</b> 1 -GS_CFG_MAX_M2VMAC_DATABASES</p>  |
| <b>mgmttvlanid</b><br><mgmttvlanid-val> | <p>This specifies the value to be used for inserting TVLAN id or vlan id of the third Vlan tag in the transmitted Ethernet frames and that is expected in received frames over this interface. Currently this is configurable and supported only for management Ethernet interface. For data Ethernet interface, the value of TVLAN id is configurable and used from the system sizing table. If the value for TVLAN id configured on a management Ethernet interface is zero then third vlan tag shall not be added neither shall it be supported in received frames. This attribute is applicable only in stacked-VLAN mode.</p> <p><b>Type:</b> Create -- Optional<br/> Modify -- Optional</p> <p><b>Valid values:</b> 0 - 4095</p> <p><b>Default value:</b> 0</p>  |

**Example:**

```
create ethernet intf ifname eth-0 ip 192.168.1.1 mask 255.255.255.0 speed 100bt
profilename sprofile mgmtvlanid 2 priority 2 trfclassprofileid 1 Ctlpktinstid 1
ctlpktgroupid 1
```

**Output:**

Verbose Mode On

Entry Created

```

Interface           : eth-0
Type                : Uplink           UseDhcp           : False
IP Address          : 192.168.1.1       Mask              : 255.255.0.0
Pkt Type            : Mcast
Orl(mbps)           : 100
Configured Duplex   : Auto             Duplex            : None
Configured Speed    : Auto
Profile Name        : SPPROFILE
Mgmt VLAN Index     : 2
Mgmt S-VLAN Index   : 2
Mgmt T-VLAN Index   : 2
Tagged Mgmt PDU Prio: 2
trfclassprofileid   : 1
Ctl Pkts Instance Id:1           Ctl Pkts Group Id : 1
Speed               : -
Operational Status  : Down             Admin Status      : Up

```

Verbose Mode Off:

Entry Created

**Output field:**

| Field          | Description  |
|----------------|--|
| <b>If-Name</b> | This parameter specifies the interface index used for the Ethernet type of interfaces. Valid Values starts from eth-0 and continues to eth-*   |
| <b>Type</b>    | This parameter specifies the type of the Ethernet interfaces. The Net is towards the NET side (2 at most) and slave means the physical interface connected to the slave device.  |
| <b>UseDhcp</b> | This parameter specifies whether a DHCP client is to be triggered to obtain an IP address for this interface. If this is configured as GS_FALSE and 'etherIfIpAddress' is not configured, then management IP traffic will not flow through the interface. If an IP address is configured and 'modify' is done for this field, then 'tEtherIfIpAddress' and 'tAggrIfNetMask' fields shall be set to Zero (0.0.0.0). Both Usedhcp and 'tEtherIfIpAddress' shall not be specified |

|                          |  |
|--------------------------|--|
|                          | together. In case lftype is 'slave', then this field can not be set to GS_TRUE.  |
| <b>Ip Address</b>        | This parameter specifies the IP address configured for the interface. This is required to be configured only if this interface is used for management IP traffic. If it is not configured and 'etherUseDhcp' is configured as GS_FALSE, then management IP traffic will not flow through this interface. 'Modify' of IP Address for an Ethernet interface shall be supported only if some IP address is configured on the interface or 'etherUseDhcp' was configured to "GS_TRUE" previously. If Usedhcp is GS_TRUE and 'modify' is done for this field, then Usedhcp field shall be set to GS_FALSE. Both 'Usedhcp' and this field shall not be specified together. |
| <b>Mask</b>              | This parameter specifies the network mask configured for the interface. This is given in conjunction with IP Address configured and shall be given only if IP address has been given. This shall be removed whenever IP Address is removed. 'Modify' of network mask for an Ethernet interface shall be supported only if some IP address is configured on the interface or 'etherUseDhcp' was configured to "GS_TRUE" previously. If Usedhcp is GS_TRUE and 'modify' is done for this field, then usedhcp field shall be set to GS_FALSE. Both usedhcp and this field shall not be specified together.  |
| <b>pkttype</b>           | This parameter defines the packet type supported by the interface. 'etherPktTypeSupported' shall be configured for every Ethernet interface. By default, all packets will be transmitted. The interface shall not transmit any other packet type than that configured.   |
| <b>Orl</b>               | This parameter specifies the output rate limiting value to be applied on this Interface. The units for the same is in Mbits/sec  |
| <b>Configured Duplex</b> | The duplex mode to be used by the interface, as configured by the user.  |
| <b>Duplex</b>            | This parameter defines the modes, in which the Ethernet Interface can come up. It can be configured as 'auto', 'half', 'full duplex' or a combination of these. Based on the values configured, the Ethernet interface negotiates with the peer entity.  |

|                             |   |
|-----------------------------|---|
| <b>Configured Speed</b>     | The Ethernet speed for the net-side interfaces.   |
| <b>Mgmt VLAN Index</b>      | This parameter specifies the VLAN (C-Vlan) for management traffic on this interface. Non-zero value of this field is valid only if either 'ip' field is non-zero or 'usedhcp' field is true. If no Management VLAN id is specified (in the create operation) or its value is set to zero (either in create or modify operation), then the system shall use the value of 'portvlanid' associated with the bridge port created on this interface as the Management VLAN Index. In case the management VLAN (i.e. 'mgmtvlanid' or the associated 'portvlanid', if 'mgmtvlanid' is zero) does not exist on the system, then IP-based management on this management VLAN shall not happen on the interface till the corresponding VLAN is created with the Net-side port as its member. In stacked-VLAN mode, the VLAN filtering mentioned above is based on virtual-VLAN mapped to C-Vlan and S-Vlan for the frame. |
| <b>Mgmt S-VLAN Index</b>    | This parameter specifies the S-VLAN for management traffic on this interface. It is applicable only in stacked-VLAN Mode. Non-zero value of this field is valid only if either 'etherIfIpAddress' field is non-zero or 'etherUseDhcp' field is true. If no management S-Vlan id is specified (in the create operation) or its value is set to zero (either in create or modify operation), then the system shall use the value of 'psvlanid' associated with the bridge port created on this interface as the management VLAN id. In case the management VLAN (virtual VLAN mapped to S-VLAN and C-VLAN for the frame) does not exist (ie. Virtual VLAN mapped to 'mgmtsvlanid' or the associated 'psvlanid', if 'mgmtsvlanid' is zero) on the system, then IP-based management shall not happen on the interface till the corresponding virtual-VLAN is created with the Net-side port as its member.          |
| <b>Tagged Mgmt PDU Prio</b> | This parameter specifies the priority to be set in Tagged Ethernet PDUs sent on Management VLAN over this interface. This field is valid only if either 'ip' field is non-zero or 'usedhcp' field is true. In Native-VLAN mode, this priority shall be used for C-Vlan tag, while in stacked-VLAN mode it shall be used for S-Vlan tag.   |
| <b>ProfileName</b>          | This parameter specifies the scheduling profile to be associated with the Ethernet interface.   |

|                             |   |
|-----------------------------|---|
| <b>Speed</b>                | The actual speed of the interface.  |
| <b>Operational Status</b>   | The operational status of the interface.  |
| <b>Admin Status</b>         | The administrative status of the interface.   |
| <b>trfclassprofileid</b>    | This parameter specifies the traffic class profile identifier to be associated with the Ethernet interface.   |
| <b>Ctl Pkts Instance Id</b> | This specifies the control packet instance identifier associated with this interface. If the user does not provide any instance identifier while creating an interface, an instance is created internally from the default profile governed by the macro 2 and associated to the interface. This will reduce the total number to instances that can be now created by one. The default instance is governed by the macro 0.   |
| <b>Ctl Pkts Group Id</b>    | This parameter specifies the Control packet instance group associated with this Ethernet interface. The flows for this interface shall be mapped to control packet instances as mapped for the flows corresponding to the groupid configured in ctlpkt group info command. If this group does not have entries for all of the flows, then those flows shall be mapped to the ctlpktinstid. If groupid is 0, then all the flows shall be mapped to ctlpktinstid.   |
| <b>M2VMacDbld</b>           | This field specifies the M2VMac Database Id associated with this interface. The value 0 means Virtual MAC feature is disabled on this interface. This field can be modified only when the interface is disabled.  |
| <b>Mgmt T-VLAN Index</b>    | This specifies the value to be used for inserting TVLAN id or vlan id of the third Vlan tag in the transmitted Ethernet frames and that is expected in received frames over this interface. Currently this is configurable and supported only for management Ethernet interface. For data Ethernet interface, the value of TVLAN id is configurable and used from the system sizing table. If the value for TVLAN id configured on a management Ethernet interface is zero then third vlan tag shall not be added neither shall it be supported in received frames. This attribute is applicable only in stacked-VLAN mode. |

## References:

- Ethernet stats command.

## 5.12 EOA Commands

---

### 5.12.1 EOA Commands

#### 5.12.1.1 Create eoa intf

**Description:**

Use this command to create an EoA interface towards the CPE side.

**Command Syntax:**

```
create eoa intf ifname <interface-name> lowif <low-interface-name> [pkttype
{multicast |broadcast |unknown-unicast} + | all|None] [fcs false | true]
[enable|disable] [inactivitytmrintrvl <inactivitytmrintrvl-val>] [m2vmacdbid
<m2vmacdbid-val> | none] [configstatus normal | config]
```

#### 5.12.1.2 Delete oea intf

**Description:**

Use this command to delete an EoA interface.

**Command Syntax:**

```
delete eoa intf ifname <interface-name>
```

#### 5.12.1.3 Get eoa intf

**Description:**

Use this command to get information on a particular EoA interface, or on all the EoA interfaces.

**Command Syntax:**

```
get eoa intf [ifname <interface-name>]
```

#### 5.12.1.4 Modify eoa intf

**Description:**

Use this command to modify the properties of an eoa interface.

**Command Syntax:**

```
modify eoa intf ifname <interface-name> [pkttype {multicast |broadcast
|unknown-unicast} + | all| none] [fcs false | true] [m2vmacdbid
<m2vmacdbid-val> | none] [enable|disable] [inactivitytmrintrvl
<inactivitytmrintrvl>]
```



## Parameters:

| Name  | Description  |
|---|--|
| <b>ifname</b> <interface-name<br>>  | This parameter specifies the name assigned to this interface.<br><b>Type:</b> Create – Mandatory<br>Delete – Mandatory<br>Get – Optional<br>Modify – Mandatory<br><b>Valid values:</b> eoa-0,eoa-1....   |
| <b>lowif</b><br><low-interface-name>  | This parameter specifies the lower interface index. It contains ifindex of the AAL5 or VC Aggregation interface.<br><b>Type:</b> Mandatory<br><b>Valid Values :</b> aal5-0 - *   |
| <b>pkttype {multicast<br/> broadcast<br/> unknownunicast}+  <br/>all none</b> | This parameter defines the packet type supported by the interface. 'EoAPktTypeSupported' shall be configured for every CPE side Ethernet interface. By default, the option taken is 'ALL' and it means that all packets will be transmitted. The value 'None' means that normal Ucast packets will be transmitted. The interface shall not transmit any other packet type than the ones configured.<br><b>Type:</b> Optional.<br><b>Valid Values:</b> {multicast  broadcast  unknown-unicast}+   all<br><b>Default Value:</b> all.                       |
| <b>fcs false   true</b>   | This specifies whether Ethernet FCS needs to be computed for the CPE side Ethernet interfaces. This can be set to true only if encaptype of the lower interface is Ethernet.<br><b>Type:</b> Optional<br><b>Valid Values:</b> false or true<br><b>Default Value:</b> false.  |
| <b>Enable disable</b>   | Administrative status of the interface<br><b>Type:</b> Optional<br><b>Valid values :</b> enable or disable<br><b>Default Values:</b> enable  |
| <b>inactivitymrintrvl</b><br><inactivitymrintrvl-val>                         | This field specifies the time (in seconds) after which interfaces shall be marked inactive if there is no data activity on this interface during this interval. This is used only when the bit corresponding to "ConfigEntry" is set for gsvEoaConfigStatus field. A value of zero means the timer is not running. In Autosensing scenario, an inactive interface is a candidate to deletion in case another protocol is sensed on Atm Vc Interface on which this interface is created.<br><b>Type:</b> Optional<br><b>Valid Values:</b> 0 to 0xffffffff |

|  |   |
|--|---|
|  | <b>Default Value:</b> 0   |
| <b>configstatus normal   config</b>                    | <p>This parameter describes the configuration mode for this interface. The value of this parameter can be normal or config. If the value is config, then this interface shall be created, but will have a dormant status. Only after the receipt of an EoA packet from the CPE side, this interface shall become active.</p> <p><b>Type:</b> Optional</p> <p><b>Valid Values:</b> normal   config</p> <p><b>Default Value:</b> normal</p> |
| <b>m2vmacdbid</b><br><m2vmacdbid-val>  <br><b>none</b> | <p>This field specifies the M2VMac Database Id associated with this interface. The value 0 means Virtual MAC feature is disabled on this interface. This field can be modified only when the interface is disabled.</p> <p><b>Type:</b> Create — Optional<br/>Modify — Optional</p> <p><b>Valid values:</b> 1 - 1154</p> <p><b>Default value:</b> 0</p>   |

### Example:

```
$create eoa intf ifname eoa-0 lowif aal5-0 m2vmacdbid 1 enable fcs false
```

### Output:

```
Verbose Mode On
Entry Created
```

```
IfName           : eoa-0           LowIfName      : aal5-0
FCS              : False
Pkt Type         : ALL
InActivity Tmr Interval : 3
M2VMac Database Id   : 1
Config Status    : Normal
Oper Status      : Down           Admin Status   : Up
```

### Output Fields:

| FIELD            | Description  |
|------------------|--|
| <b>IfName</b>    | The name of the interface that has been created.   |
| <b>LowIfName</b> | This parameter specifies the lower interface index. It contains ifindex of the AAL5 or VC Aggregation interface. |
| <b>FCS</b>       | This specifies whether Ethernet FCS needs to be computed for the CPE side Ethernet interfaces. This can          |

|                                |   |
|--------------------------------|---|
|                                | be set to true only if encapsype of the lower interface is Ethernet.  |
| <b>Pkt Type</b>                | This parameter defines the packet type supported by the interface. 'EoAPktTypeSupported' shall be configured for every CPE side Ethernet interface. By default, the option taken is 'ALL' and it means that all packets will be transmitted. The value 'None' means that normal Ucast packets will be transmitted. The interface shall not transmit any other packet type than the ones configured.   |
| <b>Admin Status</b>            | The desired state of the interface. It may be either Up or Down   |
| <b>Oper Status</b>             | The actual/current state of the interface. It can be either up or down.   |
| <b>InActivity Tmr Interval</b> | This field specifies the time (in seconds) after which interfaces shall be marked inactive if there is no data activity on this interface during this interval. This is used only when the bit corresponding to "ConfigEntry" is set for gsvEoaConfigStatus field. A value of zero means the timer is not running. In Autosensing scenario, an inactive interface is a candidate to deletion in case another protocol is sensed on Atm Vc Interface on which this interface is created.                       |
| <b>Config Status</b>           | This parameter describes the configuration mode for this interface. The value of this parameter can be Normal, Config, NotInUse, or InUse. If the value is Config, then this interface shall be created, but will have a dormant status. Only after the receipt of an EoA packet from the CPE side, this interface shall become active. The 'InUse' and 'NotInUse' bits are read-only bits. The 'NotInUse' bit indicates that the entry is dormant and the 'InUse' bit indicates that the entry is activated. |
| <b>M2VMac Database Id</b>      | This field specifies the M2VMac Database Id associated with this interface. The value 0 means Virtual MAC feature is disabled on this interface. This field can be modified only when the interface is disabled.  |

### References:

- Ethernet commands
- Ethernet Stats commands.

## 5.13 Filtering Commands

---

### 5.13.1 ACL Global Macentry Commands

#### 5.13.1.1 Get acl global macentry

**Description:**

Use this command to get.

**Command Syntax:**

**get acl global macentry [macaddr <macaddr-val >]**

#### 5.13.1.2 Create acl global macentry

**Description:**

Use this command to create.

**Command Syntax:**

**create acl global macentry macaddr <macaddr-val > [deny disable |enable]  
[track disable | enable]**

#### 5.13.1.3 Delete acl global macentry

**Description:**

Use this command to delete.

**Command Syntax:**

**delete acl global macentry macaddr <macaddr-val >**

#### 5.13.1.4 Modify acl global macentry

**Description:**

Use this command to modify.

**Command Syntax:**

**modify acl global macentry macaddr <macaddr-val > [deny disable | enable]  
[track disable | enable]**

## Parameters:

| Name                             | Description  |
|----------------------------------|--|
| <b>macaddr</b><br><macaddr-val > | Unicast Source MAC Address, which needs to be tracked/denied access<br><b>Type:</b> Create --Mandatory<br>Delete --Mandatory<br>Modify -- Mandatory<br>Get Optional  |
| <b>deny disable   enable</b>     | This flag specifies if the MAC address is to be denied access.<br><b>Type:</b> Create --Optional<br>Modify -- Optional<br><b>Default value:</b> enable   |
| <b>track disable   enable</b>    | This flag specifies if the MAC address is to be tracked accross different ports. A trap is raised when packet from the address comes over a port for the first time and when it changes the port.<br><b>Type:</b> Create --Optional<br>Modify -- Optional<br><b>Default value:</b> disable |

## Example:

```
$ create acl global macentry macaddr 00:30:4f:a0:d1:34 deny enable track enable
```

## Output:

```
Verbose Mode On  
Entry Created
```

```
Mac Address           : 00:30:4f:a0:d1:34  
Deny                  : true      Track : enable  
Number of times Port changed : 2  
Verbose Mode Off:  
Entry Created
```

## Output field:

| Field                               | Description  |
|-------------------------------------|--|
| <b>Mac Address</b>                  | Unicast Source MAC Address, which needs to be tracked/denied access  |
| <b>Deny</b>                         | This flag specifies if the MAC address is to be denied access.   |
| <b>Track</b>                        | This flag specifies if the MAC address is to be tracked accross different ports. A trap is raised in case packet from the address comes over a port for the first time and when it changes the port. |
| <b>Number of times Port changed</b> | This specifies the number of times port has been changed by the MAC address.   |

## 5.13.2 Clfr list genentry commands

### 5.13.2.1 Get clfr list genentry

**Description:**

Use this command to get.

**Command Syntax:**

### 5.13.2.2 Create clfr list genentry

**Description:**

Use this command to create.

**Command Syntax:**

**create clfr list genentry ifname** <interface-name>**value** <value-val> [**valtype** U8|U16|U32]

### 5.13.2.3 Delete clfr list genentry

**Description:**

Use this command to delete.

**Command Syntax:**

**delete clfr list genentry ifname** <interface-name> [**value** <value-val>]

**Parameter:**

| Name                              | Description  |
|-----------------------------------|--|
| <b>ifname</b><br><interface-name> | Name of ethernet, eoa, ipoe or pppoe interface, for which the classifier generic list is created. Valid values for the field are between EOA-0 and EOA-23 or between eth-0 and eth-1or between IPOE-0 and IPOE-191 or between PPPOE-0 and PPPOE-192.<br><b>Type:</b> Create -- Mandatory<br>Delete -- Mandatory<br>Get -- Optional<br><b>Valid values:</b> eth-*, eoa-*, pppoe-*,ipoe* |
| <b>value</b> <value-val>          | List Entry Value, of the classifier generic list<br><b>Type:</b> Create -- Mandatory<br>Delete -- Mandatory<br>Get -- Optional   |

|                           |  |
|---------------------------|--|
| <b>Valtype</b> U8 U16 U32 | <p>This field specifies value type of the entry. The value type for all entries on an interface should be same. Value type should match value type of matchingenlist nodes in case a tree attached on same interface. It should be 'U32' in case a rule containing IP subrule or Generic subrule with cmptype as InGenList or NotInGenList is attached on same interface. Currently only 'U32' value is supported.</p> <p>Create -- Optional</p> |
|---------------------------|--|

**Example:**

```
$ create clfr list genentry lfname eoa-1 value 0xAC1901AA valtype u8
```

**Output:**

Verbose Mode On

Entry Created

If Name : eoa-1

Value : 0xAC1901AA

Value Type : U32

Verbose Mode Off:

Entry Created

**Output field:**

| Field             | Description   |
|-------------------|---|
| <b>If Name</b>    | Name of ethernet, eoa, ipoe or pppoe interface, for which the classifier generic list is created. Valid values for the field are between EOA-0 and EOA-23 or between eth-0 and eth-1 or between IPOE-0 and IPOE-191 or between PPPOE-0 and PPPOE-192.   |
| <b>Value</b>      | List Entry Value, of the classifier generic list  |
| <b>Value Type</b> | This field specifies value type of the entry. The value type for all entries on an interface should be same. Value type should match value type of matchingenlist nodes in case a tree attached on same interface. It should be 'U32' in case a rule containing IP subrule or Generic subrule with cmptype as InGenList or NotInGenList is attached on same interface. Currently only 'U32' value is supported. |

## 5.13.3 ACL Port Macentry Commands

### 5.13.3.1 Get acl port macentry

**Description:**

Use this command to get.

**Command Syntax:**

**get acl port macentry** [**portid** <portid-val >] [**macaddr** <macaddr-val >]

### 5.13.3.2 Create acl port macentry

**Description:**

Use this command to create.

**Command Syntax:**

**create acl port macentry portid** <portid-val > **macaddr** <macaddr-val >

### 5.13.3.3 Delete acl port macentry

**Description:**

Use this command to delete.

**Command Syntax:**

**delete acl port macentry portid** <portid-val > **macaddr** <macaddr-val>

**Parameter:**

| Name                            | Description   |
|---------------------------------|---|
| <b>portid</b> <portid-val>      | Bridge Port Id, for which the port MAC Address entry is created<br><b>Type:</b> Create --Mandatory<br>Delete --Mandatory<br>Get -- Optional<br><b>Valid values:</b> 1-578 |
| <b>macaddr</b><br><macaddr-val> | Unicast Source MAC Address, which is to be allowed access over the particular port.<br><b>Type:</b> Create --Mandatory<br>Delete --Mandatory<br>Get -- Optional           |

**Example:**

\$ create acl port macentry portId 2 macaddr 00:30:4f:a0:d1:34



**Output:**

Verbose Mode On  
Entry Created

PortId : 2  
Mac Address : 00:30:4f:a0:d1:34  
Verbose Mode Off:  
Entry Created

**Output field:**

| Field       | Description   |
|-------------|---|
| PortId      | Bridge Port Id, for which the port MAC Address entry is created                     |
| Mac Address | Unicast Source MAC Address, which is to be allowed access over the particular port. |

**Caution:**

- An entry in this table shall not be applicable for a bridge port created over PPPOE/IPOE interface.

**5.13.4 Clfr namedlist genentry Commands****5.13.4.1 Get namedlist genentry****Description:**

Use this command to get.

**Command Syntax:**

**get clfr namedlist genentry** [**listid** <listid-val>] [**value** <value-val>]

**5.13.4.2 Create clfr namedlist genentry****Description:**

Use this command to create.

**Command Syntax:**

**create clfr namedlist genentry listid** <listid-val>**value** <value-val>

### 5.13.4.3 Delete clfr namedlist genentry

#### Description:

Use this command to delete.

#### Command Syntax:

```
delete clfr namedlist genentry listid <listid-val>value <value-val>
```

#### Parameter:

| Name                       | Description   |
|----------------------------|---|
| <b>listid</b> <listid-val> | This field stores the list identifier value. There must be a row indexed on the same id in the Classifier Named List Table.<br><b>Type:</b> Create -- Mandatory<br>Delete -- Mandatory<br>Get -- Optional<br><b>Valid values:</b> 1 - 65535 |
| <b>value</b> <value-val>   | This field specifies the list entry value. The value range depends upon value type of list, as specified in Classifier Named List table.<br><b>Type:</b> Create -- Mandatory<br>Delete -- Mandatory<br>Get -- Optional                      |

#### Example:

```
$ create clfr namedlist genentry listid 2 value 0xAC1901AA
```

#### Output:

```
Verbose Mode On  
Entry Created  
ListId : 2  
Value : 0xAC1901AA  
Verbose Mode Off:  
Entry Created
```

#### Output field:

| Field         | Description  |
|---------------|--|
| <b>ListId</b> | This field stores the list identifier value. There must be a row indexed on the same id in the Classifier Named List Table.              |
| <b>Value</b>  | This field specifies the list entry value. The value range depends upon value type of list, as specified in Classifier Named List table. |

## 5.13.5 Clfr namedlist info Commands

### 5.13.5.1 Get clfr namedlist info

**Description:**

Use this command to get.

**Command Syntax:**

**get clfr namedlist info [listid <listid-val>]**

### 5.13.5.2 Create clfr namedlist info

**Description:**

Use this command to create.

**Command Syntax:**

**create clfr namedlist info listid <listid-val> [valtype U8 | U16 | U32]**

### 5.13.5.3 Delete clfr namedlist info

**Description:**

Use this command to delete.

**Command Syntax:**

**delete clfr namedlist info listid <listid-val>**

### 5.13.5.4 Delete clfr namedlist info

**Description:**

Use this command to modify.

**Command Syntax:**

**modify clfr namedlist info listid <listid-val> [valtype U8 | U16 | U32]**

**Parameter:**

| Name                 | Description   |
|----------------------|---|
| <b>listid</b> listid | This field stores the list identifier value.<br><b>Type:</b> Create -- Mandatory<br>Delete -- Mandatory<br>Modify -- Mandatory<br>Get -- Optional<br><b>Valid values:</b> 1 - 65535 |

|                               |  |
|-------------------------------|--|
| <b>valtype</b> U8   U16   U32 | <p>This field specifies the value type of list. Value type should match value type of matchingenlist nodes in case a tree attached on same interface as the list. It should be 'U32' in case a rule containing IP subrule or Generic subrule with cmptype as InGenList or NotInGenList is attached on same interface. Currently only 'U32' value is supported.</p> <p><b>Type:</b> Create -- Optional<br/> Modify -- Optional</p> <p><b>Default value:</b> U32</p> |
|-------------------------------|--|

**Example:**

```
$ create clfr namedlist info listid 2 valtype u32
```

**Output:**

```
Verbose Mode On
Entry Created
```

```
ListId      : 2
Value Type  : u32
Verbose Mode Off:
Entry Created
```

**Output field:**

| Field             | Description   |
|-------------------|---|
| <b>ListId</b>     | This field stores the list identifier value.  |
| <b>Value Type</b> | This field specifies the value type of list. Value type should match value type of matchingenlist nodes in case a tree attached on same interface as the list. It should be 'U32' in case a rule containing IP subrule or Generic subrule with cmptype as InGenList or NotInGenList is attached on same interface. Currently only 'U32' value is supported. |

## 5.13.6 Clfr namedlist map Commands

### 5.13.6.1 Get clfr namedlist map

**Description:**

Use this command to get.

**Command Syntax:**

**get clfr namedlist map [ifname <interface-name>]**

### 5.13.6.2 Create clfr namedlist map

**Description:**

Use this command to create.

**Command Syntax:**

**create clfr namedlist map ifname <interface-name>listid <listid-val>**

### 5.13.6.3 Delete clfr namedlist map

**Description:**

Use this command to delete.

**Command Syntax:**

**delete clfr namedlist map ifname <interface-name>**

**Parameter:**

| Name                           | Description  |
|--------------------------------|--|
| <b>ifname</b> <interface-name> | This specifies the eoa ,ppoe, ipoe or ethernet interface to which named generic list is attached. Valid values for the field are between EOA-0 and EOA-23 or between eth-0 and eth-1or between IPOE-0 and IPOE-191 or between PPPOE-0 and PPPOE-192.<br><b>Type:</b> Create -- Mandatory<br>Delete -- Mandatory<br>Get -- Optional |
| <b>listid</b> <listid-val>     | This field stores the list identifier value.<br><b>Type:</b> Create -- Mandatory<br><b>Valid values:</b> 1 - 65535   |

**Example**

\$ create clfr namedlist map ifname eoa-1 listid 2

**Output:**

Verbose Mode On  
Entry Created

IfName : eoa-1

ListId : 2

Verbose Mode Off:

Entry Created

**Output field:**

| Field  | Description  |
|--------|--|
| IfName | This specifies the eoa ,pppoe, ipoe or ethernet interface to which named generic list is attached. Valid values for the field are between EOA-0 and EOA-23 or between eth-0 and eth-1 or between IPOE-0 and IPOE-191 or between PPPOE-0 and PPPOE-192. |
| ListId | This field stores the list identifier value.   |

**5.13.7 Clfr profile branch Commands****5.13.7.1 Get clfr profile branch****Description:**

Use this command to get.

**Command Syntax:**

**get clfr profile branch** [pname <pname-val>] [nodeid <nodeid-val>] [brtype <brtype-val>]

**5.13.7.2 Create clfr profile branch****Description:**

Use this command to create.

**Command Syntax:**

**create clfr profile branch** pname <pname-val> nodeid <nodeid-val> brtype <brtype-val> [cnodeid <cnodeid-val>]

### 5.13.7.3 Delete clfr profile branch

#### Description:

Use this command to delete.

#### Command Syntax:

```
delete clfr profile branch pname <pname-val> nodeid <nodeid-val> brtype
<brtype-val>
```

#### Parameter:

| Name                         | Description   |
|------------------------------|---|
| <b>pname</b> <pname-val>     | Name of the classifier profile<br><b>Type:</b> Create -- Mandatory<br>Delete -- Mandatory<br>Get -- Optional  |
| <b>nodeid</b> <nodeid-val>   | Node Id of the node, with which the branch is to be attached.<br><b>Type:</b> Create -- Mandatory<br>Delete -- Mandatory<br>Get -- Optional<br><b>Valid values:</b> 1 - 4   |
| <b>brtype</b> <brtype-val>   | This specifies the branch types. For a unary type node, only onlybr(0xffffffff9) branch type is allowed. For binary type and Linear/Non-Linear(Access Deny only) type, TrueBr(0xfffffffffd) and FalseBr(0xfffffffffe) are allowed. For ternary type nodes LtBr(0xfffffffffc), GtBr(0xfffffffffb), EqBr(0xfffffffffa) are allowed. For Linear, Non-Linear (match in list) the actual value is allowed. The actual value can be U8, U16, U32, U64, atmIf, ethernetIf, aal5vc.<br><b>Type:</b> Create -- Mandatory<br>Delete -- Mandatory<br>Get -- Optional |
| <b>cnodeid</b> <cnodeid-val> | Child Node Id<br><b>Type:</b> Create -- Optional<br><b>Default value:</b> 0   |

#### Example:

```
$ create clfr profile branch pname IGMP nodeid 3 brtype truebr
```

## Output

Verbose Mode On

Entry Created

Profile Name : IGMP

Node Id : 3 Branch type : true

Child NodeId : 5

Verbose Mode Off:

Entry Created

## Output field:

| Field        | Description  |
|--------------|--|
| Profile Name | Name of the classifier profile   |
| Node Id      | Node Id of the node, with which the branch is to be attached.  |
| Branch type  | This specifies the branch types. For a unary type node, only onlybr(0xfffffffffff9) branch type is allowed. For binary type and Linear/Non-Linear(Access Deny only) type, TrueBr(0xfffffffffffd) and FalseBr(0xffffffffffffe) are allowed. For ternary type nodes LtBr(0xfffffffffffcc), GtBr (0xfffffffffffb), EqBr (0xfffffffffffa) are allowed. For Linear, Non-Linear (match in list) the actual value is allowed. The actual value can be U8, U16, U32, U64, atmIf, ethernetIf, aal5vc. |
| Child NodeId | Child Node Id  |

## 5.13.8 Clfr profile info Commands

### 5.13.8.1 Get clfr profile info

#### Description:

Use this command to get.

#### Command Syntax:

**get clfr profile info [pname <pname-val>]**



### 5.13.8.2 Create clfr profile info

**Description:**

Use this command to create.

**Command Syntax:**

**create clfr profile info pname** <pname-val>

### 5.13.8.3 Delete clfr profile info

**Description:**

Use this command to delete.

**Command Syntax:**

**delete clfr profile info pname** <pname-val>

### 5.13.8.4 Modify clfr profile info

**Description:**

Use this command to modify.

**Command Syntax:**

**modify clfr profile info pname** <pname-val> [**descr** <descr-val>] [**rnode** <rnode-val>] [enable | disable]

**Parameter:**

| Name                     | Description  |
|--------------------------|--|
| <b>pname</b> <pname-val> | Name of the classifier profile<br><b>Type:</b> Create -- Mandatory<br>Delete -- Mandatory<br>Modify -- Mandatory<br>Get -- Optional<br><b>Default value:</b> ----- |
| <b>descr</b> <descr-val> | A brief description can be given with profile, to identify the profile<br><b>Type:</b> Create -- Optional<br>Modify -- Optional<br><b>Default value:</b> 0         |
| <b>rnode</b> <rnode-val> | Root node Id of the profile. Each profile can have only one root node id<br><b>Type:</b> Create -- Optional<br>Modify -- Optional<br><b>Default value:</b> 0       |

|                         |   |
|-------------------------|---|
| <b>enable   disable</b> | <p>A Profile can only be modified, if it is disabled. A tree can only use a profile, if it is enabled. A profile cannot be disabled, if a tree is using it.</p> <p><b>Type:</b> Create -- Optional<br/> Modify -- Optional</p> <p><b>Default value:</b> 2</p> |
|-------------------------|---|

**Example:**

```
$ create clfr profile info pname IGMP
```

**Output:**

```
Verbose Mode On
Entry Created
```

```
Profile Name : IGMP
```

```
Root NodeId : 0          Status : Enable
```

```
Description : Profile to match the IGMP packet
```

```
Verbose Mode Off:
```

```
Entry Created
```

**Output field:**

| Field               | Description  |
|---------------------|--|
| <b>Profile Name</b> | Name of the classifier profile   |
| <b>Root NodeId</b>  | Root node Id of the profile. Each profile can have only one root node id   |
| <b>Status</b>       | A Profile can only be modified, if it is disabled. A tree can only use a profile, if it is enabled. A profile cannot be disabled, if a tree is using it. |
| <b>Description</b>  | A brief description can be given with profile, to identify the profile   |

## 5.13.9 Clfr profile node Commands

### 5.13.9.1 Get clfr profile node

**Description:**

Use this command to get.

**Command Syntax:**

**get clfr profile node** [**pname** <pname-val>] [**nodeid** <nodeid-val>]

### 5.13.9.2 Create clfr profile node

**Description:**

Use this command to create.

**Command Syntax:**

**create clfr profile node** **pname** <pname-val> **nodeid** <nodeid-val> [ **descr** <descr-val> ] [ **export** true|false ] **Ntype** Leaf|Unary|Binary|Ternary|Linear|NonLinear **modmask** Act|ValType|Offset|Mask|Val|ValueEnd|SBType|SBShiftCnt|SBMplr|Descrip|None [ **actual** Drop|Fwd|FwdToCtl|CpToCtl|Eq|Gt|Lt|InRange|TerCmp|SetPrio|MatchInList|AccDeny|SetBase|Count|Retagprio | MatchIngenlist|GoToNextRule|allow ] [ **valuetype** U8|U16|U32|U64|AtmIf|Aal5Vc|Eoalf|EthIf|Dir|Prio|Len|VlanId ] [ **offsetval** <offsetval-val> ] [ **maskval** <maskval-val> ] [ **value** <value-val> ] [ **valend** <valend-val> ] [ **sbase**type Abs|Add|Compute|SetFromVar ] [ **shiftcnt** <shiftcnt-val> ] [ **mplr** <mplr-val> ] [ **sbvarindex** l2start|l3start ] [ **nodeprio** low|high|asintree ]

### 5.13.9.3 Delete clfr profile node

**Description:**

Use this command to delete.

**Command Syntax:**

**delete clfr profile node** **pname** <pname-val> **nodeid** <nodeid-val>

### 5.13.9.4 Modify clfr profile node

**Description:**

Use this command to modify.

## Command Syntax:

```

modify clfr profile node pname <pname-val>nodeid <nodeid-val> [ descr
descr ] [export true|false ] Ntype Leaf|Unary|Binary|Ternary|Linear|NonLinear
modmask
Act|ValType|Offset|Mask|Val|ValueEnd|SBType|SBShiftCnt|SBMplr|Descrip|None
[ actval
Drop|Fwd|FwdToCtl|CpToCtl|Eq|Gt|Lt|InRange|TerCmp|SetPrio|MatchInList|AccD
eny|SetBase|Count|Retagprio | MatchIngenlist|GoToNextRule|allow ] [ valuetype
U8|U16|U32|U64|AtmIf|Aal5Vc|Eoalf|EthIf|Dir|Prio|Len|VlanId ] [ offsetval
<offsetval-val> ] [ maskval <maskval-val> ] [ value <value-val> ] [ valend
<valend-val> ] [ sbasetype Abs|Add|Compute|SetFromVar ] [shiftcnt
<shiftcnt-val>] [ mplr <mplr-val> ] [ sbvarindex l2start|l3start ] [ nodeprio
low|high|asintree ]

```

## Parameter:

| Name                       | Description   |
|----------------------------|---|
| <b>pname</b> <pname-val>   | Name of the classifier profile<br><br><b>Type:</b> Create -- Mandatory<br>Delete -- Mandatory<br>Modify -- Mandatory<br>Get -- Optional<br><br><b>Default value:</b> ----   |
| <b>nodeid</b> <nodeid-val> | Node Id, should be unique within a profile<br><br><b>Type:</b> Create -- Mandatory<br>Delete -- Mandatory<br>Modify -- Mandatory<br>Get -- Optional<br><br><b>Valid values:</b> 1 - 0xffffffff<br><b>Default value:</b> ----  |
| <b>descr</b> <descr-val>   | A brief description can be given with node, to identify the node. If the ActVal is FwdToCtl or CpToCtl then this field is mandatory and it can be used by the applications to receive the packets coming from control plane because of this node.<br><br><b>Type:</b> Create -- Optional<br>Modify -- Optional<br><br><b>Default value:</b> 0 |
| <b>export</b> true false   | Some of the nodes of a profile can be exported. This flag tells whether this node is exported or not<br><br><b>Type:</b> Create -- Optional<br>Modify -- Optional   |

|  |   |
|--|---|
|  | <b>Default value:</b> FALSE   |
| <b>Ntype</b><br>Leaf Unary Binary Ternary Linear NonLinear | This specifies the type of the Classifier node.<br><b>Type:</b> Create -- Optional  |
| <b>maskval</b> <maskval-val>                               | Mask, used to select the individual bits to be matched in a packet. If gsvClfrProfileNodeAction is SetBase and gsvClfrProfileNodeSetBaseType is Compute, then this value is used to specify the mask, which shall be used to identify the individual bits of the field of the packet used to compute the new base offset. This field is valid only if the gsvClfrProfileNodeValType is U8, U16, U32 or U64. This field is also valid if the gsvClfrProfileNodeAction is MatchInGenList.<br><b>Type :</b> Create --Optional<br><b>Default Value :</b> --   |
| <b>value</b> <value-val>                                   | Value, to be matched. For NonLinear node types, this field is not valid. For Linear node types, this value is used to specify the start of the range. If gsvClfrProfileNodeAction is SetBase and gsvClfrProfileNodeSetBaseType is Compute then this field is used to specify the value, which is to be added to base offset to calculate new base offset. If the gsvClfrProfileNodeAction is SetPrio or RetagPrio then this field is used to specify the priority which is to be assigned to the packet. If the gsvClfrProfileNodeAction is MatchInGenList then this field is not valid. If the gsvClfrProfileNodeAction is Count then this field is read only and specifies total number of octets of the packets hitting this node.<br><b>Type:</b> Create -- Optional<br><b>Default value:</b> --- |
| <b>valend</b> <valend-val>                                 | For Linear nodes this field is used to specify the end of the range. If the gsvClfrProfileNodeAction is InRange then this field is used to specify the end of the range. If the gsvClfrProfileNodeAction is count then this field is used to specify the total number of packet hitting this node. For other actions this field is not valid.<br><b>Type:</b> Create -- Optional<br><b>Default value:</b> -----   |
| <b>sbasetype</b> Abs   Add   Compute                       | This field is valid only for the SET_BASE action type. It is used to specify, whether the base off set is to be set to an absolute value,   |

|   |  |
|---|--|
|   | <p>or some value is to be added to existing base offset value to calculate new base offset value, or the new base offset value is to be computed using some value in the packet.</p> <p><b>Type:</b> Create -- Optional<br/>Modify -- Optional</p> <p><b>Default value:</b> ---</p>  |
| <b>shiftcnt</b> <shiftcnt-val>  | <p>ShiftCount, is the number of times the Value in the packet is to be shifted before multiplying it with the gsvClfrProfileNodeMultiplier. This field is valid only if the gsvClfrProfileNodeAction is SetBase. Value 32 is meant for internal purpose and Agents should not pass this value to GAG. GAG may return 32 value to Agent, in which case Agent should treat it as invalid.</p> <p><b>Type:</b> Create -- Optional<br/>Modify -- Optional</p> <p><b>Valid values:</b> 0 - 31</p> <p><b>Default value:</b> ---</p>  |
| <b>mplr</b> <mplr-val>  | <p>Multiplier, is used to multiply the value shifted by ShiftCount. It is used to calculate the new base offset. This field is valid only if the gsvClfrProfileNodeAction is SetBase.</p> <p><b>Type:</b> Create -- Optional<br/>Modify -- Optional</p> <p><b>Valid values:</b> 1 - 32</p> <p><b>Default value:</b> ----</p>   |
| <b>Modmask</b><br>Act ValType Offset Mask<br> Val None ValueEnd Sbt<br>ype SBShiftCnt SBMlpr <br>Descrip  | <p>This specifies what fields of an exported node are modifiable and can be modified while the profile is part of a classifier tree.</p> <p><b>Type:</b> Create -- Optional<br/>Modify -- Optional</p>   |
| <b>Actval</b><br>Drop Fwd FwdToCtl CpT<br>oCtl Eq Gt Lt InRange Te<br>rCmp <br>SetPrio MatchInList Acc<br>Deny SetBase Count <br>Retagprio  <br>MatchIngenlist<br> GoToNextRule allow | <p>Action tells what is to be done by a node. 'Drop' means drop the packet. 'Fwd' means Forward the packet. 'FwdToCtl' means Forward the packet to control plane. 'CpToCtl' means forward the packet and also send a copy of the packet to control plane. 'Allow' means give the packet to the next stage. 'GoToNextRule' means go to the next rule (ruleid) attached on that interface and if no next rule is attached on that interface then forward the packet. 'Eq' means check if value specified in the packet is equal to 'Value'. 'Gt' means check if the value at the location specified in the packet is greater than 'Value'. 'Lt' means check if the value at the location specified in the packet is Less than 'Value'. 'InRange' means</p> |

|   |   |
|---|---|
|   | <p>check if the value at the location specified in the packet is in the range specified by 'Value' and 'ValEnd'. 'TerCmp' means check if the value at the location specified in the packet is less than, equals to or greater than the 'Value'. 'MatchInList' means take the branch of the node whose value is equals to the value at the location specified in the packet. 'AccDeny' means check if the value at the location specified in the packet is equals to any of the value of the branches of this node. 'SetBase' means set the base address as specified by 'setbase action'. 'SetPrio' means set the internal priority, which is used along with egress port traffic class mapping table, to determine the output queue. 'Count' means count the number of packet and bytes in the packets reaching this nodes. 'RetagPrio' means set the priority in the outgoing packet, which is also used along with egress port traffic class mapping table, to determine the output queue. 'MatchInGenList' means match value in packet with values in genlist. For Leaf node, Drop, Fwd, FwdToCtl, CpToCtl, Allow and GoToNextRule are valid actions. For Unary node, Count, SetPrio and RetagPrio are valid actions. For Binary node, Eq, Gt, Lt, SetBase and MatchInGenList are valid actions. For Ternary node, TerCmp and InRange are valid actions. For Linear node, only MatchInList is a valid action. For NonLinear node, MatchinList and AccDeny are valid actions.</p> <p><b>Type:</b> Create -- Mandatory<br/> Modify -- Optional</p> <p><b>Default value:</b> -----</p> |
| <p><b>Ntype</b><br/> Leaf Unary Binary Ternary Linear NonLinear</p> | <p>This specifies the type of the Classifier node.</p> <p><b>Type:</b> Create -- Mandatory<br/> Modify -- Optional</p> <p><b>Valid values:</b> 1 - 0xffffffff</p> <p><b>Default value:</b> -----</p>  |
| <p><b>Offsetval offsetval</b></p>                                   | <p>OffSet, in the packet with respect to the base offset, from where we have to take the value, which is to be matched. If gsvClfrProfileNodeAction is SetBase and gsvClfrProfileNodeSetBaseType is Compute then this value is used to specify the offset with respect to the base offset, which shall be used to specify the field of the packet used to compute the new base offset. If the gsvClfrProfileNodeValType is U8 the offset can be odd or even. If the gsvClfrProfileNodeValType is U16, U32 or U64 then the offset can only be even. This field is not valid for any other value type.</p>  |

|                                       |  |
|---------------------------------------|--|
|                                       | <p><b>Type:</b> Create -- Optional<br/> Modify -- Optional</p> <p><b>Valid values:</b> 0 - 64</p> <p><b>Default value:</b> -----</p>   |
| <b>Valuetype valuetype</b>            | <p>Value type tells, the type of value which is to be matched/set. For leaf type nodes this field is not valid. If gsvClfrProfileNodeAction is SetBase and gsvClfrProfileNodeSetBaseType is Compute then this value is used to specify the value type (U8, U16, U32), which shall be used to compute the new base offset. This field is not valid for other values of gsvClfrProfileNodeSetBaseType.</p> <p><b>Type:</b> Create -- Optional<br/> Modify -- Optional</p> <p><b>Default value:</b> -----</p> |
| <b>sbvarindex<br/>L2Start L3Start</b> | <p>This specifies setbase variable index. This field is valid only if 'SetBaseType' is 'SetFromVar'. 'L2Start' is read-only containing Layer 2 header start offset. 'L3Start' is read-only containing Layer 3 header start offset. It should be ensured that packet is IP packet before using 'L3Start' value</p> <p><b>Type:</b> Create -- Optional<br/> Modify -- Optional</p> <p><b>Default value:</b> Invalid</p>  |
| <b>nodeprio<br/>Low High AsInTree</b> | <p>This specifies the priority of profile node. Based on this priority value, the profile node is created in fast or slow memory. In case priority is specified as 'AsInTree', node priority will be same as specified in the tree.</p> <p><b>Type:</b> Create -- Optional<br/> Modify -- Optional</p> <p><b>Default value:</b> AsInTree</p>   |

**Example:**

```
$ create clfr profile node pname IGMP nodeid 1 ntype binary actual eq valuetype
u16 value 0xffff offsetval 12 maskval 0xffff
```



**Output:**

Verbose Mode On

Entry Created

Profile Name : IGMP  
 Node Id : 3  
 Exported : true Node Type : Binary  
 Modification Mask : Act  
 Action : eq  
 Value Type : u16 Offset : 12  
 Mask : 0xffff  
 Value : 0x800  
 Value End : None  
 Set Base type : none  
 Shift Count : none Multiplier : none  
 Description : Node to match the ip address

Verbose Mode Off:

Entry Created

**Output field:**

| Field                    | Description   |
|--------------------------|---|
| <b>Profile Name</b>      | Name of the classifier profile  |
| <b>Node Id</b>           | Node Id, should be unique within a profile  |
| <b>Exported</b>          | This specifies what fields of an exported node are modifiable and can be modified while the profile is part of a classifier tree.   |
| <b>Node Type</b>         | This specifies the type of the Classifier node  |
| <b>Modification Mask</b> | This specifies what fields of this nodes can be modified, if this node is an exported node.   |
| <b>Action</b>            | Action tells what is to be done by a node.  |
| <b>Value Type</b>        | Value type tells the type of value, which is to be matched/set. For leaf type nodes this field is not valid. if ActVal is SetBase and SBaseType is Compute then this value is used to specify the value type (U8, U16, U32), which shall be used to compute the new base offset. This field is not valid for other values of SBaseType. |
| <b>Offset</b>            | OffSet, in the packet with respect to the base offset, from where we have to take the value, which is to be matched. If ActVal is SetBase and SBaseType is Compute then this value is used to specify the offset with respect to the base offset, which shall be used to specify the field of the packet used to compute the new        |

|                      |  |
|----------------------|--|
|                      | base offset. if the valuetype is U8 the offset can be odd or even. If the ValueType is U16, U32 or U64 then the offset can only be even. This field is not valid for any other value type.   |
| <b>Mask</b>          | Mask, used to select the individual bits to be matched in a packet. If ActVal is SetBase and SBaseType is Compute then this value is used to specify the mask, which shall be used to identify the individual bits of the field of the packet used to compute the new base offset. This field is valid only if the ValueType is U8, U16, U32 or U64. This field is also valid if the ActVal is MatchInGenList.   |
| <b>Value</b>         | Value, to be matched. For NonLinear node types, this field is not valid. For Linear node types, this value is used to specify the start of the range. if ActVal is SetBase and SBaseType is Compute then this field is used to specify the value, which is to be added to base offset to calculate new base offset. If the ActVal is SetPrio or RetagPrio then this field is used to specify the priority which is to be assigned to the packet. If the ActVal is MatchInGenList then this field is not valid. If the ActVal is Count then this field is read only and specifies total number of octet of the packets hitting this node. |
| <b>Value End</b>     | For Linear nodes this field is used to specify the end of the range. If the ActVal is InRange then this field is used to specify the end of the range. If the ActVal is count then this field is used to specify the total number of packet hitting this node. For other actions this field is not valid.  |
| <b>Set Base type</b> | SetBaseType is used to specify whether the base off set is to be set to an absolute value, or some value is to be added to existing base offset value to calculate new base offset value or the new base offset value is to be computed using some value in the packet. This field is valid only if the ActVal is SetBase.   |
| <b>Shift Count</b>   | ShiftCount, is the number of times the Value in the packet is to be shifted before multiplying it with the Mplr. This field is valid only if the ActVal is SetBase. Value 32 is used to set shift count to an invalid value.   |
| <b>Multiplier</b>    | Multiplier is used to multiply the value shifted by ShiftCount. It is used to calculate the new base offset. This field is valid only if the ActVal is SetBase.  |
| <b>Description</b>   | Description of the profile node. If the ActVal is FwdToCtl or CpToCtl then this field is mandatory and it can be used by the applications to receive the packets coming from control plane   |

|                      |  |
|----------------------|--|
|                      | because of this node.  |
| <b>SBVar Index</b>   | This specifies setbase variable index. This field is valid only if 'SetBaseType' is 'SetFromVar'. 'L2Start' is read-only containing Layer 2 header start offset. 'L3Start' is read-only containing Layer 3 header start offset. It should be ensured that packet is IP packet before using 'L3Start' value |
| <b>Node Priority</b> | This specifies the priority of profile node. Based on this priority value, the profile node is created in fast or slow memory. In case priority is specified as 'AsInTree', node priority will be same as specified in the tree.   |

## 5.13.10 Clfr tree branch Commands

### 5.13.10.1 Get clfr tree branch

**Description:**

Use this command to get.

**Command Syntax:**

**get clfr tree branch** [**tname** <tname-val>] [**pid** <pid-val>] [**nodeid** <nodeid-val>]  
[**brtype** <brtype-val>]

### 5.13.10.2 Create clfr tree branch

**Description:**

Use this command to create.

**Command Syntax:**

**create clfr tree branch** **tname** <tname-val>**pid** <pid-val>**nodeid**  
<nodeid-val>**brtype** <brtype-val>**childpid** <childpid-val>

### 5.13.10.3 Delete clfr tree branch

**Description:**

Use this command to delete.

**Command Syntax:**

**create clfr tree branch** **tname** <tname-val>**pid** <pid-val>**nodeid**  
<nodeid-val>**brtype** <brtype-val>

**Parameter:**

| Name                           | Description   |
|--------------------------------|---|
| <b>tname</b> <tname-val>       | Name of the classifier tree<br><b>Type:</b> Create -- Mandatory<br>Delete -- Mandatory<br>Get -- Optional<br><b>Valid values:</b> ND - ND   |
| <b>pid</b> <pid-val>           | Profile Id. It should be unique within a tree<br><b>Type:</b> Create -- Mandatory<br>Delete -- Mandatory<br>Get -- Optional<br><b>Valid values:</b> 1 - 4   |
| <b>nodeid</b> <nodeid-val>     | Node Id, should be unique within a profile<br><b>Type:</b> Create -- Mandatory<br>Delete -- Mandatory<br>Get -- Optional<br><b>Valid values:</b> 1 - 4  |
| <b>brtype</b> <brtype-val>     | This specifies the branch types. For a unary type node, only onlybr (0xfffffffff9) branch type is allowed. For binary type and Linear/Non-Linear(Access Deny only) type, TrueBr(0xfffffffffd) and FalseBr(0xffffffffffe) are allowed. For ternary type nodes LtBr(0xfffffffffc), GtBr (0xffffffffffb), EqBr (0xfffffffffffa) are allowed. For Linear, Non-Linear (match in list) the actual value is allowed. The actual value can be U8, U16, U32, U64, atmlf, ethernetlf, aal5vc.<br><b>Type:</b> Create -- Mandatory<br>Delete -- Mandatory<br>Get -- Optional |
| <b>childpid</b> <childpid-val> | This object specifies Child Profile Id. The Child Profile Id value 0 is used to add true and false branches to a AccessDeny type node.<br><b>Type:</b> Create -- Mandatory<br><b>Default value:</b> 0   |

**Example:**

```
$ create clfr tree branch tname t1 pid 2 nodeid 1 brtype truebr childpid 1
```

**Output:**

Verbose Mode On

Entry Created

Tree Name : tree1

Profile Id : 3 Node Id : 2

Branch type : eq Child Profile Id : 4

Verbose Mode Off:

Entry Created

**Output field:**

| Field                   | Description   |
|-------------------------|---|
| <b>Tree Name</b>        | Name of the classifier tree   |
| <b>Profile Id</b>       | Profile Id. It should be unique within a tree   |
| <b>Node Id</b>          | Node Id, should be unique within a profile  |
| <b>Branch type</b>      | This specifies the branch types. For a unary type node, only onlybr(0xffffffff9) branch type is allowed. For binary type and Linear/Non-Linear(Access Deny only) type, TrueBr(0xfffffffffd) and FalseBr(0xfffffffffe) are allowed. For ternary type nodes LtBr(0xfffffffffc), GtBr (0xfffffffffb), EqBr (0xfffffffffa) are allowed. For Linear, Non-Linear (match in list) the actual value is allowed. The actual value can be U8, U16, U32, U64, atmlf, ethernetlf, aal5vc. |
| <b>Child Profile Id</b> | This object specifies Child Profile Id. The Child Profile Id value 0, is used to add true and false branches to a AccessDeny type node.   |

## 5.13.11 Clfr tree info Commands

### 5.13.11.1 Get clfr tree info

**Description:**

Use this command to get.

**Command Syntax:**

**get clfr tree info** [tname <tname-val>]

### 5.13.11.2 Create clfr tree info

**Description:**

Use this command to create.

**Command Syntax:**

**create clfr tree info tname** <tname-val> [**descr** <descry-val>] [enable | disable]  
[treeprio low | high]

### 5.13.11.3 Delete clfr tree info

**Description:**

Use this command to delete.

**Command Syntax:**

**delete clfr tree info tname** <tname-val>

### 5.13.11.4 Modify clfr tree info

**Description:**

Use this command to create.

**Command Syntax:**

**modify clfr tree info tname** <tname-val> [**descr** <descry-val>] [enable | disable]  
[treeprio low | high]

## Parameter:

| Name                       | Description   |
|----------------------------|---|
| <b>tname</b> <tname-val>   | Name of the classifier tree which is to be included as subrule of this rule.<br>This classifier tree should exist and be enabled. A classifier tree can be used only in one subrule. The Maximum length of Name should be 32.<br><b>Type:</b> Create -- Mandatory<br>Delete -- Mandatory<br>Modify -- Mandatory<br>Get -- Optional<br><b>Default value:</b> ----- |
| <b>descr</b> <descry-val>  | A brief description can be given with tree, to identify the tree<br><b>Type:</b> Create -- Optional<br>Modify -- Optional<br><b>Default value:</b> 0  |
| <b>enable   disable</b>    | A tree cannot be deleted or modified, if it is enabled. A tree can only be used, if it is enabled. A tree can not be disabled, if it is being used.<br><b>Type:</b> Create -- Optional<br>Modify -- Optional<br><b>Default value:</b> 2   |
| <b>treeprio</b> low   high | Tells the priority of the tree. Based on this priority value, the tree is created in fast or slow memory.<br><b>Type:</b> Create -- Optional<br>Modify -- Optional<br><b>Default value:</b> low   |

## Example:

```
$ create clfr tree info tname tree1
```

## Output:

Verbose Mode On

Entry Created

```
Tree Name      : tree1
Status         : disable
Description    : tree1
Tree Priority   : High
```

Verbose Mode Off:

Entry Created

### Output field:

| Field        | Description   |
|--------------|---|
| Tree Name    | Name of the classifier tree   |
| Status       | A tree cannot be deleted or modified, if it is enabled. A tree can only be used, if it is enabled. A tree can not be disabled, if it is being used. |
| Description  | A brief description can be given with tree, to identify the tree  |
| TreePriority | Tells the priority of the tree. Based on this priority value, the tree is created in fast or slow memory.   |

## 5.13.12 Clfr tree map Commands

### 5.13.12.1 Get clfr tree map

#### Description:

Use this command to get.

#### Command Syntax:

```
get clfr tree map [ifname <interface-name>]
```

### 5.13.12.2 Create clfr tree map

#### Description:

Use this command to create.

#### Command Syntax:

```
create clfr tree map ifname <interface-name> tname <tname-val> entrypid  
<entrypid-val>
```

### 5.13.12.3 Delete clfr tree map

#### Description:

Use this command to delete.

#### Command Syntax:

```
delete clfr tree map ifname <interface-name>
```



### Parameter:

| Name                              | Description  |
|-----------------------------------|--|
| <b>ifname</b><br><interface-name> | Interface name, with which the tree is to be associated<br><b>Type:</b> Create -- Mandatory<br>Delete -- Mandatory<br>Get -- Mandatory |
| <b>tname</b> <tname-val>          | <b>Type:</b> Create -- Mandatory   |
| <b>entrypid</b> <entrypid-val>    | <b>Type:</b> Create -- Mandatory<br><b>Valid values:</b> 1 - 0xffffffff  |

### Example:

```
$ create clfr tree map Ifname aal5-3 tname tree1 EntryPid 5
```

### Output:

```
Verbose Mode On  
Entry Created
```

```
If Name : aal5-3
```

```
Tree Name : tree1
```

```
Entry Profile Id : 5
```

```
Verbose Mode Off:
```

```
Entry Created
```

### Output field

| Field                   | Description   |
|-------------------------|---|
| <b>If Name</b>          | Interface name, with which the tree is to be associated |
| <b>Tree Name</b>        |   |
| <b>Entry Profile Id</b> |   |

## 5.13.13 Clfr tree node Commands

### 5.13.13.1 Get clfr tree node

#### Description:

Use this command to get.

#### Command Syntax:

```
get clfr tree node [tname <tname-val>] [pid <pid-val>] [nodeid <nodeid-val>]
```

### 5.13.13.2 Modify clfr tree node

#### Description:

Use this command to get.

#### Command Syntax:

```

modify clfr tree node tname <tname-val>pid <pid-val>nodeid <nodeid-val>
[ descr <descry-val> ] [ offset <offset-val> ] [ mask <mask-val> ] [ value
<value-val> ] [act Drop|Fwd|FwdToCtl|CpToCtl|Eq|Gt|Lt|InRange |TerCmp|
SetPrio|MatchInList|AccDeny|SetBase|Count| Retagprio |
MatchIngenlist|GoToNextRule| allow] [valend valend ] [sbasetype Abs | Add |
Compute] [ shiftcnt <shiftcnt-val> ] [ mplr <mplr-val> ] [valtype
U8|U16|U32|U64|AtmIf|Aal5Vc|Eoalf|EthIf|Dir|Prio|Len|vlanid][ sbvarindex
l2start|l3start ] [nodeprio low]

```

#### Parameter:

| Name                 | Description  |
|----------------------|--|
| <b>tname tname</b>   | Name of the classifier tree<br><b>Type:</b> Modify -- Mandatory<br>Get -- Optional<br><b>Default value:</b> ----   |
| <b>pid pid</b>       | Profile Id. It should be unique within a tree.<br><b>Type:</b> Modify -- Mandatory<br>Get -- Optional<br><b>Valid values:</b> 1 - 0xffffffff<br><b>Default value:</b> ----   |
| <b>nodeid nodeid</b> | Node Id, should be unique within a profile<br><b>Type:</b> Modify -- Mandatory<br>Get -- Optional<br><b>Valid values:</b> 1 - 0xffffffff<br><b>Default value:</b> ----   |
| <b>descr descr</b>   | Description of the tree node. If the ActVal is FwdToCtl or CpToCtl then this field is mandatory and it can be used by the applications to receive the packets coming from control plane because of this node.<br><b>Type:</b> Modify -- Optional<br><b>Default value:</b> ----   |
| <b>offset offset</b> | Offset, in the packet with respect to the base offset, from where we have to take the value, which is to be matched. If ActVal is SetBase and SBaseType is Compute then this value is used to specify the offset with respect to the base offset, which shall be used to specify the field of the packet used to compute the new base offset. If the |

|   |   |
|---|---|
|   | <p>ValueType is U8 the offset can be odd or even. If the ValueType is U16, U32 or U64 then the offset can only be even. This field is not valid for any other value type.</p> <p><b>Type:</b> Modify -- Optional</p> <p><b>Valid values:</b> 0 - 65</p> <p><b>Default value:</b> -----</p>  |
| <b>mask mask</b>  | <p>Mask, used to select the individual bits to be matched in a packet. If gsvClfrTreeNodeAction is SetBase and gsvClfrTreeNodeSetBaseType is Compute, then this value is used to specify the mask, which shall be used to identify the individual bits of the field of the packet used to compute the new base offset. This field is valid only if the gsvClfrTreeNodeValType is U8, U16, U32 or U64. This field is also valid if the gsvClfrTreeNodeAction is MatchInGenList.</p> <p><b>Type:</b> Modify -- Optional</p> <p><b>Default value:</b> -----</p>  |
| <b>value value</b>  | <p>Value, to be matched. For NonLinear node types, this field is not valid. For Linear node types, this value is used to specify the start of the range. If gsvClfrTreeNodeAction is SetBase and NodeSetBaseType is Compute then this field is used to specify the value, which is to be added to base offset to calculate new base offset. If the gsvClfrTreeNodeAction is SetPrio or RetagPrio then this field is used to specify the priority which is to be assigned to the packet. If the gsvClfrTreeNodeAction is MatchInGenList then this field is not valid. If the gsvClfrTreeNodeAction is Count, then this field is read only and specifies total number of octets of the packets hitting this node.</p> <p><b>Type:</b> Modify -- Optional</p> <p><b>Default value:</b> -----</p> |
| <b>act</b><br><b>Drop Fwd FwdToCtl </b><br><b>CpToCtl Eq Gt Lt InR</b><br><b>ange TerCmp </b><br><b>SetPrio MatchInList A</b><br><b>ccDeny SetBase Cou</b><br><b>nt  Retagprio  </b><br><b>MatchIngenlist </b><br><b>GoToNextRule allow</b> | <p>Action tells what is to be done by a node. 'Drop' means drop the packet. 'Fwd' means Forward the packet. 'FwdToCtl' means Forward the packet to control plane. 'CpToCtl' means forward the packet and also send a copy of the packet to control plane. 'Allow' means give the packet to the next stage. 'GoToNextRule' means go to the next rule (ruleid) attached on that interface and if no next rule is attached on that interface then forward the packet. 'Eq' means check if value specified in the packet is equal to 'Value'. 'Gt' means check if the value at the location specified in the packet is greater than 'Value'. 'Lt' means check if the value at the location specified in the packet is Less than 'Value'. 'InRange' means check if the value</p>                   |

|                                       |   |
|---------------------------------------|---|
|                                       | <p>at the location specified in the packet is in the range specified by 'Value' and 'ValEnd'. 'TerCmp' means check if the value at the location specified in the packet is less than, equals to or greater than the 'Value'. 'MatchInList' means take the branch of the node whose value is equals to the value at the location specified in the packet. 'AccDeny' means check if the value at the location specified in the packet is equals to any of the value of the branches of this node. 'SetBase' means set the base address as specified by setbase action. 'SetPrio' means set the internal priority, which is used along with egress port traffic class mapping table, to determine the output queue. 'Count' means count the number of packet and bytes in the packets reaching this nodes. 'RetagPrio' means set the priority in the outgoing packet, which is also used along with egress port traffic class mapping table, to determine the output queue.</p> <p>'MatchInGenList' means match value in packet with values in genlist. For Leaf node, Drop, Fwd, FwdToCtl, CpToCtl, Allow and GoToNextRule are valid actions. For Unary node, Count, SetPrio and RetagPrio are valid actions. For Binary node, Eq, Gt, Lt, SetBase and MatchInGenList are valid actions. For Ternary node, TerCmp and InRange are valid actions. For Linear node, only MatchInList is a valid action. For NonLinear node, MatchinList and AccDeny are valid actions.</p> <p><b>Type:</b> Modify -- Optional</p> |
| <b>valend valend</b>                  | <p>For Linear nodes this field is used to specify the end of the range. If the gsvClfrTreeNodeAction is InRange then this field is used to specify the end of the range. If the gsvClfrTreeNodeAction is count then this field is used to specify the total number of packets hitting this node. For other actions this field is not valid.</p> <p><b>Type:</b> Modify -- Optional</p> <p><b>Default value:</b> -----</p>   |
| <b>sbasestype Abs   Add   Compute</b> | <p>SetBaseType, is used to specify, whether the base off set is to be set to an absolute value, or some value is to be added to existing base offset value to calculate new base offset value or the new base offset value is to be computed using some value in the packet. This field is valid only if the ActVal is SetBase.</p> <p><b>Type:</b> Modify -- Optional</p> <p><b>Default value:</b> 4</p>   |
| <b>shifcnt shifcnt</b>                | <p>ShiftCount, is the number of times the Value in the packet is to be shifted before multiplying it with the gsvClfrTreeNodeMultiplier. This field is valid only if the gsvClfrTreeNodeAction is SetBase.</p>  |

|  |   |
|--|---|
|  | <b>Type:</b> Modify -- Optional<br><b>Valid values:</b> 0 – 31<br>Default value: ----   |
| <b>mplr mplr</b>   | Multiplier, is used to multiply the value shifted by ShiftCount. It is used to calculate the new base offset. This field is valid only if the gsvClfrTreeNodeAction is SetBase.<br><b>Type:</b> Modify -- Optional<br><b>Valid values:</b> 1 - 32<br><b>Default value:</b> ---- |
| <b>valtype</b><br><b>U8 U16 U32 U64 Atml</b><br><b>f Aal5Vc Eoalf Ethlf D</b><br><b>ir Prio Len vlanid</b> | Value type tells the type of value that is to be matched/set.   |
| <b>Sbvarindex</b><br><b>l2start l3start</b>  | This specifies the setbase variable index. 'L2Start' is read-only, containing Layer 2 header start offset. 'L3Start' is read-only, containing Layer 3 header start offset.  |
| <b>Nodeprio</b><br><b>low high asintree</b>  | This specifies the priority of the tree node. Based on this priority value, the tree node is created in fast or slow memory.  |

### Example:

```
$ get clfr tree node tname tree1 pid 2 nodeid 3
```

### Output:

```
Tree Name           : tree1
Profile Id          : 2           Node Id           : 3
Exported            : true        Node Type          : Binary
Modification Mask   : act offset
Action              : eq
Value Type          : u32         Offset             : 12
Mask                : 0x0000000f
Value               : 0x0000000f
ValueEnd            : NA
Set Base type       : NA
Shift Count         : NA          Multiplier         : NA
Description         : Node to match the ip address
```

## Output field:

| Field                    | Description  |
|--------------------------|--|
| <b>Tree Name</b>         | Name of the classifier tree.   |
| <b>Profile Id</b>        | Profile Id. It should be unique within a tree  |
| <b>Node Id</b>           | Node Id, should be unique within a profile   |
| <b>Exported</b>          | This specifies what fields of an exported node are modifiable and can be modified while the profile is part of a classifier tree.  |
| <b>Node Type</b>         | This specifies the type of the Classifier node   |
| <b>Modification Mask</b> | This specifies what fields of this nodes can be modified, if this node is an exported node.  |
| <b>Action</b>            | Action tells what is to be done by a node.   |
| <b>Value Type</b>        | Value type tells, the type of value which is to be matched/set. For leaf type nodes this field is not valid. If ActVal is SetBase and SBaseType is Compute then this value is used to specify the value type (U8, U16, U32), which shall be used to compute the new base offset. This field is not valid for other values of SBaseType.  |
| <b>Offset</b>            | OffSet, in the packet with respect to the base offset, from where we have to take the value, which is to be matched. If ActVal is SetBase and SBaseType is Compute then this value is used to specify the offset with respect to the base offset, which shall be used to specify the field of the packet used to compute the new base offset. If the valuetype is U8 the offset can be odd or even. If the ValueType is U16, U32 or U64 then the offset can only be even. This field is not valid for any other value type.  |
| <b>Mask</b>              | Mask, used to select the individual bits to be match in a packet. If ActVal is SetBase and SBaseType is Compute then this value is used to specify the mask, which shall be used to identify the individual bits of the field of the packet used to compute the new base offset. This field is valid only if the ValueType is U8, U16, U32 or U64. This field is also valid if the ActVal is MatchInGenList.   |
| <b>Value</b>             | Value, to be matched. For NonLinear node types, this field is not valid. For Linear node types, this value is used to specify the start of the range. if ActVal is SetBase and SBaseType is Compute then this field is used to specify the value, which is to be added to base offset to calculate new base offset. If the ActVal is SetPrio or RetagPrio then this field is used to specify the priority which is to be assigned to the packet. If the ActVal is MatchInGenList then this field is not valid. If the ActVal is Count then this field is read only and specifies total number of octet of the packets hitting this node. |
| <b>ValueEnd</b>          | For Linear nodes this field is used to specify the end of the range. If the ActVal is InRange then this field is used to specify the end of the range. If the ActVal is count then this field is used to specify the total number of packet hitting this node.   |

|                      |  |
|----------------------|--|
|                      | For other actions this field is not valid.   |
| <b>Set Base type</b> | SetBaseTyp, is used to specify whether the base off set is to be set to an absolute value, or some value is to be added to existing base offset value to calculate new base offset value or the new base offset value is to be computed using some value in the packet. This field is valid only if the ActVal is SetBase. |
| <b>Shift Count</b>   | ShiftCount is the number of times the Value in the packet is to be shifted before multiplying it with the Mplr. This field is valid only if the ActVal is SetBase. Value 32 is used to set shift count to an invalid value.  |
| <b>Multiplier</b>    | Multiplier is used to multiply the value shifted by ShiftCount. It is used to calculate the new base offset. This field is valid only if the ActVal is SetBase.  |
| <b>Description</b>   | Description of the profile node. If the ActVal is FwdToCtl or CpToCtl then this field is mandatory and it can be used by the applications to receive the packets coming from control plane because of this node.   |

## 5.13.14 Clfr tree profile Commands

### 5.13.14.1 Get clfr tree profile

**Description:**

Use this command to get.

**Command Syntax:**

**get clfr tree profile [tname <tname-val>] [pid <pid-val>]**

### 5.13.14.2 Create clfr tree profile

**Description:**

Use this command to create.

**Command Syntax:**

**create clfr tree profile tname <tname-val>pid <pid-val>pname <pname-val> [isroot <isroot-val>]**

### 5.13.14.3 Delete clfr tree profile

**Description:**

Use this command to delete.

**Command Syntax:**

**get clfr tree profile tname <tname-val> pid <pid-val>**

### 5.13.14.4 Modify clfr tree profile

#### Description:

Use this command to modify.

#### Command Syntax:

```
modify clfr tree profile tname <tname-val>pid <pid-val> [isroot true|false]
```

#### Parameter:

| Name                       | Description  |
|----------------------------|--|
| <b>tname</b> <tname-val>   | Name of the classifier tree<br><b>Type:</b> Create -- Mandatory<br>Delete -- Mandatory<br>Modify -- Mandatory<br>Get -- Optional<br><b>Default value:</b> -----  |
| <b>pid</b> <pid-val>       | Profile Id. It should be unique within a tree<br><b>Type:</b> Create -- Mandatory<br>Delete -- Mandatory<br>Modify -- Mandatory<br>Get -- Optional<br><b>Valid values:</b> 1 - 0xffffffff<br><b>Default value:</b> -----   |
| <b>pname</b> <pname-val>   | Name of the profile which is to be added<br><b>Type:</b> Create -- Mandatory<br>Delete -- Optional<br>Modify -- Optional<br>Get -- Optional<br><b>Default value:</b> -----   |
| <b>isroot</b> <isroot-val> | This specifies whether this profile is exported as a root profile or not. Only root profiles of the nodes can be specified as an entry point on an interface.<br><b>Type:</b> Create -- Optional<br>Delete -- Optional<br>Modify -- Optional<br>Get -- Optional<br><b>Valid values:</b> true, false<br><b>Default value:</b> FALSE |

#### Example:

```
$ create clfr tree profile tname tree1 pid 4 pname srcip
```



**Output:**

Verbose Mode On  
Entry Created

Tree Name : tree1 Profile Id : 4  
Profile Name : srcip  
Is Root : false  
Verbose Mode Off:  
Entry Created

**Output field:**

| Field        | Description   |
|--------------|---|
| Tree Name    | Name of the classifier tree   |
| Profile Id   | Profile Id. It should be unique within a tree   |
| Profile Name | Name of the profile which is to be added  |
| Is Root      | This specifies whether this profile is exported as a root profile or not. Only root profiles of the nodes can be specified as an entry point on an interface. |

**5.13.15 Filter expr entry Commands****5.13.15.1 Get filter expr entry****Description:**

Use this command to get.

**Command Syntax:**

**get filter expr entry [exprid <exprid-val>]**

**5.13.15.2 Create filter expr entry****Description:**

Use this command to create.

**Command Syntax:**

**create filter expr entry exprid <exprid-val>exprstring <exprstring-val>**

### 5.13.15.3 Delete filter expr entry

#### Description:

Use this command to delete.

#### Command Syntax:

```
delete filter expr entry exprid <exprid-val>
```

#### Parameter

| Name                                  | Description   |
|---------------------------------------|---|
| <b>exprid</b> <exprid-val>            | Unique identifier for a filter expression.<br><b>Type:</b> Create -- Mandatory<br>Delete -- Mandatory<br>Get -- Optional<br><b>Valid values:</b> 1 -65535   |
| <b>exprstring</b><br><exprstring-val> | Expression string contains the expression relating the subrules of a rule using the & (AND),   (OR), ! (NOT) operators, parenthesis (for precedance) and actions to be executed. Valid actions are drop, allow, setprio, sendtocontrol, retagprio, copytocontrol, gotonexrule, forwardexit. If 'ruleDir' value is 'out', only drop, allow, gotonexrule and forwardexit action types are valid. For eg. "(1 2):drop" will be used to drop all packets which match subrules 1 or 2.<br><b>Type:</b> Create -- Mandatory |

#### Example:

```
$ create filter expr entry exprid 1 exprstring "(1|2):drop"
```

#### Output:

```
Verbose Mode On  
Entry Created
```

```
Expr Id : 1  
Exprstring : (1|2):drop  
Verbose Mode Off:  
Entry Created
```

### Output field:

| Field      | Description   |
|------------|---|
| Expr Id    | Unique identifier for a filter expression.  |
| Exprstring | Expression string contains the expression relating the subrules of a rule using the & (AND),   (OR), ! (NOT) operators, parenthesis (for precedence) and actions to be executed. Valid actions are drop, allow, setprio, sendtocontrol, retagprio, copytocontrol, gotonextrule, forwardexit. If 'ruleDir' value is 'out', only drop, allow, gotonextrule and forwardexit action types are valid. For eg. "(1 2):drop" will be used to drop all packets which match subrules 1 or 2. |

## 5.13.16 Filter list genentry Commands

### 5.13.16.1 Get filter list genentry

#### Description:

Use this command to get.

#### Command Syntax:

### 5.13.16.2 Create filter list genentry

#### Description:

Use this command to create.

#### Command Syntax:

```
create filter list genentry ifname <interface-name>value <value-val> [valtype  
U8 | U16 | U32]
```

### 5.13.16.3 Delete filter list genentry

#### Description:

Use this command to delete.

#### Command Syntax:

```
delete filter list genentry ifname <interface-name> value <value-val>
```

#### Parameter:

| Name                           | Description  |
|--------------------------------|--|
| <b>ifname</b> <interface-name> | Name of ethernet, eoa, ipoe or pppoe interface, for which the generic filter generic list is created. Valid values for the field are between EOA-0 and EOA-23 or between eth-0 and eth-1 or between IPOE-0 and IPOE-191 or between PPPOE-0 and |

|                               |  |
|-------------------------------|--|
|                               | PPPOE-191.<br><b>Type:</b> Create -- Mandatory<br>Delete -- Mandatory<br>Get -- Optional   |
| <b>value</b> <value-val>      | List Entry Value, for the generic filter generic list. This value must be consistent with the mentioned valuetype of generic list.<br><b>Type:</b> Create -- Mandatory<br>Delete -- Mandatory<br>Get -- Optional   |
| <b>valtype</b> U8   U16   U32 | This field specifies value type of the entry. The value type for all entries on an interface should be same. Value type should match value type of subrule field for which comparison type is ingenlist or notingenlist incase the rule containing the subrule is attached on the same interface. It should be 'U32' in case a rule containing IP subrule or Generic subrule with cmptype as InGenList or NotInGenList is attached on same interface. Currently only 'U32' value is supported.<br><b>Type:</b> Create -- Optional<br><b>Default value:</b> U32 |

**Example:**

```
$ create filter list genentry ifname eoa-1 value 0xAC1901AA valtype u32
```

**Output:**

```
Verbose Mode On
Entry Created
```

```
IfName      : eoa-1
Value       : 0xAC1901AA
Value Type  : u32
Verbose Mode Off:
Entry Created
```

**Output field**

| Field         | Description   |
|---------------|---|
| <b>IfName</b> | Name of ethernet, eoa, ipoe or pppoe interface, for which the generic filter generic list is created. Valid values for the field are between EOA-0 and EOA-23 or between eth-0 and eth-1 or between IPOE-0 and IPOE-191 or between PPPOE-0 and PPPOE-191. |
| <b>Value</b>  | List Entry Value, for the generic filter generic list. This value must be   |

|                   |  |
|-------------------|--|
|                   | consistent with the mentioned valuetype of generic list.   |
| <b>Value Type</b> | This field specifies value type of the entry. The value type for all entries on an interface should be same. Value type should match value type of subrule field for which comparison type is ingenlist or notingenlist incase the rule containing the subrule is attached on the same interface. It should be 'U32' in case a rule containing IP subrule or Generic subrule with cmptype as InGenList or NotInGenList is attached on same interface. Currently only 'U32' value is supported. |

## 5.13.17 Filter namedlist genentry Commands

### 5.13.17.1 Get filter namedlist genentry

**Description:**

Use this command to get.

**Command Syntax:**

**get filter namedlist genentry [listid <listid-val>] [value <value-val>]**

### 5.13.17.2 Create filter namedlist genentry

**Description:**

Use this command to create.

**Command Syntax:**

**create filter namedlist genentry listid <listid-val> value value-val>] [valueto <valueto-val>]**

### 5.13.17.3 Delete filter namedlist genentry

**Description:**

Use this command to delete.

**Command Syntax:**

**delete filter namedlist genentry listid <listid-val> value <value-val>**

**Parameter:**

| Name                       | Description   |
|----------------------------|---|
| <b>listid</b> <listid-val> | This field stores the list identifier value. There must be a row indexed on the same id in the Generic Filter Named List Table.<br><b>Type:</b> Create -- Mandatory |

|                              |   |
|------------------------------|---|
|                              | Delete -- Mandatory<br>Get -- Optional<br><b>Valid values:</b> 1 - 65535  |
| <b>value</b> <value-val>     | This value is mandatory for all list types. The interpretation of value depends upon the type of the list. If the list type is discrete, then this value is the list entry value. If the list type is range, then this value is the lower limit of range. The upper limit of range is specified in valueto field.<br><b>Type:</b> Create -- Mandatory<br>Delete -- Mandatory<br>Get -- Optional |
| <b>valueto</b> <valueto-val> | This value is not required for discrete lists but is mandatory for lists of type range. For range type lists this value specifies the upper limit of range.<br><b>Type:</b> Create -- Optional<br><b>Default value:</b> 0   |

**Example:**

```
$ create filter namedlist genentry listid 2 value 0xAC1901AA valueto 0xAC1901AA
```

**Output:**

```
Verbose Mode On  
Entry Created
```

```
ListId : 2  
Value : 0xAC1901AA  
ValueTo : 0xAC1901AA  
Verbose Mode Off:  
Entry Created
```

**Output field:**

| Field          | Description   |
|----------------|---|
| <b>ListId</b>  | This field stores the list identifier value. There must be a row indexed on the same id in the Generic Filter Named List Table.   |
| <b>Value</b>   | This value is mandatory for all list types. The interpretation of value depends upon the type of the list. If the list type is discrete, then this value is the list entry value. If the list type is range, then this value is the lower limit of range. The upper limit of range is specified in valueto field. |
| <b>ValueTo</b> | This value is not required for discrete lists but is mandatory for lists of type range. For range type lists this value specifies the upper limit of range.   |

## 5.13.18 Filter namedlist info Commands

### 5.13.18.1 Get filter namedlist info

**Description:**

Use this command to get.

**Command Syntax:**

**get filter namedlist info [listid <listid-val>]**

### 5.13.18.2 Create filter namedlist info

**Description:**

Use this command to get.

**Command Syntax:**

**create filter namedlist info listid <listid-val> [listtype discrete | range] [valtype U8 | U16 | U32]**

### 5.13.18.3 Delete filter namedlist info

**Description:**

Use this command to get.

**Command Syntax:**

**delete filter namedlist info listid <listid-val>**

### 5.13.18.4 Modify filter namedlist info

**Description:**

Use this command to get.

**Command Syntax:**

**modify filter namedlist info listid <listid-val> [valtype U8 | U16 | U32]**

**Parameter:**

| Name                       | Description   |
|----------------------------|---|
| <b>listid</b> <listid-val> | This field stores the list identifier value.<br><b>Type:</b> Create -- Mandatory<br>Delete -- Mandatory<br>Modify -- Mandatory<br>Get -- Optional |

|                                  |   |
|----------------------------------|---|
|                                  | <b>Valid values:</b> 1 - 65535  |
| <b>listtype</b> discrete   range | <p>This field identifies the type of list. If the type is discrete, then list can contain max. of 8 discrete entries. If the type is range, then list can contain max 4 entries. Lists of type range cannot be specified with subrules having cmptype as innamedlist or notinnamedlist. It can only be used for mapping to create genlist of an interface.</p> <p><b>Type:</b> Create -- Optional</p> <p><b>Default value:</b> discrete</p>   |
| <b>valtype</b> U8   U16   U32    | <p>This field specifies the value type of list. Value type should match value type of subrule field for which comparison type is innamedlist or notinnamedlist. It should be 'U32' in case a rule containing IP subrule or Generic subrule with comparison type (srcaddrcmp / gencmp) as 'ingenlist' or 'notingenlist' is attached on same interface. Currently only 'U32' value is supported.</p> <p><b>Type:</b> Create -- Optional<br/>Modify -- Optional</p> <p><b>Default value:</b> U32</p> |

### Example:

```
$ create filter namedlist info listid 2 listtype discrete valtype u32
```

### Output

```
Verbose Mode On
Entry Created
```

```
ListId      : 2
List Type   : discrete
Value Type  : u32
Verbose Mode Off:
Entry Created
```

### Output field:

| Field            | Description   |
|------------------|---|
| <b>ListId</b>    | This field stores the list identifier value.  |
| <b>List Type</b> | This field identifies the type of list. If the type is discrete, then list can contain max. of 8 discrete entries. If the type is range, then list can contain max 4 entries. Lists of type range cannot be |



|                   |   |
|-------------------|---|
|                   | specified with subrules having cmptype as innamedlist or notinnamedlist. It can only be used for mapping to create genlist of an interface.   |
| <b>Value Type</b> | This field specifies the value type of list. Value type should match value type of subrule field for which comparison type is innamedlist or notinnamedlist. It should be 'U32' in case a rule containing IP subrule or Generic subrule with comparison type (srcaddrcmp / gencmp) as 'ingenlist' or 'notingenlist' is attached on same interface. Currently only 'U32' value is supported. |

## 5.13.19 Filter namedlist map Commands

### 5.13.19.1 Get filter namedlist map

**Description:**

Use this command to get.

**Command Syntax:**

**get filter namedlist map [ifname <interface-name>]**

### 5.13.19.2 Create filter namedlist map

**Description:**

Use this command to create.

**Command Syntax:**

**create filter namedlist map ifname <interface-name> listid <listid-val>**

### 5.13.19.3 Delete filter namedlist map

**Description:**

Use this command to delete.

**Command Syntax:**

**delete filter namedlist map ifname <interface-name>**

**Parameter:**

| Name                           | Description   |
|--------------------------------|---|
| <b>ifname</b> <interface-name> | This specifies the eoa ,pppoe, ipoe or ethernet interface to which named generic list is attached. Valid values for the field are between EOA-0 and EOA-23 or between eth-0 and eth-1or |

|                            |   |
|----------------------------|---|
|                            | <p>between IPOE-0 and IPOE-191 or between PPPOE-0 and PPPOE-191.</p> <p><b>Type:</b> Create -- Mandatory<br/>Delete -- Mandatory<br/>Get -- Optional</p>  |
| <b>listid</b> <listid-val> | <p>This field stores the list identifier value. A row indexed by this id must exist in Generic Filter Named List Table. Value type of the list should match subrule field for which comparison type is ingenlist or notingenlist incase the rule containing the subrule is attached on the same interface. It should be 'U32' in case a rule containing IP subrule or Generic subrule with cmptype as ingenlist or notingenlist is attached on same interface. The list type can either discrete or range.</p> <p><b>Type:</b> Create -- Mandatory<br/><b>Valid values:</b> 1 - 65535</p> |

**Example:**

```
$ create filter namedlist map ifname eoa-1 listid 2
```

**Output:**

```
Verbose Mode On
Entry Created
```

```
IfName : eoa-1
```

```
ListId : 2
```

```
Verbose Mode Off:
```

```
Entry Created
```

**Output field:**

| Field         | Description   |
|---------------|---|
| <b>IfName</b> | This specifies the eoa, pppoe, ipoe or ethernet interface to which named generic list is attached. Valid values for the field are between EOA-0 and EOA-23 or between eth-0 and eth-1 or between IPOE-0 and IPOE-191 or between PPPOE-0 and PPPOE-191.  |
| <b>ListId</b> | This field stores the list identifier value. A row indexed by this id must exist in Generic Filter Named List Table. Value type of the list should match subrule field for which comparison type is ingenlist or notingenlist incase the rule containing the subrule is attached on the same interface. It should be 'U32' in case a rule containing IP subrule or Generic subrule with cmptype as ingenlist or notingenlist is attached on same interface. The list type can either discrete or range. |

## 5.13.20 Filter rule actionmap Commands

### 5.13.20.1 Get Filter rule actionmap

**Description:**

Use this command to get.

**Command Syntax:**

**get filter rule actionmap** [ruleid <ruleid-val >] [orderindex <orderindex-val >]

### 5.13.20.2 Create filter rule actionmap

**Description:**

Use this command to create.

**Command Syntax:**

**create filter rule actionmap ruleid** <ruleid-val > **orderindex** <orderindex-val>  
**action** SetPrio | RetagPrio | CopyToControl | ModifyTos | SetBacLevel | PktVlanId  
| RetagVlanId | PktServiceVlanId | RetagServiceVlanId | RetagServicePrio | Mirror  
[**priority** <priority-val>] [**actionval** <actionval-val>] [**actionmask**  
<actionmask-val>]

### 5.13.20.3 Delete filter rule actionmap

**Description:**

Use this command to delete.

**Command Syntax:**

**delete filter rule actionmap ruleid** <ruleid-val> **orderindex** <orderindex-val>

### 5.13.20.4 Modify filter rule actionmap

**Description:**

Use this command to modify.

**Command Syntax:**

**modify filter rule actionmap ruleid** <ruleid-val> **orderindex** <orderindex-val>  
[**action** SetPrio | RetagPrio | CopyToControl | ModifyTos | SetBacLevel | PktVlanId  
| RetagVlanId | PktServiceVlanId | RetagServiceVlanId | RetagServicePrio | Mirror]  
[**priority** <priority-val>] [**actionval** <actionval-val>] [**actionmask**  
<actionmask-val>]

## Parameter:

| Name   | Description   |
|--|---|
| <b>ruleid</b> <ruleid-val>   | Unique identifier of a filter rule entry for which this mapping is being created<br><b>Type:</b> Create -- Mandatory<br>Delete -- Mandatory<br>Modify -- Mandatory<br>Get -- Optional<br><b>Valid values:</b> 1 - 65535   |
| <b>orderindex</b><br><orderindex-val>  | This is the order index to allow creation of multiple entries in this table with a single rule identified by 'ruleid'. Multiple actions of the rule are applied in the increasing order of this field<br><b>Type:</b> Create -- Mandatory<br>Delete -- Mandatory<br>Modify -- Mandatory<br>Get -- Optional<br><b>Valid values:</b> 1 -255   |
| <b>action</b> SetPrio  <br>RetagPrio <br>CopyToControl<br> ModifyTos  <br>SetBacLevel  PktVlanId<br>  RetagVlanId<br> PktServiceVlanId<br> RetagServiceVlanId<br> RetagServicePrio  <br>Mirror | This field specifies the action of the rule<br><b>Type:</b> Create -- Mandatory<br>Modify -- Optional   |
| <b>priority</b> <priority-val>   | This field specifies the priority to be set for the matching packets. It is valid only if 'action' is either 'setprio' or 'retagprio' or 'retagserviceprio'.<br><b>Type:</b> Create -- Optional<br>Modify -- Optional<br><b>Valid values:</b> 0 - 7<br><b>Default value:</b> 0  |
| <b>actionval</b><br><actionval-val>  | The parameter should contain valid value for some actions that require an additional input, other than setprio, retagprio, and retagserviceprio actions. For copytocontrol action this parameter should contain trap level 0 (trap disabled) or 1 (trap enabled). Other values are invalid for this action. For modifytos action this parameter should contain value to be set in TOS |

|   |  |
|---|--|
|   | <p>field in the packet in the range 0 to 255. Other values are invalid for this action. The application of this value is dependent on the mask parameter. For setbaclevel action this parameter should contain valid Buffer Admission Control level value of 0 or 1. For pktvlanid, retagvlanid, pktservicevlanid and retagservicevlanid actions this parameter should be filled with VLAN ID value in the range 1 to 4094. For mirror action this parameter should be filled with valid mirror context id.</p> <p><b>Type:</b> Create — Optional<br/> Modify — Optional</p> <p><b>Valid values:</b> 0 - 0xffffffff</p> <p><b>Default value:</b> 0</p> |
| <p><b>actionmask</b><br/> &lt;actionmask -val&gt;</p> | <p>This field is valid for modifytos action only. Only lower 8-bits are taken into consideration for modifytos action and other bits are ignored. In the mask if a bit location contains 1, then the corresponding bit in the TOS field is overwritten with the corresponding bit in action value. In the mask if a bit location contains 0, then the corresponding bit in the TOS field remains unchanged.</p> <p><b>Type:</b> Create — Optional<br/> Modify — Optional</p> <p><b>Valid values:</b> 0 - 0xffffffff</p> <p><b>Default value:</b> 0xffffffff</p>  |

**Example:**

```
$ create filter rule actionmap ruleid 1 orderindex 1 action SetPrio priority 3
actionval 0x00000000 actionmask 0xffffffff
```

**Output:**

```
Verbose Mode On
Entry Created
```

```
Rule Id      : 1                Order Index : 1
Action       : SetPrio          Priority      : 3
ActionValue  : 0x00000000
Action Mask  : 0xffffffff
```

```
Verbose Mode Off:
Entry Created
```

## Output field:

| Field              | Description  |
|--------------------|--|
| <b>Rule Id</b>     | Unique identifier of a filter rule entry for which this mapping is being created   |
| <b>Order Index</b> | This is the order index to allow creation of multiple entries in this table with a single rule identified by 'ruleid'. Multiple actions of the rule are applied in the increasing order of this field  |
| <b>Action</b>      | This field specifies the action of the rule  |
| <b>Priority</b>    | This field specifies the priority to be set for the matching packets. It is valid only if 'action' is either 'setprio' or 'retagprio' or 'retagserviceprio'.   |
| <b>ActionValue</b> | The parameter should contain valid value for some actions that require an additional input, other than setprio, retagprio, and retagserviceprio actions. For copytocontrol action this parameter should contain trap level 0 (trap disabled) or 1 (trap enabled). Other values are invalid for this action. For modifytos action this parameter should contain value to be set in TOS field in the packet in the range 0 to 255. Other values are invalid for this action. The application of this value is dependent on the mask parameter. For setbacklevel action this parameter should contain valid Buffer Admission Control level value of 0 or 1. For pktvlanid and pktservicevlanid actions this parameter should be filled with VLAN ID value in the range 1 to 4094. For mirror action this parameter should be filled with valid mirror context id. |
| <b>Action Mask</b> | This field is valid for modifytos action only. Only lower 8-bits are taken into consideration for modifytos action and other bits are ignored. In the mask if a bit location contains 1, then the corresponding bit in the TOS field is overwritten with the corresponding bit in action value. In the mask if a bit location contains 0, then the corresponding bit in the TOS field remains unchanged.   |

## 5.13.21 Filter rule entry Commands

### 5.13.21.1 Get Filter rule entry

**Description:**

Use this command to get.

**Command Syntax:**

**get filter rule entry** [ruleid <ruleid-val>]

### 5.13.21.2 Create filter rule entry

**Description:**

Use this command to create.

**Command Syntax:**

**create filter rule entry ruleid** r<ruleid-val> [ **action** drop | allow | setprio | sendtocontrol | retagprio | copytocontrol | clfrdef | gotonextrule | forwardexit | exprdef | modifytos | setbacklevel | pktvlanid | retagvlanid | pktservicevlanid | retagservicevlanid | retagserviceprio | ratelimiter | Mirror ] [ **description** <description-val> ] [ **priority** <priority-val> ] [ **status** enable | disable ] [ **statsstatus** enable | disable ] [ **ruleprio** low | high ] [ **ruledir** in | out ] [ **applywhenreq** enable | disable ] [ **pktype** Mcast | Bcast | Ucast ] [ **snooplevel** interface | bridge ] [ **exprid** <exprid-val> ] [ **actionval** <actionval-val> ] [ **actionmask** <actionmask-val> ]

### 5.13.21.3 Delete filter rule entry

**Description:**

Use this command to delete.

**Command Syntax:**

**delete filter rule entry ruleid** <ruleid-val >

### 5.13.21.4 Modify filter rule entry

**Description:**

Use this command to modify.

## Command Syntax:

```

modify filter rule entry ruleid <ruleid-val> [ action drop | allow | setprio |
sendtocontrol | retagprio | copytocontrol | clfrdef | gotonexrule | forwardexit |
exprdef | modifytos | setbacklevel | pktvlanid | retagvlanid | pktservicevlanid |
retagservicevlanid | retagserviceprio | ratelimiter | Mirror ] [ description
<description-val> ] [ priority <priority-val> ] [ status enable | disable ]
[ statsstatus enable | disable ] [ ruleprio low | high ] [ applywhenreq enable |
disable ] [ pkftype Mcast | Bcast | Ucast ] [ snooplevel interface | bridge ] [ exprid
<exprid-val> ] [ actionval <actionval-val> ] [ actionmask <actionmask-val> ]

```

## Parameters:

| Name  | Description   |
|---|---|
| <b>ruleid</b> <ruleid-val >   | <p>Unique identifier of a filter rule.</p> <p><b>Type:</b> Create – Mandatory<br/>Delete – Mandatory<br/>Modify – Mandatory<br/>Get – Optional</p> <p><b>Valid values:</b> 1-65535</p>  |
| <b>action</b> drop   allow<br> setprio   sendtocontrol<br> retagprio   copytocontrol <br>clfrdef   gotonexrule<br> forwardexit   exprdef<br> modifytos   setbacklevel<br> pktvlanid   retagvlanid<br> pktservicevlanid<br> retagservicevlanid<br> retagserviceprio<br> ratelimiter   Mirror | <p>Action to be applied for the packets matching this filter rule. This field can be modified only if 'ruleStatus' has the value 'disable'.</p> <p>'exprdef(10)' action has a special significance that action is defined in the expression. In this case the 'ExprId' field must be specified.</p> <p>For other types of actions, the default relationship between subrules is all ANDed. If 'ruleDir' value is 'out', 'clfrdef' and 'ratelimiter' action types are invalid. If the action is 'clfrdef', then the rule can have at most one subrule, that too of type 'clfrtree'. The actions setprio, retagprio and setserviceprio require priority value to be specified in ruleSetPrio parameter. The actions sendtocontrol, copytocontrol, modifytos, setbacklevel, setvlanid, retagvlanid, setservicevlanid, retagservicevlanid, ratelimiter and mirror require an additional value to be specified in ruleActionVal parameter. The actions sendtocontrol, copytocontrol and modifytos also require ruleActionMask parameter to be specified.</p> <p><b>Type:</b> Create – Optional<br/>Modify – Optional</p> <p><b>Default value:</b> drop</p> |
| <b>description</b><br><description-val>   | <p>Description of the application that receives packets matching this rule. This field is valid and mandatory only if RuleAction is 'sendtocontrol' or RuleApplyWhenReq is 'enable'. This field can be modified only if 'status' has the value 'disable' <b>Type:</b> Create –</p>  |



|                                     |   |
|-------------------------------------|---|
|                                     | <p>Optional</p> <p>Modify — Optional</p> <p><b>Default value:</b> "\0"</p>  |
| <b>priority</b> <priority-val>      | <p>Priority to be set for packets matching this rule. This field is valid only if RuleAction is 'setprio' or 'retagprio'. If the RuleAction is 'setprio' then this value is internal priority and is used along with egress port traffic class mapping table, to determine the output queue. If the RuleAction is 'retagprio' then this value is priority which is to be tagged into the outgoing packet and it is also used along with egress port traffic class mapping table, to determine the output queue. This field can be modified only if 'status' has the value 'disable'.</p> <p><b>Type:</b> Create — Optional<br/>Modify — Optional</p> <p><b>Valid values:</b> 0 - 7</p> <p><b>Default value:</b> 0</p> |
| <b>status</b> enable   disable      | <p>Admin status of the rule</p> <p><b>Type:</b> Create — Optional<br/>Modify — Optional</p> <p><b>Default value:</b> disable</p>  |
| <b>statsstatus</b> enable   disable | <p>Admin status of rule statistics. Statistics of a rule are collected only when this field is set to 'enable'. This field can be modified only if 'status' has the value 'disable'. NOTE - Statistics may not reflect correctly the number of egress mcast, bcast and unknown unicast packets hitting the rule.</p> <p><b>Type:</b> Create — Optional<br/>Modify — Optional</p> <p><b>Default value:</b> disable</p>   |
| <b>ruleprio</b> low   high          | <p>Tells the priority of the rule. Based on this priority value, the rule is created in fast or slow memory. This field can be modified only if 'status' has the value 'disable'. This field is ignored if the 'ruleAction' has value 'clfrdef'</p> <p><b>Type:</b> Create — Optional<br/>Modify — Optional</p> <p><b>Default value:</b> high</p>   |
| <b>ruledir</b> in   out             | <p>Specifies whether the rule will be applied on incoming interfaces (ingress) or outgoing interfaces (egress).</p> <p><b>Type:</b> Create — Optional</p> <p><b>Default value:</b> in</p>   |

|   |  |
|---|--|
| <b>applywhenreq</b> enable<br> disable  | <p>This specifies whether this rule is to be applied only when required. Rule description field is mandatory if this field is set to value 'enable'. This field can be modified only if 'status' has the value 'disable'. This field is ignored if the 'ruleAction' has value 'clfrdef'.</p> <p><b>Type:</b> Create — Optional<br/>Modify — Optional</p> <p><b>Default value:</b> disable</p>  |
| <b>pktttype</b> Mcast   Bcast<br> Ucast | <p>This field specifies the types of packets on which this rule is to be applied. 'Mcast' means this rule is valid for multicast packets, 'Bcast' means this rule is valid for broadcast packets and 'Ucast' means this rule is valid for unicast packets. This field is valid only if 'ruleDir' is 'out'. This field can be modified only if 'status' has the value 'disable'.</p> <p><b>Type:</b> Create — Optional<br/>Modify — Optional</p> <p><b>Default value:</b> Ucast</p> |
| <b>snooplevel</b> interface<br> bridge  | <p>Snoop level specifies whether packet will be snooped directly from Interface or from Bridge after applying Bridging functionality .If none of the Rule actions is 'sendtoControl' or 'copytocontrol', then this field has no significance. This field can be modified only if 'status' has the value 'disable'. <b>Type:</b> Create — Optional<br/>Modify — Optional</p> <p><b>Default value:</b> interface</p>   |
| <b>exprid</b> <exprid-val>              | <p>Identifies the expression id from the Generic Filter Expression Table to be used. This field is used only if 'ruleAction' is 'exprdef'. In absence of this field, the default relationship between all subrules is all ANDed.</p> <p><b>Type:</b> Create — Optional<br/>Modify — Optional</p> <p><b>Valid values:</b> 1 - 65535</p> <p><b>Default value:</b> 0</p>  |

**Example:**

```
$ create filter rule entry ruleid 1 action setprio description lacp priority 7 status
enable statsstatus disable ruleprio high ruledir in applywhenreq disable pktttype
Ucast snooplevel interface exprid exprid 1 actionval 0x00000000 actionmask
0xffffffff
```

**Output:**

Verbose Mode On

Entry Created

```

Rule Id           : 1           Rule Action      : setprio
Set Priority       : 7           Admin status     : enable
Stats admin status : disable    Rule Priority    : high
Rule Direction    : in          ApplyWhenReq    : disable
Pkt Type          : Ucast
Application Description : lACP
Snoop Level       : interface
Expression Id     : exprid 1
Action Value      : 0x00000000
Action Mask       : 0xffffffff

```

Verbose Mode Off:

Entry Created

**Output field:**

| Field               | Description   |
|---------------------|---|
| <b>Rule Id</b>      | Unique identifier of a filter rule.   |
| <b>Rule Action</b>  | Action to be applied for the packets matching this filter rule. This field can be modified only if 'ruleStatus' has the value 'disable'. 'exprdef (10)' action has a special significance that action is defined in the expression. In this case the 'ExprId' field must be specified. For other types of actions, the default relationship between subrules is all ANDed. If 'ruleDir' value is 'out', 'clfrdef' and 'ratelimiter' action types are invalid. If the action is 'clfrdef', then the rule can have at most one subrule, that too of type 'clfrtree'. The actions setprio, retagprio and setserviceprio require priority value to be specified in ruleSetPrio parameter. The actions sendtocontrol, copytocontrol, modifytos, setbacklevel, setvlanid, retagvlanid, setservicevlanid, retagservicevlanid, ratelimiter and mirror require an additional value to be specified in ruleActionVal parameter. The actions sendtocontrol, copytocontrol and modifytos also require ruleActionMask parameter to be specified. |
| <b>Set Priority</b> | Priority to be set for packets matching this rule. This field is valid only if RuleAction is 'setprio' or 'retagprio'. If the RuleAction is 'setprio' then this value is internal priority and is used along with egress port traffic class mapping table, to determine the output  |

|                                |  |
|--------------------------------|--|
|                                | queue. If the RuleAction is 'retagprio' then this value is priority which is to be tagged into the outgoing packet and it is also used along with egress port traffic class mapping table, to determine the output queue. This field can be modified only if 'status' has the value 'disable'.   |
| <b>Admin status</b>            | Admin status of the rule   |
| <b>Stats admin status</b>      | Admin status of rule statistics. Statistics of a rule are collected only when this field is set to 'enable'. This field can be modified only if 'status' has the value 'disable'. NOTE - Statistics may not reflect correctly the number of egress mcast, bcast and unknown unicast packets hitting the rule.  |
| <b>Rule Priority</b>           | Tells the priority of the rule. Based on this priority value, the rule is created in fast or slow memory. This field can be modified only if 'status' has the value 'disable'. This field is ignored if the 'ruleAction' has value 'clfrdef'   |
| <b>Rule Direction</b>          | Specifies whether the rule will be applied on incoming interfaces (ingress) or outgoing interfaces (egress).   |
| <b>ApplyWhenReq</b>            | This specifies whether this rule is to be applied only when required. Rule description field is mandatory if this field is set to value 'enable'. This field can be modified only if 'status' has the value 'disable'. This field is ignored if the 'ruleAction' has value 'clfrdef'.  |
| <b>Pkt Type</b>                | This field specifies the types of packets on which this rule is to be applied. 'Mcast' means this rule is valid for multicast packets, 'Bcast' means this rule is valid for broadcast packets and 'Ucast' means this rule is valid for unicast packets. This field is valid only if 'ruleDir' is 'out'. This field can be modified only if 'status' has the value 'disable'. |
| <b>Application Description</b> | Description of the application that receives packets matching this rule. This field is valid and mandatory only if RuleAction is 'sendtocontrol' or RuleApplyWhenReq is 'enable'. This field can be modified only if 'status' has the value 'disable'  |
| <b>Snoop Level</b>             | Snoop level specifies whether packet will be snooped directly from Interface or from Bridge after applying Bridging functionality .If none of the Rule actions is 'sendtoControl' or 'copytocontrol', then this field has no significance. This field can be modified only if 'status' has the value 'disable'.  |
| <b>Expression Id</b>           | Identifies the expression id from the Generic Filter Expression Table to be used. This field is used only if 'ruleAction' is 'exprdef'. In absence of this field, the default relationship between all   |

|                     |  |
|---------------------|--|
|                     | subrules is all ANDED.   |
| <b>Action Value</b> | The parameter should contain valid value for some actions that require an additional input, other than setprio, retagprio, and retagserviceprio actions. For sendtocontrol and copytocontrol actions this parameter should contain control flow id (0-3). Other values are invalid for this action. For modifytos action this parameter should contain value to be set in TOS field in the packet in the range 0 to 255. Other values are invalid for this action. The application of this value is dependent on the mask parameter. For setbacklevel action this parameter should contain valid Buffer Admission Control level value of 0 or 1. For pktvlanid, retagvlanid, pktservicevlanid and retagservicevlanid actions this parameter should be filled with VLAN ID value in the range 1 to 4094. For ratelimiter action this parameter should be filled with the valid user-defined flow type value. For mirror action this parameter should be filled with valid mirror context id. This parameter is ignored for other actions. Specifying an invalid value for an action would result in error when the rule is enabled. |
| <b>Action Mask</b>  | This field is valid for sendtocontrol, copytocontrol and modifytos actions only. For sendtocontrol and copytocontrol actions this parameter should contain trap level 0xffffffff (trap disabled) or 0x00000000(trap enabled). Other values are invalid for this action. For modifytos action, only lower 8-bits are taken into consideration and other bits are ignored. In the mask if a bit location contains 1, then the corresponding bit in the TOS field is overwritten with the corresponding bit in action value. In the mask if a bit location contains 0, then the corresponding bit in the TOS field remains unchanged.   |

## 5.13.22 Filter rule map Commands

### 5.13.22.1 Get Filter rule map

#### Description:

Use this command to get.

#### Command Syntax:

```
get filter rule map [ifname <interface-name> | all | alleoa | alleth | allpppoe | allcpe | allipoe] [stageid <stageid-val>] [ruleid <ruleid-val>]
```

### 5.13.22.2 Create filter rule map

#### Description:

Use this command to create.

#### Command Syntax:

```
create filter rule map ifname <interface-name>| all | alleoa | alleth | allpppoe |  
allcpe | allipoe stageid <stageid-val> ruleid <ruleid-val> [orderid <orderid-val>]
```

### 5.13.22.3 Delete filter rule map

#### Description:

Use this command to delete.

#### Command Syntax:

```
delete filter rule map ifname <interface-name>| all | alleoa | alleth | allpppoe |  
allcpe | allipoe stageid <stageid-val> ruleid <ruleid-val>
```

### 5.13.22.4 Modify filter rule map

#### Description:

Use this command to modify.

#### Command Syntax:

```
modify filter rule map ifname <interface-name>| all | alleoa | alleth | allpppoe |  
allcpe | allipoe stageid <stageid-val> ruleid <ruleid-val> [orderid <orderid-val>]
```

#### Parameters:

| Name  | Description  |
|---|--|
| <b>Ifname</b><br><interface-name>  all<br> alleoa   alleth  <br>allpppoe  allcpe  <br>allipoe | Name of the interface whose mapping is being created. Only EOA, PPPoE, IPOE and ethernet interfaces are allowed. If the value of this field is 'All', it indicates all interfaces, 'AllEoa' indicates all 'eoa' interfaces, and 'AllEth' indicates all 'ethernet' interfaces. AllPppoe' indicates all 'PPPoE' interfaces, 'AllIpoE' indicates all 'IPOE' interfaces and 'AllCpe' indicates all eoa , all ipoe and pppoe interfaces. If a bridge port on aggregated interface is created then this field can not have ifIndex of any specific ethernet interface.<br><br><b>Type:</b> Create — Mandatory<br>Delete — Mandatory<br>Modify — Mandatory<br>Get — Optional<br><br><b>Valid values:</b> , all , alleoa, alleth, allpppoe, allcpe,  allipoe |

|                              |  |
|------------------------------|--|
| <b>stageid</b> <stageid-val> | <p>This field specifies the stage on the interface to which the rule in the mapping belongs</p> <p><b>Type:</b> Create – Mandatory<br/> Delete – Mandatory<br/> Modify – Mandatory<br/> Get – Optional</p> <p><b>Valid values:</b> 1</p>   |
| <b>ruleid</b> <ruleid-val>   | <p>Rule Id of the rule in the mapping</p> <p><b>Type:</b> Create – Mandatory<br/> Delete – Mandatory<br/> Modify – Mandatory<br/> Get – Optional</p> <p><b>Valid values:</b> 1 - 65535</p>   |
| <b>orderid</b> <ordered-val> | <p>This field indicates the order of the rule in the attached sequence. The default value for this field will be same as the ruleid of the entry.</p> <p><b>Type:</b> Create – Optional<br/> Modify – Optional</p> <p><b>Valid values:</b> 1 - 65535</p> <p><b>Default value:</b> Same As Ruleid</p> |

**Example:**

```
$ create filter rule map ifname eoa-0 stageid 1 ruleid 1 orderId 1
```

**Output:**

```
Verbose Mode On
Entry Created
```

```
Interface : eoa-0      Stage Id : 1
Rule Id   : 1         Order Id : 1
```

Verbose Mode Off:

```
Entry Created
```

**Output field:**

| Field            | Description   |
|------------------|---|
| <b>Interface</b> | Name of the interface whose mapping is being created. Only EOA, PPPoE, IPOE and ethernet interfaces are allowed. If the value of this field is 'All', it indicates all interfaces, 'AllEoa' indicates all 'eoa' interfaces, and 'AllEth' indicates all 'ethernet' interfaces. AllPpoe' indicates all 'PPPoE' interfaces, 'AllIpoE' indicates all 'IPOE' |

|                 |   |
|-----------------|---|
|                 | interfaces and 'AllCpe' indicates all eoa , all ipoe and pppoe interfaces. If a bridge port on aggregated interface is created then this field can not have ifIndex of any specific ethernet interface. |
| <b>Stage Id</b> | This field specifies the stage on the interface to which the rule in the mapping belongs  |
| <b>Rule Id</b>  | Rule Id of the rule in the mapping  |
| <b>Order Id</b> | This field indicates the order of the rule in the attached sequence.<br>The default value for this field will be same as the ruleid of the entry.   |

## 5.13.23 Filter rule stats Commands

### 5.13.23.1 Get Filter rule stats

#### Description:

Use this command to get.

#### Command Syntax:

**get filter rule stats [ruleid <ruleid-val>]**

#### Parameter:

| Name                         | Description   |
|------------------------------|---|
| <b>ruleid &lt;ruleid&gt;</b> | Unique identifier of a filter rule<br><b>Type:</b> Get -- Optional<br><b>Valid values:</b> 1- 65535 |

#### Example:

```
$ get filter rule stats ruleid 1
```

#### Output:

```
Rule Id : 1          Num Hits : 4354
```

#### Output field:

| Field           | Description                          |
|-----------------|--------------------------------------|
| <b>Rule Id</b>  | Unique identifier of a filter rule   |
| <b>Num Hits</b> | Number of packets that hit this rule |

#### References:

- Generic Filter Commands



## 5.13.24 Filter seq entry Commands

### 5.13.24.1 Get Filter seq entry

**Description:**

Use this command to get.

**Command Syntax:**

**get filter seq entry [seqid <seqid-val >] [ruleid <ruleid-val >]**

### 5.13.24.2 Create filter seq entry

**Description:**

Use this command to create.

**Command Syntax:**

**create filter seq entry seqid <seqid-val > ruleid <ruleid-val > [orderid <ordered-val >]**

### 5.13.24.3 Delete filter seq entry

**Description:**

Use this command to delete.

**Command Syntax:**

**delete filter seq entry seqid <seqid-val > ruleid <ruleid-val >**

### 5.13.24.4 Modify filter seq entry

**Description:**

Use this command to modify.

**Command Syntax:**

**modify filter seq entry seqid <seqid-val > ruleid <ruleid-val > [orderid <ordered-val >]**

**Parameters:**

| Name | Description |
|------|-------------|
|------|-------------|

|                               |  |
|-------------------------------|--|
| <b>seqid</b> <seqid-val >     | Sequence Id of the sequence<br><b>Type:</b> Create -- Mandatory<br>Delete -- Mandatory<br>Modify -- Mandatory<br>Get – Optional<br><b>Valid Values:</b> 1-65535  |
| <b>ruleid</b> <ruleid-val >   | Rule Id of the rule<br><b>Type:</b> Create -- Mandatory<br>Delete -- Mandatory<br>Modify -- Mandatory<br>Get -- Optional<br><b>Valid Values:</b> 1-65535   |
| <b>orderid</b> <ordered-val > | This field indicates the order of the rule in the sequence. The default value for this field will be same as the ruleid of the entry.<br><b>Type:</b> Create -- Optional<br>Modify -- Optional<br><b>Valid Values:</b> 1-65535 |

**Example:**

```
$ create filter seq entry seqid 1 ruleid 1 orderId 1
```

**Output:**

Verbose Mode On  
Entry Created

Sequence Id : 1                      Rule Id : 1  
Order Id        : 1

Verbose Mode Off:

Entry Created

**Output field:**

| Field              | Description   |
|--------------------|---|
| <b>Sequence Id</b> | Sequence Id of the sequence   |
| <b>Rule Id</b>     | Rule Id of the rule   |
| <b>Order Id</b>    | This field indicates the order of the rule in the sequence. The default value for this field will be same as the ruleid of the entry. |

**References:**

- Generic filter related commands

## 5.13.25 Filter seq info Commands

### 5.13.25.1 Get Filter seq info

**Description:**

Use this command to get.

**Command Syntax:**

**get filter seq info [seqid <seqid-val >]**

### 5.13.25.2 Create filter seq info

**Description:**

Use this command to create.

**Command Syntax:**

**create filter seq info seqid seqid [ifname <interface-name> | alleth] [stageid <stageid-val>] [seqdir in | out]**

### 5.13.25.3 Delete filter seq info

**Description:**

Use this command to delete.

**Command Syntax:**

**delete filter seq info seqid <seqid-val>**

### 5.13.25.4 Modify filter seq info

**Description:**

Use this command to modify.

**Command Syntax:**

**modify filter seq info seqid <seqid-val > [ifname <interface-name>| alleth] [stageid <stageid-val>] [seqdir in | out]**

**Parameters:**

| Name | Description |
|------|-------------|
|------|-------------|

|                                   |   |
|-----------------------------------|---|
| <b>seqid</b> <seqid-val>          | Sequence Id of the sequence<br><b>Type:</b> Create -- Mandatory<br>Delete -- Mandatory<br>Modify -- Mandatory<br>Get --Optional<br><b>Valid Values:</b> 1-65535   |
| <b>ifname</b><br><interface-name> | The name of the interface whose mapping is being created. Only EoA, PPPoE, and Ethernet interfaces are allowed. If the value of this field is 'alleth', it indicates all 'Ethernet' interfaces. If the bridge port is created over the aggregated interface, then this field cannot have lflindex of any specific Ethernet interface. If the bridge port over the aggregated interface is not created, then this field cannot have the value 'alleth'. This field should not be specified during creation of an entry in this table and must be specified during modify of an entry in this table.<br><b>Type:</b> Create -- Optional<br>Modify -- Optional |
| <b>stageid</b> <stageid-val>      | Identifier of the stage on the interface for which the sequence is being applied.This field should not be specified during creation of an entry in this table and must be specified during modify of an entry in this table<br><b>Type:</b> Create -- Optional<br>Modify -- Optional<br><b>Valid values:</b> 1-2<br><b>Default Value:</b> 1   |
| <b>seqdir in   out</b>            | This field specifies whether the sequence to be applied in ingress direction or egress direction on the interface.This field should not be specified during creation of an entry in this table and must be specified during modify of an entry in this table.<br><b>Type:</b> Create -- Optional<br>Modify -- Optional<br><b>Default value:</b> In  |

**Example:**

```
$ create filter seq info seqid 1 ifname eoa-0 stageid 1 seqdir 1
```

**Output:**

```
Verbose Mode On
Entry Created
```

```
Sequence Id : 1
```

```
Verbose Mode Off:
Entry Created
```

### Output field:

| Field       | Description                 |
|-------------|-----------------------------|
| Sequence Id | Sequence Id of the sequence |

### References:

- Generic filter related commands

## 5.13.26 Filter subrule arp Commands

### 5.13.26.1 Get Filter subrule arp

#### Description:

Use this command to get.

#### Command Syntax:

```
get filter subrule arp [ruleid <ruleid-val>] [subruleid <subruleid-val>]
```

### 5.13.26.2 Create filter subrule arp

#### Description:

Use this command to create.

#### Command Syntax:

```
create filter subrule arp ruleid <ruleid-val>subruleid <subruleid-val>
[ opcode request | reply | any ] [ srcmacaddrfrom <srcmacaddrfrom-val> ]
[ srcmacaddrto <srcmacaddrto-val> ] [ dstmacaddrfrom <dstmacaddrfrom-val> ]
[ dstmacaddrto <dstmacaddrto-val> ] [ srcipaddrfrom <srcipaddrfrom-val> ]
[ srcipaddrto <srcipaddrto-val> ] [ dstipaddrfrom <dstipaddrfrom-val> ]
[ dstipaddrto <dstipaddrto-val> ] [ srcmacaddrcmp eq | neq | lt | leq | gt | geq |
any | inrange | exrange ] [ dstmacaddrcmp eq | neq | lt | leq | gt | geq | any | inrange
| exrange ] [ srcipaddrcmp eq | neq | lt | leq | gt | geq | any | inrange | exrange |
ingenlist | notingenlist ] [ dstipaddrcmp eq | neq | lt | leq | gt | geq | any | inrange |
exrange | ingenlist | notingenlist ] [ ipsrcaddrmask <ipsrcaddrmask-val> ]
[ ipdstaddrmask <ipdstaddrmask-val> ] [ subruleprio low | high | asinrule ]
```

### 5.13.26.3 Delete filter subrule arp

**Description:**

Use this command to get.

**Command Syntax:**

**delete filter subrule arp ruleid** <ruleid-val>**subruleid** <subruleid-val>

### 5.13.26.4 Modify filter subrule arp

**Description:**

Use this command to create.

**Command Syntax:**

**modify filter subrule arp ruleid** <ruleid-val>**subruleid** <subruleid-val>  
[ **opcode** request | reply | any ] [ **srcmacaddrfrom** <srcmacaddrfrom-val> ]  
[ **srcmacaddrto** <srcmacaddrto-val> ] [ **dstmacaddrfrom** <dstmacaddrfrom-val> ]  
[ **dstmacaddrto** <dstmacaddrto-val> ] [ **srcipaddrfrom** <srcipaddrfrom-val> ]  
[ **srcipaddrto** <srcipaddrto-val> ] [ **dstipaddrfrom** <dstipaddrfrom-val> ]  
[ **dstipaddrto** <dstipaddrto-val> ] [ **srcmacaddrcmp** eq | neq | lt | leq | gt | geq |  
any | inrange | exrange ] [ **dstmacaddrcmp** eq | neq | lt | leq | gt | geq | any | inrange  
| exrange ] [ **srcipaddrcmp** eq | neq | lt | leq | gt | geq | any | inrange | exrange |  
ingenlist | notingenlist ] [ **dstipaddrcmp** eq | neq | lt | leq | gt | geq | any | inrange |  
exrange | ingenlist | notingenlist ] [ **ipsrcaddrmask** <ipsrcaddrmask-val> ]  
[ **ipdstaddrmask** <ipdstaddrmask-val> ] [ **subruleprio** low | high | asinrule ]

**Parameters:**

| Name                                | Description  |
|-------------------------------------|--|
| <b>ruleid</b> <ruleid-val>          | Unique identifier of a filter rule of which this sub rule is being created.<br><b>Type:</b> Create -- Mandatory<br>Delete -- Mandatory<br>Modify -- Mandatory<br>Get -- Optional<br><b>Valid values:</b> 1 - 65535 |
| <b>subruleid</b><br><subruleid-val> | Unique identifier of a filter subrule.<br><b>Type:</b> Create -- Mandatory<br>Delete -- Mandatory<br>Modify -- Mandatory<br>Get -- Optional<br><b>Valid values:</b> 1 - 4294967295                                 |

|   |   |
|---|---|
| <p><b>opcode</b> request   reply   any</p>                  | <p>The opcode identifies whether the packet is ARP request or reply. This field specifies the type of packets on which the subrule is to be applied. If 'any' is specified, both request and reply packets are filtered.</p> <p><b>Type:</b> Create -- Optional<br/> Modify -- Optional</p> <p><b>Default value:</b> any</p>  |
| <p><b>srcmacaddrfrom</b><br/>&lt;srcmacaddrfrom-val&gt;</p> | <p>Start source Mac address of the range of source Mac addresses. This field is invalid if srcmacaddrcmp is 'any'. This field and the srcmacaddrto field specify a range of source Mac addresses if srcmacaddrcmp is either 'inrange' or'exrange'.</p> <p><b>Type:</b> Create -- Optional<br/> Modify -- Optional</p> <p><b>Default value:</b> "\0"</p>                     |
| <p><b>srcmacaddrto</b><br/>&lt;srcmacaddrto-val&gt;</p>     | <p>End source Mac address of the range of source Mac addresses. This field and the srcmacaddrfrom field specify a range of source Mac addresses, if srcmacaddrcmp is either 'inrange' or'exrange'.Otherwise this field is invalid.</p> <p><b>Type:</b> Create -- Optional<br/> Modify -- Optional</p> <p><b>Default value:</b> "\xff\xff\xff\xff\xff\xff"</p>               |
| <p><b>dstmacaddrfrom</b><br/>&lt;dstmacaddrfrom-val&gt;</p> | <p>Start destination Mac address of the range of destination Mac addresses. This field is invalid if'dstmacaddrcmp'is 'any'.This field and the dstmacaddrto field specify a range of destination Mac addresses if dstmacaddrcmp is either 'inrange' or'exrange'.</p> <p><b>Type:</b> Create -- Optional<br/> Modify -- Optional</p> <p><b>Default value:</b> "\0"</p>       |
| <p><b>dstmacaddrto</b><br/>&lt;dstmacaddrto-val&gt;</p>     | <p>End destination Mac address of the range of destination Mac addresses. This field and the dstmacaddrfrom field specify a range of destination Mac addresses, if dstmacaddrcmp is either'inrange' or'exrange'.Otherwise this field is invalid.</p> <p><b>Type:</b> Create -- Optional<br/> Modify -- Optional</p> <p><b>Default value:</b> "\xff\xff\xff\xff\xff\xff"</p> |

|  |  |
|--|--|
| <p><b>srcipaddrfrom</b><br/>&lt;srcipaddrfrom-val&gt;</p>                            | <p>Start source IP address of the range of source IP addresses. This field is invalid if srcaddrcmp is 'any','ingenlist' or 'notingenlist'.If srcaddrcmp is either 'inrange' or 'exrange', this field and srcipaddrto field specify a range of source IP addresses.</p> <p><b>Type:</b> Create -- Optional<br/>Modify -- Optional</p> <p><b>Default value:</b> 0.0.0.0</p>   |
| <p><b>srcipaddrto</b><br/>&lt;srcipaddrto-val&gt;</p>                                | <p>End source IP address of the range of source IP addresses. This field is invalid if srcaddrcmp is 'any','ingenlist' or 'notingenlist'.If srcaddrcmp is either 'inrange' or 'exrange', this field and srcipaddrfrom field specify a range of source IP addresses.</p> <p><b>Type:</b> Create -- Optional<br/>Modify -- Optional</p> <p><b>Default value:</b> 255.255.255.255</p>   |
| <p><b>dstipaddrfrom</b><br/>&lt;dstipaddrfrom-val&gt;</p>                            | <p>Start destination IP address of the range of destination IP addresses. This field is invalid if dstaddrcmp is 'any','ingenlist' or 'notingenlist'.If dstaddrcmp is either 'inrange' or 'exrange', this field and dstipaddrto field specify a range of destination IP addresses.</p> <p><b>Type:</b> Create -- Optional<br/>Modify -- Optional</p> <p><b>Default value:</b> 0.0.0.0</p>  |
| <p><b>dstipaddrto</b><br/>&lt;dstipaddrto-val&gt;</p>                                | <p>End destination IP address of the range of destination IP addresses. This field is invalid if dstaddrcmp is 'any','ingenlist' or 'notingenlist'.This field and the previous field specify a range of destination IP addresses, if dstaddrcmp is either 'inrange' or 'exrange'.Otherwise this field is invalid.</p> <p><b>Type:</b> Create -- Optional<br/>Modify -- Optional</p> <p><b>Default value:</b> 255.255.255.255</p> |
| <p><b>srcmacaddrcmp</b> eq   neq   lt   leq   gt   geq   any   inrange   exrange</p> | <p>Source Mac address comparison type.</p> <p><b>Type:</b> Create -- Optional<br/>Modify -- Optional</p> <p><b>Default value:</b> any</p>  |
| <p><b>dstmacaddrcmp</b> eq   neq   lt   leq   gt   geq   any   inrange   exrange</p> | <p>Destination Mac address comparison type.</p> <p><b>Type:</b> Create -- Optional<br/>Modify -- Optional</p> <p><b>Default value:</b> any</p>   |



|  |   |
|--|---|
| <b>srcipaddrcmp</b> eq   neq  <br>lt   leq   gt   geq   any  <br>inrange   exrange  <br>ingenlist   notingenlist | <p>Source IP address comparison type.'Ingenlist' means check if source IP address present in interface classifier generic list.'Notingenlist' means check if source IP address not present in interface classifier generic list. 'Ingenlist' and 'Notingenlist' are invalid if the direction of the rule for which this subrule is being created is 'out'.</p> <p><b>Type:</b> Create -- Optional<br/>                  Modify -- Optional</p> <p><b>Default value:</b> any</p>               |
| <b>dstipaddrcmp</b> eq   neq  <br>lt   leq   gt   geq   any  <br>inrange   exrange  <br>ingenlist   notingenlist | <p>Destination IP address comparison type.'Ingenlist' means check if destination IP address present in interface classifier generic list.'Notingenlist' means check if destination IP address not present in interface classifier generic list.'Ingenlist' and 'Notingenlist' are invalid if the direction of the rule for which this subrule is being created is 'out'.</p> <p><b>Type:</b> Create -- Optional<br/>                  Modify -- Optional</p> <p><b>Default value:</b> any</p> |
| <b>ipsrcaddrmask</b><br><ipsrcaddrmask-val>  | <p>The mask value for source IP address. The mask is applied over the source IP address before checking against a value.</p> <p><b>Type:</b> Create -- Optional<br/>                  Modify -- Optional</p> <p><b>Valid values:</b> 1 - 0xffffffff</p> <p><b>Default value:</b> 0xffffffff</p>   |
| <b>ipdstaddrmask</b><br><ipdstaddrmask-val>  | <p>The mask value for destination IP address. The mask is applied over the destination IP address before checking against a value.</p> <p><b>Type:</b> Create -- Optional<br/>                  Modify -- Optional</p> <p><b>Valid values:</b> 1 - 0xffffffff</p> <p><b>Default value:</b> 0xffffffff</p>   |
| <b>subruleprio</b> low   high  <br>asinrule  | <p>This specifies the priority of the subrule. Based on this priority value, the subrule is created in fast or slow memory. In case priority is specified as 'asinrule', subrule priority will be same as specified in the rule.</p> <p><b>Type:</b> Create -- Optional<br/>                  Modify -- Optional</p> <p><b>Default value:</b> asinrule</p>  |

**Example:**

```
$ create filter subrule arp ruleid 1 subruleid 2 opcode request srcmacaddrfrom
00:01:02:03:04:05 srcmacaddrto 00:01:02:03:04:10 dstmacaddrfrom
00:02:03:04:05:11 dstmacaddrto 00:02:03:04:05:15 srcipaddrfrom 172.25.1.125
srcipaddrto 172.25.5.125 dstipaddrfrom 172.25.6.125 dstipaddrto 172.25.10.125
srcmacaddrcmp inrange dstmacaddrcmp exrange srcipaddrcmp inrange
dstipaddrcmp exrange ipsrcaddrmask 0xffff0000 ipdstaddrmask 0xffff0000
subruleprio high
```

**Output:**

Verbose Mode On  
Entry Created

```
Rule Id           : 1                Subrule Id       : 2
Opcode           : request
Start Src Mac Addr : 00:01:02:03:04:05 End Src Mac Addr : 00:01:02:03:04:10
Start Dest Mac Addr : 00:02:03:04:05:11 End Dest Mac Addr : 00:02:03:04:05:15
Start Src Ip Addr  : 172.25.1.125      End Src Ip Addr  : 172.25.5.125
Start Dest Ip Addr : 172.25.6.125             End Dest Ip Addr : 172.25.10.125
Src Mac Addr Cmp   : inrange
Dest Mac Addr Cmp  : exrange
Src Ip Addr Cmp    : inrange
Dest Ip Addr Cmp   : exrange
Ip Src Addr Mask   : 0xffff0000
Ip Dest Addr Mask  : 0xffff0000
Subrule Prio      : high
```

Verbose Mode Off:  
Entry Created

**Parameters**

| Name              | Description   |
|-------------------|---|
| <b>Rule Id</b>    | Unique identifier of a filter rule of which this sub rule is being created.   |
| <b>Subrule Id</b> | Unique identifier of a filter subrule.  |
| <b>Opcode</b>     | The opcode identifies whether the packet is ARP request or reply. This field specifies the type of packets on which the subrule is to be applied. If 'any' is specified, both request and reply packets are filtered. |

|                            |  |
|----------------------------|--|
| <b>Start Src Mac Addr</b>  | Start source Mac address of the range of source Mac addresses. This field is invalid if srcmacaddrcmp is 'any'. This field and the srcmacaddrto field specify a range of source Mac addresses if srcmacaddrcmp is either 'inrange' or'exrange'.  |
| <b>End Src Mac Addr</b>    | End source Mac address of the range of source Mac addresses. This field and the srcmacaddrfrom field specify a range of source Mac addresses, if srcmacaddrcmp is either 'inrange' or'exrange'.Otherwise this field is invalid.  |
| <b>Start Dest Mac Addr</b> | Start destination Mac address of the range of destination Mac addresses. This field is invalid if dstmacaddrcmp is 'any'.This field and the dstmacaddrto field specify a range of destination Mac addresses if dstmacaddrcmp is either 'inrange' or'exrange'.  |
| <b>End Dest Mac Addr</b>   | End destination Mac address of the range of destination Mac addresses. This field and the dstmacaddrfrom field specify a range of destination Mac addresses, if dstmacaddrcmp is either'inrange' or'exrange'.Otherwise this field is invalid.  |
| <b>Start Src Ip Addr</b>   | Start source IP address of the range of source IP addresses. This field is invalid if srcaddrcmp is 'any','ingenlist' or'notingenlist'.If srcaddrcmp is either 'inrange' or 'exrange', this field and srcipaddrto field specify a range of source IP addresses.  |
| <b>End Src Ip Addr</b>     | End source IP address of the range of source IP addresses. This field is invalid if srcaddrcmp is 'any','ingenlist' or 'notingenlist'.If srcaddrcmp is either 'inrange' or 'exrange', this field and srcipaddrfrom field specify a range of source IP addresses.   |
| <b>Start Dest Ip Addr</b>  | Start destination IP address of the range of destination IP addresses. This field is invalid if dstaddrcmp is 'any','ingenlist' or 'notingenlist'.If dstaddrcmp is either 'inrange' or 'exrange', this field and dstipaddrto field specify a range of destination IP addresses.                                |
| <b>End Dest Ip Addr</b>    | End destination IP address of the range of destination IP addresses. This field is invalid if dstaddrcmp is 'any','ingenlist' or 'notingenlist'.This field and the previous field specify a range of destination IP addresses, if dstaddrcmp is either 'inrange' or 'exrange'.Otherwise this field is invalid. |
| <b>Src Mac Addr Cmp</b>    | Source Mac address comparison type.  |
| <b>Dest Mac Addr Cmp</b>   | Destination Mac address comparison type.   |

|                          |  |
|--------------------------|--|
| <b>Src Ip Addr Cmp</b>   | Source IP address comparison type. 'Ingenlist' means check if source IP address present in interface classifier generic list. 'Notingenlist' means check if source IP address not present in interface classifier generic list. 'Ingenlist' and 'Notingenlist' are invalid if the direction of the rule for which this subrule is being created is 'out'.                |
| <b>Dest Ip Addr Cmp</b>  | Destination IP address comparison type. 'Ingenlist' means check if destination IP address present in interface classifier generic list. 'Notingenlist' means check if destination IP address not present in interface classifier generic list. 'Ingenlist' and 'Notingenlist' are invalid if the direction of the rule for which this subrule is being created is 'out'. |
| <b>Ip Src Addr Mask</b>  | The mask value for source IP address. The mask is applied over the source IP address before checking against a value.  |
| <b>Ip Dest Addr Mask</b> | The mask value for destination IP address. The mask is applied over the destination IP address before checking against a value.  |
| <b>Subrule Prio</b>      | This specifies the priority of the subrule. Based on this priority value, the subrule is created in fast or slow memory. In case priority is specified as 'asinrule', subrule priority will be same as specified in the rule.  |

## 5.13.27 Filter subrule clftree Commands

### 5.13.27.1 Get Filter subrule clftree

**Description:**

Use this command to get.

**Command Syntax:**

**get filter subrule clftree [ruleid <ruleid-val>] [subruleid <subruleid-val >]**

### 5.13.27.2 Create filter subrule clftree

**Description:**

Use this command to create.

**Command Syntax:**

**create filter subrule clftree ruleid <ruleid-val > subruleid <subruleid-val > tname <tname-val > entrypid <entrypid-val >**

### 5.13.27.3 Delete filter subrule clftree

**Description:**

Use this command to delete.

**Command Syntax:**

**delete filter subrule clftree ruleid** <ruleid-val > **subruleid** <subruleid-val >

### 5.13.27.4 Modify filter subrule clftree

**Description:**

Use this command to modify.

**Command Syntax:**

**modify filter subrule clftree ruleid** <ruleid-val > **subruleid** <subruleid-val >  
[**tname** <tname-val >] [**entrypid** <entrypid-val >]

**Parameter:**

| Name                         | Description   |
|------------------------------|---|
| <b>ruleid</b> <ruleid>       | Unique identifier of a filter rule of which this sub rule is being created.<br><b>Type:</b> Create -- Mandatory<br>Delete -- Mandatory<br>Modify --Mandatory<br>Get -- Optional<br><b>Valid values:</b> 1- 65535  |
| <b>Subruleid</b> <subruleid> | Unique identifier of a filter subrule.<br><b>Type:</b> Create -- Mandatory<br>Delete -- Mandatory<br>Modify -- Mandatory<br>Get --Optional<br><b>Valid values:</b> 1 - 4294967295   |
| <b>tname</b> <tname>         | Name of the classifier tree which is to be included as subrule of this rule.<br>This classifier tree should exist and be enabled. A classifier tree can be used only in one subrule. The Maximum length of Name should be 32.<br><b>Type:</b> Create -- Mandatory<br>Modify -- Optional |
| <b>entrypid</b> <entrypid>   | Profile Id of the tree, which shall be treated as an entry point for it.<br><b>Type:</b> Create -- Mandatory<br>Modify -- Optional<br><b>Valid values:</b> 1 - 0xffffffff   |

**Example:**

```
$ create filter subrule clfrtree ruleid 1 subruleid 2 tname igmp entrypid 2
```

**Output:**

Verbose Mode On

Entry Created

Rule Id : 1 Subrule Id : 2

Tree Name : igmp

Entry Profile Id : 2

Verbose Mode Off:

Entry Created

**Output field:**

| Field            | Description  |
|------------------|--|
| Rule Id          | Unique identifier of a filter rule of which this sub rule is being created.  |
| Subrule Id       | Unique identifier of a filter subrule.   |
| Tree Name        | Name of the classifier tree which is to be included as subrule of this rule. This classifier tree should exist and be enabled. A classifier tree can be used only in one subrule. The Maximum length of Name should be 32. |
| Entry Profile Id | Profile Id of the tree, which shall be treated as an entry point for it.   |

**References:**

- see generic filter related commands

## 5.13.28 Filter subrule ether Commands

### 5.13.28.1 Get Filter subrule ether

**Description:**

Use this command to get.

**Command Syntax:**

```
get filter subrule ether [ruleid <ruleid-val >] [subruleid <subruleid-val >]
```

### 5.13.28.2 Create filter subrule ether

**Description:**

Use this command to create.

**Command Syntax:**

```
create filter subrule ether ruleid <ruleid-val > subruleid <subruleid-val >
>[ srcmacaddrfrom <srcmacaddrfrom-val> ] [ srcmacaddrto
<srcmacaddrto-val> ] [ dstmacaddrfrom <dstmacaddrfrom-val> ] [ dstmacaddrto
<dstmacaddrto-val> ] [ ethertypefrom <ethertypefrom-val> ] [ ethertypeto
<ethertypeto-val> ] [ vlanidfrom <vlanidfrom-val> ] [ vlanidto <vlanidto-val> ]
[ priotagfrom <priotagfrom-val> ] [ priotagto <priotagto-val> ] [ dsapfrom
<dsapfrom-val> ] [ dsapto <dsapto-val> ] [ ssapfrom <ssapfrom-val> ] [ ssapto
<ssapto-val> ] [ srcmacaddrcmp eq | neq | lt | leq | gt | geq | any | inrange |
exrange ] [ dstmacaddrcmp eq | neq | lt | leq | gt | geq | any | inrange |
exrange ] [ ethertypecmp eq | neq | lt | leq | gt | geq | any | inrange | exrange ]
[ vlanidcmp eq | neq | lt | leq | gt | geq | any | inrange | exrange ] [ priotagcmp
eq | neq | lt | leq | gt | geq | any | inrange | exrange ] [ dsapcmp eq | neq | lt |
leq | gt | geq | any | inrange | exrange ] [ ssapcmp eq | neq | lt | leq | gt | geq |
any | inrange | exrange ] [ subruleprio low | high | asinrule ]
[ servicevlanidfrom <servicevlanidfrom-val> ] [ servicevlanidto
<servicevlanidto-val> ] [ servicepriotagfrom <servicepriotagfrom-val> ]
[ servicepriotagto <servicepriotagto-val> ] [ servicevlanidcmp eq | neq | lt | leq |
gt | geq | any | inrange | exrange ] [ servicepriotagcmp eq | neq | lt | leq | gt |
geq | any | inrange | exrange ]
```

### 5.13.28.3 Delete filter subrule ether

**Description:**

Use this command to delete.

**Command Syntax:**

**delete filter subrule ether ruleid** <ruleid-val > **subruleid** <subruleid-val >

### 5.13.28.4 Modify filter subrule ether

**Description:**

Use this command to modify.

**Command Syntax:**

**modify filter subrule ether ruleid** <ruleid-val > **subruleid** <subruleid-val >  
>[ **srcmacaddrfrom** <srcmacaddrfrom-val> ] [ **srcmacaddrto** <srcmacaddrto-val> ] [ **dstmacaddrfrom** <dstmacaddrfrom-val> ] [ **dstmacaddrto** <dstmacaddrto-val> ] [ **ethertypefrom** <ethertypefrom-val> ] [ **ethertypeto** <ethertypeto-val> ] [ **vlanidfrom** <vlanidfrom-val> ] [ **vlanidto** <vlanidto-val> ] [ **priotagfrom** <priotagfrom-val> ] [ **priotagto** <priotagto-val> ] [ **dsapfrom** <dsapfrom-val> ] [ **dsapto** <dsapto-val> ] [ **ssapfrom** <ssapfrom-val> ] [ **ssapto** <ssapto-val> ] [ **srcmacaddrcmp** eq | neq | lt | leq | gt | geq | any | inrange | exrange ] [ **dstmacaddrcmp** eq | neq | lt | leq | gt | geq | any | inrange | exrange ] [ **ethertypecmp** eq | neq | lt | leq | gt | geq | any | inrange | exrange ] [ **vlanidcmp** eq | neq | lt | leq | gt | geq | any | inrange | exrange ] [ **priotagcmp** eq | neq | lt | leq | gt | geq | any | inrange | exrange ] [ **dsapcmp** eq | neq | lt | leq | gt | geq | any | inrange | exrange ] [ **ssapcmp** eq | neq | lt | leq | gt | geq | any | inrange | exrange ] [ **subruleprio** low | high | asinrule ] [ **servicevlanidfrom** <servicevlanidfrom-val> ] [ **servicevlanidto** <servicevlanidto-val> ] [ **servicepriotagfrom** <servicepriotagfrom-val> ] [ **servicepriotagto** <servicepriotagto-val> ] [ **servicevlanidcmp** eq | neq | lt | leq | gt | geq | any | inrange | exrange ] [ **servicepriotagcmp** eq | neq | lt | leq | gt | geq | any | inrange | exrange ]



## Parameter:

| Name  | Description   |
|---|---|
| <b>ruleid</b> <ruleid-val>                    | Unique identifier of a filter rule of which this sub rule is being created<br><b>Type:</b> Create – Mandatory<br>Delete – Mandatory<br>Modify – Mandatory<br>Get – Optional<br><b>Valid values:</b> 1 - 65535   |
| <b>subruleid</b><br><subruleid-val>           | Unique identifier of a filter subrule<br><b>Type:</b> Create – Mandatory<br>Delete – Mandatory<br>Modify – Mandatory<br>Get – Optional<br><b>Valid values:</b> 1 - 4294967295   |
| <b>srcmacaddrfrom</b><br><srcmacaddrfrom-val> | Start source MAC address of the range of source MAC addresses. This field is invalid if 'srcmacaddrcmp' is 'any'. This field and 'srcmacaddrto' specify a range of source MAC addresses if 'srcmacaddrcmp' is either 'inrange' or 'exrange'<br><b>Type:</b> Create – Optional<br>Modify – Optional<br><b>Default value:</b> "\0"                |
| <b>srcmacaddrto</b><br><srcmacaddrto-val>     | End source MAC address of the range of source MAC addresses. This field and 'srcmacaddrfrom' specify a range of source MAC addresses, if 'srcmacaddrcmp' is either 'inrange' or 'exrange'. Otherwise this field is invalid<br><b>Type:</b> Create – Optional<br>Modify – Optional<br><b>Default value:</b> "\xff\xff\xff\xff\xff\xff"           |
| <b>dstmacaddrfrom</b><br><dstmacaddrfrom-val> | Start destination MAC address of the range of destination MAC addresses. This field is invalid if 'dstmacaddrcmp' is 'any'. This field and the next field specify a range of destination MAC addresses if 'dstmacaddrcmp' is either 'inrange' or 'exrange'<br><b>Type:</b> Create – Optional<br>Modify – Optional<br><b>Default value:</b> "\0" |
| <b>dstmacaddrto</b><br><dstmacaddrto-val>     | End destination MAC address of the range of destination MAC addresses. This field and the previous field specify a range of destination MAC addresses if 'dstmacaddrcmp' is either 'inrange' or 'exrange'. Otherwise this field is invalid<br><b>Type:</b> Create – Optional  |

|   |   |
|---|---|
|   | <p>Modify — Optional</p> <p><b>Default value:</b> "\xff\xff\xff\xff\xff\xff"</p>  |
| <p><b>ethertypefrom</b><br/>&lt;ethertypefrom-val&gt;</p> | <p>Start ether type of the range of ether types. This field is invalid if 'ethertypecmp' is 'any'. This field and the next field specify a range of ether types, if 'ethertypecmp' is either 'inrange' or 'exrange' <b>Type:</b> Create — Optional</p> <p>Modify — Optional</p> <p><b>Default value:</b> 0</p>  |
| <p><b>ethertypeto</b><br/>&lt;ethertypeto-val&gt;</p>     | <p>End ether type of the range of ether types. This field and the previous field specify a range of ether types, if 'ethertypecmp' is either 'inrange' or 'exrange'. Otherwise this field is invalid</p> <p><b>Type:</b> Create — Optional</p> <p>Modify — Optional</p> <p><b>Default value:</b> 0xFFFF</p>   |
| <p><b>vlanidfrom</b><br/>&lt;vlanidfrom-val&gt;</p>       | <p>Start VLAN Id of the range of VLAN IDs. Invalid, if the direction of the rule for which this subrule is being created is 'out'. This field is invalid if 'vlanidcmp' is 'any'(7). This field and the vlanidto field specify a range of VLAN Ids, if 'vlanidcmp' is either 'inrange'(8) or'exrange'(9).In VLAN stacking mode this parameter maps to customer VLAN ID. <b>Type:</b> Create — Optional</p> <p>Modify — Optional</p> <p><b>Valid values:</b> 1 - 4094</p> <p><b>Default value:</b> 1</p>   |
| <p><b>vlanidto</b> &lt;vlanidto-val&gt;</p>               | <p>End VLAN Id of the range of VLAN IDs.Invalid, if the direction of the rule for which this subrule is being created is 'out'. This field and the vlanidfrom field specify a range of VLAN Ids, if 'vlanidcmp' is either 'inrange'(8) or 'exrange'(9). Otherwise, this field is invalid. In VLAN stacking mode this parameter maps to customer VLAN ID.</p> <p><b>Type:</b> Create — Optional</p> <p>Modify — Optional</p> <p><b>Valid values:</b> 1 - 4094</p> <p><b>Default value:</b> 4094</p>  |
| <p><b>priotagfrom</b><br/>&lt;priotagfrom-val&gt;</p>     | <p>Start priority tag of the range of priority tags. Invalid, if the direction of the rule for which this subrule is being created is 'out'. This field is invalid if 'priotagcmp' is 'any'(7). This field and the priotagto field specify a range of priority tags, if 'priotagcmp' is either 'inrange'(8) or 'exrange'(9).In VLAN stacking mode this parameter maps to priority in the customer VLAN tag.</p> <p><b>Type:</b> Create — Optional</p> <p>Modify — Optional</p> <p><b>Valid values:</b> 0 - 7</p> <p><b>Default value:</b> 0</p> |

|  |   |
|--|---|
| <p><b>priotagto</b><br/>&lt;priotagto-val&gt;</p>  | <p>End priority tag of the range of priority tags. Invalid, if the direction of the rule for which this subrule is being created is 'out'. This field and the priotagfrom field specify a range of priority tags, if 'priotagcmp' is either 'inrange'(8) or 'exrange'(9). Otherwise this field is invalid. In VLAN stacking mode this parameter maps to priority in the customer VLAN tag.</p> <p><b>Type:</b> Create — Optional<br/>Modify — Optional</p> <p><b>Valid values:</b> 0 - 7</p> <p><b>Default value:</b> 7</p> |
| <p><b>dsapfrom</b><br/>&lt;dsapfrom-val&gt;</p>  | <p>Start DSAP of the range of DSAPs. This object is invalid if 'dsapcmp' is 'any'. This object and the next object specify a range of DSAPs, if 'dsapcmp' is either 'inrange' or 'exrange'</p> <p><b>Type:</b> Create — Optional<br/>Modify — Optional</p> <p><b>Default value:</b> 0x00</p>  |
| <p><b>dsapto</b> &lt;dsapto-val&gt;</p>  | <p>End DSAP of the range of DSAPs. This object is invalid if 'dsapcmp' is 'any'. This object and the previous object specify a range of DSAPs, if 'dsapcmp' is either 'inrange' or 'exrange'. Otherwise this field is invalid.</p> <p><b>Type:</b> Create — Optional<br/>Modify — Optional</p> <p><b>Default value:</b> 0xff</p>  |
| <p><b>ssapfrom</b><br/>&lt;ssapfrom-val&gt;</p>  | <p>Start SSAP of the range of SSAPs. This object is invalid if 'ssapcmp' is 'any'. This object and the next object specify a range of SSAPs, if 'ssapcmp' is either 'inrange' or 'exrange'</p> <p><b>Type:</b> Create — Optional<br/>Modify — Optional</p> <p><b>Default value:</b> 0x00</p>  |
| <p><b>ssapto</b> &lt;ssapto-val&gt;</p>  | <p>End SSAP of the range of SSAPs. This object is invalid if 'ssapcmp' is 'any'. This object and the previous object specify a range of SSAPs, if 'ssapcmp' is either 'inrange' or 'exrange'. Otherwise this field is invalid</p> <p><b>Type:</b> Create — Optional<br/>Modify — Optional</p> <p><b>Default value:</b> 0xff</p>   |
| <p><b>srcmacaddrcmp</b> eq  <br/>neq  lt   leq   gt   geq  <br/>any  inrange   exrange</p> | <p>Source mac address comparison type</p> <p><b>Type:</b> Create — Optional<br/>Modify — Optional</p> <p><b>Default value:</b> any</p>  |
| <p><b>dstmacaddrcmp</b> eq  <br/>neq  lt   leq   gt   geq  <br/>any  inrange   exrange</p> | <p>Destination mac address comparison type</p> <p><b>Type:</b> Create — Optional<br/>Modify — Optional</p>  |

|  |  |
|--|--|
|  | <b>Default value:</b> any  |
| <b>ethertypecmp eq   neq   lt   leq   gt   geq   any   inrange   exrange</b> | Ether type comparison type<br><b>Type:</b> Create — Optional<br>Modify — Optional<br><b>Default value:</b> any   |
| <b>vlanidcmp eq   neq   lt   leq   gt   geq   any   inrange   exrange</b>    | VLAN Id comparison type. This field must be 'any', if 'priotagcmp' is not equal to 'any'<br><b>Type:</b> Create — Optional<br>Modify — Optional<br><b>Default value:</b> any   |
| <b>priotagcmp eq   neq   lt   leq   gt   geq   any   inrange   exrange</b>   | Priority tag comparison type. This field must be 'any', if 'vlanidcmp' is not equal to 'any'<br><b>Type:</b> Create — Optional<br>Modify — Optional<br><b>Default value:</b> any   |
| <b>ssapcmp eq   neq   lt   leq   gt   geq   any   inrange   exrange</b>      | SSAP comparison type.<br><b>Type:</b> Create — Optional<br>Modify — Optional<br><b>Default value:</b> any  |
| <b>subruleprio low   high   asinrule</b>                                     | This specifies the priority of the subrule. Based on this priority value, the subrule is created in fast or slow memory. In case priority is specified as 'asinrule', subrule priority will be same as specified in the rule.<br><b>Type:</b> Create — Optional<br>Modify — Optional<br><b>Default value:</b> asinrule   |
| <b>servicevlanidfrom</b><br><servicevlanidfrom-val>                          | Start service VLAN Id of the range of service VLAN IDs. Invalid, if the direction of the rule for which this subrule is being created is 'out'. This field is invalid if 'vlanidcmp' is 'any'(7). This field and the servicevlanidto field specify a range of service VLAN Ids, if 'servicevlanidcmp' is either 'inrange'(8) or 'exrange'(9).In native mode configuring this parameter will result in error. <b>Type:</b> Create — Optional<br>Modify — Optional<br><b>Valid values:</b> 1 - 4094<br><b>Default value:</b> 1 |
| <b>servicevlanidto</b><br><servicevlanidto-val>                              | End service VLAN Id of the range of service VLAN IDs.Invalid, if the direction of the rule for which this subrule is being created is 'out'. This field and the servicevlanidfrom field specify a range of service VLAN Ids, if 'servicevlanidcmp' is either 'inrange'(8) or 'exrange'(9).Otherwise, this field is invalid In native mode configuring this parameter will result in error.<br><b>Type:</b> Create — Optional   |

|  |   |
|--|---|
|  | <p>Modify — Optional</p> <p><b>Valid values:</b> 1 - 4094</p> <p><b>Default value:</b> 4094</p>   |
| <p><b>servicepriotagfrom</b><br/>&lt;servicepriotagfrom-val&gt;</p>                      | <p>Start service priority tag of the range of priority tags. Invalid, if the direction of the rule for which this subrule is being created is 'out'. This field is invalid if 'etherhPrioTagCmpType' is 'any'(7). This field and the etherPriorityTagTo field specify a range of priority tags, if 'etherhPrioTagCmpType' is either 'inrange'(8) or 'exrange'(9).In native mode configuring this parameter will result in error. <b>Type:</b> Create — Optional</p> <p>Modify — Optional</p> <p><b>Valid values:</b> 0 - 7</p> <p><b>Default value:</b> 0</p> |
| <p><b>servicepriotagto</b><br/>&lt;servicepriotagto-val&gt;</p>                          | <p>End service priority tag of the range of priority tags. Invalid, if the direction of the rule for which this subrule is being created is 'out'. This field and the etherhPriorityTagFrom field specify a range of service priority tags, if 'etherhServicePrioTagCmpType' is either 'inrange'(8) or 'exrange'(9). Otherwise this field is invalid. In native mode configuring this parameter will result in error.</p> <p><b>Type:</b> Create — Optional</p> <p>Modify — Optional</p> <p><b>Valid values:</b> 0 - 7</p> <p><b>Default value:</b> 7</p>     |
| <p><b>servicevlanidcmp eq   neq   lt   leq   gt   geq   any   inrange   exrange</b></p>  | <p>Service VLAN Id comparison type. This field must be 'any (7)', if etherhPrioTagCmpType is not equal to 'any (7)'In native mode configuring this parameter will result in error.</p> <p><b>Type:</b> Create — Optional</p> <p>Modify — Optional</p> <p><b>Default value:</b> any</p>  |
| <p><b>servicepriotagcmp eq   neq   lt   leq   gt   geq   any   inrange   exrange</b></p> | <p>Service Priority tag comparison type.This field must be 'any (7)', if vlanidcmp is not equal to 'any (7)'.In native mode configuring this parameter will result in error.</p> <p><b>Type:</b> Create — Optional</p> <p>Modify — Optional</p> <p><b>Default value:</b> any</p>  |

### Example:

```
$ create filter subrule ether ruleid 1 subruleid 2 srcmacaddrfrom 00:01:02:03:04:05
srcmacaddrto 00:01:02:03:04:10 dstmacaddrfrom 00:02:03:04:05:11
dstmacaddrto 00:02:03:04:05:15 ethertypefrom 0x0800 ethertypeto 0x0810
vlanidfrom 2 vlanidto 5 priotagfrom 2 priotagto 5 dsapfrom 0xf0 dsapto 0xff
ssapfrom 0xf0 ssapto 0xff srcmacaddrcmp inrange dstmacaddrcmp exrange
```

```
ethertypecmp inrange vlanidcmp exrange priotagcmp inrange dsapcmp inrange
ssapcmp inrange subruleprio high servicevlanidfrom 2 servicevlanidto 5
servicepriotagfrom 2 servicepriotagto 5 servicevlanidcmp exrange
servicepriotagcmp inrange
```

**Output:**

Verbose Mode On

Entry Created

```
Rule Id                : 1                Subrule Id            : 2
Start source mac address : 00:01:02:03:04:05
End source mac address   : 00:01:02:03:04:10
Start destination MAC address : 00:02:03:04:05:11
End destination MAC address   : 00:02:03:04:05:15
Start ethernet type      : 0x0800      End ethernet type : 0x0810
Start VLAN Id            : 2              End VLAN Id        : 5
Start priority tag       : 2              End priority tag   : 5
Start DSAP                : 0xf0          End DSAP           : 0xff
Start SSAP                : 0xf0          End SSAP           : 0xff
Source MAC addresses comparison : inrange
Destination MAC address comparison : exrange
Ether type comparison     : inrange
Vlan Id comparison       : exrange
Priority tag comparison    : inrange
DSAP comparison          : inrange
SSAP comparison          : inrange
Subrule Priority          : high
Start service VLAN Id    : 2
End service VLAN Id      : 5
Start service priority tag : 2
End service priority tag : 5
service Vlan Id comparison : exrange
Service Priority tag comparison : inrange
```

Verbose Mode Off:

Entry Created

## Output field:

| Field                                | Description  |
|--------------------------------------|--|
| <b>Rule Id</b>                       | Unique identifier of a filter rule of which this sub rule is being created   |
| <b>Subrule Id</b>                    | Unique identifier of a filter subrule  |
| <b>Start source mac address</b>      | Start source MAC address of the range of source MAC addresses. This field is invalid if 'srcmacaddrcomp' is 'any'. This field and 'srcmacaddrto' specify a range of source MAC addresses if 'srcmacaddrcomp' is either 'inrange' or 'exrange'  |
| <b>End source mac address</b>        | End source MAC address of the range of source MAC addresses. This field and 'srcmacaddrfrom' specify a range of source MAC addresses, if 'srcmacaddrcomp' is either 'inrange' or 'exrange'. Otherwise this field is invalid  |
| <b>Start destination MAC address</b> | Start destination MAC address of the range of destination MAC addresses. This field is invalid if 'dstmacaddrcomp' is 'any'. This field and the next field specify a range of destination MAC addresses if 'dstmacaddrcomp' is either 'inrange' or 'exrange'   |
| <b>End destination MAC address</b>   | End destination MAC address of the range of destination MAC addresses. This field and the previous field specify a range of destination MAC addresses if 'dstmacaddrcomp' is either 'inrange' or 'exrange'. Otherwise this field is invalid  |
| <b>Start ethernet type</b>           | Start ether type of the range of ether types. This field is invalid if 'ethertypecomp' is 'any'. This field and the next field specify a range of ether types, if 'ethertypecomp' is either 'inrange' or 'exrange'   |
| <b>End ethernet type</b>             | End ether type of the range of ether types. This field and the previous field specify a range of ether types, if 'ethertypecomp' is either 'inrange' or 'exrange'. Otherwise this field is invalid   |
| <b>Start VLAN Id</b>                 | Start VLAN Id of the range of VLAN IDs. Invalid, if the direction of the rule for which this subrule is being created is 'out'. This field is invalid if 'vlanidcomp' is 'any'(7). This field and the vlanidto field specify a range of VLAN Ids, if 'vlanidcomp' is either 'inrange'(8) or'exrange'(9).In VLAN stacking mode this parameter maps to customer VLAN ID. |
| <b>End VLAN Id</b>                   | End VLAN Id of the range of VLAN IDs.Invalid, if the direction of the rule for which this subrule is being created is 'out'. This field and the vlanidfrom field specify a range of VLAN Ids, if 'vlanidcomp' is either 'inrange'(8) or 'exrange'(9). Otherwise, this field is invalid. In VLAN stacking mode this parameter maps to customer VLAN ID.                 |
| <b>Start priority tag</b>            | Start priority tag of the range of priority tags. Invalid, if the direction  |

|  |   |
|--|---|
|  | of the rule for which this subrule is being created is 'out'. This field is invalid if 'priotagcmp' is 'any'(7). This field and the priotagto field specify a range of priority tags, if 'priotagcmp' is either 'inrange'(8) or 'exrange'(9).In VLAN stacking mode this parameter maps to priority in the customer VLAN tag.  |
| <b>End priority tag</b>                | End priority tag of the range of priority tags. Invalid, if the direction of the rule for which this subrule is being created is 'out'. This field and the priotagfrom field specify a range of priority tags, if 'priotagcmp' is either 'inrange'(8) or 'exrange'(9). Otherwise this field is invalid. In VLAN stacking mode this parameter maps to priority in the customer VLAN tag. |
| <b>Start DSAP</b>                      | Start DSAP of the range of DSAPs. This object is invalid if 'dsapcmp' is 'any'. This object and the next object specify a range of DSAPs, if 'dsapcmp' is either 'inrange' or 'exrange'   |
| <b>End DSAP</b>                        | End DSAP of the range of DSAPs. This object is invalid if 'dsapcmp' is 'any'. This object and the previous object specify a range of DSAPs, if 'dsapcmp' is either 'inrange' or 'exrange'. Otherwise this field is invalid.   |
| <b>Start SSAP</b>                      | Start SSAP of the range of SSAPs. This object is invalid if 'ssapcmp' is 'any'. This object and the next object specify a range of SSAPs, if 'ssapcmp' is either 'inrange' or 'exrange'   |
| <b>End SSAP</b>                        | End SSAP of the range of SSAPs. This object is invalid if 'ssapcmp' is 'any'. This object and the previous object specify a range of SSAPs, if 'ssapcmp' is either 'inrange' or 'exrange'. Otherwise this field is invalid  |
| <b>Source MAC addresses comparison</b> | Source mac address comparison type  |
| <b>Desination MAC addr comparison</b>  | Destination mac address comparison type   |
| <b>Ether type comparison</b>           | Ether type comparison type  |
| <b>Vlan Id comparison</b>              | VLAN Id comparison type. This field must be 'any', if 'priotagcmp' is not equal to 'any'  |
| <b>Priority tag comparison</b>         | Priority tag comparison type. This field must be 'any', if 'vlanidcmp' is not equal to 'any'"   |
| <b>DSAP comparison</b>                 | DSAP comparison type.   |
| <b>SSAP comparison</b>                 | SSAP comparison type.   |
| <b>Subrule Priority</b>                | This specifies the priority of the subrule. Based on this priority value, the subrule is created in fast or slow memory. In case priority is specified as 'asinrule', subrule priority will be same as specified in the rule.   |



|  |   |
|--|---|
| <b>Start service VLAN Id</b>           | Start service VLAN Id of the range of service VLAN IDs. Invalid, if the direction of the rule for which this subrule is being created is 'out'. This field is invalid if 'vlanidcmp' is 'any'(7). This field and the servicevlanidto field specify a range of service VLAN Ids, if 'servicevlanidcmp' is either 'inrange'(8) or 'exrange'(9).In native mode configuring this parameter will result in error.                  |
| <b>End service VLAN Id</b>             | End service VLAN Id of the range of service VLAN IDs.Invalid, if the direction of the rule for which this subrule is being created is 'out'. This field and the servicevlanidfrom field specify a range of service VLAN Ids, if 'servicevlanidcmp' is either 'inrange'(8) or 'exrange'(9).Otherwise, this field is invalid In native mode configuring this parameter will result in error.                                    |
| <b>Start service priority tag</b>      | Start service priority tag of the range of priority tags. Invalid, if the direction of the rule for which this subrule is being created is 'out'. This field is invalid if 'etherhPrioTagCmpType' is 'any'(7). This field and the etherPriorityTagTo field specify a range of priority tags, if 'etherhPrioTagCmpType' is either 'inrange'(8) or 'exrange'(9).In native mode configuring this parameter will result in error. |
| <b>End service priority tag</b>        | End service priority tag of the range of priority tags. Invalid, if the direction of the rule for which this subrule is being created is 'out'. This field and the etherhPriorityTagFrom field specify a range of service priority tags, if 'etherhServicePrioTagCmpType' is either 'inrange'(8) or 'exrange'(9). Otherwise this field is invalid. In native mode configuring this parameter will result in error.            |
| <b>service Vlan Id comparison</b>      | Service VLAN Id comparison type. This field must be 'any(7)', if etherhPrioTagCmpType is not equal to 'any(7)'.In native mode configuring this parameter will result in error.  |
| <b>Service Priority tag comparison</b> | Service Priority tag comparison type.This field must be 'any(7)', if vlanidcmp is not equal to 'any(7)'.In native mode configuring this parameter will result in error.   |

## References:

- Generic filter commands

## 5.13.29 Filter subrule generic Commands

### 5.13.29.1 Get Filter subrule generic

**Description:**

Use this command to get.

**Command Syntax:**

```
get filter subrule generic [ruleid <ruleid-val>] [subruleid <subruleid-val >]
```

### 5.13.29.2 Create filter subrule generic

**Description:**

Use this command to create.

**Command Syntax:**

```
create filter subrule generic ruleid <ruleid-val> subruleid <subruleid-val>  
[ offsethdr <Ethernet-val> | ip | tcp | udp | icmp | igmp | l3Hdr | ppp | pppoe ]  
[ offset <offset-val> ] [ mask <mask-val> ] [ valuefrom <valuefrom-val> ] [ valueto  
<valueto-val> ] [ gencmp eq | neq | lt | leq | gt | geq | any | inrange | exrange |  
ingenlist | notingenlist | innamedlist | notinnamedlist ] [ subruleprio low | high |  
asinrule ] [ namedlistid <namedlistid-val> ] [ transporthdr ethernet | pppoe ]
```

### 5.13.29.3 Delete filter subrule generic

**Description:**

Use this command to delete.

**Command Syntax:**

```
delete filter subrule generic ruleid <ruleid-val>subruleid <subruleid-val>
```

### 5.13.29.4 Modify filter subrule generic

**Description:**

Use this command to modify.

**Command Syntax:**

```
modify filter subrule generic ruleid <ruleid-val> subruleid <subruleid-val>  
[ offsethdr <Ethernet-val> | ip | tcp | udp | icmp | igmp | l3Hdr | ppp | pppoe ]  
[ offset <offset-val> ] [ mask <mask-val> ] [ valuefrom <valuefrom-val> ] [ valueto  
<valueto-val> ] [ gencmp eq | neq | lt | leq | gt | geq | any | inrange | exrange |  
ingenlist | notingenlist | innamedlist | notinnamedlist ] [ subruleprio low | high |  
asinrule ] [ namedlistid <namedlistid-val> ] [ transporthdr ethernet | pppoe ]
```

## Parameter:

| Name   | Description   |
|--|---|
| <b>ruleid</b> <ruleid-val>   | <p>Unique identifier of a filter rule of which this sub rule is being created</p> <p><b>Type:</b> Create – Mandatory<br/>Delete – Mandatory<br/>Modify – Mandatory<br/>Get – Optional</p> <p><b>Valid values:</b> 1 - 65535</p>   |
| <b>subruleid</b><br><subruleid-val>  | <p>Unique identifier of a filter subrule.</p> <p><b>Type:</b> Create -- Mandatory<br/>Delete -- Mandatory<br/>Modify -- Mandatory<br/>Get -- Optional</p> <p><b>Valid values:</b> 1 - 4294967295</p>  |
| <b>offsethdr</b> ethernet   ip  <br>tcp   udp   icmp   igmp  <br>l3Hdr   ppp   pppoe | <p>Type of offset header from where 'offset' to be measured. The value 'ethernet' is invalid if the rule for which this subrule is being created is of direction 'out'.</p> <p><b>Type:</b> Create -- Optional<br/>Modify -- Optional</p> <p><b>Default value:</b> ethernet</p>   |
| <b>offset</b> <offset-val>   | <p>Offset value to be added to 'offsethdr' to get the field value</p> <p><b>Type:</b> Create -- Optional<br/>Modify -- Optional</p> <p><b>Valid values:</b> 0 - 64</p> <p><b>Default value:</b> 0</p>   |
| <b>mask</b> <mask-val>   | <p>Mask to be applied to the contents of a packet at 'offset'</p> <p><b>Type:</b> Create -- Optional<br/>Modify -- Optional</p> <p><b>Valid values:</b> 1 - 0xffffffff</p> <p><b>Default value:</b> 0xffffffff</p>  |
| <b>valuefrom</b><br><valuefrom-val>  | <p>Start generic value of the range of generic values. This field is invalid if 'gencomp' is 'any', 'ingenlist' or 'notinngenlist', 'innamedlist', or 'notinnamedlist'. This field and next field specify a range of generic values, if 'gencomp' is either 'inrange' or 'exrange'</p> <p><b>Type:</b> Create -- Optional<br/>Modify -- Optional</p> <p><b>Default value:</b> 0</p> |

|   |  |
|---|--|
| <b>valueto</b> <valueto-val>  | <p>End generic value of the range of generic values. This field and the previous field specify a range of generic values, if 'gencomp' is either 'inrange' or 'exrange'. Otherwise this field is invalid</p> <p><b>Type:</b> Create -- Optional<br/>Modify -- Optional</p> <p><b>Default value:</b> 0xffffffff</p>   |
| <b>gencomp</b> eq   neq   lt   leq   gt   geq   any   inrange   exrange   ingenlist   notingenlist   innamedlist   notinnamedlist | <p>Generic value comparison type.</p> <p><b>Type:</b> Create -- Optional<br/>Modify -- Optional</p> <p><b>Default value:</b> any</p>   |
| <b>subruleprio</b> low   high   asinrule  | <p>This specifies the priority of the subrule. Based on this priority value, the subrule is created in fast or slow memory. In case priority is specified as 'asinrule', subrule priority will be same as specified in the rule.</p> <p><b>Type:</b> Create -- Optional<br/>Modify -- Optional</p> <p><b>Default value:</b> asinrule</p>   |
| <b>namedlistid</b> <namedlistid-val>  | <p>This specifies the list identifier value of the named list which will be used to do the lookup. In case 'gencomp' is 'innamedlist' or 'notinnamedlist', this field is mandatory else it is extra.</p> <p><b>Type:</b> Create -- Optional<br/>Modify -- Optional</p> <p><b>Valid values:</b> 1 - 65535</p> <p><b>Default value:</b> 1</p>  |
| <b>transporthdr</b> ethernet   pppoe  | <p>This specifies the type of Transport header in the packet in which corresponding IP is being transported. If value of this field is 'ethernet', then IP is being carried in ethernet header and if it is 'pppoe' then corresponding IP is being carried in PPP header. This field is valid only when value of 'offsethdr' is any one of ip, tcp, udp, icmp or igmp. Otherwise this field is extra</p> <p><b>Type:</b> Create -- Optional<br/>Modify -- Optional</p> <p><b>Default value:</b> ethernet</p> |

### Example:

```
$ create filter subrule generic ruleid 1 subruleid 2 offsethdr tcp offset 20 mask 0xFF
valuefrom 0x20 valueto 0x40 gencomp inrange subruleprio high namedlistid -
transporthdr Ethernet
```

**Output:**

Verbose Mode On

Entry Created

```

Rule Id           : 1           Subrule Id  : 2
Offset header     : tcp         Offset      : 20
Generic header comparison : inrange Mask         : 0xFF
Subrule Priority  : high        Start value : 0x20
End value         : 0x40
Transport Header  : ethernet
NamedList Id     : -

```

Verbose Mode Off:

Entry Created

**Output field:**

| Field                            | Description   |
|----------------------------------|---|
| <b>Rule Id</b>                   | Unique identifier of a filter rule for which this sub rule is being created.  |
| <b>Subrule Id</b>                | Unique identifier of a filter subrule.  |
| <b>Offset header</b>             | Type of offset header from where 'offset' to be measured. The value 'ethernet' is invalid if the rule for which this subrule is being created is of direction 'out'.  |
| <b>Offset</b>                    | Offset value to be added to 'offsethdr' to get the field value  |
| <b>Generic header comparison</b> | Generic value comparison type.  |
| <b>Mask</b>                      | Mask to be applied to the contents of a packet at 'offset'  |
| <b>Subrule Priority</b>          | This specifies the priority of the subrule. Based on this priority value, the subrule is created in fast or slow memory. In case priority is specified as 'asinrule', subrule priority will be same as specified in the rule.   |
| <b>Start value</b>               | Start generic value of the range of generic values. This field is invalid if 'gencmp' is 'any', 'ingenlist' or 'notinngenlist', 'innamedlist', or 'notinnamedlist'. This field and next field specify a range of generic values, if 'gencmp' is either 'inrange' or 'exrange' |
| <b>End value</b>                 | End generic value of the range of generic values. This field and the previous field specify a range of generic values, if 'gencmp' is either 'inrange' or 'exrange'. Otherwise this field is invalid  |
| <b>Transport Header</b>          | This specifies the type of Transport header in the packet in  |

|                     |  |
|---------------------|--|
|                     | which corresponding IP is being transported. If value of this field is 'ethernet', then IP is being carried in ethernet header and if it is 'pppoe' then corresponding IP is being carried in PPP header. This field is valid only when value of 'offsethdr' is any one of ip, tcp, udp, icmp or igmp. Otherwise this field is extra |
| <b>NamedList Id</b> | This specifies the list identifier value of the named list which will be used to do the lookup .In case 'genicmp' is 'innamedlist' or 'notinnamedlist', this field is mandatory else it is extra.  |

#### References:

- Generic filter commands

### 5.13.30 Filter subrule ICMP Commands

#### 5.13.30.1 Get Filter subrule icmp

##### Description:

Use this command to get.

##### Command Syntax:

**get filter subrule icmp** [ruleid <ruleid-val>] [subruleid <subruleid-val>]

#### 5.13.30.2 Create filter subrule icmp

##### Description:

Use this command to create.

##### Command Syntax:

**create filter subrule icmp ruleid** <ruleid-val> **subruleid** <subruleid-val>  
 [ **icmptype**<icmptype-val> ] [ **icmpcode** <icmpcode-val> ] [ **icmptypecmp** eq |  
 neq | any ] [ **icmpcodecmp** eq | neq | any ] [ **subruleprio** low | high | asinrule]  
 [ **transporthdr** ethernet | pppoe ]

#### 5.13.30.3 Delete filter subrule icmp

##### Description:

Use this command to delete.

##### Command Syntax:

**delete filter subrule icmp ruleid** <ruleid-val> **subruleid** <subruleid-val>

### 5.13.30.4 Modify filter subrule icmp

#### Description:

Use this command to modify.

#### Command Syntax:

```
modify filter subrule icmp ruleid <ruleid-val> subruleid <subruleid-val>
[ icmptype<icmp-type-val> ] [ icmpcode <icmpcode-val> ] [ icmptypecmp eq |
neq | any ] [ icmpcodecmp eq | neq | any ] [ subruleprio low | high | asinrule]
[ transporthdr ethernet | pppoe ]
```

#### Parameter:

| Name                                | Description   |
|-------------------------------------|---|
| <b>ruleid</b> <ruleid-val>          | Unique identifier of a filter rule of which this sub rule is being created<br><br><b>Type:</b> Create -- Mandatory<br>Delete -- Mandatory<br>Modify -- Mandatory<br>Get -- Optional<br><br><b>Valid values:</b> 1 - 65535 |
| <b>subruleid</b><br><subruleid-val> | Unique identifier of a filter subrule<br><br><b>Type:</b> Create -- Mandatory<br>Delete -- Mandatory<br>Modify -- Mandatory<br>Get -- Optional<br><br><b>Valid values:</b> 1 - 4294967295                                 |
| <b>icmptype</b><br><icmp-type-val>  | ICMP type<br><br><b>Type:</b> Create -- Optional<br>Modify -- Optional<br><br><b>Default value:</b> 0   |
| <b>icmpcode</b><br><icmpcode-val>   | ICMP code<br><br><b>Type:</b> Create -- Optional<br>Modify -- Optional<br><br><b>Default value:</b> 0   |
| <b>icmptypecmp</b> eq   neq   any   | ICMP type comparison type<br><br><b>Type:</b> Create -- Optional<br>Modify -- Optional<br><br><b>Default value:</b> any   |

|   |   |
|---|---|
| <b>icmpcodecmp</b> eq   neq<br>  any        | ICMP code comparison type<br><br><b>Type:</b> Create -- Optional<br>Modify -- Optional<br><br><b>Default value:</b> any   |
| <b>subruleprio</b> low   high  <br>asinrule | This specifies the priority of the subrule. Based on this priority value, the subrule is created in fast or slow memory. In case priority is specified as 'asinrule', subrule priority will be same as specified in the rule.<br><br><b>Type:</b> Create -- Optional<br>Modify -- Optional<br><br><b>Default value:</b> asinrule  |
| <b>transporthdr</b> ethernet  <br>pppoe     | This specifies the type of the transport header in the packet in which the corresponding IP is being transported. If the value of this field is ethernet, then the IP is being carried in the ethernet header. If it is 'pppoe', then the corresponding IP is being carried in the PPP header.<br><br><b>Type:</b> Create -- Optional<br>Modify -- Optional<br><br><b>Default value:</b> ethernet |

**Example:**

```
$ create filter subrule icmp ruleid 1 subruleid 2 icmptype 0 icmpcode 0
icmpypecmp neq icmpcodecmp neq subruleprio high
```

**Output:**

Verbose Mode On  
Entry Created

```
Rule Id           : 1           Subrule Id        : 2
Icmp type         : 0           Icmp code         : 0
ICMP type comparison : neq       ICMP code comparison : neq
Subrule Priority   : high
Transport Header   : Ethernet
```

Verbose Mode Off:  
Entry Created



## Output field:

| Field                | Description  |
|----------------------|--|
| Rule Id              | Unique identifier of a filter rule of which this sub rule is being created   |
| Subrule Id           | Unique identifier of a filter subrule  |
| Icmp type            | ICMP type  |
| Icmp code            | ICMP code  |
| ICMP type comparison | ICMP type comparison type  |
| ICMP code comparison | ICMP code comparison type  |
| Subrule Priority     | This specifies the priority of the subrule. Based on this priority value, the subrule is created in fast or slow memory. In case priority is specified as 'asinrule', subrule priority will be same as specified in the rule.  |
| Transport Header     | This specifies the type of the transport header in the packet in which the corresponding IP is being transported. If the value of this field is ethernet, then the IP is being carried in the ethernet header. If it is 'pppoe', then the corresponding IP is being carried in the PPP header. |

## References:

- Generic Filter commands

## 5.13.31 Filter subrule IGMP Commands

### 5.13.31.1 Get Filter subrule igmp

#### Description:

Use this command to get.

#### Command Syntax:

```
get filter subrule igmp [ruleid <ruleid-val>] [subruleid <subruleid-val>]
```

### 5.13.31.2 Create filter subrule igmp

#### Description:

Use this command to create.

**Command Syntax:**

```
create filter subrule igmp ruleid <ruleid-val>subruleid <subruleid-val>
[ igmptype <igmptype-val> ] [ igmpcode <igmpcode-val> ] [ groupaddrfrom
<groupaddrfrom-val> ] [ groupaddrto <groupaddrto-val> ] [ igmptypescmp eq |
neq | any ] [ igmpcodescmp eq | neq | any ] [ igmpgroupaddrcmp eq | neq | lt | leq
| gt | geq | any | inrange | exrange ] [ subruleprio low | high | asinrule]
[ transporthdr ethernet | pppoe ]
```

**5.13.31.3 Delete filter subrule igmp****Description:**

Use this command to delete.

**Command Syntax:**

```
get filter subrule igmp ruleid <ruleid-val>subruleid <subruleid-val>
```

**5.13.31.4 Modify filter subrule igmp****Description:**

Use this command to modify.

**Command Syntax:**

```
modify filter subrule igmp ruleid <ruleid-val>subruleid <subruleid-val>
[ igmptype <igmptype-val> ] [ igmpcode <igmpcode-val> ] [ groupaddrfrom
<groupaddrfrom-val> ] [ groupaddrto <groupaddrto-val> ] [ igmptypescmp eq |
neq | any ] [ igmpcodescmp eq | neq | any ] [ igmpgroupaddrcmp eq | neq | lt | leq
| gt | geq | any | inrange | exrange ] [ subruleprio low | high | asinrule]
[ transporthdr ethernet | pppoe ]
```

**Parameter:**

| Name                       | Description   |
|----------------------------|---|
| <b>ruleid</b> <ruleid-val> | <p>Unique identifier of a filter rule of which this sub rule is being created</p> <p><b>Type:</b> Create -- Mandatory<br/>Delete -- Mandatory<br/>Modify -- Mandatory<br/>Get -- Optional</p> <p><b>Valid values:</b> 1 - 65535</p> |

|   |  |
|---|--|
| <b>subruleid</b><br><subruleid-val>   | Unique identifier of a filter subrule<br><b>Type:</b> Create -- Mandatory<br>Delete -- Mandatory<br>Modify -- Mandatory<br>Get -- Optional<br><b>Valid values:</b> 1 - 4294967295  |
| <b>igmptype</b><br><igmptype-val>   | IGMP type<br><b>Type:</b> Create -- Optional<br>Modify -- Optional<br><b>Default value:</b> 0  |
| <b>igmpcode</b><br><igmpcode-val>   | This fields specifies the Max Response Code (time) fields of IGMP packet. This field is invalid if igmphCodeCmpType is any.<br><b>Type:</b> Create -- Optional<br>Modify -- Optional<br><b>Default value:</b> 0  |
| <b>groupaddrfrom</b><br><groupaddrfrom-val>   | Start group address of the range of igmp group addresses. This field is invalid if 'igmpgroupaddrcmp' is 'any'. This field and 'groupaddrto' specify a range of IGMP group addresses, if 'igmpgroupaddrcmp' is either 'inrange' or 'exrange'<br><b>Type:</b> Create -- Optional<br>Modify -- Optional<br><b>Default value:</b> 0 |
| <b>groupaddrto</b><br><groupaddrto-val>   | End group address of the range of igmp group addresses. This field and 'groupaddrfrom' specify a range of IGMP group addresses, if 'igmpgroupaddrcmp' is either 'inrange' or 'exrange'<br><b>Type:</b> Create -- Optional<br>Modify -- Optional<br><b>Default value:</b> 4294967295  |
| <b>igmptpecmp</b> eq   neq<br>  any   | IGMP type comparison type<br><b>Type:</b> Create -- Optional<br>Modify -- Optional<br><b>Default value:</b> any  |
| <b>igmpcodecmp</b> eq   neq<br>  any  | IGMP code comparison type<br><b>Type:</b> Create -- Optional<br>Modify -- Optional<br><b>Default value:</b> any  |
| <b>igmpgroupaddrcmp</b><br>eq   neq   lt   leq   gt  <br>geq   any   inrange  <br>exrange | IGMP group address comparison type<br><b>Type:</b> Create -- Optional<br>Modify -- Optional<br><b>Default value:</b> any   |

|   |   |
|---|---|
| <b>subruleprio</b> low   high  <br>asinrule | This specifies the priority of the subrule. Based on this priority value, the subrule is created in fast or slow memory. In case priority is specified as 'asinrule', subrule priority will be same as specified in the rule.<br><br><b>Type:</b> Create -- Optional<br>Modify -- Optional<br><br><b>Default value:</b> asinrule  |
| <b>transporthdr</b> ethernet  <br>pppoe     | This specifies the type of the transport header in the packet in which the corresponding IP is being transported. If the value of this field is Ethernet(0x1), then the IP is being carried in the ethernet header. If it is pppoe(0x2), then the corresponding IP is being carried in the PPP header.<br><br><b>Type:</b> Create -- Optional<br>Modify -- Optional<br><br><b>Default value:</b> ethernet |

**Example:**

```
$ create filter subrule igmp ruleid 1 subruleid 2 igmptype 0 igmpcode 0 groupaddr
from 224.0.2.3 groupaddrto 224.10.20.30 igmptypcmp eq igmpcodecmp eq
igmpgroupaddrcmp inrange subruleprio high
```

**Output:**

Verbose Mode On

Entry Created

```
Rule Id                : 1                Subrule Id            : 2
Igmp type              : 0                IGMP type comparison : neq
Igmp code              : 0                IGMP code comparison : neq
Start group address    : 224.0.2.3        End group address     :
224.10.20.30
IGMP group address comparison : inrange    Subrule Priority      : high
Transport Header      : Ethernet
```

Verbose Mode Off:

Entry Created

**Output field:**

| Field             | Description  |
|-------------------|--|
| <b>Rule Id</b>    | Unique identifier of a filter rule of which this sub rule is being created |
| <b>Subrule Id</b> | Unique identifier of a filter subrule                                      |
| <b>Igmp type</b>  | IGMP type  |

|                                      |  |
|--------------------------------------|--|
| <b>IGMP type comparison</b>          | IGMP type comparison type  |
| <b>Igmp code</b>                     | This field specifies the Max Response Code (time) fields of IGMP packet. This field is invalid if igmphCodeCmpType is any.   |
| <b>IGMP code comparison</b>          | IGMP code comparison type  |
| <b>Start group address</b>           | Start group address of the range of igmp group addresses. This field is invalid if 'igmpgroupaddrcmp' is 'any'. This field and 'groupaddrto' specify a range of IGMP group addresses, if 'igmpgroupaddrcmp' is either 'inrange' or 'exrange'   |
| <b>End group address</b>             | End group address of the range of igmp group addresses. This field and 'groupaddrfrom' specify a range of IGMP group addresses, if 'igmpgroupaddrcmp' is either 'inrange' or 'exrange'   |
| <b>IGMP group address comparison</b> | IGMP group address comparison type   |
| <b>Subrule Priority</b>              | This specifies the priority of the subrule. Based on this priority value, the subrule is created in fast or slow memory. In case priority is specified as 'asinrule', subrule priority will be same as specified in the rule.  |
| <b>Transport Header</b>              | This specifies the type of the transport header in the packet in which the corresponding IP is being transported. If the value of this field is Ethernet(0x1), then the IP is being carried in the ethernet header. If it is pppoe(0x2), then the corresponding IP is being carried in the PPP header. |

#### References:

- Generic Filter commands

### 5.13.32 Filter subrule IP Commands

#### 5.13.32.1 Get Filter subrule ip

##### Description:

Use this command to get.

##### Command Syntax:

**get filter subrule ip [ruleid <ruleid-val>] [subruleid <subruleid-val >]**

### 5.13.32.2 Create filter subrule ip

#### Description:

Use this command to create.

#### Command Syntax:

```
create filter subrule ip ruleid <ruleid-val > subruleid <subruleid-val >  
[ srcipaddrfrom <srcipaddrfrom-val > ] [ srcipaddrto <srcipaddrto-val > ]  
[ dstipaddrfrom <dstipaddrfrom-val > ] [ dstipaddrto <dstipaddrto-val > ]  
[ prototypefrom <prototypefrom-val > ] [ prototypeto <prototypeto-val > ]  
[ srcaddrcmp eq | neq | lt | leq | gt | geq | any | inrange | exrange | ingenlist |  
notingenlist ] [ dstaddrcmp eq | neq | lt | leq | gt | geq | any | inrange | exrange  
| ingenlist | notingenlist ] [ prototypecmp eq | neq | lt | leq | gt | geq | any |  
inrange | exrange ] [ ipsrcaddrmask <ipsrcaddrmask-val> ] [ ipdstaddrmask  
<ipdstaddrmask-val> ] [ subruleprio low | high | asinrule ] [ transporthdr  
ethernet | pppoe ] [ tosfrom <tosfrom-val> ] [ tosto <tosto-val> ] [ tosmask  
<tosmask-val> ] [ toscmp eq | neq | lt | leq | gt | geq | any | inrange | exrange ]
```

### 5.13.32.3 Delete filter subrule ip

#### Description:

Use this command to delete.

#### Command Syntax:

```
delete filter subrule ip ruleid <ruleid-val > subruleid <subruleid-val >
```

### 5.13.32.4 Modify filter subrule ip

#### Description:

Use this command to modify.

#### Command Syntax:

```
modify filter subrule ip ruleid <ruleid-val > subruleid <subruleid-val >  
[ srcipaddrfrom <srcipaddrfrom-val > ] [ srcipaddrto <srcipaddrto-val > ]  
[ dstipaddrfrom <dstipaddrfrom-val > ] [ dstipaddrto <dstipaddrto-val > ]  
[ prototypefrom <prototypefrom-val > ] [ prototypeto <prototypeto-val > ]  
[ srcaddrcmp eq | neq | lt | leq | gt | geq | any | inrange | exrange | ingenlist |  
notingenlist ] [ dstaddrcmp eq | neq | lt | leq | gt | geq | any | inrange | exrange  
| ingenlist | notingenlist ] [ prototypecmp eq | neq | lt | leq | gt | geq | any |  
inrange | exrange ] [ ipsrcaddrmask <ipsrcaddrmask-val> ] [ ipdstaddrmask  
<ipdstaddrmask-val> ] [ subruleprio low | high | asinrule ] [ transporthdr
```

**ethernet | pppoe ] [ tosfrom <tosfrom-val> ] [ tosto <tossto-val> ] [ tosmask <tosmask-val> ] [ toscmp eq | neq | lt | leq | gt | geq | any | inrange | exrange ]**

**Parameter:**

| Name                                     | Description   |
|--|---|
| <b>ruleid</b> <ruleid-val>               | <p>Unique identifier of a filter rule of which this sub rule is being created.</p> <p><b>Type:</b> Create – Mandatory<br/>Delete – Mandatory<br/>Modify – Mandatory<br/>Get – Optional</p> <p><b>Valid values:</b> 1 - 65535</p>  |
| <b>subruleid</b> <subruleid-val>         | <p>Unique identifier of a filter subrule.</p> <p><b>Type:</b> Create – Mandatory<br/>Delete – Mandatory<br/>Modify – Mandatory<br/>Get – Optional</p> <p><b>Valid values:</b> 1 - 4294967295</p>  |
| <b>srcipaddrfrom</b> <srcipaddrfrom-val> | <p>Start source IP address of the range of source IP addresses. This field is invalid if 'srcaddrcomp' is 'any', 'ingenlist' or 'notingenlist'. This field and 'srcipaddrto' specify a range of source IP addresses if 'srcaddrcomp' is either 'inrange' or 'exrange'.</p> <p><b>Type:</b> Create – Optional<br/>Modify – Optional</p> <p><b>Default value:</b> 0.0.0.0</p>                 |
| <b>srcipaddrto</b> <srcipaddrto-val>     | <p>End source IP address of the range of source IP addresses. This field and 'srcipaddrfrom' specify a range of source IP addresses, if 'srcaddrcomp' is either 'inrange' or 'exrange'. Otherwise this field is invalid.</p> <p><b>Type:</b> Create – Optional<br/>Modify – Optional</p> <p><b>Default value:</b> 255.255.255.255</p>   |
| <b>dstipaddrfrom</b> <dstipaddrfrom-val> | <p>Start destination IP address of the range of destination IP addresses. This field is invalid if 'dstaddrcomp' is 'any', 'ingenlist' or 'notingenlist'. This field and 'dstipaddrto' specify a range of destination IP addresses, if 'dstaddrcomp' is either 'inrange' or 'exrange'.</p> <p><b>Type:</b> Create – Optional<br/>Modify – Optional</p> <p><b>Default value:</b> 0.0.0.0</p> |

|   |  |
|---|--|
| <b>dstipaddrto</b><br><dstipaddrto-val>   | End destination IP address of the range of destination IP addresses. This field and 'dstipaddrfrom' specify a range of destination IP addresses, if 'dstaddrcmp' is either 'inrange' or 'exrange'. Otherwise this field is invalid<br><b>Type:</b> Create — Optional<br>Modify — Optional<br><b>Default value:</b> 255.255.255.255   |
| <b>prototypefrom</b><br><prototypefrom-val>   | Start IP protocol type of the range of IP protocol types. This field is invalid if 'prototypecmp' is 'any'. This field and 'prototypeto' specify a range of IP protocol types, if 'prototypecmp' is either 'inrange' or 'exrange'.<br><b>Type:</b> Create — Optional<br>Modify — Optional<br><b>Default value:</b> 0   |
| <b>prototypeto</b><br><prototypeto-val>   | End IP protocol type of the range of IP protocol types. This field and 'prototypefrom' specify a range of IP protocol types, if 'prototypecmp' is either 'inrange' or 'exrange'. Otherwise this field is invalid.<br><b>Type:</b> Create — Optional<br>Modify — Optional<br><b>Default value:</b> 27   |
| <b>srcaddrcmp eq   neq   lt   leq   gt   geq   any   inrange   exrange   ingenlist   notingenlist</b> | Source IP address comparison type. 'ingenlist' means check if source ip address present in interface classifier generic list. 'notingenlist' means check if source ip address not present in interface classifier generic list. 'ingenlist' and 'notingenlist' are invalid if the direction of the rule for which this subrule is being created is 'out'<br><b>Type:</b> Create — Optional<br>Modify — Optional<br><b>Default value:</b> any                 |
| <b>dstaddrcmp eq   neq   lt   leq   gt   geq   any   inrange   exrange   ingenlist   notingenlist</b> | Destination IP address comparison type. 'ingenlist' means check if destination ip address present in interface classifier generic list. 'notingenlist' means check if destination ip address not present in interface classifier generic list. 'ingenlist' and 'notingenlist' are invalid if the direction of the rule for which this subrule is being created is 'out'.<br><b>Type:</b> Create — Optional<br>Modify — Optional<br><b>Default value:</b> any |
| <b>prototypecmp eq   neq   lt   leq   gt   geq   any</b>  | IP Protocol type comparison type.<br><b>Type:</b> Create — Optional  |



|   |  |
|---|--|
| <b> inrange   exrange</b>                         | <p>Modify — Optional</p> <p><b>Default value:</b> any</p>  |
| <b>ipsrcaddrmask</b><br><ipsrcaddrmask-val>       | <p>The mask value for source ip address. The mask is applied over the source ip address before checking against a value.</p> <p><b>Type:</b> Create — Optional<br/>         Modify — Optional</p> <p><b>Valid values:</b> 1 - 0xffffffff</p> <p><b>Default value:</b> 0xffffffff</p>   |
| <b>ipdstaddrmask</b><br><ipdstaddrmask-val>       | <p>The mask value for destination ip address. The mask is applied over the destination ip address before checking against a value.</p> <p><b>Type:</b> Create — Optional<br/>         Modify — Optional</p> <p><b>Valid values:</b> 1 - 0xffffffff</p> <p><b>Default value:</b> 0xffffffff</p>   |
| <b>subruleprio low   high</b><br><b> asinrule</b> | <p>This specifies the priority of the subrule. Based on this priority value, the subrule is created in fast or slow memory. In case priority is specified as asinrule, subrule priority will be same as specified in the rule.</p> <p><b>Type:</b> Create — Optional<br/>         Modify — Optional</p> <p><b>Default value:</b> asinrule</p>                    |
| <b>transporthdr ethernet  </b><br><b>pppoe</b>    | <p>This specifies the type of Transport header in the packet in which IP is being transported. If value of this field is ethernet (1), then IP is being carried in ethernet header and if it is pppoe (2) then IP is being carried in PPP header.</p> <p><b>Type:</b> Create — Optional<br/>         Modify — Optional</p> <p><b>Default value:</b> ethernet</p> |
| <b>tosfrom &lt;tosfrom-val&gt;</b>                | <p>Start TOS value of the range of TOS values. This field is invalid if 'TosCmpType' is 'any'(7). This field and TosTo field specify a range of TOS values, if 'TosCmpType' is either 'inrange'(8) or 'exrange'(9). <b>Type:</b> Create — Optional<br/>         Modify — Optional</p> <p><b>Valid values:</b> 0 - 0xff</p> <p><b>Default value:</b> 0</p>        |
| <b>tosto &lt;tosto-val&gt;</b>                    | <p>End TOS value of the range of TOS values. This field is invalid if 'toscmp' is 'any'. This field and 'tosfrom' field specify a range of TOS values, if 'toscmp' is either 'inrange' or 'exrange'.</p> <p><b>Type:</b> Create — Optional<br/>         Modify — Optional</p>  |

|  |   |
|--|---|
|  | <b>Valid values:</b> 0 - 0xff<br><b>Default value:</b> 0xff   |
| <b>tosmask</b><br><tosmask-val>  | The mask value for TOS field. The mask is applied over the TOS field value before checking against configured values in 'tosfrom' and 'tosto'.<br><b>Type:</b> Create — Optional<br>Modify — Optional<br><b>Valid values:</b> 0x01 - 0xff<br><b>Default value:</b> 0xff |
| <b>toscmp eq   neq   lt   leq   gt   geq   any   inrange   exrange</b> | TOS comparison type.<br><b>Type:</b> Create — Optional<br>Modify — Optional<br><b>Default value:</b> any  |

### Example:

```
$ create filter subrule ip ruleid 1 subruleid 2 srcipaddrfrom 172.25.1.125
srcipaddrto 172.25.5.125 dstipaddrfrom 172.25.6.125 dstipaddrto 172.25.10.125
prototypefrom 1 prototypeto 6 srcaddrcmp inrange dstaddrcmp inrange
prototypecmp inrange ipsrcaddrmask 0xffffffff ipdstaddrmask 0xffffffff subruleprio
high transportHdr ethernet tosfrom 0x01 tosto 0x06 tosmask 0xff toscmp inrange
```

### Output:

```
Verbose Mode On
Entry Created
```

```
Rule Id          : 1          Subrule Id       : 2
Start src ip addr : 172.25.1.125  End src ip addr  : 172.25.5.125
Start dest ip addr : 172.25.6.125  End dest ip addr : 172.25.10.125
Start IP prot type : 1          End IP prot type : 6
Start TOS value    : 0x01        End TOS value    : 0x06
Src ip addr comp   : inrange     Dest ip addr comp : inrange
IP prot type comp  : inrange     TOS comp type    : inrange
IP Src Addr Mask   : 0xffffffff  IP Dest Addr Mask : 0xffffffff
Subrule Priority    : high
Transport Header    : ethernet
TOS Mask           : 0xff
Verbose Mode Off:
Entry Created
```

## Output field:

| Field                     | Description  |
|---------------------------|--|
| <b>Rule Id</b>            | Unique identifier of a filter rule of which this sub rule is being created.  |
| <b>Subrule Id</b>         | Unique identifier of a filter subrule.   |
| <b>End src ip addr</b>    | End source IP address of the range of source IP addresses. This field and 'srcipaddrfrom' specify a range of source IP addresses, if 'srcaddrcmp' is either 'inrange' or 'exrange'. Otherwise this field is invalid.   |
| <b>Start dest ip addr</b> | Start destination IP address of the range of destination IP addresses. This field is invalid if 'dstaddrcmp' is 'any', 'ingenlist' or 'notingenlist'. This field and 'dstipaddrto' specify a range of destination IP addresses, if 'dstaddrcmp' is either 'inrange' or 'exrange'.  |
| <b>End dest ip addr</b>   | End destination IP address of the range of destination IP addresses. This field and 'dstipaddrfrom' specify a range of destination IP addresses, if 'dstaddrcmp' is either 'inrange' or 'exrange'. Otherwise this field is invalid   |
| <b>Start IP prot type</b> | Start IP protocol type of the range of IP protocol types. This field is invalid if 'prototpecmp' is 'any'. This field and 'prototypeto' specify a range of IP protocol types, if 'prototpecmp' is either 'inrange' or 'exrange'.   |
| <b>End IP prot type</b>   | End IP protocol type of the range of IP protocol types. This field and 'prototypefrom' specify a range of IP protocol types, if 'prototpecmp' is either 'inrange' or 'exrange'. Otherwise this field is invalid.   |
| <b>Start TOS value</b>    | Start TOS value of the range of TOS values. This field is invalid if 'TosCmpType' is 'any'(7). This field and TosTo field specify a range of TOS values, if 'TosCmpType' is either 'inrange'(8) or 'exrange'(9).   |
| <b>End TOS value</b>      | End TOS value of the range of TOS values. This field is invalid if 'toscmp' is 'any'. This field and 'tosfrom' field specify a range of TOS values, if 'toscmp' is either 'inrange' or 'exrange'.  |
| <b>Src ip addr comp</b>   | Source IP address comparison type. 'ingenlist' means check if source ip address present in interface classifier generic list. 'notingenlist' means check if source ip address not present in interface classifier generic list. 'ingenlist' and 'notingenlist' are invalid if the direction of the rule for which this subrule is being created is 'out'                 |
| <b>Dest ip addr comp</b>  | Destination IP address comparison type. 'ingenlist' means check if destination ip address present in interface classifier generic list. 'notingenlist' means check if destination ip address not present in interface classifier generic list. 'ingenlist' and 'notingenlist' are invalid if the direction of the rule for which this subrule is being created is 'out'. |
| <b>IP prot type comp</b>  | IP Protocol type comparison type.  |
| <b>TOS comp type</b>      | TOS comparison type.   |
| <b>IP Src Addr Mask</b>   | The mask value for source ip address. The mask is applied over the source ip address before checking against a value.  |

|                          |   |
|--------------------------|---|
| <b>IP Dest Addr Mask</b> | The mask value for destination ip address. The mask is applied over the destination ip address before checking against a value.   |
| <b>Subrule Priority</b>  | This specifies the priority of the subrule. Based on this priority value, the subrule is created in fast or slow memory. In case priority is specified as asinrule, subrule priority will be same as specified in the rule.                         |
| <b>Transport Header</b>  | This specifies the type of Transport header in the packet in which IP is being transported. If value of this field is ethernet (1), then IP is being carried in ethernet header and if it is pppoe (2) then then IP is being carried in PPP header. |
| <b>TOS Mask</b>          | The mask value for TOS field. The mask is applied over the TOS field value before checking against configured values in 'tosfrom' and 'tosto'.  |

#### References:

- Generic filter commands

### 5.13.33 Filter subrule PPP Commands

#### 5.13.33.1 Get Filter subrule ppp

##### Description:

Use this command to get.

##### Command Syntax:

**get filter subrule ppp** [**ruleid** <ruleid-val>] [**subruleid** <subruleid-val>]

#### 5.13.33.2 Create filter subrule ppp

##### Description:

Use this command to create.

##### Command Syntax:

**create filter subrule ppp ruleid** <ruleid-val> **subruleid** <subruleid-val>  
[**prototypefrom** <prototypefrom-val>] [**prototypeto** <prototypeto-val>]  
[**prototypecmp** eq | neq | lt | leq | gt | geq | any | inrange | exrange] [**subruleprio**  
low | high | asinrule]

#### 5.13.33.3 Delete filter subrule ppp

##### Description:

Use this command to delete.

**Command Syntax:**

```
delete filter subrule ppp ruleid <ruleid-val> subruleid <subruleid-val>
```

**5.13.33.4 Modify filter subrule ppp****Description:**

Use this command to modify.

**Command Syntax:**

```
modify filter subrule ppp ruleid <ruleid-val> subruleid <subruleid-val>
[prototypefrom <prototypefrom-val>] [prototypeto <prototypeto-val>]
[prototypecmp eq | neq | lt | leq | gt | geq | any | inrange | exrange] [subruleprio
low | high | asinrule]
```

**Parameter:**

| Name                                     | Description   |
|--|---|
| <b>ruleid</b> <ruleid-val>               | Unique identifier of a filter rule of which this sub rule is being created<br><br><b>Type:</b> Create -- Mandatory<br>Delete -- Mandatory<br>Modify -- Mandatory<br>Get -- Optional<br><br><b>Valid values:</b> 1 - 65535   |
| <b>subruleid</b> <subruleid-val>         | Unique identifier of a filter subrule<br><br><b>Type:</b> Create -- Mandatory<br>Delete -- Mandatory<br>Modify -- Mandatory<br>Get -- Optional<br><br><b>Valid values:</b> 1 - 4294967295   |
| <b>prototypefrom</b> <prototypefrom-val> | Start of range of PPP protocol types. Invalid if 'prototypecmp' is 'any'. This field and the next field specify a range of protocol types, if 'prototypecmp' is either 'inrange' or 'exrange'. Otherwise only this field is valid<br><br><b>Type:</b> Create -- Optional<br>Modify -- Optional<br><br><b>Default value:</b> 0 |

|  |   |
|--|---|
| <b>prototypeto</b><br><prototypeto-val>  | End PPP protocol type of the range of PPP protocol types.<br><br>This field and 'prototypefrom' specify a range of ppp protocol types if 'prototypecmp' is either 'inrange' or 'exrange'<br><br><b>Type:</b> Create -- Optional<br>Modify -- Optional<br><b>Default value:</b> 65535  |
| <b>prototypecmp</b> eq   neq<br>  lt   leq   gt   geq   any  <br>inrange   exrange | Protocol comparison type<br><br><b>Type:</b> Create -- Optional<br>Modify -- Optional<br><b>Default value:</b> any  |
| <b>subruleprio</b> low   high  <br>asinrule  | This specifies the priority of the subrule. Based on this priority value, the subrule is created in fast or slow memory.<br><br>In case priority is specified as 'asinrule', subrule priority will be same as specified in the rule.<br><br><b>Type:</b> Create -- Optional<br>Modify -- Optional<br><b>Default value:</b> asinrule |

### Example:

```
$ create filter subrule ppp ruleid 1 subruleid 2 prototypefrom 0x1 prototypeto 0x5
prototypecmp inrange subruleprio high
```

### Output:

Verbose Mode On

Entry Created

```
Rule Id           : 1           Subrule Id       : 2
Start ProtoType   : 0x1         End ProtoType    : 0x5
Protocol comparison : inrange   Subrule Priority : high
```

Verbose Mode Off:

Entry Created

### Output field:

| Field                  | Description  |
|------------------------|--|
| <b>Rule Id</b>         | Unique identifier of a filter rule of which this sub rule is being created |
| <b>Subrule Id</b>      | Unique identifier of a filter subrule                                      |
| <b>Start ProtoType</b> | Start of range of PPP protocol types. Invalid if 'prototypecmp' is         |

|                            |   |
|----------------------------|---|
|                            | 'any'. This field and the next field specify a range of protocol types, if 'prototpecmp' is either 'inrange' or 'exrange'.<br>Otherwise only this field is valid  |
| <b>End ProtoType</b>       | End PPP protocol type of the range of PPP protocol types.<br>This field and 'prototypefrom' specify a range of ppp protocol types if 'prototpecmp' is either 'inrange' or 'exrange'   |
| <b>Protocol comparison</b> | Protocol comparison type  |
| <b>Subrule Priority</b>    | This specifies the priority of the subrule. Based on this priority value, the subrule is created in fast or slow memory. In case priority is specified as 'asinrule', subrule priority will be same as specified in the rule. |

### References:

- see generic filter related commands

## 5.13.34 Filter subrule TCP Commands

### 5.13.34.1 Get Filter subrule tcp

#### Description:

Use this command to get.

#### Command Syntax:

```
get filter subrule tcp [ruleid <ruleid-val>] [subruleid <subruleid-val>]
```

### 5.13.34.2 Create filter subrule tcp

#### Description:

Use this command to create.

#### Command Syntax:

```
create filter subrule tcp ruleid <ruleid-val> subruleid <subruleid-val>
[ srcportfrom <srcportfrom-val> ] [ srcportto <srcportto-val> ] [ dstportfrom
<dstportfrom-val> ] [ dstportto <dstportto-val> ] [ srcportcmp eq | neq | lt | leq |
gt | geq | any | inrange | exrange ] [ dstportcmp eq | neq | lt | leq | gt | geq | any
| inrange | exrange ] [ subruleprio low | high | asinrule] [ transporthdr ethernet
| pppoe ]
```

### 5.13.34.3 Delete filter subrule tcp

**Description:**

Use this command to delete.

**Command Syntax:**

**delete filter subrule tcp ruleid** <ruleid-val > **subruleid** <subruleid-val >

### 5.13.34.4 Modify filter subrule tcp

**Description:**

Use this command to modify.

**Command Syntax:**

**modify filter subrule tcp ruleid** <ruleid-val > **subruleid** <subruleid-val >  
[ **srcportfrom** <srcportfrom-val > ] [ **srcportto** <srcportto-val > ] [ **dstportfrom**  
<dstportfrom-val > ] [ **dstportto** <dstportto-val > ] [ **srcportcmp** eq | neq | lt | leq |  
**gt** | geq | any | inrange | exrange ] [ **dstportcmp** eq | neq | lt | leq | gt | geq | any  
| inrange | exrange ] [ **subruleprio** low | high | asinrule ] [ **transporthdr** ethernet  
| pppoe ]

**Parameters:**

| Name                                     | Description   |
|--|---|
| <b>ruleid</b> <ruleid-val >              | Unique identifier of a filter rule of which this sub rule is being created<br><b>Type:</b> Create -- Mandatory<br>Delete -- Mandatory<br>Modify -- Mandatory<br>Get --Optional<br><b>Valid values:</b> 1-65535  |
| <b>subruleid</b> <subruleid-val >        | Unique identifier of a filter subrule<br><b>Type:</b> Create -- Mandatory<br>Delete -- Mandatory<br>Modify -- Mandatory<br>Get --Optional<br><b>Valid values:</b> 1 - 4294967295  |
| <b>srcportfrom</b><br><srcportfrom-val > | Start port number of the range of source port numbers. This field is invalid if 'srcportcmp' is 'any'. This field and 'srcportto' specify a range of tcp source port numbers if 'srcportcmp' is either 'inrange' or 'exrange'<br><b>Type:</b> Create -- Optional<br>Modify -- Optional<br><b>Default value:</b> 0 |



|  |  |
|--|--|
| <b>srcportto</b> <srcportto-val >  | <p>End port number of the range of source port numbers. This field and 'srcportfrom' specify a range of TCP source port numbers if 'srcportcmp' is either 'inrange' or 'exrange'</p> <p><b>Type:</b> Create -- Optional<br/> Modify -- Optional</p> <p><b>Default value:</b> 65535</p>   |
| <b>dstportfrom</b> <dstportfrom-val >                                      | <p>Start port number of the range of destination port numbers. This field is invalid if 'dstportcmp' is 'any'. This field and 'dstportto' specify a range of tcp destination port numbers if 'dstportcmp' is either 'inrange' or 'exrange'</p> <p><b>Type:</b> Create --Optional<br/> Modify --Optional</p> <p><b>Default value:</b> 0</p>   |
| <b>dstportto</b> <dstportto-val >  | <p>End port number of the range of destination port numbers. This field and 'dstportfrom' specify a range of tcp destination port numbers if 'dstportcmp' is either 'inrange' or 'exrange'. Otherwise this field is invalid</p> <p><b>Type:</b> Create -- Optional<br/> Modify -- Optional</p> <p><b>Default value:</b> 65535</p>  |
| <b>srcportcmp</b> eq   neq   lt   leq   gt   geq   any   inrange   exrange | <p>Source port comparison type</p> <p><b>Type:</b> Create -- Optional<br/> Modify -- Optional</p> <p><b>Default value:</b> any</p>   |
| <b>dstportcmp</b> eq   neq   lt   leq   gt   geq   any   inrange   exrange | <p>Destination port comparison type</p> <p><b>Type:</b> Create -- Optional<br/> Modify -- Optional</p> <p><b>Default value:</b> any</p>  |
| <b>subruleprio</b> low   high   asinrule                                   | <p>This specifies the priority of the subrule. Based on this priority value, the subrule is created in fast or slow memory. In case priority is specified as 'asinrule', subrule priority will be same as specified in the rule.</p> <p><b>Type:</b> Create -- Optional<br/> Modify -- Optional</p> <p><b>Default value:</b> asinrule</p>  |
| <b>transporthdr</b> ethernet   pppoe                                       | <p>This specifies the type of the transport header in the packet in which the corresponding IP is being transported. If the value of this field is 'Ethernet', then the IP is being carried in the Ethernet header. If it is 'PPPoE', then the corresponding IP is being carried in the PPP header.</p> <p><b>Type:</b> Create -- Optional<br/> Modify -- Optional</p> <p><b>Default value:</b> Ethernet</p> |

**Example:**

```
$create filter subrule tcp ruleid 1 subruleid 2 srcportfrom 21 srcportto 23
dstportfrom 21 dstportto 23 srcportcmp inrange dstportcmp inrange subruleprio
high
```

**Output:**

```
Verbose Mode On
Entry Created
```

```
Rule Id           : 1           Subrule Id           : 2
Start source port : 21           End source port      : 23
Start destination port : 21       End destination port : 23
Source port comparison : inrange Destination port comparison : inrange
Subrule Priority    : high
Transport Header    : Ethernet
Verbose Mode Off:
Entry Created
```

**Output field:**

| Field                              | Description   |
|------------------------------------|---|
| <b>Rule Id</b>                     | Unique identifier of a filter rule of which this sub rule is being created.   |
| <b>Subrule Id</b>                  | Unique identifier of a filter subrule   |
| <b>Start source port</b>           | Start port number of the range of source port numbers. This field is invalid if 'srcportcmp' is 'any'. This field and 'srcportto' specify a range of tcp source port numbers if 'srcportcmp' is either 'inrange' or 'exrange'           |
| <b>End source port</b>             | End port number of the range of source port numbers. This field and 'srcportfrom' specify a range of tcp source port numbers if 'srcportcmp' is either 'inrange' or 'exrange'   |
| <b>Start destination port</b>      | Start port number of the range of destination port numbers. This field is invalid if 'dstportcmp' is 'any'. This field and 'dstportto' specify a range of tcp destination port numbers if 'dstportcmp' is either 'inrange' or 'exrange' |
| <b>End destination port</b>        | End port number of the range of destination port numbers. This field and 'dstportfrom' specify a range of tcp destination port numbers if 'dstportcmp' is either 'inrange' or 'exrange'.Otherwise this field is invalid                 |
| <b>Source port comparison</b>      | Source port comparison type   |
| <b>Destination port comparison</b> | Destination port comparison type  |
| <b>Subrule Priority</b>            | This specifies the priority of the subrule. Based on this priority value, the subrule is created in fast or slow memory. In case priority is specified as   |

|                         |  |
|-------------------------|--|
|                         | 'asinrule', subrule priority will be same as specified in the rule.  |
| <b>Transport Header</b> | This specifies the type of the transport header in the packet in which the corresponding IP is being transported. If the value of this field is 'Ethernet', then the IP is being carried in the Ethernet header. If it is 'PPPoE', then the corresponding IP is being carried in the PPP header. |

**References:**

- Generic Filter Commands

### 5.13.35 Filter subrule UDP Commands

#### 5.13.35.1 Get Filter subrule udp

**Description:**

Use this command to get.

**Command Syntax:**

**get filter subrule udp** [**ruleid** <ruleid-val>] [**subruleid** <subruleid-val>]

#### 5.13.35.2 Create filter subrule udp

**Description:**

Use this command to create.

**Command Syntax:**

**create filter subrule udp ruleid** <ruleid-val > **subruleid** <subruleid-val >  
 [**srcportfrom** <srcportfrom-val >] [**srcportto** <srcportto-val >] [**dstportfrom**  
 <dstportfrom-val >] [**dstportto** <dstportto-val >] [**srcportcmp** eq | neq | lt | leq |  
 gt | geq | any | inrange | exrange] [**dstportcmp** eq | neq | lt | leq | gt | geq | any  
 | inrange | exrange] [**subruleprio** low | high | asinrule] [**transporthdr** ethernet  
 | pppoe ]

#### 5.13.35.3 Delete filter subrule udp

**Description:**

Use this command to delete.

**Command Syntax:**

**delete filter subrule udp ruleid** <ruleid-val > **subruleid** <subruleid-val >

### 5.13.35.4 Modify filter subrule udp

#### Description:

Use this command to modify.

#### Command Syntax:

```
modify filter subrule udp ruleid <ruleid-val> subruleid <subruleid-val>  
[ srcportfrom <srcportfrom-val> ] [ srcportto <srcportto-val> ] [ dstportfrom  
<dstportfrom-val> ] [ dstportto <dstportto-val> ] [ srcportcmp eq | neq | lt | leq | gt  
| geq | any | inrange | exrange ] [ dstportcmp eq | neq | lt | leq | gt | geq | any |  
inrange | exrange ] [ subruleprio low | high | asinrule] [ transporthdr ethernet |  
pppoe ] [ transporthdr ethernet | pppoe ]
```

#### Parameters:

| Name                                     | Description  |
|--|--|
| <b>ruleid</b> <ruleid-val >              | Unique identifier of a filter rule of which this sub rule is being created<br><b>Type:</b> Create --Mandatory<br>Delete --Mandatory Modify<br>Mandatory Get --Optional<br><b>Valid values:</b> 1-65535   |
| <b>subruleid</b><br><subruleid-val >     | Unique identifier of a filter subrule<br><b>Type:</b> Create --Mandatory<br>Delete -- Mandatory<br>Modify-- Mandatory<br>Get --Optional<br><b>Valid values:</b> 1 - 4294967295   |
| <b>srcportfrom</b><br><srcportfrom-val > | Start port number of the range of source port numbers. This field is invalid if 'srcportcmp' is 'any'. This field and 'srcportto' specify a range of udp source port numbers, if 'srcportcmp' is either 'inrange' or 'exrange'<br><b>Type:</b> Create -- Optional<br>Modify -- Optional<br><b>Default value:</b> 0 |
| <b>srcportto</b><br><srcportto-val >     | End port number of the range of source port numbers.This field and 'srcportfrom' specify a range of udp source port numbers, if 'srcportcmp' is either 'inrange' or 'exrange'<br><b>Type:</b> Create -- Optional<br>Modify -- Optional<br><b>Default value:</b> 65535  |
| <b>dstportfrom</b><br><dstportfrom-val > | Start port number of the range of destination port numbers. This field is invalid if 'dstportcmp' is 'any'.This field and 'dstportto' specify a range of   |

|   |   |
|---|---|
|   | <p>udp destination port numbers, if 'dstportcmp' is either 'inrange' or 'exrange'</p> <p><b>Type:</b> Create -- Optional<br/>Modify -- Optional</p> <p><b>Default value:</b> 0</p>  |
| <p><b>dstportto</b><br/>&lt;dstportto-val &gt;</p>                                | <p>End port number of the range of destination port numbers. This field and 'dstportfrom' specify a range of udp destination port numbers, if 'dstportcmp' is either 'inrange' or 'exrange'. Otherwise this field is invalid</p> <p><b>Type:</b> Create -- Optional<br/>Modify -- Optional</p> <p><b>Default value:</b> 65535</p>   |
| <p><b>srcportcmp eq   neq   lt   leq   gt   geq   any   inrange   exrange</b></p> | <p>Source port comparison type</p> <p><b>Type:</b> Create -- Optional<br/>Modify -- Optional</p> <p><b>Default value:</b> any</p>   |
| <p><b>dstportcmp eq   neq   lt   leq   gt   geq   any   inrange   exrange</b></p> | <p>Destination port comparison type</p> <p><b>Type:</b> Create -- Optional<br/>Modify -- Optional</p> <p><b>Default value:</b> any</p>  |
| <p><b>subruleprio low   high   asinrule</b></p>                                   | <p>This specifies the priority of the subrule. Based on this priority value, the subrule is created in fast or slow memory. In case priority is specified as 'asinrule', subrule priority will be same as specified in the rule.</p> <p><b>Type:</b> Create -- Optional<br/>Modify -- Optional</p> <p><b>Default value:</b> asinrule</p>  |
| <p><b>transporthdr ethernet   pppoe</b></p>                                       | <p>This specifies the type of the transport header in the packet in which the corresponding IP is being transported. If the value of this field is Ethernet, then the IP is being carried in the Ethernet header. If it is PPPoE, then the corresponding IP is being carried in the PPP header.</p> <p><b>Type:</b> Create -- Optional<br/>Modify -- Optional</p> <p><b>Default value:</b> Ethernet</p> |

### Example:

```
$ create filter subrule udp ruleid 1 subruleid 2 srcportfrom 21 srcportto 23
dstportfrom 21 dstportto 23 srcportcmp inrange dstportcmp inrange subruleprio
high
```

**Output:**

Verbose Mode On

Entry Created

Rule Id : 1 Subrule Id : 2  
 Start source port : 21 End source port : 23  
 Start destination port : 21 End destination port : 23  
 Source port comparison : inrange Destination port comparison : inrange  
 Subrule Priority : high  
 Transport Header : ethernet  
 Verbose Mode Off:  
 Entry Created

**Output field:**

| Field                              | Description  |
|------------------------------------|--|
| <b>Rule Id</b>                     | Unique identifier of a filter rule of which this sub rule is being created   |
| <b>Subrule Id</b>                  | Unique identifier of a filter subrule  |
| <b>Start source port</b>           | Start port number of the range of source port numbers. This field is invalid if 'srcportcmp' is 'any'. This field and 'srcportto' specify a range of udp source port numbers, if 'srcportcmp' is either 'inrange' or 'exrange'           |
| <b>End source port</b>             | End port number of the range of source port numbers. This field and 'srcportfrom' specify a range of udp source port numbers, if 'srcportcmp' is either 'inrange' or 'exrange'   |
| <b>Start destination port</b>      | Start port number of the range of destination port numbers. This field is invalid if 'dstportcmp' is 'any'. This field and 'dstportto' specify a range of udp destination port numbers, if 'dstportcmp' is either 'inrange' or 'exrange' |
| <b>End destination port</b>        | End port number of the range of destination port numbers. This field and 'dstportfrom' specify a range of udp destination port numbers, if 'dstportcmp' is either 'inrange' or 'exrange'. Otherwise this field is invalid                |
| <b>Source port comparison</b>      | Source port comparison type  |
| <b>Destination port comparison</b> | Destination port comparison type   |
| <b>Subrule Priority</b>            | This specifies the priority of the subrule. Based on this  |

|                         |  |
|-------------------------|--|
|                         | priority value, the subrule is created in fast or slow memory. In case priority is specified as 'asinrule', subrule priority will be same as specified in the rule.  |
| <b>Transport Header</b> | This specifies the type of the transport header in the packet in which the corresponding IP is being transported. If the value of this field is Ethernet, then the IP is being carried in the Ethernet header. If it is PPPoE, then the corresponding IP is being carried in the PPP header. |

### References:

- Generic Filter Commands

## 5.14 IGMP Commands

---

### 5.14.1 Igmnoop cfg info Commands

#### 5.14.1.1 Get igmnoop cfg info

##### Description:

Use this command to get.

##### Command Syntax:

**get igmnoop cfg info**

#### 5.14.1.2 Modify igmnoop cfg info

##### Description:

Use this command to modify.

##### Command Syntax:

```
modify igmnoop cfg info [ queryinterval <queryinterval-val> ] [ anxioustimer <anxioustimer-val> ] [ v1hosttimer <v1hosttimer-val> ] [ lastmembqryinterval <lastmembqryinterval-val> ] [ robustness <robustness-val> ] [ status Enable | Disable ] [ reportsup Enable | Disable ] [ qryrespinterval <qryrespinterval-val> ] [ proxyreportstatus Enable | Disable ] [ versionmask v1 | v2 | v3 ] [ startupqryinterval <startupqryinterval-val> ] [ startupqrycount <startupqrycount-val> ] [ lastmemberqrycount <lastmemberqrycount-val> ] [ unsolicrprtinterval <unsolicrprtinterval-val> ]
```

## Parameters:

| Name  | Description   |
|---|---|
| <p><b>queryinterval</b><br/>&lt;queryinterval-val&gt;</p>             | <p>This parameter is used to calculate the entry age out timer, when no reports or queries are received on the entry. When the value of this parameter multiplied by 10, it should be greater than the Query Interval configured at the router. The time for which an entry created at Igmssnoop module exists, if no messages are received for it is approximately <math>((\text{QueryInterval} * 10) * \text{Robustness}) + \text{Query Response Time received in Last Query}</math></p> <p><b>Type:</b> Modify -- Optional<br/><b>Valid values:</b> 1 - 0xff</p> |
| <p><b>anxioustimer</b><br/>&lt;anxioustimer-val&gt;</p>               | <p>This parameter specifies the maximum time (in seconds) before which the Igmssnoop module will forward all IGMP membership reports received. It is started once, whenever the first membership report is received for a group, to ensure that reports are forwarded for a sufficiently long time, to take care of any lost reports. The unit is seconds.</p> <p><b>Type:</b> Modify -- Optional<br/><b>Valid values:</b> 1 - 65535</p>  |
| <p><b>v1hosttimer</b><br/>&lt;v1hosttimer-val&gt;</p>                 | <p>This parameter specifies the maximum time (in seconds), for which the Igmssnooping module can assume that there are Version 1 group members present, for the group for which this timer is running. The unit of this parameter is seconds.</p> <p><b>Type:</b> Modify -- Optional<br/><b>Valid values:</b> 1 - 260</p>   |
| <p><b>lastmembqryinterval</b><br/>&lt;lastmembqryinterval-val&gt;</p> | <p>This parameter specifies the Last Member Query Interval that is the Max Response Time inserted into Group-Specific Queries sent in response to Leave Group messages, and is also the amount of time between Group-Specific Query messages. The value of this parameter may be tuned to modify the leave latency of the network. A reduced value results in reduced time to detect the loss of the last member of a group. The unit of this parameter is one-tenth of second.</p> <p><b>Type:</b> Modify -- Optional<br/><b>Valid values:</b> 1 – 255</p>         |
| <p><b>robustness</b><br/>&lt;robustness-val&gt;</p>                   | <p>This parameter allows tuning for the expected packet loss on a subnet. The Igmssnooping module is robust to [RobustnessVar] packet losses.</p> <p><b>Type:</b> Modify -- Optional<br/><b>Valid values:</b> 2 - 255</p>   |



|   |   |
|---|---|
| <b>status</b> Enable   Disable                            | This parameter specifies whether Igmp Snooping needs to be enabled in the system.<br><b>Type:</b> Modify -- Optional  |
| <b>reportsup</b> Enable   Disable                         | Report Suppression is enabled or not.<br><b>Type:</b> Modify -- Optional  |
| <b>qryrespinterval</b><br><qryrespinterval-val>           | This parameter is used to derive Max Response Code to be filled in General query that will be initiated from Columbia<br><b>Type:</b> Modify -- Optional<br><b>Valid values:</b> 1 - 0xff   |
| <b>proxyreportstatus</b><br>Enable   Disable              | This parameter controls whether proxy reporting will be supported at the global level.<br><b>Type:</b> Modify -- Optional   |
| <b>versionmask</b> v1   v2   v3                           | This parameter controls which versions of IGMP are currently supported at Columbia. Depending on the version mask, IGMP messages of unsupported version, will be dropped<br><b>Type:</b> Modify -- Optional   |
| <b>startupqryinterval</b><br><startupqryinterval-val<br>> | This parameter specifies the interval between General Queries sent on receiving Port Up topology change trigger.<br><b>Type:</b> Modify -- Optional<br><b>Valid values:</b> 1 - 0xff  |
| <b>startupqrycount</b><br><startupqrycount-val>           | This parameter specifies the number of General Queries sent on receiving Port Up topology change trigger, separated by the StartupQryInterval<br><b>Type:</b> Modify -- Optional<br><b>Valid values:</b> 0 - 0xff   |
| <b>lastmemberqrycount</b><br><lastmemberqrycount-val>     | This parameter specifies the number of Group-specific or Group-and-Source-specific Queries sent before assuming there are no listener for this Group or Group-Source pair.<br><b>Type:</b> Modify -- Optional<br><b>Valid values:</b> 1 - 0xff              |
| <b>unsolicrptinterval</b><br><unsolicrptinterval-val<br>> | This parameter specifies the interval between unsolicited membership reports of a group sent for robustness no of times. This field is applicable only when proxy reporting is enabled.<br><b>Type:</b> Modify -- Optional<br><b>Valid values:</b> 1 - 0xff |

### Example:

```
$ get igmpsnoop cfg info
```

**Output:**

Query Interval : 12                      Query Response Interval : 10  
 StartUp Query Interval : 10              UnSolicRprtInterval : 10  
 Anxious Timer : 125                      V1 Host Timer : 130  
 Last Member Query Interval : 125        Robustness Variable : 2  
 Igmp Snoop Status : Enable  
 Version Mask : v3  
 Report Suppression Status : Enable       Proxy Report Status : Enable  
 StartUp QryCount : 2                      Last Member QryCount : 100

**Output field:**

| Field                             | Description   |
|-----------------------------------|---|
| <b>Query Interval</b>             | This parameter is used to calculate the entry age out timer, when no reports or queries are received on the entry. When the value of this parameter multiplied by 10, it should be greater than the Query Interval configured at the router. The time for which an entry created at Igmpsnoop module exists, if no messages are received for it is approximately<br>$((\text{QueryInterval} * 10) * \text{Robustness}) + \text{Query Response Time received in Last Query}$ |
| <b>Query Response Interval</b>    | This parameter is used to derive Max Response Code to be filled in General query that will be initiated from Columbia   |
| <b>StartUp Query Interval</b>     | This parameter specifies the interval between General Queries sent on receiving Port Up topology change trigger.  |
| <b>UnSolicRprtInterval</b>        | This parameter specifies the interval between unsolicited membership reports of a group sent for robustness no of times. This field is applicable only when proxy reporting is enabled.   |
| <b>Anxious Timer</b>              | This parameter specifies the maximum time (in seconds) before which the IgmpSnoop module will forward all IGMP membership reports received. It is started once, whenever the first membership report is received for a group, to ensure that reports are forwarded for a sufficiently long time, to take care of any lost reports. The unit is seconds.   |
| <b>V1 Host Timer</b>              | This parameter specifies the maximum time (in seconds), for which the IgmpSnooping module can assume that there are Version 1 group members present, for the group for which this timer is running. The unit of this parameter is seconds.  |
| <b>Last Member Query Interval</b> | This parameter specifies the Last Member Query Interval that is the Max Response Time inserted into Group-Specific Queries  |

|                                  |   |
|----------------------------------|---|
|                                  | sent in response to Leave Group messages, and is also the amount of time between Group-Specific Query messages. The value of this parameter may be tuned to modify the leave latency of the network. A reduced value results in reduced time to detect the loss of the last member of a group. The unit of this parameter is one-tenth of second. |
| <b>Robustness Variable</b>       | This parameter allows tuning for the expected packet loss on a subnet. The IcmpSnooping module is robust to [RobustnessVar] packet losses.  |
| <b>Icmp Snoop Status</b>         | This parameter specifies whether Icmp Snooping needs to be enabled in the system.   |
| <b>Version Mask</b>              | This parameter controls which versions of IGMP are currently supported at Columbia. Depending on the version mask, IGMP messages of unsupported version, will be dropped  |
| <b>Report Suppression Status</b> | Report Suppression is enabled or not.   |
| <b>Proxy Report Status</b>       | This parameter controls whether proxy reporting will be supported at the global level.  |
| <b>Startup QryCount</b>          | This parameter specifies the number of General Queries sent on receiving Port Up topology change trigger, separated by the StartupQryInterval   |
| <b>Last Member QryCount</b>      | This parameter specifies the number of Group-specific or Group-and-Source-specific Queries sent before assuming there are no listener for this Group or Group-Source pair.  |

## 5.14.2 Icmpsnoop mvlan config Commands

### 5.14.2.1 Get icmpsnoop mvlan config

#### Description:

Use this command to get.

#### Command Syntax:

```
get icmpsnoop mvlan config [grpipaddr <grpipaddr-val>] [srcipaddr <srcipaddr-val>] [vlanid <vlanid-val> | none]
```

### 5.14.2.2 Create igmpsnoop mvlan config

**Description:**

Use this command to create.

**Command Syntax:**

```
create igmpsnoop mvlan config grpipaddr <grpipaddr-val> srcipaddr  
vlanid <vlanid-val> | none [mcastvlanstag <mcastvlanstag-val> | none]  
[mcastvlanctag <mcastvlanctag-val> | invlan | none] [portlist <portlist-val> |  
none]
```

### 5.14.2.3 Delete igmpsnoop mvlan config

**Description:**

Use this command to delete.

**Command Syntax:**

```
delete igmpsnoop mvlan config [grpipaddr <grpipaddr-val>] [srcipaddr  
<srcipaddr-val>] [vlanid <vlanid-val> | none]
```

### 5.14.2.4 Modify igmpsnoop mvlan config

**Description:**

Use this command to modify.

**Command Syntax:**

```
modify igmpsnoop mvlan config grpipaddr <grpipaddr-val> srcipaddr  
<srcipaddr-val> vlanid <vlanid-val> | none [mcastvlanstag <mcastvlanstag-val> |  
none] [mcastvlanctag <mcastvlanctag-val> | invlan | none] [portlist <portlist-val>  
| none]
```

**Parameters:**

| Name                                | Description  |
|-------------------------------------|--|
| <b>grpipaddr</b><br><grpipaddr-val> | This parameter specifies the Destination Group IP address for a multicast stream. The source address and destination group address together define a multicast stream. In case of value 0, this parameter is ignored while determining Multicast Vlan<br><br><b>Type:</b> Create -- Mandatory<br>Delete -- Mandatory<br>Modify -- Mandatory<br>Get -- Optional |

|   |  |
|---|--|
| <p><b>srcipaddr</b><br/>&lt;srcipaddr-val&gt;</p>                         | <p>This parameter specifies the source IP address of the Multicast Server. The source address and destination group address together define a multicast stream. In case of value 0, this parameter is ignored while determining Multicast Vlan.</p> <p><b>Type:</b> Create -- Mandatory<br/>Delete -- Mandatory<br/>Modify -- Mandatory<br/>Get -- Optional</p>  |
| <p><b>vlanid</b> &lt;vlanid-val&gt;   none</p>                            | <p>This parameter specifies the Dot1q tag of an IGMP packet received. This will be PVID in case an untagged IGMP packet was received. In case of value 0, this parameter is ignored while determining Multicast Vlan.</p> <p><b>Type:</b> Create -- Mandatory<br/>Delete -- Mandatory<br/>Modify -- Mandatory<br/>Get -- Optional</p> <p><b>Valid values:</b> 1 - 4095<br/><b>Additional Values:</b> 0</p>   |
| <p><b>mcastvlanstag</b><br/>&lt;mcastvlanstag-val&gt;   none</p>          | <p>This parameter specifies the Multicast SVlanId to be used in case of stacked mode. In the native mode, this parameter is not applicable.</p> <p><b>Type:</b> Create -- Optional<br/>Modify -- Optional</p> <p><b>Valid values:</b> 1 - 4095<br/><b>Additional Values:</b> 0</p>   |
| <p><b>mcastvlanctag</b><br/>&lt;mcastvlanctag-val&gt;   invlan   none</p> | <p>This parameter specifies the Multicast CVlanId to be used. Two special values of this parameter are supported in stacked mode: One value (4097) to signify that report/leave shall be forwarded to querier with the C tag with which it was received from the subscriber port and the S tag specified in multicast Vlan's definition One value (0) to signify that report/leave shall be forwarded to querier with S tag specified in multicast Vlan's definition and no C tag. Other Value shall signify that, report/leave shall be forwarded to querier with S and C tag specified in multicast Vlan's definition.</p> <p><b>Type:</b> Create -- Optional<br/>Modify -- Optional</p> <p><b>Valid values:</b> 1 -4095<br/><b>Additional Values:</b> 0, 4097</p> |

|  |  |
|--|--|
| <b>portlist</b> <portlist-val>  <br>none | This parameter specifies the list of ports on which a given combination of (Group Address, Source Address, VlanId) maps to a specified multicast vlan (STag, CTag)<br><br><b>Type:</b> Create -- Optional<br>Modify -- Optional<br><br><b>Default value:</b> 0 |
|--|--|

**Example:**

```
$ create igmpsnoop mvlan config grpipaddr 224.0.0.7 srcipaddr 12.23.34.45 vlanid 6 mcastvlanstag 5 mcastvlanctag 5 portlist 5 6 10
```

**Output:**

Verbose Mode On  
Entry Created

```
Grp IPAddress   : 224.0.0.7
Src IPAddress   : 12.23.34.45
VLAN Index     : 6
McastVlan STag : 5           McastVlan CTag : 5
PortList       : 5 6 10
```

Verbose Mode Off:  
Entry Created

**Output field:**

| Field                 | Description   |
|-----------------------|---|
| <b>Grp IPAddress</b>  | This parameter specifies the Destination Group IP address for a multicast stream. The source address and destination group address together define a multicast stream. In case of value 0, this parameter is ignored while determining Multicast Vlan |
| <b>Src IPAddress</b>  | This parameter specifies the source IP address of the Multicast Server. The source address and destination group address together define a multicast stream. In case of value 0, this parameter is ignored while determining Multicast Vlan.          |
| <b>VLAN Index</b>     | This parameter specifies the Dot1q tag of an IGMP packet received. This will be PVID in case an untagged IGMP packet was received. In case of value 0, this parameter is ignored while determining Multicast Vlan.                                    |
| <b>McastVlan STag</b> | This parameter specifies the Multicast SVlanId to be used in case of stacked mode. In the native mode, this parameter is not  |

|                       |   |
|-----------------------|---|
|                       | applicable.   |
| <b>McastVlan CTag</b> | This parameter specifies the Multicast CVlanId to be used. Two special values of this parameter are supported in stacked mode:<br>One value (4097) to signify that report/leave shall be forwarded to querier with the C tag with which it was received from the subscriber port and the S tag specified in multicast Vlan's definition<br>One value (0) to signify that report/leave shall be forwarded to querier with S tag specified in multicast Vlan's definition and no C tag. Other Value shall signify that, report/leave shall be forwarded to querier with S and C tag specified in multicast Vlan's definition. |
| <b>PortList</b>       | This parameter specifies the list of ports on which a given combination of (Group Address, Source Address, VlanId) maps to a specified multicast vlan (STag, CTag)  |

### 5.14.3 Igmppsnoop port info Commands

#### 5.14.3.1 Get igmpsnoop port info

**Description:**

Use this command to get.

**Command Syntax:**

**get igmpsnoop port info [portid <portid-val >]**

#### 5.14.3.2 Modify igmpsnoop port info

**Description:**

Use this command to modify.

**Command Syntax:**

**modify igmpsnoop port info portid portid [ status Enable | Disable ]**  
**[ leavemode Normal | Fast | FastNormal ] [ pktpriority <pktpriority-val> | none ]**  
**[ maxgrpallowed <maxgrpallowed-val> ] [ querierstatus Enable | Disable ]**  
**[ mcastvlanstatus Enable | Disable ] [ nomatchaction Drop |**  
**Transparentlyforward | Learn ]**

## Parameters:

| Name  | Description   |
|---|---|
| <b>portid</b> <portid-val>                  | <p>This parameter specifies a bridge port for which IGMP Snooping needs to be enabled or disabled.</p> <p><b>Type:</b> Modify -- Mandatory<br/>Get -- Optional</p> <p><b>Valid values:</b> 1 - 194</p>  |
| <b>status</b> Enable   Disable              | <p>This parameter specifies whether IGMP Snooping is to be enabled on the port.</p> <p><b>Type:</b> Modify -- Optional</p>  |
| <b>leavemode</b> Normal   Fast   FastNormal | <p>This parameter specifies the Igmp Snooping Leave message processing mode for the port. If the mode is set to 'Normal', the Leave message is forwarded to the Querier. Then, based on the Query received from Querier, the Leave processing is triggered. If the mode is set to 'Fast', the port is immediately deleted from that multicast group on Leave message reception and then the Leave message is forwarded. The mode should be set to 'Fast' for a port only if there is one host behind the port. This is because if there are multiple hosts behind the port then it will lead to traffic disruption for other hosts who might still be listening to that multicast group. If the mode is set to 'FastNormal', the Leave message is forwarded and the Leave processing is triggered immediately without waiting for any trigger from the Querier. The 'FastNormal' mode, thus, saves the delay (equal to the time taken for Leave message to reach router and Querier processing time for it and the time taken for Query to reach IGMP Snoop module) in Leave processing.</p> <p><b>Type:</b> Modify -- Optional</p> <p><b>Valid values:</b> op module) in Leave processing.</p> |
| <b>pktpriority</b> <pktpriority-val>   none | <p>This parameter specifies the Egress Priority to be set in case the Ethernet frames carrying IGMP packets sent over this port need to be tagged by the control plane. In case the frame came tagged, priority that came in the tagged frame will not be changed. The configured priority will also be used for choice of traffic class/Queue on outgoing interface whether the frame is tagged . In case the bridge port is over an Aggregated ATM VC, this will also be used to identify the VC, on which the packet is to be sent. There is an additional support of invalid value for egress priority in IGMP port info to indicate that the priority is not to be forced on egress frame for this port.</p>   |



|  |   |
|--|---|
|  | <b>Type:</b> Modify -- Optional<br><b>Valid values:</b> 0 - 7   |
| <b>maxgrpallowed</b><br><maxgrpallowed-val>                    | This parameter controls the no. of simultaneous channels that can be received by this port<br><b>Type:</b> Modify -- Optional<br><b>Valid values:</b> 0 - 256   |
| <b>querierstatus</b> Enable  <br>Disable                       | This parameter controls whether a port can become querier<br><b>Type:</b> Modify -- Optional  |
| <b>mcastvlanstatus</b> Enable  <br>Disable                     | This parameter controls the status of Multicast Vlan option on a port<br><b>Type:</b> Modify -- Optional  |
| <b>nomatchaction</b> Drop  <br>Transparentlyforward  <br>Learn | This parameter specifies the action to be taken when multicast vlan can not be determined for a port where multicast vlan option is enabled Possible action values will be :Drop, Transparently forward, and Learn based on ingress vlan<br><b>Type:</b> Modify -- Optional |

### Example:

```
$ get igmpsnoop port info portid 6
```

### Output:

```
Port Index                : 6
Port Igmp Snoop Status   : Enable      Leave Mode           : Normal
IGMP PacketsPrio:2MaxGroupAllowed:2'
Querier Status           : Enable      McastVlan Status : Enable
No McastVlan Match Action : Learn
```

### Output field:

| Field                         | Description  |
|-------------------------------|--|
| <b>Port Index</b>             | This parameter specifies a bridge port for which IGMP Snooping needs to be enabled or disabled.  |
| <b>Port Igmp Snoop Status</b> | This parameter specifies whether IGMP Snooping is to be enabled on the port.   |
| <b>Leave Mode</b>             | This parameter specifies the Igmp Snooping Leave message processing mode for the port. If the mode is set to 'Normal', the Leave message is forwarded to the Querier. Then, based on the Query received from Querier, the Leave processing is triggered. If the mode is set to 'Fast', the port is immediately deleted from that multicast group on Leave message reception and then the Leave message is forwarded. The mode should be set to 'Fast' for a port |

|                                  |   |
|----------------------------------|---|
|                                  | <p>only if there is one host behind the port. This is because if there are multiple hosts behind the port then it will lead to traffic disruption for other hosts who might still be listening to that multicast group. If the mode is set to 'FastNormal', the Leave message is forwarded and the Leave processing is triggered immediately without waiting for any trigger from the Querier. The 'FastNormal' mode, thus, saves the delay (equal to the time taken for Leave message to reach router and Querier processing time for it and the time taken for Query to reach IGMP Snoop module) in Leave processing.</p>   |
| <b>IGMP PacketsPrio'</b>         | <p>This parameter specifies the Egress Priority to be set in case the Ethernet frames carrying IGMP packets sent over this port need to be tagged by the control plane. In case the frame came tagged, priority that came in the tagged frame will not be changed. The configured priority will also be used for choice of traffic class/Queue on outgoing interface whether the frame is tagged . In case the bridge port is over an Aggregated ATM VC, this will also be used to identify the VC, on which the packet is to be sent. There is an additional support of invalid value for egress priority in IGMP port info to indicate that the priority is not to be forced on egress frame for this port.</p> |
| <b>MaxGroupAllowed</b>           | <p>This parameter controls the no. of simultaneous channels that can be received by this port</p>   |
| <b>Querier Status</b>            | <p>This parameter controls whether a port can become querier</p>  |
| <b>McastVlan Status</b>          | <p>This parameter controls the status of Multicast Vlan option on a port</p>  |
| <b>No McastVlan Match Action</b> | <p>This parameter specifies the action to be taken when multicast vlan can not be determined for a port where multicast vlan option is enabled Possible action values will be :Drop, Transparently forward, and Learn based on ingress vlan</p>   |

**Caution:**

- An entry in this table shall not be applicable for a bridge port created over the PPPoE interface.

## 5.14.4 Igmnoop port stats Commands

### 5.14.4.1 Get igmnoop port stats

**Description:**

Use this command to get.

**Command Syntax:**

```
get igmnoop port stats [vlanid <vlanid-val>] [mcastaddr <mcastaddr-val>]  
[portid <portid-val>]
```

### 5.14.4.2 Reset igmnoop port stats

**Description:**

Use this command to reset.

**Command Syntax:**

```
reset igmnoop port stats [vlanid vlanid] mcastaddr <mcastaddr-val> portid  
<portid-val>
```

**Parameters:**

| Name                        | Description  |
|-----------------------------|--|
| <b>vlanid</b> <vlanid-val > | <p>The VLAN id for this VLAN. In devices supporting "Shared Vlan for multicast" capability, the information for a multicast MAC address is shared across VLANS. Hence, vlanid is optional and can be passed as zero or a valid vlanid value. In devices supporting "Independent Vlan for multicast" capability, each vlan can have its own information for a multicast MAC address. Hence, VLAN id is a mandatory parameter and a valid value of vlanid must be passed. For the case when the attribute "McastDeviceCapabilities" of MO "sysSizingTable" has value "none", VLAN id is not required. This feature is not supported for VLAN with vlanid as 4097.VLAN here means the 802.1q Vlan in case of Native Vlan mode and Virtual Vlan in case of Stacked Vlan Mode.</p> <p><b>Type:</b> Create -- Mandatory<br/>Delete -- Mandatory<br/>Modify -- Mandatory<br/>Get -- Optional</p> <p><b>Valid values:</b> 1-4095</p> |

|                                      |   |
|--------------------------------------|---|
| <b>Mcastaddr</b><br><mcastaddr-val > | A multicast MAC Address, learned through Igmp Snooping, within the Vlan (igmpVlanIndex), to uniquely identify the entry, for which the IgmpSnooping statistics are desired. The range of accepted values is 00:30:4F:00:00:00 to 00:30:4F:7F:FF:FF<br><b>Type:</b> Reset — Optional<br>Get — Optional<br><b>Valid values:</b> 00:30:4F:00:00:00 - 00:30:4F:7F:FF:FF |
| <b>portid</b> <portid>               | A Bridge Port belonging to the Vlan (igmpVlanIndex) and Group (igmpsnoopMcastAddress), for which the IgmpSnooping statistics are desired.<br><b>Type:</b> Reset --Optional<br>Get --Optional<br><b>Valid values:</b> 1 - 386  |

### Example:

```
$ get igmpsnoop port stats vlanid 6 mcastaddr 00:30:4f:0a:00:01 portid 6
```

### Output:

```
VLAN Index           : 6
Mcast Group Address : 00:30:4f:0a:00:01
Port Index           : 6
Query Received       : 100           Report Received : 200
Filter Mode          : Include
Include SrcList      : 10.12.14.16 12.10.45.76
Exclude SrcList      : 10.12.34.56 34.54.76.87
```

### Output field

| Field                      | Description   |
|----------------------------|---|
| <b>VLAN Index</b>          | This parameter specifies the VlanId to uniquely identify the VlanId of the entry, for which the IgmpSnooping statistics are desired. In devices supporting "Shared Vlan for multicast" capability, the information for a multicast MAC address is shared across vlans. Therefore, VlanId is an optional parameter. In devices supporting "Independent Vlan for multicast" capability, each vlan can have its own information for a multicast MAC address. Hence VlanId is a mandatory parameter in all the commands other than the get command. For no Vlan case, VlanId is not required. |
| <b>Mcast Group Address</b> | This parameter specifies a multicast MAC address, learnt through Igmp Snooping, within the Vlan (igmpVlanIndex), to uniquely identify the entry, for which the IgmpSnooping statistics are desired. The range of  |

|                        |  |
|------------------------|--|
|                        | accepted values is 00:30:4F:00:00:00 to 00:30:4F:7F:FF:FF.   |
| <b>Port Index</b>      | This parameter specifies a bridge port belonging to the Vlan (igmpVlanIndex) and Group (igmpsnoopMcastAddress), for which the IgmpSnooping statistics are desired.   |
| <b>Query Received</b>  | This parameter specifies the number of Igmp queries received on the port belonging to a particular multicast group and Vlan.   |
| <b>Report Received</b> | This parameter specifies the number of Membership reports received on the port belonging to a particular multicast group and Vlan.   |
| <b>Filter Mode</b>     | This parameter specifies the current filter mode on a port for a given group.  |
| <b>Include SrcList</b> | This parameter specifies the Include Source list, which is the list of sources to be included in case of Include filter mode and the list of conflicting sources in case of exclude mode of the port for a given group |
| <b>Exclude SrcList</b> | This parameter specifies the Exclude Source list, which is the list of sources to be excluded in case of exclude filter mode of the port for a given group   |

**Caution:**

- An entry in this table shall not be applicable for a bridge port created over the PPPoE interface.

## 5.14.5 Igmpsnoop querier info Commands

### 5.14.5.1 Get igmpsnoop querier info

**Description:**

Use this command to get.

**Command Syntax:**

**get igmpsnoop querier info [vlanid <vlanid-val >] [portid <portid-val>]**

### 5.14.5.2 Create igmpsnoop querier info

**Description:**

Use this command to create.

**Command Syntax:**

**create igmpsnoop querier info vlanid <vlanid-val > portid <portid-val >**

### 5.14.5.3 Delete igmpsnoop querier info

#### Description:

Use this command to delete.

#### Command Syntax:

```
delete igmpsnoop querier info vlanid <vlanid-val > portid <portid>
```

#### Parameters:

| Name                       | Description  |
|----------------------------|--|
| <b>vlanid</b> <vlanid-val> | <p>The VLAN id for this VLAN. In devices supporting "Shared Vlan for multicast" capability, the information for a multicast MAC address is shared across VLANs. Hence, vlanid is optional and can be passed as zero or a valid vlanid value. In devices supporting "Independent Vlan for multicast" capability, each vlan can have its own information for a multicast MAC address. Hence, VLAN id is a mandatory parameter and a valid value of vlanid must be passed. For the case when the attribute "McastDeviceCapabilities" of MO "sysSizingTable" has value "none", VLAN id is not required. This feature is not supported for VLAN with vlanid as 4097.VLAN here means the 802.1q Vlan in case of Native Vlan mode and Virtual Vlan in case of Stacked Vlan Mode.</p> <p><b>Type:</b> Create -- Mandatory<br/>Delete -- Mandatory<br/>Modify -- Mandatory<br/>Get -- Optional</p> <p><b>Valid values:</b> 1-4095</p> |
| <b>portid</b> <portid-val> | <p>A Bridge Port, belonging to the Vlan (dot1qVlanIndex), on which the Querier exists.</p> <p><b>Type:</b> Create -- Mandatory<br/>Delete -- Mandatory<br/>Get --Optional</p> <p><b>Valid values:</b> 1 - 65535</p>  |

#### Example:

```
$ create igmpsnoop querier info vlanid 6 portid 6
```

**Output:**

Verbose Mode On

Entry Created

VLAN Index : 6 Port Index : 6

Querier Port Status : Mgmt

Verbose Mode Off:

Entry Created

**Output field:**

| Field                      | Description  |
|----------------------------|--|
| <b>VLAN Index</b>          | VlanId to uniquely identify the vlanid of the entry for which the IgmpSnooping Querier is configured/ learned. In devices supporting "Shared Vlan for multicast" capability, the information for a Querier port is shared across vlans. Hence vlan id is an optional parameter. In devices supporting "Independent Vlan for multicast" capability, each vlan can have its own information for a Querier port. Hence vlanid is a mandatory parameter in all the commands other than - get. For No Vlan case, vlan id is not required. This Feature is not supported for VLAN with vlanid as 4097. |
| <b>Port Index</b>          | A Bridge Port, belonging to the Vlan (dot1qVlanIndex), on which the Querier exists.  |
| <b>Querier Port Status</b> | Specifies whether Querier Port has been learned dynamically or configured by the user.   |

**Caution:**

- An entry in this table shall not be applicable for a bridge port created over the PPPoE interface.

## 5.15 Interface Commands

---

### 5.15.1 Interface Commands

#### 5.15.1.1 Get interface stats

**Description:**

Use this command to view statistics for one interface or all the interfaces.

**Command Syntax:**

**get interface stats [ifname <interface-name>]**

**Parameters:**

| Name                              | Description  |
|-----------------------------------|--|
| <b>ifname</b><br><interface-name> | Index of the interface having one to one mapping with IfTable. Only Ethernet, EOA, Aggregator, HDLC, PPPOE, IPOE, ABOND, ATM, ATM VC Aggregation and ATM VC interface index are supported for reset operation.<br><b>Type</b> : Optional<br><b>Valid values</b> : aal5-*, eth-0, eth-1, atm-*, eoa-*, dsl-*, dslf-*, dsli-*, aggr-*, ehdlc-*, pppoe-*, pppr-*, vdsl-*, ipoe-*, abond-*, vcaggr-* |

**Example:**

```
$ get interface stats ifname eth-0
```

**Output:**

Verbose Mode On

Entry Created

```
Interface          : eth-0          Description       : eth-0
Type               : ETHERNET      Mtu              : 1500
Bandwidth          : 100000000      Phy Addr         :
00:BB:CC:DD:EE:F1
Last Change(sec)   : 219          Unknown Prot Pkts : 0
Admin Status       : Up           Operational Status : Up
In Octets          : 396312        Out Octets       : 168929
In Discards        : 0           Out Discards     : 0
In Errors          : 0           Out Errors       : 0
In Ucast Pkts     : 2291         Out Ucast Pkts  : 2518
```



In Mcast Pkts : 428                      Out Mcast Pkts : 0  
 In Bcast Pkts : 1456                     Out Bcast Pkts : 0  
 LinkUpDnTrapEnable : Enable            Promiscuous Mode : True  
 Connector Present : True                 CounterDiscontTime : 0  
 HC In Octets : 0x000060c18  
 HC OutOctets : 0x0000293e1

### Output Fields:

| Field                     | Description  |
|---------------------------|--|
| <b>Interface</b>          | Index of the interface having one to one mapping with IfTable. Only Ethernet, EOA , Aggregator, HDLC, PPPOE, IPOE, ABOND, ATM , ATM VC Aggregation and ATM VC interface index are supported for reset operation.   |
| <b>Description</b>        | This is general information about the interface  |
| <b>Type</b>               | The type of interface, distinguished according the physical/link/network protocol, immediately below the IP layer. It may be: ATM, ETHERNET, AAL5, EOA, DSL, FAST, INTERLEAVED, AGGR. EHDLC, PPP, LOOPBACK, IPOA, PPRP, PPPOE, SHDSL, ABOND, IPOE, VCAGGR, VDSL, USB. .  |
| <b>Mtu</b>                | The size (in bytes) of the largest packet, which can be sent/received on this interface in octets.   |
| <b>Bandwidth</b>          | The current bandwidth of the interface, in bps.  |
| <b>Phy Addr</b>           | Interface's address, at its protocol sublayer.   |
| <b>Admin Status</b>       | This is the desired state of the interface. It may be: Up, Down.   |
| <b>Operational Status</b> | The current operational state of the interface. If ifAdminStatus is disable (2), then ifOperStatus should be disable (2). If ifAdminStatus is changed to enable (1), then ifOperStatus should change to enable (1), if the interface is ready to transmit and receive network traffic. Interface will have the OperStatus value as dormant (5) if the 'configstatus' of the entry is 'config' and the interface is waiting for a packet to be sensed to get activated. |
| <b>Last Change</b>        | Value of System UpTime (in seconds) at the time the interface entered its current operational state.   |
| <b>Unknown Prot Pkts</b>  | The number of packets received via the interface, which were discarded because of an unknown or unsupported protocol.  |
| <b>In Octets</b>          | The total number of octets received on the interface, including the framing characters. For Ethernet interfaces, this will have the lower 32 bits of HC in octets. Valid for atm-*, eoa-*, aal5-*, eth-0, eth-1, dsl-*, dslf-*, dsli-*, aggr-*.  |
| <b>Out Octets</b>         | The total number of octets transmitted out of the interface, including framing characters. For Ethernet interfaces, this will have the lower 32 bits of HC Out octets. Valid for atm-*, eoa-*, aal5-*, eth-0, eth-1, dsl-*, dslf-*, dsli-*, aggr-*.  |
| <b>In Discards</b>        | The number of inbound packets, which were discarded, though no errors were detected.   |

|                           |   |
|---------------------------|---|
| <b>Out Discards</b>       | The number of outbound packets chosen to be discarded even though there were no errors.   |
| <b>In Errors</b>          | The number of inbound packets, which were not delivered to upper layers because of errors.  |
| <b>Out Errors</b>         | The number of outbound packets chosen to be discarded because there were errors.  |
| <b>In Ucast Pkts</b>      | The number of unicast packets delivered to a higher layer protocol.   |
| <b>Out Ucast Pkts</b>     | The total number of packets requested to be sent to unicast addresses, by upper layer protocols.  |
| <b>HC In Octets</b>       | The total number of octets received on the interface, including framing characters. This object is a 64-bit version of <b>ifInOctets</b> . Discontinuities in the value of this counter can occur at re-initialization of the management system, and at other times, as indicated by the value of <b>ifCounterDiscontinuityTime</b> . Valid for eth-*.  |
| <b>HC OutOctets</b>       | The total number of octets transmitted out of the interface, including framing characters. This object is a 64-bit version of <b>ifOutOctets</b> . Discontinuities in the value of this counter can occur at re-initialization of the management system, and at other times, as indicated by the value of <b>ifCounterDiscontinuityTime</b> . Valid for eth-*.  |
| <b>In Mcast Pkts</b>      | The number of multicast packets delivered to a higher layer protocol.   |
| <b>Out Mcast Pkts</b>     | The total number of packets requested to be sent to multicast addresses, by upper layer protocols.  |
| <b>In Bcast Pkts</b>      | The number of broadcast packets delivered to a higher layer protocol.   |
| <b>Out Bcast Pkts</b>     | The total number of packets requested to be sent to broadcast addresses, by upper layer protocols.  |
| <b>LinkUpDnTrapEnable</b> | Indicates whether linkUp/ linkDown traps should be generated for this interface.  |
| <b>Promiscuous Mode</b>   | This object has a value of false if this interface only accepts packets/frames that are addressed to this station. This object has a value of true when the station accepts all packets/frames transmitted on the media. The value true is legal only for Ethernet interfaces. The value of PromiscuousMode does not affect the reception of broadcast and multicast packets/frames by the interface. |
| <b>Connector Present</b>  | This indicates whether the interface sublayer has a physical connector or not. This is true only for physical Ethernet interfaces.  |
| <b>CounterDiscontTime</b> | The value of <b>sysUpTime</b> on the most recent occasion, at which any one or more of this interface's counters suffered a discontinuity.  |

### 5.15.1.2 Reset interface stats

**Description:**

Use this command to reset the statistics of Ethernet, EoA, ATM, AAL5, DSL, DSLF, DSLI, Aggr and EHDLC interfaces.

**Command Syntax:**

**reset interface stats ifname**<interface-name>

### 5.15.1.3 Get interface config

**Description:**

Use this command to view Interface Configuration.

**Command Syntax:**

**get interface config ifname** <interface-name>

### 5.15.1.4 Modify interface config

**Description:**

Use this command to modify interface configuration.

**Command Syntax:**

**modify interface config ifname** <interface-name> [**trap** enable|disable]

**Parameters:**

| Name                              | Description  |
|-----------------------------------|--|
| <b>ifname</b><br><interface-name> | Interface name, for which configuration is to be modified or viewed.<br><b>Type:</b> Get -Optional Modify - Mandatory<br><b>Valid values:</b> eth-*, atm-*, aal5-*, eoa-*, dsl-*, dslf-*, dsl-*, aggr-*, ehdlc-* |
| <b>trap enable disable</b>        | Indicates whether linkUp/linkDown traps should be generated for this interface.<br><b>Type:</b> Modify – Optional<br><b>Valid values :</b> enable or disable   |

**Example:**

\$ get interface Config

**Output:**

Verbose Mode On

IfName LinkUp/DnTrap

-----

aal5-0 Enable

**Output Fields:**

| FIELD         | Description  |
|---------------|--|
| IfName        | Interface name, for which configuration is to be viewed.                       |
| LinkUp/DnTrap | Indicates whether linkUp/linkDown traps shall be generated for this interface. |

**Caution:**

- Reset of ATM VC interface stats also result in atm vc stat reset for the interface and reset of Ethernet interface stats also result in dot3stats reset for the ethernet interface.

**References**

- ATM Interface commands
- Ethernet commands
- EoA commands
- DSL commands

## 5.16 IP Commands

---

### 5.16.1 IP Net to Media Table Commands

#### 5.16.1.1 Get arp

**Description:**

Use this command to display either the full ARP table or a single entry.

**Command Syntax:**

**get arp** [rid <rid-val>] [ip <ip-address>]

#### 5.16.1.2 Create arp

**Description:**

Use this command to create a static entry in the ARP Table.

**Command Syntax:**

**create arp** [rid <rid-val>] ip <ip-address> macaddr <mac-address>

#### 5.16.1.3 Delete arp

**Description:**

Use this command to delete an entry from the ARP table.

**Command Syntax:**

**delete arp** [rid <rid-val>] ip <ip-address>

**Parameters:**

| Name          | Description   |
|---------------|---|
| rid <rid-val> | RID refers to the Routing Information Database. This database contains information about the routes in the system. Each RID identifies a flow and defines route related information for that flow. The RID defines a flow based on the VLAN Id. The database can be of 2 types, IRD (Independent Routing Database) where there are more than one RIDs in the system and each RID defines separate routes in context of itself. . If VlanId <X> and RID <X> have been created and the routing database is configured for IRD, than routes in RID <X> shall define flow for packets coming on VLAN Id <X>. The other mode for the database is SRD (Shared Routing |

|                              |   |
|------------------------------|---|
|                              | <p>Database) where there is a single RID in the system and all flows map to this RID. This RID has to be explicitly created and no more than one RID can be created in the system in this mode. Flows for all created VLANs shall map to this RID for routing.</p> <p><b>Type:</b> Create — Optional<br/>Delete — Mandatory<br/>Get — Optional</p> <p><b>Valid values:</b> 0 - 4095</p> |
| <b>ip</b> <ip-address>       | <p>IP address corresponding to the media-dependent physical address.</p> <p><b>Type:</b> Create — Mandatory<br/>Delete — Mandatory<br/>Get — Optional</p> <p><b>Valid values:</b> 0.0.0.0 - 223.255.255.255</p>   |
| <b>macaddr</b> <mac-address> | <p>The media-dependent physical address</p> <p><b>Type:</b> Create — Mandatory</p> <p><b>Valid values:</b> 0:0:0:0:0:1 - ff:ff:ff:ff:fe</p>   |

**Example:**

```
$ create arp rid 1 ip 192.168.161.11 macaddr 00:11:22:33:44:55
```

**Output:**

```
Verbose Mode On
Entry Created
```

```
RID          : 1          lfname       : -
Type         : static    Mac Address  : 00:11:22:33:44:55
Ip Address.  : 192.168.161.11
```

```
Verbose Mode Off:
Entry Created
```

**Output Fields:**

| FIELD      | Description  |
|------------|--|
| <b>RID</b> | RID refers to the Routing Information Database. This database contains information about the routes in the system. Each RID identifies a flow and defines route related information for that flow. The RID defines a flow based on the VLAN Id. The database can be of 2 types, IRD( Independent Routing Database) where there are more than one RIDs in |

|                    |   |
|--------------------|---|
|                    | <p>the system and each RID defines separate routes in context of itself. . If VlanId &lt;X&gt; and RID &lt;X&gt; have been created and the routing database is configured for IRD, than routes in RID &lt;X&gt; shall define flow for packets coming on VLAN Id &lt;X&gt;. The other mode for the database is SRD( Shared Routing Database) where there is a single RID in the system and all flows map to this RID. This RID has to be explicitly created and no more than one RID can be created in the system in this mode. Flows for all created VLANs shall map to this RID for routing.</p> |
| <b>Ifname</b>      | This specifies the physical interface for the media. It indicates the interface over which the IP address for which the IP Net to media mapping has been created can be reached.  |
| <b>Ip Address.</b> | IP address corresponding to the media-dependent physical address.   |
| <b>Type</b>        | This defines the type of mapping in use. The value Invalid has the effect that this entry is not used. It may be: Static, Dynamic, Other  |
| <b>Mac Address</b> | The media-dependent physical address  |

### Cautions:

- The specified interface should pre-exist. Please refer to the create ethernetintf command.

### References:

- delete arp command
- get arp command
- create ethernet intf command
- ip route related commands

## 5.16.2 IP Route Commands

### 5.16.2.1 Get ip route

**Description:**Use this command to get.

### Command Syntax:

**get ip route [rid <rid-val>] ip <dest-ip-address> mask <net-mask>**

### 5.16.2.2 Create up route

#### Description:

Use this command to create.

#### Command Syntax:

```
create ip route [rid <rid-val>] ip <dest-ip-address> mask mask <net-mask>
gwyip <gwy-ip-address> [ifname <interface-name> | anywan] [proxyarpstatus
enable | disable]
```

### 5.16.2.3 Delete ip route

#### Description:

Use this command to create a routing table entry.

#### Command Syntax:

```
delete ip route [rid <rid-val>] ip <dest-ip-address> mask mask <net-mask>
```

#### Parameters:

| Name                 | Description  |
|----------------------|--|
| rid <rid-val>        | <p>RID refers to the Routing Information Database. This database contains information about the routes in the system. Each RID identifies a flow and defines route related information for that flow. The RID defines a flow based on the VLAN Id. The database can be of 2 types, IRD (Independent Routing Database) where there are more than one RIDs in the system and each RID defines separate routes in context of itself. If VlanId &lt;X&gt; and RID &lt;X&gt; have been created and the routing database is configured for IRD, than routes in RID &lt;X&gt; shall define flow for packets coming on VLAN Id &lt;X&gt;. The other mode for the database is SRD ( Shared Routing Database) where there is a single RID in the system and all flows map to this RID. This RID has to be explicitly created and no more than one RID can be created in the system in this mode. Flows for all created VLANs shall map to this RID for routing.</p> <p><b>Type:</b> Create – Optional<br/>Delete – Optional<br/>Modify – Mandatory<br/>Get – Optional</p> <p><b>Valid values:</b> 0 - 4095</p> |
| ip <dest-ip-address> | Destination IP address of this route.  |



|   |   |
|---|---|
|   | <p><b>Type:</b> Create – Mandatory<br/>Delete – Mandatory<br/>Modify – Mandatory<br/>Get – Optional</p> <p><b>Valid values:</b> 0.0.0.0 - 223.255.255.0</p>   |
| <b>mask</b> <net-mask>                        | <p>Indicates the mask to be logical-ANDed with the destination address before being compared to the value in the ipRouteDest field. Only absolute routes can be added in the downstream direction for the IPOE interfaces (gsvIpRouteIfIndex as ipoe-*). The mask for all such routes has to be 255.255.255.255. The creation of default route in upstream (gsvIpRouteIfIndex as GS_CFG_ANY_WAN) can have the mask as 0.0.0.0 only.</p> <p><b>Type:</b> Create – Mandatory<br/>Delete – Mandatory<br/>Modify – Mandatory<br/>Get – Optional</p> <p><b>Valid values:</b> 0.0.0.0 - 255.255.255.0</p> |
| <b>gwyip</b><br><gwy-ip-address>              | <p>The IP address of the next hop of this route. Only absolute routes can be added in the downstream direction for the IPOE interfaces (gsvIpRouteIfIndex as ipoe-*). The next hop in such cases has to be same as the destination IP address (gsvIpRouteDest) specified.</p> <p><b>Type:</b> Create – Mandatory</p> <p><b>Valid values:</b> 0.0.0.0 - 223.255.255.0</p>  |
| <b>ifname</b><br><interface-name>  <br>anywan | <p>The index value which uniquely identifies the local interface through which the next hop of this route should be reached. If IpRouteRid is not 0, than u32IpRouteIfIndex shall be mandatory to be specified in the "create ip route" command. The ifname value can be either ANYWAN (0xffffffff) or ifindex of any of the ipoe interface (ipoe-*).</p> <p><b>Type:</b> Create – Optional<br/>Modify – Optional</p>   |
| <b>proxyarpstatus</b> enable<br> disable      | <p>This specifies if the Proxy ARP has to be done for this iproute table entry. If IpRouteRid value is 0, then ProxyArpStatus will not be specified while creating/modifying an entry in IpRoute Table.</p> <p><b>Type:</b> Create – Optional<br/>Modify – Optional</p> <p><b>Default value:</b> disable</p>  |

**Example:**

```
$ create ip route rid 0 ip 192.168.161.12 mask 255.255.0.0 gwyp 172.26.6.100
ifname eth-0 routetype DIR ProxyArpStatus disable configstatus Auto
```

**Output:**

```
Verbose Mode On
Entry Created
```

```
Rid           : 0           Destination : 192.168.161.12
Net Mask      : 255.255.0.0 Gateway       : 172.26.6.100
Ifname       : eth-0      Route Type  : DIR
Route Orig   : LCL       Age         : 0
ProxyArpStatus : disable
Verbose Mode Off:
Entry Created
```

**Output Fields:**

| FIELD              | Description   |
|--------------------|---|
| <b>Rid</b>         | RID refers to the Routing Information Database. This database contains information about the routes in the system. Each RID identifies a flow and defines route related information for that flow. The RID defines a flow based on the VLAN Id. The database can be of 2 types, IRD (Independent Routing Database) where there are more than one RIDs in the system and each RID defines separate routes in context of itself. If VlanId <X> and RID <X> have been created and the routing database is configured for IRD, than routes in RID <X> shall define flow for packets coming on VLAN Id <X>. The other mode for the database is SRD( Shared Routing Database) where there is a single RID in the system and all flows map to this RID. This RID has to be explicitly created and no more than one RID can be created in the system in this mode. Flows for all created VLANs shall map to this RID for routing. |
| <b>Destination</b> | Destination IP address of this route.   |
| <b>Net Mask</b>    | Indicates the mask to be logical-ANDed with the destination address before being compared to the value in the ipRouteDest field. Only absolute routes can be added in the downstream direction for the IPOE interfaces (gsvIpRouteIfIndex as ipoe-*). The mask for all such routes has to be 255.255.255.255. The creation of default route in upstreamcan has the mask as 0.0.0.0 only.  |
| <b>Gateway</b>     | The IP address of the next hop of this route. Only absolute routes  |

|                       |   |
|-----------------------|---|
|                       | can be added in the downstream direction for the IPOE interfaces (gsvIpRouteIfIndex as ipoe-*). The next hop in such cases has to be same as the destination IP address (gsvIpRouteDest) specified.   |
| <b>Ifname</b>         | The index value which uniquely identifies the local interface through which the next hop of this route should be reached. If IpRouteRid is not GS_CFG_MGMT_RID, than u32IpRouteIfIndex shall be mandatory to be specified in the "create ip route" command. The ifname value can be either ANYWAN or ifindex of any of the ipoe interface (ipoe-*). |
| <b>Route Type</b>     | The type of route. It may be: dir (for Direct) or ind (for Indirect).   |
| <b>Route Orig</b>     | The routing mechanism, through which this route was learned. It may be: NET (for Network Management), LCL (for Local), RIP, ICMP,DYI (Dynamic through Interface creation).  |
| <b>Age</b>            | The number of seconds since this route was last updated or otherwise determined to be correct.  |
| <b>ProxyArpStatus</b> | This specifies if the Proxy ARP has to be done for this iproute table entry.If IpRouteRid value is 0, then ProxyArpStatus will not be specified while creating/modifying an entry in IpRoute Table.   |

#### References:

- get ip route command
- delete ip route command
- arp related commands.

### 5.16.3 Ipoa intf Commands

#### 5.16.3.1 Get ipoa intf

##### Description:

Use this command to get.

##### Command Syntax:

```
get ipoa intf [ifname <interface-name>]
```

#### 5.16.3.2 Create ipoa intf

##### Description:

Use this command to create.

**Command Syntax:**

**create ipoa intf ifname** <interface-name> **lowif** <lowif-val> [**configstatus**  
Normal | Config] [enable|disable]

**5.16.3.3 Delete ipoa intf****Description:**

Use this command to delete.

**Command Syntax:**

**delete ipoa intf ifname** <interface-name>

**5.16.3.4 Modify ipoa intf****Description:**

Use this command to modify.

**Command Syntax:**

**modify ipoa intf ifname** <interface-name> [enable|disable]

**Parameters:**

| Name   | Description  |
|--|--|
| <b>ifname</b><br><interface-name>            | The Ipoa Interface<br><br><b>Type:</b> Create – Mandatory<br>Delete – Mandatory<br>Modify – Mandatory<br>Get – Optional<br><br><b>Valid values:</b> 0 -575   |
| <b>lowif</b> <lowif-val>                     | This specifies the name of the lower AAL5 interface.<br><br><b>Type:</b> Create – Mandatory<br><br><b>Valid values:</b> 0 - 574  |
| <b>configstatus Normal</b><br><b> Config</b> | This mode describes the configuration status for this interface. If the "config" bit is set then this interface shall be created but will have a dormant status. Only after the receipt of an Ipoa packet from CPE side this interface shall become active. The "In-Use" and "Not-In-Use" bits are read only bits. The "Not-In-Use" indicates that the entry is dormant and "In-Use" indicates that the entry is activated.<br><br><b>Type:</b> Create – Optional<br><br><b>Default value:</b> NormalEntry |

|                       |  |
|-----------------------|--|
| <b>enable disable</b> | Administrative status of the interface.<br><b>Type:</b> Optional<br><b>Valid values:</b> enable or disable |
|-----------------------|--|

**Example:**

```
$ create ipoa intf ifname Ipoa-0 lowif aal5-0 configstatus Normal enable
```

**Output:**

```
Verbose Mode On
Entry Created
```

```
Ifname          : Ipoa-0      Low IfName     : aal5-0
Config Status  : Normal
Oper Status    : Up          Admin Status   : Enable
Verbose Mode Off:
Entry Created
```

**Output Fields:**

| FIELD                | Description   |
|----------------------|---|
| <b>Ifname</b>        | The Ipoa Interface  |
| <b>Low IfName</b>    | This specifies the name of the lower AAL5 interface.  |
| <b>Config Status</b> | This mode describes the configuration status for this interface. If the "config" bit is set then this interface shall be created but will have a dormant status. Only after the receipt of an Ipoa packet from CPE side this interface shall become active. The "In-Use" and "Not-In-Use" bits are read only bits. The "Not-In-Use" indicates that the entry is dormant and "In-Use" indicates that the entry is activated. |
| <b>Admin Status</b>  | Administrative status of the interface.   |
| <b>Oper Status</b>   | Operational status of the interface.  |

## 5.16.4 Ipoe intf Commands

### 5.16.4.1 Get ipoe intf

**Description:**

Use this command to get.

**Command Syntax:**

```
get ipoe intf [ifname <interface-name>]
```

### 5.16.4.2 Create ipoe intf

**Description:**

Use this command to create.

**Command Syntax:**

```
create ipoe intf ifname <interface-name> lowif <lowif-val> macaddrprof  
<macaddrprof-val> [ethpkttype Type2 | 802_3] [inactivitytmrintrvl  
<inactivitytmrintrvl-val>] [routingstatus enable | disable] [enable | disable]
```

### 5.16.4.3 Delete ipoe intf

**Description:**

Use this command to delete.

**Command Syntax:**

```
delete ipoe intf ifname <interface-name>
```

### 5.16.4.4 Modify ipoe intf

**Description:**

Use this command to modify.

**Command Syntax:**

```
modify ipoe intf ifname <interface-name> lowif <lowif-val> macaddrprof  
<macaddrprof-val> [ethpkttype Type2 | 802_3] [inactivitytmrintrvl  
<inactivitytmrintrvl-val>] [routingstatus enable | disable] [enable | disable]
```

## Parameters:

| Name  | Description  |
|---|--|
| <b>ifname</b><br><interface-name>                 | The IPOE Tunneling Interface.<br><b>Type:</b> Create – Mandatory<br>Delete – Mandatory<br>Modify – Mandatory<br>Get – Optional<br><b>Valid values:</b> 0-575   |
| <b>lowif</b> <lowif-val>                          | This specifies the lower interface index.It contains the ifindex of the IPoA interface.<br><b>Type:</b> Create – Mandatory<br><b>Valid values:</b> 0 – 575   |
| <b>macaddrprof</b><br>macaddrprof                 | Profile Id corresponding to the MAC address assigned to this IPOE interface. This Profile is created using the MacAddrProfileTable.<br><b>Type:</b> Create – Mandatory<br>Modify – Optional<br><b>Valid values:</b> 1 -8   |
| <b>ethpkttype</b> Type2   802_3                   | This specifies the type of the Packet.<br><b>Type:</b> Create – Optional<br>Modify – Optional<br><b>Default value:</b> Type2   |
| <b>inactivitytmrintrvl</b><br>inactivitytmrintrvl | This field specifies the time (in seconds) after which interfaces shall be marked inactive, if there is no data activity on this interface during this interval. This is used only when the bit corresponding to "ConfigEntry" is set for gsvlpoeConfigStatus field. A value of zero means the timer is not running. In autosensing scenario, an inactive interface is a candidate to deletion, if another protocol is sensed on Atm Vc Interface on which this interface is created<br><b>Type:</b> Create – Optional<br>Modify – Optional<br><b>Valid values:</b> 0- 0xffffffff<br><b>Default value:</b> 0 |
| <b>routingstatus</b> enable  disable              | This specifies if the IP Routing Lookup has to be done for this interface. By default, for the downstream traffic destined for IPOE interface, IP lookup is done based on the downstream route configured for the IPOE interface.If iproutingstatus is disabled, layer 2 lookup shall be used instead, for forwarding the downstream traffic for this IPOE interface.  |

|                       |  |
|-----------------------|--|
|                       | <b>Type:</b> Create – Optional<br>Modify – Optional<br><b>Default value:</b> enable                        |
| <b>enable disable</b> | Administrative Status of the interface.<br><b>Type:</b> Optional<br><b>Valid values:</b> enable or disable |

**Example:**

```
$ create ipoe intf ifname Ipoe-0 lowif Ipoa-0 macaddrprof 1 ethpkttype Type2
inactivitytmrintrvl 10 routingstatus disable cfgmode Auto enable
```

**Output:**

Verbose Mode On

Entry Created

Ifname : Ipoe-0 Low If Name : Ipoa-0

Mac Addr Prof : 1 Eth Pkt Type : Type2

InActivity Tmr Interval : 10

RoutingStatus : disable

Oper Status : Up Admin Status : Enable

Verbose Mode Off:

Entry Created

**Output Fields:**

| FIELD                          | Description  |
|--------------------------------|--|
| <b>Ifname</b>                  | The IPOE Tunneling Interface.  |
| <b>Low If Name</b>             | This specifies the lower interface index.It contains the ifindex of the IPoA interface.  |
| <b>Mac Addr Prof</b>           | Profile Id corresponding to the MAC address assigned to this IPOE interface. This Profile is created using the MacAddrProfileTable.  |
| <b>Eth Pkt Type</b>            | This specifies the type of the Packet.   |
| <b>InActivity Tmr Interval</b> | This field specifies the time (in seconds) after which interfaces shall be marked inactive, if there is no data activity on this interface during this interval. This is used only when the bit corresponding to "ConfigEntry" is set for gsvlpoeConfigStatus field. A value of zero means the timer is not running. In autosensing scenario, an inactive interface is a candidate to deletion, if another protocol is sensed on Atm Vc Interface on which this interface is created |



|                      |  |
|----------------------|--|
| <b>RoutingStatus</b> | This specifies if the IP Routing Lookup has to be done for this interface. By default, for the downstream traffic destined for IPOE interface, IP lookup is done based on the downstream route configured for the IPOE interface. If iproutingstatus is disabled, layer 2 lookup shall be used instead, for forwarding the downstream traffic for this IPOE interface. |
| <b>Admin Status</b>  | Administrative status of the interface.  |
| <b>Oper Status</b>   | Operational status of the interface.   |

## 5.16.5 Rid static Commands

### 5.16.5.1 Create rid static

**Description:**

Use this command to create.

**Command Syntax:**

**create rid static rid <rid-val>**

### 5.16.5.2 Delete rid static

**Description:**

Use this command to delete.

**Command Syntax:**

**delete rid static rid <rid-val>**

**Parameters:**

| Name          | Description  |
|---------------|--|
| rid <rid-val> | RID refers to the Routing Information Database. This database contains information about the routes in the system. Each RID identifies a flow and defines route related information for that flow. The RID defines a flow based on the VLAN Id. The database can be of 2 types, IRD (Independent Routing Database) where there are more than one RIDs in the system and each RID defines separate routes in context of itself. If VlanId <X> and RID <X> have been created and the routing database is configured for IRD, than routes in RID <X> shall define |

|  |  |
|--|--|
|  | <p>flow for packets coming on VLAN Id &lt;X&gt;. The other mode for the database is SRD( Shared Routing Database) where there is a single RID in the system and all flows map to this RID.</p> <p>This RID has to be explicitly created and no more than one RID can be created in the system in this mode.</p> <p>Flows for all created VLANs shall map to this RID for routing. A value of RID as 0 has a special meaning. RID value 0 refers to management RID and all entries created in context of RID value 0 shall be for routes related to the management/control. In Stacked Vlan Mode the Vlan Corresponding to RID is Virtual Vlan while in Native Vlan mode this is normal Vlan(C-VLAN).</p> <p><b>Type:</b> Create – Mandatory<br/> Delete – Mandatory<br/> Get – Optional</p> <p><b>Valid values:</b> 1 - 4095</p> |
|--|--|

**Example:**

```
$ create rid static rid 1
```

**Output:**

```
Verbose Mode On
Entry Created
```

```
RID : 1
```

Verbose Mode Off:

```
Entry Created
```

**Output Fields:**

| FIELD | Description  |
|-------|--|
| RID   | RID refers to the Routing Information Database. This database contains information about the routes in the system. Each RID identifies a flow and defines route related information for that flow. The RID defines a flow based on the VLAN Id. The database can be of 2 types, IRD (Independent Routing Database) where there are more than one RIDs in the system and each RID |

|  |   |
|--|---|
|  | <p>defines separate routes in context of itself. . If VlanId &lt;X&gt; and RID &lt;X&gt; have been created and the routing database is configured for IRD, than routes in RID &lt;X&gt; shall define flow for packets coming on VLAN Id &lt;X&gt;. The other mode for the database is SRD( Shared Routing Database) where there is a single RID in the system and all flows map to this RID.</p> <p>This RID has to be explicitly created and no more than one RID can be created in the system in this mode. Flows for all created VLANs shall map to this RID for routing. A value of RID as 0 has a special meaning. RID value 0 refers to management RID and all entries created in context of RID value 0 shall be for routes related to the management/control. In Stacked Vlan Mode the Vlan Corresponding to RID is Virtual Vlan while in Native Vlan mode this is normal Vlan(C-VLAN).</p> |
|--|---|

## 5.17 MacProfile Commands

---

### 5.17.1 Macprofile globale Commands

#### 5.17.1.1 Get macprofile global

**Description:**

Use this command to get.

**Command Syntax:**

**get macprofile global [profileid <profileid-val>]**

#### 5.17.1.2 Create macprofile global

**Description:**

Use this command to create.

**Command Syntax:**

**create macprofile global profileid <profileid-val>macaddr <macaddr-val>**

#### 5.17.1.3 Delete macprofile global

**Description:**

Use this command to delete.

**Command Syntax:**

**get macprofile global profileid <profileid-val>**

**Parameters:**

| Name                             | Description   |
|----------------------------------|---|
| <b>profileid</b> <profileid-val> | Profile Id of the MAC Address configured.<br><b>Type:</b> Create -- Mandatory<br>Delete -- Mandatory<br>Get -- Optional<br><b>Valid values:</b> 1 - 8 |
| <b>macaddr</b> <macaddr-val>     | MAC Address for the profile.<br><b>Type:</b> Create -- Mandatory  |

**Example:**

```
$ create macprofile global profileid 3 macaddr 00:30:4F:61:C1:BE
```

**Output:**

Verbose Mode On  
Entry Created

Profile Id MAC Address

-----  
3            00:30:4F:61:C1:BE

Verbose Mode Off:  
Entry Created

**Output Fields:**

| FIELD       | Description                               |
|-------------|---|
| Profile Id  | Profile Id of the MAC Address configured. |
| MAC Address | MAC Address for the profile.              |

## 5.17.2 Resvdmac profile info Commands

### 5.17.2.1 Get resvdmac profile info

**Description:**

Use this command to get.

**Command Syntax:**

**get resvdmac profile info [profileid <profileid-val>]**

### 5.17.2.2 Create resvdmac profile info

**Description:**

Use this command to create.

**Command Syntax:**

**create resvdmac profile info profileid <profileid-val>**

### 5.17.2.3 Delete resvdmac profile info

**Description:**

Use this command to delete.

**Command Syntax:**

```
delete resvdmac profile info profileid <profileid-val>
```

**Parameters:**

| Name                      | Description   |
|---------------------------|---|
| profileid <profileid-val> | Profile Id of the MAC Address configured.<br><b>Type:</b> Create -- Mandatory<br>Delete -- Mandatory<br>Get -- Optional<br><b>Valid values:</b> 1 - 8 |

**Example:**

```
$ create resvdmac profile info profileid 4
```

**Output:**

```
Verbose Mode On
Entry Created
```

```
Profile ID : 4
```

```
Verbose Mode Off:
Entry Created
```

**Output Fields:**

| FIELD      | Description                               |
|------------|---|
| Profile Id | Profile Id of the MAC Address configured. |

**5.17.3 Resvdmac profile param Commands****5.17.3.1 Get resvdmac profile param****Description:**

Use this command to get.

**Command Syntax:**

```
get resvdmac profile param [profileid <profileid-val>] [mcastaddr
<mcastaddr-val>]
```

### 5.17.3.2 Create resvdmac profile param

**Description:**

Use this command to create.

**Command Syntax:**

```
create resvdmac profile param profileid <profileid-val>mcastaddr  
<mcastaddr-val>action Drop | TransformedBcast | Participate
```

### 5.17.3.3 Delete resvdmac profile param

**Description:**

Use this command to delete.

**Command Syntax:**

```
get resvdmac profile param profileid <profileid-val> mcastaddr  
<mcastaddr-val>
```

**Parameters:**

| Name  | Description   |
|---|---|
| <b>profileid</b> <profileid-val>                          | Profile Id of the MAC Address configured.<br><b>Type:</b> Create -- Mandatory<br>Delete -- Mandatory<br>Get -- Optional<br><b>Valid values:</b> 1 - 8   |
| <b>mcastaddr</b><br><mcastaddr-val>                       | This is Reserved Multicast address. This multicast address can only be 00:30:4F:00:00:xx, where 'xx' lies between 00-0f and 20-2f.<br><b>Type:</b> Create -- Mandatory<br>Delete -- Mandatory<br>Get -- Optional  |
| <b>action</b> Drop  <br>TransformedBcast  <br>Participate | This is the action corresponding to reserved multicast address.<br>'Drop' action leads to dropping of corresponding frames.<br>'TransformedBcast' leads to sending of the frames broadcasted over all the ports as if for a broadcast frame (bridging restrictions, filtering, transformations shall apply). 'Participate' action leads to frame coming to Control Plane and it shall be given to the registered protocol module.<br><b>Type:</b> Create -- Mandatory |

**Example:**

```
$ create resvdmac profile param Profileid 4 mcastaddr 00:30:4f:00:00:00 action Drop
```

**Output**

```
Verbose Mode On  
Entry Created
```

```
Profile ID : 4           Multicast address : 00:30:4f:00:00:00  
Action       : Drop
```

```
Verbose Mode Off:  
Entry Created
```

**Output Fields:**

| FIELD                    | Description   |
|--------------------------|---|
| <b>Profile Id</b>        | Profile Id of the MAC Address configured.   |
| <b>Multicast address</b> | This is Reserved Multicast address. This multicast address can only be 00:30:4F:00:00:xx, where 'xx' lies between 00-0f and 20-2f.  |
| <b>Action</b>            | This is the action corresponding to reserved multicast address. 'Drop' action leads to dropping of corresponding frames. 'TransformedBcast' leads to sending of the frames broadcasted over all the ports as if for a broadcast frame (bridging restrictions, filtering, transformations shall apply). 'Participate' action leads to frame coming to Control Plane and it shall be given to the registered protocol module. |



## 5.18 Management Traffic Commands

---

### 5.18.1 Ctlpkt group info Commands

#### 5.18.1.1 Get ctlpkt group info

**Description:**

Use this command to get.

**Command Syntax:**

```
get ctlpkt group info [groupid <groupid-val>] [ctflowid <ctflowid-val>]
```

#### 5.18.1.2 Create ctlpkt group info

**Description:**

Use this command to create.

**Command Syntax:**

```
create ctlpkt group info groupid <groupid-val>ctflowid  
<ctflowid-val>instanceid <instanceid-val>]
```

#### 5.18.1.3 Delete ctlpkt group info

**Description:**

Use this command to delete.

**Command Syntax:**

```
delete ctlpkt group info groupid <groupid-val>ctflowid <ctflowid-val>
```

**Parameters:**

| Name                           | Description  |
|--------------------------------|--|
| <b>groupid</b> <groupid-val>   | The control packet group identifier<br><b>Type:</b> Create -- Mandatory<br>Delete -- Mandatory<br>Get -- Optional<br><b>Valid values:</b> 1 - 50 |
| <b>ctflowid</b> <ctflowid-val> | The Control packet flow id.<br><b>Type:</b> Create -- Mandatory<br>Delete -- Mandatory<br>Get -- Optional<br><b>Valid values:</b> 1 - 0x4        |

|                                       |  |
|---------------------------------------|--|
| <b>instanceid</b><br><instanceid-val> | The Control packet instance Id.<br><b>Type:</b> Create -- Mandatory<br><b>Valid values:</b> 1 - 26 |
|---------------------------------------|--|

**Example:**

```
$ create ctlpkt group info groupid 1 ctlflowid 1 instanceid 1
```

**Output:**

```
Verbose Mode On
Entry Created
```

```
Group Id      : 1
Control Flow Id : 1      Instance Id : 1
```

```
Verbose Mode Off:
Entry Created
```

**Output Fields:**

| FIELD                  | Description                         |
|------------------------|-------------------------------------|
| <b>Group Id</b>        | The control packet group identifier |
| <b>Control Flow Id</b> | The Control packet flow id.         |
| <b>Instance Id</b>     | The Control packet instance Id.     |

**References:**

- See Control Packet Instance Group related commands

## 5.18.2 Ctlpkt instance info Commands

### 5.18.2.1 Get ctlpkt instance info

**Description:**

Use this command to get.

**Command Syntax:**

```
get ctlpkt instance info [instanceid <instanceid-val>]
```

### 5.18.2.2 Create ctlpkt instance info

**Description:**

Use this command to create.

**Command Syntax:**

```
create ctlpkt instance info instanceid <instanceid-val>profileid <profileid-val>
classid <classid-val>
```

**5.18.2.3 Delete ctlpkt instance info****Description:**

Use this command to delete.

**Command Syntax:**

```
delete ctlpkt instance info instanceid <instanceid-val>
```

**5.18.2.4 Modify ctlpkt instance info****Description:**

Use this command to modify.

**Command Syntax:**

```
modify ctlpkt instance info instanceid <instanceid-val>profileid <profileid-val>
classid <classid-val>
```

**Parameters:**

| Name                                  | Description   |
|---------------------------------------|---|
| <b>instanceid</b><br><instanceid-val> | The control packets instance id.<br><b>Type:</b> Create -- Mandatory<br>Delete -- Mandatory<br>Modify -- Mandatory<br>Get -- Optional<br><b>Valid values:</b> 1 - 26  |
| <b>profileid</b> <profileid-val>      | This field identifies the control packet profile whose instance is being created.<br><b>Type:</b> Create -- Mandatory<br>Modify -- Optional<br><b>Valid values:</b> 1 - 8                                       |
| <b>classid</b> <classid-val>          | This field specifies the classid of the Instance. Class id shall be treated as the service priority of this instance.<br><b>Type:</b> Create -- Mandatory<br>Modify -- Optional<br><b>Valid values:</b> 1 - 0x4 |

**Example:**

```
$ create ctlpkt instance info instanceid 1 profileid 1 classid 1
```

**Output:**

Verbose Mode On

Entry Created

Instance Id : 1

Profile Id : 1                      Class Id : 1

Verbose Mode Off:

Entry Created

**Output Fields:**

| FIELD       | Description   |
|-------------|---|
| Instance Id | The control packets instance id.  |
| Profile Id  | This field identifies the control packet profile whose instance is being created.                                     |
| Class Id    | This field specifies the classid of the Instance. Class id shall be treated as the service priority of this instance. |

**References:**

- see control packet profile instance related commands

### 5.18.3 Ctlpkt profile info Commands

#### 5.18.3.1 Get ctlpkt profile info

**Description:**

Use this command to get.

**Command Syntax:**

```
get ctlpkt profile info [profileid <profileid-val>]
```

#### 5.18.3.2 Create ctlpkt profile info

**Description:**

Use this command to create.

**Command Syntax:**

```
create ctlpkt profile info profileid <profileid-val>maxctlpkts <maxctlpkts-val>
thrshld1 <thrshld1-val>
```

**5.18.3.3 Delete ctlpkt profile info****Description:**

Use this command to delete.

**Command Syntax:**

```
delete ctlpkt profile info [profileid <profileid-val>]
```

**5.18.3.4 Modify ctlpkt profile info****Description:**

Use this command to modify.

**Command Syntax:**

```
modify ctlpkt profile info profileid <profileid-val> [maxctlpkts <maxctlpkts-val>]
[thrshld1 <thrshld1-val>]
```

**Parameters:**

| Name                                  | Description  |
|---------------------------------------|--|
| <b>profileid</b> <profileid-val>      | The control packet's profile id.<br><br><b>Type:</b> Create -- Mandatory<br>Delete -- Mandatory<br>Modify -- Mandatory<br>Get -- Optional<br><br><b>Valid values:</b> 1 - 8                                  |
| <b>maxctlpkts</b><br><maxctlpkts-val> | This specifies the maximum control packets that can be pending for an instance of this profile.<br><br><b>Type:</b> Create -- Mandatory<br>Modify -- Optional<br><br><b>Valid values:</b> 1 - 63             |
| <b>thrshld1</b> <thrshld1-val>        | This specifies the number of outstanding control packets for each instance, when control plane is congested.<br><br><b>Type:</b> Create -- Mandatory<br>Modify -- Optional<br><br><b>Valid values:</b> 1 -63 |

**Example:**

```
$ create ctlpkt profile info profileid 1 maxctlpkts 32 thrshld1 32
```

**Output:**

Verbose Mode On

Entry Created

Profile Id : 1

Max Ctl Pkts : 32                      Threshold1 : 32

Verbose Mode Off:

Entry Created

**Output Fields:**

| FIELD        | Description  |
|--------------|--|
| Profile Id   | The control packet's profile id.   |
| Max Ctl Pkts | This specifies the maximum control packets that can be pending for an instance of this profile.              |
| Threshold1   | This specifies the number of outstanding control packets for each instance, when control plane is congested. |

**References:**

- See control packet profiles related commands.

## 5.19 PPPoE Tunneling Commands

---

### 5.19.1 PPPoE Global ACprofile Commands

#### 5.19.1.1 Get pppoe global acprofile

**Description:**

Use this command to get.

**Command Syntax:**

**get pppoe global acprofile [profileid <profileid-val>]**

#### 5.19.1.2 Create pppoe global acprofile

**Description:**

Use this command to create.

**Command Syntax:**

**create pppoe global acprofile profileid <profileid-val> acname <acname-val>**

#### 5.19.1.3 Delete pppoe global acprofile

**Description:**

Use this command to delete.

**Command Syntax:**

**delete pppoe global acprofile profileid <profileid-val>**

**Parameters:**

| Name                       | Description  |
|----------------------------|--|
| <b>profileid</b> profileid | Profile Id of the AC Name configured.<br><b>Type:</b> Create — Mandatory<br>Delete — Mandatory<br>Get — Optional<br><b>Valid values:</b> 1 - 8 |
| <b>acname</b> acname       | AC Name for the Session, based on which, the AC is selected.<br><b>Type:</b> Create — Mandatory  |

**Example:**

\$ create pppoe global acprofile profileid 2 acname ABCServer

**Output:**

Verbose Mode On  
Entry Created

Profile Id AC Name

-----

2            ABCServer

Verbose Mode Off:  
Entry Created

**Output Fields:**

| FIELD      | Description  |
|------------|--|
| Profile Id | Profile Id of the AC Name configured.                        |
| AC Name    | AC Name for the Session, based on which, the AC is selected. |

**References:**

- PPPoE global ACprofile related commands.

**5.19.2 PPPoE Global Config Commands****5.19.2.1 Get pppoe global config****Description:**

Use this command to get.

**Command Syntax:**

**get pppoe global config**

**5.19.2.2 Create pppoe global config****Description:**

Use this command to modify.

**Command Syntax:**

**modify pppoe global config [ padimaxnumretries <padimaxnumretries-val> ] [ padrmaxnumretries <padrmaxnumretries-val> ] [ paditxintrvl <paditxintrvl-val> ] [ padrtxintrvl<padrtxintrvl-val> ] [ wandntmrintrvl <wandntmrintrvl-val> ] [ inactivitytmrintrvl <inactivitytmrintrvl-val> ] [ discmaxnumretries <discmaxnumretries-val> ]**



## Parameters:

| Name  | Description   |
|---|---|
| <b>padimaxnumretries</b><br><padimaxnumretries-val>     | Maximum number of times the PPPoE Client sends a PADI for establishing a PPPoE Session.<br><b>Type:</b> Modify – Optional<br><b>Valid values:</b> 1 -10   |
| <b>padrmaxnumretries</b><br><padrmaxnumretries<br>val>  | Maximum number of times the PPPoE Client sends a PADR for establishing a PPPoE Session.<br><b>Type:</b> Modify – Optional<br><b>Valid values:</b> 1 -10   |
| <b>paditxintrvl</b> <paditxintrvl<br>-val>              | The time, n seconds, between PADI retries from the PPPoE Client.<br><b>Type:</b> Modify – Optional<br><b>Valid values:</b> 1 -60  |
| <b>padrtxintrvl</b><br><padrtxintrvl-val>               | The time, n seconds, between PADR retries from the PPPoE Client.<br><b>Type:</b> Modify – Optional<br><b>Valid values:</b> 1 -60  |
| <b>wandntmrintrvl</b><br><wandntmrintrvl-val>           | The time, n seconds, for timeout of the WAN Down Timer. The timer is started when the WAN goes down, and if the timer times out, the session is teared down. A value of zero for this timer means it is not running.<br><b>Type:</b> Modify – Optional<br><b>Valid values:</b> 0 - 0xffffffff |
| <b>inactivitytmrintrvl</b><br><inactivitytmrintrvl-val> | The time, n seconds, for timeout of the Inactivity Timer. The session can remain inactive for atmost these n seconds after which it is teared down. A value of zero means the timer is not running.<br><b>Type:</b> Modify – Optional<br><b>Valid values:</b> 0 - 0xffffffff                  |
| <b>discmaxnumretries</b><br><discmaxnumretries-val>     | The maximum number of times the PPPoE client does a discovery stage for establishing a PPPoE session. A trap is given to GAG on reaching this number.<br><b>Type:</b> Modify – Optional<br><b>Valid values:</b> 1 -5  |

## Example:

```
$ get pppoe global Config
```

**Output:**

Max Total Sessions : 10 PADI Max Num Retries : 10  
PADR Max Num Retries : 10 PADI Tx Interval : 5  
PADR Tx Interval : 5 WAN Dn Tmr Interval : 10  
InActivity Tmr Interval : 20 DISC Max Num Retries : 3

**Output Fields:**

| FIELD                          | Description  |
|--------------------------------|--|
| <b>Max Total Sessions</b>      | Maximum number of PPPoE sessions supported.  |
| <b>PADI Max Num Retries</b>    | Maximum number of times the PPPoE Client sends a PADI for establishing a PPPoE Session.  |
| <b>PADR Max Num Retries</b>    | Maximum number of times the PPPoE Client sends a PADR for establishing a PPPoE Session.  |
| <b>PADI Tx Interval</b>        | The time, n seconds, between PADI retries from the PPPoE Client.   |
| <b>PADR Tx Interval</b>        | The time, n seconds, between PADR retries from the PPPoE Client.   |
| <b>WAN Dn Tmr Interval</b>     | The time, n seconds, for timeout of the WAN Down Timer. The timer is started when the WAN goes down, and if the timer times out, the session is teared down. A value of zero for this timer means it is not running. |
| <b>InActivity Tmr Interval</b> | The time, n seconds, for timeout of the Inactivity Timer. The session can remain inactive for atmost these n seconds after which it is teared down. A value of zero means the timer is not running.                  |
| <b>DISC Max Num Retries</b>    | The maximum number of times the PPPoE client does a discovery stage for establishing a PPPoE session. A trap is given to GAG on reaching this number.  |

**References:**

- PPPoE global config related commands.

## 5.19.3 PPPoE Global Serviceprofile Commands

### 5.19.3.1 Get pppoe global serviceprofile

**Description:**

Use this command to get.

**Command Syntax:**

**get pppoe global serviceprofile [profileid <profileid-val>]**

### 5.19.3.2 Create pppoe global serviceprofile

**Description:**

Use this command to create.

**Command Syntax:**

**create pppoe global serviceprofile profileid <profileid-val> servicename  
<servicename-val>**

### 5.19.3.3 Delete pppoe global serviceprofile

**Description:**

Use this command to delete.

**Command Syntax:**

**delete pppoe global serviceprofile profileid <profileid-val>**

**Parameters:**

| Name                                    | Description  |
|---|--|
| <b>profileid</b> <profileid-val>        | Profile Id of the Service Name configured.<br><b>Type:</b> Create — Mandatory<br>Delete — Mandatory<br>Get — Optional<br><b>Valid values:</b> 1 -4 |
| <b>servicename</b><br><servicename-val> | Service Name for the Session, based on which,<br>the AC is selected.<br><b>Type:</b> Create — Mandatory  |

**Example:**

\$ create pppoe global serviceprofile profileid 1 servicename any

**Output:**

Verbose Mode On  
Entry Created

Profile Id Service Name

-----

1           any

Verbose Mode Off:  
Entry Created

**Output Fields:**

| FIELD        | Description   |
|--------------|---|
| Profile Id   | Profile Id of the Service Name configured.                        |
| Service Name | Service Name for the Session, based on which, the AC is selected. |

**References:**

- PPPoE global serviceprofile related commands.

**5.19.4 PPPoE Global Stats Commands****5.19.4.1 Get pppoe global stats****Description:**

Use this command to get.

**Command Syntax:**

**get pppoe global stats**

**Parameters:**

none

**Example:**

\$ get pppoe global stats

**Output:**

|                      |      |                      |      |
|----------------------|------|----------------------|------|
| Active Sessions      | : 10 | Total Sessions       | : 12 |
| Peak Active Sessions | : 12 | Num of PADI Tx       | : 20 |
| Num of PADI Timeouts | : 3  | Num of PADR Tx       | : 15 |
| Num of PADR Timeouts | : 2  | Num of PADT Tx       | : 2  |
| Num of PADT Rx       | : 3  | Num of PADT Rejected | : 1  |

Num of PADO Rx : 2                      Num of PADO Rejected : 1  
 Num of PADS Rx : 12                      Num of PADS Rejected : 0  
 Num of Malformed Pkts Rx : 2

### Output Fields:

| FIELD                           | Description  |
|---------------------------------|--|
| <b>Active Sessions</b>          | The number of active pppoe sessions in the system.             |
| <b>Total Sessions</b>           | The total number of PPPoE sessions.                            |
| <b>Peak Active Sessions</b>     | Peak number of active PPPoE sessions.                          |
| <b>Num of PADI Tx</b>           | The number of PPPoE PADI transmitted.                          |
| <b>Num of PADI Timeouts</b>     | The number of PPPoE timeouts waiting for a response to a PADI. |
| <b>Num of PADR Tx</b>           | The number of PPPoE PADR transmitted.                          |
| <b>Num of PADR Timeouts</b>     | The number of PPPoE timeouts waiting for a response to a PADR. |
| <b>Num of PADT Tx</b>           | The number of PPPoE PADT transmitted.                          |
| <b>Num of PADT Rx</b>           | The number of PPPoE PADT received.                             |
| <b>Num of PADT Rejected</b>     | The number of PPPoE PADT discarded.                            |
| <b>Num of PADO Rx</b>           | The number of PPPoE PADO received.                             |
| <b>Num of PADO Rejected</b>     | The number of PPPoE PADO discarded.                            |
| <b>Num of PADS Rx</b>           | The number of PPPoE PADS received.                             |
| <b>Num of PADS Rejected</b>     | The number of PPPoE PADS discarded.                            |
| <b>Num of Malformed Pkts Rx</b> | The number of PPPoE malformed packets received.                |

### References:

- PPPoE global stats related commands.

## 5.19.5 Pppoe intf Commands

### 5.19.5.1 Get pppoe intf

#### Description:

Use this command to get.

#### Command Syntax:

```
get pppoe intf [ifname <interface-name>]
```

### 5.19.5.2 Create pppoe intf

#### Description:

Use this command to create.

#### Command Syntax:

```
create pppoe intf ifname <interface-name> lowif <lowif -val>[ wanbridgeport <wanbridgeport-val> ] [ sessionid <sessionid-val> ] [ acmacaddr <acmacaddr-val> ] macaddrprof <macaddrprof-val> [ servicenameprof <servicenameprof-val> | any | anyconfigured ] [ acnameprof <acnameprof-val> | any | anyconfigured ] [ ethpkttype Type2 | 802_3 ] [ nature dynamic | static ] [ enable | disable ]
```

### 5.19.5.3 Delete pppoe intf

#### Description:

Use this command to delete.

#### Command Syntax:

```
delete pppoe intf ifname <interface-name>
```

### 5.19.5.4 Modify pppoe intf

#### Description:

Use this command to modify.

#### Command Syntax:

```
modify pppoe intf ifname <interface-name> lowif <lowif -val>[ wanbridgeport <wanbridgeport-val> ] [ sessionid <sessionid-val> ] [ acmacaddr <acmacaddr-val> ] macaddrprof <macaddrprof-val> [ servicenameprof <servicenameprof-val> | any | anyconfigured ] [ acnameprof <acnameprof-val> | any | anyconfigured ] [ ethpkttype Type2 | 802_3 ] [ nature dynamic | static ] [ enable | disable ]
```

#### Parameters:

| Name                                     | Description  |
|--|--|
| <b>lowif</b> <lowif-val>                 | This specifies the lower interface index. It contains the ifindex of the PPP relay interface.<br><b>Type:</b> Create — Mandatory<br><b>Valid values:</b> 0 - 254 |
| <b>wanbridgeport</b> <wanbridgeport-val> | WAN side bridge port. A value of zero means any WAN side port is acceptable. Currently, only value zero is supported.  |

|  |  |
|--|--|
|  | <p><b>Type:</b> Create — Optional<br/>Modify — Optional</p> <p><b>Default value:</b> 0x0</p>   |
| <p><b>sessionid</b><br/>&lt;sessionid-val&gt;</p>                                      | <p>Session Id for the session given only in case a static session is being created.</p> <p><b>Type:</b> Create — Optional<br/>Modify — Optional</p> <p><b>Valid values:</b> 1 - 0xffff</p> <p><b>Default value:</b> 0x0</p>  |
| <p><b>acmacaddr</b><br/>&lt;acmacaddr-val&gt;</p>                                      | <p>MAC address of the remote AC given only in case a static session is being created.</p> <p><b>Type:</b> Create — Optional<br/>Modify — Optional</p> <p><b>Default value:</b> 00:00:00:00:00:00</p>   |
| <p><b>macaddrprof</b><br/>&lt;macaddrprof-val&gt;</p>                                  | <p>Profile Id for self MAC addresses. The profile for the same is created using the PPPoEMacAddrProfileTable.</p> <p><b>Type:</b> Create — Mandatory<br/>Modify — Optional</p>   |
| <p><b>servicenameprof</b><br/>&lt;servicenameprof-val&gt;<br/>  any  anyconfigured</p> | <p>Profile Id related to Service Name for the Session based on which the AC is selected.The Profile for the same is created using the PPPoESessionProfileTable. A value of "any" means no specific service is needed to select an AC. A value of "anyconfigured"means any configured service name profile can be used for selecting an AC.</p> <p><b>Type:</b> Create — Optional<br/>Modify — Optional</p> <p><b>Valid values:</b> , 0-0xffffffff</p> <p><b>Default value:</b> 0</p>       |
| <p><b>acnameprof</b><br/>&lt;acnameprof-val&gt;  any<br/>  anyconfigured</p>           | <p>Profile Id related to AC Name for the Session based on which the AC is selected. The Profile for the same is created using the PPPoEAcProfileTable. A value of "any" means no specific AC is needed for establishing a session on the WAN side. A value of "anyconfigured"means any configured AC name profile can be used for selecting an AC.</p> <p><b>Type:</b> Create — Optional<br/>Modify — Optional</p> <p><b>Valid values:</b> 0-0xffffffff</p> <p><b>Default value:</b> 0</p> |
| <p><b>ethpkttype</b> Type2  <br/>802_3</p>   | <p>This specifies the type of the packet.</p> <p><b>Type:</b> Create — Optional<br/>Modify — Optional</p>  |

|                                |  |
|--------------------------------|--|
|                                | <b>Default value:</b> Type2  |
| <b>nature</b> dynamic   static | Specifies if the interface is dynamic or static in nature. The session is assumed to be in established state when the interface is static in nature.<br><b>Type:</b> Create — Optional<br>Modify — Optional<br><b>Default value:</b> dynamic |
| enable   disable               | Administrative status of the interface.<br><b>Type:</b> Create — Optional<br>Modify — Optional<br><b>Valid values:</b> enable, disable<br><b>Default value:</b> enable   |

### Example:

```
$ create pppoe intf ifname pppoe-0 lowif ppp-0 wanbridgeport 1 sessionid 10
acmacaddr 00:30:4F:61:C1:BE macaddrprof 1 servicenameprof 2 acnameprof 4
ethpkttype Type2 nature dynamic 0x1 enable
```

### Output:

```
Verbose Mode On
Entry Created
```

```
Ifname           : pppoe-0           Low If Name      : ppp-0
WAN Bridge Port  : 1                 Session Id       : 10
AC Mac Addr      : 00:30:4F:61:C1:BE Mac Addr Prof : 1
Service Name Profile : 2
AC Name Prof     : 4
Eth Pkt Type     : Type2             Nature           : dynamic
Oper Status      : Up                 Admin Status     : Enable
```

```
Verbose Mode Off:
Entry Created
```

### Output Fields

| FIELD                  | Description   |
|------------------------|---|
| <b>Ifname</b>          | The PPPoE Interface.  |
| <b>Low If Name</b>     | This specifies the lower interface index. It contains the ifindex of the PPP relay interface.                         |
| <b>WAN Bridge Port</b> | WAN side bridge port. A value of zero means any WAN side port is acceptable. Currently, only value zero is supported. |



|                             |  |
|-----------------------------|--|
| <b>Session Id</b>           | Session Id for the session given only in case a static session is being created.   |
| <b>AC Mac Addr</b>          | MAC address of the remote AC given only in case a static session is being created.   |
| <b>Mac Addr Prof</b>        | Profile Id for self MAC addresses. The profile for the same is created using the PPPoEMacAddrProfileTable.   |
| <b>Service Name Profile</b> | Profile Id related to Service Name for the Session based on which the AC is selected. The Profile for the same is created using the PPPoESessionProfileTable. A value of "any" means no specific service is needed to select an AC. A value of "anyconfigured" means any configured service name profile can be used for selecting an AC.        |
| <b>AC Name Prof</b>         | Profile Id related to AC Name for the Session based on which the AC is selected. The Profile for the same is created using the PPPoEAcProfileTable. A value of "any" means no specific AC is needed for establishing a session on the WAN side. A value of "anyconfigured" means any configured AC name profile can be used for selecting an AC. |
| <b>Eth Pkt Type</b>         | This specifies the type of the packet.   |
| <b>Nature</b>               | Specifies if the interface is dynamic or static in nature. The session is assumed to be in established state when the interface is static in nature.   |
| <b>Oper Status</b>          | The actual/current state of the interface. It can be either up or down.  |
| <b>Admin Status</b>         | The desired state of the interface. It may be either Up or Down.   |

### References:

- PPPoE session config related commands.

## 5.19.6 PPPoE Session Stats Commands

### 5.19.6.1 Get pppoe session stats

#### Description:

Use this command to get.

#### Command Syntax:

```
get pppoe session stats [ifname <interface-name>]
```

#### Parameters:

| Name                    | Description  |
|-------------------------|--|
| ifname <interface-name> | The PPPoE interface.<br><b>Type:</b> Get -- Optional<br><b>Valid values:</b> 0 - 254 |

#### Example:

```
$ get pppoe session stats ifname pppoe-0
```

#### Output:

```
Ifname                : pppoe-0
Session Id            : 10   Peer Mac Addr       : 00:30:4F:61:C1:BE
Num of PADI Tx        : 4   Num of PADI Timeouts :    2
Num of PADR Tx        : 1   Num of PADR Timeouts :    0
Num of PADT Tx        : 1   Num of PADT Rx       :    1
Num of PADT Rejected  : 1   Num of PADO Rx       :    2
Num of PADO Rejected  : 0   Num of Multi PADO Rx :    1
Num of PADS Rx        : 1   Num of PADS Rejected :    0
Num of Malformed Pkts Rx : 5   Num of Generic Err Rx :    1
Version               : 1   Type                 :    1
Connect Time          : Mon Apr 18 14:00:59 2004
Duration (s)         : 100  AC Cookie :
A1659E40766EDBD7214E18095A5E500C
Host Unique           : 0000003E   State       : sessionStage
Service Name         : dvt   AC Name       : REDBACK
```

## Output Fields:

| FIELD                    | Description   |
|--------------------------|---|
| Ifname                   | The PPPoE interface.  |
| Session Id               | Session Id.   |
| Peer Mac Addr            | MAC address of the remote AC.                                     |
| Num of PADI Tx           | The number of PPPoE PADI transmitted.                             |
| Num of PADI Timeouts     | The number of PPPoE timeouts waiting for a response to a PADI.    |
| Num of PADR Tx           | The number of PPPoE PADR transmitted.                             |
| Num of PADR Timeouts     | The number of PPPoE timeouts waiting for a response to a PADR.    |
| Num of PADT Tx           | The number of PPPoE PADT transmitted.                             |
| Num of PADT Rx           | The number of PPPoE PADT received.                                |
| Num of PADT Rejected     | The number of PPPoE PADT discarded.                               |
| Num of PADO Rx           | The number of PPPoE PADO received.                                |
| Num of PADO Rejected     | The number of PPPoE PADO discarded.                               |
| Num of Multi PADO Rx     | Number of times more than 1 PPPoE PADO was received.              |
| Num of PADS Rx           | The number of PPPoE PADS received.                                |
| Num of PADS Rejected     | The number of PPPoE PADS discarded.                               |
| Num of Generic Err Rx    | Number of generic errors received.                                |
| Version                  | Version as given in the PPPoE rfc-2516.                           |
| Type                     | Type as given in the PPPoE rfc-2516.                              |
| Connect Time             | Time when the session was established.                            |
| Duration (s)             | Number of seconds since the session was established.              |
| AC Cookie                | Binary sequence representing the AC cookie given in negotiations. |
| Host Unique              | Binary sequence representing the host unique tag value.           |
| State                    | State that session is in.   |
| Service Name             | Service name with which the session came up.                      |
| AC Name                  | AC name with which the session came up.                           |
| Num of Malformed Pkts Rx | The number of PPPoE malformed packets received.                   |

## References:

- PPPoE session stats related commands.

## 5.19.7 PPPR Interface Commands

### 5.19.7.1 Get pppr intf

**Description:**

Use this command to get.

**Command Syntax:**

**get pppr intf** [ifname <interface-name>]

### 5.19.7.2 Create pppr intf

**Description:**

Use this command to create.

**Command Syntax:**

**create pppr intf ifname** <interface-name>**lowif** <lowif-val> [ **maxpdu** <maxpdu-val> ] [ **ppprackto** <ppprackto-val>] [ **lowiftoggletimerto** <lowiftoggletimerto-val> ] [ **nature** dynamic | static ] [**configstatus** Normal | Config ] [ **pktpriority** <pktpriority-val> ] [enable | disable]

### 5.19.7.3 Delete pppr intf

**Description:**

Use this command to delete.

**Command Syntax:**

**delete pppr intf ifname** <interface-name>

### 5.19.7.4 Modify pppr intf

**Description:**

Use this command to modify.

**Command Syntax:**

**modify pppr intf ifname** <interface-name> [**ppprackto** <ppprackto-val>] **lowiftoggletimerto** <lowiftoggletimerto-val>] [**nature** dynamic | static] [**pktpriority** <pktpriority-val>] [enable | disable]

## Parameters:

| Name  | Description   |
|---|---|
| <b>ifname</b><br><interface-name>                 | The PPPR interface.<br><b>Type:</b> Create – Mandatory<br>Delete – Mandatory<br>Modify – Mandatory<br>Get – Optional<br><b>Valid values:</b> 0 – 254  |
| <b>lowif</b> <lowif-val>                          | This specifies the name of the lower AAL5 interface.<br><b>Type:</b> Create – Mandatory<br><b>Valid values:</b> 0 - 574   |
| <b>maxpdu</b> <maxpdu-val>                        | This specifies the maximum PDU size on a PPPR interface.<br><b>Type:</b> Create – Optional<br><b>Valid values:</b> 0 - 1492<br><b>Default value:</b> 1492   |
| <b>pprackto</b><br><pprackto-val>                 | Time in seconds to wait for LCP terminate Ack, after sending a terminate request.<br><b>Type:</b> Create – Optional<br>Modify – Optional<br><b>Valid values:</b> 0 -10<br><b>Default value:</b> 5   |
| <b>lowifoggetimerto</b><br><lowifoggetimerto-val> | Time in seconds to wait for lowif to come up without tearing down the pppr session.<br><b>Type:</b> Create – Optional<br>Modify – Optional<br><b>Valid values:</b> 0 – 10<br><b>Default value:</b> 5  |
| <b>nature dynamic   static</b>                    | Specifies if the interface is dynamic or static in nature.<br><b>Type:</b> Create – Optional<br>Modify – Optional<br><b>Default value:</b> Dynamic  |
| <b>configstatus Normal  Config</b>                | This mode describes the configuration status for the interface. If the "config" bit is set, this interface shall be created, but will have a dormant status. Only after the receipt of an pppoa packet from the CPE side, this interface shall become active.<br><b>Type:</b> Create – Optional |

|   |  |
|---|--|
|   | <p>Modify — Optional</p> <p><b>Default value:</b> Normal</p>   |
| <b>enable   disable</b>                 | <p>Administrative status of the interface</p> <p><b>Type:</b> Optional</p> <p><b>Valid values:</b> enable or disable</p> <p><b>Default Value:</b> enable</p>   |
| <b>pktpriority</b><br><pktpriority-val> | <p>Priority to be set in tagged PPPOE frames or PPP packets sent over this port from Control Plane. This priority shall also be used for choice of traffic class/ Queue on outgoing interface whether the frame is tagged or not. In case the bridge port is over an Aggregated ATM VC, this will also be used to identify the VC, on which the packet is to be sent.</p> <p><b>Type:</b> Create — Optional<br/>Modify — Optional</p> <p><b>Valid values:</b> 0 – 7</p> <p><b>Default value:</b> 0</p> |

**Example:**

```
$ create pppr intf ifname pppr-0 lowif aal5-0 maxPdu 1484 ppprAckTO 10
lowifToggleTimerTO 10 nature dynamic configstatus Normal
```

**Output:**

```
Verbose Mode On
Entry Created
```

```
Ifname           : pppr-0      Low IfName       : aal5-0
Max PDU Size     : 1484       Ter Ack TimeOut : 10
Lowif Toggle TimeOut : 10
Nature           : dynamic    Config Status    : Normal
Operational Status : up       Admin Status     : up
PPPOA PacketsPrio:2
Verbose Mode Off:
Entry Created
```

## Output Fields:

| FIELD                       | Description   |
|-----------------------------|---|
| <b>Ifname</b>               | The PPPR interface.   |
| <b>Low IfName</b>           | This specifies the name of the lower AAL5 interface.  |
| <b>Max PDU Size</b>         | This specifies the maximum PDU size on a PPPR interface.  |
| <b>Ter Ack TimeOut</b>      | Time in seconds to wait for LCP terminate Ack, after sending a terminate request.   |
| <b>Lowif Toggle TimeOut</b> | Time in seconds to wait for lowif to come up without tearing down the pppr session.   |
| <b>Nature</b>               | Specifies if the interface is dynamic or static in nature.  |
| <b>Config Status</b>        | This mode describes the configuration status for the interface. If the "config" bit is set, this interface shall be created, but will have a dormant status. Only after the receipt of an pppoa packet from the CPE side, this interface shall become active. The "In-Use" and "Not-In-Use" bits are read-only bits. The "Not-In-Use" bit indicates that the entry is dormant and "In-Use" bit indicates that the entry is activated. |
| <b>Operational Status</b>   | The actual/current state of the interface. It may be either Up or Down.   |
| <b>Admin Status</b>         | The desired state of the interface. It may be either Up or Down.  |
| <b>PPPOA PacketsPrio</b>    | Priority to be set in tagged PPPOE frames or PPP packets sent over this port from Control Plane .This priority shall also be used for choice of traffic class/ Queue on outgoing interface whether the frame is tagged or not.In case the bridge port is over an Aggregated ATM VC, this will also be used to identify the VC, on which the packet is to be sent.   |

## 5.20 IA (Intermeida Agent) Commands

---

### 5.20.1 Dra global stats Commands

#### 5.20.1.1 Get dra global stats

**Description:**

Use this command to get t.

**Command Syntax:**

**get dra global stats**

#### 5.20.1.2 Reset dra global stats

**Description:**

Use this command to reset.

**Command Syntax:**

**reset dra global stats**

**Parameter:**

None

**Example:**

```
$ get dra global stats
```

**Output:**

|                   |      |                  |      |
|-------------------|------|------------------|------|
| DRA Disc Count    | : 40 | DRA Req Count    | : 40 |
| DRA Decline Count | : 30 | DRA Inform Count | : 20 |
| DRA Offer Count   | : 10 | DRA Ack Count    | : 10 |
| DRA Nack Count    | : 50 |                  |      |



## Output field:

| Field                    | Description                               |
|--------------------------|---|
| <b>DRA Disc Count</b>    | Number of DHCP discovery packets received |
| <b>DRA Req Count</b>     | Number of DHCP request packets received   |
| <b>DRA Decline Count</b> | Number of DHCP decline packets received   |
| <b>DRA Inform Count</b>  | Number of DHCP inform packets received    |
| <b>DRA Offer Count</b>   | Number of DHCP offer packets received     |
| <b>DRA Ack Count</b>     | Number of DHCP Ack packets received       |
| <b>DRA Nack Count</b>    | Number of DHCP Nack packets received      |

## References:

DHCP Relay Agent commands

## 5.20.2 Dra instance entry Commands

### 5.20.2.1 Get dra instance entry

#### Description:

Use this command to get.

#### Command Syntax:

```
get dra instance entry [portid <portid-val>] [vlan <vlan-val>]
```

### 5.20.2.2 Create dra instance entry

#### Description:

Use this command to create.

#### Command Syntax:

```
create dra instance entry portid <portid-val> vlan <vlan-val> profileid  
<profileid-val> [ status disable | client | server ] [ op82 disable | AddAlways |  
AddIfNotExists ] [ configsuboption aci | Portid | None ] [ acival <acival-val> ]  
[ raival <raival-val> ] [ syncratefields ActualDataRateupstrm |  
ActualDataRatednstrm | MinDataRateupstrm | MinDataRatednstrm |  
AttainableDataRateupstrm | AttainableDataRatednstrm | MaxDataRateupstrm |  
MaxDataRatednstrm | MinLpDataRateupstrm | MinLpDataRatednstrm |  
MaxDelayupstrm | ActualDelayupstrm | MaxDelaydnstrm | ActualDelaydnstrm |  
None ] [ op82fromclientact drop | forward ] [ learning disable | enable ] [ portno  
<portno-val> ] [ draaddop82tounicast disable | enable ]
```

### 5.20.2.3 Delete dra instance entry

#### Description:

Use this command to Delete.

#### Command Syntax:

```
delete dra instance entry portid <portid-val> vlan <vlan-val>
```

### 5.20.2.4 Modify dra instance entry

#### Description:

Use this command to modify.

#### Command Syntax:

```
modify dra instance entry portid <portid-val> vlan <vlan-val> [ profileid  
<profileid-val> ] [ status disable | client | server ] [ op82 disable | AddAlways |  
AddIfNotExists ] [ configsuboption aci | Portid | None | None ] [ acival  
<acival-val> ] [ raival <raival-val> ] [ syncratefields ActualDataRateupstrm |  
ActualDataRatednstrm | MinDataRateupstrm | MinDataRatednstrm |  
AttainableDataRateupstrm | AttainableDataRatednstrm | MaxDataRateupstrm |  
MaxDataRatednstrm | MinLpDataRateupstrm | MinLpDataRatednstrm |  
MaxDelayupstrm | ActualDelayupstrm | MaxDelaydnstrm | ActualDelaydnstrm |  
None | None ] [ op82fromclientact drop | forward ] [ learning disable | enable ]  
[ portno <portno-val> ] [ draaddop82tounicast disable | enable ]
```

#### Parameters

| Name                | Description   |
|---------------------|---|
| portid <portid-val> | Bridge Port Identifier<br><b>Type:</b> Create -- Mandatory<br>Delete -- Mandatory<br>Modify -- Mandatory<br>Get -- Optional<br><b>Valid values:</b> 1 - 194   |
| vlan <vlan-val>     | VLAN identifier. In case of stacked mode this is virtual VLAN<br><b>Type:</b> Create -- Mandatory<br>Delete -- Mandatory<br>Modify -- Mandatory<br>Get -- Optional<br><b>Valid values:</b> 1 - 4095 |

|   |   |
|---|---|
| <b>profileid</b> <profileid-val>                  | <p>DRA profile identifier. This shall be used for this DRA instance</p> <p><b>Type:</b> Create -- Mandatory<br/> Modify -- Optional</p> <p><b>Valid values:</b> 1 - 4</p>   |
| <b>status</b> disable   client   server           | <p>This field is used to configure the status of DHCP relay agent per instance. It can be disabled or configured as client port or server port. If it is configured as client port then it adds option 82 and /or do learning as per configuration. If it is configured as server port then it removes option 82 and does learning if we dont get portid from agent circuit id.</p> <p><b>Type:</b> Create -- Optional<br/> Modify -- Optional</p> <p><b>Default value:</b> disable</p> |
| <b>op82</b> disable   AddAlways   AddIfNotExists  | <p>This specifies the action to be performed on Option 82 on receiving DHCP discovery packets for this instance. If disabled DRA will not add Option82 tag to the DHCP packets. If AddAlways is set then Option 82 is always added. If AddIfNotExists is set then Option 82 is added only if the received DHCP packet does not contain Option 82.</p> <p><b>Type:</b> Create -- Optional<br/> Modify -- Optional</p> <p><b>Default value:</b> AddAlways</p>                             |
| <b>configsuboption</b> aci   Portid   None   None | <p>This bitmask is used to indicate which all parameters are configured for this instance. Parameter bit set in this bitmask will overwrite the automatically derived values of agent circuit id and/or port id by the values configured in this MO.</p> <p><b>Type:</b> Create -- Optional<br/> Modify -- Optional</p> <p><b>Default value:</b> None</p>   |
| <b>acival</b> <acival-val>                        | <p>This is use to configure agent circuit id for this instance. If ACI bit is set in gsvDRAConfigSubOptionthen this parameter will overwrite the generated Agent Circuit Id</p> <p><b>Type:</b> Create -- Optional<br/> Modify -- Optional</p> <p><b>Default value:</b> "\0"</p>  |
| <b>raival</b> <raival-val>                        | <p>This is use to configure remote agent id for this instance. This parameter uniquely identifies the subscriber on the associated access loop logical port on the Columbia.</p> <p><b>Type:</b> Create -- Optional<br/> Modify -- Optional</p> <p><b>Default value:</b> "\0"</p>   |

|   |  |
|---|--|
| <p><b>syncratefields</b></p> <p>ActualDataRateupstrm  <br/> ActualDataRatednstrm  <br/> MinDataRateupstrm  <br/> MinDataRatednstrm  <br/> AttainableDataRateupstrm  <br/> AttainableDataRatednstrm  <br/> MaxDataRateupstrm  <br/> MaxDataRatednstrm  <br/> MinLpDataRateupstrm  <br/> MinLpDataRatednstrm  <br/> MaxDelayupstrm  <br/> ActualDelayupstrm  <br/> MaxDelaydnstrm  <br/> ActualDelaydnstrm   None  <br/> None</p> | <p>This bitmask is used to indicate what all access loop characteristic parameters are to be added to access loop characteristic suboption.</p> <p><b>Type:</b> Create -- Optional<br/> Modify -- Optional</p>   |
| <p><b>op82fromclientact</b> drop  <br/> forward</p>   | <p>This specifies the action to be taken on receiving DHCP message from the client with option 82. If DHCP message contains option82 and we want the packet to be dropped then drop should be set and if we want the packet to be forwarded then forward should be set.</p> <p><b>Type:</b> Create -- Optional<br/> Modify -- Optional</p> <p><b>Default value:</b> drop</p> |
| <p><b>learning</b> disable   enable</p>   | <p>This field specifies whether DHCP learning is to be done on this port or not. If enabled DRA will learn the IP Addresses assigned towards this port using upstream/downstream packets received on this port.</p> <p><b>Type:</b> Create -- Optional<br/> Modify -- Optional</p> <p><b>Default value:</b> enable</p>   |
| <p><b>portno</b> &lt;portno-val&gt;</p>   | <p>This field specifies Atm Port number.Its value is considered only when the bitmask for portid is set in ConfigSubOptionBitmask</p> <p><b>Type:</b> Create -- Optional<br/> Modify -- Optional</p> <p><b>Default value:</b> \0</p>   |

|   |  |
|---|--|
| <b>draaddop82tunicast</b><br>disable   enable | This field specifies whether Option 82 is to be added to DHCP Unicast packets or not. If enabled Option 82 will be added to DHCP Unicast Packets and when disabled, it will not be added.<br><br><b>Type:</b> Create -- Optional<br>Modify -- Optional<br><br><b>Default value:</b> enable |
|---|--|

**Example:**

```
$ create dra instance entry portid 1 vlan 5 profileid 1 status client op82 AddAlways
configsuboption aci acival "[ANI] atm 3/10:100.33" (slot = 3, port = 10, vpi = 100,
vci = 33)" raival "conexant noida" syncratefields ActualDelaydnstrm
op82fromclientact drop learning enable portno 10 draaddop82tunicast enable
Auto
```

**Output:**

Verbose Mode On  
Entry Created

```
Port Id                : 1                VLAN           : 5
Profile Id             : 1                DRA status    : client
Option82               : AddAlways
Config Sub-Option      : aci
Agent Circuit Id       : "[ANI] atm 3/10:100.33" (slot = 3, port = 10, vpi =
100, vci = 33)"
Remote Agent Id        : "conexant noida"
SyncRateInfoField      : ActualDelaydnstrm
DRA Act For Op82 From Client : drop
DRA learning           : enable           Port No        : 10
VCI                    : 33                VPI            : 100
L2 type                : Eth                Encap Type     : Llcmux
DRA Add Op82 To Unicast : enable
```

Verbose Mode Off:  
Entry Created

**Output field:**

| Field      | Description  |
|------------|--|
| Port Id    | Bridge Port Identifier   |
| VLAN       | VLAN identifier. In case of stacked mode this is virtual VLAN    |
| Profile Id | DRA profile identifier. This shall be used for this DRA instance |

|                                     |  |
|-------------------------------------|--|
| <b>DRA status</b>                   | This field is used to configure the status of DHCP relay agent per instance. It can be disabled or configured as client port or server port. If it is configured as client port then it adds option 82 and /or do learning as per configuration. If it is configured as server port then it removes option 82 and does learning if we dont get portid from agent circuit id. |
| <b>Option82</b>                     | This specifies the action to be performed on Option 82 on receiving DHCP discovery packets for this instance. If disabled DRA will not add Option82 tag to the DHCP packets. If AddAlways is set then Option 82 is always added. If AddIfNotExists is set then Option 82 is added only if the received DHCP packet does not contain Option 82.                               |
| <b>Config Sub-Option</b>            | This bitmask is used to indicate which all parameters are configured for this instance. Parameter bit set in this bitmask will overwrite the automatically derived values of agent circuit Id and/or port id by the values configured in this MO.  |
| <b>Agent Circuit Id</b>             | This is use to configure agent circuit id for this instance. If ACI bit is set in gsvDRAConfigSubOptionthen this parameter will overwrite the generated Agent Circuit Id   |
| <b>Remote Agent Id</b>              | This is use to configure remote agent id for this instance. This parameter uniquely identifies the subscriber on the associated access loop logical port on the Columbia.  |
| <b>SyncRateInfoField</b>            | This bitmask is used to indicate what all access loop characteristic parameters are to be added to access loop characteristic suboption.   |
| <b>DRA Act For Op82 From Client</b> | This specifies the action to be taken on receiving DHCP message from the client with option 82. If DHCP message contains option82 and we want the packet to be dropped then drop should be set and if we want the packet to be forwarded then forward should be set.   |
| <b>DRA learning</b>                 | This field specifies whether DHCP learning is to be done on this port or not. If enabled DRA will learn the IP Addresses assigned towards this port using upstream/downstream packets received on this port.   |
| <b>Port No</b>                      | This field specifies Atm Port number.Its value is considered only when the bitmask for portid is set in ConfigSubOptionBitmask   |
| <b>VCI</b>                          | VCI Identifier of the AAL5 VC corresponding the bridge port for this instance is created   |
| <b>VPI</b>                          | VPI Identifier of the AAL5 VC corresponding the bridge port for  |

|                                |   |
|--------------------------------|---|
|                                | this instance is created  |
| <b>L2 type</b>                 | This Parameter represents the L2 type used  |
| <b>Encap Type</b>              | This Parameter specifies the encapsulation type of the aal5 VC corresponding the bridge port for which this instance is created   |
| <b>DRA Add Op82 To Unicast</b> | This field specifies whether Option 82 is to be added to DHCP Unicast packets or not. If enabled Option 82 will be added to DHCP Unicast Packets and when disabled, it will not be added. |

### References:

DHCP Relay Agent commands

## 5.20.3 Dra stats entry Commands

### 5.20.3.1 Get dra stats entry

#### Description:

Use this command to get.

#### Command Syntax:

**get dra stats entry [portid <portid-val>] [vlan <vlan-val>]**

### 5.20.3.2 Reset dra stats entry

#### Description:

Use this command to reset.

#### Command Syntax:

**get dra stats entry [portid <portid-val>] [vlan <vlan-val>]**

#### Parameters:

| Name                             | Description  |
|----------------------------------|--|
| <b>portid &lt;portid-val&gt;</b> | Bridge port identifier<br><b>Type:</b> Reset -- Mandatory<br>Get -- Optional<br><b>Valid values:</b> 1 - 194   |
| <b>vlan &lt;vlan-val&gt;</b>     | VLAN identifier. In case of stacked mode this is virtual VLAN<br><b>Type:</b> Reset -- Mandatory<br>Get -- Optional<br><b>Valid values:</b> 1 - 4095 |

**Example:**

```
$ get dra stats entry portid 1 vlan 1
```

**Output:**

```
Port Id           : 1           VLAN           : 1
Dhcp Pkt Received : 40           Dhcp Pkt Sent : 90
Dhcp Pkt Discarded : 40
```

**Output field:**

| Field              | Description   |
|--------------------|---|
| Port Id            | Bridge port identifier  |
| VLAN               | VLAN identifier. In case of stacked mode this is virtual VLAN |
| Dhcp Pkt Received  | Number of DHCP packets received for this instance             |
| Dhcp Pkt Sent      | Number of DHCP packets sent for this instance                 |
| Dhcp Pkt Discarded | Number of DHCP packets discarded for this instance            |

**References:**

DHCP Relay Agent commands

## 5.20.4 Dra global config Commands

### 5.20.4.1 Get dra global config

**Description:**

Use this command to get.

**Command Syntax:**

```
get dra global config
```

### 5.20.4.2 Modify dra global config

**Description:**

Use this command to modify.

**Command Syntax:**

```
modify dra global config [status Enable | Disable]
```



### Parameters:

| Name                           | Description                                      |
|--------------------------------|--|
| <b>status</b> Enable   Disable | Global status of DRA<br>Type: Modify -- Optional |

### Example:

```
$ get dra global Config
```

### Output:

```
DRA global Status
```

```
-----
```

```
Enable
```

### Output field:

| Field                    | Description          |
|--------------------------|----------------------|
| <b>DRA global Status</b> | Global status of DRA |

### References:

DHCP Relay Agent commands

## 5.20.5 Ia profile entry Commands

### 5.20.5.1 Get ia profile entry

#### Description:

Use this command to get.

#### Command Syntax:

```
get ia profile entry [profileid <profileid-val>]
```

### 5.20.5.2 Create ia profile entry

#### Description:

Use this command to create.

#### Command Syntax:

```
create ia profile entry profileid <profileid-val> [ anitype auto | config ] [ anival  
<anival-val> ] [ aciprefixstr <aciprefixstr-val> ] [ acifieldlist AniVal | Chassis |  
Rack | Frame | Slot | SubSlot | L2Type | Port | Vpi | Vci | VlanTag | None ]  
[ suboption Aci | Rai | EncapType | AccessLoopChar | None ] [ chassisval
```

chassisval ] [ **rackval** <rackval-val> ] [ **frameval** <frameval-val> ] [ **slotval** <slotval-val> ] [ **subslotval** <subslotval-val> ]

### 5.20.5.3 Delete ia profile entry

**Description:**

Use this command to delete.

**Command Syntax:**

**delete ia profile entry** [profileid <profileid-val>]

### 5.20.5.4 Modify ia profile entry

**Description:**

Use this command to modify.

**Command Syntax:**

**modify ia profile entry profileid** <profileid-val> [ **anitype** auto | config ] [ **anival** <anival-val> ] [ **aciprefixstr** <aciprefixstr-val> ] [ **acifieldlist** AniVal | Chassis | Rack | Frame | Slot | SubSlot | L2Type | Port | Vpi | Vci | VlanTag | None | None ] [ **suboption** Aci | Rai | EncapType | AccessLoopChar | None | None ] [ **chassisval** <chassisval-val> ] [ **rackval** <rackval-val> ] [ **frameval** <frameval-val> ] [ **slotval** <slotval-val> ] [ **subslotval** <subslotval-val> ]

**Parameters:**

| Name                                | Description  |
|-------------------------------------|--|
| <b>profileid</b><br><profileid-val> | Intermediate Agent Profile Identifier. This can be applied on multiple PIA or DRA instances.<br><br><b>Type:</b> Create -- Mandatory<br>Delete -- Mandatory<br>Modify -- Mandatory<br>Get -- Optional<br><br><b>Valid values:</b> 1 - 4  |
| <b>anitype</b> auto   config        | This field specifies whether the Access node Identifier should be automatically derived or is configured by the user. If its value is auto, the ANI is derived from MAC address of access node.<br><br><b>Type:</b> Create -- Optional<br>Modify -- Optional<br><br><b>Default value:</b> auto |

|   |   |
|---|---|
| <b>anival</b> <anival-val>  | <p>This is used to configure access node identifier. This field will be used only when value of gsvlaAniType is config.</p> <p><b>Type:</b> Create -- Optional<br/> Modify -- Optional</p> <p><b>Default value:</b> "\0"</p>  |
| <b>aciprefixstr</b><br><aciprefixstr-val>   | <p>This is used to configure user defined string to be concatenated as a part of flexible syntax in Agent Circuit Id. It is a string of characters with spaces and special characters.</p> <p><b>Type:</b> Create -- Optional<br/> Modify -- Optional</p> <p><b>Default value:</b> "\0"</p>   |
| <b>acifieldlist</b> AniVal  <br>Chassis   Rack   Frame<br>  Slot   SubSlot  <br>L2Type   Port   Vpi   Vci<br>  VlanTag   None  <br>None | <p>This field represents list of parameters which will take part in auto generation of Agent Circuit Id.</p> <p><b>Type:</b> Create -- Optional<br/> Modify -- Optional</p>   |
| <b>suboption</b> Aci   Rai  <br>EncapType  <br>AccessLoopChar  <br>None   None  | <p>This field represents bitmask for suboptions to be added to VSA tag in case of PIA and Option82 tag in case of DRA. The options which can be added include Agent Circuit Id, Agent Remote Id, EncapType and AccessLoopCharacterstics. Agent Circuit id identifies the circuit, Agent Remote id specifies the subscriber information, EncapType and AccessLoopChar identify with the encapsulation type and access loop characterstics respectively.</p> <p><b>Type:</b> Create -- Optional<br/> Modify -- Optional</p> |
| <b>chassisval</b><br><chassisval-val>   | <p>Chasis number of access node</p> <p><b>Type:</b> Create -- Optional<br/> Modify -- Optional</p> <p><b>Default value:</b> \0</p>  |
| <b>rackval</b> <rackval-val>  | <p>Rack no of access node</p> <p><b>Type:</b> Create -- Optional<br/> Modify -- Optional</p> <p><b>Default value:</b> \0</p>  |
| <b>frameval</b><br><frameval-val>   | <p>Frame number of access node.</p> <p><b>Type:</b> Create -- Optional<br/> Modify -- Optional</p> <p><b>Default value:</b> \0</p>  |

|                                       |  |
|---------------------------------------|--|
| <b>slotval</b> <slotval-val>          | Slot number of access node<br><b>Type:</b> Create -- Optional<br>Modify -- Optional<br><b>Default value:</b> \0      |
| <b>subslotval</b><br><subslotval-val> | Sub-slot number of access node.<br><b>Type:</b> Create -- Optional<br>Modify -- Optional<br><b>Default value:</b> \0 |

**Example:**

```
$ create ia profile entry profileid 1 anitype auto anival 00aabbccddff aciprefixstr
"Conexant Noida" acifieldlist port vpi vci suboption Aci chassisval 1 rackval 1
frameval 1 slotval 3 subslotval 1Output
```

**Output:**

Verbose Mode On  
Entry Created

```
Profile Id      : 1                ANI Type : auto
ANI value      : 00aabbccddff
Aci Prefix Str : "Conexant Noida"
ACI Field List : port vpi vci
Sub Option     : Aci
Chassis       : 1                Rack      : 1
Frame        : 1                Slot      : 3
Sub Slot      : 1
```

Verbose Mode Off:  
Entry Created

**Output field:**

| Field             | Description   |
|-------------------|---|
| <b>Profile Id</b> | Intermediate Agent Profile Identifier. This can be applied on multiple PIA or DRA instances.  |
| <b>ANI Type</b>   | This field specifies whether the Access node Identifier should be automatically derived or is configured by the user. If its value is auto, the ANI is derived from MAC address of access node. |
| <b>ANI value</b>  | This is used to configure access node identifier. This field will be used only when value of gsvlaAniType is  |

|                       |   |
|-----------------------|---|
|                       | config.   |
| <b>Aci Prefix Str</b> | This is used to configure user defined string to be concatenated as a part of flexible syntax in Agent Circuit Id. It is a string of characters with spaces and special characters.   |
| <b>ACI Field List</b> | This field represents list of parameters which will take part in auto generation of Agent Circuit Id.   |
| <b>Sub Option</b>     | This field represents bitmask for suboptions to be added to VSA tag in case of PIA and Option82 tag in case of DRA. The options which can be added include Agent Circuit Id, Agent Remote Id, EncapType and AccessLoopCharacterstics. Agent Circuit id identifies the circuit, Agent Remote id specifies the subscriber information, EncapType and AccessLoopChar identify with the encapsulation type and access loop characterstics respectively. |
| <b>Chassis</b>        | Chasis number of access node  |
| <b>Rack</b>           | Rack no of access node  |
| <b>Frame</b>          | Frame number of access node.  |
| <b>Slot</b>           | Slot number of access node  |
| <b>Sub Slot</b>       | Sub-slot number of access node.   |

### References:

Intermediate Agent commands

## 5.20.6 Pia instance entry Commands

### 5.20.6.1 Get pia instance entry

#### Description:

Use this command to get.

#### Command Syntax:

```
get pia instance entry [portid <portid-val>] [vlan <vlan-val>]
```

### 5.20.6.2 Create pia instance entry

#### Description:

Use this command to create.

**Command Syntax:**

**create pia instance entry portid** <portid-val> **vlan** <vlan-val> **profileid** <profileid-val> [ **status** enable | disable ] [ **vsatag** disable | AddAlways | AddIfNotExists ] [ **configsuboptionbitmask** aci | PortId | None ] [ **acival** <acival-val> ] [ **raival** <raival-val> ] [ **syncratefields** ActualDataRateupstrm | ActualDataRatednstrm | MinDataRateupstrm | MinDataRatednstrm | AttainableDataRateupstrm | AttainableDataRatednstrm | MaxDataRateupstrm | MaxDataRatednstrm | MinLpDataRateupstrm | MinLpDataRatednstrm | MaxDelayupstrm | ActualDelayupstrm | MaxDelaydnstrm | ActualDelaydnstrm | None ] [ **iwftagfromclientact** drop | forward ] [ **insertiwfsubop** enable | disable ] [ **portno** <portno-val> ]

**5.20.6.3 Delete pia instance entry****Description:**

Use this command to delete.

**Command Syntax:**

**delete pia instance entry portid** <portid-val> **vlan** <vlan-val>

**5.20.6.4 Modify pia instance entry****Description:**

Use this command to modify.

**Command Syntax:**

**modify pia instance entry portid** <portid-val> **vlan** <vlan-val> [ **profileid** <profileid-val> ] [ **status** enable | disable ] [ **vsatag** disable | AddAlways | AddIfNotExists ] [ **configsuboptionbitmask** aci | PortId | None | None ] [ **acival** <acival-val> ] [ **raival** <raival-val> ] [ **syncratefields** ActualDataRateupstrm | ActualDataRatednstrm | MinDataRateupstrm | MinDataRatednstrm | AttainableDataRateupstrm | AttainableDataRatednstrm | MaxDataRateupstrm | MaxDataRatednstrm | MinLpDataRateupstrm | MinLpDataRatednstrm | MaxDelayupstrm | ActualDelayupstrm | MaxDelaydnstrm | ActualDelaydnstrm | None | None ] [ **iwftagfromclientact** drop | forward ] [ **insertiwfsubop** enable | disable ] [ **portno** <portno-val> ]

## Parameters:

| Name  | Description  |
|---|--|
| <b>portid</b> <portid-val>                                      | <p>Bridge Port Identifier</p> <p><b>Type:</b> Create -- Mandatory<br/>Delete -- Mandatory<br/>Modify -- Mandatory<br/>Get -- Optional</p> <p><b>Valid values:</b> 1 - 194</p>  |
| <b>vlan</b> <vlan-val>  | <p>VLAN identifier. In case of stacked mode this is virtual VLAN</p> <p><b>Type:</b> Create -- Mandatory<br/>Delete -- Mandatory<br/>Modify -- Mandatory<br/>Get -- Optional</p> <p><b>Valid values:</b> 1 - 4095</p>  |
| <b>profileid</b><br><profileid-val>                             | <p>PIA profile identifier. This shall be used for this PIA Instance</p> <p><b>Type:</b> Create -- Mandatory<br/>Modify -- Optional</p> <p><b>Valid values:</b> 1 - 4</p>   |
| <b>status</b> enable   disable                                  | <p>Used to enable or disable PPPOE intermediate agent for this instance</p> <p><b>Type:</b> Create -- Optional<br/>Modify -- Optional</p> <p><b>Default value:</b> disable</p>   |
| <b>vsatag</b> disable   AddAlways   AddIfNotExists              | <p>This specifies the action to be performed on VSA Tag on receiving PPPoE discovery packets for this instance. If disabled PIA will not add VSA tag to the PPPoE packets. If AddAlways is set then VSA tag is always added. If AddIfNotExists is set then VSA tag is added only if the received packet does not contain the VSA tag.</p> <p><b>Type:</b> Create -- Optional<br/>Modify -- Optional</p> <p><b>Default value:</b> AddAlways</p> |
| <b>configsuboptionbitmask</b><br>ask aci   PortId   None   None | <p>This bitmask is used to indicate which all parameters are configured for this instance. Parameter bit set in this bitmask will overwrite the automatically derived values of agent circuit Id and/or port id by the values configured in this MO.</p> <p><b>Type:</b> Create -- Optional</p>  |

|   |   |
|---|---|
|   | <p>Modify -- Optional</p> <p><b>Default value:</b> None</p>   |
| <p><b>acival</b> &lt;acival-val&gt;</p>   | <p>This is use to configure Agent Circuit Id for this instance. If ACI bit is set in gsvPiaConfigSubOptionBitmask then this parameter will overwrite the generated Agent Circuit Id</p> <p><b>Type:</b> Create -- Optional</p> <p>Modify -- Optional</p> <p><b>Default value:</b> "\0"</p>                            |
| <p><b>raival</b> &lt;raival-val&gt;</p>   | <p>This is used to configure Remote Agent Id for this instance. This parameter uniquely identifies the subscriber on the associated access loop logical port on Columbia.</p> <p><b>Type:</b> Create -- Optional</p> <p>Modify -- Optional</p> <p><b>Default value:</b> "\0"</p>                                      |
| <p><b>syncratefields</b></p> <p>ActualDataRateupstrm  <br/>ActualDataRatednstrm  <br/>MinDataRateupstrm  <br/>MinDataRatednstrm  <br/>AttainableDataRateupstrm  <br/>AttainableDataRatednstrm  <br/>MaxDataRateupstrm  <br/>MaxDataRatednstrm  <br/>MinLpDataRateupstrm  <br/>MinLpDataRatednstrm  <br/>MaxDelayupstrm  <br/>ActualDelayupstrm  <br/>MaxDelaydnstrm  <br/>ActualDelaydnstrm  <br/>None   None</p> | <p>This bitmask is used to indicate what all access loop characteristic parameters are to be added to access loop characteristic suboption.</p> <p><b>Type:</b> Create -- Optional</p> <p>Modify -- Optional</p>  |
| <p><b>iwftagfromclientact</b></p> <p>drop   forward</p>   | <p>This field specifies the Action to be taken on receiving PPPoE discovery msg with IWF suboption from client. It can be configured as either drop or forward. Default action is to drop the packet silently.</p> <p><b>Type:</b> Create -- Optional</p> <p>Modify -- Optional</p> <p><b>Default value:</b> drop</p> |



|   |  |
|---|--|
| <b>insertiwfsubop</b> enable<br>  disable | This is used to indicate whether to add IWF suboption to Columbia originated PPPoE discovery packets received for this instance. This field is valid only for PPPOAE interface.<br><br><b>Type:</b> Create -- Optional<br>Modify -- Optional<br><br><b>Default value:</b> enable |
| <b>portno</b> <portno-val>                | This field specifies Atm Port number.Its value is considered only when the bitmask for portid is set in ConfigSubOptionBitmask<br><br><b>Type:</b> Create -- Optional<br>Modify -- Optional<br><br><b>Default value:</b> \0  |

**Example:**

```
$ create pia instance entry portid 1 vlan 1 profileid 1 status enable vsatag
AddAlways configsuboptionbitmask aci acival "[ANI] atm 3/10:100.33" (slot = 3,
port = 10, vpi = 100, vci = 33) raival "conexant noida" syncratefields
ActualDelaydnstrm iwftagfromclientact drop insertiwfsubop enable portno 10
Auto Output
```

**Output:**

Verbose Mode On  
Entry Created

```
Port Id           : 1           VLAN           : 1
Profile Id        : 1           PIA status : enable
PIAVsaOption      : AddAlways
Config Sub Options Bitmask : aci
Agent Circuit Id   : "[ANI] atm 3/10:100.33" (slot = 3, port = 10, vpi = 100, vci = 33)"
Remote Agent Id    : "conexant noida"
SyncRateInfoField Bitmask : ActualDelaydnstrm
Act for IWFTag From Client : drop
Insert Iwf Subop   : enable
Port No            : 10
VCI                : 33           VPI            : 100
L2 type            : Eth
Encap Type         : Llc mux
```

Verbose Mode Off:  
Entry Created

**Output field:**

| <b>Field</b>                      | <b>Description</b>   |
|-----------------------------------|--|
| <b>Port Id</b>                    | Bridge Port Identifier   |
| <b>VLAN</b>                       | VLAN identifier. In case of stacked mode this is virtual VLAN  |
| <b>Profile Id</b>                 | PIA profile identifier. This shall be used for this PIA Instance   |
| <b>PIA status</b>                 | Used to enable or disable PPPOE intermediate agent for this instance   |
| <b>PIAVsaOption</b>               | This specifies the action to be performed on VSA Tag on receiving PPPoE discovery packets for this instance. If disabled PIA will not add VSA tag to the PPPoE packets. If AddAlways is set then VSA tag is always added. If AddIfNotExists is set then VSA tag is added only if the received packet does not contain the VSA tag. |
| <b>Config Sub Options Bitmask</b> | This bitmask is used to indicate which all parameters are configured for this instance. Parameter bit set in this bitmask will overwrite the automatically derived values of agent circuit Id and/or port id by the values configured in this MO.  |
| <b>Agent Circuit Id</b>           | This is use to configure Agent Circuit Id for this instance. If ACI bit is set in gsvPiaConfigSubOptionBitmask then this parameter will overwrite the generated Agent Circuit Id   |
| <b>Remote Agent Id</b>            | This is used to configure Remote Agent Id for this instance. This parameter uniquely identifies the subscriber on the associated access loop logical port on Columbia.   |
| <b>SyncRateInfoField Bitmask</b>  | This bitmask is used to indicate what all access loop characteristic parameters are to be added to access loop characteristic suboption.   |
| <b>Act for IWFTag From Client</b> | This field specifies the Action to be taken on receiving PPPoE discovery msg with IWF suboption from client. It can be configured as either drop or forward. Default action is to drop the packet silently.  |
| <b>Insert Iwf Subop</b>           | This is used to indicate whether to add IWF suboption to Columbia originated PPPoE discovery packets received for this instance. This field is valid only for PPPOAE interface.  |
| <b>Port No</b>                    | This field specifies Atm Port number.Its value is  |

|                   |   |
|-------------------|---|
|                   | considered only when the bitmask for portid is set in ConfigSubOptionBitmask  |
| <b>VCI</b>        | VCI Identifier of the AAL5 VC corresponding the bridge port for this instance is created  |
| <b>VPI</b>        | VPI Identifier of the AAL5 VC corresponding the bridge port for this instance is created  |
| <b>L2 type</b>    | This Parameter specifies the L2 type used   |
| <b>Encap Type</b> | This Parameter specifies the encapsulation type of the aal5 VC corresponding the bridge port for which this instance is created |

### References:

PPPoE Intermediate Agent commands

## 5.20.7 Pia stats entry Commands

### 5.20.7.1 Get pia stats entry

#### Description:

Use this command to get.

#### Command Syntax:

**get pia stats entry** [**portid** <portid-val>] [**vlan** <vlan-val>]

### 5.20.7.2 Reset pia stats entry

#### Description:

Use this command to reset.

#### Command Syntax:

**reset pia stats entry portid** <portid-val> **vlan** <vlan-val>

#### Parameters:

| Name                       | Description  |
|----------------------------|--|
| <b>portid</b> <portid-val> | Bridge port Identifier<br><b>Type:</b> Reset -- Mandatory<br>Get -- Optional<br><b>Valid values:</b> 1 - 194 |

|                        |  |
|------------------------|--|
| <b>vlan</b> <vlan-val> | VLAN identifier. In case of stacked mode this is virtual VLAN<br><b>Type:</b> Reset -- Mandatory<br>Get -- Optional<br><b>Valid values:</b> 1 - 4095<br><b>Additional Values:</b> 4097 |
|------------------------|--|

**Example:**

\$ get pia stats entry portid 1 vlan 1

**Output:**

```

Port Id      : 1          VLAN          : 1
Padi Received : 10       Padi Discarded : 4354
Padr Received : 4354    Padr Discarded : 4354
  
```

**Output field:**

| Field                 | Description   |
|-----------------------|---|
| <b>Port Id</b>        | Bridge port Identifier  |
| <b>VLAN</b>           | VLAN identifier. In case of stacked mode this is virtual VLAN |
| <b>Padi Received</b>  | Number of PADI received for this instance                     |
| <b>Padi Discarded</b> | Number of PADI discarded for this instance                    |
| <b>Padr Received</b>  | Number of PADR received for this instance                     |
| <b>Padr Discarded</b> | Number of PADR packets discarded for this instance            |

**References:**

PPPoE Intermediate Agent commands

## 5.20.8 Pia global config Commands

### 5.20.8.1 Get pia global config

**Description:**

Use this command to get.

**Command Syntax:**

**get pia global config**

## 5.20.8.2 Modify pia global config

### Description:

Use this command to modify.

### Command Syntax:

**modify pia global config** [**status** Enable | Disable]

### Parameters:

| Name                           | Description   |
|--------------------------------|---|
| <b>status</b> Enable   Disable | Global status of PIA<br><b>Type:</b> Modify -- Optional |

### Example:

```
$ get pia global Config
```

### Output:

```
PIA global Status : Enable
```

### Output field:

| Field                    | Description          |
|--------------------------|----------------------|
| <b>PIA global Status</b> | Global status of PIA |

### References:

PPPoE Intermediate Agent commands

## 5.21 QoS Commands

---

### 5.21.1 IRL Map Commands

#### 5.21.1.1 Get irl map

**Description:**

Use this command to get.

**Command Syntax:**

**get irl map** [ifname <interface-name>]

#### 5.21.1.2 Create irl map

**Description:**

Use this command to create.

**Command Syntax:**

**create irl map ifname** < interface-name > **profilename** <profile-name>

#### 5.21.1.3 Delete irl map

**Description:**

Use this command to delete.

**Command Syntax:**

**delete irl map ifname** < interface-name >

**Parameters:**

| Name                                  | Description   |
|---------------------------------------|---|
| <b>ifname</b> < interface-name ><br>> | Interface Name whose IRL mapping information is to be configured.<br><b>Valid Values:</b> aal5-0 - aal5-*<br><b>Type :</b> Create Mandatory<br>Delete Mandatory<br>Get --Optional<br><b>Valid values:</b> ND - ND                           |
| <b>profilename</b><br><profile-name>  | Specifies the name of the IRL profile to be associated with the interface. String of up to 64 characters ( 'A'- 'Z', 'a'-'z', '0'-'9','-', '_' ) and any combination of printable characters excluding ';'<br><b>Type:</b> Create Mandatory |

**Example:**

```
$ create irl map ifname aal5-0 profilename gold
```

**Output:**

```
Verbose Mode On
```

```
Entry Created
```

```
Interface  Profile Name
```

```
-----
```

```
aal5-0     gold
```

```
Verbose Mode Off:
```

```
Entry Created
```

**Output field:**

| Field        | Description   |
|--------------|---|
| Interface    | Interface Name whose IRL mapping information is to be configured. <b>Valid Values:</b> aal5-0 - aal5-*  |
| Profile Name | Specifies the name of the IRL profile to be associated with the interface. String of up to 64 characters ( 'A'- 'Z', 'a'-'z', '0'-'9','-',','_') and any combination of printable characters excluding ';'. |

**5.21.2 IRL Profile Commands****5.21.2.1 Get irl profile****Description:**

Use this command to get.

**Command Syntax:**

```
get irl profile [profilename <profile-name>]
```

**5.21.2.2 Create irl profile****Description:**

Use this command to create.

**Command Syntax:**

```
create irl profile  profilename <profile-name> [ irltype sr2cm | trtcm] [ cir
<cir-val> ] [ cbs <cbs-val > ] [ pir <pir-val > ] [ pbs <pbs-val > ] [ conformation
<colorgreen-val> ] [ exceedaction drop | coloryellow ] [ violateaction drop |
coloryellow ]
```

**5.21.2.3 Delete irl profile****Description:**

Use this command to delete.

**Command Syntax:**

```
delete irl profile profilename <profile-name>
```

**5.21.2.4 Modify irl profile****Description:**

Use this command to modify.

**Command Syntax:**

```
modify irl profile  profilename <profile-name> [ irltype sr2cm | trtcm] [ cir
<cir-val > ] [ cbs <cbs-val > ] [ pir <pir-val > ] [ pbs <pbs-val > ] [ conformation
<colorgreen-val> ] [ exceedaction drop | coloryellow ] [ violateaction drop |
coloryellow ]
```

**Parameters:**

| Name                                 | Description  |
|--------------------------------------|--|
| <b>profilename</b><br><profile-name> | Profile name uniquely identify an IRL profile in the system. String of up to 64 characters ( 'A'- 'Z', 'a'-'z', '0'-'9','-', '_' ) and any combination of printable characters excluding ','.<br><br><b>Type:</b> Create — Mandatory<br>Delete — Mandatory<br>Modify — Mandatory<br>Get — Optional<br><br><b>Valid values:</b> ND - ND |
| <b>irltype sr2cm   trtcm</b>         | This field specifies the type of IRL. Two types of IRLs are supported. Single Rate Two Color Marker (sr2cm) and Two Rate Three Color Marker (trtcm).<br><br><b>Type:</b> Create — Optional<br>Modify — Optional<br><br><b>Valid values:</b> trtcm  |



|  |  |
|--|--|
| <b>cir</b> <cir-val >                      | Committed Information Rate of the IRL in kbps. This field is valid for both sr2cm and trtcm type of profiles. The value of this field cannot be more than PIR.<br><b>Type:</b> Create -- Optional<br>Modify -- Optional<br><b>Default value:</b> 0-16000   |
| <b>cbs</b> <cbs-val >                      | Committed Burst Size of the IRL in bytes. This field is valid in both sr2cm and trtcm type of profiles. The value of this field cannot be more than PBS in case of trTcm.<br><b>Type:</b> Create -- Optional<br>Modify -- Optional<br><b>Default value:</b> 96-10000<br><b>Default value:</b> 7500 |
| <b>pir</b> <pir-val >                      | Peak Information Rate of the IRL in kbps. This field is valid only for trtcm type of profile. The value of this field cannot be less than CIR.<br><b>Type:</b> Create -- Optional<br>Modify -- Optional<br><b>Default value:</b> 96-16000<br><b>Default value:</b> 1000                            |
| <b>pbs</b> <pbs-val >                      | Peak burst size of the IRL in bytes. This field is valid only for trtcm type of profile. The value of this field cannot be less than CBS.<br><b>Type:</b> Create -- Optional<br>Modify -- Optional<br><b>Default value:</b> 96-15000<br><b>Default value:</b> 10000                                |
| <b>conformation</b><br><b>colorgreen</b>   | Color type to be applied for conforming packets. This field is valid in both sr2cm and trtcm type of profiles <b>Type:</b> Create -- Optional<br>Modify -- Optional<br><b>Default value:</b> colorgreen  |
| <b>exceedaction</b> drop  <br>coloryellow  | Color for exceeding packets. This field is valid only for trtcm type of profiles<br><b>Type:</b> Create -- Optional<br>Modify -- Optional<br><b>Default value:</b> coloryellow   |
| <b>violateaction</b> drop  <br>coloryellow | Color type to be applied for violating packets. This field is valid in both sr2cm and trtcm type of profiles <b>Type:</b> Create -- Optional<br>Modify -- Optional<br><b>Default value:</b> drop   |

**Example:**

```
$ create irl profile profilename gold irltype trtcm cir 1000 cbs 400 pir 2000 pbs
12000 conformation colorgreen exceedaction coloryellow violateaction drop
```

**Output:****Output field:**

| Field                 | Description   |
|-----------------------|---|
| <b>Profile name</b>   | Profile name uniquely identifies an IRL profile in the system. String of up to 64 characters ( 'A'- 'Z', 'a'- 'z', '0'- '9', '-', '_', ) and any combination of printable characters excluding ';'. |
| <b>Profile Type</b>   | This field specifies the type of IRL. Two type of IRLs are supported. Single Rate Two Color Marker (sr2cm) and Two Rate Three Color Marker (trtcm).   |
| <b>CIR(kbps)</b>      | Committed Information Rate of the IRL in kbps. This field is valid for both sr2cm and trtcm type of profiles. The value of this field cannot be more than PIR.                                      |
| <b>CBS(bytes)</b>     | Committed Burst Size of the IRL in bytes. This field is valid in both sr2cm and trtcm type of profiles. The value of this field cannot be more than PBS in case of trTcm.                           |
| <b>PIR(kbps)</b>      | Peak Information Rate of the IRL in kbps. This field is valid only for trtcm type of profile. The value of this field cannot be less than CIR.  |
| <b>PBS(bytes)</b>     | Peak burst size of the IRL in bytes. This field is valid only for trtcm type of profile. The value of this field cannot be less than CBS.   |
| <b>Conform action</b> | Color type to be applied for conforming packets. This field is valid in both sr2cm and trtcm type of profiles.  |
| <b>Exceed action</b>  | Color for exceeding packets. This field is valid only for trtcm type of profiles.   |
| <b>Violate action</b> | Color type to be applied for violating packets. This field is valid in both sr2cm and trtcm type of profiles  |

**References:**

- IRL Commands

## 5.21.3 IRL Stats Commands

### 5.21.3.1 Get irl stats

#### Description:

Use this command to get.

#### Command Syntax:

```
get irl stats [ifname <interface-name>]
```

#### Parameters:

| Name                              | Description   |
|-----------------------------------|---|
| <b>ifname</b><br><interface-name> | Interface Name whose IRL statistics are requested.<br><b>Valid Values:</b> aal5-0 - aal5-*.<br><b>Type :</b> Get -- Optional<br><b>Valid values :</b> ND - ND |

#### Example:

```
$ get irl stats ifname aal5-0
```

#### Output:

```
Interface           : aal5-0      Num packets violated   : 100  
Num packets exceeded : 300      Num packets conformed : 1000
```

#### Output field:

| Field                        | Description   |
|------------------------------|---|
| <b>Interface</b>             | Interface Name whose IRL statistics are requested.  |
| <b>Num packets violated</b>  | Number of packets that violated PIR in case of trTcm. In case of crTcm it is the number of packets violating CIR. |
| <b>Num packets exceeded</b>  | Number of packets that exceeded CIR. This field is valid only for trtcm type of profiles.                         |
| <b>Num packets conformed</b> | Number of packets that conformed to CIR.  |

#### References:

- IRL Commands

## 5.21.4 Bridge rlin stance map Commands

### 5.21.4.1 Get bridge rlinstance map

**Description:** Use this command to get.

**Command Syntax:** `get bridge rlinstance map [portid <portid-val>]  
[flowtype <flowtype-val> | bcast | unregmcast | unknownucast]`

### 5.21.4.2 Create bridge rlinstance map

**Description:** Use this command to create.

**Command Syntax:** `create bridge rlinstance map portid  
<portid-val>flowtype <flowtype-val>| bcast | unregmcast | unknownucast |  
instanceid <instanceid-val>`

### 5.21.4.3 Delete bridge rlinstance map

**Description:** Use this command to get.

**Command Syntax:** `delete bridge rlinstance map portid <portid-val>  
flowtype <flowtype-val> | bcast | unregmcast | unknownucast`

### 5.21.4.4 Modify bridge rlinstance map

**Description:** Use this command to modify.

**Command Syntax:** `modify bridge rlinstance map portid  
<portid-val>flowtype <flowtype-val>| bcast | unregmcast | unknownucast  
[instanceid <instanceid-val>]`

#### Parameters

| Name                                   | Description   |
|--|---|
| <code>portid &lt;portid-val&gt;</code> | <p>Bridge Port Identifier with which an instance is associated. If the value of this field is 'All', it indicates all bridge ports. For a particular flow, instance map cannot be created both for a specific port as well as for 'all' the bridge ports.</p> <p><b>Type:</b> Create -- Mandatory<br/>Delete -- Mandatory<br/>Modify -- Mandatory<br/>Get -- Optional</p> <p><b>Valid values:</b> 1 - 194</p> |

|   |  |
|---|--|
| <p><b>flowtype</b><br/>&lt;flowtype-val&gt;  <b>bcast</b>  <br/><b>unregmcast</b>  <br/><b>unknownucast</b></p> | <p>This field identifies the flow for which this instance is applied. Three flow types are reserved for broadcast, unregistered multicast and unknown unicast traffic. The other user defined flows are identified by filtering rules by associating flow type with a rule action of type 'ratelimiter'.</p> <p><b>Type:</b> Create -- Mandatory<br/>Delete -- Mandatory<br/>Modify -- Mandatory<br/>Get -- Optional</p> <p><b>Valid values:</b> 16 - 32</p> |
| <p><b>instanceid</b><br/>&lt;instanceid-val&gt;</p>   | <p>This field identifies the Rate limiting instance.</p> <p><b>Type:</b> Create -- Mandatory<br/>Modify -- Optional</p> <p><b>Valid values:</b> 1 - 250</p>  |

**Example:**

```
$ create bridge rinstance map portid 6 flowtype bcast instanceid 1 configstatus Auto
```

**Output:**

```
Verbose Mode On  
Entry Created
```

```
Port Id      : 6  
Flow Type   : bcast  
Instance Id : 1
```

Verbose Mode Off:

```
Entry Created
```

**Output field:**

| Field                   | Description   |
|-------------------------|---|
| <p><b>Port Id</b></p>   | <p>Bridge Port Identifier with which an instance is associated. If the value of this field is 'All', it indicates all bridge ports. For a particular flow, instance map cannot be created both for a specific port as well as for 'all' the bridge ports.</p> |
| <p><b>Flow Type</b></p> | <p>This field identifies the flow for which this instance is applied. Three flow types are reserved for broadcast, unregistered multicast and unknown unicast traffic. The</p>  |

|                    |   |
|--------------------|---|
|                    | other user defined flows are identified by filtering rules by associating flow type with a rule action of type 'ratelimiter'. |
| <b>Instance Id</b> | This field identifies the Rate limiting instance.   |

**Cautions:**

- An entry in this table shall not be applicable for a bridge port created over PPPOE and IPOE interface.

## 5.21.5 RI actionprofile info Commands

### 5.21.5.1 Get rl actionprofile info

**Description:**

Use this command to get.

**Command Syntax:**

```
get rl actionprofile info [profileid <profileid-val>] [result conform | exceed | violate] [action drop | allow | sendtocontrol | copytocontrol | modifytos | setbacklevel]
```

### 5.21.5.2 Create rl actionprofile info

**Description:**

Use this command to create.

**Command Syntax:**

```
create rl actionprofile info profileid <profileid-val> result conform | exceed | violate action drop | allow | sendtocontrol | copytocontrol | modifytos | setbacklevel [actionval <actionval-val>] [actionmask <actionmask-val>] [description <description-val>]
```

### 5.21.5.3 Delete rl actionprofile info

**Description:**

Use this command to delete.

**Command Syntax:**

```
get rl actionprofile info profileid <profileid-val> result conform | exceed | violate action drop | allow | sendtocontrol | copytocontrol | modifytos | setbacklevel
```

## 5.21.5.4 Modify rl actionprofile info

### Description:

Use this command to modify.

### Command Syntax:

```
modify rl actionprofile info profileid <profileid-val> result conform | exceed |  
violate action drop | allow | sendtocontrol | copytocontrol | modifytos | setbacklevel  
[actionval <actionval-val>] [actionmask <actionmask-val>] [description  
<description-val>]
```

### Parameters:

| Name   | Description  |
|--|--|
| <b>profileid</b><br><profileid-val>  | Rate limiter's action profile identifier, which uniquely identifies the action profile.<br><br><b>Type:</b> Create -- Mandatory<br>Delete -- Mandatory<br>Modify -- Mandatory<br>Get -- Optional<br><br><b>Valid values:</b> 1 - 32  |
| <b>result</b> conform  <br>exceed   violate  | The result type for which action is configured to be taken.<br>Multiple actions can be configured for a result type. There shall be multiple entries with same profile identifier and a result type if multiple actions are configured for the result type. If there is no entry configured for a result type, the action is assumed to be 'allow' for that result.<br><br><b>Type:</b> Create -- Mandatory<br>Delete -- Mandatory<br>Modify -- Mandatory<br>Get -- Optional |
| <b>action</b> drop   allow  <br>sendtocontrol  <br>copytocontrol  <br>modifytos   setbacklevel | Action to be taken on the packet.<br><br><b>Type:</b> Create -- Mandatory<br>Delete -- Mandatory<br>Modify -- Mandatory<br>Get -- Optional   |

|   |   |
|---|---|
| <p><b>actionval</b><br/>&lt;actionval-val&gt;</p>     | <p>The parameter should contain valid value for some actions that require an additional input. For sendtocontrol and copytocontrol actions this parameter should contain control flow id (0 - 3). Other values are invalid for this action. For modifytos action this parameter should contain value to be set in tos field in the packet in the range 0 to 255. Other values are invalid for this action. The application of this value is dependent on the mask field. For setbaclevel action this parameter should contain Buffer Admission Control level 0 or 1. Other values are invalid for this action. This parameter is ignored for other actions.</p> <p><b>Type:</b> Create -- Optional<br/>                  Modify -- Optional</p> <p><b>Valid values:</b> 0 - 0xffffffff</p> <p><b>Default value:</b> 0</p> |
| <p><b>actionmask</b><br/>&lt;actionmask-val&gt;</p>   | <p>This field is valid for sendtocontrol, copytocontrol and modifytos actions only. For sendtocontrol and copytocontrol actions this parameter should contain trap disabled (0xffffffff) or trap enabled (0x00000000). Other values are invalid for this action. Only lower 8-bits are taken into consideration for modifytos action and other bits are ignored. In the mask if a bit location contains 1, then the corresponding bit in the TOS field is overwritten with the corresponding bit in action value. In the mask if a bit location contains 0, then the corresponding bit in the TOS field remains unchanged.</p> <p><b>Type:</b> Create -- Optional<br/>                  Modify -- Optional</p> <p><b>Valid values:</b> 0 - 0xffffffff</p> <p><b>Default value:</b> 0xffffffff</p>                         |
| <p><b>description</b><br/>&lt;description-val&gt;</p> | <p>Description of the application that receives packets matching this RL. This field is mandatory if Action is 'sendtocontrol' or 'copytocontrol'. The description string should not begin with underscore '_' as it is reserved for special usage e.g. _PPPOE_CONTROL.</p> <p><b>Type:</b> Create -- Optional<br/>                  Modify -- Optional</p> <p><b>Default value:</b> "\0"</p>   |

**Example:**

```
$ create rl actionprofile info profileid 1 result conform action copytocontrol actionval 0x00000000 actionmask 0xffffffff description lacp
```



**Output:**

Verbose Mode On

Entry Created

Action Profile Id : 1                      Action Result                      : conform  
 Profile Action        : copytocontrolActionVal                      : 0x00000000  
 Action Mask            : 0xffffffff      Application Description : larp

Verbose Mode Off:

Entry Created

**Output field:**

| Field                    | Description   |
|--------------------------|---|
| <b>Action Profile Id</b> | Rate limiter's action profile identifier, which uniquely identifies the action profile.   |
| <b>Action Result</b>     | The result type for which action is configured to be taken. Multiple actions can be configured for a result type. There shall be multiple entries with same profile identifier and a result type if multiple actions are configured for the result type. If there is no entry configured for a result type, the action is assumed to be 'allow' for that result.  |
| <b>Profile Action</b>    | Action to be taken on the packet.   |
| <b>ActionVal</b>         | The parameter should contain valid value for some actions that require an additional input. For sendtocontrol and copytocontrol actions this parameter should contain control flow id (0 - 3). Other values are invalid for this action. For modifytos action this parameter should contain value to be set in tos field in the packet in the range 0 to 255. Other values are invalid for this action. The application of this value is dependent on the mask field. For setbacklevel action this parameter should contain Buffer Admission Control level 0 or 1. Other values are invalid for this action. This parameter is ignored for other actions. |
| <b>Action Mask</b>       | This field is valid for sendtocontrol, copytocontrol and modifytos actions only. For sendtocontrol and copytocontrol actions this parameter should  |

|                                       |   |
|---------------------------------------|---|
|                                       | <p>contain trap disabled (0xffffffff) or trap enabled (0x00000000). Other values are invalid for this action. Only lower 8-bits are taken into consideration for modifytos action and other bits are ignored. In the mask if a bit location contains 1, then the corresponding bit in the TOS field is overwritten with the corresponding bit in action value. In the mask if a bit location contains 0, then the corresponding bit in the TOS field remains unchanged.</p> |
| <p><b>Application Description</b></p> | <p>Description of the application that receives packets matching this RL. This field is mandatory if Action is 'sendtocontrol' or 'copytocontrol'. The description string should not begin with underscore '_' as it is reserved for special usage e.g. <code>_PPPOE_CONTROL</code>.</p>  |

## 5.21.6 RI instance info Commands

### 5.21.6.1 Get rl instance info

**Description:**

Use this command to get.

**Command Syntax:**

**get rl instance info [instanceid <instanceid-val>]**

### 5.21.6.2 Create rl instance info

**Description:**

Use this command to create.

**Command Syntax:**

**create rl instance info instanceid <instanceid-val> profileid <profileid-val> actionprofileid <actionprofileid-val>**

### 5.21.6.3 Delete rl instance info

**Description:**

Use this command to delete.

## Command Syntax:

**delete rl instance info instanceid <instanceid-val>**

## Parameters:

| Name  | Description  |
|---|--|
| <b>instanceid</b><br><instanceid-val>           | Rate limiter instance identifier, which uniquely identifies a rate limiter instance.<br><b>Type:</b> Create -- Mandatory<br>Delete -- Mandatory<br>Get -- Optional<br><b>Valid values:</b> 1 - 250   |
| <b>profileid</b><br><profileid-val>             | This field identifies the rate limiter instance's configuration profile. The rate limiter's algorithm and associated parameters are based on the configuration profile.<br><b>Type:</b> Create -- Mandatory<br><b>Valid values:</b> 1 - 16 |
| <b>actionprofileid</b><br><actionprofileid-val> | This field identifies the rate limiter instance's action profile. The rate limiter's actions on a packet depending on the result are based on the action profile.<br><b>Type:</b> Create -- Mandatory<br><b>Valid values:</b> 1 - 32       |

## Example:

```
$ create rl instance info instanceid 3 profileid 2 actionprofileid 1
```

## Output:

```
Verbose Mode On  
Entry Created
```

```
Instance Id : 3  
Profile Id : 2            Action Profile Id : 1
```

```
Verbose Mode Off:  
Entry Created
```

### Output field:

| Field             | Description   |
|-------------------|---|
| Instance Id       | Rate limiter instance identifier, which uniquely identifies a rate limiter instance.  |
| Profile Id        | This field identifies the rate limiter instance's configuration profile. The rate limiter's algorithm and associated parameters are based on the configuration profile. |
| Action Profile Id | This field identifies the rate limiter instance's action profile. The rate limiter's actions on a packet depending on the result are based on the action profile.       |

## 5.21.7 RI profile info Commands

### 5.21.7.1 Get rl profile info

#### Description:

Use this command to get.

#### Command Syntax:

```
get rl profile info [profileid <profileid-val>]
```

### 5.21.7.2 Create rl profile info

#### Description:

Use this command to create

#### Command Syntax:

```
create rl profile info profileid <profileid-val> [ rate <rate-val> ] [ mbs <mbs-val> ]  
[ level packet | byte ] [ type sr2cm | trtcm ] [ peakrate <peakrate-val> ] [ pbs  
<pbs-val> ]
```

### 5.21.7.3 Delete rl profile info

#### Description:

Use this command to delete.

#### Command Syntax:

```
get rl profile info profileid <profileid-val>
```

## 5.21.7.4 Modify rl profile info

### Description:

Use this command to modify

### Command Syntax:

```
modify rl profile info profileid <profileid-val> [ rate <rate-val> ] [ mbs <mbs-val> ]  
[ level packet | byte ] [ type sr2cm | trtcm ] [ peakrate <peakrate-val> ] [ pbs  
<pbs-val> ]
```

### Parameters:

| Name                                | Description  |
|-------------------------------------|--|
| <b>profileid</b><br><profileid-val> | Rate limiter's configuration profile identifier, which uniquely identifies the configuration profile. The configuration profile contains all parameters required for rate limiting algorithm to operate.<br><b>Type:</b> Create -- Mandatory<br>Delete -- Mandatory<br>Modify -- Mandatory<br>Get -- Optional<br><b>Valid values:</b> 1 - 16 |
| <b>rate</b> <rate-val>              | This field defines the committed information rate. If 'level' is 'packet'(1), the unit is packets per second. If 'level' is 'byte'(2), the unit is bits per second.<br><b>Type:</b> Create -- Optional<br>Modify -- Optional<br><b>Valid values:</b> 1 - 100000000<br><b>Default value:</b> 100000000  |
| <b>mbs</b> <mbs-val>                | This field defines the committed burst size. If 'level' is 'packet'(1), the unit is number of packets. If 'level' is 'byte'(2), the unit is number of bytes.<br><b>Type:</b> Create -- Optional<br>Modify -- Optional<br><b>Valid values:</b> 4 - 65535<br><b>Default value:</b> 65535   |

|                                  |  |
|----------------------------------|--|
| <b>level</b> packet   byte       | <p>Level of the rate limiter identifies whether the algorithm executes in terms of number of packets or number of bytes.If the 'level' is 'packet'(1), rate is configured in terms of packets per second and burst size is configured in terms of number of packets.If the 'level' is 'byte'(2), rate is configured in terms of bits per second and burst size is configured in terms of number of bytes.</p> <p><b>Type:</b> Create -- Optional<br/> Modify -- Optional</p> <p><b>Default value:</b> packet</p> |
| <b>type</b> sr2cm   trtcm        | <p>Type identifies the algorithm for rate limiting.The sr2cm (single rate two color marker) is a single-rate algorithm. It takes rate and burst size as input parameters.The trtcm (two rate three color marker) is a dual-rate algorithm. It takes two sets of rate and burstsize as inputs, one each for peak and committed information.</p> <p><b>Type:</b> Create -- Optional<br/> Modify -- Optional</p> <p><b>Default value:</b> sr2cm</p>   |
| <b>peakrate</b><br>peakrate-val> | <p>This field is relevant only if 'type' is 'trtcm'(2). This field defines the peak information rate. If 'level' is 'packet'(1), the unit is packets per second. If level is byte, the unit is bits per second.</p> <p><b>Type:</b> Create -- Optional<br/> Modify -- Optional</p> <p><b>Valid values:</b> 1 - 100000000</p> <p><b>Default value:</b> 100000000</p>  |
| <b>pbs</b> <pbs-val>             | <p>This field is relevant only if 'type' is 'trtcm'(2). This field defines the peak burst size. If 'level' is 'packet'(1), the unit is number of packets. If 'level' is 'byte'(2), the unit is number of bytes.</p> <p><b>Type:</b> Create -- Optional<br/> Modify -- Optional</p> <p><b>Valid values:</b> 4 - 65535</p> <p><b>Default value:</b> 65535</p>  |

**Example:**

```
$ create rl profile info profileid 1 rate 24 mbs 24 level packet type trtcm peakrate 30
pbs 30
```

**Output:**

Verbose Mode On

Entry Created

Profile Id : 1

Level : packet Type : trtcm

Rate : 24 Max Burst Size : 24

Peak Rate : 30 Peak Max Burst Size : 30

Verbose Mode Off:

Entry Created

**Output field:**

| Field                 | Description  |
|-----------------------|--|
| <b>Profile Id</b>     | Rate limiter's configuration profile identifier, which uniquely identifies the configuration profile. The configuration profile contains all parameters required for rate limiting algorithm to operate.   |
| <b>Level</b>          | Level of the rate limiter identifies whether the algorithm executes in terms of number of packets or number of bytes. If the 'level' is 'packet'(1), rate is configured in terms of packets per second and burst size is configured in terms of number of packets. If the 'level' is 'byte'(2), rate is configured in terms of bits per second and burst size is configured in terms of number of bytes. |
| <b>Type</b>           | Type identifies the algorithm for rate limiting. The sr2cm (single rate two color marker) is a single-rate algorithm. It takes rate and burst size as input parameters. The trtcm (two rate three color marker) is a dual-rate algorithm. It takes two sets of rate and burst size as inputs, one each for peak and committed information.   |
| <b>Rate</b>           | This field defines the committed information rate. If 'level' is 'packet'(1), the unit is packets per second. If 'level' is 'byte'(2), the unit is bits per second.  |
| <b>Max Burst Size</b> | This field defines the committed burst size. If 'level' is 'packet'(1), the unit is number of packets. If 'level' is 'byte'(2), the unit is number of bytes.   |
| <b>Peak Rate</b>      | This field is relevant only if 'type' is 'trtcm'(2). This field defines the peak information rate. If 'level' is 'packet'(1), the unit is packets per second. If level   |

|                            |  |
|----------------------------|--|
|                            | is byte, the unit is bits per second.  |
| <b>Peak Max Burst Size</b> | This field is relevant only if 'type' is 'trtcm'(2). This field defines the peak burst size. If 'level' is 'packet'(1), the unit is number of packets. If 'level' is 'byte'(2), the unit is number of bytes. |

## 5.21.8 Scheduling profile class Commands

### 5.21.8.1 Get sched profile class

**Description:**

Use this command to get.

**Command Syntax:**

**get sched profile class** [**name** <name-val>] [**classid** <classid-val>]

### 5.21.8.2 Modify sched profile class

**Description:**

Use this command to modify.

**Command Syntax:**

**modify sched profile class name** <name-val> **classid** <classid-val> [**param1** <param1-val>] [**param2** <param2-val>] [**param3** <param3-val>] [**param4** <param4-val>] [**param5** <param5-val>]

**Parameters:**

| Name                         | Description  |
|------------------------------|--|
| <b>name</b> <name-val>       | Name of the scheduling profile.<br><b>Type:</b> Modify – Mandatory<br>Get – Optional   |
| <b>classid</b> <classid-val> | Scheduling profile class identifier<br><b>Type:</b> Modify -- Mandatory<br>Get -- Optional<br><b>Valid values:</b> 1 – 8   |
| <b>param1</b> <param1-val>   | This specifies the first parameter for the class queue that is used in the scheduling algorithm of the profile. For PP scheduling algorithm, this parameter specifies the weight of the class queue on the scale of 1-100. Value 100 means |



|                            |   |
|----------------------------|---|
|                            | <p>Strict Priority in PP scheduling profile. This weight will be normalized with the sum of all classId weights. For Custom scheduling algorithm, this parameter specifies the excess bandwidth sharing weight of the class on the scale of 1-100. If for a class, both Minimum bandwidth and the Excess sharing weight are configured as zero, then the queue shall never be scheduled. Default value of this parameter is calculated as (classid * 10). The default value listed is only an indicative value.</p> <p><b>Type:</b> Modify — Optional</p> |
| <b>param2</b> <param2-val> | <p>This specifies the second parameter for the class queue that is used in the scheduling algorithm of the profile. For PP scheduling algorithm, it is ignored. For Custom scheduling algorithm, this parameter specifies the Minimum bandwidth in Kbps. Value zero means no minimum bandwidth guarantee for the class.</p> <p><b>Type:</b> Modify — Optional</p>   |
| <b>param3</b> <param3-val> | <p>This specifies the third parameter for the class queue that is used in the scheduling algorithm of the profile. For PP scheduling algorithm, it is ignored. For Custom scheduling algorithm, this parameter specifies the Maximum bandwidth limit in Kbps for the class. Value zero means no maximum bandwidth limit for the class.</p> <p><b>Type:</b> Modify — Optional</p>  |
| <b>param4</b> <param4-val> | <p>This specifies the fourth parameter for the class queue that is used in the scheduling algorithm of the profile. For PP and Custom scheduling algorithms, it is ignored. The default value listed is only an indicative value.</p> <p><b>Type:</b> Modify -- Optional</p>  |
| <b>param5</b> <param5-val> | <p>This specifies the fifth parameter for the class queue that is used in the scheduling algorithm of the profile. For PP and Custom scheduling algorithms, it is ignored. The default value listed is only an indicative value.</p> <p><b>Type:</b> Modify — Optional</p>  |

**Example:**

```
$ get sched profile class name gold classid 1
```

**Output:**

```
Profile Name      : gold
Class Id         : 1
Profile Class Param1 : 20          Profile Class Param2 : 25
Profile Class Param3 : 25          Profile Class Param4 : 0
Profile Class Param5 : 25
```

**Output field:**

| Field                       | Description   |
|-----------------------------|---|
| <b>Profile Name</b>         | Name of the scheduling profile  |
| <b>Class Id</b>             | Scheduling profile class identifier   |
| <b>Profile Class Param1</b> | This specifies the first parameter for the class queue that is used in the scheduling algorithm of the profile. For PP scheduling algorithm, this parameter specifies the weight of the class queue on the scale of 1-100. Value 100 means Strict Priority in PP scheduling profile. This weight will be normalized with the sum of all classId weights. For Custom scheduling algorithm, this parameter specifies the excess bandwidth sharing weight of the class on the scale of 1-100. If for a class, both Minimum bandwidth and the Excess sharing weight are configured as zero, then the queue shall never be scheduled. Default value of this parameter is calculated as (classid * 10). The default value listed is only an indicative value. |
| <b>Profile Class Param2</b> | This specifies the second parameter for the class queue that is used in the scheduling algorithm of the profile. For PP scheduling algorithm, it is ignored.<br>For Custom scheduling algorithm, this parameter specifies the Minimum bandwidth in Kbps. Value zero means no minimum bandwidth guarantee for the class.   |
| <b>Profile Class Param3</b> | This specifies the third parameter for the class queue that is used in the scheduling algorithm of  |

|                             |  |
|-----------------------------|--|
|                             | <p>the profile. For PP scheduling algorithm, it is ignored.</p> <p>For Custom scheduling algorithm, this parameter specifies the Maximum bandwidth limit in Kbps for the class. Value zero means no maximum bandwidth limit for the class.</p> |
| <b>Profile Class Param4</b> | <p>This specifies the fourth parameter for the class queue that is used in the scheduling algorithm of the profile. For PP and Custom scheduling algorithms, it is ignored. The default value listed is only an indicative value.</p>          |
| <b>Profile Class Param5</b> | <p>This specifies the fifth parameter for the class queue that is used in the scheduling algorithm of the profile. For PP and Custom scheduling algorithms, it is ignored. The default value listed is only an indicative value.</p>           |

**References:**

- Scheduling profile related commands

## 5.21.9 Scheduling profile info Commands

### 5.21.9.1 Get sched profile info

**Description:**

Use this command to get.

**Command Syntax:**

**get sched profile info [name <name-val>]**

### 5.21.9.2 Create sched profile info

**Description:**

Use this command to create.

**Command Syntax:**

**create sched profile info name <name-val> [algo pp | custom] iftype eth| atm**

### 5.21.9.3 Delete sched profile info

#### Description:

Use this command to delete.

#### Command Syntax:

**delete sched profile info name <name-val>**

#### Parameters:

| Name                    | Description   |
|-------------------------|---|
| <b>name</b> <name-val>  | Name of the scheduling profile<br><b>Type:</b> Create — Mandatory<br>Delete — Mandatory<br>Modify — Mandatory<br>Get — Optional   |
| <b>algo</b> pp   custom | Scheduling algorithm of the profile. Currently only Proabalistic Priority is supported over ethernet and custom is supported over ATM. In Proabalistic Priority algorithm, the traffic class parameter determines the probability with which its corresponding queue is served when it is polled by the server. In Custom algorithm, user shall have flexibility to assign minimum rate, maximum rate, and excess bandwidth sharing weight for classes and the scheduling shall be done based on these parameters among classes.<br><b>Type:</b> Create -- Optional<br><b>Default value:</b> pp |
| <b>iftype</b> eth   atm | The type of the interface Ethernet/ATM port for which the scheduling profile is applicable.<br><b>Type:</b> Create — Mandatory  |

#### Example:

```
$ create sched profile info name gold algo pp iftype atm
```

#### Output :

Verbose Mode On

Verbose Mode On

Entry Created

Profile Name : gold

Scheduling Algorithm : pp Interface Type : eth

Verbose Mode Off:

Entry Created

### Output field:

| Field                | Description   |
|----------------------|---|
| Profile Name         | Name of the scheduling profile  |
| Scheduling Algorithm | Scheduling algorithm of the profile. Currently only Proabalistic Priority is supported over ethernet and custom is supported over ATM. In Proabalistic Priority algorithm, the traffic class parameter determines the probablity with which its corresponding queue is served when it is polled by the server. In Custom algorithm, user shall have flexibility to assign minimum rate, maximum rate, and excess bandwidth sharing weight for classes and the scheduling shall be done based on these parameters among classes. |
| Interface Type       | The type of the interface Ethernet/ATM port for which the scheduling profile is applicable.   |

### Caution:

- For a scheduling profile that has iftype as atm, upto 8 classes can be configured, while for a scheduling profile that has iftype as eth, 8 classes can be configured.

### References:

- Scheduling profile related commands.

## 5.21.10 Trfclass profile class Commands

### 5.21.10.1 Get trfclass profile class

#### Description:

Use this command to get.

#### Command Syntax:

```
get trfclass profile class [profileid <profileid-val>] [classid <classid-val>]
```

## 5.21.10.2 Modify trfclass profile class

### Description:

Use this command to get.

**Command Syntax:** `modify trfclass profile class profileid <profileid-val>classid <classid-val> [size <size-val>] [thrshld1 <thrshld1-val>]`

### Parameters:

| Name                             | Description  |
|----------------------------------|--|
| <b>profileid</b> <profileid-val> | Traffic class profile identifier.<br><b>Type:</b> Modify -- Mandatory<br>Get -- Optional<br><b>Valid values:</b> 1 - 10  |
| <b>classid</b> <classid-val>     | Traffic class profile class identifier.<br><b>Type:</b> Modify -- Mandatory<br>Get -- Optional   |
| <b>size</b> <size-val>           | This parameter specifies the size of the Traffic class.<br><b>Type:</b> Modify -- Optional   |
| <b>thrshld1</b> <thrshld1-val>   | This parameter specifies the low threshold of the queue, as a percentage of the queue size. When the queue is full beyond this threshold, only conforming frames are passed and non-conforming frames are dropped. Conformance of frames is determined as per IRL configured on input the ATM port.<br><b>Type:</b> Modify -- Optional<br><b>Valid values:</b> 0 - 100 |

### Example:

```
$ get trfclass profile class profileid 1 classid 1
```

### Output:

```
Profile Identifier      : 1           Class Id              : 1  
Traffic Class Param Size : 32         Traffic Class Param Thresh : 50
```

### Output field:

| Field                      | Description   |
|----------------------------|---|
| Profile Identifier         | Traffic class profile identifier.   |
| Class Id                   | Traffic class profile class identifier.   |
| Traffic Class Param Size   | This parameter specifies the size of the Traffic class.   |
| Traffic Class Param Thresh | This parameter specifies the low threshold of the queue, as a percentage of the queue size. When the queue is full beyond this threshold, only conforming frames are passed and non-conforming frames are dropped. Conformance of frames is determined as per IRL configured on input the ATM port. |

### References:

- See traffic class profile related commands.

## 5.21.11 Trfclass profile info Commands

### 5.21.11.1 Get trfclass profile info

#### Description:

Use this command to get.

#### Command Syntax:

```
get trfclass profile info [profileid <profileid-val>]
```

### 5.21.11.2 Create trfclass profile info

#### Description:

Use this command to get.

#### Command Syntax:

```
create trfclass profile info profileid <profileid-val> iftype eth | atm
```

### 5.21.11.3 Delete trfclass profile info

#### Description:

Use this command to delete.

#### Command Syntax:

```
get trfclass profile info profileid <profileid-val>
```

**Parameters:**

| Name                             | Description  |
|----------------------------------|--|
| <b>profileid</b> <profileid-val> | Traffic class profile identifier.<br><b>Type:</b> Create -- Mandatory<br>Delete -- Mandatory<br>Get -- Optional<br><b>Valid values:</b> 1 - 10 |
| <b>iftype</b> eth   atm          | Interface type.<br><b>Type:</b> Create -- Mandatory  |

**Example:**

```
$ create trfclass profile info profileid 3 iftype eth
```

**Output:**

```
Verbose Mode On  
Entry Created
```

```
Profile identifier : 3           Interface Type : eth
```

```
Verbose Mode Off:  
Entry Created
```

**Output field:**

| Field                     | Description                       |
|---------------------------|-----------------------------------|
| <b>Profile identifier</b> | Traffic class profile identifier. |
| <b>Interface Type</b>     | Interface type.                   |

**5.21.12 Trfclass stats Commands****5.21.12.1 Get trfclass stats****Description:**

Use this command to get.

**Command Syntax:**

```
get trfclass stats [ifname <ifname-val>] [classid <classid-val>]
```



## 5.21.12.2 Reset trfclass stats

### Description:

Use this command to get.

### Command Syntax:

**reset trfclass stats** [**ifname** <ifname-val>] [**classid** <classid-val>]

### Parameters:

| Name                         | Description  |
|------------------------------|--|
| <b>ifname</b> <ifname-val>   | Interface name<br><b>Type:</b> Reset -- Mandatory<br>Get -- Optional           |
| <b>classid</b> <classid-val> | Traffic class identifier<br><b>Type:</b> Reset -- Mandatory<br>Get -- Optional |

### Example:

```
$ get trfclass stats ifname 149 classid 1
```

### Output:

```
Interface Name : 149          Class Id : 1  
NumDiscardPkts : 10
```

### Output field:

| Field                 | Description                 |
|-----------------------|-----------------------------|
| <b>Interface Name</b> | Interface name              |
| <b>Class Id</b>       | Traffic class identifier    |
| <b>NumDiscardPkts</b> | Number of packets discarded |

## 5.22 RMON Commands

---

### 5.22.1 RMON Statistics Group Commands

#### 5.22.1.1 Create srmon probe

**Description:**

Use this command to create RMON probe.

**Command Syntax:**

```
create srmon probe rindex <rindex-val> ifname <interface-name> owner  
<owner-string>
```

#### 5.22.1.2 Delete srmon probe

**Description:**

Use this command to delete the RMON probe.

**Command Syntax:**

```
delete srmon probe rindex <rindex-val>
```

#### 5.22.1.3 Get srmon probe

**Description:**

Use this command to get RMON probe information and statistics.

**Command Syntax:**

```
get srmon probe [rindex <rindex-val>]
```

**Parameters:**

| Name                              | Description   |
|-----------------------------------|---|
| <b>rindex</b> <rindex-val>        | Unique identifier of the probe.<br><b>Type:</b> Create – Mandatory<br>Delete – Mandatory<br>Get - Optional<br><b>Valid values :</b> 0 –20 |
| <b>ifname</b><br><interface-name> | This specifies the Interface name.<br><b>Type:</b> Create – Mandatory<br><b>Valid values :</b> eoa-0 - *, eth-0-*                         |
| <b>owner</b> <owner-string>       | The entity that configured this probe, and is therefore using the resources assigned to it.   |

|  |   |
|--|---|
|  | <b>Type</b> : Create – Mandatory<br><b>Valid values</b> : Strings of up to 64 ASCII characters. |
|--|---|

**Example:**

```
$ get srmon probe rindex 1
```

**Output :**

Verbose Mode On

```

RMON Probe Index      : 1
If-Name               : eth-0      Stats Owner           : Conexant
Total Octets          : 800        Total Packets         : 200
Total Broadcast Packets : 138    Total Multicast Packets : 200
Total 64 Octets       : 100        Total 65-127 Octets  : 200
Total 128-255 Octets : 200        Total 256-511 Octets : 300
Total 512-1023 Octets : 50         Total 1024-1518 Octets : 100

```

**Output field:**

| Field                          | Description  |
|--------------------------------|--|
| <b>RMON Probe Index</b>        | Unique identifier of RMON probe.   |
| <b>If-Name</b>                 | This specifies the Interface name. It can be :<br>eoa-0 - *, eth-*   |
| <b>Stats Owner</b>             | The entity that configured this entry and is therefore using the resources assigned to it.   |
| <b>Total Octets</b>            | The total number of octets of data (including those in bad packets) received on the network (excluding framing bits but including FCS octets). |
| <b>Total Packets</b>           | The total number of packets (including bad packets, broadcast packets, and multicast packets) received.  |
| <b>Total Broadcast Packets</b> | The total number of good packets received, that were directed to the broadcast address.  |
| <b>Total Multicast Packets</b> | The total number of good packets received, that were directed to a multicast address.  |
| <b>Total 64 Octets</b>         | The total number of packets (including bad packets) received, that were 64 octets in length (excluding framing bits but including FCS octets). |
| <b>Total 65-127 Octets</b>     | The total number of packets (including bad packets) received, that were between 65 and 127 octets in length inclusive (excluding framing       |

|                               |  |
|-------------------------------|--|
|                               | bits but including FCS octets).  |
| <b>Total 128-255 Octets</b>   | The total number of packets (including bad packets) received that were between 128 and 255 octets in length inclusive (excluding framing bits but including FCS octets).   |
| <b>Total 256-511 Octets</b>   | The total number of packets (including bad packets) received that were between 256 and 511 octets in length inclusive (excluding framing bits but including FCS octets).   |
| <b>Total 512-1023 Octets</b>  | The total number of packets (including bad packets) received that were between 512 and 1023 octets in length inclusive (excluding framing bits but including FCS octets).  |
| <b>Total 1024-1518 Octets</b> | The total number of packets (including bad packets) received that were between 1024 and 1518 octets in length inclusive (excluding framing bits but including FCS octets). |

**Caution:**

- This command is not supported on an EoA interface for which ConfigStatus is set to Config.

## 5.22.2 RMON Task Info Commands

### 5.22.2.1 Get rmon task

**Description:**

Use this command to get.

**Command Syntax:**

**get rmon task [rname <task-name>]**

**Parameters:**

| Name                     | Description  |
|--------------------------|--|
| <b>Rname</b> < taskname> | This parameter specifies the name of a particular task.<br><b>Valid values:</b> Any task name present in the system. |

**Example:**

```
$ get rmon task taskname tsk1
```

**Output:**

```
Name           : TSK1                Status           : EVENT SUSPEND
Sched Count    : 1                    Priority          : 10
Preempt        : Yes                   Time Slice       : 0
Stack Base     : 0x520cc18             Stack Size       : 2048
CleanStackSize : 14080
LastSchedTime  : Thu Jan 01 00:00:08 1970-
```

**Output field:**

| Field                 | Description  |
|-----------------------|--|
| <b>Name</b>           | This parameter specifies the name of the task.   |
| <b>Status</b>         | This parameters specifies the status of the task. The task can in ready state, terminated state, suspended state or finished state.  |
| <b>Sched Count</b>    | This parameter specifies the Schedule count of the task i.e. number of times the task has been scheduled.  |
| <b>Priority</b>       | This parameter tells the priority of the task.   |
| <b>Preempt</b>        | This parameter tells whether the task preemption is allowed or not. If the value is yes then task can be preempted .If the value is No , then task can not be preempted.   |
| <b>Time Slice</b>     | This parameters tell the time slice of the task. If this value is zero, it means that time slicing is disabled for this task.  |
| <b>Stack Base</b>     | This parameter specifies the base address (starting address) of the stack associated with this task. The stack of the task would span from the address as given by Stack Base till the address as given by (Stack Base + Stack Size). Note that the stack grows from the address as given by (Stack Base + Stack Size) towards Stack Base. |
| <b>Stack Size</b>     | This parameters tells the total number of bytes in the task's stack.   |
| <b>CleanStackSize</b> | This Parameter tells the free stack size i.e. the number of bytes that have never been accessed in the stack of task. Basically this gives an idea of the stack watermark.   |
| <b>LastSchedTime</b>  | This parameter tells the system time at which the task was lastly scheduled.   |

## 5.22.3 RMON Memory Pool Info Commands

### 5.22.3.1 Get rmon mpool

#### Description:

Use this command to get.

#### Command Syntax:

```
get rmon mpool [rname <mpool-name>]
```

#### Parameters:

| Name        | Description  |
|-------------|--|
| rname mpool | This parameter specifies the name of a particular memory pool.<br><b>Valid values</b> : Any memory pool name present in the system.<br>A user can also give first few characters of a memory pool name. In that case all the memory pools whose name start with those characters shall be displayed. |

#### Example 1:

For variable size memory pool

```
$ get rmon mpool DCLFR113
```

#### Output:

```
Name           : DCLFR113           Size           : 5392
Min            : 16                Free            : 5360
Tasks Waiting  : 0                Suspend Type   : FIFO
StartAddr      : 0x147b7d28       FirstTaskName  : -
FirstAllocator : CLFR             LastAllocator  : CLFR
LastDellocater : CLFR             LastFailUser   : -
LastFailDellocater : -          WaterMark      : 84
TotalMemAlloc  : 52                TotalMemFree   : 52
MemAllocFailCount : 0            MemFreeFailCount : 0
MPoolType      : DYNAMIC          Threshold      : 5392
Threhold Count : 0
LastMemAllocTime : Thu Jan 01 00:01:08 1970
LastMemFreeTime  : Thu Jan 01 00:02:18 1970
LastMemAllocFailTime: -
LastMemFreeFailTime : -
ThresholdHitTime : -
```

**Output field:**

| Field                      | Description   |
|----------------------------|---|
| <b>Name</b>                | Name of the memory pool. For fixed size pool, the name starts with 'D'.   |
| <b>Size</b>                | Size of memory pool i.e.number of bytes in the pool.  |
| <b>Min</b>                 | Minimum number of bytes for each allocation from this pool.   |
| <b>Free</b>                | Number of free bytes in the pool i.e. Number of bytes that are available in the pool for allocation and has not been yet allocated.   |
| <b>Task Waiting</b>        | Number of tasks waiting on this pool.   |
| <b>Suspend Type</b>        | The task suspended type. Task suspend type on a memory pool can be either FIFO (First In First Out) or Priority.  |
| <b>Start Addr</b>          | The Starting Address of the memory pool.  |
| <b>FirstTaskName</b>       | Name of the first suspended task on this memory pool.   |
| <b>FirstAllocator</b>      | Name of the module which has firstly allocated memory from the pool.  |
| <b>LastAllocator</b>       | Name of the module which has lastly (i.e. most recently) allocated memory from the pool.  |
| <b>LastDeallocator</b>     | Name of the module which has lastly (ie. most recently)deallocated memory to the pool.  |
| <b>LastFailAllocator</b>   | Name of the module which has lastly failed to allocate the memory from the pool.  |
| <b>LastFailDeallocator</b> | Name of the module which has lastly failed to deallocate the memory to the pool.  |
| <b>WaterMark</b>           | WaterMark of the memorypool i.e. the maximum amount of memory that has been allocated from the memory pool at some point in time.   |
| <b>TotalMemAlloc</b>       | Total amount of memory allocated from the memory pool (since its creation ). This field is a running counter and it only increments. When the memory is freed this field is not decremented rather the TotalMemFree field is incremented. |
| <b>TotalMemFree</b>        | Total amount of memory that has been deallocated from the memory pool (since its creation). This is also a running counter.   |
| <b>MemAllocFailCount</b>   | The number of times memory allocation from this   |

|                             |   |
|-----------------------------|---|
|                             | pool has been failed.   |
| <b>MemFreeFailCount</b>     | The number of times the memory deallocation to the pool has been failed.  |
| <b>MPoolType</b>            | Type of the pool. If the value is DYNAMIC , the memory pool is of variable size . If it is PARTITION, it is fixed type memory pool. |
| <b>Threshold</b>            | Threshold Value set for the memory pool, in number of bytes.  |
| <b>ThresholdCOunt</b>       | Number of times the threshold value has been hit for this memory pool.  |
| <b>LastMemAllocTime</b>     | The system time when memory was lastly allocated from the pool.   |
| <b>LastMemFreeTime</b>      | The system time when memory was lastly freed into the pool.   |
| <b>LastMemAllocFailTime</b> | The system time when the last memory allocation from the pool has failed.   |
| <b>LastMemFreeFailTime</b>  | The system time when the last memory deallocation has failed.   |
| <b>ThresholdHitTime</b>     | The system time when threshold of the pool has hit most recently.   |

### Example 2:

For fixed size memory pool

\$ get rmon mpool FTSK142

### Output:

```

Name           : FTSK142           Size           : 280
Partion Size   : 20                Allocated      : 1
Free           : 9
Tasks Waiting  : 0                Suspend Type   : FIFO
StartAddr      : 0x5307e40        FirstTaskName  : -
FirstAllocator : TSK1             LastAllocator   : TSK1
LastDellocater : TSK1            LastFailUser    : -
LastFailDellocater : -          WaterMark      : 84
TotalMemAlloc  : 3                TotalMemFree    : 2
MemAllocFailCount : 0            MemFreeFailCount : 0
MPoolType      : PARTTION        Threshold      : 280
Threhold Count : 0
LastMemAllocTime : Thu Jan 01 00:02:34 1970
LastMemFreeTime : Thu Jan 01 00:02:49 1970

```



LastMemAllocFailTime: -  
 LastMemFreeFailTime : -  
 ThresholdHitTime : -

**Output field:**

| Field                     | Description  |
|---------------------------|--|
| <b>Name</b>               | Name of the memory pool. For fixed size pool, the name starts with 'F'.  |
| <b>Size</b>               | Size of memory pool i.e.number of bytes in the pool.   |
| <b>Partition Size</b>     | Partition size specifies the size of each partition in bytes.  |
| <b>Allocated</b>          | Number of partitions allocated.  |
| <b>Free</b>               | Number of free partitions in the pool i.e. Number of partitions that are available in the pool for allocation and has not been yet allocated.  |
| <b>Task Waiting</b>       | Number of tasks waiting on this pool.  |
| <b>Suspend Type</b>       | The task suspended type. Task suspend type on a memory pool can be either FIFO (First In First Out) or Priority.   |
| <b>StartAddr</b>          | The Starting Address of the memory pool.   |
| <b>FirstTaskName</b>      | Name of the first suspended task on this memory pool.  |
| <b>FirstAllocator</b>     | Name of the module which has firstly allocated partition from the pool.  |
| <b>LastAllocator</b>      | Name of the module which has lastly (i.e. most recently) allocated partition from the pool.  |
| <b>LastDellocater</b>     | Name of the module which has lastly (ie. most recently) freed the partition to the pool.   |
| <b>LastFailUser</b>       | Name of the module which has lastly failed to allocate the partition from the pool.  |
| <b>LastFailDellocater</b> | Name of the module which has lastly failed to free the partition in to the pool.   |
| <b>WaterMark</b>          | WaterMark of the memorypool i.e. the maximum amount of memory that has been allocated from the memory pool at some point in time. This figure (displayed in bytes) includes the memory allocated as well as the overhead that nucleus keeps while allocating partitions. |
| <b>TotalmemAlloc</b>      | Total number of partitions allocated from the  |

|                             |   |
|-----------------------------|---|
|                             | memory pool (since its creation ). This is a running counter, it always increments never decrements.  |
| <b>TotalMemFree</b>         | Total number of partitions that has been freed into the memory pool (since its creation). This is a running counter, it always increments never decrements. |
| <b>MemAllocFailCount</b>    | The number of times partition allocation from this pool has failed.   |
| <b>MemFreeFailCount</b>     | The number of times the partition deallocation to the pool has failed.  |
| <b>MPoolType</b>            | Type of the pool. If the value is DYNAMIC , the memory pool is of variable size . If it is PARTITION, it is fixed type memory pool.                         |
| <b>Threshold</b>            | Threshold Value set for the memory pool, in number of bytes.  |
| <b>Threshold Count</b>      | Number of times the threshold value has been hit for this memory pool.  |
| <b>LastMemAllocTime</b>     | The last system time when a partition has been allocated from the pool.   |
| <b>LastMemFreeTime</b>      | The last system time when a partition has been freed into the pool.   |
| <b>LastMemAllocFailTime</b> | The last system time when the partition allocation from the pool has failed.  |
| <b>LastMemFreeFailTime</b>  | The last system time when the partition deallocation has failed.  |
| <b>ThresholdHitTime</b>     | The last system time when threshold of the pool has hit.  |

### 5.22.3.2 Get rmon mpool threshold

#### Description:

Use this command to get the critical events logged for the memory pool. This command will display 20 entries (maximum) .Events are logged for the memory pool for the following 3 cases:

- Mem Pool Allocation Fail.
- Mem Pool Deallocation Fail.
- Threshold Hit.

**Command Syntax:****get rmon mpool threshold****Parameters:**

None

**Example:**

\$ get rmon mpool threshold

**Output:**

Task Name : TSK1

Mpool Name : FTSK143

Pool Type : PARTITION

ThresholdHitTimeStamp :Thu Jan 01 00:20:53 1970

Event Type : Allocation Fail

**Output field:**

| Field                        | Description   |
|------------------------------|---|
| <b>Task Name</b>             | Name of the module which tries to allocate or deallocate from memory pool during a critical event.  |
| <b>MPool Name</b>            | The name of memory pool.  |
| <b>Pool Type</b>             | Type of memory pool. DYNAMIC for variable size of memory pool and PARTITION for fixed size memory pool.   |
| <b>ThresholdHitTimeStamp</b> | The system time at which event logging is done.   |
| <b>Event Type</b>            | Cause of event logging.<br>Its value can be:<br>Allocation Fail - If allocation from pool has failed.<br>Deallocation Fail - If deallocation from pool has failed.<br>Threshold Hit - If threshold value of pool has been hit while allocation. |

### 5.22.3.3 Reset rmon mpool

**Description:**

Use this command to reset some parameters of memory pool. This command will reset the following parameters of memory pool.

- Set MemAllocFailCount value to zero.
- Set MemFreeFailCount value to zero.
- Set watermark value to the value of the currently allocated memory from that pool.
- Set ThresholdCount value to the zero.

**Command Syntax:**

```
reset rmon mpool
```

**Parameters:**

None

**Example:**

```
$ reset rmon mpool
```

**Output Field:**

None

## 5.22.4 RMON Queue Info Commands

### 5.22.4.1 Get rmon queue

**Description:**

Use this command to get the information about a particular queue or about all the queues present in the system.

**Command Syntax:**

```
get rmon queue [rname <queue-name>]
```

**Parameters:**

| Name               | Description  |
|--------------------|--|
| rname <queue-name> | This parameter specifies the name of a particular queue.<br><b>Valid values:</b> Any queue name present in the system. |

**Example:**

```
$ get rmon queue rname tsk173
```

**Output:**

```
Name           : TSK173           Start Addr      : 0x520c700
Size           : 10                Available Size   : 9
Pending Msgs   : 1                Msg Type        : FIXED
Msg Size       : 1                Suspend Type    : PRIORITY
Tasks Waiting  : 0                FirstTaskName   : -
TotalMsgIn     : 3                TotalMsgOut     : 2
DropCount      : 0                WaterMark       : 3
LastMsgInFailPtr: 0x0             LastSender      : TSK2
LastRecvr      : TSK1             LastSenderFail  : -
LastRecvFail   : -                ThreshHold      : 10
ThresholdHitCount: 0
LastMsgOutTime : Thu Jan 01 00:04:17 1970
LastMsgInTime  : Thu Jan 01 00:03:50 1970
LastMsgOutFailTime : -
LastMsgInFailTime : -
ThresholdHitTime : -
```

**Output field:**

| Field                 | Description  |
|-----------------------|--|
| <b>Name</b>           | Name of the Queue.   |
| <b>Start Addr</b>     | The Starting Address of the queue.   |
| <b>Size</b>           | Size of the queue i.e the total number of unsigned words (4 bytes) in the queue.   |
| <b>Available Size</b> | Available size of the queue i.e. number of unsigned words (4 bytes) free in the queue.   |
| <b>Pending Msgs</b>   | Number of messages present in the queue.   |
| <b>Msg Type</b>       | Type of the messages in the queue. If it is FIXED, then all the messages in the queue are of a fixed size. If it is VARIABLE , then the messages present in the queue can be of varying size.                |
| <b>Msg Size</b>       | Size of the message in number of unsigned words (4 bytes). If the msg type is fixed, then it tells the exact size of each message , else if the msg type is variable then it tells the maximum message size. |
| <b>Suspend Type</b>   | The task suspended type. Task suspend type on the queue can be either FIFO (First In First Out) or   |

|                           |  |
|---------------------------|--|
|                           | Priority.  |
| <b>Tasks Waiting</b>      | Number of tasks waiting on this queue.   |
| <b>FirstTaskName</b>      | Name of the first suspended task on this queue.  |
| <b>TotalMsgIn</b>         | Total number of messages enqueued i.e. the number of messages send to this queue (since its creation ).<br>This is a running counter and never decrements. |
| <b>TotalMsgOut</b>        | Total number of messages dequeued i.e. the number of messages received from this queue(since creation).<br>This is a running counter and never decrements. |
| <b>DropCount</b>          | Number of messages dropped i.e. total number of times message send to this queue failed. This is a running counter and never decrements.                   |
| <b>WaterMark</b>          | WaterMark of the queue i.e the maximum number of unsigned words (4 bytes) that has been present in this queue at some point in time.                       |
| <b>LastMsgInFailPtr</b>   | Address of the message buffer that failed to enqueue in the queue lastly.  |
| <b>LastSender</b>         | Name of the module which has lastly (i.e. most recently) send the message to the queue.  |
| <b>LastRecv</b>           | Name of the module which has lastly (ie. most recently)recieved the message from the queue.  |
| <b>LastSenderFail</b>     | Name of the module which has lastly failed to send the message to the queue.   |
| <b>LastRecvFail</b>       | Name of the module which has lastly failed to receive the message from the queue.  |
| <b>Threshold</b>          | Threshold Value set for the queue, in number of unsigned words (4 bytes).  |
| <b>ThresholdHitCount</b>  | Number of times threshold has been hit for the queue.  |
| <b>LastMsgOutTime</b>     | The system time when the message was lastly received from the queue.   |
| <b>LastMsgInTime</b>      | The system time when the message was lastly send to the queue.   |
| <b>LastMsgOutFailTime</b> | The system time when the message receiving from the queue has lastly failed.   |
| <b>LastMsgInFailTime</b>  | The system time when the message send to the queue has lastly failed.  |
| <b>ThresholdHitTime</b>   | The system time when threshold of the queue has lastly hit.  |

## 5.22.4.2 Get rmon queue threshold

### Description:

Use this command to get the critical events logged for the queue. This command will display 20 entries (maximum) . Events are logged for the queue for the following 3 cases:

- Message Receiving From Queue Fail.
- Message Send To Queue Fail.
- Threshold Hit.

### Command Syntax:

```
get rmon queue threshold
```

### Parameters

None

### Example

```
$ get rmon queue threshold
```

### Output

```
Queue Name      : TSK173                Task Name: TSK1
ThreshHitTime  : Thu Jan 01 00:00:14 1970
Event Type     : Msg Recv From Q Fail
```

### Output field:

| Field            | Description  |
|------------------|--|
| Queue Name       | Name of the queue.   |
| Task Name        | Name of the module which has tried to send or receive the message from the queue when the event has happened.  |
| ThresholdHitTime | The system time at which event logging is done.  |
| Event Type       | Cause of event logging.<br>Its value can be:<br>Msg Send To Q Fail - If failure occurred while sending message to queue.<br>Msg Recv From Q Fail - If failure occurred while receiving a message from the queue.<br>Threshold Hit - If threshold value of queue has been hit while sending the message to queue. |

### 5.22.4.3 Reset rmon queue

**Description:**

Use this command to reset some parameters of queue. This command will reset the following parameters of queue.

- Set DropCount value to zero.
- Set watermark value to the value of the currently used size of queue .
- Set ThresholdCount value to the zero.

**Command Syntax:**

Reset rmon queue

**Parameters:**

None

**Example:**

```
$ reset rmon queue
```

**Output Field:**

None

### 5.22.5 RMON Net buffers Info Commands

#### 5.22.5.1 Get rmon netbuf

**Description:**

Use this command to get the information about all the net buffers present in the system.

**Command Syntax:**

```
get rmon netbuf
```

**Parameters**

None

**Example:**

```
$ get rmon netbuf
```



## Output

TotalNetBuf : 116                      TotalUsed : 8  
TotalFree : 7                              WaterMark : 3  
Threshold : 116                          ThresholdHitCount: 0  
AllocFailCount : 0                      FreeFailCount : 0  
LastUserTask : PKEV                      LastFreeTask : PKEV  
LastUserFailTask :                      LastFreeFailTask :  
ThresholdHitTask :  
LastUsedTime : Thu Jan 01 00:04:45 1970  
LastFreeTime : Thu Jan 01 00:05:01 1970  
LastUseFailTime : -  
ThresholdHitTime : -

## Output field:

| Field                    | Description   |
|--------------------------|---|
| <b>TotalNetBuf</b>       | Total number of net buffers present in the system.  |
| <b>TotalUsed</b>         | Total number of net buffers allocated by the system since the system has come up. This is a running counter and never decrements. |
| <b>TotalFree</b>         | Total number of net buffers freed by the system since the system has come up. This is a running counter and never decrements.     |
| <b>WaterMark</b>         | WaterMark of the net buffer i.e. maximum number of net buffers used by the system at some point in time.                          |
| <b>Threshold</b>         | Threshold value set for net buffer in the system in terms of number of net buffers.   |
| <b>ThresholdHitCount</b> | Number of times threshold has been hit for the net buffer.  |
| <b>AllocFailCount</b>    | Number of times net buffer allocation has failed.   |
| <b>FreeFailCount</b>     | Number of times net buffer freeing has failed.  |
| <b>LastUserTask</b>      | Name of the task which has lastly allocated (used)the net buffer.   |
| <b>LastFreeTask</b>      | Name of the task which has lastly deallocated (freed) the net buffer.   |
| <b>LastUserFailTask</b>  | Name of the task which has lastly failed to allocate (used) the net buffer.   |
| <b>LastFreeFailTask</b>  | Name of the task which has lastly failed to deallocate (freed) the net buffer.  |
| <b>ThresholdHitTask</b>  | Name of the task which has lastly allocated (used) the net buffer, causing threshold hit.   |
| <b>LastUsedTime</b>      | The last system time when net buffer was lastly used.   |
| <b>LastFreeTime</b>      | The last system time when net buffer was lastly freed.  |
| <b>LastUseFailTime</b>   | The last system time when the net buffer allocation has lastly failed.  |
| <b>ThresholdHitTime</b>  | The last system time when the threshold has hit while allocating the net buffer.  |

## 5.22.5.2 Get rmon netbuf threshold

### Description:

Use this command to get the critical events logged for the netbuffer. This command will display 20 entries(maximum). Events are logged for netbuffer in the following 3 cases:

- Allocation of net buffer failed.
- Threshold Hit.

### Command Syntax:

```
get rmon netbuf threshold
```

### Parameters:

None

### Example:

```
$ get rmon netbuf threshold
```

### Output:

Task Name : TSK1

ThresholdHitTimeStamp : Thu Jan 01 00:00:39 1970

Event Type : Allocation Fail

### Output field:

| Field                 | Description  |
|-----------------------|--|
| Task Name             | The name of Task which tries to allocate the netbuffer during a critical event.  |
| ThresholdHitTimeStamp | The system time when event logging is done.  |
| Event Type            | Cause of event logging.<br>Its value can be:<br>Allocation Fail - If allocation of net buffer has failed.<br>Threshold Hit - If threshold value of net buffer has been hit while allocation. |

### 5.22.5.3 Reset rmon netbuf

**Description:**

Use this command to reset some parameters of netbuf. This command will reset the following parameters of netbuf.

- Set ThresholdCount value to zero.
- Set AllocFailCount value to zero
- Set WaterMark to the number of net buffers currently used by system.
- Set FreeFailCount value to the zero.

**Command Syntax:**

```
reset rmon netbuf
```

**Parameters:**

None

**Example:**

```
$ reset rmon netbuf
```

**Output Field:**

None

### 5.22.6 RMON Semaphore Info Commands

#### 5.22.6.1 Get rmon semaphore

**Description:**

Use this command to get the information about all the semaphores present in the system.

**Command Syntax:**

```
get rmon semaphore
```

**Parameters:**

None

**Example:**

```
$ get rmon semaphore
```

**Output:**

| Name<br>Task | Count | Suspend Type | Tasks Waiting | First |
|--------------|-------|--------------|---------------|-------|
| -----        |       |              |               |       |
| SACL4        | 1     | FIFO         | 0             | -     |

**Output field:**

| Field               | Description  |
|---------------------|--|
| <b>Name</b>         | This specifies the name of the semaphore.  |
| <b>Count</b>        | This specifies the current instance count of the semaphore.  |
| <b>Suspend Type</b> | This specifies the task suspended type on this semaphore. It can be either FIFO type or priority type. |
| <b>Task Waiting</b> | This specifies the number of tasks waiting on this semaphore.  |
| <b>First Task</b>   | This specifies the name of the first task suspended on the semaphore.                                  |

**5.22.7 RMON Event Group Info Commands****5.22.7.1 Get rmon eventgrp****Description:**

Use this command to get the information about all the event groups present in the system.

**Command Syntax:**

```
get rmon eventgrp
```

**Parameters:**

None

**Example:**

```
$ get rmon eventgrp
```

**Output:**

| Name    | Event Flags | Tasks Waiting | First Task |
|---------|-------------|---------------|------------|
| EDSLM11 | 0           | 1             |            |
| DSLML   |             |               |            |

**Output field:**

| Field               | Description  |
|---------------------|--|
| <b>Name</b>         | This specifies the name of the event flag group.   |
| <b>Count</b>        | This specifies the current event flags.  |
| <b>Suspend Type</b> | This specifies the task suspended type on this semaphore. It can be either FIFO type or priority type. |
| <b>Task Waiting</b> | This specifies the number of tasks waiting on the event flag group.                                    |
| <b>First Task</b>   | This specifies the name of the first task suspended on the event flag group.                           |

## 5.23 SNMP Commands

---

### 5.23.1 SNMP Comm Commands

#### 5.23.1.1 Get snmp comm

**Description:**

Use this command to get.

**Command Syntax:**

**get snmp comm [community <community-val >]**

#### 5.23.1.2 Create snmp comm

**Description:**

Use this command to create.

**Command Syntax:**

**create snmp comm community <community-val > [access ro | rw]**

#### 5.23.1.3 Delete snmp comm

**Description:**

Use this command to delete.

**Command Syntax:**

**delete snmp comm community <community-val>**

**Parameter:**

| Name                                 | Description   |
|--------------------------------------|---|
| <b>community</b><br><community-val > | This specifies the Community name.<br><b>Type:</b> Create — Mandatory<br>Delete — Mandatory<br>Get — Optional   |
| <b>access ro   rw</b>                | This specifies the access permissions given to man-agers with this community name. ro implies Read Only permissions and rw implies Read-Write per-missions.<br><b>Type:</b> Create — Optional<br><b>Default value:</b> ro |

**Example:**

```
$ create snmp comm community public
```

**Output:**

```
Verbose Mode On
Verbose Mode On
Entry Created
```

```
Access community
```

```
-----
```

```
ro    public
Verbose Mode Off:
Entry Created
```

**Output field:**

| Field     | Description  |
|-----------|--|
| community | This specifies the Community name.   |
| Access    | This specifies the access permissions given to managers with this community name.ro implies Read Only permissions and rw implies Read-Write permissions. |

**References:**

- SNMP commands

**5.23.2 SNMP Host Commands****5.23.2.1 Get snmp host****Description:**

Use this command to get.

**Command Syntax:**

```
get snmp host
```

**5.23.2.2 Create snmp host****Description:**

Use this command to create.

**Command Syntax:**

```
create snmp host ip <ip-address > community <community-val >
```

**5.23.2.3 Delete snmp host****Description:**

Use this command to delete.

**Command Syntax:**

```
delete snmp host ip <ip-address > community <community-val >
```

**Parameter:**

| Name                                 | Description   |
|--------------------------------------|---|
| <b>ip</b> <ip-address >              | This specifies the IP address of the manager that has access permissions.<br><b>Type:</b> Create — Mandatory<br>Delete — Mandatory<br>Get — Optional                      |
| <b>community</b><br><community-val > | This specifies the Community name. This must be a valid community in the snmp community table.<br><b>Type:</b> Create — Mandatory<br>Delete — Mandatory<br>Get — Optional |

**Example:**

```
$ create snmp host ip 172.25.34.34 community public
```

**Output:**

Verbose Mode On

Entry Created

```
Host Address      Community
-----
```

```
172.25.34.34    public
```

Verbose Mode Off:

Entry Created



### Output field:

| Field      | Description  |
|------------|--|
| Ip Address | This specifies the IP address of the manager that has access permissions.                      |
| Community  | This specifies the Community name. This must be a valid community in the snmp community table. |

### References:

- SNMP commands

## 5.23.3 SNMP Stats Commands

### 5.23.3.1 Snmp stats

#### Description:

Use this command to get.

#### Command Syntax:

```
get snmp stats
```

### 5.23.3.2 Modify snmp stats

#### Description:

Use this command to modify.

#### Command Syntax:

```
modify snmp stats [authentraps enable | disable]
```

#### Parameter:

| Name                                  | Description   |
|---------------------------------------|---|
| <b>authentraps</b> enable<br> disable | Indicates whether the SNMP agent process is permitted to generate authentication-failure traps. The value of this object overrides any configuration information; as such, it provides a means whereby all authentication-failure traps may be disabled.<br><br><b>Type:</b> Modify — Optional<br><br><b>Default value:</b> disable |

**Example:**

```
$ get snmp stats
```

**Output:**

```
InPkts           : 100           OutPkts           : 100
InBadVersions    : 0             InBadCommunityNames : 0
InBadCommunityUses : 0         InASNParseErrs    : 0
InTooBig        : 0             InNoSuchNames     : 0
InBadValues     : 0             InReadOnly        : 0
InGenErrs       : 0             InTotalReqVars    : 200
InTotalSetVars  : 0             InGetRequests     : 100
InGetNexts      : 0             InSetRequests     : 0
InGetResponses  : 0             InTraps           : 0
OutTooBig       : 0             OutNoSuchNames    : 0
OutBadValues    : 0             OutGenErrs        : 0
OutGetRequests  : 0             OutGetNexts       : 0
OutSetRequests  : 0             OutGetResponses   : 100
OutTraps        : 0             AuthenTraps       : disable
SilentDrops     : 0             ProxyDrops        : 0
```

**Output field:**

| Field                      | Description   |
|----------------------------|---|
| <b>InPkts</b>              | The total number of Messages delivered to the SNMP entity from the transport service.   |
| <b>OutPkts</b>             | The total number of SNMP Messages which were passed from the SNMP protocol entity to the transport service.   |
| <b>InBadVersions</b>       | The total number of SNMP Messages which were delivered to the SNMP protocol entity and were for an unsupported SNMP version.  |
| <b>InBadCommunityNames</b> | The total number of SNMP Messages delivered to the SNMP protocol entity which used a SNMP community name not known to say entity.   |
| <b>InBadCommunityUses</b>  | The total number of SNMP Messages delivered to the SNMP protocol entity which represented an SNMP operation which was not allowed by the SNMP community named in the Message. |
| <b>InASNParseErrs</b>      | The total number of ASN.1 or BER errors encountered by the SNMP protocol entity when decoding received SNMP Messages.   |
| <b>InTooBig</b>            | The total number of SNMP PDUs which were delivered to the SNMP protocol entity and for which the value of the error-status field is 'tooBig'.                                 |
| <b>InNoSuchNames</b>       | The total number of SNMP PDUs which were delivered to the SNMP protocol entity and for which the value of the error-status field is 'noSuchName'.                             |
| <b>InBadValues</b>         | The total number of SNMP PDUs which were delivered to the SNMP protocol   |

|                        |   |
|------------------------|---|
|                        | entity and for which the value of the error-status field is 'badValue'.   |
| <b>InReadOnly</b>      | The total number valid SNMP PDUs which were de-livered to the SNMP protocol entity and for which the value of the error-status field is `readOnly'. It should be noted that it is a protocol error to generate an SNMP PDU which contains the value 'readOnly' in the error-status field, as this object is provided as a means of detecting incorrect implementations of the SNMP. |
| <b>InGenErrs</b>       | The total number of SNMP PDUs which were delivered to the SNMP protocol entity and for which the value of the error-status field is 'genErr'.   |
| <b>InTotalReqVars</b>  | The total number of MIB objects which have been retrieved successfully by the SNMP protocol entity as the result of receiving valid SNMP Get-Request and Get-Next PDUs.   |
| <b>InTotalSetVars</b>  | The total number of MIB objects which have been altered successfully by the SNMP protocol entity as the result of receiving valid SNMP Set-Request PDUs.  |
| <b>InGetRequests</b>   | The total number of SNMP Get-Request PDUs which have been accepted and processed by the SNMP protocol entity.   |
| <b>InGetNexts</b>      | The total number of SNMP Get-Next PDUs which have been accepted and processed by the SNMP protocol entity.  |
| <b>InSetRequests</b>   | The total number of SNMP Set-Request PDUs which have been accepted and processed by the SNMP protocol entity.   |
| <b>InGetResponses</b>  | The total number of SNMP Get-Response PDUs which have been accepted and processed by the SNMP protocol entity.  |
| <b>InTraps</b>         | The total number of SNMP Trap PDUs which have been accepted and processed by the SNMP protocol entity.  |
| <b>OutTooBig</b>       | The total number of SNMP PDUs which were generated by the SNMP protocol entity and for which the value of the error-status field is 'tooBig'.   |
| <b>OutNoSuchNames</b>  | The total number of SNMP PDUs which were generated by the SNMP protocol entity and for which the value of the error-status is 'noSuchName'.   |
| <b>OutBadValues</b>    | The total number of SNMP PDUs which were generated by the SNMP protocol entity and for which the value of the error-status field is 'badValue'.   |
| <b>OutGenErrs</b>      | The total number of SNMP PDUs which were generated by the SNMP protocol entity and for which the value of the error-status field is 'genErr'.   |
| <b>OutGetRequests</b>  | The total number of SNMP Get-Request PDUs which have been generated by the SNMP protocol entity.  |
| <b>OutGetNexts</b>     | The total number of SNMP Get-Next PDUs which have been generated by the SNMP protocol entity.   |
| <b>OutSetRequests</b>  | The total number of SNMP Set-Request PDUs which have been generated by the SNMP protocol entity.  |
| <b>OutGetResponses</b> | The total number of SNMP Get-Response PDUs which have been generated by the SNMP protocol entity.   |

|                    |   |
|--------------------|---|
| <b>OutTraps</b>    | The total number of SNMP Trap PDUs which have been generated by the SNMP protocol entity.   |
| <b>AuthenTraps</b> | Indicates whether the SNMP agent process is permitted to generate authentication-failure traps. The value of this object overrides any configuration information; as such, it provides a means whereby all authentication-failure traps may be disabled.  |
| <b>SilentDrops</b> | The total number of GetRequest-PDUs, GetNextRequest-PDUs, GetBulkRequest-PDUs, SetRequest-PDUs, and InformRequest-PDUs delivered to the SNMP entity which were silently dropped because the size of a reply containing an alternate Response-PDU with an empty variable-bindings field, was greater than, either a local constraint, or the maximum message size associated with the originator of the request. |
| <b>ProxyDrops</b>  | The total number of GetRequest-PDUs, GetNextRequest-PDUs, GetBulkRequest-PDUs, SetRequest-PDUs, and InformRequest-PDUs delivered to the SNMP entity, which were silently dropped, because the transmission of the (possibly translated) message to a proxy target failed in a manner (other than a time-out) such that no Response-PDU could be returned.   |

**References:**

- SNMP commands.

## 5.23.4 SNMP Traphost Commands

### 5.23.4.1 Get snmp traphost

**Description:**

Use this command to get.

**Command Syntax:**

**get snmp traphost** [**ip** <ip-address>] [**port** <port-val >]

### 5.23.4.2 Create snmp traphost

**Description:**

Use this command to create.

**Command Syntax:**

**create snmp traphost ip** <ip-address > **community** <community-val > [**port** <port-val >] [**version** v1 | v2c]

### 5.23.4.3 Delete snmp traphost

**Description:**

Use this command to delete.

**Command Syntax:**

**delete snmp traphost ip < ip-address > [port <port-val >]**

### 5.23.4.4 Modify snmp traphost

**Description:**

Use this command to modify

**Command Syntax:**

**modify snmp traphost ip <ip> [port <port>] [version v1 | v2c] [severity critical | major | minor | info]**

**Parameter:**

| Name  | Description   |
|---|---|
| <b>ip</b> <ip-address >                         | This specifies the IP address of the manager where trap is to be sent.<br><b>Type:</b> Create – Mandatory<br>Delete – Mandatory<br>Modify – Mandatory<br>Get – Optional   |
| <b>port</b> <port-val >                         | This specifies the Port at which the trap is to be sent.<br><b>Type:</b> Create – Optional<br>Get – Optional<br>Modify – Optional<br>Delete – Optional  |
| <b>version v1   v2c</b>                         | This specifies the Trap version to be sent to the Manager.<br><b>Type:</b> Create – Optional<br>Get – Optional<br>Modify – Optional<br><b>Default value:</b> v2c  |
| <b>severity critical   major   minor   info</b> | This specifies the Trap severity which is used for trap classification. The given trap severity will be used for filtering of traps on per manager basis i.e. manager will receive traps on the basis of configured severity<br><b>Type:</b> Create – Optional<br>Modify – Optional |

**Example:**

```
$ create snmp traphost ip 172.25.34.34 port 162 community public version v2c  
severity minor
```

**Output:**

```
Verbose Mode On  
Entry Created
```

```
Ip Address : 172.25.34.34  
Community  : public  
Port       : 162      Version : v2c  
Severity   : minor
```

```
Verbose Mode Off:
```

```
Entry Created
```

**Output field:**

| Field             | Description  |
|-------------------|--|
| <b>Ip Address</b> | This specifies the IP address of the manager where trap is to be sent.   |
| <b>Port</b>       | This specifies the Port at which the trap is to be sent.   |
| <b>Community</b>  | This specifies the Community name used in the trap.  |
| <b>Version</b>    | This specifies the Trap version to be sent to the Manager  |
| <b>Severity</b>   | This specifies the Trap severity which is used for trap classification. The given trap severity will be used for filtering of traps on per manager basis i.e. manager will receive traps on the basis of configured severity |

## 5.24 SNTP Commands

---

### 5.24.1 SNTP Cfg Commands

#### 5.24.1.1 Get sntp cfg

**Description:**

Use this command to get.

**Command Syntax:**

**get sntp cfg**

#### 5.24.1.2 Modify sntp cfg

**Description:**

Use this command to modify.

**Command Syntax:**

**modify sntp cfg [enable | disable]**

**Parameter:**

| Name                  | Description  |
|-----------------------|--|
| <b>enable disable</b> | This specifies whether the SNTP service is enabled or disabled. True means that SNTP is enabled and False means that SNTP is disabled.<br><b>Type:</b> Modify – Optional<br><b>Valid values:</b> enable, disable |

**Example:**

```
$ modify sntp cfg enable
```

**Output:**

Verbose Mode On/Off

Status : Enable

**Output field:**

| Name          | Description   |
|---------------|---|
| <b>Status</b> | This specifies whether the SNTP service is enabled or disabled. True means that SNTP is enabled and False means that SNTP is disabled |

## 5.24.2 SNTP servaddr Commands

### 5.24.2.1 Get sntp servaddr

**Description:**

Use this command to get.

**Command Syntax:**

**get sntp servaddr**

### 5.24.2.2 Create sntp servaddr

**Description:**

Use this command to create.

**Command Syntax:**

**create sntp servaddr <ip-address>**

**Example:**

```
$ create sntp servaddr 172.23.3.45
```

**Output:**

```
Verbose Mode On  
Verbose Mode On  
Entry Created
```

```
Server Addr : 172.23.3.45      Status : Standby  
Verbose Mode Off  
Entry Created
```

**Output field:**

| Field       | Description   |
|-------------|---|
| Server Addr | This specifies the IP Address of the SNTP Server.               |
| Status      | Server is in Use. OR Server is in standby mode i.e. not in use. |



## 5.24.3 SNTP Stats Commands

### 5.24.3.1 Get sntp stats

**Description:**

Use this command to get.

**Command Syntax:**

**get sntp stats**

### 5.24.3.2 Reset sntp stats

**Description:**

Use this command to reset.

**Command Syntax:**

**reset sntp stats**

**Example:**

\$ get sntp stats

**Output:**

Verbose Mode On/Off

Requests count : 0 Response count : 0

Invalid Response count : 0 Lost Response count : 0

Last Time Stamp [MM/DD/YYYY::HH:MM:SS] : Thu Jan 01 00:00:00 1970

**Output field:**

| Field                                  | Description  |
|--|--|
| Requests count                         | This specifies the number of requests sent to SNTP Server.   |
| Responses count                        | This specifies the Number of responses received from SNTP Server.  |
| Invalid Responses count                | This specifies the Number of invalid responses received from SNTP Server.  |
| Lost Responses count                   | This specifies the number of responses which do not come within time limit.  |
| Last Time Stamp [MM/DD/YYYY::HH:MM:SS] | This specifies time at which the local clock was last set or corrected.<br>The display format shall be mm/dd/ yyyy:hr:min:sec. |

## 5.25 System Commands

---

### 5.25.1 Cbuftrace cfg Commands

#### 5.25.1.1 Get cbuftrace cfg

**Description:**

Use this command to get.

**Command Syntax:**

**get cbuftrace cfg [module <module-val>]**

#### 5.25.1.2 Reset cbuftrace cfg

**Description:**

Use this command to reset.

**Command Syntax:**

**reset cbuftrace cfg module <module-val>**

**Parameters:**

| Name                       | Description   |
|----------------------------|---|
| <b>module</b> <module-val> | This specifies the module, for which c-buftrace configuration is to be modified<br><b>Type:</b> Reset -- Mandatory<br>Get -- Optional |

**Example:**

```
$ get cbuftrace cfg module GAG
```

**Output:**

```
module : GAG  
flow   : 3           level : 0xff
```

**Output field:**

| Field         | Description   |
|---------------|---|
| <b>module</b> | This specifies the module, for which c-buftrace configuration is to be modified   |
| <b>flow</b>   | This indicates a Hexadecimal bitmask, which sets the filter for c-buftrace flow.  |
| <b>level</b>  | This indicates a Hexadecimal bitmask, which sets the filter for c-buftrace level. |

## 5.25.2 System Configuration Save and Restore Commands

### 5.25.2.1 Commit

**Description:**

Use this command to commit the active configuration to the flash. This command is not supported

**Command Syntax:**

**commit** [nbsize]

**Parameters:**

None

**Example:**

```
$ commit
```

**Output:**

Set Done

**Caution:**

This command will take some time to execute.

**References:**

reboot command  
Download command.

### 5.25.2.2 Reboot

**Description:**

Use this command to reboot the system and to set the boot configuration.

**Command Syntax:**

**reboot** [**control** <nvram|network>] [**dataplane** <nvram|network>] [**config** <network | default | last | backup | clean | minimum | safe >]

## Parameters:

| Name  | Description   |
|---|---|
| <b>control</b><br><nvram network>                           | <p>This specifies whether the control plane binaries are to be fetched from the network or the binaries already present in NVRAM are to be used.</p> <p><b>Type :</b> Optional</p> <p><b>Default value:</b> Binary present in NVRAM.</p>  |
| <b>dataplane</b><br><nvram network>                         | <p>This specifies whether the data plane binaries are to be fetched from the network or the binaries already present in NVRAM are to be used.</p> <p><b>Type:</b> Optional</p> <p><b>Default value:</b> Binaries present in NVRAM.</p>  |
| <b>config</b> <network default last backup clean minimum m> | <p>This specifies the boot configuration – the &lt;last backup clean minimum&gt; source, from which to boot up. The boot configuration is set to last automatically, whenever a commit command is given. The boot configuration being an optional parameter, if it is not specified, it retains the previous value. So giving reboot after a commit will result in a reboot from the committed configuration.</p> <p>Default: Use Default factory configuration while booting up.<br/>           Backup: Use the Backup configuration to boot the system.<br/>           Last: Use last committed configuration to boot the system.<br/>           Minimum: Use a configuration in which:</p> <ul style="list-style-type: none"> <li>• the size command is executed.</li> <li>• the user (login name and password as root) is created.</li> <li>• an Ethernet interface with IP address 192.168.1.1 mask 255.255.0.0 is created.</li> </ul> <p>Clean: The system comes up with nothing configured.<br/>           Network: The system fetches the default configuration file from the remote host and system comes up with this default configuration, fd.cfg.</p> <p><b>Type :</b> Optional</p> <p><b>Default value:</b> If a reboot is being given for the first time, then the default value is default. Otherwise, the default value is the same as what was given the last time.</p> |

**Mode:**

Super-User.

**Example:**

```
$ reboot
```

**Output:**

None

**Output Fields:**

None

**References:**

Commit command.

## 5.25.3 System Control Table Commands

### 5.25.3.1 Create user

**Description:**

Use this command to create a user account. A maximum two accounts can exist.

**Command Syntax:**

```
create user name <user-name> passwd <password> [root|user]
```

### 5.25.3.2 Delete user

**Description:**

Use this command to delete a user login.

**Command Syntax:**

```
delete user name <user-name>
```

### 5.25.3.3 Get user

**Description:**

Use this command to display information of all the users. Password information is not displayed.

**Command Syntax:**

```
get user
```

## Parameters:

| Name                     | Description   |
|--------------------------|---|
| <b>Name</b> <user-name>  | This specifies the User Name to be created.<br><b>Type:</b> Mandatory<br><b>Valid values:</b> String of up to 64 characters ( 'A'- 'Z', 'a'-'z', '0'-'9','-', '_' ) and any combination of printable characters excluding “.”                               |
| <b>passwd</b> <password> | This specifies the password required by this user to login to the unit.<br><b>Type :</b> Mandatory<br><b>Valid values:</b> String of up to 64 characters ( 'A'- 'Z', 'a'-'z', '0'-'9','-', '_' ) and any combination of printable characters excluding “.”. |
| <b>Root user</b>         | This indicates the privilege level of the user.<br><b>Type :</b> Optional<br><b>Default value:</b> user   |

## Example:

```
$ create user name user1 passwd temp1 user
```

## Output:

Verbose Mode On

Entry Created

```
Privilege      UserName
```

-----

```
user           user1
```

Verbose Mode Off

Entry Created

## Output Fields:

| FIELD            | Description  |
|------------------|--|
| <b>UserName</b>  | This shows the new user login, which has been cre-ated.  |
| <b>Privilege</b> | This represents the privilege level associated with the user name shown. It may be: user, root |

## References:

Delete user command.

get user command

passwd related commands.

### 5.25.3.4 Passwd

#### Description:

Use this command to change the password associated with a user login. An ordinary user may change the password for another user if he knows the old password. However, the root does not need to know a user's existing password before changing it. The passwords are not echoed on to the screen.

#### Command Syntax:

**passwd** [name]

#### Parameters:

| Name        | Description  |
|-------------|--|
| <b>name</b> | <p>The id of the user whose password is to be changed. If not specified then the current user is as-sumed.</p> <p><b>Type:</b> Mandatory, if user is logged in through serial port and user authentication is disabled through se-rial port. Otherwise, Optional.</p> <p><b>Valid values:</b> String of up to 64 characters (All print-able characters except ';')</p> |

#### Mode:

Super-User, User.

#### Example:

Normal Usage

\$passwd

Old Password:

New Password:

Confirm New Password:

Set Done.

Super User (for ordinary user)

\$passwd User1

Enter New Password:

Confirm New Password:

Set Done.

**Output::**

None

**Caution:**

None.

**References:**

user command

## 5.25.4 System crash info Commands

### 5.25.4.1 Get system crash info

**Description:**

This command is used to display a list of crashes that were encountered by the system. This command is not supported on the Flashless system.

**Command Syntax:**

```
get system crash info [numentries <numentries-val>] [showview [general |
ctrlandstatusregs | stackregs | stackinfo | altwinregs | stdwinregs |
stdwinregsdetailed | coprocessorregs] +]
```

**Parameters:**

| Name   | Description   |
|--|---|
| <b>Numentries</b><br><numentries-val>  | This specifies the last <numentries> number of crashes encountered in the system.<br><br><b>Type:</b> Optional<br><b>Valid values:</b> 1 to 128<br><b>Default :</b> 1   |
| <b>showview</b> general  <br>ctrlandstatusregs  <br>stackregs   stackinfo  <br>altwinregs   stdwinregs<br>  stdwinregsdetailed  <br>coprocessorregs] + | The optional showview parameter shall help the user to view selective details of the crash dump. The information on any one or combination of crash dump sections can be retrieved by ORing the following parameters: <ul style="list-style-type: none"> <li>•general</li> <li>•ctrlandstatusregs</li> <li>•stackregs</li> <li>•stackinfo</li> <li>•altwinregs</li> <li>•stdwinregs</li> <li>•stdwinregsdetailed</li> </ul> |



|  |   |
|--|---|
|  | <p>•coprocessorregs</p> <p><b>Note:</b> You cannot use the stdwinregs and stdwinregsdetailed parameters simultaneously.</p> |
|--|---|

**Mode:**

Super-User, User

**Example:**

```
$ get system crash info numentries 1 showview general ctrlndstatusregs
stackregs stackinfo altwinregs stdwinregs coprocessorregs
```

**Output:**

General crash info

```
Crash Id      : 1          Crash IU      : 0
Time of Crash : Thu Jan 01 00:00:43 1970
DP Version    : DP_B02_10_15_09_ip1000a
CP Version    : COL2.10.3.0.060317
Crash Cause   : CP crashed after DP Init
SystemUpTime  Days      Hours      Mins      Secs
-----
0             0         0         43
```

User Crash Info :

Control And Status Registers

```
PSR Reg      : 0x940060c7   Wim Reg      : 0x1
Single Fault PC : 0x4d3cdb8   Single Fault nPC : 0x4d3cdbc
Double Fault PC : 0x0       Double Fault nPC : 0x0
Y Reg MSW     : 0x0       Y Reg LSW     : 0x12345678
Single Fault Trap Num : 0x7   Double Fault Trap Num : 0xffffffff
Fault Status Reg : 0x14     Double Fault Reg : 0xcf70
IER           : 0x2000     Trap Base Reg : 0x4f7a070
```

Alternate Window # 0x1f

```
Reg#:Local   : In      |Reg#:Local   : In      |
0 : 0x0      : 0x0      | 1 : 0x0      : 0x0      |
2 : 0x0      : 0x0      | 3 : 0x0      : 0x0      |
4 : 0x0      : 0x0      | 5 : 0x0      : 0x0      |
6 : 0x0      : 0x0      | 7 : 0x0      : 0x0      |
```

Alternate Window # 0x1e

```
Reg#:Local   : In      |Reg#:Local   : In      |
```

|   |       |       |  |   |       |       |
|---|-------|-------|--|---|-------|-------|
| 0 | : 0x0 | : 0x0 |  | 1 | : 0x0 | : 0x0 |
| 2 | : 0x0 | : 0x0 |  | 3 | : 0x0 | : 0x0 |
| 4 | : 0x0 | : 0x0 |  | 5 | : 0x0 | : 0x0 |
| 6 | : 0x0 | : 0x0 |  | 7 | : 0x0 | : 0x0 |

Alternate Window # 0x1d

|            |       |       |  |            |       |       |  |
|------------|-------|-------|--|------------|-------|-------|--|
| Reg#:Local | :     | In    |  | Reg#:Local | :     | In    |  |
| 0          | : 0x0 | : 0x0 |  | 1          | : 0x0 | : 0x0 |  |
| 2          | : 0x0 | : 0x0 |  | 3          | : 0x0 | : 0x0 |  |
| 4          | : 0x0 | : 0x0 |  | 5          | : 0x0 | : 0x0 |  |
| 6          | : 0x0 | : 0x0 |  | 7          | : 0x0 | : 0x0 |  |

....

....

....

Alternate Window # 0x18

|            |       |       |  |            |       |       |  |
|------------|-------|-------|--|------------|-------|-------|--|
| Reg#:Local | :     | In    |  | Reg#:Local | :     | In    |  |
| 0          | : 0x0 | : 0x0 |  | 1          | : 0x0 | : 0x0 |  |
| 2          | : 0x0 | : 0x0 |  | 3          | : 0x0 | : 0x0 |  |
| 4          | : 0x0 | : 0x0 |  | 5          | : 0x0 | : 0x0 |  |
| 6          | : 0x0 | : 0x0 |  | 7          | : 0x0 | : 0x0 |  |

Current Standard Window Dump # 0x8

Registers : Global : Out : Local : In

New Func Called

|   |              |             |             |              |
|---|--------------|-------------|-------------|--------------|
| 0 | : 0x0        | : 0x0       | : 0x1       | : 0x30800005 |
| 1 | : 0x0        | : 0x0       | : 0x52a7164 | : 0x0        |
| 2 | : 0x7        | : 0x0       | : 0x5c67400 | : 0x2800005  |
| 3 | : 0x18       | : 0x5       | : 0x5c67400 | : 0x2        |
| 4 | : 0x4f6cca8  | : 0x4f6cca8 | : 0x0       | : 0x52bdce0  |
| 5 | : 0x144805cc | : 0x1       | : 0xffff    | : 0x0        |
| 6 | : 0x5c67400  | : 0x52bdbb0 | : 0x59ec    | : 0x52bdc18  |
| 7 | : 0x0        | : 0x4f6e040 | : 0x0       | : 0x4ce765c  |

Standard Window Dump # 0x9

| Registers : | Global       | : | Out          | : | Local       | : | In           |
|-------------|--------------|---|--------------|---|-------------|---|--------------|
| 0           | : 0x0        | : | : 0x30800005 | : | : 0x1       | : | : 0x0        |
| 1           | : 0x0        | : | : 0x0        | : | : 0x52bde30 | : | : 0xf        |
| 2           | : 0x7        | : | : 0x2800005  | : | : 0x2       | : | : 0x4fcfb38  |
| 3           | : 0x18       | : | : 0x2        | : | : 0x5c67400 | : | : 0xf        |
| 4           | : 0x4f6cca8  | : | : 0x52bdce0  | : | : 0x0       | : | : 0x567      |
| 5           | : 0x144805cc | : | : 0x0        | : | : 0x5c67000 | : | : 0x51eb851f |
| 6           | : 0x5c67400  | : | : 0x52bdc18  | : | : 0x0       | : | : 0x52bdc98  |
| 7           | : 0x0        | : | : 0x4ce765c  | : | : 0x0       | : | : 0x4ce591c  |

#### Standard Window Dump # 0xa

| Registers : | Global       | : | Out          | : | Local        | : | In          |
|-------------|--------------|---|--------------|---|--------------|---|-------------|
| 0           | : 0x0        | : | : 0x0        | : | : 0x5b70ed0  | : | : 0x542a810 |
| 1           | : 0x0        | : | : 0xf        | : | : 0x52bde18  | : | : 0x0       |
| 2           | : 0x7        | : | : 0x4fcfb38  | : | : 0x20000000 | : | : 0x5abc6f8 |
| 3           | : 0x18       | : | : 0xf        | : | : 0x0        | : | : 0x542a810 |
| 4           | : 0x4f6cca8  | : | : 0x567      | : | : 0x4f6cbb8  | : | : 0x5c36448 |
| 5           | : 0x144805cc | : | : 0x51eb851f | : | : 0xffffffff | : | : 0x5b69300 |
| 6           | : 0x5c67400  | : | : 0x52bdc98  | : | : 0x0        | : | : 0x52bdd18 |
| 7           | : 0x0        | : | : 0x4ce591c  | : | : 0x52bdcd9  | : | : 0x4ce52f0 |

....

....

....

#### Wim Window # 0x0

| Registers : | Global       | : | Out          | : | Local | : | In          |
|-------------|--------------|---|--------------|---|-------|---|-------------|
| 0           | : 0x0        | : | : 0x0        | : | : 0x0 | : | : 0x0       |
| 1           | : 0x0        | : | : 0xb        | : | : 0x0 | : | : 0x0       |
| 2           | : 0x7        | : | : 0x0        | : | : 0x0 | : | : 0x0       |
| 3           | : 0x18       | : | : 0x5c67400  | : | : 0x0 | : | : 0x0       |
| 4           | : 0x4f6cca8  | : | : 0xffffffff | : | : 0x0 | : | : 0x0       |
| 5           | : 0x144805cc | : | : 0x0        | : | : 0x0 | : | : 0x0       |
| 6           | : 0x5c67400  | : | : 0x52bdff8  | : | : 0x0 | : | : 0x5c67410 |
| 7           | : 0x0        | : | : 0x0        | : | : 0x0 | : | : 0x4f62f7c |

#### Standard Window Dump # 0x1

| Registers : | Global       | : | Out       | : | Local     | : | In        |
|-------------|--------------|---|-----------|---|-----------|---|-----------|
| 0           | : 0x0        | : | 0x0       | : | 0x0       | : | 0x57e2688 |
| 1           | : 0x0        | : | 0x0       | : | 0x52bd8e5 | : | 0x0       |
| 2           | : 0x7        | : | 0x0       | : | 0x1       | : | 0xf7      |
| 3           | : 0x18       | : | 0x0       | : | 0x0       | : | 0xe7      |
| 4           | : 0x4f6cca8  | : | 0x0       | : | 0x0       | : | 0x54758a4 |
| 5           | : 0x144805cc | : | 0x0       | : | 0x0       | : | 0x40      |
| 6           | : 0x5c67400  | : | 0x5c67410 | : | 0x8000    | : | 0x5c67410 |
| 7           | : 0x0        | : | 0x4f62f7c | : | 0x52a69a8 | : | 0x4d501fc |

#### Standard Window Dump # 0x2

| Registers : | Global       | : | Out       | : | Local      | : | In        |
|-------------|--------------|---|-----------|---|------------|---|-----------|
| 0           | : 0x0        | : | 0x57e2688 | : | 0x944060c2 | : | 0xedd     |
| 1           | : 0x0        | : | 0x0       | : | 0x4d4bbec  | : | 0x0       |
| 2           | : 0x7        | : | 0xf7      | : | 0x4d4bbf0  | : | 0x0       |
| 3           | : 0x18       | : | 0xe7      | : | 0x2000708  | : | 0x0       |
| 4           | : 0x4f6cca8  | : | 0x54758a4 | : | 0x0        | : | 0x0       |
| 5           | : 0x144805cc | : | 0x40      | : | 0x5c67000  | : | 0x0       |
| 6           | : 0x5c67400  | : | 0x5c67410 | : | 0x0        | : | 0x5c67410 |
| 7           | : 0x0        | : | 0x4d501fc | : | 0x1        | : | 0x4a58968 |

#### Coprocessor Register Dump

|                |               |                |              |
|----------------|---------------|----------------|--------------|
| CCSR Register  | : 0x2f7f72a7  | CCCRC Register | : 0x7ffffff  |
| CCPR Register  | : 0xfe5bf8b7  |                |              |
| CCIR Register  | : 0xffffffff  | CCIBR Register | : 0xffffffff |
| CCOBR Register | : 0xffffffffe | CCOR Register  | : 0xdfffffff |

#### Call Stack at the time of Crash :

| StackDepth : | CallAddress : | Return Address: | Frame Ptr   | : | StackPtr  |
|--------------|---------------|-----------------|-------------|---|-----------|
| 8            | : 0x4f6e040   | : 0x4ce765c     | : 0x52bdc18 | : | 0x52bdbb0 |
| 7            | : 0x4ce765c   | : 0x4ce591c     | : 0x52bdc98 | : | 0x52bdc18 |
| 6            | : 0x4ce591c   | : 0x4ce52f0     | : 0x52bdd18 | : | 0x52bdc98 |
| 5            | : 0x4ce52f0   | : 0x4ce3140     | : 0x52bdd90 | : | 0x52bdd18 |
| 4            | : 0x4ce3140   | : 0x4ce333c     | : 0x52bde30 | : | 0x52bdd90 |
| 3            | : 0x4ce333c   | : 0x4ce44dc     | : 0x52bdec8 | : | 0x52bde30 |
| 2            | : 0x4ce44dc   | : 0x4f62830     | : 0x52bdf90 | : | 0x52bdec8 |

#### Stack dump at the time of Crash:

0x052bb528: 00 00 00 00 00 00 00 00 00 00 00 00 00 00 00 00

0x052bb538: 00 00 00 00 00 00 00 00 00 00 00 00 00 00 00 00  
 0x052bb548: 00 00 00 00 00 00 00 00 00 00 00 00 00 00 00 00  
 0x052bb558: 00 00 00 00 00 00 00 00 00 00 00 00 00 00 00 00  
 0x052bb568: 00 00 00 00 00 00 00 00 00 00 00 27 00 00 00 00  
 0x052bb578: 00 00 00 00 00 00 04 04 00 00 00 23 00 00 00 00  
 0x052bb588: 00 00 00 00 00 00 04 05 a4 d9 50 00 00 00 00 00  
 0x052bb598: 00 00 00 00 00 00 00 00 00 00 12 34 05 a5 14 68  
 0x052bb5a8: 01 23 45 67 00 00 21 44 00 00 00 00 05 a4 d9 50  
 0x052bb5b8: 05 2b b5 f0 05 bf c4 00 00 00 00 80 00 00 02  
 0x052bb5c8: 05 2b bb d8 04 a4 0a 40 00 00 00 17 ff ff ff  
 0x052bb5d8: 05 2b b5 f0 00 00 00 24 00 00 00 15 05 a4 d9 7c  
 0x052bb5e8: 00 00 3a d4 00 00 00 00 0d 0a 00 40 04 b8 24 78  
 0x052bb5f8: 00 00 00 00 05 a5 14 50 00 00 00 00 00 00 00  
 0x052bb608: 00 00 00 00 00 00 00 00 00 00 00 00 00 00 00  
 0x052bb618: 00 00 00 21 00 00 21 47 00 00 00 00 00 00 00  
 0x052bb628: 00 00 00 00 00 00 00 00 05 a5 14 68 00 00 00  
 0x052bb638: 05 a5 f2 3c 05 2b b0 08 00 00 00 1d 00 00 00 17  
 0x052bb648: cc cc cc cd 00 00 3a d4 00 00 00 01 00 00 00 01  
 0x052bb658: 00 01 38 00 05 a4 d9 50 ff ff ff bc 00 00 3a d4  
 0x052bb668: 00 00 00 01 00 00 00 01 00 00 00 02 05 26 47 f0  
 0x052bb678: 00 00 00 00 05 2b b7 28 05 2b bd 88 05 a5 14 50  
 0x052bb688: 05 2b bd 88 05 2b b7 28 05 a5 14 68 04 a4 43 8c  
 0x052bb698: 00 00 00 00 00 00 00 00 00 00 00 00 05 a6 13 2c  
 0x052bb6a8: 00 00 00 77 00 00 3a d4 00 00 00 00 00 00 00

Task for which stack over flow occur

---

NO Stack Overflow

**Output Fields:**

| Field                | Description  |
|----------------------|--|
| <b>Crash Id</b>      | The crash number.  |
| <b>Crash IU</b>      | The internal processor number.   |
| <b>Time of Crash</b> | This specifies the time of the crash.  |
| <b>DP Version</b>    | Version of Crashed DP  |
| <b>CP Version</b>    | Version of Crashed CP  |
| <b>Crash Cause</b>   | This specifies the crash cause. Following are the possible causes:<br>- Ctrl Transfer To CP Failed |

|  |   |
|--|---|
|  | <ul style="list-style-type: none"> <li>- Crash in CP self processing</li> <li>- DP Init Failure</li> <li>- CP crashed after DP Init</li> <li>- DP crashed after DP Init</li> <li>- DP internal Failure</li> <li>- System in Loop</li> <li>- Crash in DP Processing</li> </ul> |
| <b>SystemUpTime</b>                              | This specifies the system up time in:<br>Days : Hours : Minutes : Seconds   |
| <b>PSR Reg</b>                                   | This specifies the value of the processor state register at the time of the crash.  |
| <b>Wim Reg</b>                                   | The window invalid mask register.   |
| <b>PC</b>  | This specifies the value of the program counter at the time of the crash.   |
| <b>nPC</b>                                       | This specifies the value of the next program counter at the time of the crash.  |
| <b>Y Reg MSW</b>                                 | This specifies the value of MSW of the Y Register at the time of the crash.   |
| <b>Y Reg LSW</b>                                 | This specifies the value of LSW of the Y Register at the time of the crash.   |
| <b>Trap Num</b>                                  | This specifies the number of traps that caused the crash.   |
| <b>Trap Base Reg</b>                             | This specifies the value of the Trap Base register at the time of the crash.  |
| <b>Fault Status Reg</b>                          | This specifies the value of the Fault Status Register at the time of the crash.   |
| <b>Double Fault Reg</b>                          | This specifies the value of the Double Fault Register at the time of the crash.   |
| <b>IER</b>                                       | This specifies the value of the Implementation Extension Register at the time of the crash.   |
| <b>Alternate Window - Reg# Local</b>             | For crashes involving Alternate Windows, this capture specifies all local register for Alternate Windows # 24 to 31 (0x1f to 0x18).   |
| <b>Alternate Window - Reg# In</b>                | For crashes involving Alternate Windows, this capture specifies all input register for Alternate Windows # 24 to 31(0x1f to 0x18).  |
| <b>Standard Window Dump - Registers - Global</b> | The Sparclet Global register.   |
| <b>Standard Window Dump - Registers - Out</b>    | The output registers of the specified Sparclet Window.  |
| <b>Standard Window Dump</b>                      | The local registers of the specified Sparclet Window.   |

|   |  |
|---|--|
| <b>- Registers - Local</b>  |  |
| <b>Standard Window Dump - Registers - In</b>                        | The input registers of the specified Sparclet Window.  |
| <b>CCSR Register</b>  | The CCP Status register.   |
| <b>CCCRC Register</b>   | The CCP CRC register.  |
| <b>CCPR Register</b>  | The CCP Polynomial register.   |
| <b>CCIR Register</b>  | The CCP InReg register.  |
| <b>CCIBR Register</b>   | The CCP InBuf register.  |
| <b>CCOBR Register</b>   | The CCP OutBuf register.   |
| <b>CCOR Register</b>  | The CCP OutReg register.   |
| <b>Stack at the time of the Crash - StackDepth - CallAddress</b>    | The callee function address.   |
| <b>Stack at the time of the Crash - StackDepth - Return Address</b> | The return address back to the caller function.  |
| <b>Stack at the time of the Crash - StackDepth - Frame Ptr</b>      | The frame pointer at the time of the call.   |
| <b>Stack at the time of the Crash - StackDepth - StackPtr</b>       | The stack pointer at the time of the call.   |
| <b>Stack dump at the time of Crash</b>                              | The stack dump at the time of crash. The total size of the dump would be the minimum between the hash define 400 and the total number of bytes actually in the stack.  |
| <b>Tasks for which Stack Overflow Occurred</b>                      | In case the crash is due to stack overflow, the task for which stack overflow has occurred will be displayed here. Otherwise, it would specify that stack overflow hasn't occurred - meaning that the crash is due to some other reason. |

**Note:**

The Current Standard Window dump displays the current dump corresponding to Global, Out, Local, and In.

## 5.25.4.2 Get system crash configinfo

### Description:

This command gets system crash configuration parameters..

### Command Syntax:

**get system crash configinfo**

## 5.25.4.3 Modify system crash configinfo

### Description:

This command modifies system crash configuration parameters

### Command Syntax:

**modify system crash configinfo [action reboot | debug]**

### Parameters:

| Name                       | Description:   |
|----------------------------|--|
| <b>Action</b> reboot debug | This parameter defines the state of the system after a DP IU crashes. If the action is set to reboot, the system shall reboot after DP IU crash. If it is set to debug, the system shall not reboot and a CLI prompt shall be given to the user for further debugging.<br><b>Type</b> :Modify - Optional<br><b>Valid values</b> : reboot - debug |

### Example:

```
$ modify system crash configinfo action reboot
```

### Output:

```
Crash Config Info : reboot
```

### Output Fields:

| Field                    | Description  |
|--------------------------|--|
| <b>Crash Config Info</b> | This parameter defines the state of the system after a DP IU crashes. If the action is set to reboot, the system shall reboot after DP IU crash. If it is set to debug, the system shall not reboot and a CLI prompt shall be given to the user for further debugging. |



## 5.25.5 System info Commands

### 5.25.5.1 Get system info

**Description:**

This command to get system parameters.

**Command Syntax:**

**get system info**

### 5.25.5.2 Modify system info

**Description:**

Use this command to modify the system parameters.

**Command Syntax:**

**modify system info** [**contact** <sys-contact>] [**name** <sys-name>] [**location** <sys-location>] [**vendor** <sys-vendor-info>] [**logthresh** <sys-log-threshold>] [**systemtime** <systemtime>] [**dst** <on |off>] [**timezone** <timezone>]

**Parameters:**

| Name                                   | Description:   |
|--|--|
| <b>contact</b> <sys-contact>           | This contains the textual identification of the contact person for this modem, together with information on how to contact this person<br><b>Type:</b> Optional<br><b>Valid values:</b> String of up to 63 ASCII Characters  |
| <b>name</b> <sys-name>                 | This specifies the name of the modem<br><b>Type:</b> Optional<br><b>Valid values:</b> String of up to 63 ASCII Characters  |
| <b>Location</b> <sys-location>         | This specifies the physical location of this modem <b>Type:</b> Optional<br><b>Valid values:</b> String of up to 63 ASCII Characters   |
| <b>vendor</b><br><sys-vendor-info>     | This contains the vendor-specific information<br><b>Type:</b> Optional<br><b>Valid values:</b> String of up to 63 ASCII Characters   |
| <b>logthresh</b><br><sys-logthreshold> | This specifies the severity level of the trap equal to or lower than that shall be logged. 1 is the lowest and represents critical traps. Changing the parameter's value in a flashless system shall have no effect as there is no NVRAM support present to log traps. <b>Type:</b> Optional |

|                              |   |
|------------------------------|---|
|                              | <b>Valid values:</b> 1-4  |
| <b>Systime</b> <system-time> | <p>This specifies the current system time.</p> <p><b>Type:</b> Optional</p> <p><b>Valid values:</b> System Time String in format. The total string length must be 20 characters. Single digits should be prepended with a `0`, e.g. `1` should be given as `01` mon dd hh:mm:ss year e.g. "Feb 01 21:20:10 2001"</p>  |
| <b>dst</b> <on   off>        | <p>This specifies if the Daylight Savings Time has been enabled or not.</p> <p><b>Type:</b> Optional</p> <p><b>Valid values:</b> on off</p>   |
| <b>timezone</b> <timezone>   | <p>Time zone</p> <p><b>Type:</b> Optional</p> <p><b>Valid values:</b> Given below, are the valid values within ``, followed by their descriptions.</p> <p>"IDLW" - International Date Line West</p> <p>"NT" - Nome</p> <p>"HST" - Hawaii Standard</p> <p>ìCAT" - Central Alaska</p> <p>"AHST" - Alaska-Hawaii Standard</p> <p>"YST" - Yukon Standard</p> <p>"PST" - US Pacific Standard</p> <p>"MST" - US Mountain Standard</p> <p>"CST" - US Central Standard</p> <p>"EST" - US Eastern Standard</p> <p>"AST" - Atlantic Standard</p> <p>"NFST" - Newfoundland Standard</p> <p>"NFT" - Newfoundland</p> <p>"BRST" - Brazil Standard</p> <p>"AT" - Azores</p> <p>ìWAT" - West Africa</p> <p>"GMT" - Greenwich Mean</p> <p>"UTC" - Universal (Coordinated)</p> <p>"WET" - Western European</p> <p>"CET" - Central European</p> <p>"FWT" - French Winter</p> <p>"MET" - Middle European</p> <p>"MEWT" - Middle European Winter</p> <p>"SWT" - Swedish Winter</p> <p>"EET" - Eastern Europe, Russia Zone 1</p> |

|   |
|---|
| "IST" - Israeli Standard  |
| "BT" - Baghdad, Russia Zone 2                                     |
| "IT" - Iran   |
| "ZP4" - "Russia Zone 3"   |
| "ZP5" - "Russia Zone 4"   |
| "INST" - "Indian Standard"  |
| "ZP6" - "Russia Zone 5"   |
| "NST" - "North Sumatra"   |
| "WAST" - West Australian Standard                                 |
| "SSMT" - South Sumatra, Russia Zone 6                             |
| "JT" - Java   |
| "CCT" - China Coast, Russia Zone 7                                |
| "ROK" - Korean Standard   |
| "KST" - Korean Standard   |
| "JST" - Japan Standard, Russia Zone 8                             |
| "CAST" - Central Australian Standard                              |
| "EAST" - Eastern Australian Standard                              |
| "GST" - Guam Standard, Russia Zone 9                              |
| "IDLE" - International Date Line East                             |
| "NZST" - New Zealand Standard                                     |
| "NZT" - New Zealand   |
| Example: \IDLWf , that stands for International Date<br>Line West |

**Example:**

\$ get system info

**Output:**

Verbose Mode On

Description : Columbia  
Name : conexant.com  
Location : Conexant Systems, Inc.,100 Schulz Drive,  
RedBank,NJ 07701,U.S.A  
Contact : Conexant Systems, Inc.,100 Schulz Drive,  
RedBank,NJ 07701,U.S.A  
Vendor : Conexant Systems, Inc.,100 Schulz Drive,  
RedBank,NJ 07701,U.S.A  
LogThreshold : 0  
Object-id : 1.3.6.1.4.1.200  
Up Time(HH:MM:SS) : 5:2:0  
HwVersion : c023b6d3

CPSwVersion : COL2.6.3.0.040707  
 DPSwVersion :  
 System Time : Thu Jan 01 05:02:00 1970  
 Time Zone : GMT  
 DST : off  
 Services : physical datalink internet end-to-end applications

### Output Fields:

| Field               | Description   |
|---------------------|---|
| <b>Description</b>  | This is a textual description of the entity.  |
| <b>Name</b>         | This specifies the name of the system.  |
| <b>Location</b>     | This specifies the physical location of this node.  |
| <b>Contact</b>      | This shows the textual identification of the contact person for this managed node, together with the information on how to contact this person. |
| <b>Vendor</b>       | This shows the vendor-specific information.   |
| <b>LogThreshold</b> | This specifies the severity level of the trap equal to or lower than that shall be logged. 1 is the lowest and represents critical traps.       |
| <b>Object-id</b>    | This shows the vendor's authoritative identification of the network management subsystem contained in the entity.                               |
| <b>Up Time</b>      | This specifies the time in seconds since the system is up.  |
| <b>HwVersion</b>    | This specifies the hardware and firmware version of the system.   |
| <b>CPSwVersion</b>  | This specifies the software version of the CP.  |
| <b>DPSwVersion</b>  | This specifies the software version of the DP.  |
| <b>System Time</b>  | This shows the current system time.   |
| <b>Time Zone</b>    | This specifies the time zone that has been set on the modem.  |
| <b>DST</b>          | This specifies whether Daylight Saving Time has been enabled or not.  |
| <b>Services</b>     | This specifies the functionality provided by this node.<br>These may be: physical, datalink, internet, end-to-end, or applications.             |

### References:

Get/modify nbsize

Get system stats

### 5.25.5.3 Get rmon idletime

#### Description:

Use this command to display a list of idle time records.

#### Command Syntax:

**get rmon idletime** [**numentries** <numentries-val>]

#### Parameters:

| Name                                  | Description:   |
|---------------------------------------|--|
| <b>Numentries</b><br><numentries-val> | This specifies last numentries idle time records to be displayed<br><b>Type:</b> Optional<br><b>Valid values :</b> 1 to 6<br><b>Default :</b> 10 |

#### Mode:

Super-User, User

#### Example:

```
$ get rmon idletime numentries 1
```

#### Output:

```
$get rmon idletime numentries 1
```

```
Start Time                End Time                Total
Idle Util %
Time                      Time
-----
Thu Jan 1 12:34:51 1970 Thu Jan 1 12:35:00 1970 10s  7s  30
```

#### Output Fields:

| FIELD             | Description   |
|-------------------|---|
| <b>Start Time</b> | This specifies the starting time of the period for which the idle time was recorded |
| <b>End Time</b>   | This specifies the end time of the period for which the idle time was recorded      |
| <b>Total Time</b> | This specifies the total time (in seconds) elapsed in this period.                  |
| <b>Idle Time</b>  | This specifies the time (in seconds) for which the                                  |

|               |   |
|---------------|---|
|               | system was idle during this period.   |
| <b>Util %</b> | This specifies the Utilization (in percentage) of the system during this period |

## 5.25.6 System manuf info Commands

### 5.25.6.1 Get system manuf info

#### Description:

This command is used to display manufacturing text information in the system.

#### Command Syntax:

**get system manuf info**

#### Example:

```
$ get system manuf info
```

#### Output:

```
CpeUtopiaMode           : Tx 16 Bit Rx 8 Bit
NetUtopiaMode           : Tx 16 Bit Rx 8 Bit
CpeUtopiaMaster         : True           NetUtopiaMaster         : False
MaxEthMacPhy            : 2           ColumbiaIdSel           : 18
CpeUtopiaFreq           : 40 MHz
Eth Speed                : 100 Mbps
```

| S.No | SelfMacAddr       | EthPortIdSel | EthType   |
|------|-------------------|--------------|-----------|
| 1    | 00:BB:CC:DD:EE:FF | 16           | Data Mgmt |
| 2    | 00:BB:CC:DD:EE:FE | 17           | Data Mgmt |

#### Dsl manuf Text Info

```
Num of LBRams           : 2           Num of Chips           : 2
Num of Ports            : 24          Interface Type         : Host Bus
Chip Type               : G24
Serial Number           : <co-0123456>
Vendor Id               : FFBSGSPN
Version Number          : Z3219
```

| Chip No | Base Addr | LBRam |
|---------|-----------|-------|
| -----   |           |       |

```

1      0x84a00000      0
2      0x84a00c00      1

```

### Logical To Physical Port Mapping

```

-----
[ 0 - 7 ]    0    1    2    3    4    5    6    7
[ 8 - 15 ]   8    9   10   11   12   13   14   15
[ 16 - 23 ]  16   17   18   19   20   21   22   23
[ 24 - 31 ]  24   25   26   27   28   29   30   31
[ 32 - 39 ]  32   33   34   35   36   37   38   39
[ 40 - 47 ]  40   41   42   43   44   45   46   47

```

### UART manuf Text Info

```
-----
```

Num of UARTs : 1

HSSL Port Id : 1                      Baud Rate : 9600

Data Bits : 8                      Stop Bit : 2

Parity : Even                      UART Mode : Polling

Application Type : Console

\$

### Output Fields:

| FIELD                  | Description  |
|------------------------|--|
| <b>CpeUtopiaMode</b>   | Mode of operation of CPE side Utopia interface   |
| <b>NetUtopiaMode</b>   | Mode of operation of NET side Utopia interface   |
| <b>CpeUtopiaMaster</b> | This specifies whether CPE side Utopia interface is master   |
| <b>NetUtopiaMaster</b> | This specifies whether NET side Utopia interface is master   |
| <b>MaxEthMacPhy</b>    | This specifies the maximum number of MACs that can be configured   |
| <b>ColumbiaIdSel</b>   | Specifies the address bit in the PCI bus, which is connected to IDSEL pin of the Columbia                        |
| <b>CpeUtopiaFreq</b>   | CPE Frequency for Utopia Interface   |
| <b>Eth Speed</b>       | This specifies the speed of operation. Supported speeds are – 10 Mbps, 100 Mbps, and 1000 Mbps. It is a bitmask. |
| <b>SelfMacAddr</b>     | This specifies the self MAC address  |
| <b>EthPortIdSel</b>    | This specifies the address bit in the PCI bus, which is connected to IDSEL pin of the Ethernet device            |

|   |  |
|---|--|
| <b>EthType</b>                          | This specifies the Defines the ethernet types – data , mgmt, or both. It is a bitmask.                   |
| <b>Num of LBRams</b>                    | This specifies the number of LBRams in the system.   |
| <b>Num of Chips</b>                     | This specifies the number of Chips in the system.  |
| <b>Num of Ports</b>                     | This specifies the number of Ports per Chip in the system.   |
| <b>Interface Type</b>                   | This specifies the InterfaceType. Following are the values it can take – Host Bus, PCI, Utopia           |
| <b>Chip Type</b>                        | This specifies the Type of Chip – G24, G16, and octane.  |
| <b>Serial Number</b>                    | This specifies the vendor specific string that identifies the vendor equipment.                          |
| <b>Vendor Id</b>                        | This specifies the binary vendor identification field.   |
| <b>Version Number</b>                   | This specifies the vendor specific version number sent by this ATU as part of the initialization message |
| <b>Base Addr</b>                        | This specifies the base address of the chip.   |
| <b>LBRam</b>                            | This specifies the LBRam associated with the chip  |
| <b>Logical To Physical Port Mapping</b> | This specifies the Logical To Physical Port Mapping.   |
| <b>No of UARTs</b>                      | This specifies the number of UARTs configured.   |
| <b>HSSL Port Id</b>                     | This specifies the HSSL port to be used for UART.  |
| <b>Baud Rate</b>                        | This specifies the Baud Rate of the port   |
| <b>Data Bits</b>                        | This specifies the number of data bits to be used  |
| <b>Stop Bit</b>                         | This specifies the stop bits used on HSSL – 1, 2, 1.5  |
| <b>Parity</b>                           | This specifies the parity used on HSSL – even, odd, none   |
| <b>UART Mode</b>                        | This specifies the UART Mode – polling, interrupt based  |
| <b>Application Type</b>                 | This specifies the application name using this UART.   |

## 5.25.7 System reboot info Commands

### 5.25.7.1 Get system reboot info

#### Description:

This command is used for displaying a list of reboot failures that were encountered when the system was trying to come up.

#### Command Syntax:

**get system reboot info [numentries]**



**Parameters:**

| Name                                  | Description:  |
|---------------------------------------|---|
| <b>numentries</b><br><numentries-val> | This specifies the last <numentries> number of reboot failures recorded in the system.<br><br><b>Type:</b> Optional<br><b>Valid values :</b> 1 to 100<br><b>Default :</b> 1 |

**Example:**

```
$ get system reboot info numentries 1
```

**Output :**

Verbose Mode On

CP Bin Version : 1.6

DP Bin Version : 1.8

Time of Reboot : Thu Jan 2 12:34:56 1970

Reboot Failure Cause : DP Init Failure

Reboot Type : Secondary CFG

**Output Fields:**

| FIELD                        | Description  |
|------------------------------|--|
| <b>Control Plane Version</b> | The control Plane Version with which the system could not come up.   |
| <b>Data Plane Version</b>    | The data Plane Version with which the system could not come up.  |
| <b>Time of Reboot</b>        | Time at which the reboot failure occurred.   |
| <b>Type of Reboot</b>        | This tells the type of reboot with which the system is trying to come up. The various possible values are :-<br>Last, Back Up, Default, Minimum, Clean.  |
| <b>Failure Cause</b>         | This tells the various causes of failure that system encountered while rebooting. It can be :-<br>Sdram CP Decompress failed<br>Nvram CP Decompress failed<br>Sdram DP Decompress failed<br>Nvram DP Decompress failed<br>DP Init Failure<br>Nvm CP Nvm DP CI Mismatch<br>Nvm CP Sdram DP CI Mismatch<br>Sdram CP Nvm DP CI Mismatch # |

|                                 |
|---------------------------------|
| Sdram CP Sdram DP CI Mismatch   |
| Sdram CP All DP CI Mismatch     |
| Nvm CP All DP CI Mismatch       |
| Applying Last cfg failed        |
| Applying BackUp cfg failed      |
| Applying Min cfg failed         |
| Applying Nvm FD failed          |
| Applying Sdram FD failed        |
| Nvm CP Last CFG CI Mismatch     |
| Nvm CP Backup CFG CI Mismatch   |
| Sdram CP Last CFG CI Mismatch   |
| Sdram CP Backup CFG CI Mismatch |
| NVRAM CP had invalid sign       |
| SDRAM CP had invalid sign       |
| Control Plane wrongly linked    |
| CP mem req exceeds limit        |
| Applying Clean cfg Failed       |

## 5.25.8 Nsize Commands

### 5.25.8.1 Get nsize

**Description:**

Use this command to view System Sizing parameters available on next boot.

**Command Syntax:**

**get nsize**

### 5.25.8.2 Modify nsize

**Description:**

Use this command to modify System Sizing parameters available on next boot.

**Command Syntax:**

**modify nsize** [ **maxatmport** <maxatmport-val> ] [ **maxvcperport** <maxvcperport-val> ] [ **maxvc** <maxvc-val> ] [ **maxatmoam** <maxatmoam-val> ] [ **maxrmon** <maxrmon-val> ] [ **maxnumethprioqs** <maxnumethprioqs-val> ] [ **maxnumeoaprioqs** <maxnumeoaprioqs-val> ] [ **maxmulticast** <maxmulticast-val> ] [ **maxmac** <maxmac-val> ] [ **maxhashbuck** <maxhashbuck-val> ] [ **maxnumvlan** <maxnumvlan-val> ] [ **maxvlanidval** <maxvlanidval-val> ] [ **maxnumacentry** <maxnumacentry-val> ] [ **devcap IVL** ]

**SVL | none ] [ bridgingmode Restricted | Unrestricted | Residential ]**  
**[ maxhpriortreenodes <maxhpriortreenodes-val> ] [ maxlpriortreenodes**  
**<maxlpriortreenodes-val> ] [ maxclfrtrees <maxclfrtrees-val> ] [ maxclfrprofiles**  
**<maxclfrprofiles-val> ] [ maxinrules <maxinrules-val> ] [ maxoutrules**  
**<maxoutrules-val> ] [ maxinhpriosubrulers <maxinhpriosubrulers-val> ]**  
**[ maxinlpriosubrulers <maxinlpriosubrulers-val> ] [ maxouthpriosubrulers**  
**<maxouthpriosubrulers-val> ] [ maxoutlpriosubrulers <maxoutlpriosubrulers-val> ]**  
**[ mcastcap ivmcapable | svmcapable | none ] [ ridcap irdcapable | srdcapable ]**  
**[ maxnumac <maxnumac-val> ] [ maxnumsrcmac <maxnumsrcmac-val> ]**  
**[ vlanmode nativemode | stackedmode ] [ svlanprotocolid**  
**<svlanprotocolid-val> ] [ tvlanprotocolid <tvlanprotocolid-val> ] [ tvlanid**  
**<tvlanid-val> ] [ abondglbctrlvpi <abondglbctrlvpi-val> ] [ abondglbctrlvci**  
**<abondglbctrlvci-val> ] [ abondglbsidfmt EightBitSid | TwelveBitSid ]**

### Parameters:

| Name  | Description  |
|---|--|
| <b>maxatmport</b><br><maxatmport-val>           | Maximum number of ATM ports that can be configured<br><b>Type:</b> Modify — Optional<br><b>Valid values:</b> 1 -144  |
| <b>maxvcperport</b><br><maxvcperport-val>       | Maximum number of VCs possible per ATM port. <b>Type:</b><br>Modify — Optional<br><b>Valid values:</b> 1 -8  |
| <b>maxvc</b> <maxvc-val>                        | Maximum number of VCs possible in the system. <b>Type:</b><br>Modify — Optional<br><b>Valid values:</b> 1 - (144 * 8)  |
| <b>maxatmoam</b><br><maxatmoam-val>             | Maximum number of OAM activities that can be active at a<br>time.<br><b>Type:</b> Modify — Optional<br><b>Valid values:</b> 1 - 10   |
| <b>maxrmon</b> <maxrmon-val>                    | Maximum number RMON probes that can be applied<br>simultaneously in the system<br><b>Type:</b> Modify — Optional<br><b>Valid values:</b> 1 - 20  |
| <b>maxnumethprioqs</b><br><maxnumethprioqs-val> | This specifies the max number of priority queues that can<br>be configured on a bridge port created over an ethernet<br>interface.<br><b>Type:</b> Modify — Optional<br><b>Valid values:</b> 1 - 8 |
| <b>maxnumeoaprioqs</b><br><maxnumeoaprioqs-val> | This specifies the max number of priority queues that can<br>be configured on a bridge port created on EOA interface   |

|   |   |
|---|---|
|   | <p><b>Type:</b> Modify — Optional</p> <p><b>Valid values:</b> 1 -8</p>  |
| <p><b>maxmulticast</b><br/>&lt;maxmulticast-val&gt;</p>           | <p>Maximum number of multicast groups that can be configured in the system</p> <p><b>Type:</b> Modify — Optional</p> <p><b>Valid values:</b> 1 - 4</p>  |
| <p><b>maxmac</b> &lt;maxmac-val&gt;</p>                           | <p>Maximum number of MAC addresses that can be learned by the system. This should be a multiple of 32</p> <p><b>Type:</b> Modify — Optional</p> <p><b>Valid values:</b> 1 - 4000</p>  |
| <p><b>maxhashbuck</b><br/>&lt;maxhashbuck-val&gt;</p>             | <p>Maximum number of hash buckets for the Forwarding table. This value should be a power of 2. (1, 2, 4, 8 ,...)</p> <p><b>Type:</b> Modify — Optional</p> <p><b>Valid values:</b> 1 - 8192</p>   |
| <p><b>maxnumvlan</b><br/>&lt;maxnumvlan-val&gt;</p>               | <p>Maximum number of VLANs that can be configured on the Bridge either statically or dynamically</p> <p><b>Type:</b> Modify — Optional</p> <p><b>Valid values:</b> 0 - 512</p>  |
| <p><b>maxvlanidval</b><br/>&lt;maxvlanidval-val&gt;</p>           | <p>Maximum value of VLAN ID that this Bridge can support</p> <p><b>Type:</b> Modify — Optional</p> <p><b>Valid values:</b> 1 - 4095</p>   |
| <p><b>maxnumacentry</b><br/>&lt;maxnumacentry-val&gt;</p>         | <p>Maximum number of Static UCast Entries that can be configured on the Bridge</p> <p><b>Type:</b> Modify — Optional</p> <p><b>Valid values:</b> 0 - 512</p>  |
| <p><b>devcap IVL   SVL   none</b></p>                             | <p>Device Capabilities of Q-Bridge MIB. In case of Stacked Vlan Mode this shall apply to Virtual Vlans. <b>Type:</b> Modify — Optional</p>  |
| <p><b>bridgingmode Restricted  Unrestricted   Residential</b></p> | <p>This specifies the state of full bridging on the bridge. Value residential species that packets coming from CPE side would be forwarded to the net side port without a lookup. In case of restricted bridging, the packets would undergo a lookup and if the destination is another CPE port, the packet would be dropped, i.e. CPE to CPE traffic is not allowed. Unrestricted bridging is forwarding based on lookup in all cases.</p> <p><b>Type:</b> Modify — Optional</p> |
| <p><b>maxhprtreenodes</b><br/>&lt;maxhprtreenodes-val&gt;</p>     | <p>Maximum number of classifier tree nodes of high access priority that can be created.</p> <p><b>Type:</b> Modify — Optional</p>   |

|   |   |
|---|---|
|   | <b>Valid values:</b> 1 -32  |
| <b>maxlpriortreenodes</b><br><maxlpriortreenodes-val>     | Maximum number of classifier tree nodes of low access priority that can be created.<br><b>Type:</b> Modify — Optional<br><b>Valid values:</b> 1 -256  |
| <b>maxclfrtrees</b><br><maxclfrtrees-val>                 | Maximum number of classifier trees that can be created.<br><b>Type:</b> Modify — Optional<br><b>Valid values:</b> 1 - 63  |
| <b>maxclfrprofiles</b><br><maxclfrprofiles-val>           | Maximum number of classifier profiles that can be created.<br><b>Type:</b> Modify — Optional<br><b>Valid values:</b> 1 - 61   |
| <b>maxinrules</b><br><maxinrules-val>                     | Maximum number of generic filter ingress rules that can be created.This parameter is deprecated and the value is ignored.<br><b>Type:</b> Modify — Optional<br><b>Valid values:</b> 1 -275                        |
| <b>maxoutrules</b><br><maxoutrules-val>                   | Maximum number of generic filter egress rules that can be created.This parameter is deprecated and the value is ignored.<br><b>Type:</b> Modify — Optional<br><b>Valid values:</b> 1 -25                          |
| <b>maxinhpriosubrulers</b><br><maxinhpriosubrulers-val>   | Maximum number of generic filter ingress subrules of high access priority that can be created.This parameter is deprecated and the value is ignored. <b>Type:</b> Modify — Optional<br><b>Valid values:</b> 1 -75 |
| <b>maxinlpriosubrulers</b><br><maxinlpriosubrulers-val>   | Maximum number of generic filter ingress subrules of low access priority that can be created.This parameter is deprecated and the value is ignored. <b>Type:</b> Modify — Optional<br><b>Valid values:</b> 1 -425 |
| <b>maxouthpriosubrulers</b><br><maxouthpriosubrulers-val> | Maximum number of generic filter egress subrules of high access priority that can be created.This parameter is deprecated and the value is ignored. <b>Type:</b> Modify — Optional<br><b>Valid values:</b> 1 -25  |
| <b>maxoutlpriosubrulers</b><br><maxoutlpriosubrulers-val> | Maximum number of generic filter egress subrules of low access priority that can be created.This parameter is deprecated and the value is ignored. <b>Type:</b> Modify — Optional                                 |

|   |   |
|---|---|
|   | <b>Valid values:</b> 1 -175   |
| <b>mcastcap ivmcapable</b><br><b> svmcapable   none</b> | It denotes the Multicast Device Capability. If the device capability is ivlcapable then svmcapable is not a valid value. If the device capability is neither ivlcapable nor svmcapable then the only valid value for this field is none. If the device capability is ivlcapable or svlcapable then this field can't have value none. ivmcapable and svmcapable can't be set together. In case of Stacked Vlan Mode this shall apply to Virtual Vlan.<br><b>Type:</b> Modify — Optional  |
| <b>ridcap irdcapable</b><br><b> srdcapable</b>          | RID refers to the Routing Information Database. This database contains information about the routes in the system. Each RID identifies a flow and defines route related information for that flow. The RID defines a flow based on the VLAN Id. The database can be of 2 types, IRD( Independent Routing Database) where there are more than one RIDs in the system and each RID defines separate routes in context of itself. If VlanId <X> and RID <X> have been created and the routing database is configured for IRD, than routes in RID <X> shall define flow for packets coming on VLAN Id <X>. The other mode for the database is SRD( Shared Routing Database) where there is a single RID in the system and all flows map to this RID. This RID has to be explicitly created and no more than 1 RID can be created in the system in this mode. Flows for all created VLANs shall map to this RID for routing.<br><b>Type:</b> Modify — Optional |
| <b>maxnumac</b><br><maxnumac-val>                       | It denotes the maximum number of Access Concentrators supported.<br><b>Type:</b> Modify — Optional<br><b>Valid values:</b> 1 - 8  |
| <b>maxnumsrcmac</b><br><maxnumsrcmac-val>               | It denotes the maximum number of Source MAC addresses that can be used across the different PPPOE and IPOE interfaces.<br><b>Type:</b> Modify — Optional<br><b>Valid values:</b> 1 - 8  |
| <b>vlanmode nativemode</b><br><b> stackedmode</b>       | Vlan Mode <b>Type:</b> Modify Optional  |
| <b>svlanprotocolid</b><br><svlanprotocolid-val>         | This specifies the ProtocolId value to be used for Stacked Vlan/Service Vlan/Provider Vlan/Second Vlan tag. It is   |

|   |  |
|---|--|
|   | <p>recommended to keep the value for this different from Protocolld value defined for 802.1q Vlan(0x8100). This attribute is applicable only in 'VLAN Stacking mode'.</p> <p><b>Type:</b> Modify — Optional</p> <p><b>Valid values:</b> 0x8100 - 0xFFFF</p>  |
| <p><b>tvlanprotocolid</b><br/>&lt;tvlanprotocolid-val&gt;</p>                 | <p>This specifies the Protocolld value to be used for Stacked Vlan/Service Vlan/Provider Vlan/Second Vlan tag. It is recommended to keep the value for this different from Protocolld value defined for 802.1q Vlan (0x8100). This attribute is applicable only in 'VLAN Stacking mode'.</p> <p><b>Type:</b> Modify — Optional</p> <p><b>Valid values:</b> 0x8100 — 0xFFFF</p> |
| <p><b>tvlanid</b> &lt;tvlanid-val&gt;</p>                                     | <p>This specifies the Protocolld value to be used for Stacked Vlan/Service Vlan/Provider Vlan/Second Vlan tag. It is recommended to keep the value for this different from Protocolld value defined for 802.1q Vlan(0x8100). This attribute is applicable only in 'VLAN Stacking mode'.</p> <p><b>Type:</b> Modify — Optional</p> <p><b>Valid values:</b> 0 - 4095</p>         |
| <p><b>abondglbctrlvpi</b><br/>&lt;abondglbctrlvpi-val&gt;</p>                 | <p>This VPI value will be used for the control channel which will be created to run the ATM based multi pair bonding protocol. This is a system wide parameter and applies to all the abond group interfaces which can be created in the system. Change in this value will be applied at next boot only.</p> <p><b>Type:</b> Modify — Optional</p>                             |
| <p><b>abondglbctrlvci</b><br/>&lt;abondglbctrlvci-val&gt;</p>                 | <p>This VCI value will be used for the control channel which will be created to run the ATM based multi pair bonding protocol. This is a system wide parameter and applies to all the abond group interfaces which can be created in the system. Change in this value will be applied at next boot only.</p> <p><b>Type:</b> Modify — Optional</p>                             |
| <p><b>abondglbsidfmt</b><br/><b>EightBitSid  </b><br/><b>TwelveBitSid</b></p> | <p>This SID Format value will be used for all the Abond Group Interfaces which can be created in the system. Change in this value will be applied at next boot only.</p> <p><b>Type:</b> Modify — Optional</p>   |

**Example:**

\$ get nbsize

**Output:**

```

Max ATM Ports           : 48           Max VC per Port       : 8
Max VCs                 : 384          Max OAM activities    : 10
Max RMON probes         : 20           Bridging Mode         :
Residential
Max Multicast groups    : 256          Max MAC addresses     : 4000
Max Hash buckets        : 8192         Max Vlans              : 512
Max VlanId Value        : 4095         Max num Static Mac Entries : 512
Dev Capabilities        : IVL
Max Num EOA Prio Qs     : 3           Max Num Eth Prio Qs   : 8
Max High Prio Tree Nodes : 100        Max Low Prio Tree Nodes : 200
Max Clfr Trees          : 63           Max Clfr Profiles     : 63
Max In Rules            : 250          Max Out Rules         : 50
Max In HighPrio SubRules : 100        Max In LowPrio SubRules : 300
Max Out HighPrio SubRules : 50          Max Out LowPrio SubRules : 150
Mcast Capabilities     : ivmcapable
Max Access Concentrators : 2
Max Src MAC Addresses   : 4
Vlan Mode               : 1
S Vlan Protocol Id     : 0x9100     T Vlan Protocol Id    : 0x9200
T Vlan Id               : 1
AbondGlbCtrlVpi        : 0           AbondGlbCtrlVci       : 20
AbondGlbSidFmt         : TwelveBitSID
Ridcap                  : srdcapable

```

**Output Fields:**

| FIELD                     | Description  |
|---------------------------|--|
| <b>Max ATM Ports</b>      | Maximum number of ATM ports that can be configured   |
| <b>Max VC per Port</b>    | Maximum number of VCs possible per ATM port.   |
| <b>Max VCs</b>            | Maximum number of VCs possible in the system.  |
| <b>Max OAM activities</b> | Maximum number of OAM activities that can be active at a time.   |
| <b>Max RMON probes</b>    | Maximum number RMON probes that can be applied simultaneously in the system  |
| <b>Bridging Mode</b>      | This specifies the state of full bridging on the bridge. Value residential species that packets coming from CPE side would be forwarded to the net side port without a lookup. In case of restricted bridging, the packets would undergo a lookup and if the destination is another CPE port, the packet would be dropped, i.e. CPE to CPE traffic is not allowed. Unrestricted bridging is forwarding based on lookup in all cases. |



|                                   |  |
|-----------------------------------|--|
| <b>Max Multicast groups</b>       | Maximum number of multicast groups that can be configured in the system  |
| <b>Max MAC addresses</b>          | Maximum number of MAC addresses that can be learned by the system. This should be a multiple of 32   |
| <b>Max Hash buckets</b>           | Maximum number of hash buckets for the Forwarding table.<br>This value should be a power of 2. (1, 2, 4, 8 ,...)                                     |
| <b>Max Vlans</b>                  | Maximum number of VLANs that can be configured on the Bridge either statically or dynamically  |
| <b>Max VlanId Value</b>           | Maximum value of VLAN ID that this Bridge can support  |
| <b>Max num Static Mac Entries</b> | Maximum number of Static UCast Entries that can be configured on the Bridge  |
| <b>Dev Capabilities</b>           | Device Capabilities of Q-Bridge MIB. In case of Stacked Vlan Mode this shall apply to Virtual Vlans.   |
| <b>Max Num EOA Prio Qs</b>        | This specifies the max number of priority queues that can be configured on a bridge port created on EOA interface                                    |
| <b>Max Num Eth Prio Qs</b>        | This specifies the max number of priority queues that can be configured on a bridge port created over an ethernet interface.                         |
| <b>Max High Prio Tree Nodes</b>   | Maximum number of classifier tree nodes of high access priority that can be created.   |
| <b>Max Low Prio Tree Nodes</b>    | Maximum number of classifier tree nodes of low access priority that can be created.  |
| <b>Max Clfr Trees</b>             | Maximum number of classifier trees that can be created.  |
| <b>Max Clfr Profiles</b>          | Maximum number of classifier profiles that can be created.   |
| <b>3Max In Rules</b>              | Maximum number of generic filter ingress rules that can be created.This parameter is deprecated and the value is ignored.                            |
| <b>Max Out Rules</b>              | Maximum number of generic filter egress rules that can be created.This parameter is deprecated and the value is ignored.                             |
| <b>Max In HighPrio SubRules</b>   | Maximum number of generic filter ingress subrules of high access priority that can be created.This parameter is deprecated and the value is ignored. |
| <b>Max In LowPrio SubRules</b>    | Maximum number of generic filter ingress subrules of low access priority that can be created.This parameter is deprecated and the value is ignored.  |
| <b>Max Out HighPrio SubRules</b>  | Maximum number of generic filter egress subrules of high access priority that can be created.This parameter is deprecated and the value is ignored.  |
| <b>Max Out LowPrio SubRules</b>   | Maximum number of generic filter egress subrules of low access priority that can be created.This parameter is deprecated and the value is ignored.   |
| <b>Mcast Capabilities</b>         | It denotes the Multicast Device Capability. If the device  |

|                                 |  |
|---------------------------------|--|
|                                 | capability is ivlcapable then svlcapable is not a valid value. If the device capability is neither ivlcapable nor svlcapable then the only valid value for this field is none. If the device capability is ivlcapable or svlcapable then this field can't have value none. ivmcapable and svlcapable can't be set together. In case of Stacked Vlan Mode this shall apply to Virtual Vlan. |
| <b>Max Access Concentrators</b> | It denotes the maximum number of Access Concentrators supported.   |
| <b>Max Src MAC Addresses</b>    | It denotes the maximum number of Source MAC addresses that can be used across the different PPPOE and IPOE interfaces.   |
| <b>Vlan Mode</b>                | Vlan Mode  |
| <b>S Vlan Protocol Id</b>       | This specifies the ProtocolId value to be used for Stacked Vlan/Service Vlan/Provider Vlan/Second Vlan tag. It is recommended to keep the value for this different from ProtocolId value defined for 802.1q Vlan(0x8100). This attribute is applicable only in 'VLAN Stacking mode'.   |
| <b>T Vlan Protocol Id</b>       | This specifies the ProtocolId value to be used for Stacked Vlan/Service Vlan/Provider Vlan/Second Vlan tag. It is recommended to keep the value for this different from ProtocolId value defined for 802.1q Vlan(0x8100). This attribute is applicable only in 'VLAN Stacking mode'.   |
| <b>T Vlan Id</b>                | This specifies the ProtocolId value to be used for Stacked Vlan/Service Vlan/Provider Vlan/Second Vlan tag. It is recommended to keep the value for this different from ProtocolId value defined for 802.1q Vlan(0x8100). This attribute is applicable only in 'VLAN Stacking mode'.   |
| <b>AbondGlbCtrlVpi</b>          | This VPI value will be used for the control channel which will be created to run the ATM based multi pair bonding protocol. This is a system wide parameter and applies to all the abond group interfaces which can be created in the system. Change in this value will be applied at next boot only.  |
| <b>AbondGlbCtrlVci</b>          | This VCI value will be used for the control channel which will be created to run the ATM based multi pair bonding protocol. This is a system wide parameter and applies to all the abond group interfaces which can be created in the system. Change in this value will be applied at next boot only.  |
| <b>AbondGlbSidFmt</b>           | This SID Format value will be used for all the Abond Group Interfaces which can be created in the system. Change in this value will be applied at next boot only.  |
| <b>Ridcap</b>                   | RID refers to the Routing Information Database. This database  |

|  |  |
|--|--|
|  | <p>contains information about the routes in the system. Each RID identifies a flow and defines route related information for that flow. The RID defines a flow based on the VLAN Id. The database can be of 2 types, IRD( Independent Routing Database) where there are more than one RIDs in the system and each RID defines separate routes in context of itself. If VlanId &lt;X&gt; and RID &lt;X&gt; have been created and the routing database is configured for IRD, than routes in RID &lt;X&gt; shall define flow for packets coming on VLAN Id &lt;X&gt;. The other mode for the database is SRD( Shared Routing Database) where there is a single RID in the system and all flows map to this RID. This RID has to be explicitly created and no more than 1 RID can be created in the system in this mode. Flows for all created VLANs shall map to this RID for routing.</p> |
|--|--|

## 5.25.9 System Stats Commands

### 5.25.9.1 Get system stats

**Description:**

Use this command to view System Statistics.

**Command Syntax:**

**get system stats**

### 5.25.9.2 Reset system stats

**Description:**

Use this command to reset System Statistics.

**Command Syntax:**

**reset system stats**

**Example:**

\$ get system stats

**Output :**

Verbose Mode On

Verbose Mode On

|                      |      |                          |      |
|----------------------|------|--------------------------|------|
| CPE Ucast Addr Count | : 10 | DnLink Ucast Addr Count  | : 80 |
| NET Ucast Addr Count | : 20 | CPE Learn Entry Discards | : 90 |

DnLink Learn Entry Discards : 30                      NET Learn Entry Discards : 100  
 Dyn Addr Conflicts Static    : 40                      Moved Dyn Addrs Count    : 110  
 Ucast Lookup Fail Count     : 50                      Mcast Lookup Fail Count   : 120  
 Tx Ctl Pkts Count             : 60                      Rx Ctl Pkts Count         : 130  
 Ctl Pkts Discards Count      : 70  
 PPPOE Session Look Up Failures: 5

### Output Fields:

| FIELD                              | Description   |
|------------------------------------|---|
| <b>CPE Ucast Addr Count</b>        | Number of unicast addresses, which were learned from the CPE ports.   |
| <b>DnLink Ucast Addr Count</b>     | Number of unicast addresses, which were learned from the Downlink port.   |
| <b>Learn Entry Discards</b>        | Number of addresses which, were not learned from the CPE ports, due to lack of space in the forwarding table.     |
| <b>DnLink Learn Entry Discards</b> | Number of addresses which, were not learned from the Downlink port, due to lack of space in the forwarding table. |
| <b>Dyn Addr Conflicts Static</b>   | Number of times a learned address conflicted with a static address.   |
| <b>Moved Dyn Addrs Count</b>       | Number of times a learned address moved from one port to another.   |
| <b>Ucast Lookup Fail Count</b>     | Number of times Unicast address lookup failed.  |
| <b>Mcast Lookup Fail Count</b>     | Number of times Multicast address lookup failed.  |
| <b>Tx Ctl Pkts Count</b>           | Number of packets sent to the Control module.   |
| <b>Rx Ctl Pkts Count</b>           | Number of packets received from Control module.   |
| <b>Ctl Pkts Discards Count</b>     | Number Control module packets discarded.  |
| <b>NumNetUcastAddrCount</b>        | Number of unicast addresses which were learned from the Net ports.  |
| <b>NumNetLearnEntryDiscards</b>    | Number of addresses, which were not learned from the Net ports, due to lack of space in the forwarding table.     |

### References:

get/modify system info  
 get/modify nbsize

## 5.25.10 System Traps Commands

### 5.25.10.1 Reset traps

**Description:**

Use this command to delete all trap logs.

**Command Syntax:**

reset traps

**Mode :**

super-user

**Example:**

\$ reset traps

**Output:**

Set Done

**Output Fields:**

None

**References:**

get traps command.

## 5.25.11 System Traps Log Table Commands

### 5.25.11.1 Get traps

**Description:**

Use this command to get the listing of all Trap Log Table entries (tTraps) or the last few tentries (Traps). This command is not supported on a flashless system.

**Command Syntax:**

**get traps** [num-of-traps]

## Parameters:

| Name         | Description  |
|--------------|--|
| Num-of-traps | This specifies the maximum number of (entries) traps to be displayed from trap log table; if not specified then all entries are displayed.<br><b>Type:</b> Optional<br><b>Valid values :</b> 0 to 4294967295 |

## Mode:

Super-User, User

## Example:

```
$ get traps
```

## Output

```
Thu Jan 01 00:00:13 1970 : STATUS ALARM : ATM VC Up :Interface Name--  
aal5-0
```

```
Thu Jan 01 00:00:13 1970 : STATUS ALARM : System Up
```

## Output Fields

| FIELD         | Description  |
|---------------|--|
| Trap time     | This specifies the time at which the trap was logged.  |
| Trap severity | This specifies the severity level of the trap. It can be –<br>CRITICAL ALARM<br>MAJOR ALARM<br>WARNING<br>STATUS ALARM   |
| Trap name     | This specifies the name of the trap. It can be –<br><b>System Init Failed</b> - This trap is originated at the time of system initialization failures. The failure could be due to an internal error or due to a wrong/corrupted configuration file. Trap parameters are Module and Cause.<br><b>System Up</b> - This trap is originated after the unit boots up successfully.<br><b>ADSL ATUC Up</b> - This trap indicates that the DSL port is in data mode.<br><b>ADSL ATUC Down</b> - This trap indicates that the DSL port is no longer in data mode.<br><b>ATM Interface Up</b> - This trap indicates that the ATM port is operationally up. Trap parameter is Interface No.<br><b>ATM Interface Down</b> - This trap indicates that the ATM port is operationally down. Trap parameter is Interface No. |
|               | <b>ETHER Interface Up</b> - This trap indicates that the Ethernet port is  |

|  |   |
|--|---|
|  | <p>operationally up. Trap parameter is Interface No.</p> <p><b>ETHER Interface Down</b> - This trap indicates that the Ethernet port is operationally down. Trap parameter is Interface No.</p> <p><b>ATM VC Up</b> - This trap indicates that the ATM VC is operationally up. Trap parameter is Interface Name.</p> <p><b>ATM VC Down</b> - This trap indicates that the ATM VC is operationally down. Trap parameter is Interface Name.</p> <p>ADSL ATUC Loss of Frame 15-Minute Threshold hit - This trap indicates that 15-minute interval threshold for ATUC Loss of Frame has reached.</p> <p>ADSL ATUC Loss of Signal 15-Minute Threshold hit - This trap indicates that 15-minute interval threshold for ATUC Loss of Signal has reached.</p> <p>ADSL ATUC Loss of Link 15-Minute Threshold hit - This trap indicates that 15-minute interval threshold for ATUC Loss of Link has reached.</p> <p>ADSL ATUC Loss of Power 15-Minute Threshold hit - This trap indicates that 15-minute interval threshold for ATUC Loss of Power has reached.</p> <p>ADSL ATUC Errored Seconds 15-Minute Threshold hit - This trap indicates that 15-minute interval threshold for ATUC Errored Seconds has reached.</p> <p><b>EoA Interface Up</b> – This trap indicates that the EOA interface is operationally up. Trap parameter is Interface name</p> <p><b>EOA Interface Down</b> - This trap indicates that the EOA Interface is operationally down. Trap parameter is Interface Name.</p> <p><b>ADSL Loss of Frame Threshold hit</b> - This trap indicates that Loss of Framing 15-minute interval threshold has reached.</p> |
|  | <p><b>ADSL Loss of Signal Threshold hit</b> - This trap indicates that Loss of Signal 15-minute interval threshold has reached</p> <p>ADSL Loss of Power Threshold hit - This trap indicates that Loss of Power 15-minute interval threshold has reached.</p> <p><b>ADSL Errored Seconds Threshold hit</b> - This trap indicates that Errored Second 15-minute interval threshold has reached</p> <p><b>ADSL ADUC Tx Rate changed</b> - This trap indicates that the ATUCs transmit rate has changed (RADSL mode only).</p> <p><b>ADSL Loss of Link Threshold hit</b>- This trap indicates that Loss of Link 15-minute interval threshold has reached</p> <p><b>ADSL ATUC Init failed</b> - This trap indicates that ATUC initialization failed. See <code>adslAtucCurrStatus</code> for potential reasons</p> <p><b>ADSL Failed Fast Retrans Threshold hit</b> - This trap indicates that Failed Fast Retrans 15-minute threshold has reached</p> <p><b>ADSL ATUC Severely Errored Seconds 15-Minute Threshold hit</b> - This trap indicates that 15-minute interval threshold for ATUC Severely Errored Seconds has reached.</p>  |

|  |  |
|--|--|
|  | <p><b>ADSL ATUC Unavailable Seconds 15-Minute Threshold hit</b> - This trap indicates that 15-minute interval threshold for ATUC Unavailable Seconds has reached.</p> <p><b>ADSL Unavailable Seconds Threshold hit</b> - This trap indicates that unavailable seconds-line 15-minute threshold has reached</p> <p><b>ADSL Severely Errored Seconds Threshold hit</b> - This trap indicates that severely errored seconds-line 15-minute threshold has reached.</p> <p><b>Aggregator Interface Up</b> - This trap indicates that the aggregator interface is operationally up.</p> <p><b>Aggregator Interface Down</b> - This trap indicates that the aggregator interface is operationally down.</p> <p>The OP state of ADSL line &lt;interface name&gt; has changed from &lt;previous status&gt; to &lt;current status&gt;- This trap indicates the change in the operational status of the port.</p> <p><b>ADSL ATUR Loss of Frame Threshold hit</b> - This trap indicates that Loss of Framing 15-minute interval threshold has reached.</p> <p><b>ADSL ATUR Loss of Frame 15-Minute Threshold hit</b> - This trap indicates that 15-minute interval threshold for ATUR Loss of Frame has reached.</p>  |
|  | <p><b>ADSL ATUR Loss of Signal 15-Minute Threshold hit</b> - This trap indicates that 15-minute interval threshold for ATUR Loss of Signal has reached.</p> <p><b>ADSL ATUR Loss of Power 15-Minute Threshold hit</b> - This trap indicates that 15-minute interval threshold for ATUR Loss of Power has reached</p> <p><b>ADSL ATUR Errored Seconds 15-Minute Threshold hit</b> - This trap indicates that 15-minute interval threshold for ATUR Errored Seconds has reached.</p> <p><b>ADSL ATUR Loss of Signal Threshold hit</b> - This trap indicates that Loss of Signal 15-minute interval threshold has reached.</p> <p><b>ADSL ATUR Loss of Power Threshold hit</b> - This rap indicates that Loss of Power 15-minute interval threshold has reached.</p> <p><b>ADSL ATUR Errored Seconds Threshold hit</b> - This trap indicates that Errored Second 15-minute interval threshold has reached.</p> <p><b>ADSL ATUR Rate Changed</b> -This trap indicates that the ATUR rate has changed (RADSL mode only).</p> <p><b>Port binding status changed</b> - This trap indicates that the port on which the mac address has been learned has changed.</p> <p><b>Port binding status changed</b> - This trap indicates that the port on which the tracked MAC address is being received has changed.</p> <p><b>Port binding status learnt</b> - This trap indicates that the particular mac address has been received for the first time. This trap will also be received if the tracked MAC address is received from an existing port and the port from</p> |



|  |   |
|--|---|
|  | <p>which it was earlier received has been deleted by now.</p> <p><b>Failed To Get IP Address</b> - This trap indicates that DHCP client could not get an ip address from DHCP server.</p> <p><b>Chip Lockup Detected</b> - This trap indicates that a chip lockup has occurred.</p> <p><b>Chip Recovery from Lockup OK</b> - This trap indicates that Chip Recovery from Lockup has occurred.</p> <p><b>Chip Recovery from Lockup Failed</b> - This trap indicates that Chip Recovery from Lockup has Failed.</p> <p><b>Chip Preinit CheckSum Failed</b> - This trap indicates that Preinit Checksum for Chip has Failed</p> <p>Xcvr Lockup Detected - This trap indicates that a transceiver lockup has occurred.</p>  |
|  | <p>Xcvr Recovery from Lockup OK - This trap indicates that a transceiver Recovery from Lockup has occurred.</p> <p>Xcvr Recovery from Lockup Failed - This trap indicates that a transceiver Recovery from Lockup has Failed</p> <p>EHDLC Interface Up - This trap indicates that HDLC Interface over EOC is operationally up. Trap Parameter is Interface Index.</p> <p>EHDLC Interface Down - This trap indicates that HDLC Interface over EOC is operationally down. Trap Parameter is Interface Index.</p> <p><b>Control packet Q congestion start</b> - This trap indicates that Congestion has occurred on data plane to Control plane Packet Queue for the Interface.</p> <p><b>Control packet Q congestion stop</b> - This trap indicates that Congestion has stopped on data plane to Control plane Packet Queue for the Interface.</p> <p>Statistics Reset - This trap indicates that Interface Stats has been reset .</p> <p>ADSL ATUC Loss of Frame 1-Day Threshold hit - This trap indicates that 1-Day interval threshold for ATUC Loss of Frame has reached.</p> <p>ADSL ATUC Loss of Signal 1-Day Threshold hit - This trap indicates that 1-Day interval threshold for ATUC Loss of Signal has reached.</p> <p>ADSL ATUC Loss of Link 1-Day Threshold hit - This trap indicates that 1-Day interval threshold for ATUC Loss of Link has reached.</p> <p>ADSL ATUC Loss of Power 1-Day Threshold hit - This trap indicates that 1-Day interval threshold for ATUC Loss of Power has reached.</p> <p>ADSL ATUC Errored Seconds 1-Day Threshold hit - This trap indicates that 1-Day interval threshold for ATUC Errored Seconds has reached.</p> <p>ADSL ATUC Severely Errored Seconds 1-Day Threshold hit - This trap indicates that 1-Day interval threshold for ATUC Severely Errored Seconds has reached.</p> <p>ADSL ATUC Unavailable Seconds 1-Day Threshold hit - This trap indicates that 1-Day interval threshold for ATUC Unavailable Seconds has reached.</p> |

|  |   |
|--|---|
|  | <p>ADSL ATUR Severely Errored Seconds 15-Minute Threshold hit - This trap indicates that 15-Minute interval threshold for ATUR Severely Errored Seconds has reached.</p>  |
|  | <p>ADSL ATUR Unavailable Seconds 15-Minute Threshold hit - This trap indicates that 15-Minute interval threshold for ATUR Unavailable Seconds has reached.</p> <p>ADSL ATUR Loss of Frame 1-Day Threshold hit - This trap indicates that 1-Day interval threshold for ATUR Loss of Frame has reached.</p> <p>ADSL ATUR Loss of Signal 1-Day Threshold hit - This trap indicates that 1-Day interval threshold for ATUR Loss of Signal has reached.</p> <p>ADSL ATUR Loss of Power 1-Day Threshold hit - This trap indicates that 1-Day interval threshold for ATUR Loss of Power has reached</p> <p>ADSL ATUR Errored Seconds 1-Day Threshold hit - This trap indicates that 1-Day interval threshold for ATUR Errored Seconds has reached.</p> <p>ADSL ATUR Severely Errored Seconds 1-Day Threshold hit - This trap indicates that 1-Day interval threshold for ATUR Severely Errored Seconds has reached.</p> <p><b>ADSL ATUR Unavailable Seconds 1-Day Threshold hit</b> - This trap indicates that 1-Day interval threshold for ATUR Unavailable Seconds has reached.</p> <p><b>PPPOE Interface Up</b> - This trap indicates that the PPPoE interface is operationally up. The trap parameter is the interface name.</p> <p><b>PPPOE Interface Down</b> - This trap indicates that the PPPoE interface is operationally down. The trap parameter is the interface name.</p> <p><b>PPPOE Max Tries in Discovery Stage have exceeded for a PPPoE</b> - This trap indicates that the maximum tries for initiation of discovery stage for the PPPoE session establishment has exceeded for the PPPoE interface. The Trap parameter is the interface name.</p> <p><b>PPPR Interface Up</b> - This trap indicates that the PPPR interface is operationally up. The trap parameter is the interface name.</p> <p><b>PPPR Interface Down</b> - This trap indicates that the PPPR interface is operationally down. The trap parameter is the interface name.</p> <p><b>Lock on GAG acquired:</b> This trap specifies that an agent has acquired an exclusive lock on GAG. Requests from other agents will not be serviced by GAG.</p> |

|  |  |
|--|--|
|  | <p><b>Lock on GAG released:</b> This trap specifies that an agent has released lock on GAG. Requests from other agents will now be serviced by GAG.</p> <p><b>Bridge port status transitioned to dormant :</b> This trap specifies that bridge port status has changed to dormant.</p> <p><b>ATM interface out of deficit :</b> This trap specifies that ATM interface is out of deficit.</p> <p><b>ATM VC AAL5 EncapType Changed :</b> This trap specifies that encapsulation type of ATM VC AAL5 has changed.</p> <p><b>AutoSensing Config Change Based Stack Tear DownFailed, RETRY:</b></p> <p><b>Change of Power Management State of ADSL Line:</b> This trap specifies that power management state of ADSL line has changed. Chip Local Bus Access Failed: This trap specifies that power management state of ADSL line has changed.</p> <p><b>IPOA Interface Up:</b> This trap indicates that the IPOA interface is operationally up. The trap parameter is the interface name.</p> <p><b>IPOA Interface Down:</b> This trap indicates that the IPOA interface is operationally down. The trap parameter is the interface name.</p> <p><b>IPOE Interface Up:</b> This trap indicates that the IPOE interface is operationally up. The trap parameter is the interface name.</p> <p><b>IPOE Interface Down:</b> This trap indicates that the IPOE interface is operationally down. The trap parameter is the interface name.</p> <p><b>ABOND Interface Up:</b> This trap indicates that the ABOND interface is operationally up. The trap parameter is the interface name.</p> <p><b>ABOND Interface Down:</b> This trap indicates that the ABOND interface is operationally down. The trap parameter is the interface name.</p> <p><b>VCAGGR Interface Up:</b> This trap indicates that the VCAGGR interface is operationally up. The trap parameter is the interface name.</p> <p><b>VCAGGR Interface Down:</b> This trap indicates that the VCAGGR interface is operationally down. The trap parameter is the interface name.</p> <p><b>SHDSL Loop Attenuation crossing:</b> This trap indicates that the SHDSL loop attenuation is crossing.</p> <p><b>SHDSL SNR crossing:</b> This trap indicates that the SHDSL loop attenuation is crossing.</p> <p><b>SHDSL Errored Seconds 15-Minute Threshold hit :</b> This trap indicates that 15-Minute interval threshold for SHDSL Errored Seconds has reached.</p> |
|  | <p><b>SHDSL Severely Errored Seconds 15-Minute Threshold hit :</b> This trap indicates that 15- minute interval threshold for ATUC Severely Errored Seconds has reached.</p> <p><b>SHDSL CRC Anomalies 15-Minute Threshold hit:</b> This notification indicates that the CRC anomalies threshold (as set in SHDL End point alarm conf profile</p>  |

|  |   |
|--|---|
|  | <p>table) has been reached/exceeded for the SHDSL segment endpoint. Reached/exceeded is determined by comparing the endpoint's CRC anomalies in the current 15-minute interval (as set in SHDSL End Point Curr Table) with the specified threshold.</p> <p><b>SHDSL Loss of Sync Word Seconds 15-Minute Threshold hit:</b> This notification indicates that the Loss of Sync Word (LOSW) seconds threshold (as set in SHDL End point alarm conf profile table) has been reached/exceeded for the SHDSL segment endpoint. Reached/exceeded is determined by comparing the endpoint's LOSW seconds in the current 15-minute interval (as set in SHDSL End Point Curr Table) with the specified threshold.</p> <p><b>SHDSL Unavailable Seconds 15-Minute Threshold hit:</b> This trap indicates that 15-minuteinterval threshold for SHDSL Unavailable Secondshas reached.</p> <p><b>SHDSL Invalid number of Repeaters detected:</b> This trap indicates the number of Invalid repeaters detected.</p> <p><b>SHDSL Loopback Failure detected:</b>This trap indicates that loop back failure has been detected.</p> <p><b>SHDSL Power Backoff Setting changed:</b> This trap specifies that Operational state of VDSL line has changed.</p> <p><b>SHDSL STU-C Init Fail:</b> This notification indicates that STUC failure during initialization due to peer STU not able to support requested configuration</p> <p><b>SHDSL Local Power Loss:</b> This trap specifies that local power loss of SHDSL</p> <p><b>Change of OP state of SHDSL line:</b> This trap specifies change of Operational state of VDSL line.</p> <p><b>SHDSL Framer OH and Defects Trap:</b> This notification indicates a change in values of overhead/defect data transmitted from the remote unit. LOSSD, SEGA, PS, and SEGD values are reported.</p> <p><b>SHDSL STU-C Up:</b> This trap indicates that the SHDSL STU-C is operationally up. The trap parameter is the interface name.</p> |
|  | <p><b>SHDSL STU-C Down:</b> This trap indicates that the SHDSL STU-C is operationally down. The trap parameter is the interface name.</p> <p><b>SHDSL Remote ATM Cell Status Response:</b> This trap indicates that remote ATM Cell status response has been received.</p> <p><b>SHDSL UTC received in response of STU-R Config Request:</b> This notification indicates the remote unit was unable to comply (UTC) with an STU-R Configuration Request -Management (EOC Message Id 18).</p> <p><b>SHDSL UTC received in response of Remote EOC request:</b> This notification provides a generic unable to comply(UTC) indication. If the remote unit is unable to comply with a remote EOC request, this trap indicates the noncompliance of the remote unit.</p> <p><b>SHDSL Generic Failure Trap:</b> This notification reports any failure that has</p>  |

|                        |   |
|------------------------|---|
|                        | occurred while processing any command issued by the customer.   |
| <b>Trap parameters</b> | <p>This specifies additional parameters describing the trap. Different traps have different combinations of trap parameters. There are also some traps with no additional parameters. The parameters can be -</p> <p>Module - &lt;module name&gt;</p> <p>Cause - &lt;failure cause&gt;</p> <p>Interface - &lt;interface name&gt;</p> <p>&lt;user name&gt;</p> <p>IP - &lt;IP address&gt;</p> <p>Port - &lt;port number&gt;</p> <p>VPI - &lt;vpi&gt;</p> <p>VCI - &lt;vci&gt;</p> <p>Current - &lt;current value&gt;</p> <p>Threshold - &lt;threshold value&gt;</p> <p>Previous - &lt;previous value&gt;</p> |

**References:**

- reset traps command
- logthresh parameter in modify system and get system commands.

## 5.25.12 System Version Commands

### 5.25.12.1 Get system version

**Description:**

This command is used to get the information of the versions with which the system has come up.

**Command Syntax:**

**get system version**

**Parameters:**

None

**Example:**

\$ get system version

**Output:**

Verbose Mode On

Control Plane Binary : COL 2.6.0.0.040217

Data Plane Binary : DP\_B02\_06\_19

**Output Fields:**

| FIELD                | Description   |
|----------------------|---|
| Control Plane Binary | This tells about the version of the control plane binary with which the system has come up. |
| Data Plane Binary    | This tells about the version of the data plane binary with which the system has come up.    |

**5.25.13 Trace Log Configuration Commands****5.25.13.1 Get trace cfg****Description:**

Use this command to display the trace configuration for a specific module, or for all modules.

**Command Syntax:**

**get trace cfg** [module <module-name>]

**5.25.13.2 Modify trace cfg****Description:**

Use this command to modify the trace and log configuration for a specific module

**Command Syntax:**

**modify trace cfg module** <module-name> [**flow** <trace-flow>] [**level** <trace-level>] [**syslog|net|stdout**] [**dest** <ip-address>] [**port** <port-number>]

**Parameters:**

| Name                                       | Description   |
|--|---|
| <b>module</b><br><module-name>  <b>all</b> | This specifies the module, for which trace/log configuration is to be modified.<br><br><b>Type</b> : Modify – Mandatory<br>Get – Optional<br><br><b>Valid values:</b> GCOS,OAM, CIN, GAG, CDB, CLI, ATM, EOA, TBG, DSLME, NVM, FFC, DNCD, DATAME, GARP, |

|                            |  |
|----------------------------|--|
|                            | GVRP, LACP   |
| <b>flow</b> <trace-flow>   | This indicates a Hexadecimal bitmask, which sets the filter for trace flow.<br><b>Type</b> : Optional<br><b>Valid values:</b> 0x0 to 0xffffffff  |
| <b>level</b> <trace-level> | This indicates a Hexadecimal bitmask, which sets the filter for trace level.<br><b>Type</b> : Optional<br><b>Valid values:</b> 0x0 to 0xffffffff   |
| <b>syslog net stdout</b>   | This specifies the type of logging to be done. Incase net or syslog is specified then dest and port must be specified.<br><b>Type:</b> Optional  |
| <b>dest</b> <ip-address>   | This specifies the IP address for host for logging for trace type syslog and net. It is invalid incase of trace type stdout<br><b>Type:</b> Mandatory when type is modified to net or syslog; else it is invalid<br><b>Valid values:</b> Any valid class A/B/C IP address    |
| <b>port</b> <port-number>  | Port number on which, host is listening for trace info to be logged incase of trace type syslog and net. It is invalid incase of trace type stdout<br><b>Type:</b> Mandatory when type is modified to net or syslog; else it is invalid<br><b>Valid values:</b> 0-4294967295 |

**Mode:**

Super-User

**Example:**

\$ modify trace cfg module GAG flow 0x1 level 0x1

**Output :**

Verbose Mode On

| Module | Flow | Level | Type   | Destn   | Port |
|--------|------|-------|--------|---------|------|
| GAG    | 0x0  | 0x0   | Stdout | 0.0.0.0 | 0    |

Set Done

| Module | Flow | Level | Type   | Destn   | Port |
|--------|------|-------|--------|---------|------|
| GAG    | 0x1  | 0x1   | Stdout | 0.0.0.0 | 0    |

Verbose Mode Off

Set Done

### Output Fields:

| FIELD         | Description   |
|---------------|---|
| <b>Module</b> | This specifies the module for trace/log config whose information is being displayed: It can be : GCOS,OAM, CIN, GAG, CDB, CLI, ATM, EOA, TBG, DSLME, NVM, FFC, DNCD, DATAME, GARP, GVRP, LACP |
| <b>Flow</b>   | This indicates a Hexadecimal bitmask, which sets the filter for trace flow.   |
| <b>Level</b>  | This indicates a Hexadecimal bitmask, which sets the filter for trace level.  |
| <b>Type</b>   | This specifies the type of logging to be done. It may be: Syslog, Net, Stdout   |
| <b>Destn</b>  | This specifies the IP address for host for logging for trace type syslog and net. It is invalid incase of trace type stdout   |
| <b>Port</b>   | Port number on which host is listening for trace info to be logged incase of trace type syslog and net. It is invalid incase of trace type stdout   |

### References:

- get trace cfg command
- get trace stats command.

## 5.25.14 Trace Log Statistics Commands

### 5.25.14.1 Get trace stats

#### Description:

Use this command to display trace statistics.

#### Command Syntax:

```
get trace stats
```

#### Parameters:

None



**Mode:**

Super-User, User.

**Example:**

```
$ get trace stats
```

**Output:**

Verbose Mode On/Off

Bytes Logged: 2744

Bytes Discarded : 40595

Msgs Logged : 19

Msgs Discarded : 1045

**Output Fields:**

| FIELD                  | Description   |
|------------------------|---|
| <b>Bytes Logged</b>    | This specifies the number of bytes logged by the tracing/logging module.                        |
| <b>Bytes Discarded</b> | This specifies the number of bytes discarded by the tracing/ logging module due to filtering.   |
| <b>Msgs Logged</b>     | This specifies the number of message logged by the tracing/ logging module.                     |
| <b>Msgs Discarded</b>  | This specifies the number of messages discarded by the tracing/logging module due to filtering. |

**References:**

- get trace cfg command
- Modify trace cfg command.

## 5.26 VC Aggregation Commands

---

### 5.26.1 Atm vcaggr intf Commands

#### 5.26.1.1 Get atm vcaggr intf

**Description:**

Use this command to get.

**Command Syntax:**

**get atm vcaggr intf [ifname <interface-name>]**

#### 5.26.1.2 Create atm vcaggr intf

**Description:**

Use this command to create.

**Command Syntax:**

**create atm vcaggr intf ifname <interface-name> mapid <mapid-val>  
defaultdnstrmvc <defaultdnstrmvc-val> [enable | disable]**

#### 5.26.1.3 Delete atm vcaggr intf

**Description:**

Use this command to delete.

**Command Syntax:**

**delete atm vcaggr intf ifname<interface-name>**

#### 5.26.1.4 Modify atm vcaggr intf

**Description:**

Use this command to modify.

**Command Syntax:**

**modify atm vcaggr intf ifname <interface-name> [defaultdnstrmvc  
<defaultdnstrmvc-val>] [enable | disable]**

## Parameters:

| Name  | Description  |
|---|--|
| <b>ifname</b> <interface-name>                  | Name of the VC aggregation interface<br><b>Type:</b> Create – Mandatory<br>Delete – Mandatory<br>Modify – Mandatory<br>Get – Optional<br><b>Valid values:</b> 0 – 142  |
| <b>mapid</b> <mapid-val>                        | It contains the Id of VcAggrMap in VcAggrMap table. The VcAggrMap contains the list of VCs being aggregated and the priority assignment information. Once the aggregation interface is created with the specified MapId, no more entries can be created in the VcAggrMap table for that MapId, however the priority assignment can be modified any time<br><b>Type:</b> Create – Mandatory<br><b>Valid values:</b> 1 - 144 |
| <b>defaultdnstrmvc</b><br><defaultdnstrmvc-val> | Default VC for the VC Aggregation interface. All the downstream priorities that are left unassigned in the VcAggrMap table with the associated MapId, will be mapped to the default VC. Default VC should be one of the VCs associated with MapId in the VcAggrMap table.<br><b>Type:</b> Create – Mandatory<br>Modify – Optional<br><b>Valid values:</b> 0 – 574  |
| <b>enable   disable</b>                         | Administrative status of the interface.<br><b>Type:</b> Create – Optional<br>Modify – Optional<br><b>Valid values:</b> enable, disable<br><b>Default value:</b> enable   |

## Example:

```
$ create atm vcaggr intf ifname VcAggr-0 mapid 1 defaultdnstrmvc aal5-0 enable
```

## Output:

```
Verbose Mode On  
Entry Created
```

```
Ifname           : VcAggr-0  VC MapId       : 1  
default downstream VC : aal5-0
```

Oper Status : Up Admin Status : Down

Verbose Mode Off:  
Entry Created

#### Output Fields:

| FIELD                 | Description   |
|-----------------------|---|
| Ifname                | Name of the VC aggregation interface  |
| VC MapId              | It contains the Id of VcAggrMap in VcAggrMap table. The VcAggrMap contains the list of VCs being aggregated and the priority assignment information. Once the aggregation interface is created with the specified MapId, no more entries can be created in the VcAggrMap table for that MapId, however the priority assignment can be modified any time |
| default downstream VC | Default VC for the VC Aggregation interface. All the downstream priorities that are left unassigned in the VcAggrMap table with the associated MapId, will be mapped to the default VC. Default VC should be one of the VCs associated with MapId in the VcAggrMap table.   |
| Oper Status           | The actual/current state of the interface. It can be either up or down.   |
| Admin Status          | The desired state of the interface. It may be either Up or Down.  |

## 5.26.2 Atm vcaggr map Commands

### 5.26.2.1 Get atm vcaggr map

#### Description:

Use this command to get.

#### Command Syntax:

**get atm vcaggr map [mapid <mapid-val>] [vc <vc-val>]**

### 5.26.2.2 Create atm vcaggr map

**Description:**

Use this command to create.

**Command Syntax:**

```
create atm vcaggr map mapid <mapid-val> vc <vc-val> [dnstrmpriolist  
{0|1|2|3|4|5|6|7} +|none] [upstrmdefprio <upstrmdefprio-val> |none]  
[upstrmregenprio <upstrmregenprio-val> |none]
```

### 5.26.2.3 Delete atm vcaggr map

**Description:**

Use this command to delete.

**Command Syntax:**

```
delete atm vcaggr map mapid <mapid-val>vc <vc-val>
```

### 5.26.2.4 Modify atm vcaggr map

**Description:**

Use this command to modify.

**Command Syntax:**

```
modify atm vcaggr map mapid <mapid-val> vc <vc-val> [dnstrmpriolist  
{0|1|2|3|4|5|6|7} +|none] [upstrmdefprio <upstrmdefprio-val> |none]  
[upstrmregenprio <upstrmregenprio-val> |none]
```

**Parameters:**

| Name              | Description   |
|-------------------|---|
| mapid <mapid-val> | <p>It contains the Id of VcAggregation Map. The VcAggrMap contains the list of VCs being aggregated and the associated priorities in downstream and upstream directions. Once the VC aggregation interface is created with the a MapId, no more entries can be created in the VcAggrMap table for that MapId</p> <p><b>Type:</b> Create -- Mandatory<br/>Delete -- Mandatory<br/>Modify -- Mandatory<br/>Get -- Optional</p> <p><b>Valid values:</b> 1 - 24</p> |

|  |  |
|--|--|
| <b>vc</b> <vc-val>   | Name of the VC to be part of aggregation.<br><b>Type:</b> Create -- Mandatory<br>Delete -- Mandatory<br>Modify -- Mandatory<br>Get -- Optional<br><b>Valid values:</b> 101 -206  |
| <b>dnstrmpriolist</b> 0   1   2   3   4   5   6   7   none | This field specifies the downstream priorities with which the specified VC interface shall be associated under a VC Aggregation interface.<br>This field is used for demultiplexing downstream traffic. A VC can be mapped to multiple priorities. But not two VCs can be mapped to same priority. Value None has special significance. It specifies that this VC is part of VC Aggregation interface but no priority is mapped to it.<br><b>Type:</b> Create -- Optional<br>Modify -- Optional<br><b>Default value:</b> 8 |
| <b>upstrmdefprio</b><br><upstrmdefprio-val>                | Priority parameter to be used for tagging the untagged upstream traffic coming on a VC.<br>Regeneration of priority at bridge level will be done on the basis of this priority.If value None is specified, then bridge port's defprio will be used for tagging the untagged packets<br><b>Type:</b> Create -- Optional<br>Modify -- Optional<br><b>Valid values:</b> 0 -8<br><b>Default value:</b> 8   |
| <b>upstrmregenprio</b><br><upstrmregenprio-val>            | Priority parameter to be used for retagging the tagged upstream traffic coming on a VC.Regeneration of priority at bridge level will be done on the basis of this priority.If value None is specified, then bridge port's priority regeneration map will be used.<br><b>Type:</b> Create -- Optional<br>Modify -- Optional<br><b>Valid values:</b> 0 - 8<br><b>Default value:</b> 8  |

**Example:**

```
$ create atm vcaggr map mapid 1 vc aal5-0 dnstrmpriolist 1 3 7 upstrmdefprio 2
upstrmregenprio 2
```

**Output:**

```
Verbose Mode On
Entry Created
```

```
VC map Id          : 1          VC Intf          : aal5-0
Up Stream Default Priority : 2          Up Stream Regen Priority : 2
Downstream priority Map   : 1 3 7
```

```
Verbose Mode Off:
Entry Created
```

**Output Fields:**

| Field                             | Description   |
|-----------------------------------|---|
| <b>VC map Id</b>                  | It contains the Id of VcAggregation Map. The VcAggrMap contains the list of VCs being aggregated and the associated priorities in downstream and upstream directions. Once the VC aggregation interface is created with the a MapId, no more entries can be created in the VcAggrMap table for that MapId   |
| <b>VC Intf</b>                    | Name of the VC to be part of aggregation.   |
| <b>Up Stream Default Priority</b> | Priority parameter to be used for tagging the untagged upstream traffic coming on a VC. Regeneration of priority at bridge level will be done on the basis of this priority.If value None is specified, then bridge port's defprio will be used for tagging the untagged packets  |
| <b>Up Stream Regen Priority</b>   | Priority parameter to be used for retagging the tagged upstream traffic coming on a VC.Regeneration of priority at bridge level will be done on the basis of this priority.If value None is specified, then bridge port's priority regeneration map will be used.   |
| <b>Downstream priority Map</b>    | This field specifies the downstream priorities with which the specified VC interface shall be associated under a VC Aggregation interface. This field is used for demultiplexing downstream traffic. A VC can be mapped to multiple priorities. But not two VCs can be mapped to same priority. Value None has special significance. It specifies that this VC is part of VC Aggregation interface but no priority is mapped to it. |

## 5.27 VLAN Commands

---

### 5.27.1 GVRP Info Commands

#### 5.27.1.1 Get gvrp info

**Description:**

Use this command to get GVRP information.

**Command Syntax:**

**get gvrp info**

#### 5.27.1.2 Modify gvrp info

**Description:**

Use this command to modify GVRP information.

**Command Syntax:**

**modify gvrp info gvrpstatus enable | disable**

**Parameter:**

| Name                               | Description   |
|------------------------------------|---|
| <b>gvrpstatus</b> enable   disable | The administrative status requested by management for GVRP<br><b>Type:</b> Optional |

**Example:**

```
$ modify gvrp info gvrpstatus enable
```

**Output:**

Verbose Mode On:

VLAN Version Number : 1                      Current VLANS : 1000

GVRP Status                      : enable

Set Done

VLAN Version Number : 1                      Current VLANS : 1000

GVRP Status                      : enable

Verbose Mode Off:

Set Done



## Output Fields:

| Field                      | Description   |
|----------------------------|---|
| <b>VLAN Version Number</b> | Version Number of IEEE802.1Q, that device supports.                         |
| <b>Current VLANS</b>       | The current number of IEEE 802.1Q VLANs that are configured on this device. |
| <b>GVRP Status</b>         | The administrative status requested by management for GVRP.                 |

## References:

gvrp port info commands  
gvrp port stats commands

## 5.27.2 GVRP Port Info Commands

### 5.27.2.1 Get gvrp port info

#### Description:

Use this command to get.

#### Command Syntax:

```
get gvrp port info [portid <portid-val >]
```

### 5.27.2.2 Modify gvrp port info

#### Description:

Use this command to modify.

#### Command Syntax:

```
modify gvrp port info portid <portid-val > [ portvlanid <portvlanid-val > ]  
[ acceptframetypes all | tagged ] [ ingressfiltering true|false ] [ gvrpstatus  
enable | disable ] [ restrictedvlanreg true|false ] [pktpriority <pktpriority-val> ]  
[psvlanid <psvlanid-val> | none] [ppstatus enable | disable] [ctosprofileid  
<ctosprofileid-val> | none]
```

#### Parameter:

| Name                | Description  |
|---------------------|--|
| portid <portid-val> | The bridge port id.<br><b>Type:</b> Modify — Mandatory<br>Get — Optional |

|   |  |
|---|--|
|   | <b>Valid values:</b> 1 - 578   |
| <b>portvlanid</b><br><portvlanid-val>   | The VLAN Identifier.<br><b>Type:</b> Modify — Optional<br><b>Valid values:</b> 1 - 4095  |
| <b>acceptframetypes</b> all<br> tagged  | When this is Tagged, the device will discard untagged frames or Priority-Tagged frames received on this port. When All, untagged frames or Priority-Tagged frames received on this port will be accepted and assigned to the PVID for this port.<br><b>Type:</b> Modify — Optional   |
| <b>ingressfiltering</b> False<br> True  | When this is true, the device will discard incoming frames for VLANs, which do not include this Port in its Member set. When false, the port will accept all incoming frames.<br><b>Type:</b> Modify — Optional<br><b>Valid values:</b> False, True  |
| <b>gvrpstatus</b> enable<br> disable    | The state of GVRP operation on this port. The value 'enable', indicates that GVRP is enabled on this port, as long as 'gvrpstatus' in 'GVRP INFO' command is also enabled for this device. When this is 'disable', even if 'gvrpstatus' in 'GVRP INFO' command is 'enable' for the device, GVRP will be 'disable' on this port. In such a case, any GVRP packets received will be silently discarded and no GVRP registrations will be propagated from other ports. This object affects all GVRP Applicant and Registrar state machines on this port. This configuration shall not be effective for a bridge port created over PPPOE/IPOE interface.<br><b>Type:</b> Modify — Optional |
| <b>restrictedvlanreg</b><br>False  True | The state of Restricted VLAN Registration on this port. If the value of this control is true(1), then creation of a new dynamic VLAN entry is permitted only if there is a Static VLAN Registration Entry for the VLAN concerned, in which, the Registrar Administrative Control value for this port is, Normal Registration. <b>Type:</b> Modify — Optional<br><b>Valid values:</b> False, True   |
| <b>pktpriority</b><br><pktpriority-val> | For the GVRP PDUs generated by the Control Plane, this priority shall be used for choice of traffic class/ Queue on outgoing interface. In case the bridge port is over an Aggregated ATM VC, this will also be used to identify the VC, on which the packet is to be sent.<br><b>Type:</b> Modify — Optional  |

|  |  |
|--|--|
|  | <b>Valid values:</b> 0 - 7   |
| <b>psvlanid</b><br><psvlanid-val>   none           | <p>Port service Vlan Index, the Service VLAN ID assigned to frames received on this port. This is applicable only to Non-Provider ports. The value zero here means that this field is not applicable. psvlanid and ctosprofileid both can be non-zero. But they both can not be zero. In case of bridge port on PPPoE and IPoE interfaces psvlanid value must be non-zero, ctosprofileid is ignored for such a port. For other bridge ports † psvlanid value can be zero. If both psvlanid and ctosprofileid have non-zero value for such ports, the ctosprofileid shall be applied and psvlanid shall be ignored</p> <p><b>Type:</b> Modify — Optional</p> <p><b>Valid values:</b> 0 - 4095</p> |
| <b>ppstatus</b> enable   disable                   | <p>This specifies if the port is a provider port or a Non-Provider port as per Vlan stacking model. This field is applicable only in Vlan stacking scenario. The modification of this parameter is allowed only when the bridge port is disabled. If the value of this field is enable i.e the port is a provider port, then Priority of the incoming C-Vlan tag is kept preserved irrespective of gsvSVlanCvlanQosPreserveMode of the Svlan to which the packet belongs to.</p> <p><b>Type:</b> Modify — Optional</p>   |
| <b>ctosprofileid</b><br><ctosprofileid-val>   none | <p>This specifies the CtoS profileid for the Vlan Map profile associated † with this interface. Value zero for this means no CtoS profile associated with this port. † psvlanid and ctosprofileid both can be non-zero. But they both can not be zero. In case of bridge port on PPPoE and IPoE interfaces psvlanid value must be non-zero, ctosprofileid is ignored for such a port. For other bridge ports † psvlanid value can be zero. If both psvlanid and ctosprofileid have non-zero value for such ports, the ctosprofileid shall be applied and psvlanid shall be ignored.</p> <p><b>Type:</b> Modify — Optional</p> <p><b>Valid values:</b> 0 -4</p>                                   |

**Example:**

\$ get gvrp port info portid 10

**Output:**

Verbose Mode On:

VLAN Version Number : 1                      Current VLANS : 1000

GVRP Status                      : enable

Set Done

VLAN Version Number : 1                      Current VLANS : 1000

GVRP Status                      : enable

Verbose Mode Off:

Set Done

**Output Fields:**

| Field                               | Description  |
|-------------------------------------|--|
| <b>Port Id</b>                      | The bridge port id.  |
| <b>Port VLAN Index</b>              | The VLAN Identifier.   |
| <b>Accept Frame Types</b>           | When this is Tagged, the device will discard untagged frames or Priority-Tagged frames received on this port. When All, untagged frames or Priority-Tagged frames received on this port will be accepted and assigned to the PVID for this port.   |
| <b>Ingress Filtering</b>            | When this is true, the device will discard incoming frames for VLANs, which do not include this Port in its Member set. When false, the port will accept all incoming frames.  |
| <b>Gvrp Status</b>                  | The state of GVRP operation on this port. The value 'enable', indicates that GVRP is enabled on this port, as long as 'gvrpstatus' in 'GVRP INFO' command is also enabled for this device. When this is 'disable', even if 'gvrpstatus' in 'GVRP INFO' command is 'enable' for the device, GVRP will be 'disable' on this port. In such a case, any GVRP packets received will be silently discarded and no GVRP registrations will be propagated from other ports. This object affects all GVRP Applicant and Registrar state machines on this port. This configuration shall not be effective for a bridge port created over PPPOE/IPOE interface. |
| <b>Failed Registrations</b>         | The total number of failed GVRP registrations, for any reason, on this port.   |
| <b>Last Pdu Origin</b>              | The Source MAC Address of the last GVRP message received on this port.   |
| <b>Restricted Vlan Registration</b> | The state of Restricted VLAN Registration on this port. If the value of this control is true(1), then creation of a new dynamic VLAN entry is  |

|                             |   |
|-----------------------------|---|
|                             | permitted only if there is a Static VLAN Registration Entry for the VLAN concerned, in which, the Registrar Administrative Control value for this port is, Normal Registration.   |
| <b>GVRP PacketsPrio'</b>    | For the GVRP PDUs generated by the Control Plane, this priority shall be used for choice of traffic class/ Queue on outgoing interface. In case the bridge port is over an Aggregated ATM VC, this will also be used to identify the VC, on which the packet is to be sent.   |
| <b>PS VLAN Index</b>        | Port service Vlan Index, the Service VLAN ID assigned to frames received on this port. This is applicable only to Non-Provider ports. The value zero here means that this field is not applicable. psvlanid and ctosprofileid both can be non-zero. But they both can not be zero. In case of bridge port on PPPoE and IPoE interfaces psvlanid value must be non-zero, ctosprofileid is ignored for such a port. For other bridge ports† psvlanid value can be zero. If both psvlanid and ctosprofileid have non-zero value for such ports, the ctosprofileid shall be applied and psvlanid shall be ignored |
| <b>Port Provider Status</b> | This specifies if the port is a provider port or a Non-Provider port as per Vlan stacking model. This field is applicable only in Vlan stacking scenario. The modification of this parameter is allowed only when the bridge port is disabled. If the value of this field is GS_STATE_ENABLE i.e the port is a provider port, then Priority of the incoming C-Vlan tag is kept preserved irrespective of gsvSVlanCvlanQosPreserveMode of the Svlan to which the packet belongs to.  |
| <b>CtoS Profile Id</b>      | This specifies the CtoS profileid for the Vlan Map profile associated† with this interface. Value zero for this means no CtoS profile associated with this port.† psvlanid and ctosprofileid both can be non-zero. But they both can not be zero. In case of bridge port on PPPoE and IPoE interfaces psvlanid value must be non-zero, ctosprofileid is ignored for such a port. For other bridge ports† psvlanid value can be zero. If both psvlanid and ctosprofileid have non-zero value for such ports, the ctosprofileid shall be applied and psvlanid shall be ignored.                                 |

## References:

gvrp commands

## 5.27.3 GVRP Port Stats Commands

### 5.27.3.1 Get gvrp port stats

**Description:**

Use this command to get GVRP port statistics.

**Command Syntax:**

**get gvrp port stats** [**portid** <portid-val >]

### 5.27.3.2 Reset gvrp port stats

**Description:**

Use this command to reset GVRP port statistics.

**Command Syntax:**

**reset gvrp port stats portid** <portid-val>

**Parameter:**

| Name                        | Description   |
|-----------------------------|---|
| <b>portid</b> <portid-val > | The bridge port id.<br><b>Type</b> :Optional for all commands<br><b>Valid values:</b> 1-578 |

**Example:**

```
$ get gvrp port stats
```

**Output:**

```
ortId          : 6
Recv Join Empty : 100      Send Join Empty : 100
Recv Join In   : 200      Send Join In    : 200
Recv Empty     : 200      Send Empty      : 200
Recv Leave    : 300      Send Leave      : 300
Recv Leave All : 300      Send Leave All  : 300
Leave Empty Rx  : 300      Leave Empty Tx  : 300
```

**Output Fields:**

| Field                  | Description   |
|------------------------|---|
| <b>PortId</b>          | Index of the Bridge Port.                               |
| <b>Recv Join Empty</b> | Counter for the number of Join Empty Messages received. |

|                        |  |
|------------------------|--|
| <b>Send Join Empty</b> | Counter for the number of Join Empty Messages sent.    |
| <b>Recv Join In</b>    | Counter for the number of Join In Messages received.   |
| <b>Send Join In</b>    | Counter for the number of Join In Messages sent.       |
| <b>Recv Empty</b>      | Counter for the number of Empty Messages received.     |
| <b>Send Empty</b>      | Counter for the number of Empty Messages sent.         |
| <b>Recv Leave</b>      | Counter for the number of Leave Messages received.     |
| <b>Send Leave</b>      | Counter for the number of Leave Messages sent.         |
| <b>Recv Leave All</b>  | Counter for the number of Leave All Messages received. |
| <b>Send Leave All</b>  | Counter for the number of Leave All Messages sent.     |
| <b>Leave Empty Rx</b>  | Counter for the number of Leave Empty Rx received.     |
| <b>Leave Empty Tx</b>  | Counter for the number of Leave Empty Tx sent.         |

**References:**

gvrp commands

## 5.27.4 Vlan curr info Commands

### 5.27.4.1 Get vlan curr info

**Description:**

Use this command to get.

**Command Syntax:**

**get vlan curr info [vlanid <vlanid-val >]**

**Parameters:**

| Name                              | Description   |
|-----------------------------------|---|
| <b>vlanid &lt;vlanid-val &gt;</b> | The VLAN Identifier.<br><b>Type:</b> Get -- Optional<br><b>Valid values:</b> 1 - 4095 |

**Example:**

```
$ get vlan curr info vlanid 45
```

**Output:**

```
VLAN Index           : 45
VLAN Status          : 1
Egress Ports         : 24
Untagged Ports       : 24
Bridging Mode        : Residential
Flood support Status : enable
Broadcast support Status : enable
Reserved Mac Profile Id : 1
```

**Output field:**

| Field                 | Description  |
|-----------------------|--|
| <b>VLAN Index</b>     | The VLAN identifier  |
| <b>VLAN Status</b>    | This value indicates the status of the VLAN Port corresponding to this entry. Other (1) - the entry is for the default VLAN created for the system.<br>Permanent (2) - this entry, corresponding to an entry in dot1qVlanStaticTable, is currently in use and will remain so after the next reset of the device. The port lists for this entry include ports from the equivalent dot1qVlanStaticTable entry and ports learnt dynamically. Dynamic (3) - this entry is currently in use and will remain so until removed by GVRP. There is no static entry for this VLAN and it will be removed when the last port leaves the VLAN. |
| <b>Egress Ports</b>   | The set of ports, which are transmitting traffic for this VLAN, as either tagged or untagged frames.   |
| <b>Untagged Ports</b> | The set of ports, which are transmitting traffic for this VLAN as untagged frames. In Stacked Vlan mode this applies tagging/untagging for C-VLAN.   |
| <b>Bridging Mode</b>  | This specifies the state of full bridging for the Vlan. There can be 3 values associated with this based on global fullBridgingStatus. These values can be restricted bridging, unrestricted full bridging and residential bridging. The user can specify the bridging mode for the vlan in the Dot1qVlanStaticTable table as one of these   |



|                                 |   |
|---------------------------------|---|
|                                 | <p>values; otherwise the vlan inherits the globally set bridging mode. Unrestricted bridging is not applicable for bridge ports created over pppoe interface even though the vlan may be unrestricted. For a Vlan with bridging mode as CrossConnect there is no learning and lookup and there are at most two member ports for it. In band Management traffic cannot run for such a vlan. VLAN here means the 802.1q vlan in case of Native Vlan mode and Virtual Vlan in case of Stacked Vlan Mode.</p> |
| <b>Flood support Status</b>     | <p>This tells if the flooding shall be done for unknown unicast packets for this vlan or not. The unknown unicast packets shall be flooded to all ports for a vlan if global value (present in Dot1dTpInfo) is enabled or throttle and the value per vlan is also enabled else dropped. This field is not applicable if dot1qGsVlanFullBridgingStatus is CrossConnect</p>   |
| <b>Broadcast support Status</b> | <p>This tells if the broadcast shall be done for this vlan or not. The broadcast packets shall be broadcasted on all ports for a vlan if global value (present in Dot1dTpInfo) and the value per vlan are both enabled else dropped. This field is not applicable if dot1qGsVlanFullBridgingStatus is CrossConnect.</p>   |
| <b>Reserved Mac Profile Id</b>  | <p>The Profile associated with this Vlan to be used to determine the behavior for Reserved Mac destined frames. Reserved Mac addresses are the multicast addresses defined as reserved in IEEE 802.1Q and IEEE 802.1ad.</p>   |

## 5.27.5 VLAN mapprofile info Commands

### 5.27.5.1 Get vlan mapprofile info

#### **Description:**

Use this command to get.

**Command Syntax:**

```
get vlan mapprofile info [profileid <profileid-val>]
```

**5.27.5.2 Create vlan mapprofile info****Description:**

Use this command to create.

**Command Syntax:**

```
create vlan mapprofile info profileid <profileid-val>profiletype CtoS
```

**5.27.5.3 Delete vlan mapprofile info****Description:**

Use this command to delete.

**Command Syntax:**

```
delete vlan mapprofile info profileid <profileid-val>
```

**Parameters:**

| Name                      | Description   |
|---------------------------|---|
| profileid <profileid-val> | Vlan Map profile identifier<br><b>Type:</b> Create -- Mandatory<br>Delete -- Mandatory<br>Get -- Optional<br><b>Valid values:</b> 1 - 4 |
| profiletype CToS          | Profile type<br><b>Type:</b> Create -- Mandatory  |

**Example:**

```
$ create vlan mapprofile info profileid 3 profiletype CtoS
```

**Output:**

Verbose Mode On

Entry Created

Profile Id : 3                    Profile Type : CtoS

Verbose Mode Off:

Entry Created

**Output field:**

| Field               | Description                 |
|---------------------|-----------------------------|
| <i>Profile Id</i>   | Vlan Map profile identifier |
| <i>Profile Type</i> | Profile type                |

**References:**

VLAN commands

**5.27.6 Vlan mapprofile param Commands****5.27.6.1 Get vlan mapprofile param****Description:**

Use this command to get.

**Command Syntax:**

**get vlan mapprofile param [profileid <profileid-val>] [vlan1 <vlan1-val>]**

**5.27.6.2 Create vlan mapprofile param****Description:**

Use this command to create.

**Command Syntax:**

**create vlan mapprofile param profileid <profileid-val> vlan1 <vlan1-val>vlan2 <vlan2-val>**

**5.27.6.3 Delete vlan mapprofile param****Description:**

Use this command to delete.

**Command Syntax:**

**delete vlan mapprofile param profileid <profileid-val>vlan1 <vlan1-val>**

**Parameters:**

| Name                      | Description  |
|---------------------------|--|
| profileid <profileid-val> | Vlan Map profile identifier.<br><b>Type:</b> Create -- Mandatory<br>Delete -- Mandatory<br>Get -- Optional |

|                          |   |
|--------------------------|---|
|                          | <b>Valid values:</b> 1 - 4  |
| <b>vlan1</b> <vlan1-val> | <p>This is the first Vlan for the Map entry. In case of CtoS type of profile this is C-VLAN. There can only be single entry for this parameter corresponding to a given profile.</p> <p><b>Type:</b> Create -- Mandatory<br/>Delete -- Mandatory<br/>Get -- Optional</p> <p><b>Valid values:</b> 1 - 4095</p>   |
| <b>vlan2</b> <vlan2-val> | <p>This is the second Vlan for the Map entry. In case of CtoS type of profile this is S-VLAN.</p> <p>GS_UNREGISTERED_VLANID is a special Virtual Vlan Id used for keeping configuration of the traffic for those VLANs that are unknown in the system. The valid range for this field also includes GS_UNREGISTERED_VLANID besides the range 1-GS_CFG_MAX_VLAN_ID. There can only be single entry for this parameter corresponding to a given profile.</p> <p><b>Type:</b> Create -- Mandatory</p> <p><b>Valid values:</b> 1 - 4095</p> |

### Example:

```
$ create vlan mapprofile param profileid 1 vlan1 1 vlan2 2
```

### Output:

```
Verbose Mode On
Entry Created
```

```
Profile Id : 1          Vlan 1 : 1
Vlan 2      : 2
```

```
Verbose Mode Off:
```

```
Entry Created
```

### Output field:

| Field             | Description   |
|-------------------|---|
| <b>Profile Id</b> | Vlan Map profile identifier.  |
| <b>Vlan 1</b>     | This is the first Vlan for the Map entry. In case of CtoS type of profile this is C-VLAN. There can only be single entry for this parameter corresponding to a given profile. |

|               |  |
|---------------|--|
| <b>Vlan 2</b> | <p>This is the second Vlan for the Map entry. In case of CtoS type of profile this is S-VLAN.</p> <p>GS_UNREGISTERED_VLANID is a special Virtual Vlan Id used for keeping configuration of the traffic for those VLANs that are unknown in the system. The valid range for this field also includes GS_UNREGISTERED_VLANID besides the range 1-4097. There can only be single entry for this parameter corresponding to a given profile.</p> |
|---------------|--|

### References:

VLAN commands

## 5.27.7 VLAN Static Commands

### 5.27.7.1 Get vlan static

#### Description:

Use this command to get.

#### Command Syntax:

```
get vlan static [vlanname <vlan-name>] [vlanid <vlanid-val>]
```

### 5.27.7.2 Create vlan static

#### Description:

Use this command to create.

#### Command Syntax:

```
create vlan static  vlanname <vlan-name>vlanid <vlanid-val> [ egressports
<egressports-val> ] [ forbidegressports <forbidegressports-val> ]
[ untaggedports <untaggedports-val> ] [ bridgingmode Restricted | Unrestricted |
Residential | CrossConnect ] [ floodsupport enable | disable ] [ bcstsupport
enable | disable ] [ resvmacprofileid <resvmacprofileid-val> ] [ igmpsnoopaction
Drop | TransparentlyForward | Learn ] [ igmpsnoopproxyreporting Enable |
Disable ] [ igmpsnoopingressprio <igmpsnoopingressprio-val> | none ]
[ darpstatus Enable | Disable ] [ darpfailedhandling Drop | TransparentForward
| FloodTrustedPorts ] [ drabcasttoucst Enable | Disable ] [ bngmac
<bngmac-val> ] [ drastatus Enable | Disable ] [ piastatus Enable | Disable ]
[ findoneportfailact drop | floodtrusted | TransparentlyForward ]
```

### 5.27.7.3 Modify vlan static

#### Description:

Use this command to modify.

#### Command Syntax:

```
modify vlan static vlanname <vlan-name>vlanid <vlanid-val> [ egressports <egressports-val> ] [ forbidegressports <forbidegressports-val> ] [ untaggedports <untaggedports-val> ] [ bridgingmode Restricted | Unrestricted | Residential | CrossConnect ] [ floodsupport enable | disable ] [ bcastsupport enable | disable ] [ resvmacprofileid <resvmacprofileid-val> ] [ igmpsnoopaction Drop | TransparentlyForward | Learn ] [ igmpsnoopproxyreporting Enable | Disable ] [ igmpsnoopingressprio <igmpsnoopingressprio-val> | none ] [ darptestatus Enable | Disable ] [ darptestfailedhandling Drop | TransparentForward | FloodTrustedPorts ] [ drabcasttoucast Enable | Disable ] [ bngmac <bngmac-val> ] [ drastatus Enable | Disable ] [ piastatus Enable | Disable ] [ findoneportfailact drop | floodtrusted | TransparentlyForward ]
```

### 5.27.7.4 Delete vlan static

#### Description:

Use this command to delete.

#### Command Syntax:

```
delete vlan static vlanname <vlanname-val > | vlanid <vlanid-val >
```

#### Parameters:

| Name                            | Description  |
|---------------------------------|--|
| <b>vlanname</b> <vlanname-val > | An administratively assigned string, which may be used to identify the VLAN. This is mandatory in the case of create cmd. In case of get/modify/delete - either vlan name or vlan id can be given.<br><b>Type:</b> Create -- Mandatory<br>Delete -- Mandatory<br>Modify -- Mandatory<br>Get -- Optional  |
| <b>vlanid</b> <vlanid-val       | The VLAN Identifier. GS_UNREGISTERED_VLANID is a special Vlan Id used for managing the traffic for those VLANs that are neither created nor learned in the system. The valid range for this field also includes GS_UNREGISTERED_VLANID besides the range 1-4095<br><b>Type:</b> Create -- Mandatory<br>Delete -- Mandatory<br>Modify -- Mandatory<br>Get -- Optional |

|  |   |
|--|---|
|  | <b>Valid values:</b> 1 - 4095   |
| <b>egressports</b><br><egressports-val>  | The set of ports, which are permanently assigned to the egress list for this VLAN by management<br><b>Type:</b> Create -- Optional<br>Modify -- Optional<br><b>Default value:</b> 0   |
| <b>forbidegressports</b><br><forbidegressports-val>                              | The set of ports which are prohibited by management from being included in the egress list for this VLAN.<br><b>Type:</b> Create -- Optional<br>Modify -- Optional<br><b>Default value:</b> 0   |
| <b>untaggedports</b><br><untaggedports-val>                                      | The set of ports, which should transmit egress packets for this VLAN, as untagged.<br><b>Type:</b> Create -- Optional<br>Modify -- Optional<br><b>Default value:</b> 0  |
| <b>bridgingmode</b> Restricted  <br>Unrestricted   Residential  <br>CrossConnect | This specifies the state of full bridging for the VLAN. There can be three values associated with this, based on global fullBridgingStatus. These values can be restricted bridging, unrestricted full bridging and residential bridging. If the user does not specify the bridging mode at the time of VLAN creation, the VLAN inherits the globally set bridging mode. The user can modify bridging mode for a created VLAN. If the dynamic entry for the VLAN to be created already exists, the user can only specify globally set bridging mode for this VLAN. The bridging modes are defined as Restricted Full Bridging, Unrestricted full bridging and Residential bridging. The default residential VLAN, like any other residential VLAN allows only one net side bridge port as its member. This port shall be added automatically to the default VLAN if it is the only net side bridge port being added to the VLAN. Subsequently, the user can add another net side port to the egressportslist and untaggedportslist only after removing the previously added net side bridge port. Unrestricted bridging is not applicable for bridge ports created over the PPPoE interface even though the VLAN may be unrestricted.<br><b>Type:</b> Create -- Optional<br>Modify -- Optional<br><b>Valid values:</b> usly added net side bridge port. Unrestricted bridging is not applicable for bridge ports created over the PPPoE interface even though the VLAN may be unrestricted. |

|  |  |
|--|--|
|  | <b>Default value:</b> Residential bridging   |
| <b>floodsupport</b> enable   disable                       | <p>This specifies if the flooding has to be done for unknown unicast packets for this vlan or not. The default value for this shall be taken from enable when vlan is created. The unknown unicast packets shall be flooded on all ports for a vlan if global value (present in Dot1dTpInfo) is enabled or throttle, and the value per vlan is also enabled else dropped.</p> <p><b>Type:</b> Create -- Optional<br/>Modify -- Optional</p> <p><b>Default value:</b> enable</p>  |
| <b>bcastsupport</b> enable   disable                       | <p>This specifies if the broadcast has to be done for this vlan or not. The default value for this shall be taken from enable when vlan is created. The broadcast packets shall be flooded on all ports for a vlan if global value (present in Dot1dTpInfo) and the value per vlan are both enabled else dropped.</p> <p><b>Type:</b> Create -- Optional<br/>Modify -- Optional</p> <p><b>Default value:</b>enable</p>   |
| <b>resvmacprofileid</b><br><resvmacprofileid-val>          | <p>The Profile associated with this Vlan to be used to determine the behavior for Reserved Mac destined frames. Reserved Mac addresses are the multicast addresses defined as reserved in IEEE 802.1Q and IEEE 802.1ad. The existence of the specified "ResvdCtlPktProfile Table" entry is a must for VLAN static entry creation to succeed. Further, even if the specified "ResvdCtlPktProfile Table" entry exists, but the corresponding entry in "ResvdCtlPktProfile Param Table" is missing the packets will be dropped. VLAN here means the 802.1q Vlan in case of Native Vlan mode and Virtual Vlan in case of Stacked Vlan Mode.</p> <p><b>Type:</b> Create -- Optional<br/>Modify -- Optional</p> <p><b>Valid values:</b> 1 - 4</p> <p><b>Default value:</b> 1</p> |
| <b>igmpsnoopaction</b> Drop   TransparentlyForward   Learn | <p>This parameter specifies that if an action is "Learn" then igmpsnoop will be supported for this Vlan and an entry will be learnt. Here action will be applied in conjunction with global igmpsnoopStatus and port level igmpsnoopStatus flags, that is IGMP functionality will be executed for a frame if IGMP is enabled globally and on the port it has been received and for the vlan/virtual vlan on which it has come. If action is "drop" then igmpsnoop functionality is not supported for this vlan and IGMP frames shall</p>   |



|  |  |
|--|--|
|  | <p>be dropped. If action is "transparently forward", then IGMP frames received for this Vlan shall be forwarded transparently and learning will not be done</p> <p><b>Type:</b> Create -- Optional<br/>Modify -- Optional</p> <p><b>Default value:</b> Learn</p>   |
| <p><b>igmpsnoopproxyreporting</b><br/>Enable   Disable</p>         | <p>This parameter provides a configuration option to choose between transparent snooping or Proxy reporting behavior per Vlan. Depending on the type of mode, IGMP module will perform either transparent snooping or proxy reporting for the IGMP messages, received on a Vlan. Here the Vlan which is being referred is the one on which learning will happen. It will be multicast vlan, if "Multicast Vlan option" is enabled.</p> <p><b>Type:</b> Create -- Optional<br/>Modify -- Optional</p> <p><b>Default value:</b> Disable</p>  |
| <p><b>igmpsnoopingressprio</b><br/>igmpsnoopingressprio   none</p> | <p>This parameter specifies the ingress priority to be forced on the incoming frame. If the ingress priority field has valid value, then that value will be used for traffic class determination and packet priority. If valid egress priority is configured for a port, then egress priority shall override the ingress priority. In addition, there is support of invalid value for ingress priority to indicate that the priority is not to be forced on ingress frame for this port. Here the Vlan which is being referred is the one on which learning shall happen. It will be multicast vlan, if "Multicast Vlan option" is enabled.</p> <p><b>Type:</b> Create -- Optional<br/>Modify -- Optional</p> <p><b>Valid values:</b> 0 -7</p> <p><b>Additional Values:</b> 8</p> <p><b>Default value:</b> 8</p> |
| <p><b>darstatus</b> Enable   Disable</p>                           | <p>This specifies whether ARP packets received on this VLAN are to be directed to a single port using (VLANId, IP address) to bridge port mapping learnt using DRA. This attribute is effective in conjunction with the attribute 'gsvDot1dPortDirectedARP' of 'Dot1dBasePortExtTable' MO. ARP packets are to be directed as mentioned above, only if both the flags are enabled. If any of the two is disabled, the ARP packets will be forwarded as per the normal bridging flow.</p> <p><b>Type:</b> Create -- Optional<br/>Modify -- Optional</p>  |

|  |   |
|--|---|
|  | <b>Default value:</b> enable  |
| <b>darpfailurehandling</b> Drop   TransparentForward   FloodTrustedPorts | <p>This specifies the action to be taken on an ARP packet received on this VLAN for which it is not possible to determine a single port using (VLANId, IP address) to bridge port mapping learnt using DRA. If the value is drop, the ARP packet will be dropped. If the value is Transparent Forwarding, the ARP packet will be forwarded as per the normal bridging. If the value is FloodTrustedPorts, the ARP packet will be forwarded as per the normal bridging, but only on ports that are trusted.</p> <p><b>Type:</b> Create -- Optional<br/>Modify -- Optional</p> <p><b>Default value:</b> FloodTrustedPorts</p> |
| <b>drabcasttouncast</b> Enable   Disable                                 | <p>This Parameter is used to configure whether DHCP broadcast packet received for this vlan will be converted to unicast packet or not.</p> <p><b>Type:</b> Create -- Optional<br/>Modify -- Optional</p> <p><b>Default value:</b> Disable</p>  |
| <b>bngmac</b> <bngmac-val>   | <p>This is used to configure BNG Mac address of this VLAN. If VLAN is configured to convert DHCP broadcast packets to Unicast packets, then this MAC address is used as destination MAC address.</p> <p><b>Type:</b> Create -- Optional<br/>Modify -- Optional</p> <p><b>Default value:</b> "\xff\xff\xff\xff\xff\xff"</p>  |
| <b>drastatus</b> Enable   Disable  | <p>This Parameter specifies the status of DRA whether it is enabled for this Vlan or not. If enabled DRA will Act as per the port configuration on which DHCP packet is received. If disabled DRA will not perform any action on the DHCP packets received over this vlan.</p> <p><b>Type:</b> Create -- Optional<br/>Modify -- Optional</p> <p><b>Default value:</b> Enable</p>  |
| <b>piastatus</b> Enable   Disable  | <p>This Parameter specifies the status of PIA whether it is enabled for this Vlan or not. If enabled PIA will Act as per the port configuration on which PPPoE packet is received. If disabled PIA will not perform any action on the PPPoE packets received over this vlan.</p> <p><b>Type:</b> Create -- Optional<br/>Modify -- Optional</p> <p><b>Default value:</b> Enable</p>  |

|   |  |
|---|--|
| <b>findoneportfailact</b> drop  <br>floodtrusted   TransparentlyForward | This field specifies the action to be taken when DRA fails to determine the destined port for downstream DHCP packets. If this field is set to drop then the packets are dropped. If it is specified as floodtrusted then packets are forwarded to trusted ports only. If it is set as TransparentlyForward then the packets are forwarded to all the ports as per normal bridging functionality.<br><br><b>Type:</b> Create -- Optional<br>Modify -- Optional<br><br><b>Default value:</b> TransparentlyForward |
|---|--|

**Example :**

```
$ create vlan static vlnname gsvlan vlanid 1 egressports 1 2 20 forbidegressports 34 5 untaggedports 2 bridgingmode Residential bcstsupport enable floodsupport enable resvmacprofileid 1
```

**Output:**

```
Verbose Mode On
Entry Created
```

```
VLAN Name                : gsvlan
VLAN Index                : 1
Egress ports              : 1 2 20
Forbidden Egress Ports    : 34 5
Untagged Ports            : 2
Bridging Mode             : Residential
Flood support Status      : enable
Broadcast support Status  : enable
Reserved Mac Profile Id   : GS_CFG_DEF_RSVD_MAC_PROFILE_ID
Icmp Snoop Action         : Learn
Igmppsnoop ProxyReporting Status : Normal
Igmppsnoop ingress Priority : 4          Directed ARP status : enable
DARPFfailedHandling       : enable
DRA Bcast To Ucast        : Enable
BNG MAC address           : 00:01:03:04:05:11
DRA Status                 : Enable
PIA Status                 : Enable    Find One Port Fail Act : Drop
```

```
Verbose Mode Off:
Entry Created
```

**Output field:**

| Field                         | Description  |
|-------------------------------|--|
| <b>VLAN Name</b>              | An administratively assigned string, which may be used to identify the VLAN. This is mandatory in the case of create cmd. In case of get/modify/delete - either vlan name or vlan id can be given.   |
| <b>VLAN Index</b>             | The VLAN Identifier. GS_UNREGISTERED_VLANID is a special Vlan Id used for managing the traffic for those VLANs that are neither created nor learned in the system. The valid range for this field also includes GS_UNREGISTERED_VLANID besides the range 1-4095.   |
| <b>Egress ports</b>           | The set of ports, which are permanently assigned to the egress list for this VLAN by management  |
| <b>Forbidden Egress Ports</b> | The set of ports which are prohibited by management from being included in the egress list for this VLAN.  |
| <b>Untagged Ports</b>         | The set of ports, which should transmit egress packets for this VLAN, as untagged.   |
| <b>Bridging Mode</b>          | <p>This specifies the state of full bridging for the VLAN. There can be three values associated with this, based on global fullBridgingStatus. These values can be restricted bridging, unrestricted full bridging and residential bridging. If the user does not specify the bridging mode at the time of VLAN creation, the VLAN inherits the globally set bridging mode. The user can modify bridging mode for a created VLAN. If the dynamic entry for the VLAN to be created already exists, the user can only specify globally set bridging mode for this VLAN. The bridging modes are defined as Restricted Full Bridging, Unrestricted full bridging and Residential bridging. The default residential VLAN, like any other residential VLAN allows only one net side bridge port as its member. This port shall be added automatically to the default VLAN if it is the only net side bridge port being added to the VLAN. Subsequently, the user can add another net side port to the egressportslist and untaggedportslist only after removing the previously added net side bridge port. Unrestricted bridging is not applicable for bridge ports created over the PPPoE interface even though the VLAN may be unrestricted.</p> |

|  |  |
|--|--|
| <b>Flood support Status</b>            | This specifies if the flooding has to be done for unknown unicast packets for this vlan or not. The default value for this shall be taken from enable when vlan is created. The unknown unicast packets shall be flooded on all ports for a vlan if global value (present in Dot1dTpInfo) is enabled or throttle, and the value per vlan is also enabled else dropped.   |
| <b>Broadcast support Status</b>        | This specifies if the broadcast has to be done for this vlan or not. The default value for this shall be taken from enable when vlan is created. The broadcast packets shall be flooded on all ports for a vlan if global value (present in Dot1dTpInfo) and the value per vlan are both enabled else dropped.   |
| <b>Reserved Mac Profile Id</b>         | The Profile associated with this Vlan to be used to determine the behavior for Reserved Mac destined frames. Reserved Mac addresses are the multicast addresses defined as reserved in IEEE 802.1Q and IEEE 802.1ad. The existence of the specified "ResvdCtlPktProfile Table" entry is a must for VLAN static entry creation to succeed. Further, even if the specified "ResvdCtlPktProfile Table" entry exists, but the corresponding entry in "ResvdCtlPktProfile Param Table" is missing the packets will be dropped. VLAN here means the 802.1q Vlan in case of Native Vlan mode and Virtual Vlan in case of Stacked Vlan Mode.   |
| <b>Igmp Snoop Action</b>               | This parameter specifies that if an action is "Learn" then igmpsnoop will be supported for this Vlan and an entry will be learnt. Here action will be applied in conjunction with global igmpsnoopStatus and port level igmpsnoopStatus flags, that is IGMP functionality will be executed for a frame if IGMP is enabled globally and on the port it has been received and for the vlan/virtual vlan on which it has come. If action is "drop" then igmpsnoop functionality is not supported for this vlan and IGMP frames shall be dropped. If action is "transparently forward", then IGMP frames received for this Vlan shall be forwarded transparently and learning will not be done |
| <b>Igmpsnoop ProxyReporting Status</b> | This parameter provides a configuration option to choose between transparent snooping or Proxy reporting behavior per Vlan. Depending on the type of mode, IGMP module will perform either transparent   |

|                                   |  |
|-----------------------------------|--|
|                                   | snooping or proxy reporting for the IGMP messages, received on a Vlan. Here the Vlan which is being referred is the one on which learning will happen. It will be multicast vlan, if "Multicast Vlan option" is enabled.   |
| <b>Igmpsnoop ingress Priority</b> | This parameter specifies the ingress priority to be forced on the incoming frame. If the ingress priority field has valid value, then that value will be used for traffic class determination and packet priority. If valid egress priority is configured for a port, then egress priority shall override the ingress priority. In addition, there is support of invalid value for ingress priority to indicate that the priority is not to be forced on ingress frame for this port. Here the Vlan which is being referred is the one on which learning shall happen. It will be multicast vlan, if "Multicast Vlan option" is enabled. |
| <b>Directed ARP status</b>        | This specifies whether ARP packets received on this VLAN are to be directed to a single port using (VLANId, IP address) to bridge port mapping learnt using DRA. This attribute is effective in conjunction with the attribute 'gsvDot1dPortDirectedARP' of 'Dot1dBasePortExtTable' MO. ARP packets are to be directed as mentioned above, only if both the flags are enabled. If any of the two is disabled, the ARP packets will be forwarded as per the normal bridging flow.   |
| <b>DARPFailedHandling</b>         | This specifies the action to be taken on an ARP packet received on this VLAN for which it is not possible to determine a single port using (VLANId, IP address) to bridge port mapping learnt using DRA. If the value is drop, the ARP packet will be dropped. If the value is Transparent Forwarding, the ARP packet will be forwarded as per the normal bridging. If the value is FloodTrustedPorts, the ARP packet will be forwarded as per the normal bridging, but only on ports that are trusted.  |
| <b>DRA Bcast To Ucast</b>         | This Parameter is used to configure whether DHCP broadcast packet received for this vlan will be converted to unicast packet or not.   |
| <b>BNG MAC address</b>            | This is used to configure BNG Mac address of this VLAN. If VLAN is configured to convert DHCP broadcast packets to Unicast packets, then this MAC address is used as destination MAC address.  |

|                               |   |
|-------------------------------|---|
| <b>DRA Status</b>             | This Parameter specifies the status of DRA whether it is enabled for this Vlan or not. If enabled DRA will Act as per the port configuration on which DHCP packet is received. If disabled DRA will not perform any action on the DHCP packets received over this vlan.   |
| <b>PIA Status</b>             | This Parameter specifies the status of PIA whether it is enabled for this Vlan or not. If enabled PIA will Act as per the port configuration on which PPPoE packet is received. If disabled PIA will not perform any action on the PPPoE packets received over this vlan.   |
| <b>Find One Port Fail Act</b> | This field specifies the action to be taken when DRA fails to determine the destined port for downstream DHCP packets. If this field is set to drop then the packets are dropped. If it is specified as floodtrusted then packets are forwarded to trusted ports only. If it is set as TransparentlyForward then the packets are forwarded to all the ports as per normal bridging functionality. |

**References:**

VLAN commands

## 5.28 Miscellaneous Commands

---

### 5.28.1 File Commands

#### 5.28.1.1 Apply

**Description:**

Use this command to apply a configuration file stored on the system

**Command Syntax:**

**Apply** **fname** <file-name> [**version** <version>] [**besteffort** true|false]

**Parameters:**

| Name                         | Description   |
|------------------------------|---|
| <b>fname</b> <file-name>     | This specifies the name of the configuration file (the extension of the file shall be .cfg) to be applied. The file shall contain valid CLI commands. The user shall specify the filename for files present in the system as directories. The directories are /nvram/cfg/ factorydef/, /nvram/user/, /sdram/cfg, /sdram/user.<br><b>Type:</b> mandatory<br><b>Valid values:</b> string of up to 128 characters: ('A'-'Z', 'a'-'z', '0'-'9', '-', '_') |
| <b>version</b> <version>     | This specifies the version of the file that needs to be applied.<br><b>Type:</b> Optional<br><b>Default Value:</b> Incase of multiple version files the active copy gets applied. Not valid for single version file.  |
| <b>besteffort</b> true false | If the besteffort flag is false, command execution (as specified in "file-name"file) stops immediately after a command returns an error. If the besteffort flag is true, command execution (as specified in "file-name"file) continues even if a command returns an error.<br><b>Type :</b> Optional<br><b>Default value :</b> false  |

**Mode:**

Super-User



**Example:**

```
$ apply fname /nvram/user/commands.cfg version 2
```

**Output:**

The output of the command is dependent on the list of CLI commands in commands.cfg file.

**Example 1:**

The file commands.cfg has the following commands:

Verbose on

```
create atm port ifname atm-0 lowif dsl-0
```

Entry Created

```
If-Name      : atm-0      LowIfName     : dsl-0
MaxVccs      : 2          MaxConfVccs  : 4
MaxVpiBits   : 3          MaxVciBits    : 10
OAMSrc       : 0xffffffffffffffffffffffffffff
Oper Status  : Up         Admin Status  : Up
```

**Example 2:**

The file commands.cfg has the following commands:

```
create atm port ifname atm-0 lowif dsl-0
```

The output would be:

Entry Created

**Output Fields:**

None

**References:**

Upgrade command

Remove command

List command

Download command

## 5.28.1.2 Download

### Description:

Use this command to download a binary, configuration or user specific file from the remote host.

### Command Syntax:

```
download src <src-filename> dest <dest-filename> ip <ip-address> [mode tftp|ftp] [savemode compact]
```

### Parameters:

| Name                        | Description  |
|-----------------------------|--|
| <b>src</b> <src-filename>   | <p>This specifies the name of the binary, configuration or user specific file to be downloaded from a remote host.</p> <p>The filename contains the complete path on the host. The filename extension can be .cfg or .bin or any other user specified extension. A cfg file can contain only valid CLI commands. A .bin file must be a valid image file.</p> <p><b>Type:</b> Mandatory</p> <p><b>Valid values:</b> String of up to 128 characters (all characters except ';', ',', '?')</p>  |
| <b>dest</b> <dest-filename> | <p>This specifies the name of the binary, configuration or user specific file on the system. The user shall specify the filename for files present in the system, as directories.</p> <p>The directories are <b>/nvram/bin/control/</b> - This directory contains control plane zipped image. There can be multiple versions of images. The name of the image file shall be as specified in the configuration file of createfi tool.</p> <p>The files are stored in NVRAM.</p> <p><b>/nvram/bin/dataplane/</b> - This directory contains data plane zipped image. There can be multiple versions of images. The name of the image file shall be as specified in the configuration file of createfi tool. The files are stored in NVRAM.</p> <p><b>/nvram/bin/decompressor/</b> - This directory contains decompressor image. There can be multiple versions of images. The name of the image file shall be as specified in the configuration file of createfi tool. The files are stored in NVRAM.</p> <p><b>/nvram/bin/dslphy/</b> - This directory contains DSL physical layer image. Only one version of image is possible. The name of the image file shall be as specified in the configuration file of createfi tool. The files are stored in NVRAM.</p> <p><b>/nvram/cfg/factorydef/</b> - This directory contains factory default configuration files. There can be multiple versions of files. The name of the file shall be as specified in the configuration file of createfi tool. The files are stored in</p> |

|                         |   |
|-------------------------|---|
|                         | <p>NVRAM.</p> <p><b>/nvram/user/</b> - This directory contains user specific files. There can be multiple versions of files. The files are stored in NVRAM.</p> <p><b>/sdram/cfg/</b> - This directory contains user specific Configuration files with .cfg extension. The files are stored in SDRAM</p> <p><b>/sdram/user/</b> - This directory contains user specific files. The files are stored in SDRAM.</p> <p><b>Type:</b> Mandatory</p> <p><b>Valid values:</b> String of up to 128 characters (all Characters except ';', ', '?)</p> |
| <b>ip</b> <ip-address>  | <p>This specifies the IP address of the remote host from which the file is to be downloaded.</p> <p><b>Type:</b> Mandatory</p> <p><b>Valid values:</b> Any valid IP address.</p>  |
| <b>mode</b> tftp   ftp  | <p>This specifies the protocol to be used for downloading the file. Currently only TFTP is supported.</p> <p><b>Type:</b> Optional</p> <p><b>Default Value :</b> TFTP</p>   |
| <b>savemode</b> compact | <p>It allows saving of files in the compact mode. This option is applicable for downloading user files only.</p> <p><b>Note:</b> This option is enabled only when GS_CFG_USER_COMPACT_FILE_SYSTEM is TRUE.</p> <p><b>Type:</b> Optional</p> <p><b>Valid Values:</b> compact</p>   |

**Example:**

```
$ download src myconfig.cfg dest /nvram/user/myconfig.cfg ip 198.168.1.1
```

**Output:**

```
Verbose Mode On
Downloading The Code File. . .
Download Completed
Verbose Mode Off
Downloading The Code File. . .
Download Completed
```

**Output Fields:**

None

**Caution:**

Ensure that the TFTP server is running on the remote host. After downloading the image in safe mode, the system should be rebooted and no other nvram operations should be tried on the system.

**References:**

upgrade command  
remove command  
list command  
apply command

**5.28.1.3 List****Description:**

This command is used to list the Configuration or binary files stored on the unit

**Command Syntax:**

**list fname** [/nvram | /sdram]

**Parameters:**

| Name                           | Description   |
|--------------------------------|---|
| <b>fname</b> [/nvram   /sdram] | <p>This specifies whether the files of NVRAM or SDRAM are to be listed.</p> <p><b>/nvram</b> – This lists all directories and files stored in NVRAM.</p> <p><b>/sdram</b> - This lists all directories and files stored in SDRAM.</p> <p><b>Type:</b> Optional.</p> <p><b>Default Value:</b> All the files present in the NVRAM or SDRAM will be displayed.</p> |

**Mode:**

Super-User.

**Example :**

```
$ list fname /nvram
```

## Output :

Verbose Mode On

Flash size : 4194304

Flash Block size : 131072

Free Blocks in Flash : 3

/nvram/bin/control/

Name : CP.bin.gz

Version : 1 Size(bytes) : 1424656

Time : Thu Dec 23 15:42:26 2004

Permission : RW State : active

Used Blocks : 11

/nvram/bin/dataplane/

Name : DP.bin.gz

Version : 1 Size(bytes) : 293092

Time : Thu Jan 01 00:01:54 1970

Permission : RW State : active

Used Blocks : 3

/nvram/bin/dslphy/

Name : gsv\_dsl\_AD\_DM\_0000000C.bin.gz

Version : 1 Size(bytes) : 91632

Time : Thu Dec 23 15:42:26 2004

Permission : RW State : active

Used Blocks : 1

Name : gsv\_dsl\_AD\_DM\_0004200C.bin.gz

Version : 1 Size(bytes) : 159408

Time : Thu Dec 23 15:42:26 2004

Permission : RW State : active

Used Blocks : 2

/nvram/cfg/factorydef/

Name : FD.cfg

Version : 1 Size(bytes) : 45

Time : Thu Dec 23 15:42:26 2004

Permission : RW State : active

Used Blocks : 1

/nvram/cfg/manuf/

Name : Manuf.txt

Version : 1 Size(bytes) : 5768  
Time : Thu Dec 23 15:42:26 2004  
Permission : RW State : active  
Used Blocks : 1

/nvram/system/

Name : CFG1  
Version : 1 Size(bytes) : 262056  
Time :  
Permission : SYS State : active  
Used Blocks : 2

Name : CFG2  
Version : 1 Size(bytes) : 262056  
Time :  
Permission : SYS State : active  
Used Blocks : 2

Name : LOGS  
Version : 1 Size(bytes) : 130988  
Time :  
Permission : SYS State : active  
Used Blocks : 1

/nvram/user

Name : user.txt  
Version : 1 Size(bytes) : 5768  
Time : Thu Dec 23 15:42:26 2004  
Permission : RW State : active  
Used Blocks : 1

Verbose Mode Off

Flash size : 4194304  
Flash Block size : 131072  
Free Blocks in Flash : 4

/nvram/bin/control/

Name : CP.bin.gz  
Version : 1 Size(bytes) : 1424656  
Time : Thu Dec 23 15:42:26 2004  
Permission : RW State : active  
Used Blocks : 11

/nvram/bin/dataplane/

Name : DP.bin.gz  
Version : 1 Size(bytes) : 293092  
Time : Thu Jan 01 00:01:54 1970  
Permission : RW State : active  
Used Blocks : 3

/nvram/bin/dslphy/

Name : gsv\_dsl\_AD\_DM\_0000000C.bin.gz  
Version : 1 Size(bytes) : 91632  
Time : Thu Dec 23 15:42:26 2004  
Permission : RW State : active  
Used Blocks : 1

Name : gsv\_dsl\_AD\_DM\_0004200C.bin.gz  
Version : 1 Size(bytes) : 159408  
Time : Thu Dec 23 15:42:26 2004  
Permission : RW State : active  
Used Blocks : 2

/nvram/cfg/factorydef/

Name : FD.cfg  
Version : 1 Size(bytes) : 45  
Time : Thu Dec 23 15:42:26 2004  
Permission : RW State : active  
Used Blocks : 1

/nvram/cfg/manuf/

Name : Manuf.txt  
Version : 1 Size(bytes) : 5768  
Time : Thu Dec 23 15:42:26 2004  
Permission : RW State : active  
Used Blocks : 1

/nvram/system/

Name : CFG1  
Version : 1 Size(bytes) : 262056  
Time :  
Permission : SYS State : active  
Used Blocks : 2

Name : CFG2  
Version : 1 Size(bytes) : 262056

Time :  
 Permission : SYS State : active  
 Used Blocks : 2  
 Name : LOGS  
 Version : 1 Size(bytes) : 130988  
 Time :  
 Permission : SYS State : active  
 Used Blocks : 1

/nvram/user

Name : user.txt  
 Version : 1 Size(bytes) : 5768  
 Time : Thu Dec 23 15:42:26 2004  
 Permission : RW State : active  
 Used Blocks : 1

### Output Fields:

| FIELD                       | Description  |
|-----------------------------|--|
| <b>Flash Size</b>           | Total flash size in bytes. This field is relevant for NVRAM files                                      |
| <b>Flash Block Size</b>     | Flash Block Size in bytes. This field is relevant for NVRAM files.                                     |
| <b>Free Blocks in Flash</b> | Number of free blocks in flash. This field is relevant for NVRAM files.                                |
| <b>Name</b>                 | The name of the file present in the directory. Name starting with <i>i/i</i> indicates directory name. |
| <b>Version</b>              | This specifies the version of the file.  |
| <b>Time</b>                 | Time at which the file got created. This is displayed in Day Mon DD HH:MM:SS YEAR format.              |
| <b>Size</b>                 | The size of the file in bytes.   |
| <b>Permissions</b>          | Permission of the file. It can be read only, read write or protected.                                  |
| <b>State</b>                | The state of the file. It can be active, inactive, tried, latest.                                      |
| <b>Used Blocks</b>          | Number of blocks used in the flash by the file.  |

### References:

upgrade command  
 remove command  
 apply command  
 download command



## 5.28.1.4 Permission

### Description:

Use this command to change the permission of the files stored on flash.

### Command Syntax:

**permission fname** <fname-val> **type** ro|rw|pr [**version** <version-val>]

### Parameters:

| Name                   | Description  |
|------------------------|--|
| <b>fname fname</b>     | Name of the file whose permission is to be changed.<br><b>Type:</b> mandatory<br><b>Valid values:</b> string of up to 128 characters: ('A'-<br>'Z','a'-'z', '0'-'9', '-', '_')                 |
| <b>version version</b> | This specifies the version of the file that need to be applied.<br><b>Type:</b> Optional for single version file.<br>Mandatory for multiple version file.                                      |
| <b>type ro rw pr</b>   | This specifies that to what type, ro (read-only), rw (read-write), or pr (protected), permission of the file is to be changed.<br><b>Type:</b> mandatory<br><b>Valid Values :</b> ro   rw   pr |

### Mode:

Super-User

### Example:

```
$ permission fname /nvram/user/commands.cfg version 1 type ro
```

### Output:

Verbose Mode On

Set Done

Verbose Mode Off

Set Done

### Output Fields:

None

**References:**

upgrade command  
 remove command  
 list command  
 download command

**5.28.1.5 Ping****Description:**

Use to send one or more ICMP messages to another host for a reply.

**Command Syntax:**

```
ping {ip-address | domain-name} [-t | -n <number>] [-i <time-to-live>] [-w <seconds>] [-s <size>]
```

**Parameters:**

| Name                     | Description  |
|--------------------------|--|
| ip-address   domain-name | This specifies the Destination address to be pinged.<br><b>Type</b> : Mandatory<br><b>Valid values</b> : Any Valid IP Address (0.0.0.0 – 255.255.255.255) or Domain Name - String of Max 63 characters ('a'-'z', 'A'-'Z', '0'-'9', '-', '_' and '.') |
| -t                       | This indicates continuous ping to host, until the user interrupts.<br><b>Type</b> : Optional   |
| -n <number>              | This specifies the number of pings to send to host.<br><b>Type</b> : Optional<br><b>Valid values</b> : 1-65535<br><b>Default Value</b> : 4   |
| -w <seconds>             | This specifies the time interval between successive ping requests<br><b>Type</b> : Optional<br><b>Valid values</b> : 0-65535<br><b>Default Value</b> : 2   |
| -I <time-to-live>        | This specifies the time-to-live, to be filled in the ping request<br><b>Type</b> : Optional<br><b>Valid values</b> : 0 – 255<br><b>Default Value</b> : 64  |
| -s <size>                | This specifies the size of payload for ping. <b>Type</b> : Optional<br><b>Valid values</b> : 4-1500<br><b>Default Value</b> : 64   |

**Example:**

```
$ ping 192.168.1.13
```

**Output:**

```
$ ping 192.168.1.13
```

```
64 bytes of data from 192.168.1.13, seq=0 ttl=64 rtt=0.000 msec
```

```
64 bytes of data from 192.168.1.13, seq=1 ttl=64 rtt=0.000 msec
```

```
64 bytes of data from 192.168.1.13, seq=2 ttl=64 rtt=0.000 msec
```

```
64 bytes of data from 192.168.1.13, seq=3 ttl=64 rtt=0.000 msec
```

```
----- Ping Statistics -----
```

```
4 packets transmitted, 4 packets received, 0 percent packet loss
```

**Output Fields:**

| FIELD          | Description  |
|----------------|--|
| 64 bytes of... | This denotes the number of bytes in the ping packet and the source IP Address.         |
| Seq            | This denotes the ping attempt counter value.   |
| Ttl            | This is the Time to live for the packet.   |
| Rtt            | This denotes the Round trip Time for the packet. A value less than 10ms is shown as 0. |

**5.28.1.6 Remove****Description:**

Use this command to remove a configuration or binary file stored on the unit

**Command Syntax:**

```
remove fname <file-name> [version <version>]
```

**Parameters:**

| Name                     | Description  |
|--------------------------|--|
| <b>fname</b> <file-name> | <p>This specifies the file name, which needs to be removed. The user shall specify the filename for files present in the system, as directories. The directories are /nvram/bin/control/, /nvram/bin/control/, /nvram/bin/dataplane/, /nvram/bin/dslphy, /nvram/cfg/factorydef/, /nvram/user/, /sdram/cfg, /sdram/user.</p> <p><b>Type</b> : Mandatory</p> <p><b>Valid values</b>: string of upto 128 characters ('A'-'Z', 'a'-'z', '0'-'9', '-', '_')</p> |

|                          |   |
|--------------------------|---|
| <b>version</b> <version> | This specifies the version of the file that need to be removed.<br><b>Type:</b> Optional for single version file. Mandatory for multiple version file. Default Value: |
|--------------------------|---|

**Example:**

\$ remove fname /nvram/user/commands.cfg

**Output:**

Verbose Mode On  
File removed

Verbose Mode Off  
File removed

**Output Fields:**

None

**References:**

- apply command
- list command
- download command

### 5.28.1.7 Upgrade

**Description:**

Use this command to upgrade a configuration or binary file stored on the system.

**Command Syntax:**

**upgrade fname** <file-name> **version** <version>

**Parameters:**

| Name                     | Description  |
|--------------------------|--|
| <b>fname</b> <file-name> | This specifies the file name, which needs to be upgraded. The specified file becomes Active and the present active file is made inactive. The user shall specify the filename for files present in Columbia, as directories. The directories are /nvram/bin/control/, /nvram/bin/dataplane/, /nvram/bin/decompressor, /nvram/bin/dslphy, /nvram/cfg/factorydef/, /nvram/ user/,<br><b>Type :</b> Mandatory<br><b>Valid values:</b> string of upto 128 characters ('A'-'Z', 'a'-'z', '0'-'9', '-', '_') |

|                          |   |
|--------------------------|---|
| <b>version</b> <version> | <p>This specifies the version of the file that needs to be upgraded</p> <p><b>Type :</b> Mandatory</p> <p><b>Valid values:</b> Decimal number</p> |
|--------------------------|---|

**Mode:**

Super-User

**Example:**

```
$ upgrade fname /nvram/cfg/factorydef/commands.cfg version 2
```

**Output:**

Verbose Mode On

File upgraded

Verbose Mode Off

File upgraded

**Output Fields:**

None

**References:**

apply command

list command

download command

### 5.28.1.8 Upload

**Description:**

Use this command to upload the primary/secondary configuration file saved in flash on the Columbia system to the remote host.

**Command Syntax:**

**Upload src** <src-filename> **dest** <dest-filename> **ip** <ip-address> [**mode** tftp | ftp]

## Parameters:

| Name                        | Description  |
|-----------------------------|--|
| <b>src</b> <src-filename>   | This specifies the name of the configuration file on the system. The files that can be uploaded are: <b>/nvram/system/primcfg</b> - The primary configuration file created on the system after commit operation has been performed once.<br><b>/nvram/system/seccfg</b> - The secondary configuration file created on the system after commit operation has been performed twice.<br><b>Type:</b> Mandatory<br><b>Valid values:</b> String of up to 128 characters (all characters except ';', ' ', '?') |
| <b>dest</b> <dest-filename> | This specifies the name of the configuration file to be uploaded to a remote host. The filename contains the complete path on the host. The filename extension can be .cfg or .bin or any other user specified extension. <b>Type:</b> Mandatory<br><b>Valid values:</b> String of up to 128 characters (all characters except ';', ' ', '?')  |
| <b>ip</b> <ip-address>      | This specifies the IP address of the remote host to which the file is to be uploaded.<br><b>Type:</b> Mandatory<br><b>Valid values:</b> Any valid IP address   |
| <b>mode</b> tftp   ftp      | This specifies the protocol to be used for uploading the file. Currently, only TFTP is supported.<br><b>Type:</b> Optional<br><b>Valid values:</b> TFTP  |

## Example:

```
$ upload src /nvram/system/primcfg dest myconfig.cfg ip 198.168.1.1
```

## Output:

```
Verbose Mode On  
Uploading The Code File. . .  
Upload Completed  
Verbose Mode Off  
Uploading The Code File. . .  
Upload Completed
```

## Output Fields:

None

## Caution:

Ensure that the TFTP server is running on the remote host.

## References:

Commit command

## 5.28.2 Other Commands

### Description:

Use this command to create an alias for any CLI command. You can later call this command by using the alias-string along with any additional parameters, which you need to specify. It will display a list of all the aliases currently defined if no parameter is given.

### Command Syntax:

**alias** [alias-string = aliased-command]

### Parameters:

| Name                   | Description   |
|------------------------|---|
| <b>alias-string</b>    | The string, which you will use to refer to the aliased command, henceforth. It should not match any CLI keyword.<br><b>Type:</b> Optional<br><b>Valid values:</b> string of up to 14 characters ('A'-'Z', 'a'-'z', '0'-'9', '-', '_') |
| <b>aliased-command</b> | This is the total CLI command length (512 characters).<br><b>Type:</b> Mandatory<br><b>Valid values:</b> Any string (all printable characters except ';') as long as the total CLI Command length is not exceeded.                    |

### Mode:

Super-User, User

### Output:

With Parameters

```
$alias abc = modify nbsize
```

```
Set Done
```

```
$abc maxatmport 48
```

```
Set Done
```

Without Parameters

```
$alias
```

```
Alias          Command
```

```
-----
```

```
abc          modify nbsize
```

### Output Fields:

| FIELD   | Description   |
|---------|---|
| Alias   | This is the new abbreviated command, which you may use in place of the string specified in Command. |
| Command | The command string which has been aliased.  |

### References:

Unalias command

## 5.28.2.1 Unalias

### Description:

Use this command to delete an alias. Either a particular alias or all aliases can be removed using this command.

### Command Syntax:

**unalias** [all | <name>]

### Parameters:

| Name | Description   |
|------|---|
| all  | Using this option all the aliases defined in the system will be removed.<br><b>Type:</b> Optional<br><b>Valid values:</b> String ìALL.î |
| Name | Name of the alias defined for a command.<br><b>Type:</b> Optional.<br><b>Valid values:</b> Any valid alias defined in the system.       |

### Mode:

Super-User, User

### Example :

Unalias abc

### Output:

Entry Deleted

### Output Fields:

None



## 5.28.2.2 Help

### Description:

Use this command for a listing of all the user inputs permissible at the point. In case Help is asked for, as a parameter of any incomplete command, then it displays a list of all the pending/Extra parameters input by the user. In all other cases, the next set of permissible keywords required in order to shortlist a command, is displayed. The Incomplete Command keyed in by the user is made available again, after help is displayed.

### Command Syntax:

**help** |? or **<Any Incomplete Command>?**

### Mode:

Super-User, User

### Example:

```
$help
```

| Command | Description                           |
|---------|---------------------------------------|
| alias   | To Alias a command                    |
| commit  | Commit the active config to the flash |
| create  | Create a new entry of specified type  |
| delete  | Delete the specified entry            |

.

.

```
$delete ?
```

| Command | Description           |
|---------|-----------------------|
| arp     | IP Net To Media Table |
| atm     | ATM Commands          |
| bridge  | Bridge Commands       |
| dhcp    | DHCP Commands         |

.

.

```
$delete atm ?
```

| Command | Description               |
|---------|---------------------------|
| port    | ATM port commands         |
| vc intf | ATM VC Interface commands |

**Output Fields:**

None

**Caution:**

Currently help is not available between a parameter name and its value.

**5.28.2.3 Logout****Description:**

Use this command to exit from the CLI shell.

**Command Syntax:**

logout | quit | exit

**5.28.2.4 Prompt****Description:**

Use this command to set the new CLI prompt.

**Command Syntax:**

**prompt** <new-prompt>

**Parameters:**

| Name                       | Description   |
|----------------------------|---|
| <b>prompt</b> <new-prompt> | The new prompt string.<br><b>Type:</b> Mandatory<br><b>Valid values:</b> String of up to 19 characters ( All characters except ';', ' ', '?') |

**Mode :**

Super-User, User

**Example :**

\$ prompt \$\$\$

**Output:**

Set Done

\$\$\$

**Output Fields:**

None

**Caution:**

None. The modified prompt is not saved across a reboot.

**5.28.2.5 Traceroute****Description:**

This command is used to trace the route to the specified destination.

**Command Syntax:**

```
traceroute {ip <ip-address> | dname <domain-name>} {ping | udp} [-m
<num-of-hops>] [-w <wait-time>] [-p <udp-port-number>] [-q <numof-probes>]
```

**Parameters:**

| Name  | Description  |
|---|--|
| <b>ip-address   dn</b> ame<br><domain-name> | This specifies the Destination address to be pinged.<br><b>Type:</b> Mandatory<br><b>Valid values :</b> Any Valid IP Address (0.0.0.0 – 255.255.255.255) or Domain Name (String of Max 63 characters ('a'-'z', 'A'-'Z', '0'-'9', '-', '_', and '.')) |
| <b>Ping   udp</b>                           | Traceroute probe message type<br><b>Type:</b> Mandatory  |
| <b>-m</b> <num-of-hops>                     | Maximum number of hops to search for ip-address <b>Type:</b> Optional<br><b>Valid Values:</b> 0-255<br><b>Default Value :</b> 30   |
| <b>-w</b> <wait-time>                       | This specifies the timeout in seconds<br><b>Type:</b> Optional<br><b>Valid values :</b> 0-65535<br><b>Default Value :</b> 5  |
| <b>-p</b> <udp-port-number>                 | Destination UDP port to be used, only when Probe is Udp<br><b>Type:</b> Optional.<br><b>Valid Values:</b> 0-65535<br><b>Default Value :</b> 32768  |
| <b>-q</b> <num-of-probes>                   | Number of probes to be sent for each TTL value <b>Type:</b> Optional<br><b>Valid Values:</b> 0-255<br><b>Default Value :</b> 3   |

**Example:**

```
$ traceroute 192.168.1.13 ping
```

**Output:**

Tracing route to [192.168.1.13]

Over a maximum of 30 hops

1 0.000000 ms 0.000000 ms 0.000000 ms 192.168.1.13

Trace complete.

**Output Fields:**

| FIELD | Description   |
|-------|---|
| 1     | This denotes the hop counter value.   |
| 2-4   | These are the Round trip timings of the 3 probe packets sent. A * denotes that this probe was missed. |
| 5     | This is the ip address of the intermediate/destination node.  |

**References:**

ping command.

**5.28.2.6 Verbose****Description:**

Using this command, a user can view the status of entries before and after the execution of a command (create, delete, modify,get). However if this mode is turned off, then display only shows the final result of execution of command, i.e. whether it was successful or failure.

**Command Syntax:**

Verbose [on | off]

**Parameters:**

| Name | Description  |
|------|--|
| On   | Used for switching on the verbose mode.<br><b>Type:</b> Optional<br><b>Valid values:</b> On.   |
| Off  | Used for switching off the verbose mode.<br><b>Type:</b> Optional.<br><b>Valid values:</b> Off |

**Mode:**

Super-User

## Appendix A --- FD.cfg in detail

verbose off

create user name admin passwd admin root

create dsl system

create ethernet intf ifname eth-1 ip 192.168.100.111 mask 255.255.255.0

create bridge port intf portid 385 ifname eth-1 status enable

create ethernet intf ifname eth-3 ip 192.168.1.1 mask 255.255.255.0

modify bridge mode enable

create atm port ifname atm-1 lowif dsl-1

create atm vc intf ifname aal5-1 lowif atm-1 vpi 8 vci 81

create eoa intf ifname eoa-1 lowif aal5-1

create bridge port intf ifname eoa-1 portid 1 learning enable status enable

create atm port ifname atm-2 lowif dsl-2

create atm vc intf ifname aal5-2 lowif atm-2 vpi 8 vci 81

create eoa intf ifname eoa-2 lowif aal5-2

create bridge port intf ifname eoa-2 portid 2 learning enable status enable

create atm port ifname atm-3 lowif dsl-3

create atm vc intf ifname aal5-3 lowif atm-3 vpi 8 vci 81

create eoa intf ifname eoa-3 lowif aal5-3

create bridge port intf ifname eoa-3 portid 3 learning enable status enable

create atm port ifname atm-4 lowif dsl-4

create atm vc intf ifname aal5-4 lowif atm-4 vpi 8 vci 81

create eoa intf ifname eoa-4 lowif aal5-4

create bridge port intf ifname eoa-4 portid 4 learning enable status enable

create atm port ifname atm-5 lowif dsl-5

create atm vc intf ifname aal5-5 lowif atm-5 vpi 8 vci 81

create eoa intf ifname eoa-5 lowif aal5-5

create bridge port intf ifname eoa-5 portid 5 learning enable status enable

```
create atm port ifname atm-6 lowif dsl-6
create atm vc intf ifname aal5-6 lowif atm-6 vpi 8 vci 81
create eoa intf ifname eoa-6 lowif aal5-6
create bridge port intf ifname eoa-6 portid 6 learning enable status enable
```

```
create atm port ifname atm-7 lowif dsl-7
create atm vc intf ifname aal5-7 lowif atm-7 vpi 8 vci 81
create eoa intf ifname eoa-7 lowif aal5-7
create bridge port intf ifname eoa-7 portid 7 learning enable status enable
```

```
create atm port ifname atm-8 lowif dsl-8
create atm vc intf ifname aal5-8 lowif atm-8 vpi 8 vci 81
create eoa intf ifname eoa-8 lowif aal5-8
create bridge port intf ifname eoa-8 portid 8 learning enable status enable
```

```
create atm port ifname atm-9 lowif dsl-9
create atm vc intf ifname aal5-9 lowif atm-9 vpi 8 vci 81
create eoa intf ifname eoa-9 lowif aal5-9
create bridge port intf ifname eoa-9 portid 9 learning enable status enable
```

```
create atm port ifname atm-10 lowif dsl-10
create atm vc intf ifname aal5-10 lowif atm-10 vpi 8 vci 81
create eoa intf ifname eoa-10 lowif aal5-10
create bridge port intf ifname eoa-10 portid 10 learning enable status enable
```

```
create atm port ifname atm-11 lowif dsl-11
create atm vc intf ifname aal5-11 lowif atm-11 vpi 8 vci 81
create eoa intf ifname eoa-11 lowif aal5-11
create bridge port intf ifname eoa-11 portid 11 learning enable status enable
```

```
create atm port ifname atm-12 lowif dsl-12
create atm vc intf ifname aal5-12 lowif atm-12 vpi 8 vci 81
create eoa intf ifname eoa-12 lowif aal5-12
create bridge port intf ifname eoa-12 portid 12 learning enable status enable
```

```
create atm port ifname atm-13 lowif dsl-13
create atm vc intf ifname aal5-13 lowif atm-13 vpi 8 vci 81
create eoa intf ifname eoa-13 lowif aal5-13
create bridge port intf ifname eoa-13 portid 13 learning enable status enable
```

```
create atm port ifname atm-14 lowif dsl-14
```

```
create atm vc intf ifname aal5-14 lowif atm-14 vpi 8 vci 81
create eoa intf ifname eoa-14 lowif aal5-14
create bridge port intf ifname eoa-14 portid 14 learning enable status enable
```

```
create atm port ifname atm-15 lowif dsl-15
create atm vc intf ifname aal5-15 lowif atm-15 vpi 8 vci 81
create eoa intf ifname eoa-15 lowif aal5-15
create bridge port intf ifname eoa-15 portid 15 learning enable status enable
```

```
create atm port ifname atm-16 lowif dsl-16
create atm vc intf ifname aal5-16 lowif atm-16 vpi 8 vci 81
create eoa intf ifname eoa-16 lowif aal5-16
create bridge port intf ifname eoa-16 portid 16 learning enable status enable
```

```
create atm port ifname atm-17 lowif dsl-17
create atm vc intf ifname aal5-17 lowif atm-17 vpi 8 vci 81
create eoa intf ifname eoa-17 lowif aal5-17
create bridge port intf ifname eoa-17 portid 17 learning enable status enable
```

```
create atm port ifname atm-18 lowif dsl-18
create atm vc intf ifname aal5-18 lowif atm-18 vpi 8 vci 81
create eoa intf ifname eoa-18 lowif aal5-18
create bridge port intf ifname eoa-18 portid 18 learning enable status enable
```

```
create atm port ifname atm-19 lowif dsl-19
create atm vc intf ifname aal5-19 lowif atm-19 vpi 8 vci 81
create eoa intf ifname eoa-19 lowif aal5-19
create bridge port intf ifname eoa-19 portid 19 learning enable status enable
```

```
create atm port ifname atm-20 lowif dsl-20
create atm vc intf ifname aal5-20 lowif atm-20 vpi 8 vci 81
create eoa intf ifname eoa-20 lowif aal5-20
create bridge port intf ifname eoa-20 portid 20 learning enable status enable
```

```
create atm port ifname atm-21 lowif dsl-21
create atm vc intf ifname aal5-21 lowif atm-21 vpi 8 vci 81
create eoa intf ifname eoa-21 lowif aal5-21
create bridge port intf ifname eoa-21 portid 21 learning enable status enable
```

```
create atm port ifname atm-22 lowif dsl-22
create atm vc intf ifname aal5-22 lowif atm-22 vpi 8 vci 81
```

```
create eoa intf ifname eoa-22 lowif aal5-22
create bridge port intf ifname eoa-22 portid 22 learning enable status enable

create atm port ifname atm-23 lowif dsl-23
create atm vc intf ifname aal5-23 lowif atm-23 vpi 8 vci 81
create eoa intf ifname eoa-23 lowif aal5-23
create bridge port intf ifname eoa-23 portid 23 learning enable status enable

create atm port ifname atm-24 lowif dsl-24
create atm vc intf ifname aal5-24 lowif atm-24 vpi 8 vci 81
create eoa intf ifname eoa-24 lowif aal5-24
create bridge port intf ifname eoa-24 portid 24 learning enable status enable

create filter rule entry ruleid 1 action sendtocontrol description IGMP
create filter subrule ip ruleid 1 subruleid 1 prototypefrom 2 prototypecmp eq
modify filter rule entry ruleid 1 status enable

create filter rule map ruleid 1 ifname eth-1 stageid 1

create filter rule map ruleid 1 ifname eoa-1 stageid 1
create filter rule map ruleid 1 ifname eoa-2 stageid 1
create filter rule map ruleid 1 ifname eoa-3 stageid 1
create filter rule map ruleid 1 ifname eoa-4 stageid 1
create filter rule map ruleid 1 ifname eoa-5 stageid 1
create filter rule map ruleid 1 ifname eoa-6 stageid 1
create filter rule map ruleid 1 ifname eoa-7 stageid 1
create filter rule map ruleid 1 ifname eoa-8 stageid 1
create filter rule map ruleid 1 ifname eoa-9 stageid 1
create filter rule map ruleid 1 ifname eoa-10 stageid 1
create filter rule map ruleid 1 ifname eoa-11 stageid 1
create filter rule map ruleid 1 ifname eoa-12 stageid 1
create filter rule map ruleid 1 ifname eoa-13 stageid 1
create filter rule map ruleid 1 ifname eoa-14 stageid 1
create filter rule map ruleid 1 ifname eoa-15 stageid 1
create filter rule map ruleid 1 ifname eoa-16 stageid 1
create filter rule map ruleid 1 ifname eoa-17 stageid 1
create filter rule map ruleid 1 ifname eoa-18 stageid 1
create filter rule map ruleid 1 ifname eoa-19 stageid 1
create filter rule map ruleid 1 ifname eoa-20 stageid 1
create filter rule map ruleid 1 ifname eoa-21 stageid 1
create filter rule map ruleid 1 ifname eoa-22 stageid 1
```



create filter rule map ruleid 1 ifname eoa-23 stageid 1

create filter rule map ruleid 1 ifname eoa-24 stageid 1

modify igmpsnoop port info portid 385 status enable

modify igmpsnoop port info portid 1 status enable

modify igmpsnoop port info portid 2 status enable

modify igmpsnoop port info portid 3 status enable

modify igmpsnoop port info portid 4 status enable

modify igmpsnoop port info portid 5 status enable

modify igmpsnoop port info portid 6 status enable

modify igmpsnoop port info portid 7 status enable

modify igmpsnoop port info portid 8 status enable

modify igmpsnoop port info portid 9 status enable

modify igmpsnoop port info portid 10 status enable

modify igmpsnoop port info portid 11 status enable

modify igmpsnoop port info portid 12 status enable

modify igmpsnoop port info portid 13 status enable

modify igmpsnoop port info portid 14 status enable

modify igmpsnoop port info portid 15 status enable

modify igmpsnoop port info portid 16 status enable

modify igmpsnoop port info portid 17 status enable

modify igmpsnoop port info portid 18 status enable

modify igmpsnoop port info portid 19 status enable

modify igmpsnoop port info portid 20 status enable

modify igmpsnoop port info portid 21 status enable

modify igmpsnoop port info portid 22 status enable

modify igmpsnoop port info portid 23 status enable

modify igmpsnoop port info portid 24 status enable

verbose on

end

### PropMib (Conexant)

---

- GSV-ABOND-MIB.mib
- GSV-ACL-MIB.mib
- GSV-ACT-STDBY-MIB.mib
- GSV-ADMIN-MIB.mib
- GSV-AGGR-MIB.mib
- GSV-ATM-MIB.mib
- GSV-BRIDGE-MIB.mib
- GSV-CLFR-MIB.mib
- GSV-CTLPKT-MIB.mib
- GSV-EHDLC-MIB.mib
- GSV-ENTERPRISE-INFO-MIB.mib
- GSV-ETHER-MIB.mib
- GSV-GENFLTR-MIB.mib
- GSV-IA-MIB.mib
- GSV-IGMP-MIB.mib
- GSV-IPOA-IPOE-MIB.mib
- GSV-IRL-MIB.mib
- GSV-LACP-MIB.mib
- GSV-PPPoE-MIB.mib
- GSV-PPPR-MIB.mib
- GSV-RDNCY-AGG-MIB.mib
- GSV-RL-MIB.mib
- GSV-SCHD-PRFL-MIB.mib
- GSV-SNTP-MIB.mib
- GSV-SYS-MIB.mib
- GSV-TC-MIB.mib
- GSV-TRAP-MIB.mib
- GSV-TRFCLASS-MIB.mib
- GSV-TRFCLASS-STATS-MIB.mib
- GSV-VC-AGGR-MIB.mib
- GSV-VMAC-MIB.mib

## StdMib (Standard)

---

- ADSL-DMT-LINE-MIB.mib
- ADSL-TC-MIB
- ATM-TC-MIB
- draft-ietf-atommib-atm2-17
- draft-ietf-bridge-bridgemib-smiv2-02
- draft-ietf-bridge-ext-v2-00
- draft-ietf-bridge-ext-v2-01
- EtherLike-MIB
- HCNUM-TC
- HC-PerfHist-TC-MIB
- IANAIfType-MIB.mib
- IEEE8023-LAG-MIB
- IF-MIB
- IP-MIB
- PerfHist-TC-MIB
- Q-BRIDGE-MIB
- RFC1213-MIB
- rfc2515
- rfc2662
- rfc2665
- rfc3440
- RMON2-MIB.mib
- RMON-MIB
- SNMP-FRAMEWORK-MIB
- SNMPv2-MIB
- SNMPv2-SMI
- SNMPv2-TC
- TOKEN-RING-RMON-MIB.mib
- VDSL-LINE-EXT-MCM-MIB
- VDSL-LINE-MIB.txt

### Understanding How 802.1X Authentication Works

IEEE 802.1X is a client-server-based access control and authentication protocol that restricts unauthorized devices from connecting to a local area network (LAN) through publicly accessible ports. 802.1X authenticates each user device that is connected to a switch port before making available any services that are offered by the switch or the LAN. Until the device is authenticated, 802.1X access control allows only Extensible Authentication Protocol over LAN (EAPOL) traffic through the port to which the device is connected. After authentication is successful, normal traffic can pass through the port.

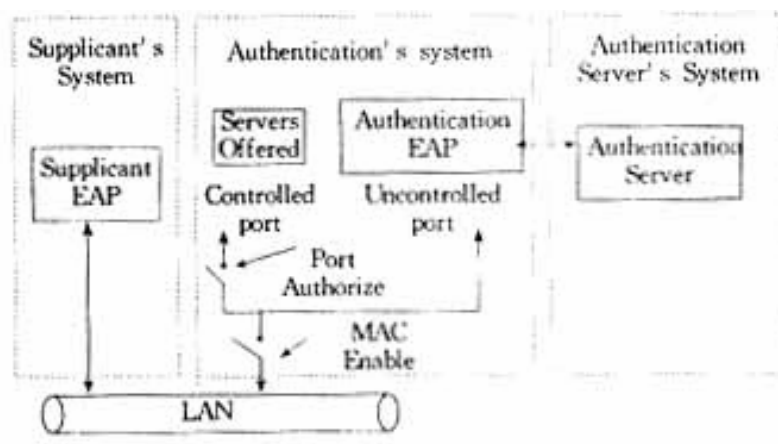

802.1X controls network access by creating two distinct virtual access points at each port (See Above Figure). One access point is an uncontrolled port; the other is a controlled port. All traffic through the single port is available to both access points. Only EAPOL traffic is allowed to pass through the uncontrolled port, which is always open. The controlled port is open only when the device that is connected to the port has been authorized by 802.1X. After this authorization takes place, the controlled port opens, allowing normal traffic to pass.

## Device Roles

With 802.1X port-based authentication, the devices in the network have specific roles. (See below figure).

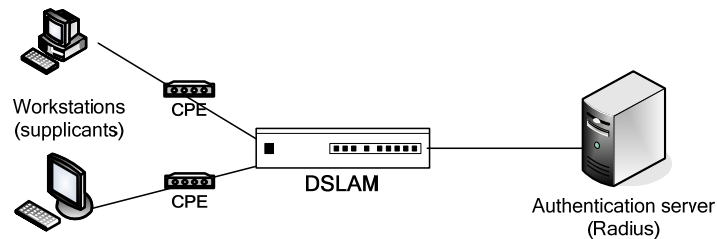

- Supplicant—Requests access to the LAN and switch services and responds to requests from the switch. The workstation must be running 802.1X-compliant software.
- Authentication server—performs the actual authentication of the host. The authentication server validates the identity of the host and notifies the DSLAM whether or not the host is authorized to access the LAN and DSLAM services. Because the DSLAM acts as the proxy, the authentication service is transparent to the host. In this release, the Remote Authentication Dial-In User Service (RADIUS) security system with Extensible Authentication Protocol (EAP) extensions is the only supported authentication server; it is available in Cisco Secure Access Control Server version 3.0. RADIUS operates in a client/server model in which secure authentication information is exchanged between the RADIUS server and one or more RADIUS clients.
- DSLAM (Authenticator)—Controls the physical access to the network that is based on the authentication status of the host. The DSLAM acts as an intermediary (proxy) between the host and the authentication server, requesting identity information from the host, verifying information with the authentication server, and relaying a response to the host. The DSLAM interacts with the RADIUS client. The RADIUS client encapsulates and decapsulates the EAP frames and interacts with the authentication server.
- When the DSLAM receives Extensible Authentication Protocol over LAN (EAPOL) frames and relays them to the authentication server, the Ethernet header is stripped and the remaining EAP frame is reencapsulated in the RADIUS format. The EAP frames are not modified or examined during encapsulation, and the authentication server must support EAP within the native frame format. When the DSLAM receives the frames from the authentication server, the server's frame header is removed, leaving the EAP frame, which is then encapsulated for Ethernet and sent to the host.

## Authenticcation Initiation and Message Exchange

The host initiate authentication by sending an EAPOL-start frame, which prompts the DSLAM to request the host's identity.

When the host supplies its identity, the DSLAM acts as the intermediary, pass EAP frames between the host and the authentication server until authentication succeeds or fails. If the authentication succeeds, the DSLAM port becomes authorized.

The specific exchange of EAP frames depends on the authentication method that is being used. The below fiugre shows a message exchange that is initiated by the host using the One-Time-Password (OTP) authentication method with a RADIUS server.

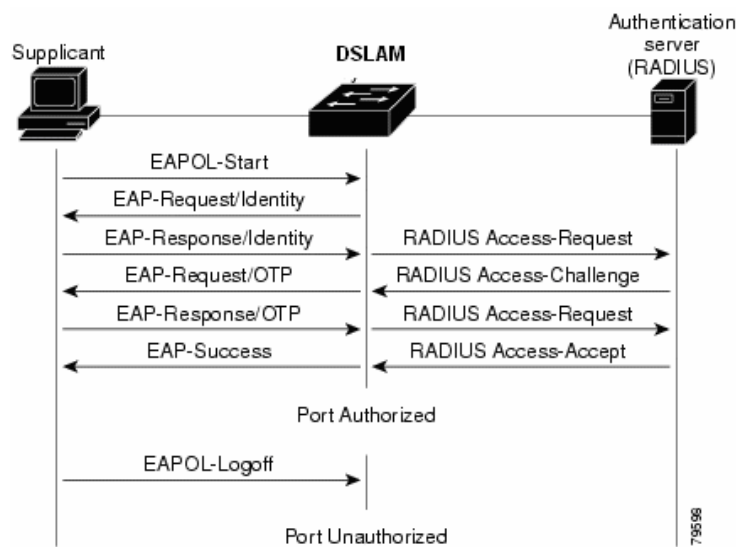

## 802.1X CLI commands

---

### Specifying RADIUS Servers

To specify one or more RADIUS servers, perform this task in privileged mode:

|        | Task  | Command  |
|--------|---|--|
| Step 1 | Specify the IP address of up to three RADIUS servers. Specify the primary server using the <b>primary</b> keyword. Optionally, specify the destination UDP port to use on the server. | <b>create radius server</b><br>ip_addr [acct-port<br>port_number] [ <b>primary</b> ] |
| Step 2 | Verify the RADIUS server configuration.   | <b>get radius</b>  |

### Specifying the RADIUS Key

Use the RADIUS key to encrypt and authenticate all communication between the RADIUS client and server. You must configure the same key on the client and the RADIUS server.

The length of the key is limited to 65 characters. It can include any printable ASCII characters except tabs.

To specify the RADIUS key, perform this task in privileged mode:

|        | Task   | Command                      |
|--------|--|------------------------------|
| Step 1 | Specify the RADIUS key that is used to encrypt packets that are sent to the RADIUS server. | <b>create radius key</b> key |
| Step 2 | Verify the RADIUS configuration.   | <b>get radius</b>            |

### Configuring 802.1X Authentication

The following sections describe how to configure 802.1X authentication on the switch.

## Enabling 802.1X globally

You must enable 802.1X authentication for the entire system.

To globally enable 802.1X authentication, perform this task in privileged mode:

| Task                    | Command  |
|-------------------------|--|
| Globally enable 802.1X. | <b>create dot1x system-auth-control enable</b> |

## Disabling 802.1X globally

When you enable 802.1X authentication for the entire system, you can disable it globally.

To globally disable 802.1X authentication, perform this task in privileged mode:

| Task                     | Command   |
|--------------------------|---|
| Globally disable 802.1X. | <b>Create dot1x system-auth-control disable</b> |

## Enabling and Initializing 802.1X Authentication Individual Ports

After you enable 802.1X authentication globally, you can enable and initialize 802.1X authentication from the console only for individual ports.

To enable and initialize 802.1X authentication for access to the switch, perform this task in privileged mode:

|        | Task                                      | Command  |
|--------|---|--|
| Step 1 | Enable 802.1X control on a specific port. | <b>create port dot1x <i>mod/port</i></b><br><b>port-control auto</b> |
| Step 2 | Initialize 802.1X on the same port.       | <b>Create port dot1x <i>mod/port</i> initialize</b>                  |
| Step 3 | Verify the 802.1X configuration.          | <b>get port dot1x <i>mod/port</i></b>                                |



## Enabling Multiple Hosts

You can enable a specific port to allow multiple users. When a port is enabled for multiple users, and a host that is connected to that port is authorized successfully, any host (with any MAC address) is allowed to send and receive traffic on that port. If you connect multiple hosts to that port through a hub, you can reduce the security level on that port.

To enable access for multiple users on a specific port, perform this task in privileged mode:

| Task                                      | Command  |
|---|--|
| Enable multiple hosts on a specific port. | <b>create port dot1x mod/port multiple-host enable</b> |

## Disabling Multiple Hosts

You must disable access for multiple users on any port where it is enabled.

To disable access for multiple users on a specific port, perform this task in privileged mode:

| Task                                       | Command   |
|--|---|
| Disable multiple hosts on a specific port. | <b>create port dot1x mod/port multiple-host disable</b> |

## 802.1X Protocol over IP DSLAM

In 802.1x application, the IP DSLAM acts as the pure Ethernet packets transport system. The 802.1x packets pass through the IP DSLAM without further operation (see below figure)

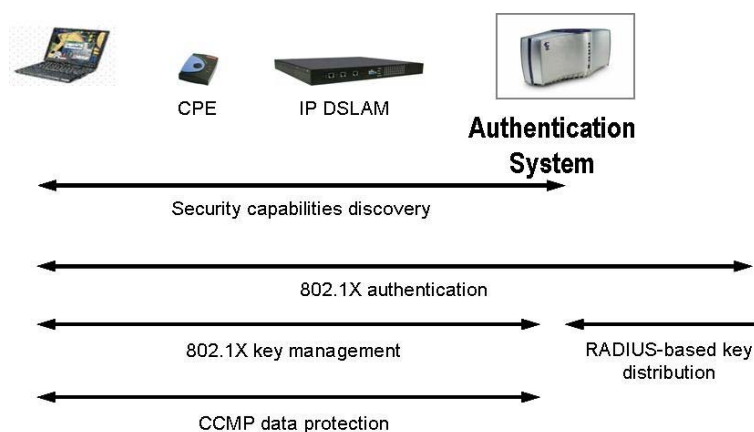

## Appendix D --- What's IP DSLAM

DSLAM and IP DSLAM in PPPoE application sample.

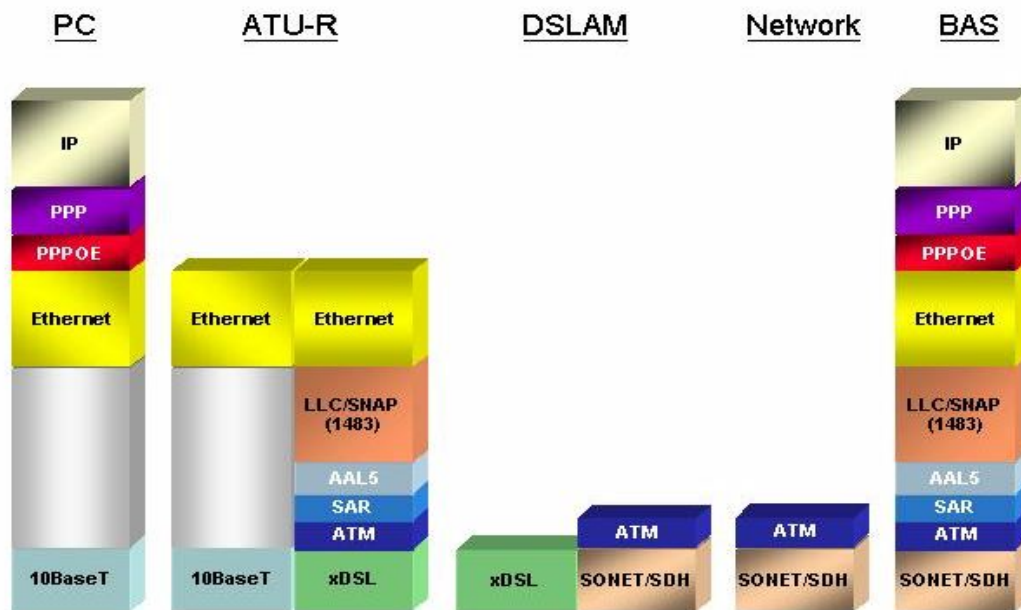

As above Figure displays, in traditional ATM-based ADSL network, the user application information is encapsulated by ADSL CPE into ATM cells in pre-defined VC (Virtual Channel, PVC), and then upstream the ATM cells to DSLAM via ADSL link. (In this example, the user information (PPPoE encapsulated) is encapsulated by ATU-R using RFC-1483 Bridge-mode encapsulation format.)

All the ATM cells belong to the specified VC is concentrated by the DSLAM, and switched in the ATM network clouds, to the defined destination (ISPs or Offices), at there the ATM cells and PPPoE frames is resolved by the Broadband Access Server, and the user application information is serviced.

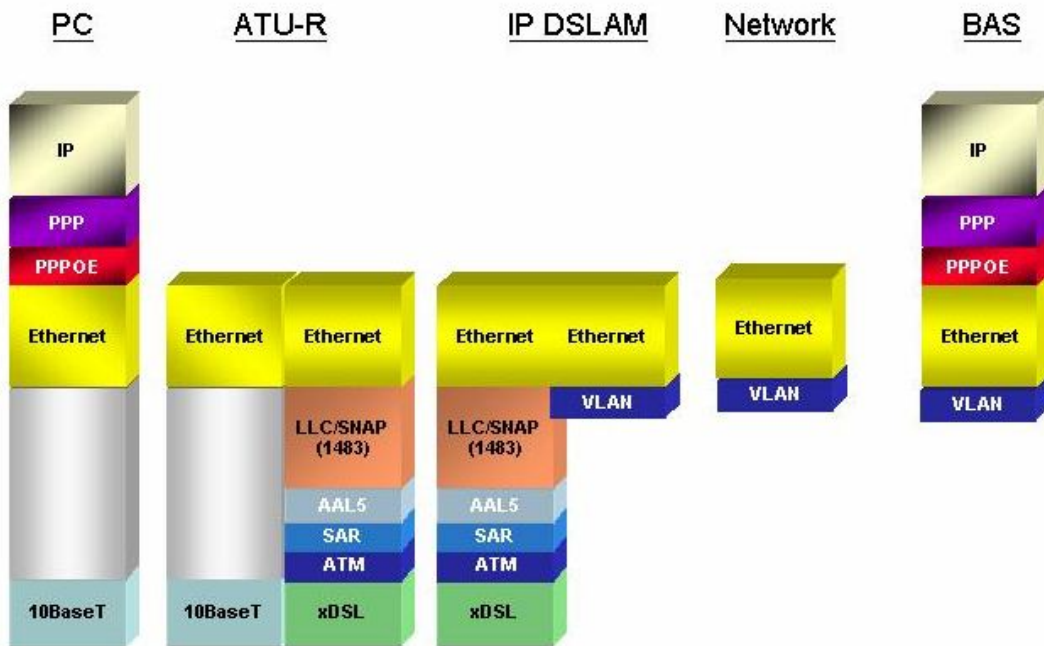

In addition to traditional ATM-based ADSL network. As above Figure displays, the user application information is still encapsulated by ADSL CPE into ATM cells in pre-defined VC (Virtual Channel, PVC), and then upstream the ATM cells to DSLAM via ADSL link.

In the IP DSLAM, all the ATM cells belong to the specified VC are decapsulated back to the original PPPoE encapsulated Ethernet packet (if VLAN-mode of the specified ADSL port is disabled), or mapped to the pre-defined Ethernet-VLAN packets (if VLAN-mode of the specified ADSL port is enabled). IP DSLAM concentrates all Ethernet-with/without VLAN-tag packets from 24/48 ports' ADSL and uplinks to ISP's Ethernet-All-The-Way network. The PPPoE frames will be resolved at Broadband Access Server (BAS), and the user application information was serviced.

The IP DSLAM supports ADSL CPE Bridge-mode. For future FW upgrade, the IP DSLAM can act as BRAS to process user application information directly.

IP DSLAM provides Ethernet-with/without VLAN tag to ATM-PVC mapping feature for the ISP to isolate user's data with security and to provide lots of service enhancement capabilities. IP DSLAM supports 8 ATM PVC links for each CPE.

## Free Manuals Download Website

<http://myh66.com>

<http://usermanuals.us>

<http://www.somanuals.com>

<http://www.4manuals.cc>

<http://www.manual-lib.com>

<http://www.404manual.com>

<http://www.luxmanual.com>

<http://aubethermostatmanual.com>

Golf course search by state

<http://golfingnear.com>

Email search by domain

<http://emailbydomain.com>

Auto manuals search

<http://auto.somanuals.com>

TV manuals search

<http://tv.somanuals.com>