

ProV950HB

USER'S GUIDE

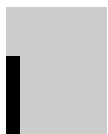

REAL



Hi8

CAMCORDER

IMPORTANT SAFETY INFORMATION

Be sure to read all safety information before you begin to use this product.

WARNING: TO REDUCE THE RISK OF FIRE OR ELECTRIC SHOCK, DO NOT EXPOSE THIS CAMCORDER OR AC ADAPTER/CHARGER TO RAIN OR MOISTURE.



CAUTION:

TO REDUCE THE RISK OF ELECTRIC SHOCK, DO NOT REMOVE COVER (OR BACK). NO USER-SERVICEABLE PARTS ARE INSIDE. REFER SERVICING TO QUALIFIED SERVICE PERSONNEL.



This symbol warns the user of uninsulated voltage within the unit that can cause dangerous electric shocks.



This symbol alerts the user that there are important operating and maintenance instructions in the literature accompanying this unit.

CAUTION: To reduce the risk of electric shock and fire hazard, do NOT use any other power source.

CAUTION: To prevent electric shock, match wide blade of plug to wide slot, fully insert.

ATTENTION: Pour éviter les chocs électriques, introduire la lame la plus large de la fiche dans la borne correspondante de la prise et pousser jusqu'au fond.

To reduce risk of injury, charge only rechargeable batteries recommended by the manufacturer for this camcorder. Other batteries may burst causing damage and personal injury.

FCC Regulations state that unauthorized changes or modifications to this equipment may void the user's authority to operate it.

NOTE: The camcorder's LCD panel is a very high technology product with 112,000 thin-film transistors*, giving you fine picture detail. Occasionally, a pixel may appear on the screen as a fixed point of blue, green, red, or black. Please note that this does not affect your camcorder's performance.

*Specifications are subject to change without notice.

Product Registration

Please fill out the product registration card and return it immediately. Returning this card allows us to contact you if needed.

Keep your sales receipt for proof of purchase to obtain warranty parts and service and attach it here. Record the serial and model numbers located on the bottom of the camcorder.

Model No: ProV950HB
Serial No: _____
Purchase Date: _____
Purchased From: _____

IMPORTANT SAFEGUARDS

In addition to the careful attention devoted to quality standards in the manufacture of your video product, safety is a major factor in the design of every instrument. However, safety is your responsibility too.

This sheet lists important information that will help to assure your enjoyment and proper use of the video product and accessory equipment. Please read it carefully before operating and using your video product.

Installation

1 Read and Follow Instructions—

All the safety and operating instructions should be read before the video product is operated. Follow all operating instructions.

2 Retain Instructions—The safety and operating instructions should be retained for future reference.

3 Heed Warnings—Comply with all warnings on the video product and in the operating instructions.

4 Polarization—This video product is equipped with a polarized alternating-current line plug (a plug having one blade wider than the other). This plug will fit into the power outlet only one way. This is a safety feature. If you are unable to insert the plug fully into the outlet, try reversing the plug. If the plug still fails to fit, contact your electrician to replace your obsolete outlet. To prevent electric shock, do not use this polarized plug with an extension cord, receptacle, or other outlet unless the blades can be fully inserted without blade exposure. If you need an extension cord, use a polarized cord.

5 Power Sources—This video product should be operated only from the type of power source indicated on the marking label. If you are not sure of the type of power supply to your home, consult your video dealer or local power company. For video products intended to operate from battery power, or other sources, refer to the operating instructions.

6 Overloading—Do not overload wall outlets or extension cords as this can result in a risk of fire or electric shock. Overloaded AC outlets, extension cords, frayed power cords, damaged or cracked wire insulation, and broken plugs are dangerous. They may result in a shock or fire hazard. Periodically examine the cord, and if its appearance indicates damage or deteriorated insulation, have it replaced by your service technician.

7 Power-Cord Protection—Power-supply cords should be routed so that they are not likely to be walked on or pinched by items placed upon or against them, paying particular attention to cords at plugs, convenience receptacles, and the point where they exit from the video product.

8 Ventilation—Slots and openings in the case are provided for ventilation to ensure reliable operation of the video product and to protect it from overheating. These openings must not be blocked or covered. The openings should never be blocked by placing the video product on a bed, sofa, rug, or other similar surface. This video product should never be placed near or over a radiator or heat register. This video product should not be placed in a built-in installation such as a bookcase or rack unless proper ventilation is provided or the video product manufacturer's instructions have been followed.

9 Attachments—Do not use attachments unless recommended by the video product manufacturer as they may cause hazards.

10 Water and Moisture—Do not use this video product near water—for example, near a bath tub, wash bowl, kitchen sink or laundry tub, in a wet basement, or near a swimming pool and the like.

Caution: Maintain electrical safety. Powerline operated equipment or accessories connected to this unit should bear the UL listing mark or CSA certification mark on the accessory itself and should not be modified so as to defeat the safety features. This will help avoid any potential hazard from electrical shock or fire. If in doubt, contact qualified service personnel.

11 Accessories—Do not place this video product on an unstable cart, stand, tripod, bracket, or table. The video product may fall, causing serious injury to a child or adult as well as serious damage to the video product. Use this video product only with a cart, stand, tripod, bracket, or table recommended by the manufacturer or sold with the video product. Any mounting of the product should follow the manufacturer's instructions and use a mounting accessory recommended by the manufacturer.

11A A video product and cart combination should be moved with care. Quick stops, excessive force, and uneven surfaces may cause the video product and cart combination to overturn.

Note to CATV System Installer:

This reminder is provided to call the CATV system installer's attention to Section 820-40 of the NEC which provides guidelines for proper grounding and, in particular, specifies that the cable ground shall be connected to the grounding system of the building, as close to the point of cable entry as practical.

(continued on next page)

IMPORTANT SAFEGUARDS

12 Outdoor Antenna Grounding—If an outside antenna or cable system is connected to the video product, be sure the antenna or cable system is grounded so as to provide some protection against voltage surges and built-up static charges. Section 810 of the National Electrical Code, ANSI/NFPA No. 70 (Section 54 of Canadian Electrical Code, Part 1) provides information with respect to proper grounding of the mast and supporting structure, grounding of the lead-in wire to an antenna-discharge unit, size of grounding conductors, location of antenna-discharge unit, connection to grounding electrodes, and requirements for the grounding electrode. See example below.

Example of Antenna Grounding

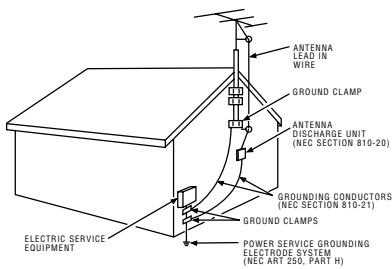

13 Power Lines—An outside antenna system should not be located in the vicinity of overhead power lines, other electric light or power circuits, or where it can fall into such power lines or circuits. When installing an outside antenna system, extreme care should be taken to keep from touching or approaching such power lines or circuits as contact with them might be fatal. Installing an outdoor antenna can be hazardous and should be left to a professional antenna installer.

Use

14 Cleaning—Unplug this video product from the wall outlet before cleaning. Do not use liquid cleaners or aerosol cleaners. Use a damp cloth for cleaning.

15 Object and Liquid Entry—Never push objects of any kind into this video product through openings as they may touch dangerous voltage points or “short-out” parts that could result in a fire or electric shock. Never spill liquid of any kind on the video product.

16 Lightning—For added protection for this video product during a lightning storm, or when it is left unattended and unused for long periods of time, unplug it from the wall outlet and disconnect the antenna or cable system. This will prevent damage to the video product due to lightning and power line surges.

Service

17 Servicing—Do not attempt to service this video product yourself as opening or removing covers may expose you to dangerous voltage or other hazards. Refer all servicing to qualified service personnel.

18 Conditions Requiring Service—Unplug this video product from the wall outlet and refer servicing to qualified service personnel under the following conditions.

- When the power-supply cord or plug is damaged.
- If liquid has been spilled, or objects have fallen into the video product.
- If the video product has been exposed to rain or water.
- If the video product does not operate normally by following the operating instructions. Adjust only those controls that are covered by the operating instructions. Improper adjustment of other controls may result in damage and will often require extensive work by a qualified technician to restore the video product to its normal operation.
- If the video product has been dropped or the cabinet has been damaged.
- When the video product exhibits a distinct change in performance—this indicates a need for service.

19 Replacement Parts—When replacement parts are required, have the service technician verify that the replacements he uses have the same safety characteristics as the original parts. Use of replacements specified by the video product manufacturer can prevent fire, electric shock, or other hazards.

20 Safety Check—Upon completion of any service or repairs to this video product, ask the service technician to perform safety checks recommended by the manufacturer to determine that the video product is in safe operating condition.

21 Wall or Ceiling Mounting—The product should be mounted to a wall or ceiling only as recommended by the manufacturer.

22 Heat—The product should be situated away from heat sources such as radiators, heat registers, stoves, or other products (including amplifiers) that produce heat.

Table of Contents

Assistance

We want to make sure you enjoy your new camcorder. If you have any questions, call:

Camcorder Exchange Warranty	800-283-6503 (pages 70-71)
Customer Service	800-336-1900 (page 69)
Accessories	800-338-0376 (pages 58-61)

Important Information

Important Safety Information	i
Important Safeguards	ii-iii
Supplied Accessories	3
Camcorder Controls	4-5

First-Time Operation

Installing the Lithium Cell in the Camcorder	6
Installing the Lithium Cell in the Remote Control ...	6
Attaching the AC Adapter/Battery Charger	7
Charging on the Docking Station	8
Inserting and Removing the Battery Pack	9
Powering the Camcorder from an AC Outlet	10
Powering the Camcorder from Your Car Battery ..	11
Inserting and Removing a Cassette	12
Controlling the Monitor Display	13
Using the On-Screen Menu	14-15
Warning Indicators	16
Setting the Area, Date, and Time	17
World Clock	18-20
Picture/Backlight Adjustments	21
Using the Hand Strap	22
Attaching the Shoulder Strap	22

Basic Operations Camera Recording

Easy Camera Recording with Full Auto	23
Zooming	24
Setting the Digital Zoom	24
Digital Quick Zoom (Extend Zoom)	25
Auto Focus	25
Backlight Compensation (BLC)	26
Gain-up (Cat's Eye)	26
Digital Image Stabilization (DIS)	27
Macro Shots	27
Fade In and Fade Out	28
Recording with the Wide Screen (16:9)	29
Quick Return	30
Edit Search	30
Tips on Recording Positions	31
Hints for Better Shooting	31
Setting the Camcorder to Full Auto Mode	32
Recording the Date and Time	32
Remaining Recording Time Display	33
Remaining Battery Power Display	33

Table of Contents

Basic Operations Playback

Playback	34
Volume Control	34
Fast Forward and Rewind	34
Using the Stand	35
Video Search	35
Still	35
Slow	35
Program Search	36
Using the Tape Counter	37
Counter Memory	38
Turning Off the LCD Monitor Backlight	38
Using the Infrared Remote Control	39

Useful Features for Camera Recording

Self Recording	40-42
Manual Focus	43
Scene Menu (Program AE)	44
Setting the Shutter Speed	45
White Balance Lock	46
Manual Iris	47
Recording a Five-second Still Image (Snapshot)	48
Still Recording	48
Strobe Recording	49
Stopwatch	49-50
Lighting	51

Connections and Editing

Connection to TV Using the Docking Station	52
Connection to TV Using a VCR	52
Connections for Playback on a TV Using Audio/Video Jacks	53
Use the Camcorder to Play Back Tapes on a TV	53
Using the Optional SAV103 A/V Pack	54
Editing	55
Recording from an External Source	56

References

Fluorescent Lamp Backlight	57
Optional Accessories	58
Accessory Order Form	59-61
Use and Care	62-65
Trouble Checks	66-67
Specifications	68
Information to User	68
Customer Assistance and Service	69
Limited Warranty	70-71
Index	72-75

Supplied Accessories

This section describes only the basic steps necessary to set up your camcorder to record. Refer to the other sections for detailed operation and feature options.

Assistance

These toll-free numbers are available to help you with any problems you may encounter.

Camcorder Exchange Warranty	800-283-6503
Customer Service	800-336-1900
Accessories	800-338-0376

Supplied Accessories

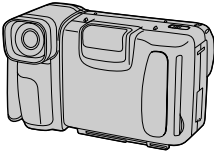

Model ProV950HB

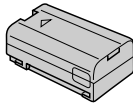

Rechargeable Battery Pack
Part No. BB75

WARNING: LITHIUM-ION (RECHARGEABLE) BATTERY MUST BE RECYCLED OR DISPOSED OF PROPERLY. DO NOT INCINERATE OR DISASSEMBLE—MAY EXPLODE OR RELEASE TOXIC MATERIALS. DO NOT SHORT CIRCUIT—MAY CAUSE BURNS.

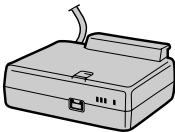

AC Adapter/Charger
Part No. 233576

CAUTION: Do not use this adapter/charger for any purpose other than charging the BB75 or BB90 battery pack or supplying power to the camcorder.



Remote Control
Part No. 233581



Shoulder Strap
Part No. 233580

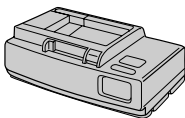

Docking Station
Part No. 233665

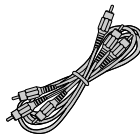

Audio/Video Cable
Part No. 233582

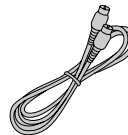

S-Video Cable
Part No. 233579

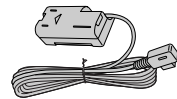

DC Output Cable
Part No. 233578



Two Lithium Cells
3-Volt Micro Lithium
Cells – such as CR2025
– are available from
most local drug stores
and camera shops.
Use of other cells
present a risk of fire or
explosion.

CAUTIONS: Lithium cells must be disposed of properly. Never handle punctured or leaking cells. May cause burns or personal injury.

Keep out of the hands of children. Can cause death or injury if swallowed. If swallowed, consult a physician immediately for emergency treatment.

The lithium cells used in these devices may explode resulting in a fire or chemical burn if mistreated. Do not recharge, disassemble, heat above 212° F (100°C), or incinerate.

Never use metallic tweezers to hold the cell, and never short circuit the + and – sides of the cell.

Camcorder Controls

For details on the use of each control, refer to the page number indicated in the brackets.

Front View

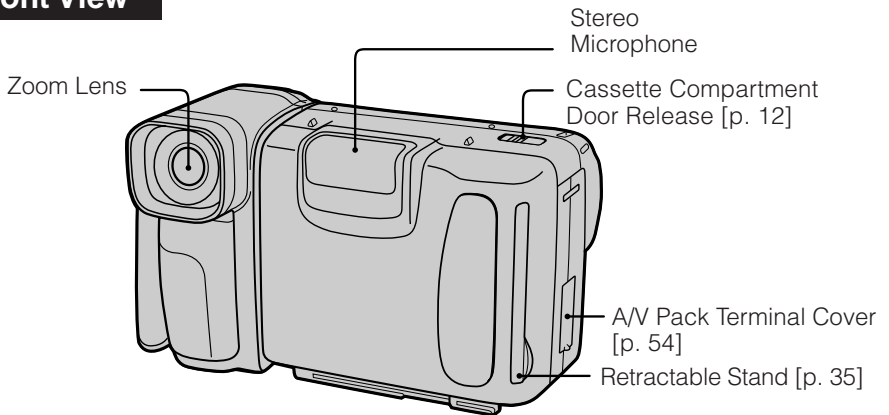

When the cassette compartment door is opened

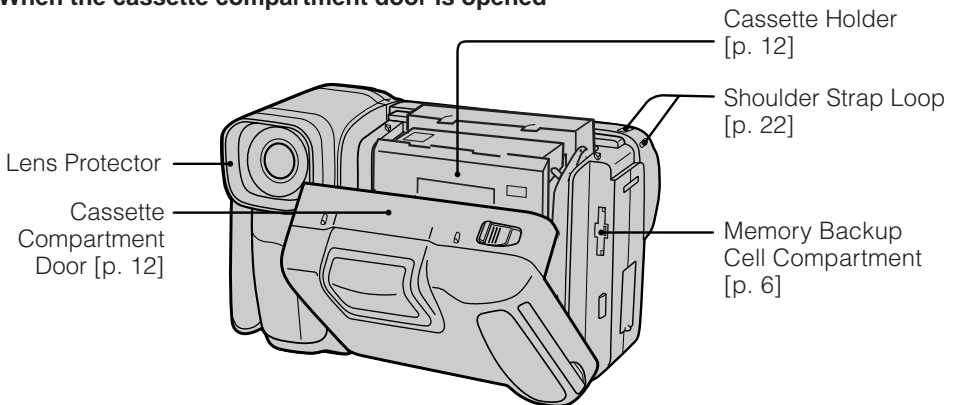

Removing the Lens Protector

Before mounting an optional wide or telephoto conversion lens, remove the lens protector by turning it counter-clockwise.

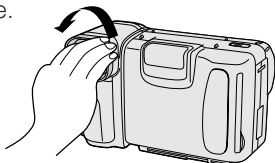

Rear View

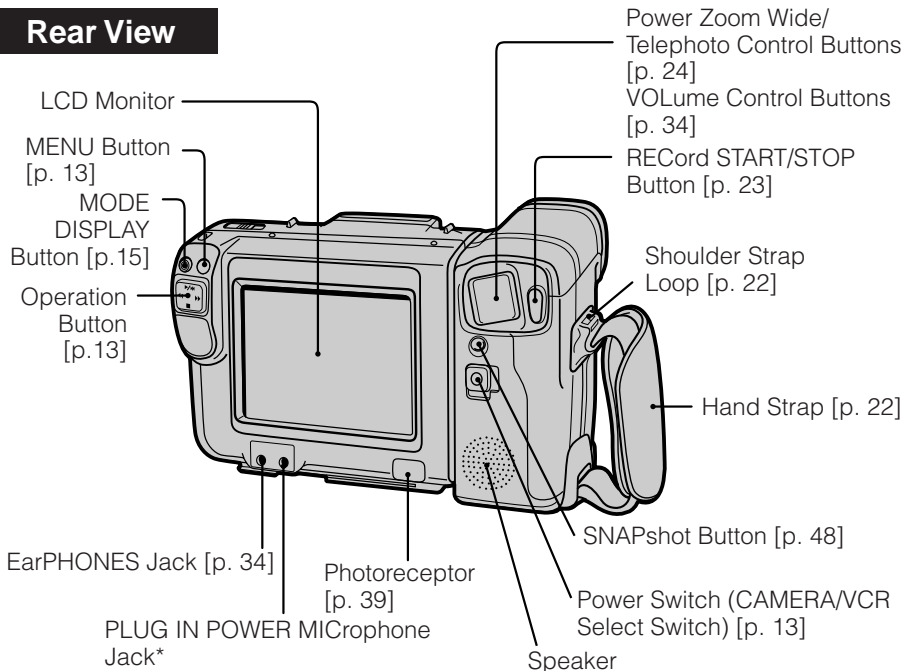

*About the PLUG IN POWER MIC Jack

This external microphone jack outputs a DC voltage of 4.0 V. It is for use with any 2.5–4.0 volt DC use condenser-type microphone with a 3.5 mm diameter plug. The use of other types of microphones may result in damage to the microphone or the camcorder.

Side View

When Camera Module is Rotated

Fluorescent Lamp Compartment [p. 57]

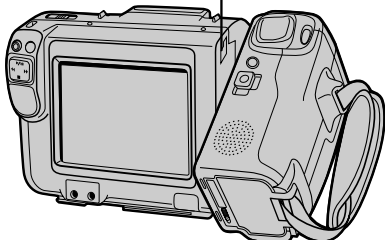

Bottom View

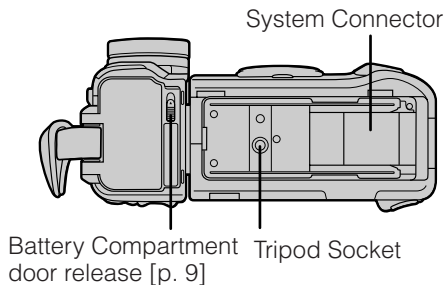

First-Time Operation

Installing the Lithium Cell in the Camcorder

- 1 Slide the release and open the cassette compartment door. (The cassette holder opens automatically.) Pull out the cell holder using a pointed object such as the point of a pen, as shown.

Cassette Compartment Door Release

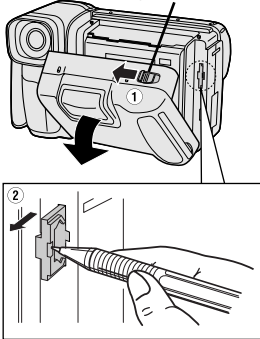

- 2 Insert the supplied lithium cell into the holder with the + side facing outward.

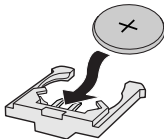

- 3 Insert the cell holder back into its compartment, and push it in completely.

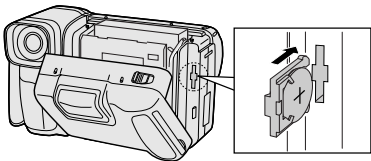

- 4 Press the "PUSH" mark until the cassette holder clicks into place. Then, close the cassette compartment door firmly until it clicks.

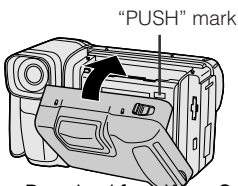

WARNING: Replace cell only with 3-volt micro lithium cells – such as CR2025 – available from most local drug stores and camera shops. Use of other cells present a risk of fire or explosion.

Cautions:

Lithium cells must be disposed of properly. Never handle punctured or leaking cells. May cause burns or personal injury.

Keep out of the hands of children. Can cause death or injury if swallowed. If swallowed, consult a physician immediately for emergency treatment.

The lithium cells used in these devices may explode resulting in a fire or chemical burn if mistreated. Do not recharge, disassemble, heat above 212° F (100°C), or incinerate.

Never use metallic tweezers to hold the cell, and never short circuit the + and - sides of the cell.

Notes:

- The lithium cell is used to back up the calendar and other memory functions.
- The battery will last about one year of normal usage.
- Replace the battery with a new CR2025 cell when the camcorder's time indicator starts to fall behind the correct time.

Installing the Lithium Cell in the Remote Control

- 1 Hold the remote control face down. Then pull out the cell holder while pressing the tab toward the center.

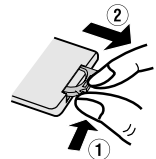

- 2 Install the supplied CR2025 lithium cell with its + side matching the ⊕ marked side of the cell holder into the cell holder.

- 3 Insert the cell holder in the direction of the arrow. Make sure that the ⊕ side faces the back of the remote control.

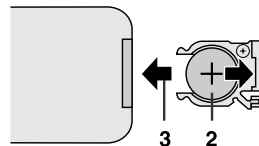

Attaching the AC Adapter/ Battery Charger

Precautions:

- If used near a radio, the AC adapter/battery charger may interfere with reception.
- Prevent flammables, liquids, and metal objects from entering the unit.
- This is a sealed unit. Do not attempt to open or modify it.
- Do not damage, drop, or subject the unit to vibration.
- Do not leave the unit in direct sunlight.
- Avoid using the unit in humid or extremely hot places.
- If the power source becomes disconnected during recording, playback, or other operations, the tape will remain wrapped around the drum, causing possible damage to the tape. Reconnect the power source to the main unit immediately.
- The supplied AC adapter/battery charger is specially designed for use with this camcorder, and should not be used as a power supply for other camcorders.

Charging the Battery Pack

- 1 Be sure the DC output cable is disconnected from the AC adapter/battery charger. Insert the AC plug into a power outlet. The POWER indicator will light.

To Power Outlet POWER Indicator

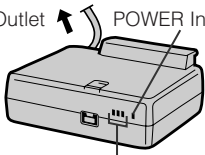

CHARGE Indicators

- 2 Align the ▼ mark on the battery with the ▲ mark on the charger (①). Guide the battery into the groove. Pressing the battery (②), slide it in the direction of the arrow (③) until it locks into place.

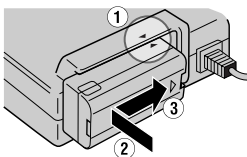

- 3 When the battery is charged, all three CHARGE indicators will light. Remove the battery and the AC plug.

CHARGE Indicators

	Charging starts. (Indicator starts flashing.)
	Now charging.
	Charging completed. (The indicators will turn off approximately 90 to 120 minutes after charging is completed.)

Charging Time Using AC Adapter/Battery Charger

Battery Pack	Charging Time
BB75	Approx. 90 min.

Notes:

- The battery and charger warm up during charging. This is not a malfunction.
- Charging time depends on the ambient temperature and the condition of the battery.

Cautions:

- Charge only BB75 battery pack. Other types of batteries may burst, causing personal injury and damage.
- Do not incinerate or mutilate the battery pack. It may present the risk of a rise in surface temperature, and/or the release of flammable vapors.
- Replace battery with BB75 only. Use of another battery may present a risk of fire or explosion.

Attaching the AC Adapter to the Docking Station

Attach the AC adapter to the Docking Station and insert the AC plug into a power outlet.

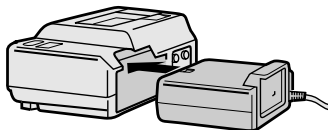

Removing the AC Adapter from the Docking Station

Press the AC adapter release button and pull out the adapter.



First-Time Operation

Charging on the Docking Station

If the camcorder is attached to the Docking Station, the battery pack in the camcorder can be charged automatically and continuously. The Docking Station keeps your camcorder ready to operate at any time.

- 1 Attach the AC adapter to the Docking Station and insert the AC plug into a power outlet (see page 7).
- 2 Insert the battery pack in the camcorder (see page 9).
 - Make sure that the Power switch is set to OFF. Charging is not possible when the camcorder is in the VCR or Camera mode.

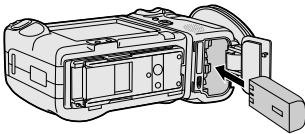

- 3 Attach the camcorder to the Docking Station with the LCD monitor facing the Docking Station's LED lamp window side (1). Then slide the camcorder securing lever on the Docking Station in the direction of the arrow to the lock position (2). Charging starts automatically.

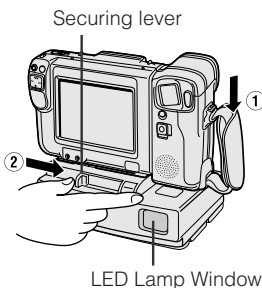

Caution:

- If you remove the camcorder from the Docking Station without first setting the Power switch to OFF while the battery pack is in the camcorder, the power may turn off and not turn on even if you set the Power switch to CAMERA or VCR.

Charging Two Battery Packs at the Same Time

You can charge two battery packs at the same time using the Docking Station unit.

- 1 Attach the first battery pack to the AC adapter/battery charger.
- 2 Insert the second battery pack in the camcorder and attach the camcorder to the Docking Station.
 - The battery pack on the AC adapter/battery charger will be charged first and then the battery pack in the camcorder will be charged.
 - The charge level of the battery pack in the camcorder can be monitored by removing the camcorder from the Docking Station and setting it to Camera or VCR mode.

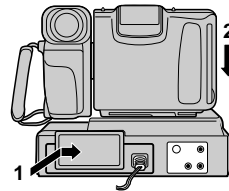

Note:

- Charging the battery pack fully in the camcorder on the Docking Station will take approximately 11 hours with BB75. If you are in a hurry, we recommend you use the AC adapter.

Removing the Camcorder from the Docking Station

Press the camcorder release button and remove the camcorder.



Note:

- If the camcorder is removed from the Docking Station, the battery pack inside will naturally discharge with time, even after it has been fully charged. We recommend you place the camcorder on the Docking Station even when it is not in use.

Cautions:

- Do not use excessive force with the camcorder and/or Docking Station. Doing so may cause damage or malfunction.
- When installing the camcorder on the Docking Station, be sure to lock it firmly with the securing lever. When removing, hold the camcorder firmly while releasing the lock so that the camcorder will not fall over.

Inserting and Removing the Battery Pack

Inserting the Battery Pack

- Slide the battery compartment door release on the bottom of the camcorder in the direction of the arrow (1), to open the battery compartment door (2).

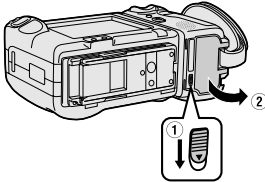

- Insert the battery pack into the compartment (1), as shown, and push it in completely (2).

Caution:

- Do not force the battery pack into the battery compartment if it does not go in easily.

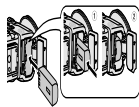

- Close the door. Be sure to push firmly until it clicks.

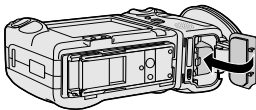

Removing the Battery Pack

Perform step 1 above. Then, with the camcorder facing down, press the lock as shown (1), and remove the battery pack (2).

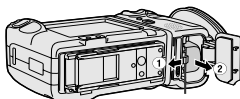

Lock

Cautions:

- BEFORE REMOVING THE BATTERY PACK, ALWAYS STOP THE TAPE AND TURN THE POWER OFF. If you remove the battery pack during recording or playback, the tape will remain wound around the video head drum and may be damaged. Should the power source (battery or adapter) become disconnected during operation, reconnect it again immediately.
- Do not expose the battery compartment door to strong force, as it may come off.
- Be sure to close the battery compartment door firmly, especially during operations. If you do not, the battery pack may come off or camcorder operation may fail because of the poor contact pressure.
- Remove the battery pack from the camcorder or disconnect the camcorder from the AC adapter if the camcorder will not be used for a long time.
- When removing the battery pack, do not tilt the camcorder so that the battery compartment faces down. The battery pack may fall out.

Battery Pack Handling

- Make sure that you take enough battery packs with you to provide two to three times your estimated recording time.
- Recording time will be reduced in cold weather.
- The battery will drain in Recording Standby mode. Turn off the power if you will not be recording again soon.

First-Time Operation

Powering the Camcorder from an AC Outlet

- 1 Slide the battery compartment door release on the bottom of the camcorder in the direction of the arrow (1), to open the battery compartment door (2).

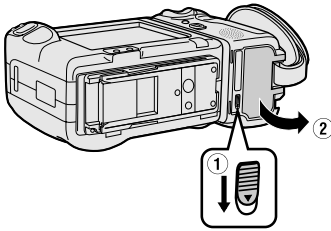

- 2 Slide the cable notch cover in the direction of the arrow shown in the diagram.

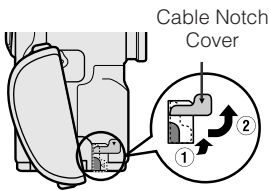

- 3 Insert the DC cable connecting plate into the compartment (1), pass the DC cable through the battery compartment notch, and then close the battery compartment door firmly (2).

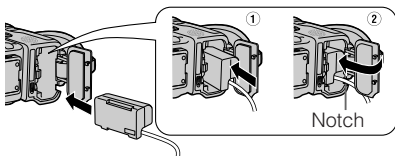

- 4 Insert the cable plug into the DC OUT jack on the supplied AC adapter.

- 5 Plug the power cord into a power outlet. The POWER indicator on the AC adapter will light.

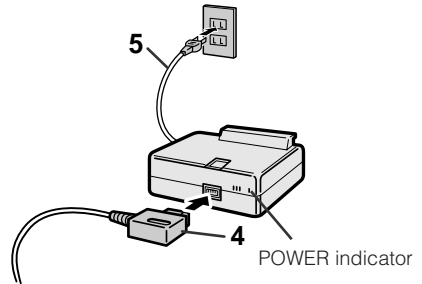

Removing the DC Cable from the Camcorder

- 1 Slide the battery compartment door release and open the door.
- 2 Press the lock as shown (1), remove the cable from the notch and then remove the DC cable (2).

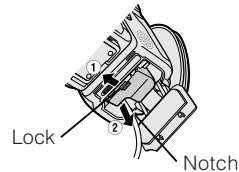

Note:

- The DC cable can be easily removed by facing the camcorder down at an angle.

Cautions:

- Turn the Power switch off before removing the DC cable.
- When removing the DC cable, grasp the connecting plate, not the cable itself, and pull it out of the compartment.

Using an Optional Plug Adapter

An optional plug adapter may be required in some countries.

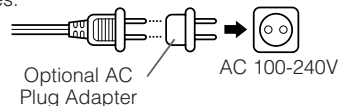

- 1 Plug the adapter/charger's plug into the AC plug adapter.
- 2 Plug the AC plug adapter into the AC outlet.

Powering the Camcorder from Your Car Battery

Use the optional SDC100 car battery adapter (shown on page 58) to power the camcorder from your car battery.

- 1 Open the battery compartment door release on the bottom of the camcorder and insert the DC cable connecting plate in the camcorder.

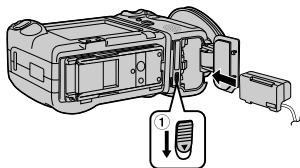

- 2 Pass the DC cable through the battery compartment notch, then close the battery compartment door.
- 3 Insert the DC cable plug into the DC OUT jack on the car battery adapter.
- 4 Start the car engine and leave it idling. Then, insert the power cord plug of the car battery adapter into the cigarette lighter socket.

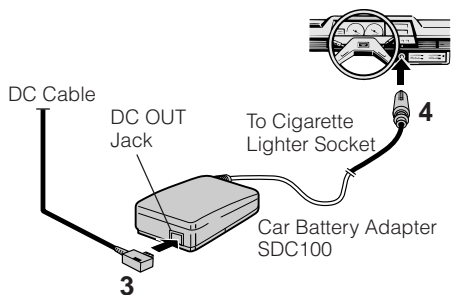

Note:

- See the SDC100 operation manual for details.

Cautions:

- Use only in DC 12 V or 24 V negative ground system cars. Positive-ground car batteries CANNOT BE USED. Check your car operation manual or consult a local car dealer.
- Use the car battery adapter only when the car is idling or being driven. Otherwise, the car's battery will be drained.
- Before starting the car engine, the car battery adapter must be unplugged from the cigarette lighter socket.
- Before removing either the DC plug or the cigarette lighter plug, the camcorder's Power switch should be set to OFF.
- Do not apply strong force to the DC cable connected to the camcorder as this will cause a malfunction.

Inserting and Removing a Cassette

Inserting a Cassette

- 1 Slide the release and fully open the cassette compartment door.
 - The cassette holder opens automatically.

Cassette compartment door release

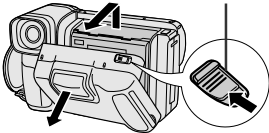

- 2 Insert the tape cassette fully with the window facing out and the erasure protect tab facing up.

Erasure Protect Tab

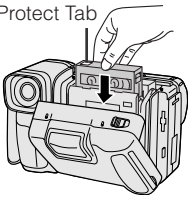

- 3 Press the "PUSH" mark until the cassette holder clicks into place.
 - The cassette holder retracts automatically.

"PUSH" Mark

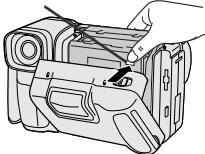

- 4 Wait for the cassette holder to fully retract. Close the compartment door pressing its center until it clicks into place.

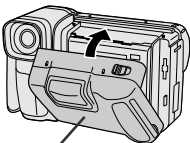

Press Here.

Removing a Cassette

Perform step 1 and then remove the cassette.

Cautions:

- Be careful not to get your fingers caught in the cassette compartment.
- Do not apply force to the cassette compartment except for pressing the "PUSH" mark to close it.
- Do not tilt the camcorder or hold it upside down when you are inserting or removing a cassette. It may damage the tape.
- Remove the cassette if you will not use the camcorder for a long time.
- If you do not press the cassette holder closed correctly in step 3, the camcorder's cassette protection mechanism might eject the cassette. If this happens, repeat the insertion procedure.
- Do not attempt to pick up the camcorder by the cassette compartment door.
- If the compartment door does not close when gently pressed into position, check the compartment door release. The door release may not be completely opened as shown below on the left. In this case, slide the door release in the direction of the arrow and press the compartment door closed.



- If the battery power is too low, you may not be able to eject the cassette or operate the Power switch. Replace the battery pack with a fully charged one.
- If the tape cassette is loaded when dew has formed, the camcorder's cassette protection mechanism might eject the cassette (see page 63). Check that the cassette holder has retracted completely before closing the cassette compartment door.

Controlling the Monitor Display

You can use various functions and make mode settings while viewing the monitor display.

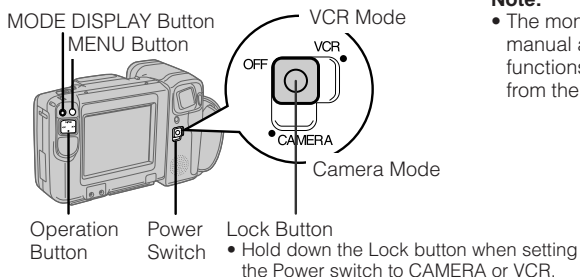

Note:

- The monitor illustrations in this operation manual are for the purpose of explaining the functions of the camcorder, and may differ from the actual monitor displays.

Camera mode (when the Power switch is set to CAMERA)

- Each time you press the MENU button, the screen changes from 14 to 44.
- With the 44 screen displayed, press ► on the operation button (⏏) to select "MENU". Each time you press ◀ or ▶ on the ⏏ button, the screen changes from MENU-PAGE 1 to 4.
- If the area, date and time have not been set, MENU-PAGE 4 appears when you press ► on the ⏏ button to select "MENU" on 44 (see page 17).

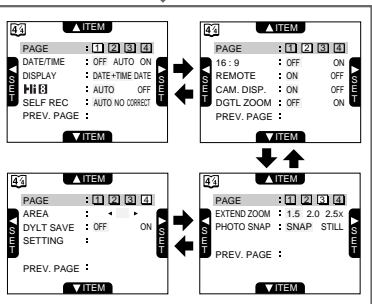
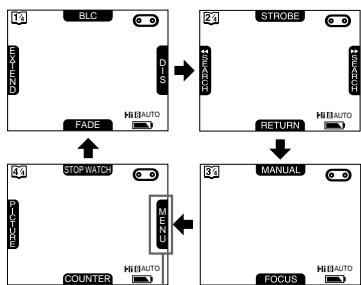

VCR mode (when the Power switch is set to VCR)

- Each time you press the MENU button, the screen changes from 13 to 33.
- With the 33 screen displayed, press ► on the ⏏ button to select "MENU". The menu screen will appear.

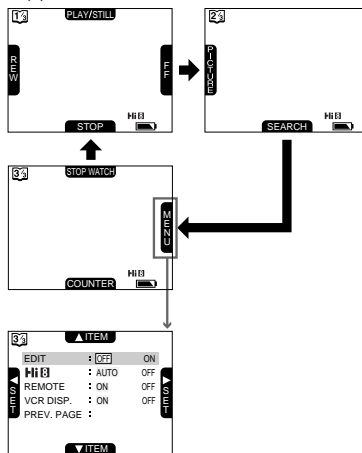

Note:

- The above displays are those when a cassette is loaded in the camcorder and the power is supplied from a battery pack.

About the Operation button



Use this button to select and set the various functions on the monitor by pressing ① ►►, ② ◀◀, ③ ■, or ④ ►► as shown.

(① Up, ② Left, ③ Down, ④ Right)

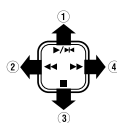

Using the On-Screen Menu

1 To display the Camera mode menu screen:

Hold down the Lock button and slide the Power switch to CAMERA.

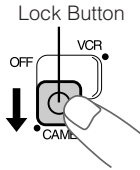

To display the VCR mode menu screen:

Hold down the Lock button and slide the Power switch to VCR.

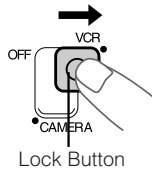

2 Press the MENU button until **4 4** screen appears. (Select **3 3** in VCR mode.)

Ex. Camera Mode

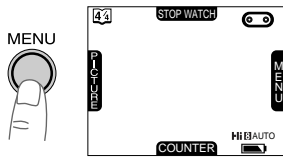

3 Press **▶▶** on the operation button (**3 3**) to select "MENU". MENU-PAGE **1 1** will appear on the monitor.

- There is only one menu page in VCR mode. Skip step 4.

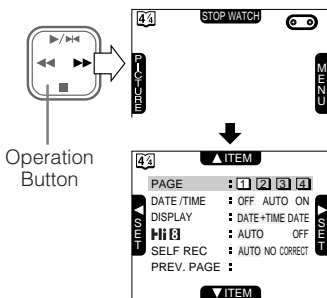

4 Press **◀◀** or **▶▶** on the **3 3** button to change from MENU-PAGE **1 1** to **4 4**.

Ex. Camera Mode

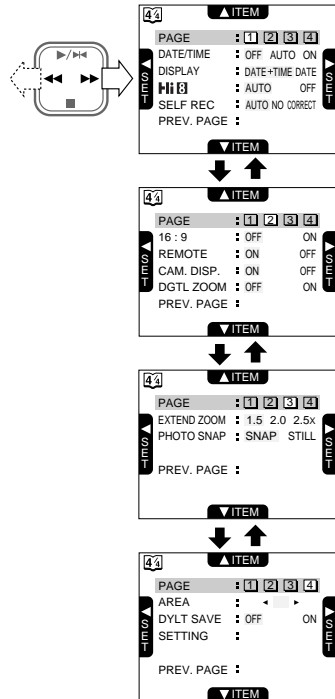

5 Press **▶/▶▶** or **◀** on the **3 3** button to select the menu item you wish to set.

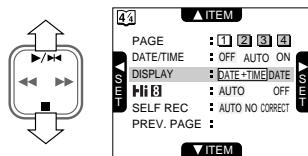

6 Press **◀◀** or **▶▶** on the **3 3** button to set the desired mode.

- Each time you press the button, the item setting changes as shown on the next page.

Note:

- If the area, date and time have not been set, MENU-PAGE **4 4** appears.

1) Camera Mode

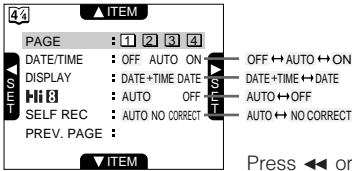

Press ◀ or ▶ on the button to change from MENU-PAGE 1 to 4.

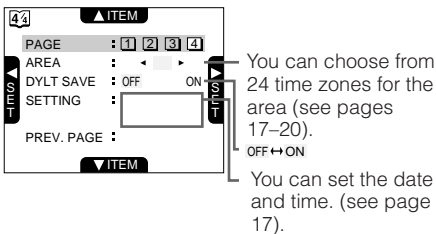
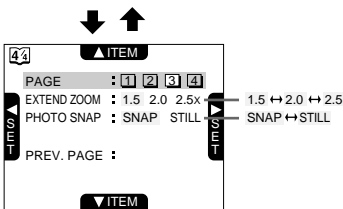
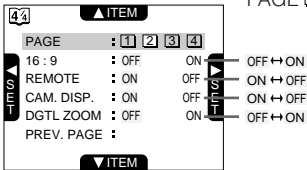

2) VCR Mode

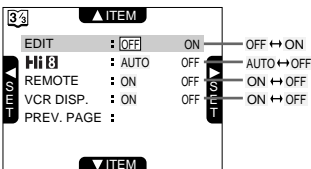

7 After completing the setting, press the MENU button. The menu screen will disappear.

Notes:

- Certain menu items are common to both the Camera and VCR modes. If the “REMOTE” menu item, for example, is set to “OFF” in the Camera mode, it will automatically be set to “OFF” in the VCR mode.
- The menu screen cannot be displayed when the camcorder is recording.
- To turn off the menu display, press the MENU button or MODE DISPLAY button. When the MENU button is pressed, the menu screen will disappear and the 14 screen will be displayed. When the MODE DISPLAY button is pressed, operation indicators will disappear. Press it again to display the indicators.

Returning to the Previous Screen

Press ■ on the button to select “PREV. PAGE” and then press ◀ or ▶ on the button to select “SET” to return to the previous screen.

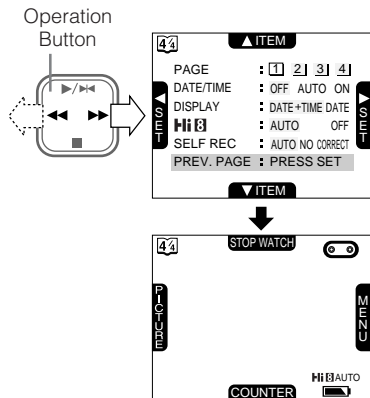

First-Time Operation

Warning Indicators

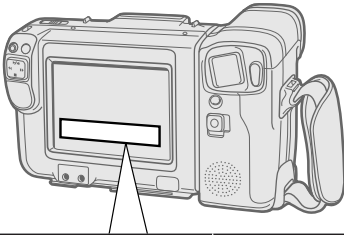

Display for the first 3 seconds	Display after the first 3 seconds	Description of Warning
EJECT THE CASSETTE.	EJECT THE CASSETTE.	The video cassette is defective and should be removed.
DEW		Dew has formed inside the camcorder. Wait for a few hours until the dew disappears (see page 63). About ten seconds after this warning appears, the camcorder and display turn off.
BATTERY IS TOO LOW.		The battery is almost depleted. Note: Operation of the zoom may interrupt the camcorder power. Replace the battery pack.
		The video heads are clogged and should be cleaned (see page 63).
INSERT A CASSETTE.		There is no tape cassette in the camcorder. Load a cassette.
CASSETTE NOT RECORDABLE.		The red erasure protect tab in the video cassette has been slid to the record-protect position, preventing recording.
THE TAPE ENDS SOON.		The tape is about to end. Get ready to load a new cassette.
CHANGE THE CASSETTE.	TAPE END	The tape has reached its end. Load a new cassette.
REPLACE THE LAMP.	REPLACE THE LAMP.	The fluorescent lamp behind the LCD monitor is close to the end of its service life. Replace it with a new one (see page 57). The LCD monitor turns off about one minute after this warning is displayed.
		During Self Recording mode, every warning indicator is replaced by a "⬠" indicator displayed in the center of the monitor. To check the meaning of the warning, rotate the monitor back to the normal position.

Note:

- indicates a blinking display.

Setting the Area, Date and Time

Example:

Setting the date to June 2, 1997 (JUN. 2.1997) and the time to 10:30 am (10:30 AM) in New York.

Note:

- Check that the memory backup lithium cell has been installed before setting the date and time.

- Set the Power switch to CAMERA. Press the MENU button until **44** appears on the monitor (Camera mode).

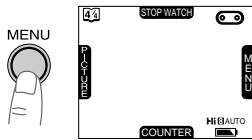

- Press **▶▶** on the operation button (**44**) to select "MENU". The MENU-PAGE **44** appears.
 - If the date and time have been set, the MENU-PAGE **11** appears.

Operation Button

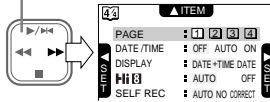

- Press **▶▶** on the **44** button to select PAGE **41**.

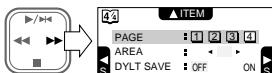

- Press **■** on the **44** button to select "AREA" (1), then press **◀◀** or **▶▶** on the **44** button until "20" (New York) appears (2).

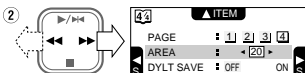
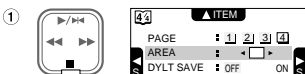

- See the time zone chart on page 19 and the area table on page 20 for area numbers and representative cities for each time zone.

- Press **■** on the **44** button to select "SETTING". Then press **▶▶** on the **44** button to select "SET".

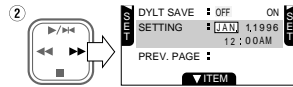
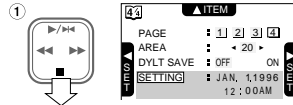

- Press **▶▶** or **■** on the **44** button to select "JUN." (month), and press **▶▶** on the **44** button.

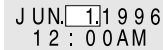

- Press **▶▶** or **■** on the **44** button to select "2." (day), and press **▶▶** on the **44** button.

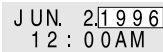

- Press **▶▶** or **■** on the **44** button to select "1997" (year), and press **▶▶** on the **44** button.

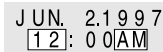

- Press **▶▶** or **■** on the **44** button to select "10 AM" (hour), and press **▶▶** on the **44** button.

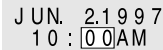

- Press **▶▶** or **■** on the **44** button to select "30" (minutes), and press **▶▶** on the **44** button.

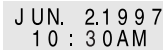

The date and time settings are now complete.

To Turn Off the Menu Display

Press the MENU button.

Notes:

- The internal clock starts operating when **▶▶** on the operation button (**44**) is pressed in step 10 above.
- When the tape cassette is inside, if no settings are made within 5 minutes after the menu display appears, the display is automatically canceled.
- If you set the area to the blank setting in step 4, and then reset the area after setting the date and time, the date and time will not appear on the screen even if you turn off the menu display. If you want to reset the area, perform steps 4–10 again.

First-Time Operation

World Clock

This camcorder is equipped with a world clock feature. It allows you to easily adjust the time when you use the camcorder while traveling anywhere in the world outside your own time zone. Set the area, date and time if they are not already set. (See page 17.)

Operation Button

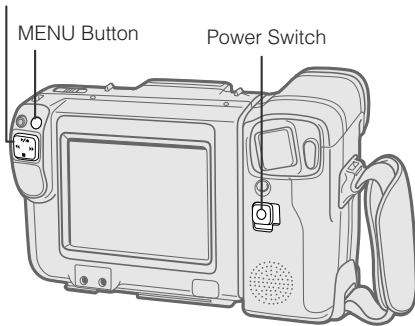

- 4 Press **▶▶** on the **⏮** button to select PAGE **4**.

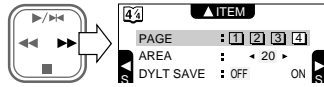

- 5 Press **■** on the **⏮** button to select "AREA".

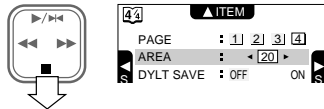

- 6 Press **◀◀** or **▶▶** on the **⏮** button until "17" (Los Angeles) appears. The camcorder is now set to the L.A. time. Press the MENU button to turn off the menu.

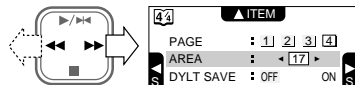

Changing the Area of the Time Zone

Example:

Changing the area from New York to Los Angeles.

- 1 Hold down the Lock button and slide the Power switch to CAMERA.

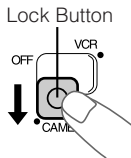

- 2 Press the MENU button until **4 4** appears on the monitor.

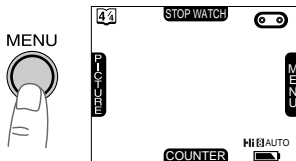

- 3 Press **▶▶** on the operation button (**⏮**) to select "MENU".

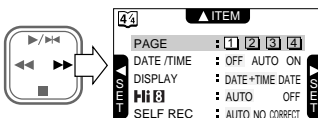

Blank Area Setting

If you do not want to set the area (time zone), you can leave the setting blank. In step 6 above, press **◀◀** or **▶▶** on the **⏮** button until the area setting is blank (after "24").

To Turn Off the MENU-PAGE Display

Press the MENU button.

To Display Area, Date and Time on the Monitor

1 Refer to page 14 to display MENU-PAGE 1.

2 Press **■** on the operation button () to select "DATE/TIME".
Operation button

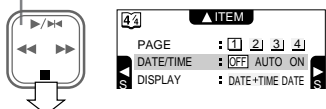

3 Press **◀** or **▶** on the  button to select "AUTO" or "ON".

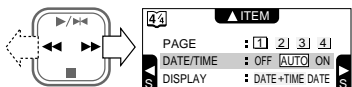

4 Press the MENU button to turn off the menu display. The area, date and time will be displayed on the monitor.



Notes:

- When "AUTO" is selected, the date/time is displayed for 10 seconds at the beginning of the first recording of each day. When "ON" is selected, the date/time is continuously displayed along with the subject.
- During recording and playback, the position of the date/time displayed on the LCD may differ, however, this does not indicate a malfunction.

Setting Daylight Saving Time

1 Refer to page 14 to display MENU-PAGE 1. Press **▶▶** on the operation button () to select MENU-PAGE 4.

Operation Button



2 Press **■** on the  button to select "DYLT SAVE".

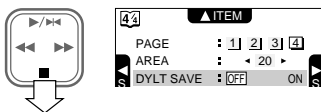

3 Press **▶▶** on the  button to select "ON". The time automatically changes to daylight saving time.



4 Press the MENU button to turn off the menu display. The "☀" mark will be displayed to the left of the area indicator. To reset to standard time, set the "DYLT SAVE" menu item to "OFF".



Time Zone Chart

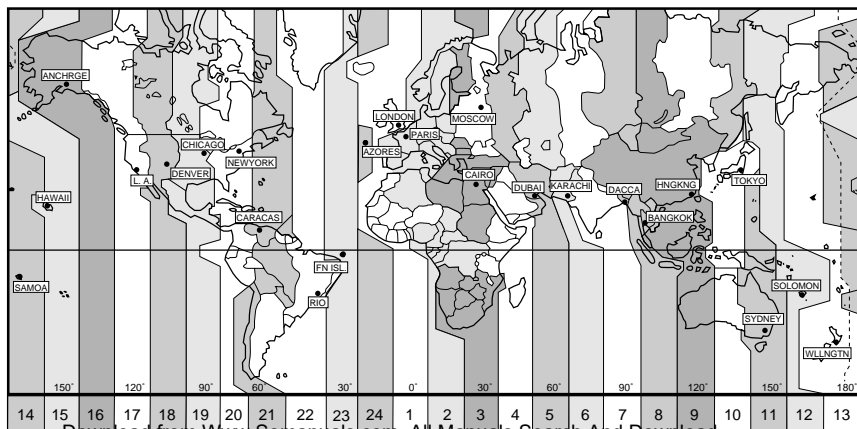

Area Number

First-Time Operation

Area Table

Area Number	Area Name	Countries or Areas*
1	LONDON	England, Morocco, GMT (Greenwich mean time)
2	PARIS	Austria, France, Germany, Italy, Netherlands, Spain, Sweden, Switzerland, Portugal, CST (Continental Standard Time), Tunisia
3	CAIRO	Egypt, Finland, Greece, Turkey
4	MOSCOW	Ethiopia, Iraq, Kenya, Mauritius, Saudi Arabia, Seychelles, Russia (Moscow)
5	DUBAI	United Arab Emirates
6	KARACHI	Maldives, Pakistan
7	DACCA	Bangladesh, India, Myanmar
8	BANGKOK	Cambodia, Indonesia (Jakarta), Thailand, Vietnam
9	HNGKNG	Australia (Perth), China, Hong Kong, Indonesia (Borneo, Bali), Malaysia, Philippines, Singapore, Taiwan
10	TOKYO	Japan, Korea
11	SYDNEY	Australia (Sydney)
12	SOLOMON	New Caledonia
13	WLLNGTN	Fiji, New Zealand
14	SAMOA	Western Samoa
15	HAWAII	Hawaii Is., Tahiti, HST (Hawaii Standard Time)
16	ANCHRGE	U.S.A. (Alaska), AST (Alaska Standard Time)
17	L.A.	U.S.A. (Los Angeles, San Francisco), PST (Pacific Standard Time)
18	DENVER	U.S.A. (Denver), MST (Mountain Standard Time)
19	CHICAGO	Mexico, U.S.A. (Chicago), CST (Central Standard Time)
20	NEWYORK	Canada (Montreal), Jamaica, Peru, U.S.A. (New York, Washington D.C.), EST (Eastern Standard Time)
21	CARACAS	Chile, Dominica, Venezuela
22	RIO	Argentina, Brazil, Uruguay
23	FN ISL.	Fernando de Noronha
24	AZORES	Azores Islands

* These are common names. The formal may be different.

Picture/Backlight Adjustments 5

Operation Button

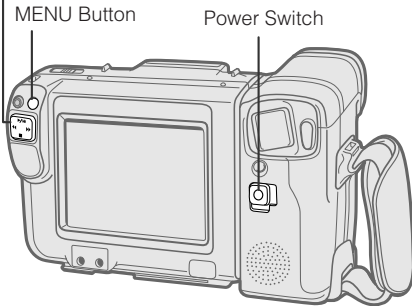

Press ◀ or ▶ on the button to adjust the picture or backlight to your preference.

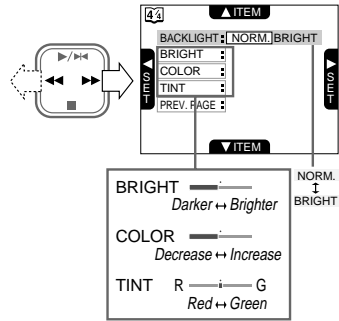

If the picture is difficult to see due to ambient lighting, etc., adjust the monitor picture.

- 1 Set the Power switch to CAMERA.

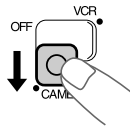

- 2 Press the MENU button until appears on the monitor.

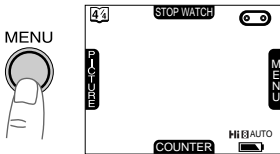

- 3 Press ◀ on the operation button () to select "PICTURE".

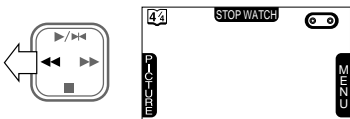

- 4 Press or on the button to select the menu item you wish to adjust.

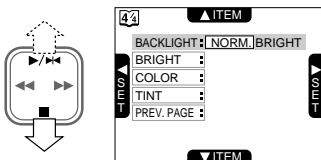

- 6 When you are finished, press the MENU button to turn off the adjustment display.

When the Camcorder is in VCR Mode

Press the MENU button until appears on the monitor. Then perform steps 3 through 6 as shown.

Notes:

- In bright daylight, the monitor picture will be easier to see if you set the backlight ("BACKLIGHT") to "BRIGHT".
- The picture adjustments have been factory preset to neutral settings, and the backlight mode ("BACKLIGHT") has been factory preset to normal ("NORM").
- When the color or tint is adjusted, the picture on the screen may differ from the picture actually recorded. Do not change the color and tint settings unless it is necessary.

Using the Hand Strap

Fitting the Strap to Your Hand

Hold the camcorder against your chest, and pull the strap down until the velcro patches open. Then put your thumb close to the Power Zoom buttons, pull the strap tight until it fits snugly, and seal the velcro closures.

Caution:

- Do not swing the camcorder by its hand strap.

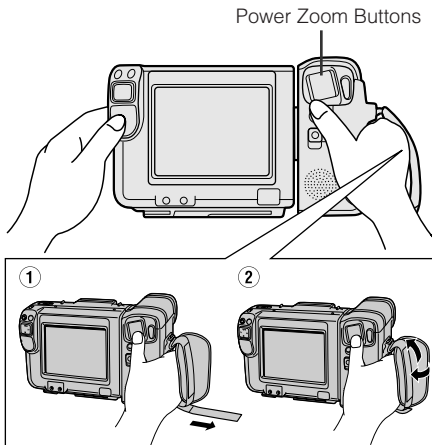

Attaching the Shoulder Strap

- 1 Hold one end of the strap and thread it through the loop on the left side of the monitor.
- 2 Thread the end of the strap through the long slider and move the long slider in the direction of the arrow to secure.
- 3 Loosen the strap in the buckle, and then feed the end of the strap through, as shown.
- 4 Draw the strap in the direction of the arrow (①), and then secure the end of the strap with the short slider (②).
- 5-8 Use the same procedure to attach the other end of the strap.

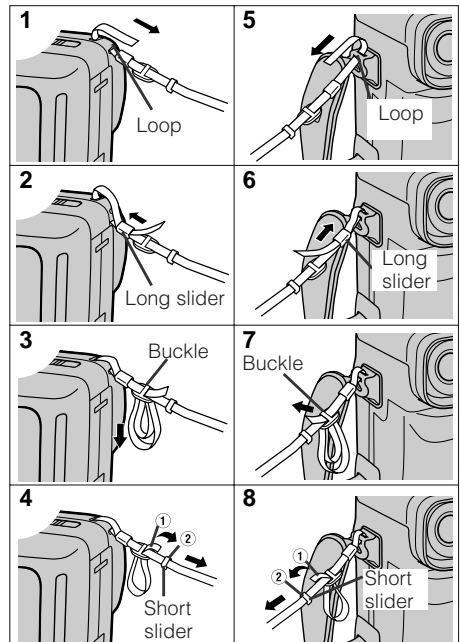

Handling the LCD Monitor

- Do not let anything press against the monitor screen or expose the screen to shock, as it may break.
- Do not put the camcorder on a table, or any other surface, with the monitor screen facing down.
- Use a soft clean cloth to clean the screen.

Basic Operations Camera Recording

- Refer to pages 13-15 on how to operate the monitor display.

Unlike conventional camcorders, this model frees you from having to peer into a small viewfinder. You can watch the subject on the large LCD monitor screen for easier, more enjoyable video-shooting.

Easy Camera Recording with Full Auto

Before you start recording, perform the operations described on pages 6 through 22 to prepare your camcorder for recording.

- 1 Hold down the lock button and slide the Power switch to CAMERA.

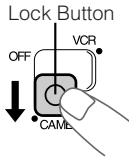

- 2 Press the MENU button until any of [14], [24], [34] or [44] appears on the monitor.
 - The picture from the lens is now displayed on the LCD monitor. Operation indicator

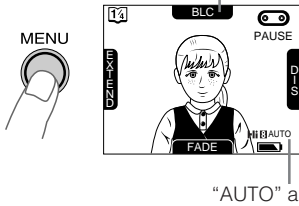

- 3 Press the REC START/STOP button to start recording.

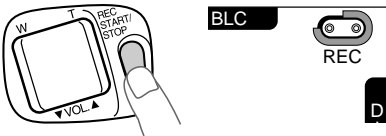

Note:

- When you set the Power switch to CAMERA, it may take some time until the screen appears. Wait until the screen appears before starting operation.

To Pause Recording

Press the REC START/STOP button again. Recording pauses, and the camcorder enters Recording Standby mode.

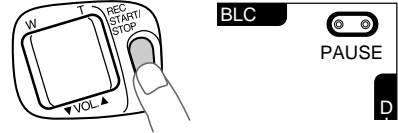

To turn the Power switch to OFF, slide the switch to OFF without pressing the Lock button.



Notes:

- To leave Camera Recording mode, set the Power switch to OFF.
- During Camera Recording mode, the speaker is off, and the PHONES (earphones) jack below the monitor cannot be used.
- If the camcorder is kept in Recording Standby mode for more than approximately 5 minutes, the power will automatically turn off to save battery power and to protect the tape from being damaged. To continue recording after this, set the Power switch to OFF, and then back to CAMERA again.
- If you will not be recording again for a while, turn off the power by sliding the Power switch to OFF. This will make the battery last longer.
- The operation indicators can be turned off or back on again with the MODE DISPLAY button.

Maximum Time for Continuous Camera Recording

Battery Pack	Max. Camera Recording Time
BB75	Approx. 65 min.

Note:

- The use of the zoom and other functions will accelerate power consumption. The actual recording time per battery pack may be 30%–50% less than the maximum camera recording time shown above.

Camera Recording

Zooming

Zooming allows you to move visually closer to or farther from a subject without physically changing your position.

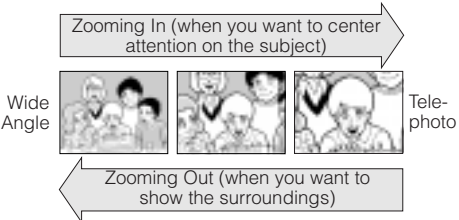

To Zoom In

Press the Power Zoom T (telephoto) button to get a close-up view (1).

To Zoom Out

Press the Power Zoom W (wide angle) button to get a wide field of view (2).

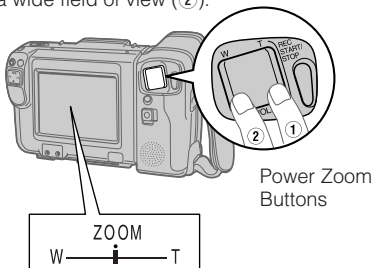

- The zoom speed changes depending on the degree of pressure placed on the Power Zoom buttons.
- The on-screen display will show you the current zoom setting.

Notes:

- The camcorder is unable to focus when zooming in on subjects within 5 feet (1.5 m). The camcorder will automatically zoom out until it focuses on the subject.
- Frequent zooming produces unattractive pictures. It also increases battery power consumption.

Setting the Digital Zoom

You can select between two zoom ranges: normal = 1–12× (optical) or digital = 1–12× (optical) plus 12–30× (digital). The digital option adds the 12–30× digital range to the normal zoom, allowing you to record powerful close-up pictures using the same zoom features as normal zoom. The zoom option is factory preset to 1–12× optical zoom. In the 12–30× zoom range, the picture quality may suffer slightly.

- 1 Press the MENU button until 4/4 appears on the monitor (Camera mode).

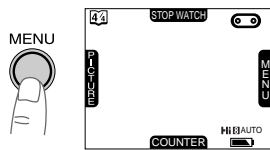

- 2 Press \blacktriangleright on the operation button (2) to select "MENU".



- 3 Press \blacktriangleright on the \square button to select MENU-PAGE 2 then press \blacksquare on the \square button to select "DGTL ZOOM".

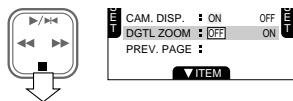
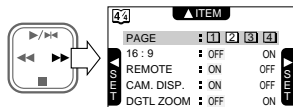

- 4 Press \blacktriangleright on the \square button to select "ON".

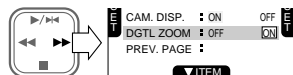

- 5 The digital zoom is now on. Press the MENU button to turn off the menu.

To return to normal zoom, set "DGTL ZOOM" to "OFF" in step 4 above.

Note:

- When the digital zoom is used, the picture quality may suffer in the 12–30× range. At maximum zoom, the horizontal resolution decreases by a maximum of 60% of the optical zoom.

Digital Quick Zoom (Extend Zoom)

Use the digital quick zoom function (extend zoom) to instantly zoom in on a subject. This is useful when you want to instantly capture a particular subject.

Setting Digital Quick Zoom Ranges

Refer to page 14 to display MENU-PAGE [3], and then press **■** on the operation button ([]) to select "EXTEND ZOOM".

Press **◀** or **▶** on the [] button to select "1.5 x", "2.0 x", or "2.5 x".

Operation Button

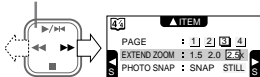

Using Digital Quick Zoom (Extend Zoom)

- 1 Press the MENU button until [3] appears on the monitor (Camera mode).

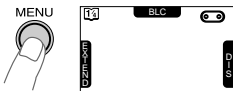

- 2 During recording, press **◀** on the operation button ([]) to select "EXTEND" when you want to instantly zoom in on a subject.

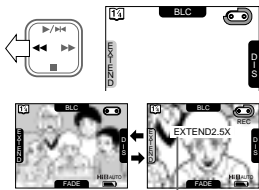

"EXTEND 2.5x" is displayed.

To return to the previous magnification, press **◀** on the [] button to select "EXTEND" again.

Notes:

- When the digital quick zoom is used, the picture quality decreases by a maximum of 60% of the optical zoom.
- When digital zoom is on, EXTEND function does not work in the digital-zoom (12-30x) range. (EXTEND becomes disabled and appears dimmed.)
- If the optical zoom is at 12X when you turn the "EXTEND ZOOM" to "ON", 1.5x becomes 18x, 2.0x becomes 24x, and 2.5x becomes 30x.

Auto Focus

The auto focus feature is designed to focus on most types of subjects. In Auto Focus mode, the camcorder automatically focuses on whatever is in the center of the scene. Always keep the subject in the center of the screen. The auto focus may not be able to focus on the subject in the situations shown in the chart. In such situations, set the camcorder to Manual Focus mode and focus manually (see page 43).

 Subject is too dark.	 Lack of contrast, e.g. snow scene.
 Fast-moving subject.	 Background is too bright.
 Subject has vertical or horizontal stripes.	 Subject is being shot through a dirty or wet window.
 Light reflects off the subject.	 Two subjects at different distances overlap in the same scene.
 Subject has fine, repeated patterns.	 Subjects at different distances appear in the center of the scene at the same time.
 High-speed shutter being used under fluorescent lighting.	

Notes:

- If no subject is in the center of the monitor, the focus area will expand and the subject nearest the center will be focused on.
- If no subject is displayed on the monitor, the camcorder will automatically zoom out until some subject comes into the frame.
- If the image being recorded is not sharp, the auto focus may not function and the image will be blurred. If this occurs, press the Power Zoom W button to zoom out, or pan the camcorder to shoot some other subject. The auto focus will resume operation.

Backlight Compensation (BLC)

When the subject is backlit, the image will be darkened if it is recorded normally. Use the backlight compensation (BLC) feature to improve the picture.

- 1 Press the MENU button until appears on the monitor (Camera mode).

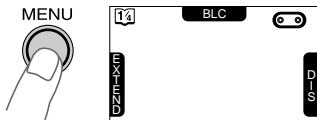

Note:

- At locations where lighting is insufficient, "LIGHT" appears on the monitor. "GAIN-UP" appears indicating the BLC function cannot be used.

- 2 Press on the operation button () to select "BLC". The backlight compensation indicator "" appears on the monitor, indicating that the BLC function is now working.

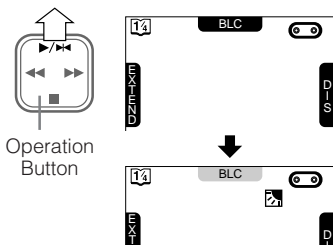

To turn off the BLC function, press on the button to select "BLC" again. The "" indicator goes off.

Gain-up (Cat's Eye)

When you are recording in a dark or poorly illuminated location, "LIGHT" (warning of too little ambient illumination) is displayed on the monitor. Use the gain-up feature to record a brighter picture.

- 1 Press the MENU button until appears on the monitor (Camera mode).

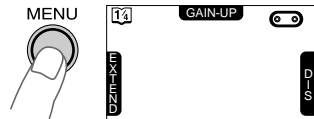

Note:

- At locations where lighting is adequate, the "LIGHT" indicator will not appear. "BLC" instead of "GAIN-UP" appears indicating the gain-up function cannot be used.

- 2 Press on the operation button () to select "GAIN-UP". The "LIGHT" display changes to the gain-up (cat's eye) display "", indicating that the gain-up function is now working.

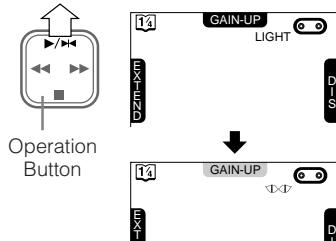

To turn off the gain-up function, press on the button to select "GAIN-UP" again. The "" display changes to the "LIGHT" display.

Notes:

- If the camcorder is moved to a bright location after it is engaged in Gain-up mode, the Gain-up mode will disengage automatically.
- There is more picture noise in Gain-up mode.

Digital Image Stabilization (DIS)

The DIS function lets you stabilize the image by electronically canceling relatively small image shakes that are often annoying in close-up shots.

- 1 Press the MENU button until appears on the monitor (Camera mode).
- 2 Press on the operation button () to select "DIS". The indicator appears on the monitor, and the camcorder enters DIS mode.

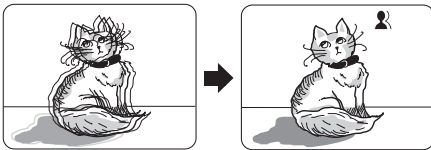
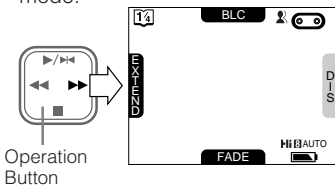

To return to normal recording mode, press on the button to select "DIS" again. The indicator will disappear.

Notes:

- While this function is in progress, the image on the monitor is slightly magnified, and the shutter speed is automatically switched from the standard speed (1/60 sec.) to 1/100 sec.
- Image resolution slightly decreases in DIS mode.
- Under the light of fluorescent lamps, the picture may brighten and dim.
- The DIS feature does not work during Still Recording mode.
- Battery consumption is larger in DIS mode. We recommend that you not use the DIS feature when using the camcorder on a tripod.

Caution:

- The DIS function cannot compensate for excessive image shake, or for the subjects or situations described below.
 - Subject with low contrast*
 - Subject with a plain background*
 - Dark or dimly lit subject*
 - Subject with vertical or horizontal stripes
 - Many moving subjects in a single frame
 - A shutter speed other than 1/100 sec. is used under the light of fluorescent lamps. (*The indicator blinks during these conditions.)

Macro Shots

This camcorder lets you shoot close-up images of small objects such as flowers and insects, or make title frames for your videos. When you want to record a magnified image of a subject which is within approximately 5 feet (1.5 m) of the camcorder, do not zoom in on the subject. Instead, zoom out all the way by holding down the Power Zoom W button, and then move the camcorder closer to the subject until you obtain the desired angle of view. The camcorder will automatically focus on the subject when the lens is set for the widest angle.

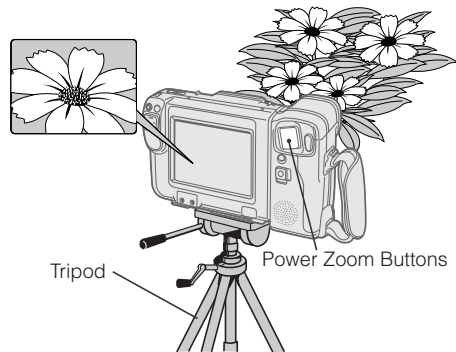

Notes:

- When you are recording a macro shot, be sure that the subject receives sufficient illumination.
- It is recommended that you use a tripod for recording macro shots to prevent image shake.

Camera Recording

Fade In and Fade Out

With the fade function, it is possible to fade in or out of scenes smoothly. It is effective especially for indicating a dramatic change in scenery.

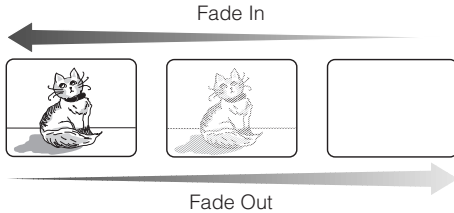

Fade In

- 1 Press the MENU button until **14** appears on the monitor (Camera mode).

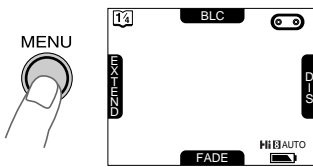

- 2 Press **■** on the operation button (**⏮**) to select "FADE".

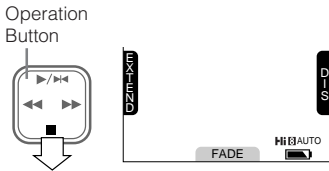

- 3 Press the REC START/STOP button. "FADE" changes to "FADE IN", and after the screen turns white, recording begins and the picture and sound fade into the monitor screen.

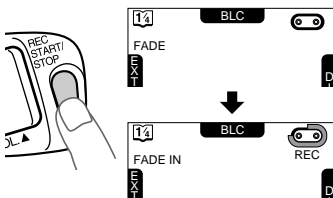

Fade Out

- 1 Press the MENU button until **14** appears on the monitor (Camera mode).

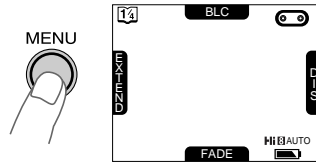

- 2 Press the REC START/STOP button to start recording.

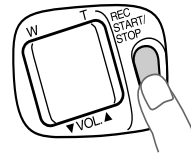

- 3 Press **■** on the operation button (**⏮**) to select "FADE".

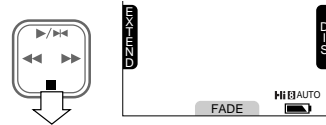

- 4 Press the REC START/STOP button at the point where you wish to stop recording. "FADE" changes to "FADE OUT", and the picture and sound fade out as the screen gradually turns white. The camcorder then returns to Recording Standby mode.

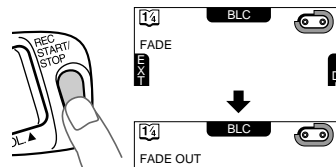

Recording with the Wide Screen (16:9)

This feature lets you record scenes with the wide-screen feel of a movie shown in a theater. The top and the bottom of the picture are masked with black bands to produce an effective screen aspect ratio of 16:9.

Setting the Wide Screen Mode

1 Press the MENU button until **44** appears on the monitor (Camera mode).

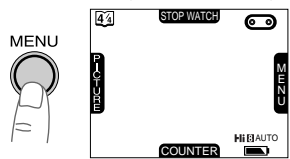

2 Press **▶▶** on the operation button (**44**) to select "MENU".

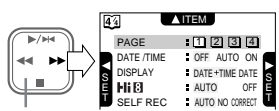

Operation Button

3 Press **▶▶◀◀** on the **44** button to select "PAGE". Press **▶▶** on the **44** button to select MENU-PAGE **2** and then press **■** on the **44** button to select "16:9".

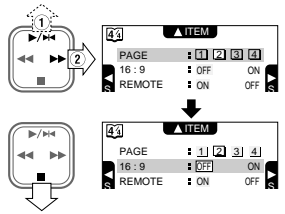

4 Press **▶▶** on the **44** button to select "ON". Then, press the MENU button to remove the menu.

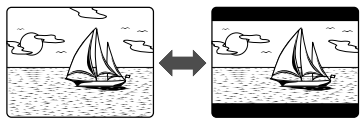
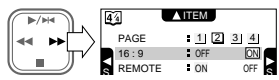

Normal Screen Mode Wide Screen Mode

5 To return to the normal picture, press **◀◀** on the **44** button to select "OFF" in step 4.

Notes:

- The masked portion of the screen will appear green when recording; however, during playback it will be black.
- When using the fade function (see page 28) in the Wide Screen mode, only the unmasked portion of the screen will fade in or out.
- You can only use the Wide Screen mode when the camcorder is in Camera mode.

To Cancel Automatic Display of the **14** Screen in Camera Mode

Normally, when the power is turned on in Camera mode, the **14** screen with the indicators such as "BLC" and "EXTEND" is automatically displayed on the monitor.

If you do not want these indicators to be automatically displayed, follow the procedure below.

1 Press the MENU button until **44** appears on the monitor.

2 Press **▶▶** on the **44** button to select "MENU".

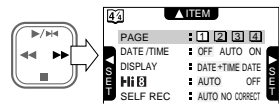

3 Press **▶▶** on the **44** button to select MENU-PAGE **2** and then press **■** on the **44** button to select "CAM. DISP.".

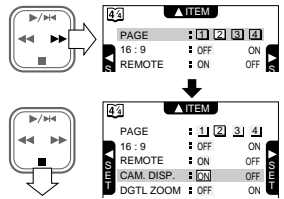

4 Press **▶▶** on the **44** button to select "OFF". Then, press the MENU button to remove the menu. Turn camera off, then on again. Indicators will not appear.

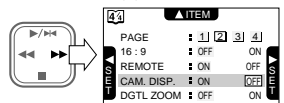

Notes:

- You can cancel the automatic display of **14** screen in VCR mode by setting "VCR DISP." to "OFF" on the VCR menu screen.
- If you want the indicators to be displayed, press the MODE DISPLAY button.

Camera Recording

Quick Return

When you have been playing back what you have recorded, and wish to quickly return to recording again from the end of the last recorded scene, use the quick return function.

- 1 Set the Power switch to CAMERA.

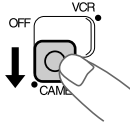

- 2 Press the MENU button until 2/4 appears on the monitor.

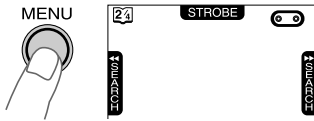

- 3 Press \blacksquare on the operation button () to select "RETURN". The tape will begin winding or rewinding to the end of the last recorded scene.

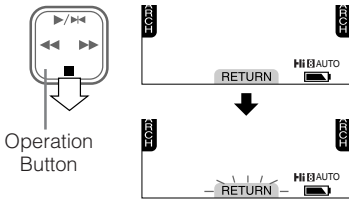

- To cancel, press \blacksquare on the  button to select "RETURN" again.

- 4 When the tape reaches the end of the last recorded scene, the camcorder enters Recording Standby mode.

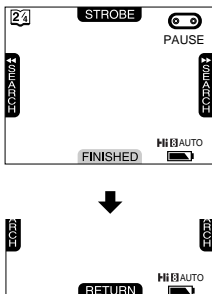

Note:

- If the cassette has been removed since the last recording or if no recording has been made since the cassette was loaded, the "RETURN" indicator will be faintly displayed and the quick return function will not operate.

Edit Search

The edit search feature lets you search, without switching from Camera Recording mode to VCR mode, for the point on the tape where you wish to start recording next.

- 1 In Recording Standby mode, make sure that no operation indicators are displayed on the monitor.

- If they are displayed on the monitor, turn them off by pressing the MODE DISPLAY button.

- 2 Press the MENU button until 2/4 appears on the monitor.

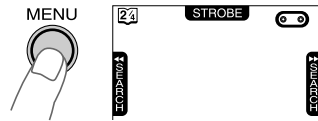

- 3 Press \lll for reverse edit search or \ggg for forward edit search on the  button.

- 4 When you find the point where you want to begin recording, release the button.

Notes:

- Some picture noise appears during reverse edit search.
- Forward edit search is performed at the same speed as normal playback, and reverse edit search is performed at three times the normal playback speed.
- The sound is off during edit search.

Tips on Recording Positions

The rotating LCD monitor screen lets you enjoy easy video recording in relaxed postures.

- You can record using more natural body postures since you can see the subject on-screen, without having to hold the camcorder against your eye.
- The LCD monitor also makes high-angle and low-angle shots easy.
- In hand-held recording, the camcorder has to be steadied to prevent image shake.
- Use a tripod for very stable recording.

Basic Recording Positions

Put the fingers of your right hand through the hand strap, and place your right thumb close to the REC START/STOP and Power Zoom buttons. Place your left thumb in the indentation on the left side of the LCD monitor.

Basic Posture

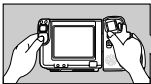

Look at the monitor with both eyes.

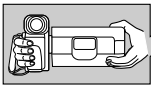

Press your elbows against your sides.

Place your feet at a 45° angle and take a firm stance.

Kneeling

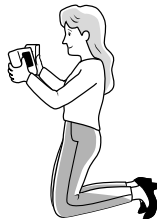

When kneeling, put one knee on the ground for the best stability.

High Angle



You can record and still see the monitor screen. This is convenient when you want to record over a crowd.

Low Angle



Prone



Rest on both elbows to stabilize the camcorder.

Notes:

- Take care not to touch the monitor screen with your fingers, as perspiration and dirt will smudge it.
- Unless you intend to create a special effect, keep the camcorder level with the horizontal plane.
- Take care not to touch the microphone with your fingers when the camcorder is recording. It will cause noise on the audio track.

Hints for Better Shooting

- Position the subject in the center of the screen. When you are using auto focus, whatever is in the center of the screen is kept in focus.



Position the subject in the center.



Focus manually when you need to position the subject off center (see page 43).

- Avoid backlit subjects. For the best picture, have the light source behind you. When the background is brighter than the subject, the subject often becomes too dark. If you need to record with this lighting, correct the gain or iris to improve the picture (see pages 26 and 47).

Light from Behind

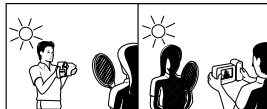

Back-lighting

- Before zooming, think about how to best frame the shot. Stop zooming when the shot is well framed.
- When image shake is noticeable during zoomed-in telephoto shooting, use a tripod, or press the Power Zoom W (wide angle) button to zoom out. Screw the tripod into the tripod socket on the bottom of the camcorder.
- Horizontal panning (lateral movement) and tilting (vertical movement) should be done slowly to emphasize the wide expanse of a scene or the height of a building, and to make them easy to watch on playback.
- Use wide-angle settings for fast-moving subjects.

Note:

- It may take longer to focus when zooming and panning are used frequently.

Setting the Camcorder to Full Auto Mode

This camcorder is equipped with auto focus, auto white balance, auto exposure, and auto shutter speed functions. Setting the camcorder to Full Auto mode lets you record high-quality pictures easily.

When "AUTO" is not displayed on the monitor the camcorder is not in Full Auto mode. Perform the procedure below to set the camcorder to Full Auto mode.

- 1 While the camcorder is in Camera mode, press the MENU button until **34** appears.
- 2 Press **▶/◀** on the operation button (**35**) to select "MANUAL".

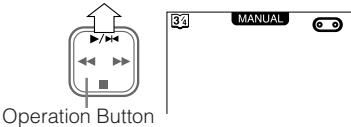

Note:

- If the camcorder is in manual focus mode ("FOCUS" selected on **34** screen), press **■** on the **35** button to return to Auto Focus mode (see page 43).

- 3 Select "CAMERA MODE" and then press **◀** on the **35** button to select "AUTO".



- 4 Press the MENU button until **14** appears. During normal operation, use the **14** screen for the Full Auto mode. "AUTO" appears on the monitor.

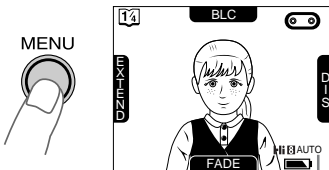

"AUTO" appears.

Recording the Date and Time

Follow the procedure shown in the next column to record the date and time – or the date only – along with the subject.

- 1 Refer to page 14 to display MENU-PAGE **14**. Press **■** on the operation button (**35**) to select "DATE/TIME".

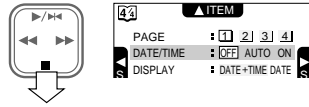

- 2 Press **◀** or **▶** on the **35** button to select "AUTO", "ON" or "OFF".

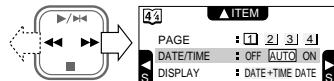

When "ON" is selected, the date/time is continuously displayed and recorded along with the subject.

When "AUTO" is selected, the date/time is displayed and recorded for 10 seconds at the beginning of the first recording of each day.

When "OFF" is selected, the date/time is neither displayed nor recorded.

Note:

- Select "AUTO" if continuous date/time display annoys you during recording or playback.

- 3 Press **■** on the **35** button to select "DISPLAY".

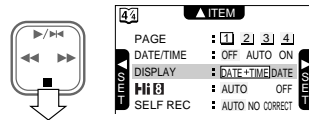

- 4 Press **◀** or **▶** on the **35** button to select "DATE+ TIME" or "DATE".

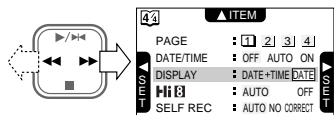

When "DATE+TIME" is selected, both the date and the time are displayed and recorded.

When "DATE" is selected, only the date is displayed and recorded.

- 5 Press the MENU button to turn off the menu display.

Note:

- When "AUTO" is selected in step 2, the date/time is not displayed and recorded even if the date changes during recording.

Remaining Recording Time Display

When the camcorder is recording in Camera mode, an on-screen indicator will begin to show how much time you have left as shown below. You might want to get a new tape ready at this time. To turn off the remaining recording time display, press the MODE DISPLAY button.

Notes:

MODE DISPLAY Button

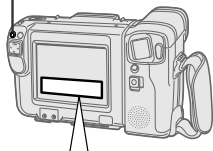

Approx. Remaining Recording Time	Monitor Display
This icon will appear when less than half the tape is remaining.	
10 min.–8 min.	
8 min.–6 min.	
6 min.–4 min.	
4 min.–2 min.	
2 min.–1 min.	
1 min.–0 min.	<p>THE TAPE ENDS SOON.</p> <p>↓ (after 3 sec.)</p>
0 min. (The tape has reached its end.)	<p>CHANGE THE CASSETTE.</p> <p>↓ (after 3 sec.)</p> <p>TAPE END</p>

- The time-remaining indicators only show approximate time left. Also, they vary slightly depending on the length of tape used. (This function's design is based on the P6-120 tape standard.)
- If the MODE DISPLAY button is pressed to turn off the remaining recording time display, this display will reappear after a short interval to indicate the new time remaining.
- The time-remaining indicators above appear after 5 seconds from the time you press the REC START/STOP button to start recording.

Remaining Battery Power Display

When you turn on the camcorder, the remaining battery power display automatically appears on the monitor. By pressing the MODE DISPLAY button, you can turn the display on and off. The remaining power is displayed in five levels, as shown.

If the battery power is very low, a warning message will appear. Replace the battery pack.

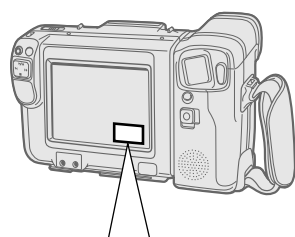

Monitor Display

(Green)
 (Green)
 (Green)
 (Yellow)
 (Red)

}

5-Level Display

BATTERY IS TOO LOW.

↓

Notes:

- Use the remaining battery power display only as an indication.
- Battery consumption may vary depending on the condition of use.
- The battery power display may change to either a higher or lower level if you set the Power switch to OFF and then back to CAMERA or VCR again.
- Use of the zoom functions when the warning message "BATTERY IS TOO LOW." is displayed may cause the camcorder to suddenly lose power. Replace the battery pack.
- Remaining battery power display will not be displayed when using a DC cable or Docking station.

Basic Operations

Playback

- Refer to pages 13-15 on how to operate the monitor display.

Playback



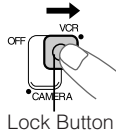

The LCD monitor makes it possible to play back and see what you have just recorded. Nothing needs to be connected, allowing instant on-screen playback. You can hear the sound through the built-in speaker or via your own stereo earphones. You can also watch prerecorded 8 mm video tapes on this camcorder.

- 1 Hold down the Lock button and slide the Power switch to VCR. It may take some time for the screen to appear. Wait until the screen appears before starting operation.

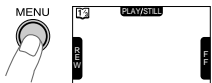

- 2 Press the MENU button until  appears on the monitor.



- 3 If the tape is not at the desired point, press  or  on the operation button () to select "FF" () or "REW" ().

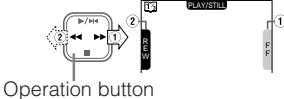

- 4 Press  on the  button to select "PLAY".

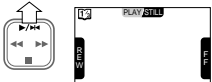

To Stop Playback

Press  on the  button to select "STOP".

Auto Tape Rewind

The tape is automatically rewound when playback reaches the end of the tape.

Notes:

- If you wish to turn off the operation indicators on the monitor (e.g. because they interfere with your view of the picture), press the MODE DISPLAY button. The buttons will still function as indicated even after their indicators are turned off.
- Stereo earphones with a 3.5 mm diameter plug can be plugged directly into the PHONES jack below the monitor. When you use this jack, the speaker automatically turns off.





PHONE Jack

Caution:

- To use the infrared remote control, make sure that the remote control menu item ("REMOTE") is set to "ON". The remote control cannot be used to operate the camcorder when this menu item is set to "OFF". See page 39.

Volume Control

While the camcorder is in the VCR mode, press the VOL.  or  button to increase or decrease the volume to your preference.



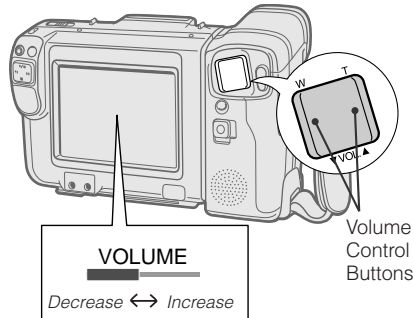

The volume control indicator will appear on the monitor. After adjusting the volume, if the Volume control buttons are not pressed, the indicator will disappear by itself shortly.







Note:

- The volume can also be adjusted with the remote control.

Fast Forward and Rewind

Press  or  on the  button to select "FF" (Fast Forward) or "REW" (Rewind) on the  screen (VCR mode) during a stop mode.

Searching for and Playing Back a Scene Far from the Current Tape Position

When fast forwarding (or rewinding) a tape, press  on the  button to select "FF" (or  to select "REW") on the  screen (VCR mode). The fast forward (or reverse) playback picture is displayed on-screen. Release the button to return to normal fast forward (or reverse) mode.

Using the Stand

Pull out the stand and lock it into position when you put the camcorder on a table or other flat surface.

Cautions:

- Protect the stand from strong forces. Otherwise it may break.
- To retract the stand, press it in the direction of the arrow.

Pulling the Stand Out

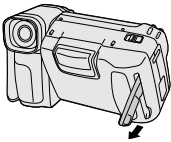

Retracting the Stand

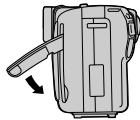

Placing



To stabilize the camcorder, make sure the camera module stands vertically.

Video Search

This function makes it easy for you to search for a scene near the current tape position.

- 1 During playback, press **▶▶** on the operation button (▶▶) to select "FF" (①) (or **◀◀** to select "REW" (②)) on the **[1/2]** screen (VCR mode). The fast forward (or reverse) playback picture is displayed on-screen.

Operation Button

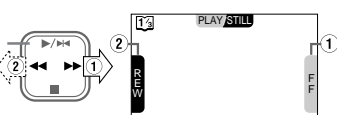

- 2 When you find the desired scene, press the **▶▶** on the **[▶▶]** button to select "PLAY" to return to normal playback.

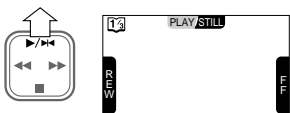

Notes:

- The sound is off during these searches.
- Some picture noise appears during these searches. This is not a malfunction.

Still

This function makes it possible to freeze the picture. During playback, press **▶▶** on the **[▶▶]** button to select "STILL" on the **[1/2]** screen (VCR mode). To return to normal playback, press **▶▶** on the **[▶▶]** button to select "STILL" once again.

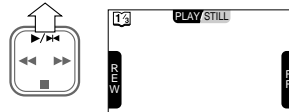

- Still image playback can also be operated with the remote control. (See page 39.)

Slow

This function makes it possible to play back in slow motion. During playback, press the SLOW button (**▶**) on the remote control. To return to normal playback, press PLAY button on the remote control to select "PLAY".

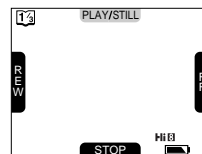
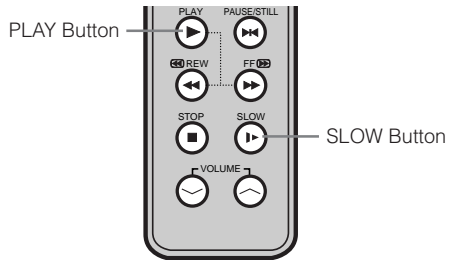

Notes:

- The sound is off during Still and Slow modes.
- To protect the tape, the camcorder automatically returns to ordinary playback mode if it is left in Still mode for more than 5 minutes or in Slow mode for more than about 40 seconds.
- If still or slow functions are used when connected to a TV, noise will appear and distort the image.
- Slow function cannot be operated from the camcorder.

Program Search

The program search feature automatically finds the beginning of a number of previously recorded scenes. Up to 10 different scenes can be found on one tape.

- 1 Set the Power switch to VCR.

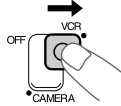

- 2 Press the MENU button until 2/3 screen appears on the monitor.

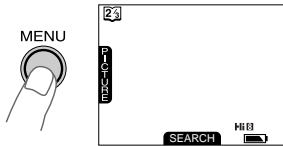

- 3 Press ■ on the operation button (⏮) to select "SEARCH". The camcorder enters the Program Search mode. Both the "REW" and "FF" indicators, or one of them will start flashing. To cancel, press ■ on the ⏮ button to select SEARCH again.

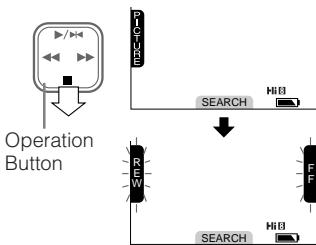

- 4 Press ⏪ on the ⏮ button to select REW (or ⏩ to select FF) button. "SEARCH" will start flashing. The tape rewinds (or fast forwards) to the beginning of a scene immediately before (or after) the current tape position; playback then starts automatically. The "REW" and "FF" indicators automatically disappear after about 10 seconds.

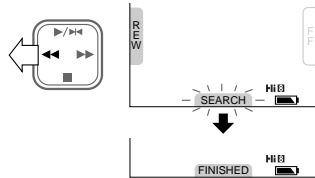

- 5 To continue searching, press ⏪ on the ⏮ button to select REW (or ⏩ to select FF) while its indicator is displayed.

Notes:

- Use this feature when the tape is stopped or being played back.
- This function finds the beginning of the scene immediately before or after the current tape position, stopping at every scene. It is not possible to skip a scene.
- This function cannot spot recordings that are shorter than 10 seconds in length.
- In steps 3 and 5, if the tape is at a point ahead of the most recent recording, only the "REW" indicator will flash, and the "FF" indicator will not appear.
- In steps 3 and 5, if the tape is at a point before the oldest recording, only the "FF" indicator will flash, and the "REW" indicator will not appear.
- This feature does not function if no recording has been made since the cassette was loaded, or if the cassette has been removed after the recordings were made. "SEARCH" is faintly displayed in this case.

Example: To find the beginning of five different scenes:

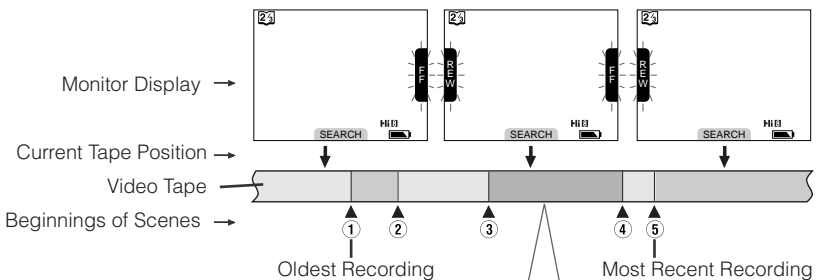

When you are at this position:
 Press ⏪ on the ⏮ button to select "REW" to rewind the tape to ③ and begin playback.
 Press ⏩ on the ⏮ button to select "FF" to forward the tape to ④ and begin playback.

Using the Tape Counter

Use the tape counter feature when you want to know the recording or playback time.

- 1 Press the MENU button until **3/3** (VCR mode) or **4/4** (Camera mode) appears on the monitor.

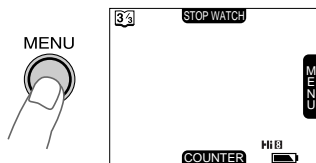

- 2 Press **■** on the operation button (**⏮**) to select "COUNTER". The counter display will appear.

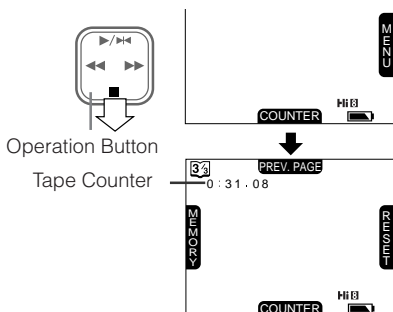

- 3 Begin playback or recording. You can check the recording or playback time on the monitor.

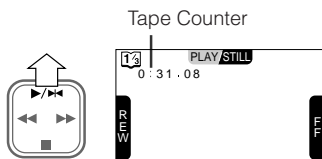

To Turn Off the Counter Display

Press **■** on the **⏮** button again to select "COUNTER" in step 2.

To Reset the Counter to Zero

During playback or recording, perform steps 1 and 2, and then press **▶▶** on the **⏮** button to select "RESET".

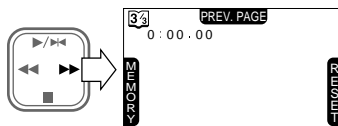

Counter Memory

Use the counter memory when you want to return to the beginning of a particular scene. The position where the counter memory is reset, (0:00.00) is stored in memory to make it easier to return the tape to that point.

- 1 During playback or recording, press the MENU button until **3/3** (VCR mode) or **4/4** (Camera mode) appears on the monitor.

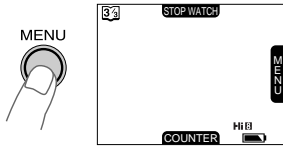

- 2 Press **■** on the button to select "COUNTER" then press **◀** on the button to select "MEMORY". "M" will appear to the left of the counter display.

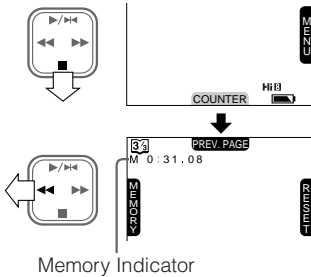

- 3 Press **▶▶** on the button to select "RESET" at the beginning of a scene you want to return to later.

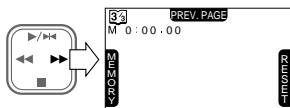

- 4 After playback, press **■** on the button to select "STOP" on the **1/3** screen. If you have been recording, stop the tape and set the Power switch to VCR.

- 5 Press **◀◀** on the button to select "REW" on the **1/3** screen. The tape will automatically stop when the counter reaches 0:00.00.

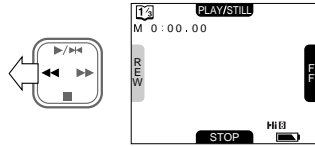

- 6 Press **▶▶** on the button to select "PLAY" on the **1/3** screen to view the desired scene.

To Cancel the Counter Memory Mode

Perform step 1. Then press **■** on the operation button (**■**) to select "COUNTER" and then press **◀** on the button to select "MEMORY". "M" will disappear. The Counter Memory mode is now canceled.

Notes:

- In Step 5, **▶▶** on the button can be used to select "FF" in the same way.
- This function does not work during video searches.
- In step 5, the tape may stop slightly ahead or behind the point where you reset the counter to "M 0:00.00".

Turning Off the LCD Monitor Backlight

This camcorder's LCD monitor uses a fluorescent lamp for backlighting (see page 57). In order to reduce battery consumption, you can turn off the lamp when backlighting is not necessary (e.g. when you are watching a playback on a connected TV's screen).

While the camcorder is in Camera or VCR mode, hold down the MODE DISPLAY button for more than 5 seconds. The backlight will turn off and the LAMP OFF indicator will light.

To turn it on again, press the MODE DISPLAY button or set the Power switch to OFF, and then back to CAMERA or VCR.

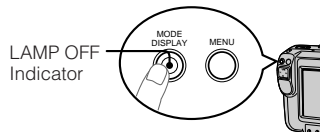

Notes:

- The LAMP OFF indicator will blink when the monitor is off to indicate that there is a warning message. Press the MODE DISPLAY button and check the message on the monitor.
- Turning the LCD monitor on and off repeatedly may deplete battery power.

Using the Infrared Remote Control

Use the remote control to operate the camcorder from a distance, such as when you want to record yourself in a scene, or when the camcorder is connected to a TV for use as a VCR.

- 1 Set the Power switch to CAMERA or VCR.



- 2 Press the MENU button until 4/4 (Camera mode) or 3/3 (VCR mode) appears on the monitor.

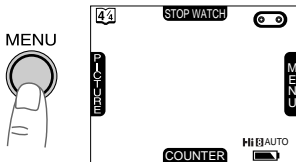

- 3 Press ►► on the operation button (◀▶) to select "MENU".

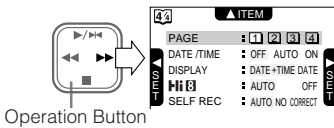

- 4 Press ►► on the button (◀▶) to select MENU-PAGE 2 and then press ■ on the button (◀▶) to select "REMOTE". Make sure the "REMOTE" is set to "ON".

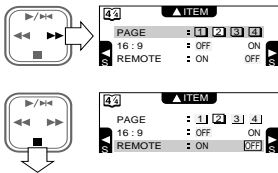

If the "REMOTE" is set to "OFF", press ◀◀ on the button (◀▶) to select "ON".

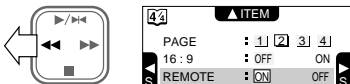

- 5 Aim the remote control at the photoreceptor of the camcorder, and press the control buttons for operation.

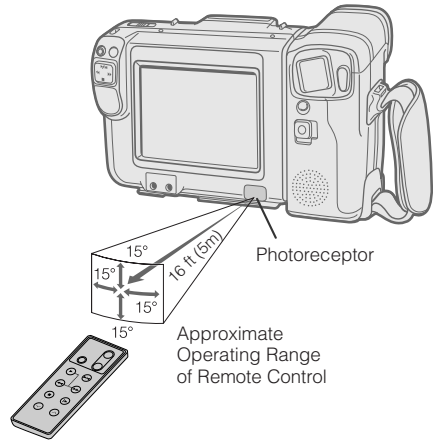

Notes:

- Be careful not to allow direct sunlight or bright light from interior illumination to fall onto the camcorder's photoreceptor, as this may prevent the remote control from operating properly.
- Be sure that there are no obstacles between the remote control and the camcorder's photoreceptor.
- When the "REMOTE" item setting is changed in either Camera or VCR mode, the setting for the other mode is automatically set to the same.
- The lithium cell normally lasts about one year. It can be shorter under some operating conditions. When the lithium cell is dead and the remote control does not operate, replace the cell with a new one by following the instructions on page 6.

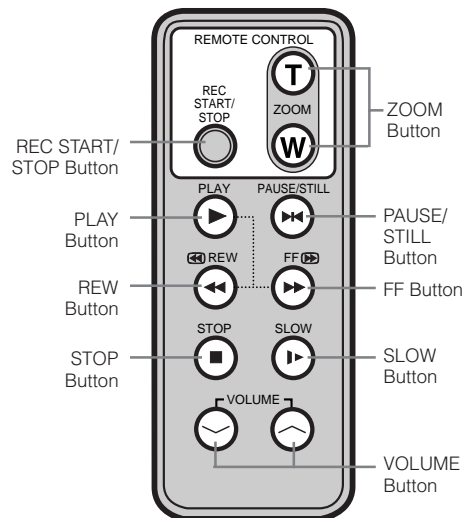

Useful Features for Camera Recording

Self Recording

The LCD monitor can be rotated 180° vertically so that the monitor screen faces the subject. This lets you record yourself while watching yourself on the screen.

Enjoy recording your own portrait by yourself, or recording yourself and your friend together at a party.

Example of Recording in Self Recording Mode



Cautions:

- Do not rotate the monitor to the self recording position while the camcorder is recording or playing back.
- For recording in Self Recording mode, be sure to rotate the monitor, NOT the lens. If you hold the camcorder upside down with its lens at the bottom, the subject will be recorded upside down.

Normal Self Recording

- Rotate the camcorder's monitor section 180° vertically. The camcorder will show a mirror image of the subject. Playback image will not be reversed even though the monitor shows the mirror image during self recording.

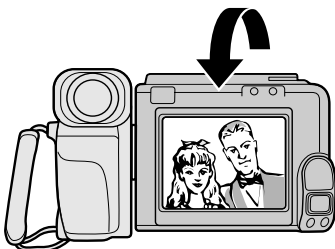

Note:

- If the image on the monitor is upside-down, rotate the monitor (normal position) and display MENU-PAGE 1 (Camera mode), press **■** on the operation button (CAM) to select "SELF REC" and then press **◀▶** on the **◀▶** button to select "AUTO".

Operation Button

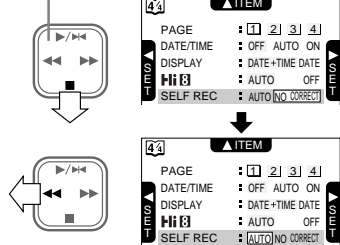

- Press **◀▶** or **▶▶** to select "WIDE" or "TELE".

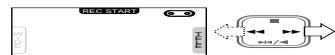

- Press **■** on the **CAM** button to select "REC START".

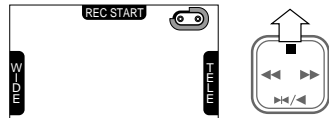

To pause recording, press **■** on the **CAM** button.

Self Recording Message OSD

In Self Recording mode, by following some simple instructions that appear on the monitor screen, you can easily record a short video message for someone. This feature is especially convenient for editing video letters.

- Complete steps 1 and 2 of "Normal Self Recording" on page 40. Then perform the procedure below.

- 1 Press **▶/◀** on the operation button () to select "MESSAGE". The instruction "PRESS REC START FOR LEAVING YOUR MESSAGE." appears on the monitor, and the "REC START" indicator starts flashing.

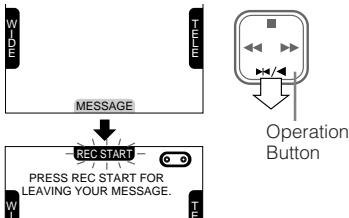

- 2 Press **■** on the  button to select "REC START". Say your message while facing the lens of the camcorder.
 - The recording time is preset for 20 seconds.
 - The remaining number of seconds is displayed in the upper right hand corner.

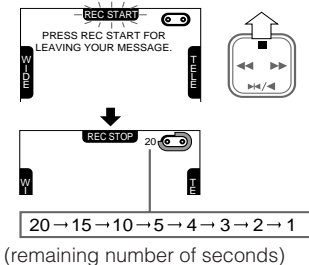

- 3 When the remaining recording time reaches 5 seconds, "EXTEND" will flash.
 - When you want to extend the recording time, press **▶/◀** on the  button to select "EXTEND" within 5 seconds. After pressing the button, you may record continuously for 10 more seconds.

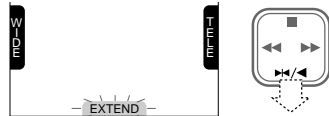

- 4 At the end of recording, the screen fades out, and recording stops automatically. The camcorder returns to Recording Standby mode, and "PRESS REC START FOR LEAVING YOUR MESSAGE." appears again on the monitor screen.

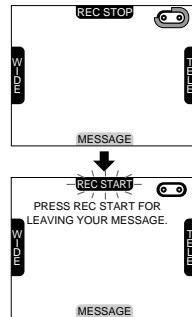

Note:

- When you want to stop recording before message recording stops automatically, press **■** on the  button to select "REC STOP". The screen fades out immediately and the camcorder returns to Recording Standby mode.

Useful Features for Camera Recording

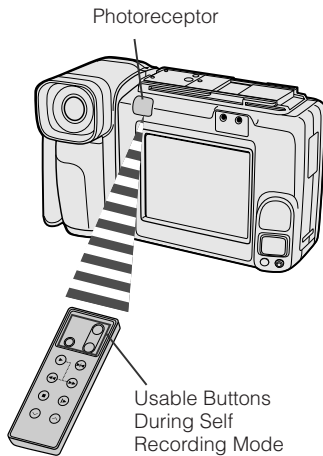

More Information on Self Recording

- The screen image is automatically inverted when the monitor rotation is between 140° and 200°. When the monitor is turned back to the normal position, the image returns to normal.
- During Self Recording mode, only the REC START/STOP, Zoom Wide and Telephoto buttons function on the remote control (see page 39).



- In the Self Recording mode, all standard warning indicators on the monitor are replaced by a flashing “” indicator. To check the meaning of the warning, turn the monitor back to the normal position.

- In Self Recording mode, it is not possible to record using manual recording modes, change picture adjustments, display menus, record the date and time, or use the quick-return and some of the other features.

- You can begin playback by setting the Power switch to VCR, even while the monitor is rotated 180°. The functions displayed on the monitor during normal playback still operate even though not displayed. (For example, the  on the operation button () works as the Play button.)

After recording in Self Recording mode, you can enjoy instant playback without having to re-rotate the monitor. In this case, the indicators will not be displayed on the monitor.

- If you set “SELF REC” to “NO CORRECT” on MENU-PAGE  (Camera mode), the screen image on the monitor will be displayed upside-down.

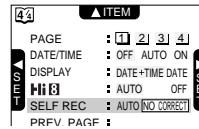

Manual Focus

The auto focus may not be able to focus on the subject in the situations shown in the chart on page 25. In such situations, set the camcorder to Manual Focus mode and focus manually.

Operation Button

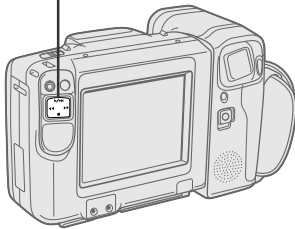

Setting the Manual Focus

- 1 Press the MENU button until **3/4** appears on the monitor (Camera mode). Press **■** on the operation button (**⊕**) to select "FOCUS".

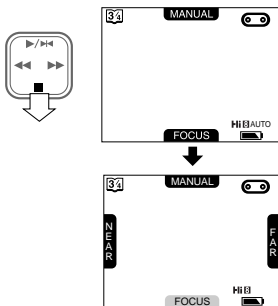

- 2 Press **◀** or **▶** on the **⊕** button to select "NEAR" or "FAR".

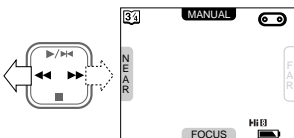

To Return to Auto Focus Mode

Press **■** on the **⊕** button to select "FOCUS" in step 1.

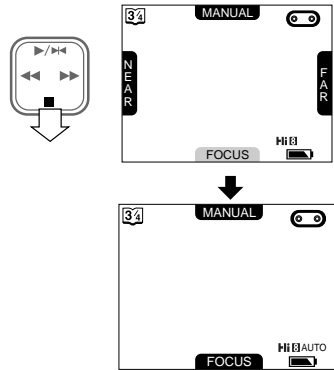

Notes:

- When recording in the Manual Focus mode, you may not be able to focus correctly if the subject is within approximately 5 feet (1.5 m) of the camcorder. In such a case, shift the zoom control toward wide angle, and then try focusing again.
- If you focus on a subject in wide angle and then set the zoom to maximum, the subject may go out of focus. (First focus on the subject at maximum zoom setting and then shoot at the desired zoom setting.)
- If the lens is dirty or fogged, you may not be able to obtain correct focus.

Useful Features for Camera Recording

Scene Menu (Program AE)

You can set the camcorder to the shooting mode that will bring the best results for a specific type of shooting situation. Just select one of the four scene settings shown below. The camcorder will automatically set the exposure, white balance, and shutter speed to produce the optimum picture quality for the selected situation.

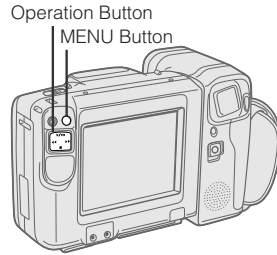

Scene	Situation	Camcorder Adjustment
Sport 	To record a fast-moving subject.	The shutter speed is set to 1/500 sec. for a clear, unblurred picture of fast-moving objects. The white balance is set for outdoor sunlight.
Ski or sand 	When the background is too bright.	The aperture is adjusted to maintain the appropriate brightness. The white balance is set for outdoor sunlight.
Twilight 	When you want to faithfully record the red of the setting sun, and the surrounding twilight.	The white balance is fixed to optimize the red of the sunset. Light sensitivity and contrast are reduced to reproduce the surrounding twilight.
Party 	When the illumination is from a spotlight or candles.	Brightness is adjusted to reduce white flaring (overexposure) from faces when the spotlight or candles are too bright.

1 Press the MENU button until appears on the monitor (Camera mode). Press on the operation button () to select "MANUAL".

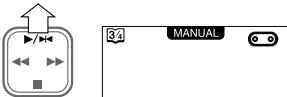

2 Select "CAMERA MODE" and then press on the button to select "MANUAL".



3 Press on the button to select "SCENE MENU".

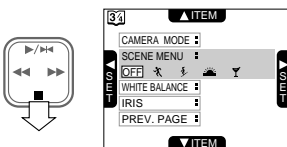

Note:

- Pressing on the button once again will select "SHUT. SPEED", not "WHITE BALANCE".

4 Press or on the button to select the scene setting that best fits the recording situation. Each time you press or on the button, the scene indicator changes as shown.

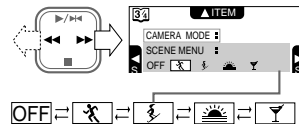

To Go Back to Auto Mode

Select "SCENE MENU" in step 3 above, and then press on the operation button () to select "OFF".

To reset the camcorder to Full Auto mode, press on the button to select "CAMERA MODE" and then press on the button to select "AUTO" in step 2.

Notes:

- When is selected, recording under the light of fluorescent lamps, mercury lamps, or sodium lamps may cause color shifts or fluctuations in picture brightness.
- When is selected, the picture may not be satisfactory if the lighting is very dim.
- We recommend that you use Auto mode ("SCENE MENU: OFF") to record outdoor parties.
- If other manual items are adjusted after setting the Scene Menu, the Scene Menu will automatically return to "OFF".

Setting the Shutter Speed

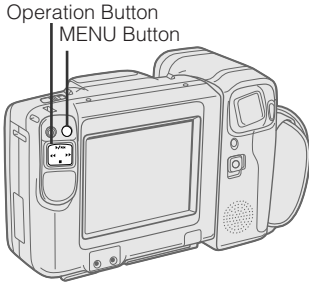

- 1 Press the MENU button until **3/4** appears on the monitor (Camera mode). Press **▶/▶** on the operation button (**3/4**) to select "MANUAL".

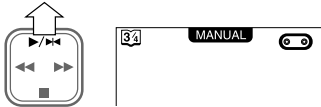

- 2 Select "CAMERA MODE" and then press **▶** on the **3/4** button to select "MANUAL".

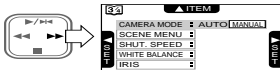

- 3 Press **■** on the **3/4** button to select "SHUT. SPEED".

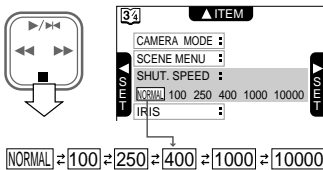

Note:

- Pressing **■** on the **3/4** button once again will select "WHITE BALANCE", not "IRIS".

- 4 Press **▶▶** on the **3/4** button to select the desired shutter speed.
 - You can select from 6 shutter speed settings from 1/60 (NORMAL) to 1/10000.

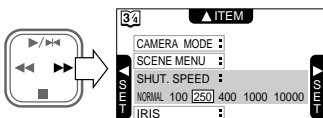

To Return to the Standard Shutter Speed

In step 4, press **◀◀** on the operation button (**3/4**) to select "NORMAL".

To reset the camcorder to Full Auto mode, press **▶/▶** on the **3/4** button to select "CAMERA MODE" and then press **◀◀** on the **3/4** button to select "AUTO" in step 2.

Recommended Shutter Speeds

The faster the shutter speed, the darker the picture becomes. Select the most appropriate shutter speed for the ambient light.

Situation	Recommended Shutter Speed
<ul style="list-style-type: none"> • Recording sports action in bright daylight • Recording in bright daylight at a ski resort 	1/10000 sec. 1/1000 sec.
<ul style="list-style-type: none"> • Recording outdoor sports on a somewhat cloudy day • Recording an outside scene through a car window (when you want to minimize blurs caused by camera shake) 	1/1000 sec. 1/250 sec.
<ul style="list-style-type: none"> • When you want to reduce the light by half. Use as a substitute for an ND2 filter. 	1/100 sec.

Note on Recording under Fluorescent Lighting

If the picture on the monitor flickers when recording under fluorescent lighting, you may be able to compensate by changing the shutter speed to 1/100 sec.

Notes:

- Using a fast shutter speed under fluorescent lighting will cause flickering in the picture and possibly periodic color shifts.
- Recording with a shutter speed higher than 1/60 sec. (standard) tends to darken the picture. Record in bright locations when you use a high shutter speed.
- If the Scene Menu is set after setting the shutter speed, the shutter speed will automatically return to "NORMAL" (1/60).

Useful Features for Camera Recording

White Balance Lock

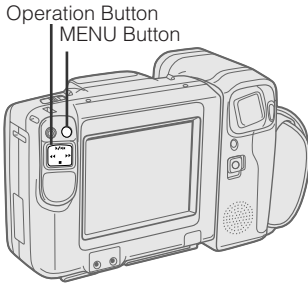

- 1 Press the MENU button until **3/4** appears on the monitor (Camera mode). Press **▶/▶◀** on the operation button (**3/4**) to select "MANUAL".

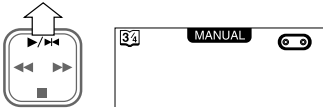

- 2 Select "CAMERA MODE" and then press **▶▶** on the **3/4** button to select "MANUAL".



- 3 Press **■** on the **3/4** button to select "WHITE BALANCE".

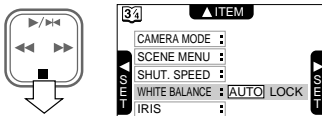

- 4 Aim the camcorder at a solid white subject in the light.

- 5 Press **▶▶** on the **3/4** button to select "LOCK".
The "LOCK" display flashes and the white balance is automatically locked. The "LOCK" display stops flashing when the locking procedure is completed.

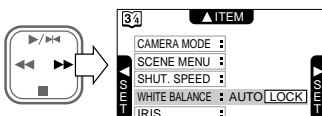

To Return to the Auto Mode

In step 5, press **◀◀** on the operation button (**3/4**) to select "AUTO". The white balance mode display will change to "AUTO".

To reset the camcorder to Full Auto mode, press **▶/▶◀** on the **3/4** button to select "CAMERA MODE" and then press **◀◀** on the **3/4** button to select "AUTO" in step 2.

Notes:

- When recording with the white balance locked, if the light source changes or if you move from indoor to outdoor, or vice versa, the white balance may shift. Reset the white balance.
- Even after the white balance has been locked, white balance shifts may occur due to slight changes in illumination or depending on the subject.
- Do not move the camcorder while "LOCK" is flashing in step 5.
- If the "LOCK" indicator does not stop flashing, set the white balance to "AUTO" and reset to "LOCK".
- If the Scene Menu is set after setting the white balance to "LOCK", the white balance will automatically return to "AUTO".

Manual Iris

The camcorder is normally set to Auto Iris mode, which automatically chooses the optimal aperture. When there is too much contrast in brightness between the subject and background, you may not be able to record a clear image. Correct the iris to adjust the aperture.

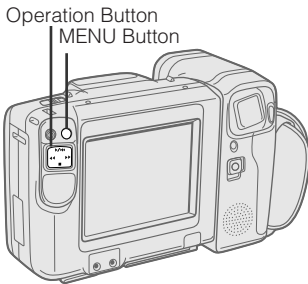

- 1 Press the MENU button until **34** appears on the monitor (Camera mode). Press **▶/▶** on the operation button (◻) to select "MANUAL".

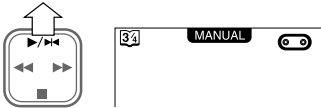

- 2 Select "CAMERA MODE" and then press **▶** on the **◻** button to select "MANUAL".



- 3 Press **■** on the **◻** button to select "IRIS".

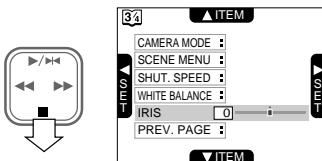

- 4 Press **◀** or **▶** on the operation button (◻) to select the desired value setting.
 - The number shows the selected aperture value. The adjustable range is from -6 (least light) to +6 (most light).

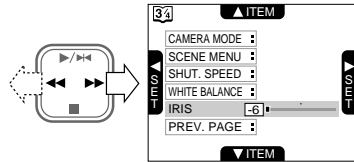

To Return to the Auto Mode

In step 4, press **◀** or **▶** on the operation button (◻) to select "0".

To reset the camcorder to Full Auto mode, press **▶/▶** on the **◻** button to select "CAMERA MODE" and then press **◀** on the **◻** button to select "AUTO" in step 2.





Note:

- If the Scene Menu is set after setting the manual iris, the aperture setting will automatically return to "0" (normal).

Recording a Five-Second Still Image (Snapshot)

You can record a still picture (snapshot) for about five seconds with normal sound simply by pressing the SNAP button.

This is useful when you want to record a scene like a photograph.

- 1 Refer to page 14 to display MENU-PAGE [3] (Camera mode). Press  on the operation button () to select "PHOTO SNAP" and then press  on the  button to select "SNAP". Press the MENU button to turn off the menu.

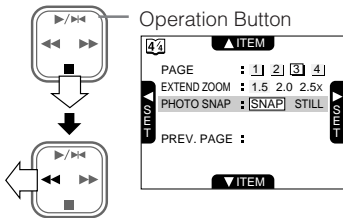

- 2 Press the SNAP button while the camcorder is in Recording Standby mode.

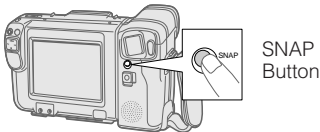

- 3 Press the REC START/STOP button.
 - The  indicator is displayed during snapshot recording.

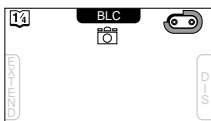

A still image of the subject will be recorded for about five seconds, then the camcorder automatically enters Recording Standby mode.





Notes:

- The image on the monitor will also be frozen during snapshot recording.
- If the electronic high-speed shutter is used with the snapshot function, you can record a complete still image without any blurring.
- The picture quality of the snapshot is slightly lower than normal picture quality.

Still Recording

You can record still images of subjects with normal sound.

You will find it useful when you want to record a shot of a tourist information board during sightseeing.

- 1 Refer to page 14 to display "MENU-PAGE [3]" (Camera mode). Press  on the  button to select "PHOTO SNAP" and then press  on the  button to select "STILL".

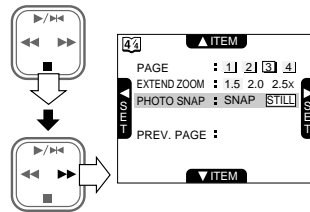

- 2 Press the SNAP button while the camcorder is in Recording Standby mode.
- 3 Press the REC START/STOP button.
- 4 To return to normal recording, press the SNAP button again in the Still Recording mode.

Notes:

- Once the Still Recording mode is set, the camcorder will remain in that mode until it is canceled, even when switching between Recording mode and Recording Standby mode.
- The picture quality in this mode will be slightly lower than normal pictures.

Caution:

- Do not keep the camcorder in Still Recording mode too long. The monitor may hold an after-image. Turn off the power and wait for a while. The monitor will return to normal.

To Stop Snapshot or Still Recording

Press the REC START/STOP button.

Strobe Recording

You can record strobe images (still pictures that capture continuous motion at 1/5 sec. intervals) of subjects with normal sound. You will find it useful when you want to produce a special effect while recording moving subjects such as your friends waving at you.

- 1 Press on the operation button () to select "STROBE" on the screen (Camera mode) while the camcorder is in Recording Standby mode.

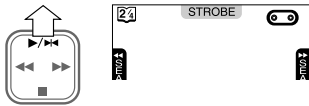

- Each time you press the button, the recording mode changes as shown below.
Normal ↔ Strobe

- 2 Press the REC START/STOP button.

- 3 To return to normal recording, press on the button to select "STROBE" again.

Notes:

- Once the Strobe Recording mode is set, the camcorder will remain in that mode until it is canceled, even when switching between Recording mode and Recording Standby mode.
- The picture quality in this mode will be slightly lower than normal pictures.

Stopwatch

The stopwatch feature is useful for measuring times in athletic races and other time competitions. You can measure down to 1/100 second. The function is available for both Camera and VCR modes.

Operation Button
MENU Button

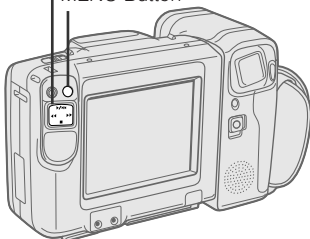

Using the Stopwatch Function

- 1 During playback (or recording), press the MENU button until (VCR mode) or (Camera mode) appears on the monitor.

- 2 Press on the operation button () to select "STOP WATCH".



- 3 Press on the button to select "START".

The "START" indicator changes to "STOP", and the stopwatch begins to show elapsed time.

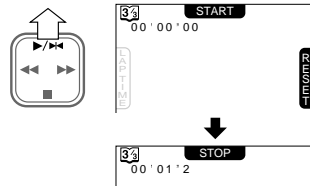

- 4 Press on the button to select "STOP".

The stopwatch display now shows the total elapsed time.

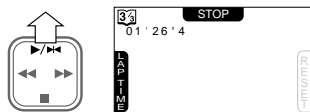

To Reset the Stopwatch

Press on the button to select "RESET".

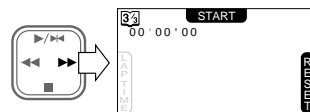

Notes:

- While the stopwatch is running, the elapsed time is displayed down to 1/10 second.
- After completing step 4, if you press on the button to select "PREV. PAGE", the monitor display will return to step 1.
- When using the stopwatch during recording, the stopwatch display is not recorded.

Useful Features for Camera Recording

Displaying Lap Times

When using the stopwatch in an athletic competition such as a 100 m swimming race, the stopwatch can display lap times, e.g. at the 50 m turn, while continuing to measure elapsed time. This function is available for both Camera and VCR modes.

Operation Button

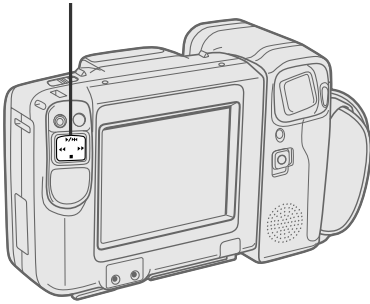

- 1 When measuring time with the stopwatch function, press **◀◀** on the operation button (**⏸**) to select "LAP TIME" at the moment that you want to know the time elapsed so far, e.g. at the 50 m turning point. The elapsed time is replaced by the lap time. The stopwatch continues to measure internally.

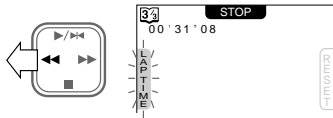

- 2 Press **◀◀** on the **⏸** button to select "LAP TIME" again. The elapsed time will reappear.

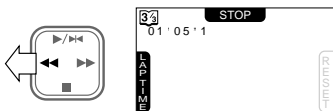

Notes:

- When using the stopwatch during recording, the lap time display is not recorded.
- Each time you select "LAP TIME", the stopwatch display indicates the time elapsed from the moment the stopwatch was started to the moment you pressed **◀◀** on the **⏸** button to select "LAP TIME".
- The stopwatch cannot measure lap time for any intermediate period.

- 3 Press **▶▶** on the **⏸** button to select "STOP". The stopwatch stops measuring, and shows the time elapsed between the start and the moment you pressed stop, e.g. from the start to the goal of the 100 m race.

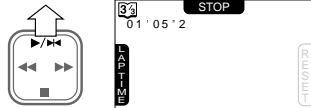

- 4 Press **◀◀** on the **⏸** button to select "LAP TIME" once to display the most recent lap time. Press **◀◀** on the **⏸** button to select "LAP TIME" a second time to display the total time elapsed.
 - You can switch between these two displays by selecting "LAP TIME".

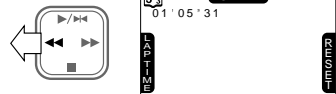
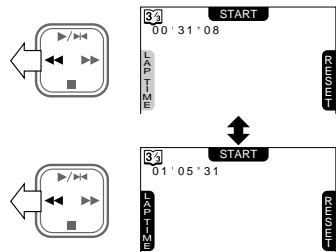

Lighting

For clear, good-quality recording, 500 to 100,000 lux is needed. Recording is also possible with less light, but the picture quality may suffer. Adequate lighting is also essential for correct white balance.

Brightness (Lux)	Situation (Lux)
100,000	Blue sky Clear day at noon (100,000)
10,000	Clear day at 10 am (65,000) Clear day at 3 pm (35,000) Cloudy day at noon (32,000) Cloudy day at 10 am (25,000)
1,000	Cloudy day, one hour after sunrise (2,000) Clear day, one hour before sunset (1,000) Fluorescent light near window (1,000)
100	Factory floor (700–800) Sales counter in department store (500–700) Bowling alley (500) Library (400–500) Office with fluorescent lighting (400–500) Fluorescent desk lamp (400) Flashlight at 3 ft (1 m) (250) Shop stairway (100)
10	During intermission at movie theater (15–35) Cigarette lighter at 1 ft (30 cm) (15–20) Candles on birthday cake at 8 inches (20 cm) (10–15) Candlelight

Reference

Lighting is not only one of the most important areas in producing home videos, but also one of the most overlooked. Good lighting can often mean the difference between a great picture and a poor one. Lighting is also essential for correct white balance.

In most outdoor, daytime scenes, natural lighting is adequate for home videos. Indoors, the situation becomes more complicated. Artificial lighting is required, and halogen lamps provide the most natural artificial light while maintaining a constant color temperature over a long operating life. Good lighting is difficult to achieve. There are many problems waiting to catch the unwary. Simply mounting one light or several lights on either side of the camcorder will only make your subject look flat and two-dimensional. To make a subject more interesting, use the lighting to model your subject and to add or create emphasis in a scene.

Color Temperature (degrees Kelvin)	Situation	Color	White Balance Range
10,000	Clear day	Blue	A U T O
9,000			
8,000	Cloudy day		
7,000	Rainy day		
6,500	Daylight fluorescent light		
6,000	Camera flashbulb		
5,500		White	
5,000	Blue photolamp		
4,500	White fluorescent light		
3,500	Off-white fluorescent light Tungsten photolamp		
3,200	Halogen lamp		Yellow
2,800	Tungsten lamp Iodine lamp		
2,500	Acetylene lamp Kerosene lamp		
2,000	Candlelight	Red	

Notes:

- The figures in the charts are approximations.
- The auto white balance operates automatically within the range of "AUTO" shown in the chart. However, it will satisfactorily operate from 2,500 K up to 8,000 K, although the picture may take on a red or blue tint.

Lighting indicator ("LIGHT")

When the "LIGHT" indicator appears on the monitor, it means that there is not enough illumination for recording. Either move to a brighter location or increase the light. You can also correct the problem by manually setting the gain (see page 26).

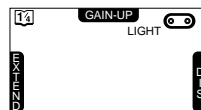

Connections and Editing

Connections for Playback on a TV

Although you can enjoy playback on the camcorder's LCD monitor, you can also play back tapes on your TV screen.

Connection to TV Using the Docking Station

- 1 Attach the camcorder to the Docking Station (see page 8).
- 2 Connect the Docking Station to your TV with the supplied audio/video cable.
- 3 Set the TV to its "AV" or "VIDEO" channel. (See the operation manual for your TV.)
 - If your TV has an S-video input connector, connect it to the Docking Station's S-VIDEO connector with the supplied S-video cable.

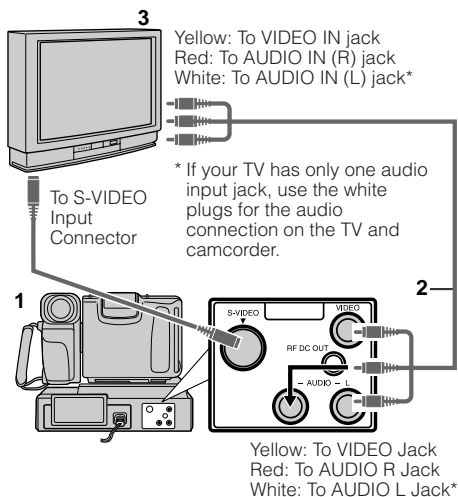

Caution:

- Make sure that the camcorder, TV and other equipment to be connected have been turned off before you make connections. Making connections with any of the components left turned on may cause picture noise or malfunction.

Note:

- When the camcorder is connected to a TV for playback, the picture on the TV screen may flicker if the volume on the camcorder is set to maximum. Should this occur, turn the volume down (see page 34).

Connection to TV Using a VCR

- 1 Connect the Docking Station to your VCR with the supplied audio/video cable.
- 2 Set the VCR to its "LINE" or "VIDEO" input channel. Operate the TV as you normally do to see the signal from the VCR. (See the operation manuals for your TV and VCR.)
 - If your VCR has an S-video input connector, connect it to the Docking Station's S-VIDEO connector with the supplied S-video cable.

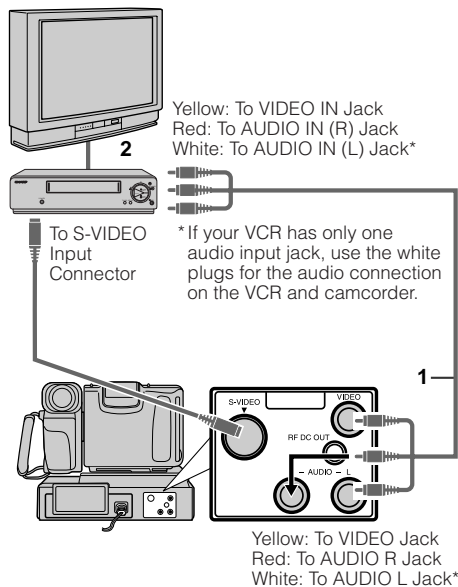

About the S-video Connector

S-video connectors are used to pass the chroma (color) and luminance (brightness) components of video signals separately. They serve to improve the picture quality in both recording and playback.

Note:

- When both the normal A/V cable and the S-video cable are connected to the Docking Station, video signals are output only through the S-video cable. Do not connect the S-video cable to the Docking Station if the video equipment to be connected does not have an S-video connector.

Connections for Playback on a TV Using Audio/Video Jacks

Although you can enjoy playback on the camcorder's LCD monitor, you can also play back tapes on your TV screen.

Connect the camcorder to your TV with the supplied audio/video cable, as shown.

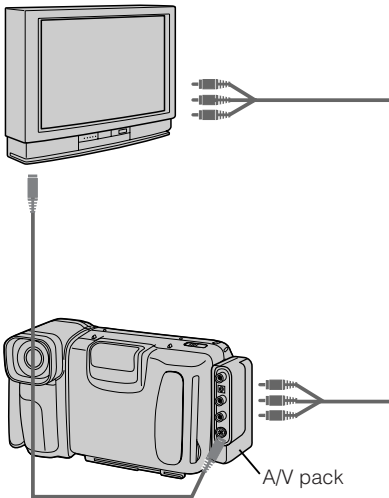

Caution:

- Make sure that the camcorder, TV and other equipment to be connected have been turned off before you make connections. Making connections with any of the components left turned on may cause picture noise or malfunction.



Note:

- When the camcorder is connected to a TV for playback, the picture on the TV screen may flicker if the volume on the camcorder is set to maximum. Should this occur, turn the volume down (see page 34).

Use the Camcorder to Play Back Tapes on a TV

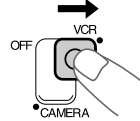
- 1 Set the Power switch to VCR.



- 2 Press  on the operation button () to select "PLAY".

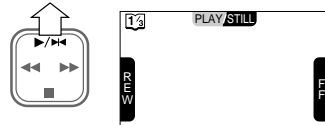

Using the Optional SAV103 A/V Pack

The optional SAV103 A/V pack (shown on page 58) lets you connect the camcorder to other audio-visual equipment. Small and lightweight, it comes in handy when traveling or any time you are away from home.

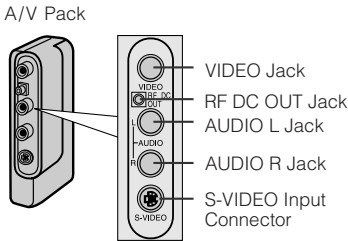

Detaching the A/V Pack

Slide the A/V PACK EJECT release in the direction of the arrow, and then pull the A/V pack straight out.

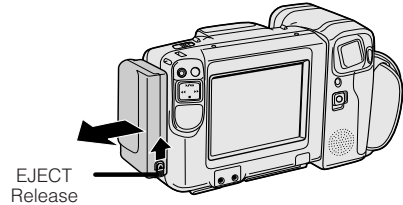

Caution:

- Do not use the A/V pack as a handle. It will cause malfunctions.

Attaching the A/V Pack

- 1 Pull the A/V pack terminal cover of the camcorder in the direction of the arrow as shown below.

Note:

- Be careful not to lose the A/V pack terminal cover once it is removed.

- 2 Align the projections on the A/V pack with the openings on the camcorder's mounting panel, and insert the A/V pack as shown. Then push the A/V pack firmly against the mounting panel until it clicks into place.

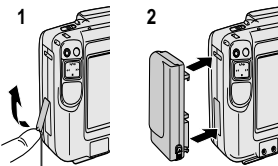

A/V Pack Terminal Cover

Editing

Video editing lets you refine your videos by removing unwanted sequences from your tape or transposing one sequence with another. This camcorder lets you monitor the source program on the built-in LCD monitor without having to connect it to an external TV or video monitor.

Connect the camcorder to a VCR with the supplied Docking Station unit and audio/video cable.

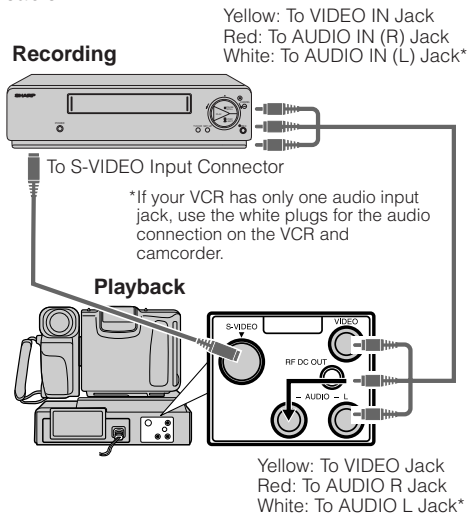

Notes:

- If your VCR has an S-video input connector, connect it to the S-VIDEO connector on the Docking Station with the supplied S-video cable.
- When both the normal A/V cable and the S-video cable are connected to the Docking Station, video signals are output only through the S-video cable. Do not connect the S-video cable to the Docking Station if the video equipment to be connected does not have an S-video connector.

Cutting Unwanted Sequences

- 1 Play back the tape to be edited, and locate the beginning and end of the sequence you wish to cut. Write down the tape counter readings at the beginning and end of that sequence (see page 37). Then rewind the tape to the beginning of the portion that you wish to keep.
- 2 Load a blank tape cassette into the recording VCR.
- 3 Set the Power switch to VCR. Press **▶/⏪** on the operation button (**⏻**) to select "PLAY" and press the VCR's REC (Record) button at the same time.
- 4 Press the VCR's Pause/Still button to pause recording when the source tape reaches the beginning of the sequence to be cut.
- 5 Press the VCR's Pause/Still (or Record) button to resume recording when the source tape reaches the end of the sequence to be cut.

To Stop Editing

Press **■** on the **⏻** button to select "STOP" on the VCR **⏻** screen and press the STOP button on the VCR.

Notes:

- Make sure that you press the Pause/Still button at exactly the right moments in steps 4 and 5 above. Otherwise, some of the transitions between edited sequences may be slightly off.
- The picture may be disturbed during video search or still picture playback. This does not imply a defect in the camcorder.

Setting the Edit Mode

Picture quality inevitably declines during dubbing from the camcorder to a VCR. To minimize the quality reduction, set the camcorder to Edit mode.

- 1 Set the camcorder to VCR mode, and press the MENU button until **33** appears.
- 2 Press **▶▶** on the **⏻** button to select "MENU".
- 3 Press **▶▶** on the **⏻** button to set "EDIT" to "ON".

Notes:

- The "EDIT" setting is ineffective when the camcorder is recording.
- After you finish dubbing, set the "EDIT" menu item back to "OFF".

Connections and Editing

Recording from an External Source

You can use this camcorder to record or edit video from another source, such as a VCR, TV, or video disc player.

Connect the camcorder to the source equipment, using the Docking Station and audio/video cable, as shown.

Recording

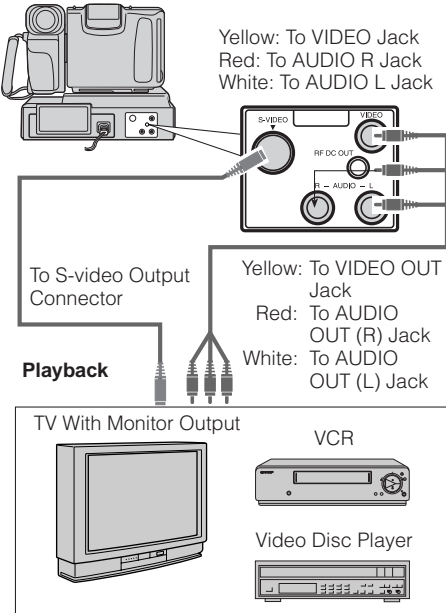

Notes:

- If the source equipment has an S-video output connector, connect it to the S-VIDEO connector on the Docking Station with the supplied S-video cable.
- If the source equipment has only one audio output jack, use the white plugs for the audio connection on the source equipment and Docking Station.

Automatic Switching of the Audio/Video Jack's Input/Output Mode

The AUDIO/VIDEO jack's mode is normally set to input. It automatically switches to output when the camcorder is playing back.

To Record from an External Source

- 1 Set the Power switch to VCR.
- 2 Start sending audio/video signals from the source equipment connected to the Docking Station. Check the camcorder's monitor to see if the picture is being properly received.
- 3 Press the REC START/STOP button on the camcorder to start recording.

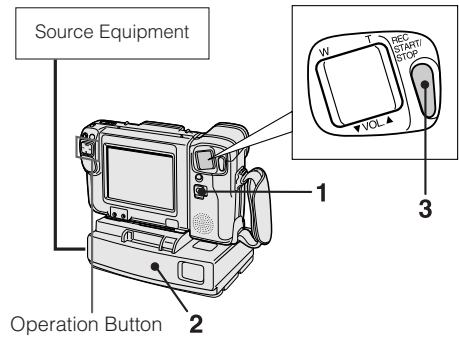

Note:

- To pause recording, press ►|◄ on the operation button (◻) on the camcorder. Press the button again to resume recording.

To Stop Recording

Press ■ on the ◻ button on the camcorder.

Caution: The unauthorized recording of television programs and other materials may infringe the rights of others.

Fluorescent Lamp Backlight

The fluorescent lamp backlight used in this camcorder will eventually need replacing. If you continue to use the camcorder when the fluorescent lamp has almost reached the end of its service life, the "REPLACE THE LAMP." indicator will be displayed on the monitor for approximately one minute. When this occurs, purchase a replacement lamp (235179) and replace the old lamp.

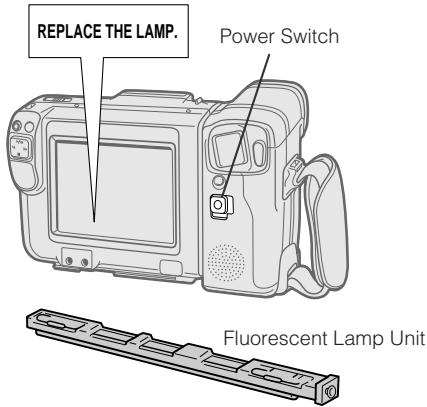

Replacing the Fluorescent Lamp Backlight

- 1 Set the Power switch to OFF to turn off the camcorder, and wait about 15 minutes for the lamp unit to cool down. Make sure the battery pack is removed from the camcorder before replacing the lamp.

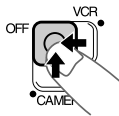

- 2 Rotate the camera module of the camcorder halfway forward in the direction of the arrow.

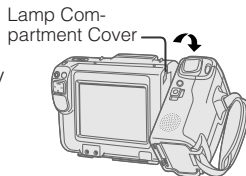

- 3 Remove the lamp compartment cover: insert a pointed object such as the point of a pen, push the cover release "⏏" down, and then pull off the cover.

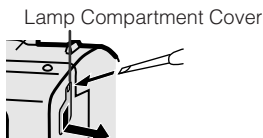

- 4 Carefully hold the end (white knob) of the lamp unit with tweezers, and pull it out.

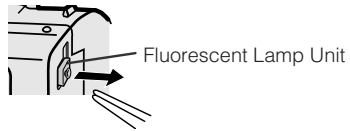

- 5 Insert the replacement lamp unit into the compartment. See note below.

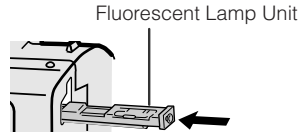

- 6 Replace the fluorescent lamp compartment cover.

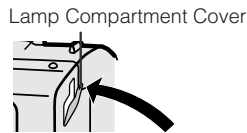

Notes:

- Be sure to insert the replacement fluorescent lamp straight in, in the direction of the arrow, into the compartment. Do not press diagonally as it may cause contact failure.
- The fluorescent light may flicker when first turned on. Should this occur, turn off the camcorder, and then turn it on again.
- When used in cold locations, the fluorescent lamp may lose some of its brightness.

Caution:

- The fluorescent lamp is hot during and immediately after use of the camcorder. Wait at least 15 minutes after turning the power off before attempting to change the lamp, to allow time for it to cool down. Attempting to change the lamp unit while it is still hot may result in burns or other injuries.

Optional Accessories

We invite you to look at some great ideas for sparking creativity and adding to the fun of using your camcorder. These accessories are designed to make the process of recording and watching your videos more enjoyable.

To order accessories, contact your local Dealer. If a dealer is not nearby, all accessories are available through toll-free ordering or by using the order form on the next page.

BB75 Battery Pack

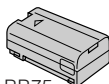

BB75

This rechargeable battery is designed specifically for long life. The BB75 is the same battery that came packed with your camcorder. It can be charged using the adapter/charger that came with your camcorder.

SUN102 Sun Hood



This sun hood helps protect the lens from strong sunlight when recording on a bright sunny day.

SDC100 Car Battery Adapter

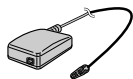

This car battery adapter enables you to operate your Camcorder from your car, truck, or RV by plugging the car cord directly into the vehicle's cigarette lighter socket. The SDC100 is designed specifically to convert power from a 24- or 12-volt negative ground car battery to a 4.5-volt output.

Caution: Do not use any other car battery adapter with this camcorder.

SAV103 A/V Pack

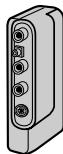

This A/V pack lets you connect your camcorder to other audio/video equipment. Small and lightweight, it comes in handy when traveling.

STP104 Tuner Pack



This tuner pack lets you view TV channels on your camcorder. You can use the tuner pack's built-in antenna or attach an external antenna to receive the TV signal. See the tuner pack User's Guide for details.

Using the Optional AC088 Tripod

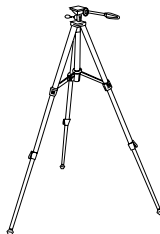

Mounting the camcorder on a tripod, such as AC088, will keep the camcorder steady and produce excellent video results.

This tripod's fluid-effect head provides smooth camera pan and tilt. The quick-release mount makes it easy to attach or remove the camcorder. The grooved, tubular 3-section leg

design folds down to 26 inches when not in use. Rubber feet allow for sure footing.

Cautions: Before using a tripod, make sure it is stable enough to hold the camcorder without falling over. Do not transport the camcorder attached to the tripod.

When attaching your camcorder to a tripod, be careful not to force the tripod screw into the Camcorder's tripod mounting hold.

The tripod screw should not protrude into the camcorder more than approximately three-eighths (3/8) inch. Forcing the screw could damage the mounting hole on the bottom of the camcorder.

Accessory Order Form

Order Form for Camcorder Model ProV950HB				
Description	Part No.	Price	Qty.	Total
Tripod	AC088	\$ 39.95		
Rechargeable Battery	BB75	\$ 99.95		
Audio/Video Pack	SAV103	\$ 49.95		
Car Battery Adapter	SDC100	\$119.95		
Tuner Pack	STP104	\$ 249.00		
Sun Hood	SUN102	\$ 69.95		
AC Adapter/Battery Charger	233576	\$ 169.95		
DC Output Cable	233578	\$ 14.95		
S-Video Cable	233579	\$ 12.95		
Shoulder Strap	233580	\$ 9.95		
Remote Control	233581	\$ 13.95		
Audio/Video Cable	233582	\$ 9.95		
Docking Station	233665	\$119.95		
Replacement Lamp Unit	235179			

Prices are subject to change without notice.

Total Merchandise \$ _____

Sales Tax \$ _____

We are required by law to collect the appropriate sales tax for each individual state, county, and locality to which the merchandise is being sent.

Shipping and Handling \$ **5.00** _____

Total Amount Enclosed \$ _____

Use VISA, MasterCard, or Discover.
Money order or check must be in U.S. currency only. No COD.

Detach Here



Accessory Order Form

Charge your order on your VISA,
MasterCard, or Discover Card by
filling in below

USE YOUR CREDIT CARD

IMPORTANT: Copy complete account number
from your VISA card



My card expires:

IMPORTANT: Copy complete account number
from your MasterCard



Copy Number
above your
name on
MasterCard

My card
expires:

IMPORTANT: Copy complete account number
from your Discover Card



My card expires:

AUTHORIZED SIGNATURE

Prices are subject to change without notice.

Print or type your name and
address clearly. This will be
your mailing label.



A complete and correct
order will save you days
of waiting.

Name: _____

Street: _____

_____ Apt: _____

City: _____

State: _____ Zip: _____

Please make sure that both sides of this form
have been filled out completely.

• Allow 4 weeks for delivery.

Download from www.Softmanuals.com All Manuals Search And Download.

All accessories are subject to availability.



To order accessories, contact your local Dealer.

If a dealer is not nearby, you can also follow the directions below to order by telephone or direct-by-mail.

United States and Canada Orders

To place your order by phone, have your Visa, MasterCard, or Discover card ready and call the toll-free number listed below between 8AM and 8PM (EST) Monday through Friday or between 9AM and 5PM (EST) Saturday.

Use this number only to place an order for accessory items listed on this order form.

1-800-338-0376

To place your order by mail, detach and mail the completed order form with credit card information, money order, or check in U.S. currency (made payable to Thomson Consumer Electronics, Inc.) to the following address:

Video Accessories
PO Box 8419
Ronks, PA 17573

Use and Care

Precautions

- **After operation, remove the battery pack from the unit.**

- **Do not aim the lens at the sun.**

Do not allow direct sunlight to strike the camcorder lens or LCD panel, whether recording is in progress or not, as it may damage the CCD sensor or LCD panel surface. Be particularly careful when recording outside.

- When shooting in dark places, avoid sudden brightly lit objects or light sources, such as the sun. Otherwise, the image may white out. Should this happen, point the camera in a different direction until the picture returns to normal.

- **Avoid magnetic sources.**

Using the camcorder near strong fluorescent lights, motors, televisions, or other magnetic sources may adversely affect recorded images.

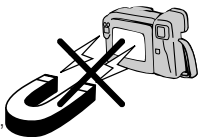

- **Remember to remove the cassette tape, turn off the power, and remove the battery pack when the camcorder is not in use.**

- **Using the camcorder near a broadcasting station or other powerful transmission source may cause buzzing or picture deterioration.**

- **Avoid shocks and dropping.**

Do not drop or otherwise subject the camcorder to hard shocks or strong vibrations. Bumping or striking the unit during recording will generate noise in the recorded image.

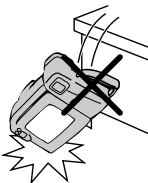

- **Avoid placing the camcorder in close proximity to lighting equipment.**

The heat from incandescent lights may deform the camcorder, or cause it to malfunction.



- **Always respect prohibitions or restrictions on the use of electronic equipment on commercial flights or in other sensitive areas.** The camcorder generates electrical interference that can disable vital equipment, leading to the risk of a serious accident.

- **Watch the temperature and humidity.**

You can use your camcorder at 0°C to +40°C (32°F to 104°F), and at 30% to 80% relative humidity. Do not store the unit in an unventilated car in the summer, in direct sunlight, or near strong heat sources; this can result in severe damage to the unit's casing and circuitry. Be careful when handling the unit after it has been left in a hot place, such as the ones described above.



- **Avoid situations where water, sand, dust or other foreign matter could get on or inside the camcorder. Such substances could cause malfunctions.**

Do not use your camcorder in areas with excessive smoke or steam.

Do not leave your camcorder in areas with excessive dust or moisture.

Such environments can cause mildew to form on this unit's lenses. Be sure to provide ample ventilation.

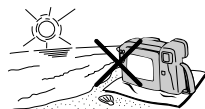

- **Some small, portable tripods may be difficult to attach and may not be sturdy enough to support your camcorder. Be sure to use only a strong, stable tripod.**



- **When using your camcorder in a cold environment, the color LCD view screen may appear less bright. This often occurs in cold environments immediately after the power is turned on. This is not a malfunction. If this occurs, put the camcorder in a warmer location for some time before use. To prevent excessive cooling, wrap the camcorder in a thick cloth (a blanket, etc.).**

Dew Formation

• What is “dew formation”?

When cold water is poured into a glass, dew drops form on the glass. This clinging of water drops is called dew formation.

• When dew forms in your camcorder.

Dew will gradually form on the head drum of your camcorder and make the video tape stick to the head. This causes damage both to the head and the tape. When dew formation occurs, recording and playback may not function properly. Dew is likely to form in the following circumstances:

- when moving the camcorder from a cold place to a warm place,
- when placing the camcorder in a cold room which is then heated rapidly,
- when moving the camcorder outdoors from an air conditioned room,
- when placing the camcorder in the direct path of air blowing from an air conditioner,
- when placing the camcorder in a humid room.



• How to prevent trouble due to dew formation.

When using the camcorder in a place where dew formation is likely to occur, allow the camcorder and the video tape to acclimate to the surroundings for about one hour. For example, when bringing the camcorder indoors after skiing, place it in a plastic bag and allow it to adapt to room conditions for some period of time.

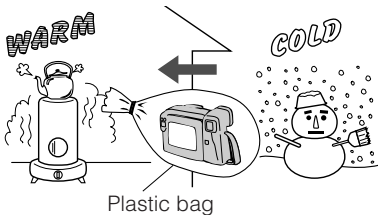

- ① Be sure to tightly seal the plastic bag containing the camcorder.
- ② Remove the bag when the air temperature inside it reaches the temperature of the surroundings.

• “Dew” warning feature

If dew forms, the word “DEW” flashes on the LCD monitor, and the power will automatically turn off in approximately 10 seconds.

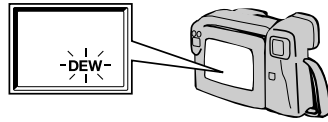

- ① If the word “DEW” flashes on the LCD monitor, remove the cassette, leave the cassette compartment open, and wait several hours to allow the camcorder to acclimate to the surrounding temperature.
- ② To use the camcorder again, turn on the power after waiting for several hours. Be sure that the word “DEW” has disappeared from the monitor screen.
- ③ Do not insert a cassette while the word “DEW” is flashing; this may result in damage to the tape.
- ④ Since dew forms gradually, it may take 10 to 15 minutes before the dew warning feature engages.

• How to continually maintain good recording.

If used in a variety of places, eventually your camcorder may not function properly due to accumulation of dirt on the head drum.

Please pay special attention to the following points when using your camcorder.

- 1) Dew formation on the head drum.
- 2) Worn video tapes:
Using a damaged or soiled video tape may also soil the head drum, causing the picture to be blurred or nothing to be recorded on the video tape. Do not use such a video tape.
- 3) The camcorder use in a humid or dusty place. Use in extremely humid or dusty places may cause damage to your camcorder.

• When the video heads become clogged.

Using the camcorder when the video tape is dirty may cause the head to clog, producing noise on the recorded image or preventing the image from being recorded at all. Under such circumstances, contact the nearest Authorized RCA Camcorder Servicenter or your dealer for further advice. (Video head cleaning can be done by using a commercially available cleaning tape. However, excessive use of the cleaning tape may also cause damage to the video heads. Please read the instructions accompanying the cleaning tape carefully, before using it.)

Use and Care

Care

Cleaning and maintenance

- Many plastic parts are used in the camcorder casing. Do not use thinners, benzenes or other strong chemical cleaners. These may cause discoloration and damage to the casing.
- Clean the casing with a soft, dry cloth. If the casing is particularly dirty, wipe the casing with a tightly wrung cloth dampened with a diluted, neutral detergent. Then wipe it again with a soft, dry cloth.
- Use a cloth to wipe finger marks and other soiling off the LCD monitor and lens protector.
- If the lens needs cleaning, first remove the lens protector by turning it counterclockwise. Then clean the lens with a cloth, or compressed air and lens papers designed for photographic lenses.

Battery Pack

This camcorder uses a lithium-ion type battery pack. It is not necessary to store the lithium-ion battery pack in a fully discharged state. Also, if stored in the charged state, the battery will gradually self-discharge, resulting in decreased recording time. Charge the battery pack soon (a day) before use.

Battery pack consumption

- Recording with many starts and stops, frequent zooming, and recording in low temperatures will somewhat shorten actual recording times. Accordingly, be sure to turn off the power when not recording. Use of an auxiliary battery pack is recommended to prevent undesirable interruptions in your recording.
- Do not use an insufficiently charged or weak battery pack. Such battery packs may cause the power to automatically stop during camcorder operation to protect both the battery pack and the unit.

Battery power is consumed even when the camcorder's power is turned off. If you are not going to use your camcorder immediately, remove the battery pack. (See page 9.)

Note:

- Use only the BB75 battery pack. It is designed specifically for use with this camcorder.

How to use the marker on the battery pack

The marker is provided to indicate the battery's charge condition. Slide the switch to indicate the charge condition as shown below.

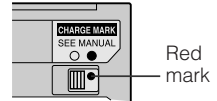

Position	Charge condition
	Before charging
	After charging

Temperature during charging

- Store the battery pack in a dry, cool place.
- Charge the battery pack at temperature of 10°C to 30°C (50°F to 86°F).

For long battery lifetime

- Charge the battery pack (lithium-ion type) at least once every six months.
- Do not leave the battery pack being charged for long periods of time.

Cautions:

- If the battery pack is misused, there is danger of fire or explosion. Pay close attention to the following:
 1. Do not dispose of in fire.
 2. Do not allow metallic objects to come in contact with the terminals. This can cause a short circuit.
 3. Do not disassemble or repair by yourself.
 4. Do not use any battery charger other than those designed for use with these battery packs.
 5. Do not place the battery pack under direct sunlight or in excessively hot places (over 60°C or 140°F) such as the dashboard of cars.
 6. Do not expose to moisture, water, or salt water.
 7. Do not drop or subject to strong force.
 8. Keep battery out of reach of children and in the original package until ready to use.
 9. Dispose of used batteries promptly.
- The battery pack will become warm during charging and use. This is normal and not a malfunction.
- The battery pack has a limited service life. If the period of use becomes noticeably shorter with a normal charge, the battery pack is at the end of its service life. Replace it with a new battery pack.
- For safety, keep the battery pack in its protective cover when it is not being used. If the metal parts of the battery pack come in contact with other metal objects, there is a danger that a short circuit may occur.

Video Cassette Tapes

To protect recordings against erasure

When a previously recorded cassette is used again for recording, the previously recorded material is erased. To protect a recording against accidental erasure, slide the tab on the cassette to cover the hole. (A red mark will be exposed.) To record, slide the tab to open the hole.

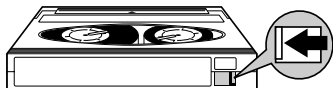

Notes:

- Do not insert anything into the erasure-protection hole in the cassette.
- Only use those tapes with the **Hi8** or the **8** mark.
- Do not put anything into the holes on the bottom of the cassette.
- Do not store or place your video tapes in direct sunlight, near heaters, or in places with excessive moisture or dust.
- Do not keep video tapes near magnetic objects as they may erase the recording.
- Do not drop or subject the tapes to excessive shocks.
- Uneven tape winding will damage the tape. If the tape is not properly wound, reinsert it in the camcorder and rewind the tape.
- Store the cassettes in their cases and stand them on edge.

What is Hi8?

Hi8 is a high-performance extension of the ordinary 8 mm format. It uses advanced technology to achieve even higher resolution and picture quality. Hi8 recording on special Hi8 tape results in a revolutionary improvement in picture quality, realizing vivid, realistic, high-quality pictures. Use a video cassette with the mark on it for high-quality recording and **Hi8** playback, or use one with the **8** mark to enjoy ordinary 8 mm recording and playback.

- When you load a Hi8 tape, recording is in Hi8 format. (The Hi8 indicator on the view screen lights up.) When you load a normal 8 mm tape, recording is in ordinary 8 mm format. (The Hi8 indicator on the view screen is off.)
- During playback, the format recorded is automatically detected.
- Video equipment not for use with Hi8 is unable to play back a tape recorded in Hi8 format.

- If you want to record with a Hi8 tape in normal 8 mm format, set the menu item "**Hi8**" to "OFF" on the MENU-PAGE **1** (Camera mode **4**) screen before recording. (See page 14 for the menu screen.)

Using Your Camcorder Abroad

Television system signals and electrical system voltages and frequencies vary substantially from country to country. When you are abroad, please check the sections below before using the AC adapter or connecting the camcorder to a TV.

AC Power Sources

The AC adapter is compatible with 50 Hz and 60 Hz electrical systems in the range of 100 V to 240 V AC.

Optional SDC100 Car Battery Adapter

This can be used with 12-V and 24-V negative-ground cars only. Do not use it with positive-ground electrical systems.

Television Signal Systems

In any country, you can always watch the video picture by using the LCD monitor screen. However, if you want to watch the picture on a TV screen, the TV must be NTSC-M system compatible. NTSC-M is used in the following areas:

The Bahamas, Barbados, Bermuda, Myanmar (previously Burma), Canada, Chile, Colombia, Costa Rica, Cuba, The Dominican Republic, Ecuador, El Salvador, Greenland, Guam, Guatemala, Haiti, Honduras, Jamaica, Japan, South Korea, Mexico, The Netherland Antilles, Nicaragua, Panama, Peru, The Philippines, Puerto Rico, St. Kitts, St. Lucia, Surinam, Taiwan, Trinidad, the U.S.A., Venezuela, southern Vietnam, and the Virgin Islands.

Trouble Checks

Troubles sometimes are caused by simple "faults" that you can easily correct without the help of a service technician by first checking a few basic remedies. Before you call or take your camcorder to an Authorized RCA Camcorder Servicer, look below for the type of trouble you are experiencing. Then perform the simple checks and adjustments listed for that trouble. If service should be necessary, the warranty information lists what your warranty covers and explains how to get service.

	Symptom	Possible cause	Suggested solution
Power	No power.	• Power source is not properly connected.	• Connect power source properly. (pp. 9, 10, 11)
		• Battery pack is not charged.	• Charge battery pack sufficiently. (pp.7, 8)
		• Dew in camcorder.	• Wait until dew dries. (p. 63)
		• Safety function is in effect.	• Set Power switch to OFF and remove battery pack; wait for two seconds, then re-install battery pack and turn on power. (p.9)
Recording	REC START/STOP button does not work.	• Erasure protect tab on video cassette is closed.	• Open tab or use a new cassette. (p.65)
	Power suddenly turns off.	• Camcorder left in Recording Standby mode for five minutes.	• Set Power switch to OFF and then back to CAMERA.
	Monitor picture is hard to see.	• Inappropriate picture adjustments.	• Adjust picture. (p. 21)
	Auto focus does not work.	• Manual Focus mode is engaged.	• Set to Auto Focus mode. (p. 43)
		• Zoom used on close subject.	• Zoom out on subject. (p. 24)
		• Subject has little contrast in brightness or is full of horizontal or vertical stripes.	• Focus manually. (p. 43)
	Bright subject produces wide vertical lines.	• Occurs when shooting subject with strong contrast to the background. Does not indicate a malfunction.	—
	No audio from speaker when recording.	• Speaker does not work during Camera mode. (Volume control in Camera mode only affects earphone volume.)	—
Automatically zooms out without operating Zoom buttons.	• Camcorder is unable to focus when zooming in on subject within 5 feet (1.5 m), and automatically zooms out until it focuses on subject.	• Zoom out. (p. 24)	
	• No subject in the field of view.	• Direct lens to some subject, or set zoom to widest angle before shooting. (p. 24)	
Playback	Tape stops midway through rewind or fast forward.	• Counter is in memory mode.	• Disengage the memory mode. (p. 38)
	No image appears on connected TV screen.	• Video input channel on TV or TV channel is not selected properly.	• Select video input channel or TV channel properly. (p. 52)
		• A/V cable is not properly connected.	• Connect A/V cable properly. (p. 52)
	• Docking Station is not properly connected.	• Connect the Docking Station properly. (p. 8)	

	Symptom	Possible cause	Suggested solution
Playback	Cannot play back, rewind or fast forward tape.	• Tape already wound or rewound completely.	• Rewind or fast forward tape to desired point. (p. 34)
	Video noise in image.	• Dirty video heads.	• Call for service.
		• Old or worn tape.	• Use a new video cassette.
Recording & Playback	No power in VCR or Camera mode.	• Depleted battery pack.	• Use fully charged battery pack. (pp.7, 8)
		• AC adapter cord removed from power outlet.	• Plug AC adapter cord into power outlet. (p.10)
	Cassette will not eject.	• Power source is not properly connected.	• Connect power source properly. (pp. 9, 10, 11)
		• Battery pack is not charged.	• Charge battery pack sufficiently. (pp. 7, 8)
		• Camcorder is recording.	• Stop tape and try again.
	No buttons operate.	• Dew in camcorder.	• Wait until dew dries. (p. 63)
No image on monitor.	• Backlight has been turned off.	• Press MODE DISPLAY button, or set Power switch to OFF and then back to CAMERA or VCR. (p. 38)	
	• Fluorescent lamp is burned out.	• Replace with new fluorescent lamp unit. (p. 57)	
Cannot edit to connected VCR.	• A/V or S-video cable is not properly connected.	• Connect A/V or S-video cable properly. (p. 52)	
	• Docking Station is not properly connected.	• Connect Docking Station properly. (p. 8)	
Lens makes rattling sound when camcorder is moved in VCR mode or with power off.	• Does not indicate a malfunction.	—	
Remote control does not function.	• "REMOTE" menu item is set to "OFF".	• Set "REMOTE" menu item to "ON". (p. 39)	
	• Remote control lithium cell has run down.	• Replace remote control lithium cell with a new one. (p. 6)	
	• Remote control used beyond operating range.	• Use remote control within operating range. (p. 39)	
	• Intense daylight falling on camcorder's photoreceptor.	• Protect photoreceptor from exposure to intense daylight. (p. 39)	
	• Obstacle between remote control and camcorder's photoreceptor.	• Remove obstacle or use remote control from different angle. (p. 39)	

Notes:

- This unit is equipped with a microprocessor. Its performance could be adversely affected by external electrical noise or interference. If this should happen, turn off the power and disconnect the unit from any power sources, including lithium batteries, etc. Then reconnect the power sources (to resume operation).
- If the characters displayed on the monitor screen appear to malfunction, disconnect the power source and remove the lithium cell, then reconnect the power source, insert the lithium cell, and turn the power on again. The characters on the monitor should be normal. Set the date and time, then resume operation.

Specifications

Signal System: NTSC standard
Recording System: 2 rotary heads, helical scanning system
Cassette: 8 mm video tape, MP type or Hi8 MP, ME type
Recording/Playback Time: 120 minutes (P6-120)
Tape Speed: 14.345 mm/second
Pickup Device: $\frac{1}{4}$ " (6.4 mm, effective size: 4.5 mm) CCD image sensor (with approx. 410,000 pixels including optical black)
Lens: $12\times$ power zoom lens (F1.8, $f=4.2\text{--}50.4$ mm), full-range auto focus
Lens Filter Diameter: 37 mm
Monitor: 4" (10.1 cm)—full-color LCD screen (TFT active matrix)
Microphone: Electret stereo microphone
Power Requirement: DC 3.6 V
Power Consumption: 7.1 W (during camera recording in full auto mode with zoom motor off, backlight in normal mode)
Operating Temperature: 0°C to +40°C (32°F to 104°F)
Operating Humidity: 30% to 80%
Storage Temperature: -20°C to +60°C (-4°F to 140°F)
Dimensions (approx.): $7\frac{15}{32}$ " (W) \times $4\frac{1}{32}$ " (H) \times $3\frac{1}{16}$ " (D) [190 mm (W) \times 117 mm (H) \times 97 mm (D)]
Weight (approx.): 1.8 lbs (820 g) (without battery pack, lithium battery, video cassette)

AC Adapter/Battery Charger

Power Requirement: AC 100–240 V, 50/60 Hz
DC Output: 4.5 V
Power Consumption: 25 W
Dimensions (approx.): $4\frac{3}{4}$ " (W) \times 2" (H) \times 4" (D) [120 mm (W) \times 51 mm (H) \times 101.5 mm (D)]
Weight (approx.): 0.86 lbs (390 g)

Specifications are subject to change without notice.

INFORMATION TO USER

This device complies with Part 15 and Part 18 of the FCC Rules. Operation is subject to the following two conditions: (1) This device may not cause harmful interference, and (2) this device must accept any interference received, including interference that may cause undesired operation.

This equipment has been tested and found to comply with the limits for a Class B digital device and RF lighting device pursuant to Part 15 and Part 18 of the FCC Rules. These limits are designed to provide reasonable protection against harmful interference in a residential installation. This equipment generates, uses, and can radiate radio frequency energy and, if not installed and used in accordance with the instructions, may cause harmful interference to radio communications. However, there is no guarantee that interference will not occur in a particular installation. If this equipment does cause harmful interference to radio or television reception, which can be determined by turning the equipment off and on, the user is encouraged to try to correct the interference by one or more of the following measures:

- Reorient or relocate the receiving antenna.
- Increase the separation between the equipment and receiver.
- Connect the equipment into an outlet on a circuit different from that to which the receiver is connected.
- Consult the dealer or an experienced radio/TV technician for help.

Customer Assistance and Service

You can reach Thomson at the following number:

800-283-6503

(Toll free inside U.S.A.)

Our toll-free Camcorder number operates from 8 a.m. to 5 p.m., CST Monday - Friday for U.S. customers only

Thomson provides a toll-free telephone number to help you with any problems you may encounter with your camcorder. Many can be diagnosed over the phone, and if necessary, a replacement unit can be shipped to you. Please have your camcorder model/serial number and date of purchase ready when you call. If your unit is out of warranty, we will quote the cost of an exchange unit to you.

Returning equipment to Thomson for repair or exchange

If we are unable to resolve your problem over the phone, we will gladly service your unit or exchange it for a new or refurbished camcorder. Refer to the limited warranty on the reverse side to learn about your specific rights and responsibilities.

Always consult Thomson and get a Return Authorization number before returning anything! Obtain a Return Authorization (RA) number from the telephone representative before returning your equipment to avoid delays, accounting errors, or even loss of your unit.

Important information to customers who ship defective equipment to Thomson Consumer Electronics

The Thomson representative who authorized the return of your equipment will give you an RA number over the phone. They will also provide you with instructions on where and how to return your camcorder. Write the number in large, clear characters on the outside of the box. To avoid confusion and misunderstandings, shipments without an RA number clearly visible on the outside of the box will be returned to you at your expense.

Include a brief note describing the problem and any conversations about the problem you have had with Thomson personnel. Include your name, address

and model/serial number of your camcorder. These numbers are located on the bottom of your unit. If your camcorder is within the warranty period, please provide a copy of the bill of sale to verify purchase date. Use the original box and packing material to protect the equipment from damage in shipment.

For your protection, insure all shipments for full replacement value and use a reliable shipper. Thomson assumes no responsibility for warranty shipments from the customer to the factory if not shipped in the manner prescribed by Thomson.

Limited warranty

What your warranty covers:

- Any defect in materials or workmanship.

For how long after your purchase:

- 90 days for labor charges.
- One year for parts.

(The warranty period for rental units begins with the first rental or 45 days from date of shipment to the rental firm, whichever comes first.)

What we will do:

During the initial 90 days

- Exchange your camcorder with a new or refurbished unit, or repair your camcorder. The option will be ours. There will be no cost to you.

After the 90 days and within one year

- Exchange your camcorder with a new or refurbished unit, or repair your camcorder. The option will be ours. Parts will be provided at no charge, but you will be responsible for the cost of labor required for the repair.

How you get service:

- Call 1-800-283-6503 and have your unit's date of purchase and model/serial number ready. The model/serial number information is on the bottom of your camcorder.
- A representative will troubleshoot your problem over the phone. If the representative determines that you should receive a replacement unit, you will be provided with a Return Authorization (RA) number and the location of a nearby exchange point if one exists. No returns will be accepted without the RA number.

To receive a replacement camcorder before you return yours:

If you are located near an exchange point:

1. We will send a replacement unit to the exchange point next business day delivery in the continental USA.
2. The exchange location will notify you of its arrival.

3. Take your unit, including all accessories, and your evidence of purchase date, such as a bill of sale, to the exchange location and you will be provided the new or refurbished unit.
4. If the repairs were covered by your warranty, you will not be billed.

If you are *not* located near an exchange point:

1. Provide your Discover, MasterCard or Visa account number and expiration date to our phone representative. This is for security purposes. If we receive your unit including all accessories within 14 days from the date you were provided an RA number, only items not covered by warranty will be charged to your account. **IF YOUR UNIT INCLUDING ALL ACCESSORIES IS NOT RECEIVED WITHIN 14 DAYS, THE SUGGESTED RETAIL VALUE OF THE CAMCORDER AND/OR ACCESSORIES WILL BE CHARGED TO YOUR CREDIT CARD.** This amount will be credited if the unit is subsequently received.
2. We will send you a replacement unit next business day delivery in the continental USA.
3. You will receive an invoice packed with the replacement product, but will not be charged for the unit portion of the invoice amount if we receive your unit including all accessories within 14 days from the date you were provided the RA number. Any labor and parts charges not covered by the warranty will be included and charged against your account.
4. Ship the unit back to us along with all accessories included with your camcorder using the replacement unit's carton. Shipping instructions will be included in the carton along with your RA number, which will allow you to easily ship the unit back to us. **Make sure you insure your shipment in case of damage or loss.**

Include with the shipment:

- Evidence of purchase date, such as a bill of sale, to verify your unit's warranty eligibility.
- A brief note describing your camcorder's problem.
- Your name, address, and phone number.

Return transportation, storage, handling, and insurance costs are your sole responsibility. We accept no liability in case of damage or loss.

To receive a replacement unit after we have received your unit:

1. **Write the RA number on the outside of the carton used to return the unit. Make sure you insure your shipment in case of damage or loss.**
2. Carefully pack the unit along with all accessories included with your camcorder, using the original box and packing material if possible.
3. Include with the shipment:
 - Evidence of purchase date, such as a bill of sale, to verify your unit's warranty eligibility.
 - A brief note describing your camcorder's problem.
 - Your name, address, and phone number.

Return transportation, storage, handling, and insurance costs are your responsibility. We accept no liability in case of damage or loss.

4. Include a cashier's check or money order for payment if there are any out of warranty labor or parts charges which were indicated by the representative, and you elected not to use your credit card.
5. Upon receipt of your product, a new or refurbished unit will be shipped to you next day delivery in the continental USA.

To have your Camcorder repaired by an Authorized RCA Camcorder Servicer:

- Check with your dealer or call 1-800-336-1900 for the Authorized RCA Camcorder Servicer nearest you.
- Take your unit to the Authorized RCA Camcorder Servicer of your choice.
- Show the Authorized RCA Camcorder Servicer representative evidence of purchase date, such as a bill of sale.
- Pick up your camcorder when repairs are complete.

What your warranty *does not* cover:

- Adjustment of customer controls.
- Damage from misuse or neglect.
- A unit that has been modified or incorporated into other products or is used for institutional or other commercial purposes.
- Batteries.
- Cleaning of video/audio heads.
- Camcorders purchased or serviced outside the USA.
- Return transportation, storage, and handling costs of your unit, including insurance for loss or damage.
- Acts of God, such as but not limited to lightning damage.

Product Registration:

- Please complete and mail the Product Registration Card packed with your camcorder. It will make it easier to contact you should it ever be necessary. The return of the card is not required for warranty coverage.

How State Law relates to warranty:

- This warranty gives you specific legal rights, and you may have other rights that vary from state to state.

If you purchased your camcorder outside the USA:

- This warranty does not apply. Contact your dealer for warranty information.

Index

— A —

16:9 Recording	29
A/V Pack Terminal Cover	4
A/V Pack, Optional	54,58-61
AC Adapter, Using	10
AC Adapter/Battery Charger	7
Accessories, Included	3,59-61
Accessories, Optional	58-61
Accessories, Order Form	59-61
Area Table for Time Zones	20
Area, Date, and Time Displaying	19
Area, Date, and Time Setting	17
Assistance	3,69,Back Cover
Auto Focus	25
Auto Tape Rewind	34
Automatic Screen Display, Canceling	29

— B —

Backlight Compensation	26
Backlight/Picture Adjustment	21
Basic Operations – Camera Recording	23-33
Basic Operations – Playback	34-39
Battery Compartment	5,9,11
BATTERY IS TOO LOW Indicator ...	16,33
Battery Pack	7,8,9,33,64
Battery Pack, Care	64
Battery Power Display	33
Buttons, Remote Control	39

— C —

Camcorder, Care	64
Camcorder Cell, Installing	6
Camcorder Controls	4-5
Camcorder, Cleaning	64
Camcorder, Powering	9-11
Camera Mode	13-15,21,28,32
Camera Recording – Basic Operations	23-33
Camera Recording – Useful Features	40-51

Canceling Automatic Screen Display .	29
Car Battery Adapter, Using	11
Care and Use	62-65
Cassette Compartment	4,6,12
CASSETTE NOT RECORDABLE Indicator	16
Cassettes, Care	65
Cassettes, Hi8	65
Cassettes, Inserting and Removing ...	12
Cat's Eye (Gain Up)	26
Cautions	i
Cell, Installing in Camcorder	6
Cell, Installing in Remote Control	6
CHANGE THE CASSETTE Indicator	16,33
Charging the Battery, Adapter/ Charger	7
Charging the Battery, Docking Station	8
Chart for Time Zone	20
Checks, Trouble	66-67
Clock, World	18
Connections and Editing	52-56
Connections, TV Using Docking Station	52
Connections, TV With Audio/Video Jacks	53
Connections, VCR Using Docking Station	52
Contents	1-2
Controls, Camcorder	4-5
Counter Memory	38
Customer Assistance	3,69,Back Cover
Customer Assistance and Service .	69-71

— D —

Date and Time Recording	32
Date, Area, and Time Displaying	19
Date, Area, and Time Setting	17
DC Cable	10,11
Design Specifications	68
Dew in Camcorder	63
DEW Indicator	16,63
Digital Image Stabilization	27
Digital Quick Zoom	25
Digital Zoom	24

Display of Remaining Recording Time	33
Docking Station, Using	7,8,52
EarPHONE Jack	5,34
Edit Search	30
Editing	55
Editing and Connections	52-56
EJECT THE CASSETTE Indicator	16
Erasure Protect Tab	12,65
Extend Zoom	25
External Microphone Jack	5
External Source, Recording From	56

— F —

Fading	28
Fast Forward Operation	34
Features – Camera Recording	40-51
FF (Fast Forward) Button	39
First-Time Operation	6-22
Fluorescent Lamp Backlight	57
Fluorescent Lamp Compartment	5
Focus Auto	25
Focus, Manual	43
Full Auto Mode	23,32

— G —

Gain-Up (Cat's Eye)	26
---------------------------	----

— H —

Handstrap, Adjusting	5,22
Hi8 Cassettes	65

— I —

Important Safeguards	ii-iii
Important Safety Information	i
Included Accessories	3,59-61
Information, Important	i-5
INSERT A CASSETTE Indicator	16
Inserting and Removing Cassettes	12
Iris, Manual	47

— L —

LAMP OFF Indicator	38
Lamp, Fluorescent	57
Lap Times	50
LCD Monitor	5
LCD Monitor Backlight, Turning Off	38
LCD Monitor, Handling	22
LCD Monitor, Replacing Lamp	57
Lens Protector	4
LIGHT Indicator	51
Lighting	51
Limited Warranty	70-71

— M —

Macro Shots	27
Manual Focus	43
Memory, Counter	38
MENU Button	5,13-15,17,18,19,24,26, 27,28,29,30,32,34,36,37 38,43,44,45,46,47,48,49
Menus, On-Screen	13-15
Messages, Self-Recording	41
MICROPHONE Jack	5
Microphone, Stereo	4
MODE DISPLAY Button	5,13-15,29,30,33,38

— O —

Operation Button	5,13-15,17,18,19 21,23,24,25,26,27,28,29,30 32,34,35,36,37-38,40-42,43 44,45,46,47,48,49-50
Operation	
Backlight Compensation	26
Digital Image Stabilization	27
Fading	28
First-Time	6-22
Focus, Auto	25
Focusing, Manual	43
Full Auto	23,32
Gain-Up	26

Index

Iris	47
Playback	34
Recording	23-33
Remote Control	39
Self-Recording	40-42
Snapshot Recording	48
Still Recording	48
Strobe Recording	49
Stopwatch	49-50
Tape Counter	37-38
White Balance	46
Wide Screen Recording	29
Zooming	24-25
Optional Accessories	58-61
Optional Car Battery Adapter	11,58
Optional Plug Adapter	10
Order Form, Accessories	59-61

— P —

Party Mode	44
Pause Recording	23
PAUSE/STILL Button	39
Photoreceptor	5,39
Picture/Backlight Adjustment	21
Play Back Tapes Using Camcorder	53
PLAY Button	39
Playback	34
Playback – Basic Operations	34-39
Positions, Recording	31
Power (CAMERA/VCR) Switch	5
..... 13-15,17,18,19,21,23,30,33,36	
Power Zoom Buttons	5,24,27,39
Powering the Camcorder	9-11
PREV. PAGE Menu Feature	15
Problem Solving	66-67
Product Registration	i
Program AE	44
Program Search	36
PUSH Mark	12

— Q —

Quick Return	30
--------------------	----

— R —

RECOrd START/STOP Button	
..... 5,23,28,39	
Recording Date and Time	32
Recording on the Camcorder	56
Recording Pause	23
Recording Positions	31
Recording Tips	31
References	57-75
Registration Card	i
Registration, Product	i
Remaining Battery Power Display	33
Remaining Recording Time Display ...	33
Remote Cell, Installing	6
Remote Control Buttons	39
Remote, Using	39
Removing the Lens Protector	4
REPLACE THE LAMP Indicator	16
Return, Quick	30
REW Button	39
Rewind Operation	34

— S —

S-Video Connector	52,54-56
Safeguards, Important	ii-iii
Scene Menu	44
Search, Edit	30
Search, Program	36
Search, Video	35
Self Recording	40-42
Sensor, Remote	39
Setting Area, Date, and Time	17
Setting the Shutter Speed	45
Shoulder Strap, Attaching	22
Shoulder Strap	5,22
Shutter Speed	45
Ski or Sand Mode	44
SLOW Button	35,39
Slow Feature	35
SNAPshot Button	5,48
Snapshot Feature	48
Solving Problems	66-67
Specifications	68

Sport Mode	44
Stabilization, Digital Image	27
Stand, Retractable	4
Stand, Using	35
Stereo Microphone	4
Still Feature	35
Still Image Recording	48
Still Recording	48
STOP Button	39
Stopwatch	49-50
Strobe Recording	49
Supplied Accessories	3,59-61

— T —

Table of Contents	1-2
Tape Counter	37-38
TAPE END Indicator	33
Tape Rewind, Auto	34
THE TAPE ENDS SOON Indicator ..	16,33
Time and Date Recording	32
Time Zone Chart	19
Time, Area and Date Displaying	19
Time, Area and Date Setting	17
Times Zones Table	20
Tips on Traveling Abroad	65
Tips, Recording	31
Traveling Abroad Tips	65
Tripod	27,58
Tripod Socket	5,58
Trouble Checks	66-67
Twilight Mode	44

— U —

Use and Care	62-65
Useful Features – Camera	
Recording	40-51
Using Remote	39

— V —

VCR Mode	13-15,21,34,35
Video Heads Clogged Indicator	16
Video Search	35
VOLume Buttons	5,34,39

— W —

Warning	i
Warning Indicator During	
Self-Recording Mode	16
Warning Indicators	16
Warranty, Limited	70-71
White Balance	46
Wide Screen Recording	29
World Clock	18

— Z —

Zoom Buttons	5,24,27,39
Zoom Lens	4
Zooming	24,25

Need Assistance? We want to help!

U.S. Consumers:

Camcorder Exchange Warranty 800-283-6503
Customer Service 800-336-1900
Accessories 800-338-0376

Canadian Consumers:

English 800-522-0338
French 800-522-0445

Please do not send any products to the Indianapolis address listed in this manual or on the carton. This will only add delays in service for your product.

 **THOMSON CONSUMER ELECTRONICS**
10330 N Meridian Street
Indianapolis, IN 46290

©1996 Thomson Consumer Electronics, Inc.
Trademark(s)[®] Registered
Marca(s) Registrada(s)
Printed in Japan
Part Number 96-ProV950HB-1
TINSE0206TAZZ

Free Manuals Download Website

<http://myh66.com>

<http://usermanuals.us>

<http://www.somanuals.com>

<http://www.4manuals.cc>

<http://www.manual-lib.com>

<http://www.404manual.com>

<http://www.luxmanual.com>

<http://aubethermostatmanual.com>

Golf course search by state

<http://golfingnear.com>

Email search by domain

<http://emailbydomain.com>

Auto manuals search

<http://auto.somanuals.com>

TV manuals search

<http://tv.somanuals.com>