

# REMINGTON®

BLUE FLAME VENT-FREE  
PROPANE/LP GAS HEATER  
OWNER'S OPERATION AND  
INSTALLATION MANUAL

For more information, visit [www.desatech.com](http://www.desatech.com)

REM10PT  
10,000 Btu/Hr  
Thermostatically-  
Controlled Heater

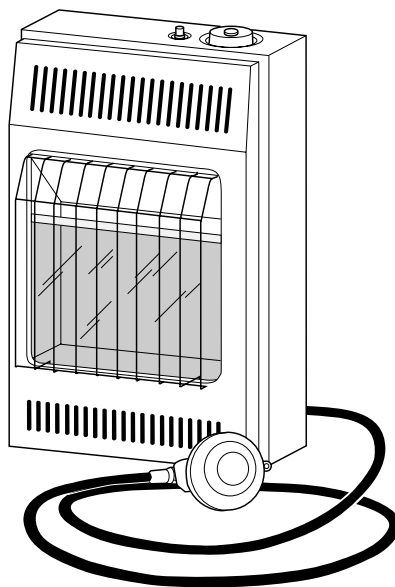

**WARNING:** If the information in this manual is not followed exactly, a fire or explosion may result causing property damage, personal injury, or loss of life.

- Do not store or use gasoline or other flammable vapors and liquids in the vicinity of this or any other appliance.
- **WHAT TO DO IF YOU SMELL GAS**
  - Do not try to light any appliance.
  - Do not touch any electrical switch; do not use any phone in your building.
  - Immediately call your gas supplier from a neighbor's phone. Follow the gas supplier's instructions.
  - If you cannot reach your gas supplier, call the fire department.
- Installation and service must be performed by a qualified installer, service agency, or the gas supplier.

**WARNING:** Improper installation, adjustment, alteration, service, or maintenance can cause injury or property damage. Refer to this manual for correct installation and operational procedures. For assistance or additional information consult a qualified installer, service agency, or the gas supplier.

**WARNING:** This is an unvented gas-fired heater. It uses air (oxygen) from the room in which it is installed. Provisions for adequate combustion and ventilation air must be provided. Refer to *Air for Combustion and Ventilation* section on page 4 of this manual.

This appliance is only for use with the type of gas indicated on the rating plate. This appliance is not convertible for use with other gases.

Save this manual for future reference.



## TABLE OF CONTENTS

SAFETY INFORMATION .....	2	TROUBLESHOOTING .....	13
PRODUCT IDENTIFICATION .....	3	ILLUSTRATED PARTS BREAKDOWN AND PARTS LIST .....	16
UNPACKING .....	3	SPECIFICATIONS .....	18
LOCAL CODES .....	4	TECHNICAL SERVICE .....	18
PRODUCT FEATURES .....	4	SERVICE HINTS .....	18
PROPANE/LP SUPPLY .....	4	SERVICE PUBLICATIONS .....	18
INSTALLATION .....	4	ACCESSORIES .....	18
OPERATING HEATER .....	9	REPLACEMENT PARTS .....	18
INSPECTING BURNER .....	11	OWNER'S REGISTRATION FORM .....	21
STORAGE .....	11	WARRANTY INFORMATION .....	Back Cover
CLEANING AND MAINTENANCE .....	12		

## SAFETY INFORMATION

### WARNINGS

**IMPORTANT:** Read this owner's manual carefully and completely before trying to assemble, operate, or service this heater. Improper use of this heater can cause serious injury or death from burns, fire, explosion, electrical shock, and carbon monoxide poisoning.

** DANGER:** Carbon monoxide poisoning may lead to death!

When used without adequate combustion and ventilation air, this heater may give off excessive carbon monoxide, an odorless, poisonous gas.

** WARNING:** Early signs of carbon monoxide poisoning resemble the flu, with headaches, dizziness, and nausea. If you have these signs, the heater may not be working properly. Get fresh air at once! Have heater serviced.

Some people, including pregnant women, people with heart or lung disease, anemia, those under the influence of alcohol, and those at high altitudes, are more affected by carbon monoxide than others.

**Propane/LP Gas:** Propane/LP gas is odorless. An odor-making agent is added to propane/LP gas. The odor helps you detect a fuel gas leak. However, the odor added to propane/LP gas can fade. Propane/LP gas may be present even though no odor exists.

Make certain you read and understand all warnings. Keep this manual for reference. It is your guide to safe and proper operation of this heater.

** WARNING:** Any change to this heater or its controls can be dangerous.

** WARNING:** Do not use any accessory not approved for use with this heater.

** WARNING:** If the recreational or commercial enclosure does not have a window or roof vent, **DO NOT USE THIS HEATER** inside.

This heater should be inspected before each use. Frequent cleaning may be required. The control compartments, burners and circulating air passageways of the heater must be kept clean.

Due to high temperatures, the appliance should be located out of traffic and away from combustible materials.

Children and adults should be alerted to the hazard of high surface temperature and should stay away to avoid burns or clothing ignition.

Do not place clothing or other flammable material on or near the appliance. Never place any objects on the heater.

Heater will remain hot for a time after shutdown. Allow surface to cool before touching.

Young children should be carefully supervised when they are near the heater.

## SAFETY INFORMATION

### Continued

**Any safety screen or guard removed for servicing the appliance must be replaced prior to operating the heater.**

**Keep the appliance area clear and free from combustible materials, gasoline and other flammable vapors and liquids.**

1. Install and use heater with care. Follow all local ordinances and codes. In the absence of local ordinances and codes, refer to the *Standard for Storage and Handling of Liquefied Petroleum Gas, ANSI/NFPA 58* and the *Natural Gas Installation Code, CAN/CGA B149.2*. This instructs on the safe storage and handling of propane/LP gases.
2. This appliance is only for use with the type of gas indicated on the rating plate. This appliance is not convertible for use with other gases.
3. This heater may be used in a recreational enclosure or temporary construction work enclosure with a remote refillable propane/LP cylinder **ONLY** when the cylinder is located outdoors and the heater is used with the hose kit #LPA3090 (included with this heater). **NEVER** bring a refillable propane/LP cylinder indoors. A fire or explosion can occur causing property damage, serious injury or death.
4. Use only the hose and factory preset regulator provided with the heater. Use only replacement pressure regulators and hose assemblies specified in this manual. See *Accessories*, page 18.
5. Inspect the hose before each use of the heater. If it is evident there is excessive abrasion or wear, or the hose is cut, it must be replaced prior to the heater being put into operation. Use replacement hose assembly kit #LPA3090 (see *Accessories*, page 18).
6. Use only propane gas set up for vapor withdrawal.
7. This heater shall not be installed in a bedroom or bathroom.
8. This heater needs fresh, outside air ventilation to run properly. This heater has an Oxygen Depletion Sensing (ODS) safety shutoff system. The ODS shuts down the heater if not enough fresh air is available. You must provide a minimum 10 square inches of ventilation air for adequate combustion.
9. If heater shuts off, do not relight until you provide fresh, outside air. If heater keeps shutting off, have it serviced.
10. Keep all air openings in front and bottom of heater clear and free of debris. This will insure enough air for proper combustion.
11. Do not use heater if any part has been under water. Immediately call a qualified service technician to inspect the room heater and to replace any part of the control system and any gas control which has been under water.
12. Turn off and let cool before servicing. Only a qualified service person should service and repair heater.
13. Operating heater above elevations of 4,500 feet could cause pilot outage.
14. Turn off propane/LP supply when not in use.
15. Check heater for damage before each use. Do not use a damaged heater.
16. Do not alter heater. Keep heater in its original state.
17. Do not use heater if altered.
18. This heater can only be used in a recreational or commercial enclosure with a window or roof vent. This heater is not for outdoor use.
19. **Before using the heater provide adequate ventilation. An area of 10 square inches of opening of a window or roof vent is needed for adequate combustion and ventilation air.**

## PRODUCT IDENTIFICATION

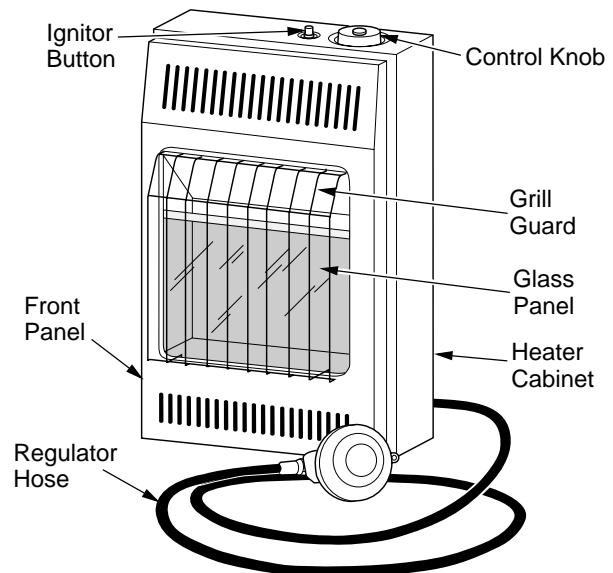

Figure 1 - Vent-Free Propane/LP Gas Heater

## UNPACKING

1. Remove heater from carton.
2. Remove all protective packaging applied to heater for shipment.
3. Check heater for any shipping damage. If heater is damaged, promptly return to dealer where you bought heater.

## LOCAL CODES

Install and use heater with care. Follow all local codes. In the absence of local codes, use the latest edition of *National Fuel Gas Code, ANSI Z223.1/NFPA 54\**.

\*Available from:

American National Standards Institute, Inc.  
 1430 Broadway  
 New York, NY 10018

National Fire Protection Association, Inc.  
 Batterymarch Park  
 Quincy, MA 02269

## PRODUCT FEATURES

### SAFETY PILOT

This heater has a pilot with an Oxygen Depletion Sensing (ODS) safety shutoff system. The ODS/pilot is a required feature for vent-free room heaters. The ODS/pilot shuts off the heater if there is not enough fresh air.

### PIEZO IGNITION SYSTEM

This heater has a piezo ignitor. This system requires no matches, batteries, or other sources to light heater.

## PROPANE/LP SUPPLY

Propane/LP gas and propane/LP tank(s) are to be furnished by the user. The propane/LP cylinder to be used must be constructed and marked in accordance with the specifications for the propane/LP gas cylinders of the U.S. Department of Transportation (DOT).

Use this heater only with a propane/LP vapor withdrawal supply system. See Chapter 5 of the *Standard for Storage and Handling of Liquefied Petroleum Gas, ANSI/NFPA 58 and/or CAN/CGA B149.2*. Your local library or fire department will have this booklet.

The amount of propane/LP gas ready for use from propane/LP tanks varies. Two factors decide this amount:

1. The amount of propane/LP gas in tank(s)
2. The temperature of tank(s)

This heater is designed for use with a 20 or 40 pound refillable propane/LP cylinder when used as a self contained heating system (with hose and regulator). Larger tanks may be used if installed in a permanent gas supply system.

The propane/LP cylinder used must include a collar to protect the cylinder valve, and a listed overfilling prevention device (OPD).

## INSTALLATION

### CHECK GAS TYPE

Use only propane/LP gas. If your gas supply is not propane/LP, do not install heater. Call dealer where you bought heater for proper type heater.

### LOCATING HEATER

**⚠ WARNING:** Maintain the minimum clearances shown in Figure 2. If you can, provide greater clearances from floor, ceiling, and joining wall.

**⚠ WARNING:** Never install the heater

- in a bathroom
- where curtains, furniture, clothing, or other flammable objects are less than 36 inches from the front, top, or sides of the heater
- as a fireplace insert
- in high traffic areas
- in windy or drafty areas

**⚠ CAUTION:** This heater creates warm air currents. These currents move heat to wall surfaces next to heater. Installing heater next to vinyl or cloth wall coverings or operating heater where impurities (such as, but not limited to, tobacco smoke, aromatic candles, cleaning fluids, oil or kerosene lamps, etc.) in the air exist, may discolor walls or cause odors.

**⚠ CAUTION:** If you install the heater in a home garage

- heater pilot and burner must be at least 18 inches above floor
- locate heater where moving vehicle will not hit it

For convenience and efficiency, install heater

- where there is easy access for operation, inspection, and service
- in coldest part of room

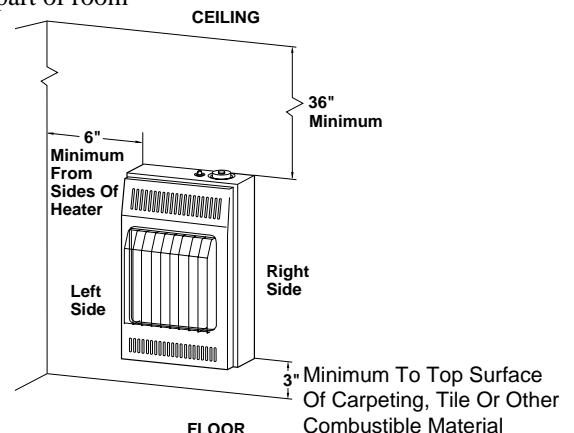

Figure 2 - Mounting Clearances As Viewed From Front of Heater

## INSTALLATION

### Continued

### THERMOSTAT SENSING BULB

The thermostat sensing bulb is located inside the heater. Do not move this bulb during installation or operation of the heater.

### INSTALLING HEATER TO WALL

#### Marking Screw Locations

1. Determine where you will locate heater.

**⚠ WARNING: Maintain minimum clearances shown in Figure 3. If you can, provide greater clearances from floor and joining wall.**

2. Mark two mounting screw locations on wall (see Figure 3).

#### Installing Two Mounting Screws

*Note:* Wall anchors and mounting screws are in hardware package. The hardware package is provided with heater.

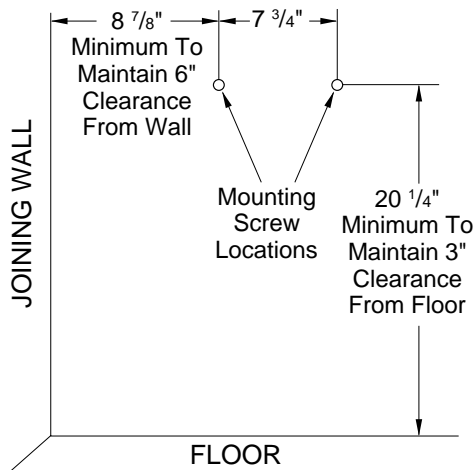

Figure 3 - Mounting Screw Locations

#### Attaching To Wall Stud Method

For attaching mounting screw to wall stud

1. Drill hole at marked location using 9/64" drill bit.
2. Insert mounting screw into wall stud.
3. Tighten screw until 1/16" space (thickness of penny) is between screwhead and wall.

#### Attaching To Wall Anchor Method

Follow instructions below to attach mounting screws to hollow walls (wall areas between studs) or solid walls (concrete or masonry).

1. Drill holes at marked locations using 5/16" drill bit. For solid walls (concrete or masonry), drill at least 1 1/4" deep.
2. Fold wall anchor (see Figure 4).

3. Insert wall anchor (wings first) into hole. Tap anchor flush to wall.
4. For thin walls (1/2" or less), insert red key into wall anchor. Push red key to "pop" open anchor wings (see Figure 5).

**IMPORTANT:** Do not hammer key! For thick walls (over 1/2" thick) or solid walls, do not pop open wings.

5. Tighten two screws until 1/16" space (thickness of penny) is between screwheads and wall (see Figure 6).

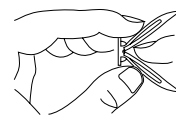

Figure 4 - Folding Anchor

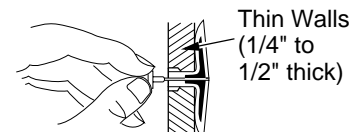

Figure 5 - Popping Open Anchor Wings For Thin Walls

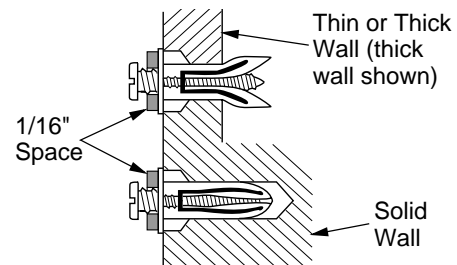

Figure 6 - Tightening Anchors

#### Placing Heater On Mounting Screws

1. Locate two keyhole slots on back panel of heater (see Figure 7).
2. Place large openings of slots over screwheads. Slide heater down until screws are in small portion of slots.

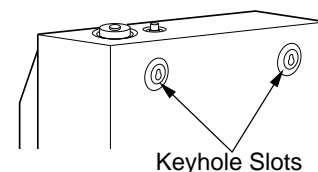

Figure 7 - Location Of Keyhole Slots On Back Panel Of Heater

#### Removing Front Panel Of Heater

1. Remove two screws near bottom corners of front panel.
2. Lift straight up on grill guard until it stops. Grill guard will slide up about 1/4".
3. Pull bottom of front panel forward, then down.

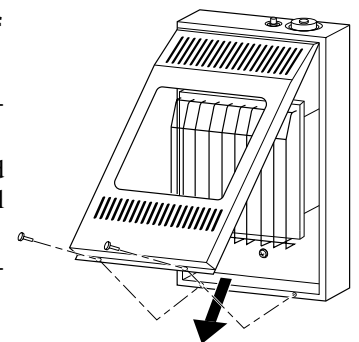

Figure 8 - Removing Front Panel Of Heater

## INSTALLATION

### Continued

#### Installing Bottom Mounting Screw

1. Locate bottom mounting hole. This hole is near bottom on back panel of heater (see Figure 9).
2. Mark screw location on wall.
3. Remove heater from wall.
4. If installing bottom mounting screw into hollow or solid wall, install wall anchor. Follow steps 1 through 5 under *Attaching To Wall Anchor Method*, page 5. If installing bottom mounting screw into wall stud, drill hole at marked location using 9/64" drill bit.
5. Replace heater on wall.
6. Insert bottom anchor screw through back panel into bottom anchor or drilled hole (see Figure 9).
7. Tighten screw until heater is firmly secured to wall. Do not over tighten.

**Note:** Do not replace front panel at this time. Replace front panel after making gas connections and checking for leaks (see pages 9 and 10).

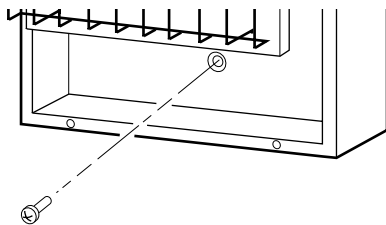

Figure 9 - Installing Bottom Mounting Screw

#### CONNECTING TO PORTABLE CYLINDER GAS SUPPLY

**WARNING:** Review and understand the warnings in the *Safety Information* section, page 2. They are needed to safely operate this heater. Follow all local codes when using this heater.

**WARNING:** Test all gas piping and connections for leaks after installation or servicing. Never use an open flame to check for a leak. Apply a noncorrosive leak detection fluid to all joints. Bubbles forming show a leak. Correct all leaks at once.

**WARNING:** Use pipe joint sealant that is resistant to liquid petroleum (LP) gas.

**IMPORTANT:** You must use a propane/LP gas supply cylinder that is compatible with the connection device provided with the hose and regulator.

1. Remove 90° gas fitting from hardware bag.
2. Apply pipe joint sealant lightly to male NPT threads (see Figure 10). This will prevent excess sealant from going into pipe. Excess sealant in pipe could result in clogged heater valves.
3. Hold gas pressure regulator with wrench when connecting the 90° gas fitting. Do not over tighten connection to regulator. The regulator body could be damaged.
4. Provide propane/LP supply system (see *Propane/LP Supply*, page 4).
5. Connect fuel gas fitting on hose/regulator assembly to propane/LP tank(s). Turn fuel gas fitting counterclockwise into threads on tank. Tighten firmly using a wrench. **IMPORTANT:** Position regulator so that hose leaving the regulator is in a horizontal position (see Figure 11). This places the regulator vent in the proper position to protect it from the weather.
6. Connect hose to heater inlet. Tighten firmly using a wrench. You must use the regulator supplied with heater.

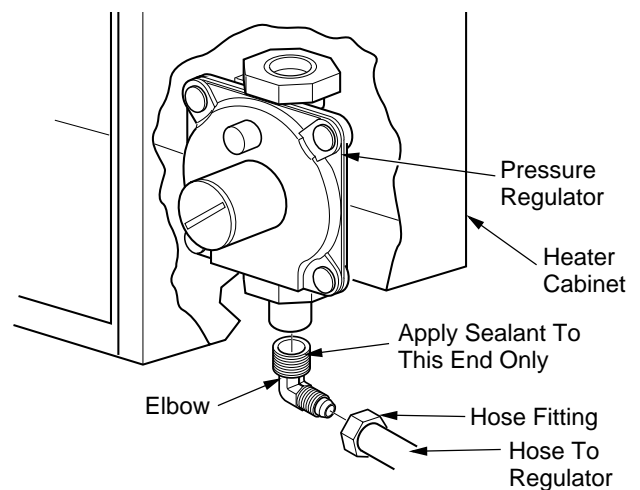

Figure 10 - Gas Connection

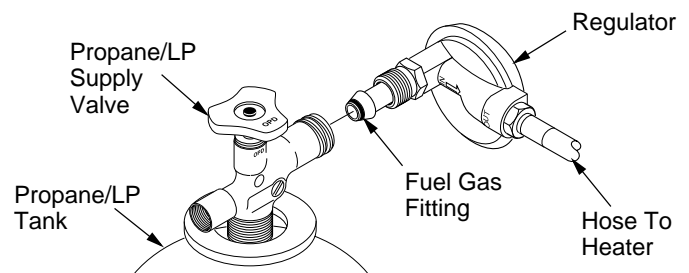

Figure 11 - Regulator Position

## INSTALLATION

### Continued

7. Open propane/LP supply valve on propane/LP tank(s) slowly.  
*Note:* If not opened slowly, excess-flow check valve on propane/LP tank may stop gas flow. If this happens, close propane/LP supply valve and open again slowly.
8. Check all connections for leaks. Apply a noncorrosive leak detection fluid to gas joints. Bubbles forming show a leak that must be corrected.
9. Close propane/LP supply valve.

### CONNECTING TO PERMANENT GAS SUPPLY

**⚠ WARNING:** This appliance requires a 3/8" NPT (National Pipe Thread) inlet connection to the pressure regulator.

**⚠ WARNING:** A qualified service person must connect heater to gas supply. Follow all local codes.

**⚠ CAUTION:** Never connect heater directly to the propane/LP supply. This heater requires an external regulator (not supplied). Install the external regulator between the heater and propane/LP supply.

#### Installation Items

Before installing heater, make sure you have the items listed below.

- external regulator (supplied by installer)
- piping (check local codes)
- sealant (resistant to propane/LP gas)
- equipment shutoff valve \*
- ground joint union
- test gauge connection \*
- sediment trap
- tee joint
- pipe wrench

\* A CSA design-certified equipment shutoff valve with 1/8" NPT tap is an acceptable alternative to test gauge connection. The optional CSA design-certified equipment shutoff valve can be purchased from your dealer. See *Accessories*, page 18.

If installing to a fixed fuel piping system, the installation must conform with local codes or, in the absence of local codes, with the *National Fuel Gas Code, ANSI Z223.1*.

If the heater will be connected to a permanent gas source, the installer must supply an external regulator. The external regulator will reduce incoming gas pressure. You must reduce incoming gas pressure to between 11 and 14 inches of water. If you do not reduce incoming gas pressure, heater regulator damage could occur. Install the external regulator with the vent pointing down as shown in Figure 12. Pointing the vent down protects it from freezing rain or sleet.

**⚠ CAUTION:** Use only new, black iron or steel pipe. Internally-tinned copper tubing may be used in certain areas. Check your local codes. Use pipe of large enough diameter to allow proper gas volume to heater. If pipe is too small, undue loss of volume will occur.

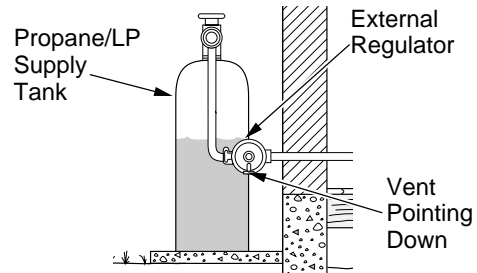

**Figure 12 - External Regulator With Vent Pointing Down**

Installation must include equipment shutoff valve, union, and plugged 1/8" NPT tap. Locate NPT tap within reach for test gauge hook up. NPT tap must be upstream from heater (see Figure 13, page 8).

**IMPORTANT:** Install an equipment shutoff valve in an accessible location. The equipment shutoff valve is for turning on or shutting off the gas to the appliance.

Apply pipe joint sealant lightly to male NPT threads. This will prevent excess sealant from going into pipe. Excess sealant in pipe could result in clogged heater valves.

**⚠ WARNING:** Use pipe joint sealant that is resistant to liquid petroleum (LP) gas.

## INSTALLATION

### Continued

### CONNECTING TO PERMANENT GAS SUPPLY (CONTINUED)

Install sediment trap in supply line as shown in Figure 13. Locate sediment trap where it is within reach for cleaning. Locate sediment trap where trapped matter is not likely to freeze. A sediment trap traps moisture and contaminants. This keeps them from going into heater controls. If sediment trap is not installed or is installed wrong, heater may not run properly.

**IMPORTANT:** Hold the pressure regulator with wrench when connecting it to gas piping and/or fittings. Do not over tighten pipe connection to regulator. The regulator body could be damaged.

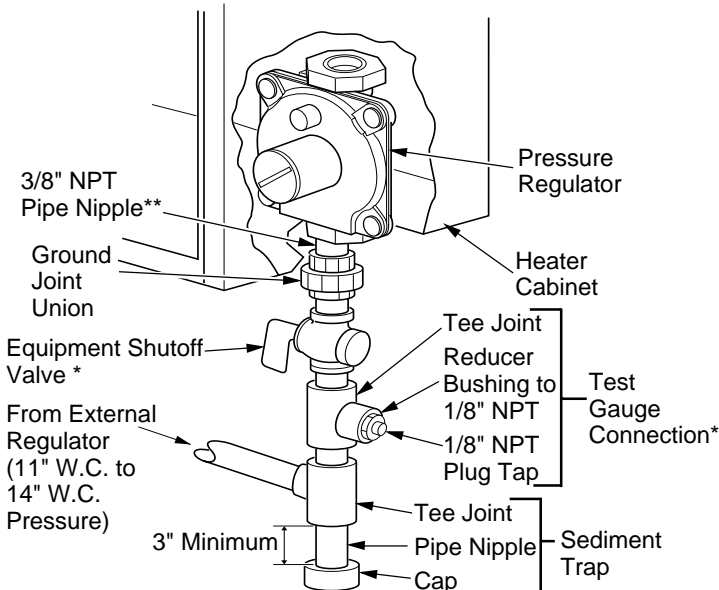

**Figure 13 - Gas Connection**

\* A CSA design-certified equipment shutoff valve with 1/8" NPT tap is an acceptable alternative to test gauge connection. Purchase the optional CSA design-certified equipment shutoff valve from your dealer. See *Accessories*, page 18.

\*\* The 90° elbow on the regulator is removed and the 3/8" NPT pipe nipple is installed in its place.

### CHECKING GAS CONNECTIONS FOR PERMANENT GAS SUPPLY

**WARNING:** Test all gas piping and connections for leaks after installing or servicing. Correct all leaks at once.

**WARNING:** Never use an open flame to check for a leak. Apply a noncorrosive leak detection fluid to all joints. Bubbles forming show a leak. Correct all leaks at once.

**CAUTION:** Make sure external regulator has been installed between propane/LP supply and heater. See guidelines under *Connecting to Permanent Gas Supply*, pages 7 and 8.

### Pressure Testing Gas Supply Piping System

#### Test Pressures In Excess Of 1/2 PSIG (3.5 kPa)

1. Disconnect appliance with its appliance main gas valve (control valve) and equipment shutoff valve from gas supply piping system. Pressures in excess of 1/2 psig will damage heater regulator.
2. Cap off open end of gas pipe where equipment shutoff valve was connected.
3. Pressurize supply piping system by opening propane/LP supply tank valve or using compressed air.
4. Check all joints of gas supply piping system. Apply a noncorrosive leak detection fluid to all joints. Bubbles forming show a leak.
5. Correct all leaks at once.
6. Reconnect heater and equipment shutoff valve to gas supply. Check reconnected fittings for leaks.

#### Test Pressures Equal To or Less Than 1/2 PSIG (3.5 kPa)

1. Close equipment shutoff valve (see Figure 14).
2. Pressurize supply piping system by either opening propane/LP supply tank valve or using compressed air.

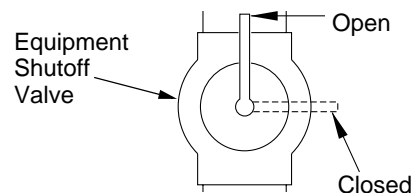

**Figure 14 - Equipment Shutoff Valve**



## INSTALLATION

### Continued

### CHECKING GAS CONNECTIONS FOR PERMANENT GAS SUPPLY (CONTINUED)

3. Check all joints from supply tank to equipment shutoff valve (see Figure 15). Apply a noncorrosive leak detection fluid to all joints. Bubbles forming show a leak.
4. Correct all leaks at once.

### Pressure Testing Heater Gas Connections

1. Open equipment shutoff valve (see Figure 14, page 8).
2. Open propane/LP supply tank valve.
3. Make sure control knob of heater is in the OFF position.
4. Check all joints from equipment shutoff valve to thermostat gas valve (see Figure 15). Apply a noncorrosive leak detection fluid to all joints. Bubbles forming show a leak.
5. Correct all leaks at once.
6. Light heater (see *Lighting Instructions*, pages 9 and 10). Check all other internal joints for leaks.
7. Turn off heater (see *To Turn Off Gas to Appliance*, page 10).
8. Replace front panel.

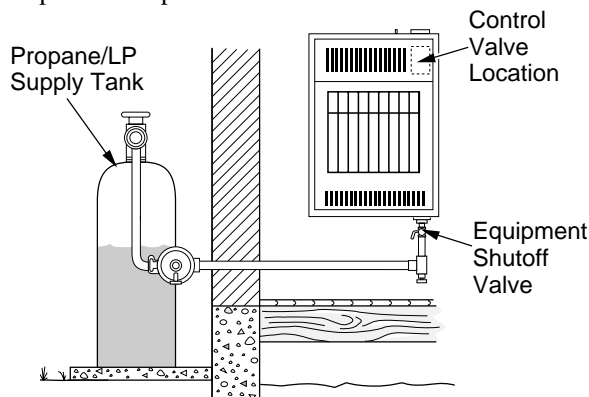

Figure 15 - Checking Gas Joints



## OPERATING HEATER

### FOR YOUR SAFETY READ BEFORE LIGHTING

**⚠ WARNING:** If you do not follow these instructions exactly, a fire or explosion may result causing property damage, personal injury or loss of life.

- A. This appliance has a pilot which must be lighted by hand. When lighting the pilot, follow these instructions exactly.
- B. **BEFORE LIGHTING** smell all around the appliance area for gas. Be sure to smell next to the floor because some gas is heavier than air and will settle on the floor.  
**WHAT TO DO IF YOU SMELL GAS**
  - Do not try to light any appliance.
  - Do not touch any electric switch; do not use any phone in your building.
  - Immediately call your gas supplier from a neighbor's phone. Follow the gas supplier's instructions.
  - If you cannot reach your gas supplier, call the fire department.
- C. Use only your hand to push in or turn the gas control knob. Never use tools. If the knob will not push in or turn by hand, don't try to repair it, call a qualified service technician or gas supplier. Force or attempted repair may result in a fire or explosion.
- D. Do not use this appliance if any part has been under water. Immediately call a qualified service technician to inspect the appliance and to replace any part of the control system and any gas control which has been under water.

### LIGHTING INSTRUCTIONS

1. **STOP!** Read the safety information above.
2. Make sure equipment shutoff valve is fully open.
3. Turn control knob clockwise  to the OFF position.
4. Wait five (5) minutes to clear out any gas. Then smell for gas, including near the floor. If you smell gas, **STOP!** Follow "B" in the safety information above. If you don't smell gas, go to the next step.
5. Turn control knob counterclockwise  to the PILOT position. Press in control knob for five (5) seconds (see Figure 16, page 10).

**Note:** You may be running this heater for the first time after hooking up to gas supply. If so, the control knob may need to be pressed in for 30 seconds or more. This will allow air to bleed from the gas system.

- If control knob does not pop up when released, contact a qualified service person or gas supplier for repairs.

## OPERATING HEATER

### Continued

6. With control knob pressed in, push down and release ignitor button. This will light pilot. The pilot is attached to the front of burner. The pilot can be seen through the glass panel. If needed, keep pressing ignitor button until pilot lights.

**Note:** If pilot does not stay lit, refer to *Troubleshooting*, pages 13 through 15. Also contact a qualified service person or gas supplier for repairs. Until repairs are made, light pilot with match. To light pilot with match, see *Manual Lighting Procedure*.

7. Keep control knob pressed in for 30 seconds after lighting pilot. After 30 seconds, release control knob.
- If control knob does not pop up when released, contact a qualified service person or gas supplier for repairs.

**Note:** If pilot goes out, repeat steps 3 through 7. This heater has a safety interlock system. Wait one (1) minute before lighting pilot again.

8. Turn control knob counterclockwise to desired heating level. The main burner should light. Set control knob to any heat level between HI and LO.

**CAUTION:** Do not try to adjust heating levels by using the equipment shutoff valve.

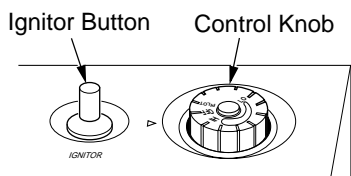

Figure 16 - Control Knob In The OFF Position

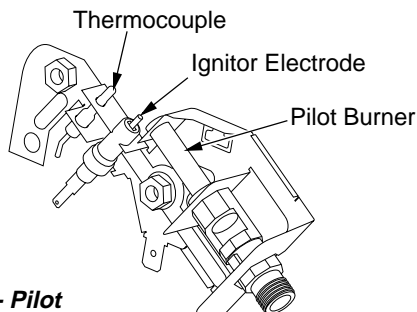

Figure 17 - Pilot

### TO TURN OFF GAS TO APPLIANCE

#### Shutting Off Heater

1. Turn control knob clockwise to the OFF position.
2. Turn off all electric power to the appliance if service is to be performed.

#### Shutting Off Burner Only (pilot stays lit)

Turn control knob clockwise to the PILOT position.

### THERMOSTAT CONTROL OPERATION

The thermostatic control used on these models differs from standard thermostats. Standard thermostats simply turn on and off the burner. The thermostat used on this heater senses the room temperature. The thermostat adjusts the amount of gas flow to the burner. This increases or decreases the burner flame height. At times the room may exceed the set temperature. If so, the burner will shut off. The burner will cycle back on when room temperature drops below the set temperature. The control knob can be set to any heat level between HI and LO. Selecting the HI setting will cause the burner to remain fully on without modulating down in most cases.

**Note:** The thermostat sensing bulb measures the temperature of air near the heater cabinet. This may not always agree with room temperature (depending on housing construction, installation location, room size, open air temperatures, etc.). Frequent use of your heater will let you determine your own comfort levels.

### MANUAL LIGHTING PROCEDURE

1. Remove front panel (see Figure 8, page 5).
2. Follow steps 1 through 5 under *Lighting Instructions*, page 9.
3. With control knob pressed in, strike match. Hold match to pilot until pilot lights.
4. Keep control knob pressed in for 30 seconds after lighting pilot. After 30 seconds, release control knob. Follow step 8 under *Lighting Instructions*.
5. Replace front panel.

## INSPECTING BURNER

Check pilot flame pattern and burner flame pattern often.

### PILOT FLAME PATTERN

Figure 18 shows a correct pilot flame pattern. Figure 19 shows an incorrect pilot flame pattern. The incorrect pilot flame is not touching the thermocouple. This will cause the thermocouple to cool. When the thermocouple cools, the heater will shut down.

If pilot flame pattern is incorrect, as shown in Figure 19

- turn heater off (see *To Turn Off Gas to Appliance*, page 10)
- see *Troubleshooting*, pages 13 through 15

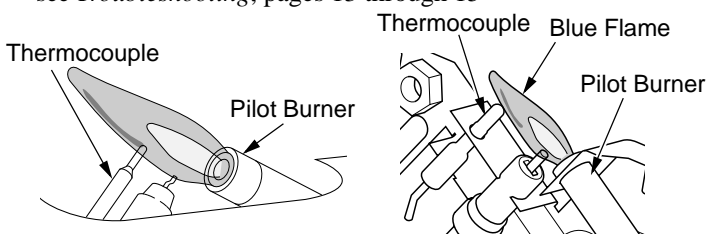

Figure 18 - Correct Pilot Flame Pattern

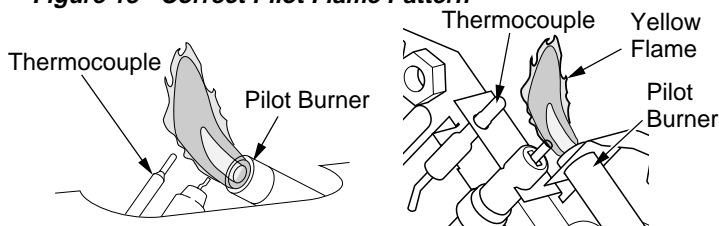

Figure 19 - Incorrect Pilot Flame Pattern

### BURNER FLAME PATTERN

Figure 20 shows a correct burner flame pattern. Figure 21 shows an incorrect burner flame pattern. The incorrect burner flame pattern shows yellow tipping of the flame. It also shows the flame higher than 1/2 the glass panel height.

**WARNING:** If yellow tipping occurs, your heater could produce increased levels of carbon monoxide. If burner flame pattern shows yellow tipping, see the following instructions.

**NOTICE:** Do not mistake orange flames with yellow tipping. Dust or other fine particles enter the heater and burn causing brief patches of orange flame.

If burner flame pattern is incorrect, as shown in Figure 23

- turn heater off (see *To Turn Off Gas to Appliance*, page 10)
- see *Troubleshooting*, pages 13 through 15

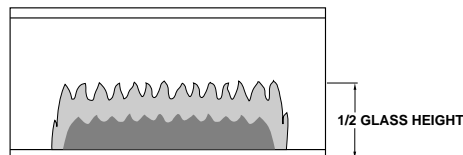

Figure 20 - Correct Burner Flame Pattern

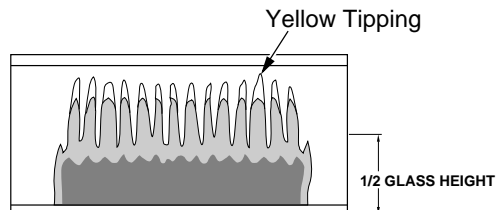

Figure 21 - Incorrect Burner Flame Pattern

## STORAGE

**CAUTION:** Disconnect heater from propane/LP supply tank(s).

When the propane/LP supply cylinder is not disconnected from the heater, the heater and the cylinder must be stored outdoors, in a well ventilated space, out of reach of children. Do not store in a building, garage or any other enclosed area.

Storage of the heater is permissible only if the cylinder is disconnected and removed from the heater. Cylinders must be stored outdoors out of reach of children. Do not store in a building, garage or any other enclosed area.

1. Store propane tank(s) in safe manner. See Chapter 5 of *Standard for Storage and Handling of Liquefied Petroleum Gases, ANSI/NFPA 58*. Follow all local codes. Always store propane tanks outdoors.
2. Place plastic cover caps over brass fittings on inlet connector and hose/regulator assembly.
3. Store in dry, clean, and safe place. Do not store hose/regulator assembly inside heater combustion chamber.
4. When taking heater out of storage, always check inside of heater. Insects and small animals may place foreign objects in heater.

## CLEANING AND MAINTENANCE

**⚠ WARNING:** Turn off heater and let cool before cleaning.

**⚠ CAUTION:** You must keep control areas, burner, and circulating air passageways of heater clean. Inspect these areas of heater before each use. Have heater inspected yearly by a qualified service person.

**⚠ CAUTION:** You must check and keep burner/venturi tubes clean of insect and insect nest. A clogged tube can lead to a fire.

### ODS/PILOT AND BURNER

- Use a vacuum cleaner, pressurized air, or small, soft bristled brush to clean.

### CLEANING BURNER PILOT AIR INLET

The primary air inlet holes allow the proper amount of air to mix with the gas. This provides a clean burning flame. Keep these holes clear of dust, dirt, and lint. Clean these air inlet holes prior to each heating season. Blocked air holes will create soot. We recommend that you clean the unit every three months during operation and have heater inspected yearly by a qualified service person.

We also recommend that you keep the burner tube and pilot assembly clean and free of dust and dirt. To clean these parts we recommend using compressed air no greater than 30 PSI. Your local computer store, hardware store, or home center may carry compressed air in a can. You can use a vacuum cleaner in the blow position. If using compressed air in a can, please follow the directions on the can. If you don't follow directions on the can, you could damage the pilot assembly.

1. Shut off the unit, including the pilot. Allow the unit to cool for at least thirty minutes.
2. Inspect burner, pilot for dust and dirt.
3. Blow air through the ports/slots and holes in the burner.
4. Never insert objects into the pilot tube.

Clean the pilot assembly also. A yellow tip on the pilot flame indicates dust and dirt in the pilot assembly. There is a small pilot air inlet about two inches from where the pilot flame comes out of the pilot assembly (see Figure 22). With the unit off, lightly blow air through the air inlet. You may blow through a drinking straw if compressed air is not available.

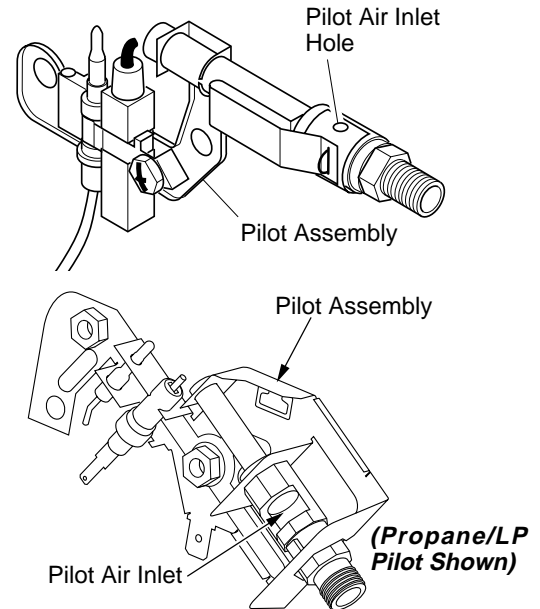

Figure 22 - Pilot Inlet Air Hole

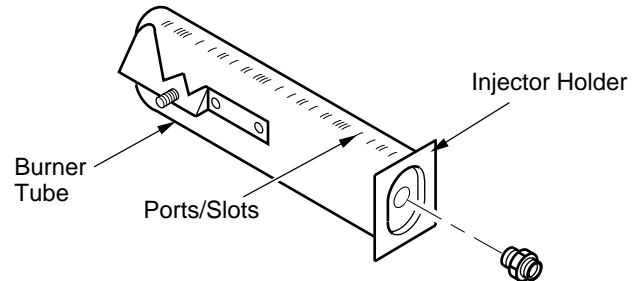

Figure 23 - Injector Holder On Burner Tube

### CABINET

#### Air Passageways

- Use a vacuum cleaner or pressurized air to clean.

#### Exterior

- Use a soft cloth dampened with a mild soap and water mixture. Wipe the cabinet to remove dust.

## TROUBLESHOOTING

*Note:* All troubleshooting items are listed in order of operation.

**⚠ WARNING:** Turn off heater and let cool before servicing. Only a qualified service person should service and repair heater.

**⚠ CAUTION:** Never use a wire, needle, or similar object to clean ODS/pilot. This can damage ODS/pilot unit.

OBSERVED PROBLEM	POSSIBLE CAUSE	REMEDY
When ignitor button is pressed, there is no spark at ODS/pilot	<ol style="list-style-type: none"> <li>1. Ignitor electrode positioned wrong</li> <li>2. Ignitor electrode broken</li> <li>3. Ignitor electrode not connected to ignitor cable</li> <li>4. Ignitor cable pinched or wet</li> <li>5. Piezo ignitor nut is loose</li> <li>6. Broken ignitor cable</li> <li>7. Bad piezo ignitor</li> </ol>	<ol style="list-style-type: none"> <li>1. Replace pilot assembly</li> <li>2. Replace pilot assembly</li> <li>3. Reconnect ignitor cable</li> <li>4. Free ignitor cable if pinched by any metal or tubing. Keep ignitor cable dry</li> <li>5. Tighten nut holding piezo ignitor to heater cabinet. Nut is located inside heater cabinet at top</li> <li>6. Replace ignitor cable</li> <li>7. Replace piezo ignitor</li> </ol>
When ignitor button is pressed, there is spark at ODS/pilot but no ignition	<ol style="list-style-type: none"> <li>1. Gas supply turned off or equipment shutoff valve closed</li> <li>2. Control knob not in PILOT position</li> <li>3. Control knob not pressed in while in PILOT position</li> <li>4. Air in gas lines when installed</li> <li>5. ODS/pilot is clogged</li> <li>6. Gas regulator setting is not correct</li> </ol>	<ol style="list-style-type: none"> <li>1. Turn on gas supply or open equipment shutoff valve</li> <li>2. Turn control knob to PILOT position</li> <li>3. Press in control knob while in PILOT position</li> <li>4. Continue holding down control knob. Repeat igniting operation until air is removed</li> <li>5. Clean ODS/pilot (see <i>Cleaning and Maintenance</i>, page 12) or replace ODS/pilot assembly</li> <li>6. Replace gas regulator</li> </ol>
ODS/pilot lights but flame goes out when control knob is released	<ol style="list-style-type: none"> <li>1. Control knob not fully pressed in</li> <li>2. Control knob not pressed in long enough</li> <li>3. Safety interlock system has been triggered</li> <li>4. Equipment shutoff valve not fully open</li> <li>5. Thermocouple connection loose at control valve</li> <li>6. Pilot flame not touching thermocouple, which allows thermocouple to cool, causing pilot flame to go out. This problem could be caused by one or both of the following: <ol style="list-style-type: none"> <li>A) Low gas pressure</li> <li>B) Dirty or partially clogged ODS/pilot</li> </ol> </li> <li>7. Thermocouple damaged</li> <li>8. Control valve damaged</li> </ol>	<ol style="list-style-type: none"> <li>1. Press in control knob fully</li> <li>2. After ODS/pilot lights, keep control knob pressed in 30 seconds</li> <li>3. Wait one minute for safety interlock system to reset. Repeat ignition operation.</li> <li>4. Fully open equipment shutoff valve</li> <li>5. Hand tighten until snug, then tighten 1/4 turn more</li> <li>6. A) Contact local propane/LP gas company B) Clean ODS/pilot (see <i>Cleaning and Maintenance</i>, page 12) or replace ODS/pilot assembly</li> <li>7. Replace pilot assembly</li> <li>8. Replace control valve</li> </ol>

## TROUBLESHOOTING

*Continued*

OBSERVED PROBLEM	POSSIBLE CAUSE	REMEDY
Burner does not light after ODS/pilot is lit	<ol style="list-style-type: none"> <li>1. Burner orifice is clogged</li> <li>2. Inlet gas pressure is too low</li> </ol>	<ol style="list-style-type: none"> <li>1. Clean burner orifice (see <i>Cleaning and Maintenance</i>, page 12) or replace burner orifice</li> <li>2. Contact local propane/LP gas company</li> </ol>
Delayed ignition of burner	<ol style="list-style-type: none"> <li>1. Manifold pressure is too low</li> <li>2. Burner orifice is clogged</li> </ol>	<ol style="list-style-type: none"> <li>1. Contact local propane/LP gas company</li> <li>2. Clean burner orifice (see <i>Cleaning and Maintenance</i>, page 12) or replace burner orifice</li> </ol>
Burner backfiring during combustion	<ol style="list-style-type: none"> <li>1. Burner orifice is clogged or damaged</li> <li>2. Inlet gas pressure is too low</li> <li>3. Burner damaged</li> <li>4. Gas regulator defective</li> </ol>	<ol style="list-style-type: none"> <li>1. Clean burner orifice (see <i>Cleaning and Maintenance</i>, page 12) or replace burner orifice</li> <li>2. Contact local propane/LP gas company</li> <li>3. Replace burner</li> <li>4. Replace gas regulator</li> </ol>
Yellow flame during burner combustion	<ol style="list-style-type: none"> <li>1. Not enough air</li> <li>2. Inlet gas pressure is too low</li> <li>3. Gas regulator defective</li> </ol>	<ol style="list-style-type: none"> <li>1. Check burner for dirt and debris. If found, clean burner (see <i>Cleaning and Maintenance</i>, page 12)</li> <li>2. Contact local propane/LP gas company</li> <li>3. Replace gas regulator</li> </ol>
Slight smoke or odor during initial operation	<ol style="list-style-type: none"> <li>1. Residues from manufacturing processes</li> </ol>	<ol style="list-style-type: none"> <li>1. Problem will stop after a few hours of operation</li> </ol>
Heater produces a whistling noise when burner is lit	<ol style="list-style-type: none"> <li>1. Turn control knob to HI position when burner is cold</li> <li>2. Air in gas line</li> <li>3. Air passageways on heater blocked</li> <li>4. Dirty or partially clogged burner orifice</li> </ol>	<ol style="list-style-type: none"> <li>1. Turn control knob to LO position and let warm up for a minute</li> <li>2. Operate burner until air is removed from line. Have gas checked by local propane/LP gas company</li> <li>3. Observe minimum installation clearances (see Figure 2, page 4)</li> <li>4. Clean burner (see <i>Cleaning and Maintenance</i>, page 12) or replace burner orifice</li> </ol>

## TROUBLESHOOTING

### Continued

- ⚠ WARNING: If you smell gas**
- **Shut off gas supply.**
  - **Do not try to light any appliance.**
  - **Do not touch any electrical switch; do not use any phone in your building.**
  - **Immediately call your gas supplier from a neighbor's phone. Follow the gas supplier's instructions.**
  - **If you cannot reach your gas supplier, call the fire department.**

*IMPORTANT:* Operating heater where impurities in air exist may create odors. Cleaning supplies, paint, paint remover, cigarette smoke, cements and glues, new carpet or textiles, etc., create fumes. These fumes may mix with combustion air and create odors.

OBSERVED PROBLEM	POSSIBLE CAUSE	REMEDY
Heater produces a clicking/ticking noise just after burner is lit or shut off	1. Metal expanding while heating or contracting while cooling	1. This is common with most heaters. If noise is excessive, contact qualified service person
Heater produces unwanted odors	1. Heater burning vapors from paint, hair spray, glues, etc. See <i>IMPORTANT</i> statement above 2. Low fuel supply 3. Gas leak. <b>See Warning statement at top of page</b>	1. Ventilate room. Stop using odor-causing products while heater is running 2. Refill supply tank 3. Locate and correct all leaks (see <i>Checking Gas Connections for Permanent Gas Supply</i> , page 9)
Heater shuts off in use (ODS operates)	1. Not enough fresh air is available 2. Low line pressure 3. ODS/pilot is partially clogged	1. Open window and/or door for ventilation 2. Contact local propane/LP gas company 3. Clean ODS/pilot (see <i>Cleaning and Maintenance</i> , page 12)
Gas odor even when control knob is in OFF position	1. Gas leak. <b>See Warning statement at top of page</b> 2. Control valve defective	1. Locate and correct all leaks (see <i>Checking Gas Connections for Permanent Gas Supply</i> , page 9) 2. Replace control valve
Gas odor during combustion	1. Foreign matter between control valve and burner 2. Gas leak. <b>See Warning statement at top of page</b>	1. Take apart gas tubing and remove foreign matter 2. Locate and correct all leaks (see <i>Checking Gas Connections for Permanent Gas Supply</i> , page 9)
Moisture/condensation noticed on windows	1. Not enough combustion/ventilation air	1. Provide more combustion area. A minimum 10 square inches of ventilation air must be provided for adequate combustion.

ILLUSTRATED PARTS  
BREAKDOWN

REM10PT

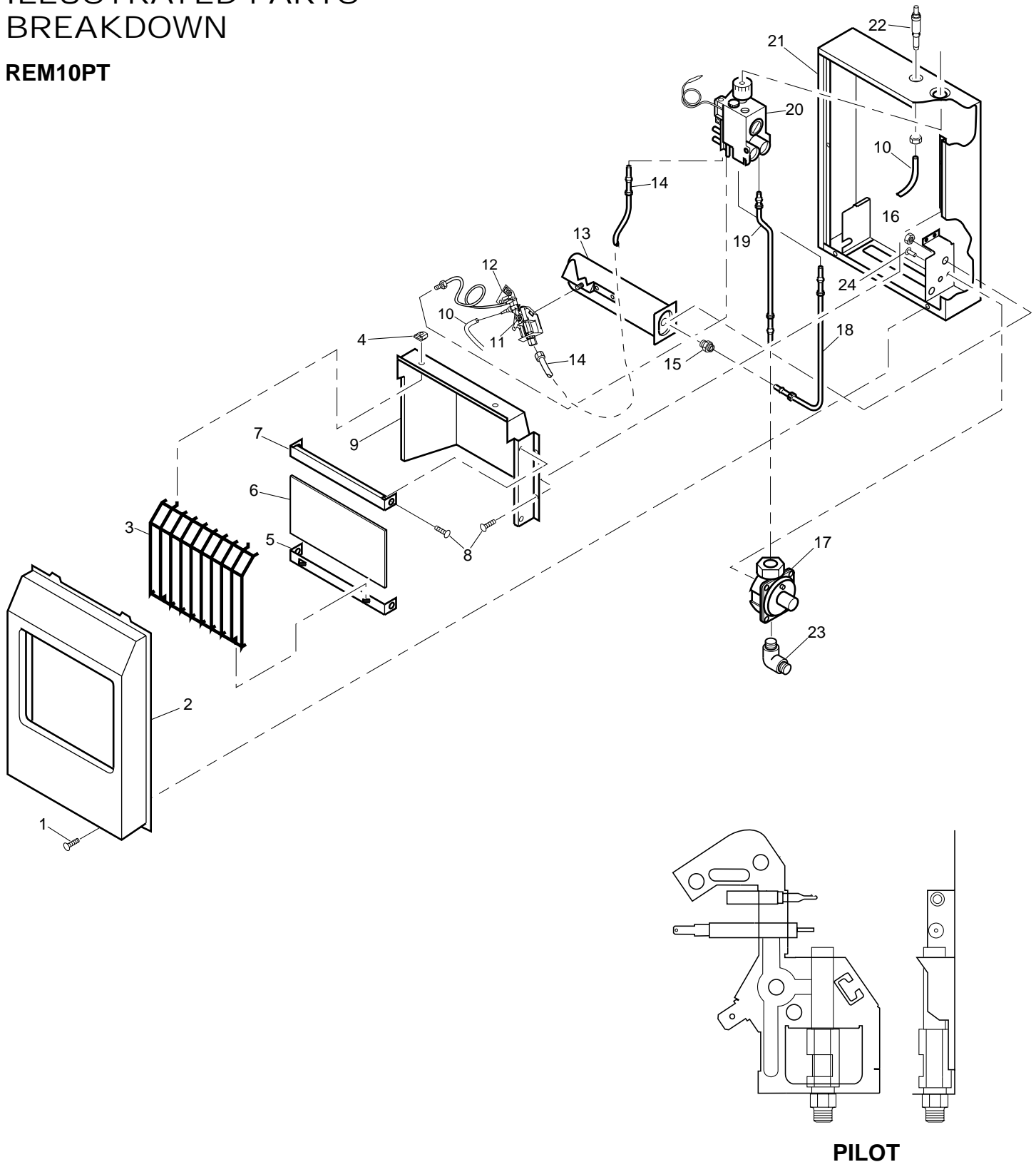
For more information, visit [www.desatech.com](http://www.desatech.com)



## PARTS LIST

## REM10PT

This list contains replaceable parts used in your heater. When ordering parts, follow the instructions listed under *Replacement Parts* on page 18 of this manual.

KEY NO.	PART NUMBER	DESCRIPTION	QTY.
1	098304-01	Screw, #10 x 3/8"	2
2	099467-03	Front Panel Assembly	1
3	099318-04	Grill Guard	1
4	101108-01	Grill Guard Clip	2
5	102017-02	Bottom Glass Retainer	1
6	098260-11	Glass Panel	1
7	098532-06AA	Top Glass Retainer	1
8	M11084-38	Screw, #8 x 3/8"	8
9	099317-02	Deflector Unit	1
10	098271-09	Ignitor Cable	1
11	098249-01	Nut, M5	2
12	107667-02	ODS/Pilot Assembly	1
13	104263-01	Burner	1
14	099387-11	Pilot Tubing	1
15	104259-06	Injector, 1 Piece	1
16	NJF-8C	Hex Nut	1
17	099415-13	Pressure Regulator	1
18	104261-01	Burner Tubing	1
19	104264-01	Regulator Tubing	1
20	098522-18	Thermostat Gas Valve	1
21	**	Cabinet	1
22	097159-04	Piezo Ignitor	1
23	110701-01	Elbow Fitting	1
24	098303-02	Screw, #6 x 5/16"	2
<b>PARTS AVAILABLE - NOT SHOWN</b>			
	102471-01	Control Position Label	1
	100642-02	Assembly, Hardware	1
	LPA3090	Hose/Regulator Assembly	1

\*\* Not a field replaceable part.

## SPECIFICATIONS

	<b>REM10PT</b>
Btu(Variable)	5,000/10,000
Type Gas	Propane/LP Only
Ignition	Piezo
Internal Regulator Setting	8" W.C.
Inlet Gas Pressure to Heater (inches of water)	14" Max. / 11" Min.
Supply Pressure to Regulator	
Min (for input adjustment)	10 psi
Max	200 psi
Heater Dimensions	
(Includes knobs and grill)	21.5" (H) x 13.5" (W) x 7" (D)
Shipping Weight (pounds)	21

## TECHNICAL SERVICE

You may have further questions about installation, operation, or troubleshooting. If so, contact DESA International's Technical Service Department at 1-866-672-6040. When calling please have your model and serial numbers of your heater ready.

You can also visit DESA International's technical service web site at [www.desatech.com](http://www.desatech.com).

## SERVICE HINTS

### When Gas Pressure Is Too Low

- pilot will not stay lit
- burner will have delayed ignition
- heater will not produce specified heat
- propane/LP gas supply may be low

You may feel your gas pressure is too low. If so, contact your local propane/LP gas supplier.

## SERVICE PUBLICATIONS

You can purchase a service manual from the address listed on the back page of this manual. Send a check for \$5.00 payable to DESA International.

## ACCESSORIES

Purchase this heater accessory from your local dealer. If they cannot supply this accessory, call DESA International at 1-866-672-6040 for referral information. You can also write to the address listed on the back page of this manual.

Part Number	Description
<b>LPA3090</b>	<b>Hose/Regulator Assembly</b> U.L. listed.
<b>LPA4020</b>	<b>Fuel Gas Connector</b> Connects regulator to all standard propane tanks. U.L. and A.G.A. listed.

## REPLACEMENT PARTS

*Note:* Use only original replacement parts. This will protect your warranty coverage for parts replaced under warranty.

### PARTS UNDER WARRANTY

Contact authorized dealer from whom you purchased this product. If they cannot supply original replacement part(s), call DESA International's Technical Service Department at 1-866-672-6040 for referral information. When contacting your dealer or DESA International, have ready:

- your name and address
- model and serial numbers of your heater
- how heater was malfunctioning
- type of gas used (propane/LP or natural gas)
- purchase date

Usually, we will ask you to return the part to the factory.

### PARTS NOT UNDER WARRANTY

Contact authorized dealers of this product. If they cannot supply original replacement part(s), call DESA International at 1-866-672-6040 for referral information. When calling DESA International, have ready:

- model number of your heater
- the replacement part number

# OWNER'S REGISTRATION FORM

In order to provide better customer service for this and future purchases, we recommend that you register your product with us. You can register online at [www.desatech.com](http://www.desatech.com). If access to our website is not available to you, please complete this Owner's Registration Form and mail to the address on the back of this owner's manual. Please provide the following product information:

Brand: \_\_\_\_\_ (Comfort Glow, Vanguard, etc.)  
 Model: \_\_\_\_\_ (EFP33PR, VTGH33NR, etc.)  
 Date Purchased: \_\_\_\_\_ *Note: Keep receipt for warranty verification.*  
 Serial Number: \_\_\_\_\_ 7 or 9 digit number located on product or identification tag.  
 First Name: \_\_\_\_\_ Last Name: \_\_\_\_\_  
 Address: \_\_\_\_\_  
 City: \_\_\_\_\_ State: \_\_\_\_\_ Zip: \_\_\_\_\_ Country: \_\_\_\_\_  
 Home Phone: (\_\_\_\_) \_\_\_\_\_ - \_\_\_\_\_  
 E-Mail: \_\_\_\_\_

Please answer the following questions to register your product with DESA International:

1. If you bought this product yourself, did you plan to purchase this type of product before going into the store?  Yes  No
2. Who selected the product?  Male  Female  Both
3. What is the population of your area?  Under 10,000  10,000 to 25,000  25,000 to 50,000  50,000 to 100,000  
 100,000 to 250,000  Over 250,000
4. What is your primary source of heat?  Propane (LP Gas)  Fuel Oil  Wood  Other
5. How was the product installed?  Professional Installer  Self  Other
6. Cost of product excluding sales tax? \$ \_\_\_\_\_
7. Cost to install product? \$ \_\_\_\_\_
8. Type of store where product was purchased?  Hardware  Propane Dealer  Natural Gas/Utility Co.  Home Center/Builder's Supply  
 Farm Store  Other
9. What motivated you to buy this product?  Sudden Cold Weather  Replace Older Model  
 Heater was on Sale  Energy Savings/High Efficiency  Other
10. How did you learn about this product brand?  Advertising  Relative or Friend  Store Display  Other \_\_\_\_\_
11. Level of Education of Purchaser:  Some High School  Completed High School  Completed College  Completed Graduate School
12. Age of Purchaser:  Under 20  20 - 29  30 - 39  40 - 49  50 - 59  60 or Over
13. Buyer's total annual household income:  Under \$15,000  \$15,000 to \$19,999  \$20,000 to \$34,999  \$35,000 to \$49,999  
 \$50,000 to \$74,999  \$75,000 to \$99,999  \$100,000 and Over
14. Store where product was purchased:  
 Name: \_\_\_\_\_  
 City: \_\_\_\_\_ State: \_\_\_\_\_
15. In choosing this product, how important were the following:

	Not Important	Somewhat Important	Very Important
Availability	<input type="radio"/>	<input type="radio"/>	<input type="radio"/>
Price	<input type="radio"/>	<input type="radio"/>	<input type="radio"/>
Brand Name	<input type="radio"/>	<input type="radio"/>	<input type="radio"/>
Overall Quality	<input type="radio"/>	<input type="radio"/>	<input type="radio"/>
Heat Output	<input type="radio"/>	<input type="radio"/>	<input type="radio"/>
Made in USA	<input type="radio"/>	<input type="radio"/>	<input type="radio"/>
Warranty	<input type="radio"/>	<input type="radio"/>	<input type="radio"/>
Local Service	<input type="radio"/>	<input type="radio"/>	<input type="radio"/>
Value for Price	<input type="radio"/>	<input type="radio"/>	<input type="radio"/>
Prior Brand Experience	<input type="radio"/>	<input type="radio"/>	<input type="radio"/>
Controls Location	<input type="radio"/>	<input type="radio"/>	<input type="radio"/>
Thermostat, Remote, or Manual Operation	<input type="radio"/>	<input type="radio"/>	<input type="radio"/>
Ease of Operation	<input type="radio"/>	<input type="radio"/>	<input type="radio"/>
Special Features	<input type="radio"/>	<input type="radio"/>	<input type="radio"/>
Salesperson's Recommendation	<input type="radio"/>	<input type="radio"/>	<input type="radio"/>
Friend/Relative's Recommendation	<input type="radio"/>	<input type="radio"/>	<input type="radio"/>
Portability	<input type="radio"/>	<input type="radio"/>	<input type="radio"/>
Quiet Operation	<input type="radio"/>	<input type="radio"/>	<input type="radio"/>

TAPE

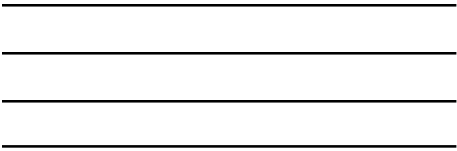

Postage  
Required

**DESA**<sup>TM</sup>  
**INTERNATIONAL**  
2701 Industrial Drive  
P.O. Box 90004  
Bowling Green, KY 42102-9004



# WARRANTY INFORMATION

KEEP THIS WARRANTY

Model _____
Serial No. _____
Date Purchased _____

Always specify model and serial numbers when communicating with the factory.

We reserve the right to amend these specifications at any time without notice. The only warranty applicable is our standard written warranty. We make no other warranty, expressed or implied.

## LIMITED WARRANTY VENT-FREE GAS HEATERS

DESA International warrants this product to be free from defects in materials and components for two (2) years from the date of first purchase, provided that the product has been properly installed, operated and maintained in accordance with all applicable instructions. To make a claim under this warranty the Bill of Sale or cancelled check must be presented.

This warranty is extended only to the original retail purchaser. This warranty covers the cost of part(s) required to restore this heater to proper operating condition and an allowance for labor when provided by a DESA Authorized Service Center. Warranty part(s) MUST be obtained through authorized dealers of this product and/or DESA International who will provide original factory replacement parts. Failure to use original factory replacement parts voids this warranty. The heater MUST be installed by a qualified installer in accordance with all local codes and instructions furnished with the unit.

This warranty does not apply to parts that are not in original condition because of normal wear and tear, or parts that fail or become damaged as a result of misuse, accidents, lack of proper maintenance or defects caused by improper installation. Travel, diagnostic cost, labor, transportation and any and all such other costs related to repairing a defective heater will be the responsibility of the owner.

TO THE FULL EXTENT ALLOWED BY THE LAW OF THE JURISDICTION THAT GOVERNS THE SALE OF THE PRODUCT; THIS EXPRESS WARRANTY EXCLUDES ANY AND ALL OTHER EXPRESSED WARRANTIES AND LIMITS THE DURATION OF ANY AND ALL IMPLIED WARRANTIES, INCLUDING WARRANTIES OF MERCHANTABILITY AND FITNESS FOR A PARTICULAR PURPOSE TO TWO (2) YEARS ON ALL COMPONENTS FROM THE DATE OF FIRST PURCHASE; AND DESA INTERNATIONAL'S LIABILITY IS HEREBY LIMITED TO THE PURCHASE PRICE OF THE PRODUCT AND DESA INTERNATIONAL SHALL NOT BE LIABLE FOR ANY OTHER DAMAGES WHATSOEVER INCLUDING INDIRECT, INCIDENTAL OR CONSEQUENTIAL DAMAGES.

Some states do not allow a limitation on how long an implied warranty lasts or an exclusion or limitation of incidental or consequential damages, so the above limitation on implied warranties, or exclusion or limitation on damages may not apply to you.

This warranty gives you specific legal rights, and you may also have other rights that vary from state to state.

For information about this warranty write:

**DESA**<sup>TM</sup>  
INTERNATIONAL  
2701 Industrial Drive  
P.O. Box 90004  
Bowling Green, KY 42102-9004  
www.desatech.com

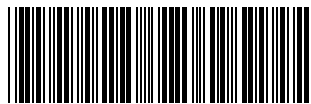

110373 01

NOT A UPC

110373-01  
Rev. B  
09/02

For more information, visit [www.desatech.com](http://www.desatech.com)

## Free Manuals Download Website

<http://myh66.com>

<http://usermanuals.us>

<http://www.somanuals.com>

<http://www.4manuals.cc>

<http://www.manual-lib.com>

<http://www.404manual.com>

<http://www.luxmanual.com>

<http://aubethermostatmanual.com>

Golf course search by state

<http://golfingnear.com>

Email search by domain

<http://emailbydomain.com>

Auto manuals search

<http://auto.somanuals.com>

TV manuals search

<http://tv.somanuals.com>