

Operating Instructions



Important:

Read this manual and all labels carefully before operating your powder actuated tool. This manual should always accompany the tool and be transferred with it upon change of ownership.

INDEX

Warning: Safety Precautions	3-11
Why A Fastener Holds	12
Selecting Fasteners and Power Loads	13
Operation	14
Parts List	16
Cleaning and Maintenance	17
Tool Disassembly	18
Tool Assembly	21
Troubleshooting	23
Fasteners	24
Application Chart	24
Parts Central	26
Warranty	Back Cover

REMINGTON

Powerdriver Model 491

The Remington Powerdriver Model 491 is designed for use with Remington 27 caliber power load strips and Remington power fasteners which are no longer than 2 1/2"*. Remington power fasteners are manufactured from special steel and heat treated to produce a very hard yet ductile fastener.

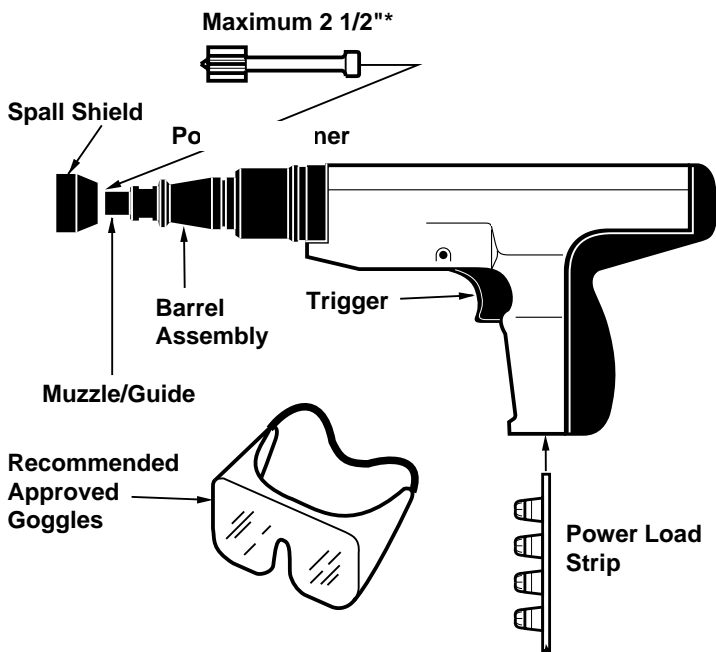

* 3" fasteners can be used with optional guide, part number 301110.

Warning: Safety Precautions

IMPORTANT: Read these operating instructions carefully and completely before trying to operate or service this tool. Improper use of this tool can cause serious injury or death from firing fastener into body or from flying debris. We expressly disclaim any liability for any injury to persons or damage to property which result from your failure to take the precautions contained in this manual.

WARNING: This tool is designed only for use by qualified operators. Qualification is obtained through a thorough understanding of the Safety Warnings and operating instructions as defined in this operating manual. **NOTE:** Your local labor regulations may require that the operator of this tool on a job site be thoroughly trained and certified for competence prior to operating this tool. For certification procedures, call: 1-800-626-2237 (U.S.A.) or 1-905-826-8010 (Canada).

BEFORE USING

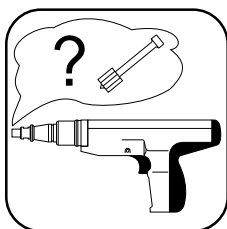
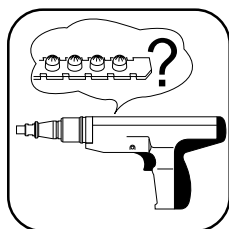

1. Always handle the tool as if it were loaded. Before starting work, check that the tool is unloaded and the muzzle is clear. Never load a tool unless it is going to be used.

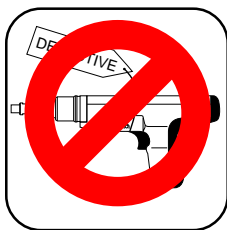
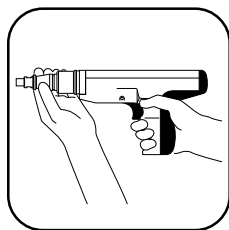

2. Always inspect to make sure the tool is working properly. If the tool does not work properly, remove from service and tag "DEFECTIVE." Do not use the tool again until it has been properly repaired.



3. Operators and bystanders must wear goggles and ear protection which meet or exceed the accepted standards for adequate protection in your country. In the U.S.A., refer to ANSI standards. In Canada, refer to CSA standards.

Safety Precautions

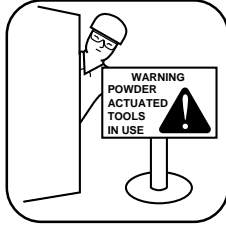

4. Always clear the work area on all sides and post appropriate warning signs on job sites.

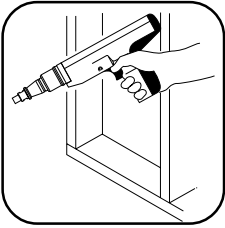

5. Make sure the work area is clean from loose material and debris.

HANDLING THE TOOL

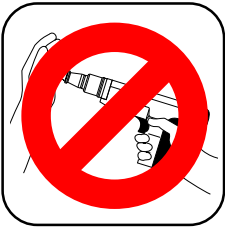

1. Never place your hand over the muzzle. Accidental discharge can cause serious injury.

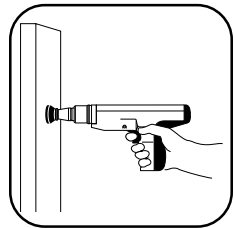
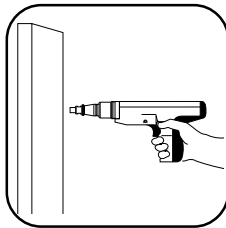

2. Never place your finger on the trigger until the tool's muzzle is against the work surface.

Safety Precautions

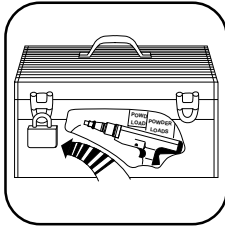
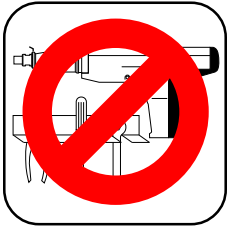

3. Store powder actuated tool and power load strips in a locked container. Unload tool before storing. Keep power loads of different power levels in separate containers.

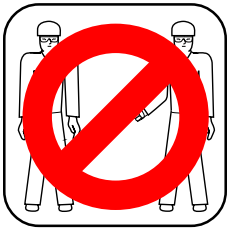

4. Never carry or pass a loaded powder actuated tool. Never point a powder actuated tool at anyone.

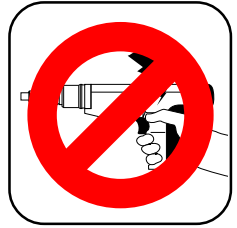
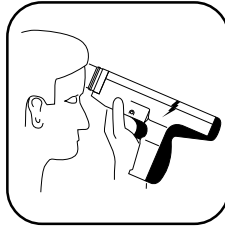
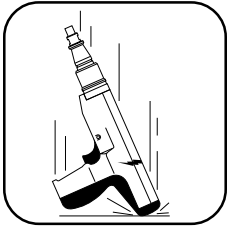

5. If the tool is dropped, inspect for damage and repair it before continuing to work. Never use a damaged tool.

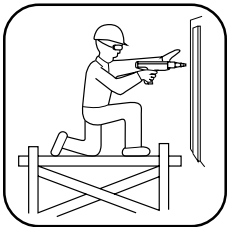

6. Always take precaution to maintain your balance while operating a powder actuated tool.

Safety Precautions



7. An operator taking medication should take extra precautions while handling the tool. Never drink alcoholic beverages or take medications which impair your vision, balance or judgement before using a powder actuated tool.

KNOW YOUR FASTENING BASE MATERIAL

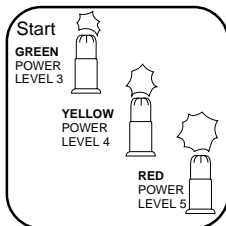
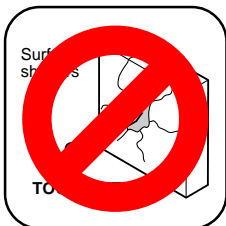
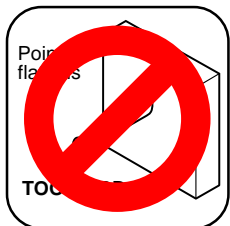
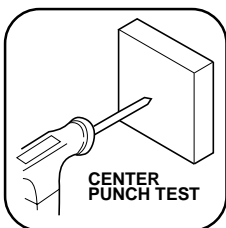
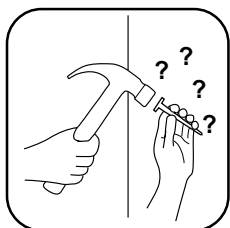

1. Always know the thickness and type of base material into which you are fastening. Never guess. Test the base material by using the Center Punch Test. The Center Punch Test is performed by using a hammer to test drive the particular power fastener to be used into the material. If the point penetrates easily, the material is too soft. If the point becomes blunt, the material is too hard. If the material fractures, cracks or shatters, the material is too brittle. Test fastenings can be made if the material shows a clear fastener impression and the fastener point is not blunted. Always start with the lowest power load (Green-Level 3) and proceeding with the order shown in the lower right-hand figure above. Always wear approved goggles.

Safety Precautions

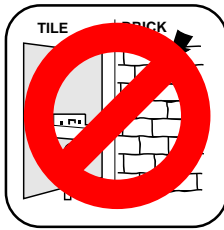
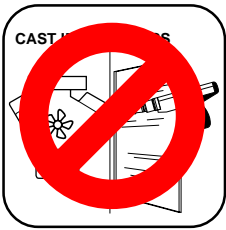

2. Never attempt to drive power fasteners into very hard or brittle materials including, but not limited to cast iron, glass, tile, stone, brick, or hardened steel. Materials of this type tend to shatter and create hazard from flying particles.

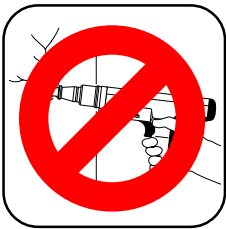

3. Never make fastenings in spalled or cracked areas.

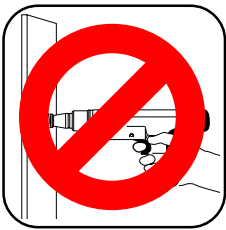

4. Never drive power fasteners into thin or easily penetrated materials unless it is backed by concrete or steel. When in doubt, such as when base material is concealed, conduct a Center Punch Test (See page 6). Check continually to avoid fastening into unsuitable material, especially in older buildings.

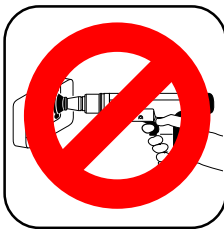
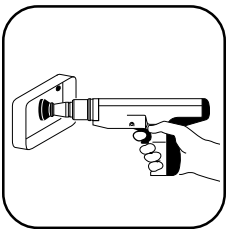

5. Do not fasten through or within 1/2" of predrilled or pre-punched holes.

Safety Precautions

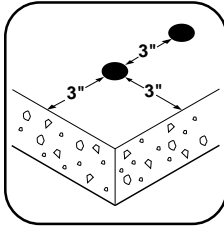
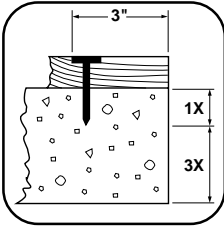

6. Do not drive power fasteners into concrete less than three times as thick as the intended fastener penetration, within 3" of the edge, within 3" of another power fastener or within 3" of a failed power fastener.

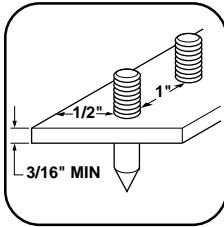
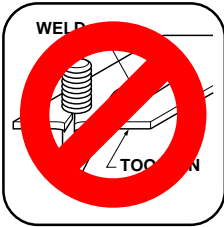

7. Do not drive power fasteners into steel base material less than 3/16" thick, within 2" of a weld, within 1/2" of the edge or within 1" of another power fastener.

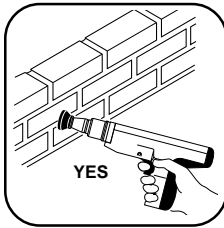
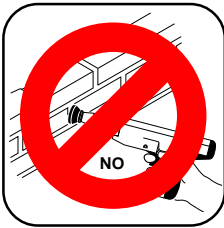

8. When fastening into masonry walls, always drive into horizontal mortar joints, never into vertical mortar joints. Be careful. A poorly laid joint may permit too much penetration, and/or unsatisfactory holding power.

OPERATING THE TOOL

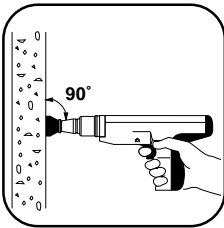

1. Always hold tool perpendicular to work surface.

Safety Precautions

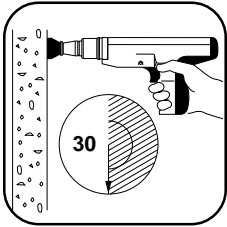

2. Should the tool fail to fire, hold the muzzle firmly against the work surface for 30 seconds. Release the trigger and remove pressure on the tool while holding the muzzle against the work surface. Again press the tool firmly against the work surface and pull the trigger. If the tool still fails to fire, hold the tool firmly against the work surface for another 30 seconds before advancing the power load strip. Use remaining loads in strip. Discard power load strip into water or oil.

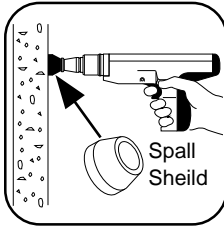
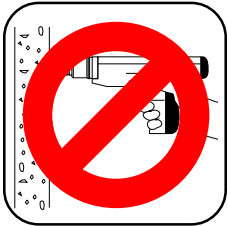

3. Always use the spall shield when driving directly into concrete or steel. Always wear approved goggles.

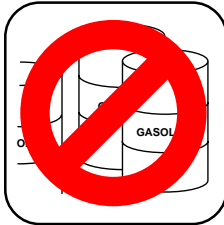
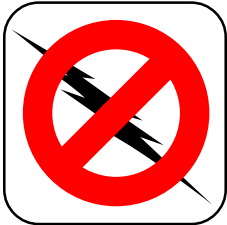

4. Never use a powder actuated tool in an explosive or flammable atmosphere or when non-sparking tools are required.

POWER LOADS AND FASTENERS

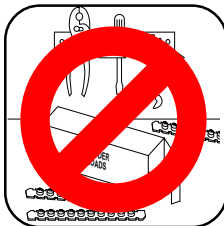
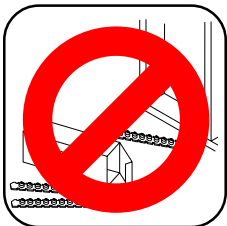

1. Never leave unfired power load strips on floors or work surfaces.

Safety Precautions

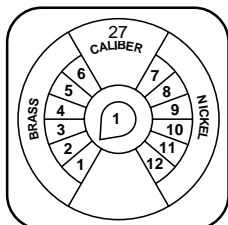
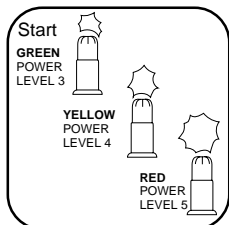

NOTE:

Failure to start with the lowest power level can result in overdrive condition and will result in damage to tool (See page 13).

- Remington power load strips are available in three power levels – green (level 3), yellow (level 4) and red (level 5). Green is lowest power level, red is highest power level. Always start with the lowest power level (green-level 3) and increase until a proper fastening is made (See page 13 “Selecting Power Fasteners and Power Loads”). **IMPORTANT: Purple (level 6) power load strips will not function in model 491 tool.**

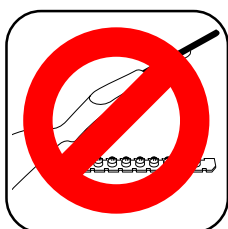
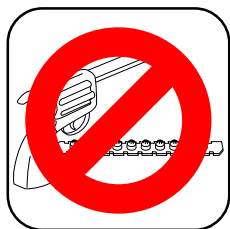

- Never use power loads in firearms.

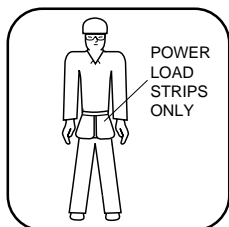

- Never carry fasteners or other hard objects in the same pocket or container with power load strips.

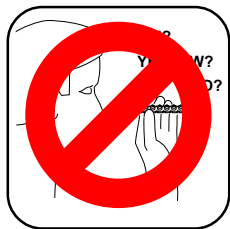

- A color blind person must take extra precautions to prevent the chance of mixing the power load strips of various levels.

Safety Precautions

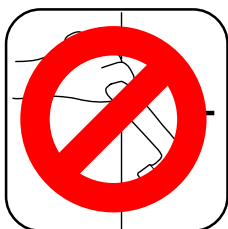

6. Power fasteners are a permanently installed fixture. An act of demolition is required for their removal. Appropriate safety precautions must be taken.

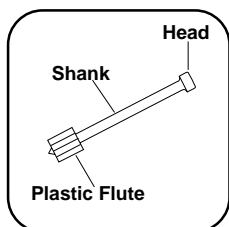

7. Never use common nails or other materials as fasteners. Remington Power Fasteners are manufactured from special steel and heat treated to produce a very hard yet ductile fastener.



8. Never pry a power load out of the strip. Prying can discharge the load causing serious injury (See Troubleshooting Guide, page 23).

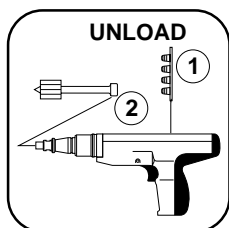

9. If work is interrupted for any reason, remove the power load strip before removing the power fastener.

Why A Power Fastener Holds

WHY A POWER FASTENER HOLDS IN CONCRETE

The compression bond of the concrete to the power fastener accounts for the majority of the holding power. The fastener displaces the concrete which tries to return to its original form causing a squeezing effect.

Maximum holding power is achieved when the depth of penetration produces a bond on the power fastener equal to the strength of the concrete. As a general rule, penetration should be approximately 1" to 1 1/4" into the base concrete. Make sure the concrete is at least three times as thick as the intended fastener penetration. Never have the power fastener point protrude through the concrete.

NOTE: Concrete needs to cure for 28 days before maximum fastening holding power will be achieved.

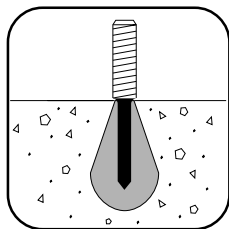

WHY A POWER FASTENER HOLDS IN STEEL

Holding power in steel depends on the elasticity of the steel. The steel pushes back on the shank of the power fastener.

Drop a marble into water; the water parts, the marble continues down, the water closes back. This is similar to the reaction when a power fastener penetrates steel.

In steel, the point of the power fastener must penetrate completely through for highest holding power. If the fastener does not penetrate, the spring action of the steel pushes back on the point and tends to force the fastener out.

Recommended applications are between 3/16-3/8" steel.

NOTE: When fastening in steel be sure the point goes through the steel.

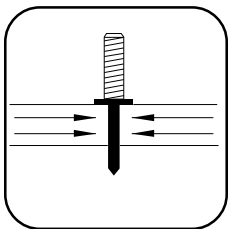

Selecting Power Fasteners and Power Loads

FASTENING INTO CONCRETE

The proper power fastener length can be determined by adding the thickness of the material to be fastened and the amount of fastener that will actually penetrate the concrete. The concrete must be three times as thick as the intended fastener penetration. In most cases, penetration should be approximately 1" to 1 1/4" into the base concrete material.

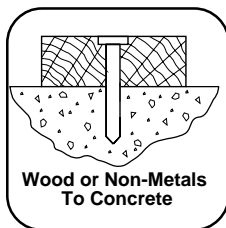

FASTENING INTO STEEL

The proper fastener length can be determined by adding the thickness of the material to be fastened and the thickness of the steel. The point of the power fastener must go completely through the steel.

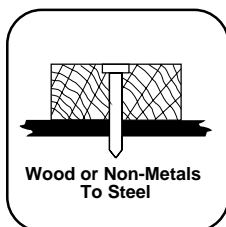

POWER LOADS

Always start with the lowest power level (green-level 3). If the first test fastener does not penetrate to the desired depth, move to the next highest power level (yellow-level 4). Increase until a proper fastening is made.

IMPORTANT: Damage to the tool will result if the above instructions are not followed (see illustrations to right and lower right).

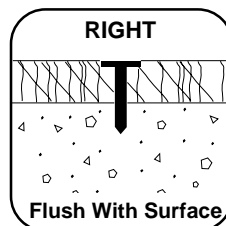

OVERDRIVEN POWER FASTENERS AND PISTON

An overdriven power fastener results when too strong of a power load is used causing the piston to extend past the muzzle. Move to the next lightest power load. Repeated overdrive will damage your tool. By avoiding overdrive, you can extend the life of your tool considerably and avoid costly repairs.

NOTE: Never fire the tool without a power fastener. This can damage the tool and/or cause possible injury to the operator.

IMPORTANT: Only use 2 1/2" power fasteners with the standard guide. 3" power fasteners can be used with optional guide, part number 301110.



Operation

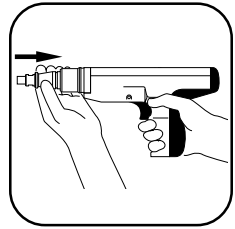
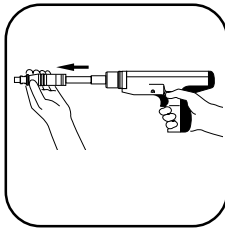
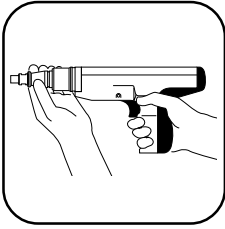

1. Grasp barrel assembly and slide forward rapidly until it stops. Push barrel assembly back into tool to the closed position. This sets piston into firing position.

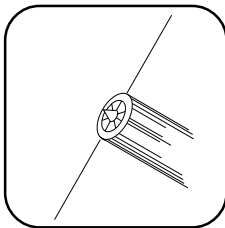
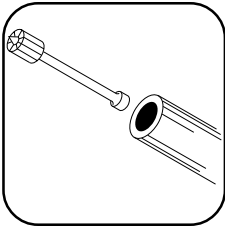

2. Insert power fastener into muzzle of tool, head end first. Push the fastener until point is even with end of tool.

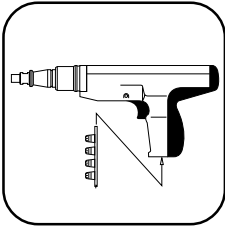

NOTE:

Failure to start with the lowest power level can result in overdrive condition and will result in damage to tool (See page 13).

3. Select the proper power level of power load strips. Always insert powder strip loads through bottom of handle. Push power load strip in until even with bottom of handle.

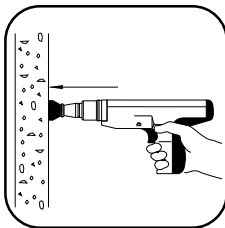
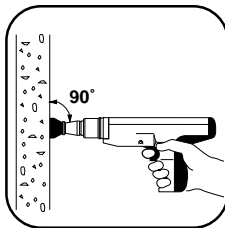

4. Place the muzzle of tool perpendicular to work surface without tilting the tool. Push tool against work surface until sliding action of barrel stops.

Operation

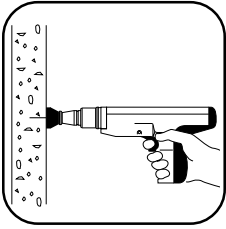

5. Squeeze trigger to set power fastener. Be sure to keep pressure on tool during this operation.

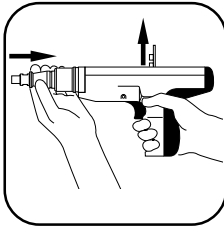
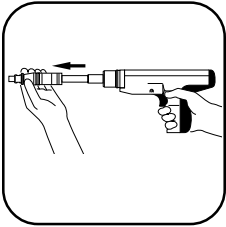

6. Grasp base plate and slide barrel forward rapidly until it stops. Push base plate back into liner to the closed position. This advances the power load strip and resets the piston for the next fastening.

WARNING: Do not depress muzzle of tool into barrel assembly when loading new power fastener. Live power load is in firing position.

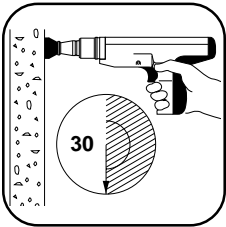

7. Should the tool fail to fire, hold the muzzle firmly against the work surface for 30 seconds. Release the trigger and remove pressure on the tool while holding the muzzle against the work surface. Again press the tool firmly against the work surface and pull the trigger. If the tool still fails to fire, hold the tool firmly against the work surface for another 30 seconds before advancing the power load strip. Use remaining loads in strip. Discard power load strip into water or oil.

Parts List

Key No.	Part No.	Description	Qty.
1	301002	Body	1
2	301034	Trigger Pin	1
3	301529	Advance Holder	1
4	301530	Advance Bar	1
5	301531	Advance Bar Spring	1
6	301533	Trigger	1
7	301015	Screw	2
8	301100	Liner	1
9	301014	Annular Spring	1
10	301013	Ball Bearing	1
11	301012	Stop	1
12	301016	Push Pin	1
13	301046	Ball Bearing	2
14	301047	Spring	2
15	301006	Piston Sleeve	1
16	301903	Piston Assembly (Includes Piston and Ring)	1
17	301208	Piston Ring	1
18	301010	Guide	1
19	301009	Base Plate	1
20	301011	Shear Clip	1
21	301300	Sear Holder	1
22	301023	Sear	1
23	301024	Sear Spring	1
24	301904	Firing Pin Assembly	1
25	301026	Sear Holder Spring	1
26	301025	Firing Pin Spring	1
27	301028	Plug	1
28	301601	Rubber Pad	1
29	301844	Rock Arm	1
30	301840	Spring	1
31	301843	Spring	1
32	301845	Rock Arm Pin	1
		Optional Accessory	
	301110	Guide For 3" Power Fasteners	1
	301053	Spall Shield	1

IMPORTANT: Do not use key numbers when ordering service parts. Always order components by part number and description. Include model number and serial number of tool.

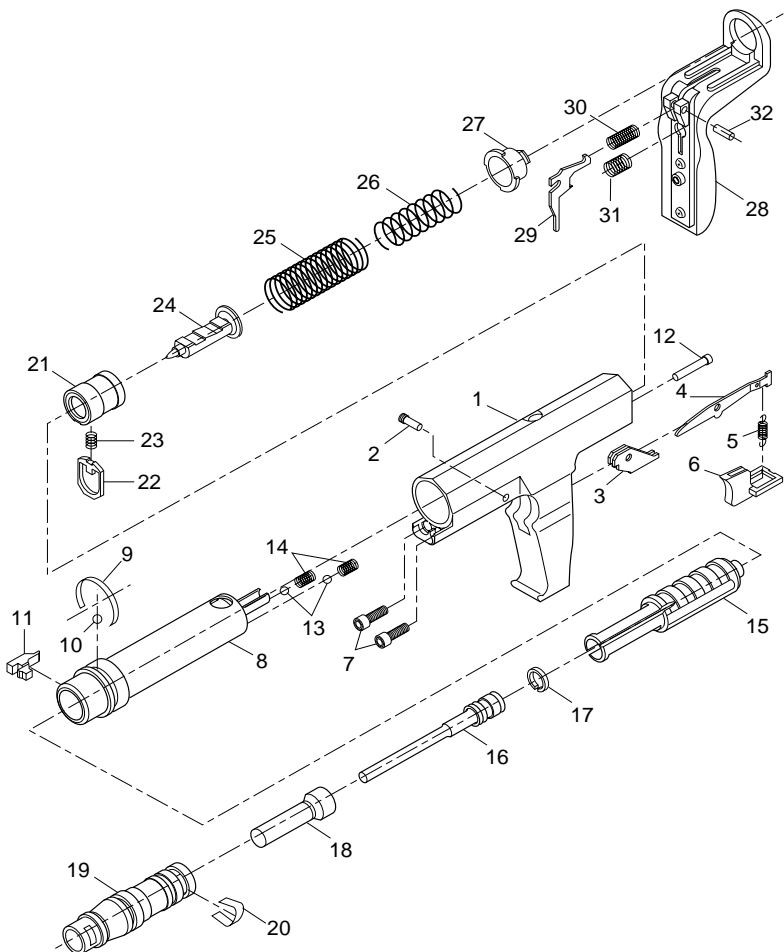

Cleaning and Maintenance

Clean tool after each days use. Disassemble and clean the barrel assembly with the wire brush provided with tool. **Notice:** Do not attempt to clean power load strip channel with wire brush.

Apply good quality penetrating lubricant spray (such as WD-40) sparingly and wipe dry.

Tool Disassembly

WARNING: Never disassemble, replace barrel, clean, or assemble a loaded powder actuated tool.

REMOVING BARREL ASSEMBLY

1. Using screwdriver, lift end of annular spring and rotate spring until stop is uncovered (see Figure 1).

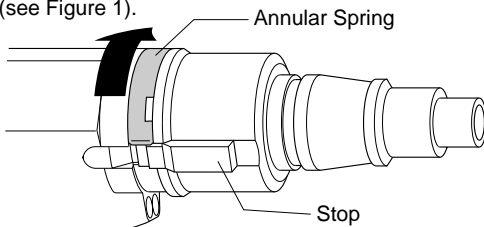

Figure 1 - Rotating Annular Spring

2. Using thumb, push stop towards rear of tool and remove (see Figure 2).

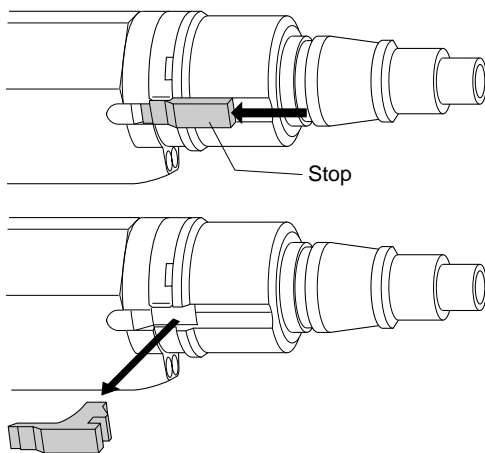

Figure 2 - Removing Stop

3. Pull barrel assembly out of liner in tool body.
4. Remove shear clip from barrel assembly (see item 20, page 17, for shear clip location).
5. Separate base plate from piston sleeve (see Figure 3).

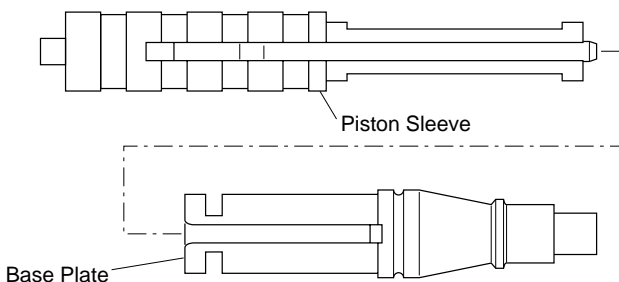

Figure 3 - Separating Base Plate From Piston Sleeve

6. Remove piston assembly from piston sleeve (see Figure 4).

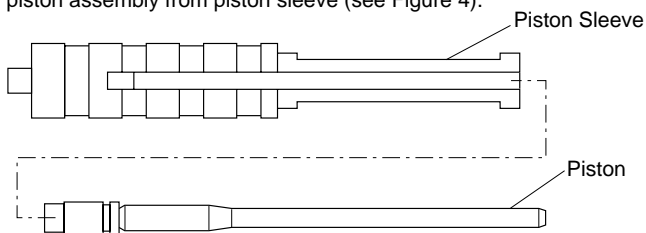

Figure 4 - Removing Piston From Piston Sleeve

7. Tilt rear of base plate down. Guide will slide out.

REMOVING RUBBER PAD

1. Loosen screw on back of rubber pad with 5mm Allen wrench.
2. Detach rubber pad from top of tool first, then pull entire rubber pad from tool.

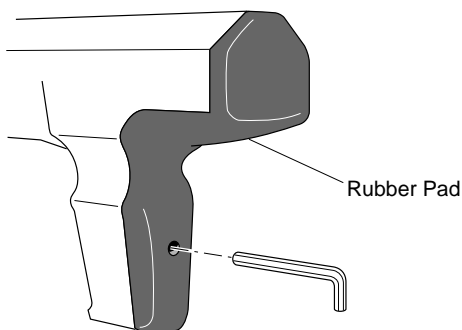

Figure 5 - Removing Rubber Pad

REMOVING ROCK ARM

Rock arm assembly is located on rubber pad.

1. Push out rock arm pin (see Figure 6).
2. Remove rock arm and spring from rubber pad.

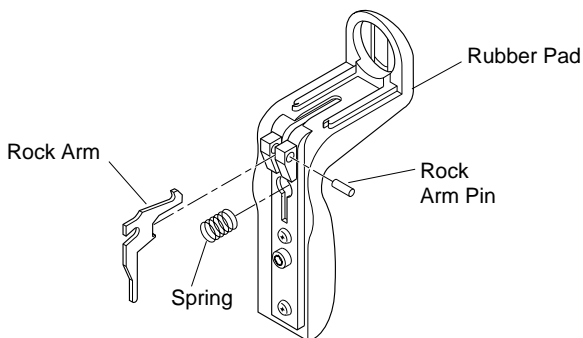

Figure 6 - Removing Rock Arm

REMOVING FIRING PIN

1. Remove plug from end of tool. Do this by pressing plug in and turning it 90°. This will release the plug from the tool body.
2. Remove the two springs within the cylinder at rear of tool body.

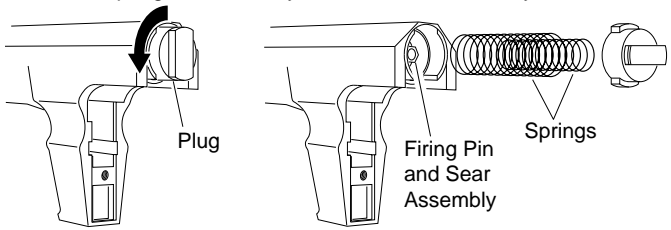

Figure 7 - Removing Plug and Springs to Access Firing Pin

3. Use needle-nosed pliers to grasp nut at rear of firing pin assembly. Pull firing pin assembly and sear assembly from tool body.
4. Remove push pin from inside tool body. Do this by tilting rear of tool down. Push pin will fall out.
5. Remove firing pin assembly from sear assembly.

REMOVING TRIGGER ASSEMBLY

1. Remove trigger pin from tool body (see Figure 8). *Note:* End of trigger pin is threaded. Unscrew threaded portion of pin, then pull pin from tool body.
2. Remove trigger assembly from rear of tool body.

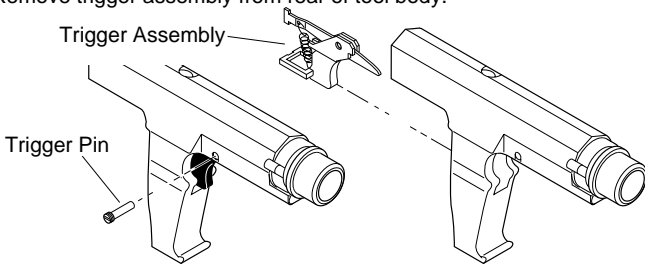

Figure 8 - Removing Trigger Pin and Trigger Assembly

REMOVING LINER FROM TOOL BODY

Note: You must remove trigger assembly before removing liner.

1. Remove two screws just under liner at front of tool body.
2. Grasp liner and hold tool vertically with liner pointing down.
3. Remove liner from tool body.
4. Remove two springs and two ball bearings at rear of liner.

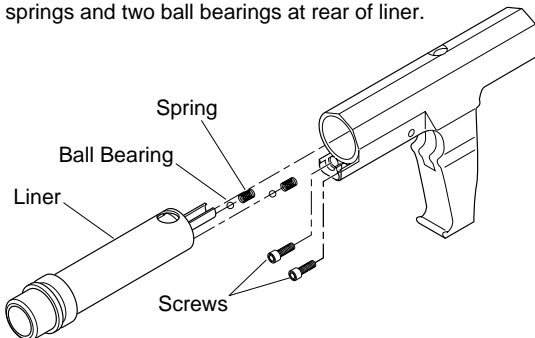

Figure 9 - Removing Liner From Tool Body

Tool Assembly

ATTACHING LINER TO TOOL BODY

1. Replace two ball bearings and springs into end of liner (see Figure 9, page 20).
2. Slide tool body onto liner.
3. Insert two screws into front of tool body just under liner. Tighten screws firmly.

ATTACHING TRIGGER ASSEMBLY TO TOOL BODY

1. Insert trigger assembly into tool body at rear of body (see Figure 8, page 20).
2. Replace trigger pin. Do this by inserting trigger pin through tool body and trigger assembly. After pin is inserted, tighten pin firmly using a standard screw driver.

ATTACHING FIRING PIN ASSEMBLY

1. Insert push pin into tool body (see item 12, page 17, for push pin location). Hole for push pin is located in cylinder at rear of tool. The hole for the push pin is located beside center hole in cylinder. Insert narrow end of pin first.
2. Insert sear assembly into cylinder at rear of tool body. Sear assembly consists of sear, spring, and sear holder (see items 21, 22, & 23, page 17). Insert sear assembly sear-end first (see Figure 10). Make sure sear is pointing towards bottom of tool. *Note:* Use screw driver to depress sear so sear assembly can pass into cylinder. Press sear assembly into cylinder until it stops. *Note:* Sear can be seen through slot in bottom of cylinder. Use screw driver to depress sear through slot. Move sear assembly further into cylinder until sear is located at center of slot.

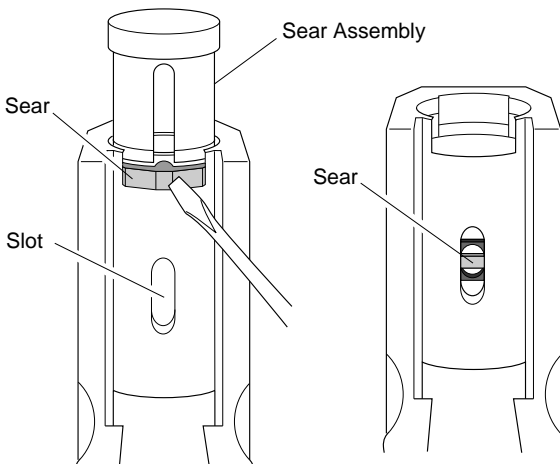

Figure 10 - Inserting Sear Assembly Into Cylinder As Viewed From Bottom Of Tool

3. Insert firing pin (point-first) into sear assembly. Make sure notched side of firing pin is pointing towards top of tool body. Do not force firing pin assembly into place. Use screw driver to depress sear through slot in cylinder. With free hand, gently press firing pin until it drops into place.
4. Place smaller diameter spring into sear assembly. Make sure spring is over top of firing pin (see Figure 7, page 20).
5. Place large diameter spring over top of smaller spring (see Figure 7, page 20).
6. Place plug over end of both springs.
7. Press plug to tool body. This will compress the springs into the tool body. After plug enters tool body, turn plug 90° to lock plug.

ATTACHING RUBBER PAD

1. Slip top of rubber pad over plug at rear of tool body (see Figure 5, page 19).
2. Press rubber pad into place.
3. Tighten screw on back of rubber pad with 5mm Allen wrench.

ASSEMBLING BARREL ASSEMBLY

1. Insert guide into rear of base plate (see Figure 11).

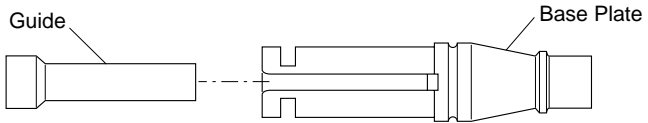

Figure 11 - Inserting Guide Into Base Plate

2. Insert piston into piston sleeve. Push piston to end of piston sleeve (see Figure 12).

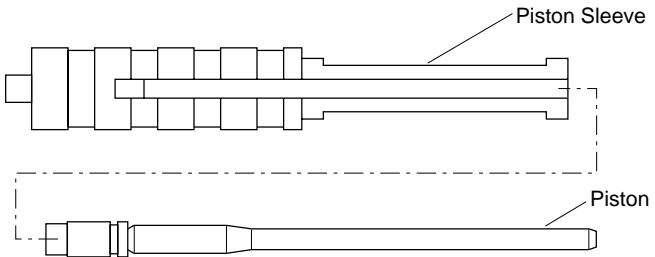

Figure 12 - Inserting Piston Into Piston Sleeve

3. Slide base plate onto piston sleeve. *Note:* Make sure guide groove on base plate and piston sleeve are in line (see Figure 13).

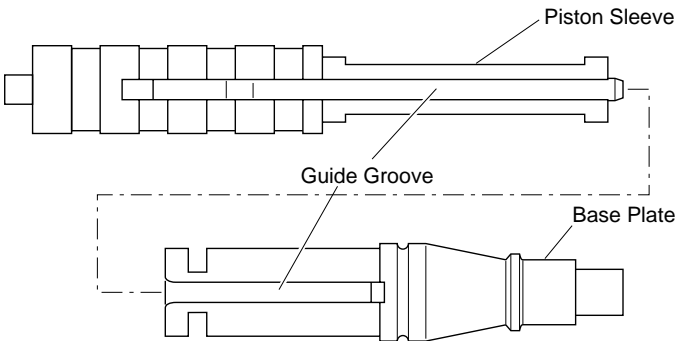

Figure 13 - Sliding Base Plate Onto Piston Sleeve

4. Snap shear clip in place (see item 20, page 17, for shear clip location).
5. Insert barrel assembly into liner in tool housing. *Note:* Align guide groove on barrel assembly with stop opening on liner.
6. Replace stop. After placing stop in hole on liner, move stop towards front of tool (see Figure 2, page 18 for stop location).
7. Rotate annular spring back over stop. Annular spring holds stop in place.

Troubleshooting Guide

PROBLEM	POSSIBLE CAUSE	REMEDY
Piston hangs out of muzzle.	Tool overdriven.	Tap piston on hard surface until piston is pushed back into the guide. (See "Overdriven Fastener" below)
	Piston not properly assembled in relation to barrel stop.	Remove barrel assembly (see pages 18-22). Replace all damaged or missing parts.
	Broken piston or piston ring.	Replace piston or piston ring or take tool to your distributor.
Overdriven fastener.	Excessive power.	Change either to next lower power load or next longer length fastener.
Piston jammed.	Overdriving of fastener (see above).	Remove barrel assembly (see pages 18-22). Replace other parts if damaged.
Power load strip will not advance.	Advance bar or spring damaged	Replace advance bar or springs.
	Tool dirty.	Clean tool. Notice: Do not attempt to clean power load strip channel with wire brush. You may damage tool.
Reduction or loss of power.	Piston not returning to full rear position.	Barrel must be opened to the full extended position to properly position piston.
	Worn piston ring or broken piston.	Replace piston and/or piston ring or take tool to your distributor.
Tool does not completely depress.	Misassembled or damaged sear holder and firing pin parts.	Remove sear holder and check all parts for correct fit assembly.
Tool does not fire.	Failure of tool to depress completely.	See data listed under "Tool does not completely depress," above.
	Piston not fully reset.	Fully reset piston. See step 1 under OPERATION, page 14.
Tool does not fire.	Dirt buildup on sear holder not allowing proper penetration of firing pin or worn firing pin.	Check firing pin mark on power load. Clean sear holder, sear and firing pin. Replace worn or damaged parts. Notice: Do not attempt to clean power load strip channel with wire brush. You may damage tool.
Opening and closing of barrel or pushing down on tool, etc. is not smooth but is rough or binds.	Lack of proper cleaning.	Inspect and clean complete tool. Replace worn or damaged parts. Notice: Do not attempt to clean power load strip channel with wire brush. You may damage tool.

Fasteners

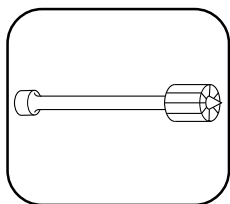



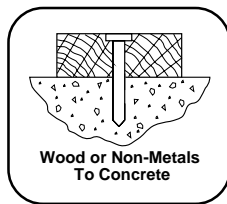







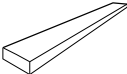





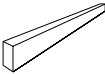



















SP FASTENERS



Fasten wood or nonmetals to concrete or steel.

Application Chart

Power load and power fastener application information.

For fastening this	to this	power fastener length	power load color
Two by fours 	Concrete Cement block Steel (3/16" to 3/8" thick)	 2 1/2"  2"	 Yellow  Green  Yellow/Red
Furring strips 	Concrete Cement block Steel (3/16" to 3/8" thick)	 1 1/2"  1"  3/4"	 Yellow  Green  Yellow/Red
Electrical junction boxes 	Concrete Cement block Steel (3/16" to 3/8" thick)	 1"  3/4"	 Yellow  Green  Yellow/Red
Conduit clips 	Concrete Cement block Steel (3/16" to 3/8" thick)	 1"  3/4"	 Yellow  Green  Yellow/Red
Shelf brackets 	Concrete Cement block	 1"  1"	 Yellow  Green
1/4" Plywood or pegboard 	Concrete Cement block Steel (3/16" to 3/8" thick)	 1 1/4"  1"	 Yellow  Green  Yellow/Red

Power load listings are recommendations only. If you are in doubt, try a test fastening using the next lightest power load.

Application Chart

IMPORTANT

- Recommended for use with Remington power load strips and power fasteners.
- Only use power fasteners up to 2 1/2" long with standard guide. Power fasteners 3" long can be used with optional guide, part number 301110.
- If power fastener goes below the top surface of the board, use penetrating control disc (* see illustration below).
- Always wear approved eye and ear protection.

* Use power fastener with penetration control disc, part number 015549.

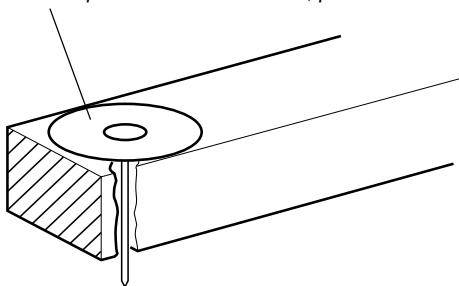

27 CALIBER strip loads for powder actuated tools	Load Level Number	Load Strength	Color Code	
			Case Body	Head
	3	medium	brass	Green
	4	heavy	brass	Yellow
	5	extra heavy	brass	Red

Parts Central

Contact authorized dealers of this product. If they can't supply original replacement part(s), either contact your nearest Parts Central (see below) or call DESA International's Parts Department at 1-800-972-7879.

In Canada call 1-905-826-8010.

When calling DESA International, have ready

- model number of your tool
- replacement part number

RAILWAY DISTRIBUTORS

264 Railway Avenue
Campbell, CA 95008
408-866-9266
Guy Bothelho

BALTIMORE ELECTRIC

1348 Dixwell Avenue
Hamden, CT 06574
1-800-397-7553
203-248-7553
Parts Department

ALL TOOL & FASTENER

7830 N.W. 72nd Avenue
Miami, FL 33166
305-888-6909
Parts Department

PRECISION TOOL

431 Commerce Park Drive
Suite 106
Marietta, GA 30060
404-421-0688
Bob Young

PORTABLE HEATER PARTS

342 No. County Road 400 East
Valparaiso, IN 46383
219-462-7441
1-800-362-6951

F B D

601 Hope Street
Bowling Green, KY 42101
502-796-8406
1-800-654-8534

MASTER SERVICE CENTER

1184 Wilson NW
Grand Rapids, MI 49504
US 1-800-446-1446
616-791-4760
Mike Fowler

MANZO ASSOCIATES

1645 Bustleton Pike
Feasterville, PA 19053
215-364-0480
Parts Department

21st CENTURY

RD 2, Box 165
Perkasie, PA 18944
215-795-0400
1-800-325-4828
Parts Department

BLUEBONNET TOOL

10490 Shady Trail
Suite 104
Dallas, TX 75220
214-358-2363
Ken Perry

CLARK SUPPLY

9435 Summerbell
Houston, TX 77074
713-771-0404
Parts Department

Limited Warranty Agreement

DESA International warrants the Remington Powerdriver Model 491 against defects in materials and workmanship for a period of one (1) year from the date of purchase.

If within one (1) year from the purchase date this Powder Actuated Tool fails due to a defect in material or workmanship, DESA will repair or replace the tool at DESA's option. To obtain service under this warranty, contact DESA at the number/address listed below. You must have the Serial Number, Model Number, date of purchase and indicate the type of problem being experienced. DESA will send replacement part(s), repair or replace the tool at DESA's option. However, this warranty does not cover failures caused by misusing or abusing the product (for proper use of this product, read and understand the operating instructions in this owners manual). Repairs made because of misuse, abuse, negligence or accident will be charged for at regular repair prices.

This express and limited warranty is the only warranty on this product, and to the full extent permitted by law there are no other warranties, express or implied, including warranties of merchantability and/or fitness for a particular purpose which extend beyond the terms of this express and limited warranty.

To the full extent permitted by law, the liability of DESA for personal injury, property damage or any other damage whatsoever, including consequential and incidental damages, arising from the sale or use of this product shall not exceed the purchase price of this product.

This warranty gives you specific legal rights, and you may also have other rights which vary from state to state.

For information about this warranty write:

In U.S.A., contact:

DESA
INTERNATIONAL

P.O. Box 90004
2701 Industrial Drive
Bowling Green, KY 42102-9004
502-781-9600

In Canada, contact:

DESA Industries
of Canada, Inc.

Unit #4
2220 Argentia Road
Mississauga, Ontario
L5N 2K7
905-826-8010
Fax 905-826-8236

For Technical Assistance call
Technical Services Department
1-800-323-5190.

099494-01
REV. C
7/95

Free Manuals Download Website

<http://myh66.com>

<http://usermanuals.us>

<http://www.somanuals.com>

<http://www.4manuals.cc>

<http://www.manual-lib.com>

<http://www.404manual.com>

<http://www.luxmanual.com>

<http://aubethermostatmanual.com>

Golf course search by state

<http://golfingnear.com>

Email search by domain

<http://emailbydomain.com>

Auto manuals search

<http://auto.somanuals.com>

TV manuals search

<http://tv.somanuals.com>