

GR

DIGITAL

RICOH

GR DIGITAL III

Camera User Guide

The product serial number may be found on the bottom of the camera.

Before You Begin

Before using your camera, take a few moments to familiarize yourself with camera controls and displays (pages 1–8). **Refer to this section as you read through the rest of the manual.**

Basic Photography and Playback

Read this section before using the camera for the first time. It covers the steps involved in readying the camera for use, taking photographs, and playing them back (pages 9–38).

Reference

Read this section for information on topics not covered in “Basic Photography and Playback.” It covers advanced shooting and playback options and describes how to print photographs, customize camera settings, and copy pictures to a computer (pages 39–173).

The rechargeable battery needs to be charged before use. The battery is not charged at the time of purchase.

Package Contents

Before using your Ricoh digital camera, confirm that the package contains the items listed below.



GR DIGITAL III

The serial number may be found on the bottom of the camera.



USB cable with mini-B connector

Connect the camera to a computer or printer.

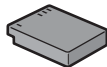

DB-65 rechargeable battery



Hot shoe cover

The cover comes mounted on the camera hot shoe.



A/V cable

Connect the camera to a TV.

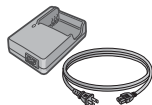

BJ-6 battery charger

- CD: Contains software and a *Software User Guide*.
- *Camera User Guide* (this manual)
- *Safety Precautions*
- Hand strap



Tip: Attaching the Hand Strap

Pass the small loop through the strap eyelet on the camera body and pass the large loop through the small loop as shown.

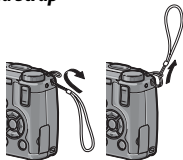

Notices

- **Safety precautions:** Read all safety precautions thoroughly to ensure safe use.
- **Test shots:** Take test shots to ensure that the camera is working properly before taking photos on important occasions.
- **Copyright:** Reproduction or alteration of copyrighted documents, magazines, and other materials, other than for personal, home, or other similarly limited purposes, without the consent of the copyright holder, is prohibited.
- **Exemption from liability:** Ricoh Co., Ltd. assumes no liability for failure to record or display images as a result of product malfunction.
- **Warranty:** This product is manufactured to local specifications and the warranty is valid within the country of purchase. The manufacturer assumes no responsibility for servicing the product in other countries or bearing any expense thereby incurred.
- **Radio interference:** Operating this product in the vicinity of other electronic equipment may adversely affect both the camera and the other device. Interference is particularly likely if the camera is used in close proximity to a radio or television. This can be resolved by moving the camera as far as possible from the other device, reorienting the radio or television antenna, or plugging the radio or television into a different outlet.

© 2009 RICOH CO., LTD. All rights reserved. This publication may not be reproduced in whole or in part without Ricoh's express written permission. Ricoh reserves the right to change the contents of this document at any time without prior notice.

Every effort has been made to ensure the accuracy of the information in this document. Should you nevertheless notice any errors or omissions, we would be grateful if you would notify us at the address listed on the back cover of this booklet.

Microsoft, Windows, Windows Vista, and Internet Explorer are registered trademarks of Microsoft Corporation in the United States of America and other countries. Macintosh and Mac OS are registered trademarks of Apple Inc. in the United States of America and other countries. Adobe, the Adobe logo, and Adobe Reader are trademarks of Adobe Systems Incorporated. All other trade names mentioned in this document are the property of their respective owners.

Product Manuals

The following manuals are provided with the GR DIGITAL III:



Camera User Guide (this booklet)

This guide describes how to use your camera and install the supplied software. The English version of the manual is also available in pdf format on the supplied CD.



Software User Guide (pdf file)

The *Software User Guide* describes how to copy pictures from your camera to a computer for display and editing. It is available in several languages, each in its own folder in the "DC Manual" folder on the supplied CD. For ease of reference, copy the pdf file from the CD to your computer hard disk.

Note: This folder contains a pdf copy of the English *Camera User Guide*.

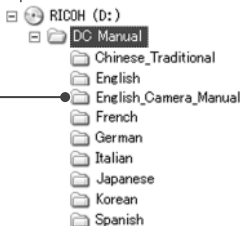

"Irodio Photo & Video Studio" image viewing and editing software is also included with the camera. For information on using this software, see the **Help** menu in Irodio Photo & Video Studio or telephone one of the following customer support centers:



- **North America (U. S. A.):** +1-800-458-4029 (toll free)
- **U. K., Germany, France, and Spain:** +800-1532-4865 (toll free)
- **Other European countries:** +44-1489-564-764
- **China:** +86-21-5385-3786
- **Other Asian countries:** +63-2-438-0090

Business hours: 9:00 AM to 5:00 PM

Table of Contents

Package Contents.....	ii
Notices.....	iii
Product Manuals.....	iv
Before You Begin	1
Read this section before using your camera for the first time.	
Introduction	2
Parts of the Camera	2
Basic Photography and Playback	9
Read this section before using your camera for the first time.	
First Steps	10
Charging the Battery.....	10
Inserting the Battery	12
Inserting Memory Cards.....	13
Turning the Camera on and Off.....	14
Basic Setup.....	16
Taking Photographs	17
Holding the Camera.....	17
Taking a Photograph.....	18
Digital Zoom	22
Close-ups (Macro Mode)	23
Flash Photography	24
The Self-Timer.....	26
The Tilt Indicator	27
Viewing and Deleting Photographs	29
Viewing Photographs.....	29
Deleting Photographs.....	33
The  (DISP) Button	36

Read this section for more information on camera functions.

More on Photography	40
Mode P: Program Shift	40
Mode A: Aperture Priority	42
Mode S: Shutter Priority	43
Mode M: Manual Exposure	44
SCENE Mode: Matching Settings to the Scene.....	46
"MY" Modes: Using Custom Settings	53
The Shooting Menu.....	54
Movies	87
 Recording Movies	87
 Viewing Movies.....	90
More on Playback	91
The Playback Menu.....	91
Viewing Pictures on TV	104
Printing Photographs	106
Connecting the Camera	106
Printing	108
The Setup Menu.....	112
Key Custom Settings/Setup Menu Options	114
Copying Pictures to a Computer.....	136
Windows.....	136
Macintosh	148
Technical Notes	150
Troubleshooting	150
Specifications.....	158
Optional Accessories	162
Using the Camera Abroad	169
Precautions for Use	169
Camera Care and Storage.....	171
Warranty and Servicing	172
NOTICES.....	173
Index	174

Before You Begin

Read this section before using your camera for the first time.

■ Introduction.....	2
---------------------	---

Introduction

This manual describes how to take pictures and play them back. To ensure that you get the most from your camera, read this manual thoroughly before use and keep it handy when using the product.

Parts of the Camera

For more information, refer to the page number to the right of each item.

Front

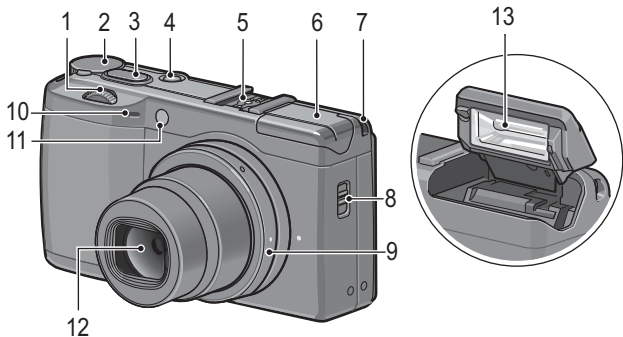

1 Up-down dial	5	8 Flash OPEN switch.....	24
2 Mode dial	4	9 Ring cap	163
3 Shutter-release button....	17, 18, 19	10 Microphone	87
4 POWER button	14, 15, 17	11 AF auxiliary light	26, 125
5 Hot shoe	ii, 164	12 Lens.....	17
6 Flash cover.....	24	13 Flash.....	24
7 Strap eyelet.....	ii		

Back

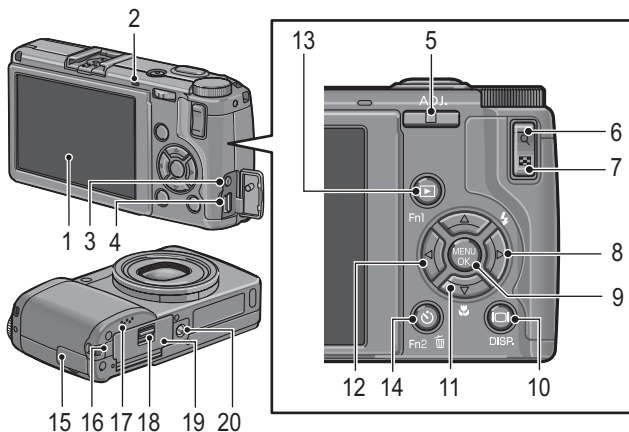

- | | | | |
|--|-----------------------|--|-------------------------------------|
| 1 Picture display..... | 6–8 | 11 ▼/🌸 (macro) button..... | 5, 23 |
| 2 Autofocus/flash lamp..... | 14, 18, 25 | 12 ◀/Fn1 (function 1) button...5, | 121 |
| 3 Connector for A/V cable..... | 104 | 13 ▶ (playback) button..... | 15, 29, 91 |
| 4 Connector for USB cable..... | 107 | 14 ⌚ (self-timer)/Fn2 (function 2)/ | 🗑️ (delete) button...26, 33–35, 121 |
| 5 ADJ. lever..... | 5, 78, 119–120 | 15 Connector cover..... | 104, 107 |
| 6 🔍 (enlarged view) button | 22, 31, 32, 122 | 16 DC power cable cover..... | 165 |
| 7 🖼️ (thumbnail display) button | 22, 31, 32, 122 | 17 Speaker..... | 27, 90, 125–126 |
| 8 ▶/⚡ (flash) button..... | 5, 24 | 18 Release lever..... | 12, 13, 165 |
| 9 MENU/OK button | 47, 54, 91, 112 | 19 Battery/card cover..... | 12, 13, 165 |
| 10 ◻ (DISP.) button..... | 36 | 20 Tripod screw hole..... | 48, 61 |

The Mode Dial

Before shooting, press the mode dial lock release (①) and rotate the mode dial to choose a shooting mode (②).

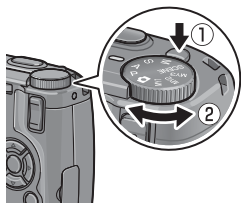

P (program shift): You choose from combinations of shutter speed and aperture that produce the same exposure (page 40).

A (aperture priority): You choose an aperture and let the camera adjust the shutter speed for optimal exposure (page 42).

S (shutter priority): You choose a shutter speed and let the camera adjust aperture for optimal exposure (page 43).

 **(auto):** The camera sets shutter speed and aperture for optimal exposure (page 17).

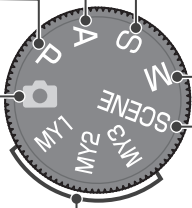

M (manual exposure): You choose shutter speed and aperture (page 44).

MY1, MY2, MY3 ("my settings"): Recall settings saved using **Reg. My Settings** (pages 53, 114–116).

SCENE (scene): Optimize settings for the current subject or scene or shoot movies (pages 46–52).

The Up-down Dial and ADJ. Lever

When viewing pictures or navigating the menus, you can use the up-down dial in place of the ▲ and ▼ buttons and the ADJ. lever in place of the ◀ and ▶ buttons. The ADJ. lever and up-down dial can also be used to select shutter speed and aperture in P, A, S, and M modes.

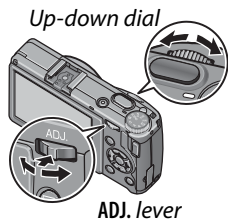

You can assign frequently-used shooting menu items to the ADJ. lever for easy access. To display a shooting menu item, center the ADJ. lever and press it in; you can then use the lever and up-down dial to select an option as described on page 116.



Note

The **M Mode Dial Options** and **Playback Mode Dial Options** items in the setup menu can be used to reverse the roles of the up-down dial and ADJ. lever (page 123).

The Picture Display

The following indicators may be displayed during shooting and playback.

Shooting (still photography)

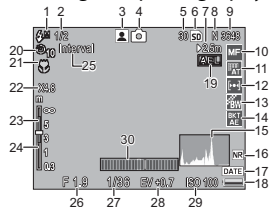

Shooting (movie mode)



- | | | |
|---|--|---|
| 1 Flash mode..... 24 | 10 Focus mode/full press snap59, 64 | 22 Zoom..... 22 |
| 2 Flash compensation/manual flash level72, 73 | 11 White balance/white balance compensation ...79, 82 | 23 Depth of field 59 |
| 3 Scene mode..... 46 | 12 Metering 65 | 24 Focus bar 59 |
| Continuous..... 68–69 | 13 Image setting..... 66 | 25 Interval timer shooting..... 75 |
| 4 Shooting mode/plus normal shooting 4, 49, 50 | 14 Bracketing..... 70 | 26 Aperture.....40, 42, 44 |
| 5 Number of exposures remaining* 161 | 15 Histogram37, 38 | 27 Shutter speed40, 43, 44 |
| 6 Destination..... 13 | 16 Noise reduction 74 | 28 Exposure compensation 77 |
| 7 Snap focus distance.....59, 64 | 17 Date imprint..... 76 | 29 ISO..... 84 |
| 8 Picture quality..... 57 | 18 Battery level..... 8 | 30 Tilt indicator 27 |
| 9 Picture size 57 | 19 Autoexposure lock 121 | 31 Blur warning 27 |
| | 20 Self-timer 26 | 32 Movie length 161 |
| | 21 Macro mode 23 | 33 Time available* 161 |
| | | 34 Frame rate.....87, 89 |

* Approximation only; actual capacity varies with shooting conditions and make of memory card. Display shows “9999” when memory remains for over 9,999 images.

Playback (photographs)

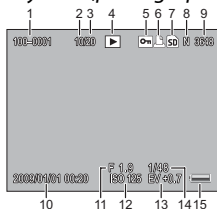

Playback (movies)

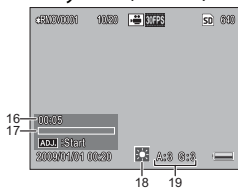

1 File number	8 Picture quality 57	14 Shutter speed
2 Current frame	9 Picture size 57 40, 43, 44
3 Total frames	10 Date of recording	15 Battery level 8
4 Playback mode indicator 16	16 Length/elapsed time
5 Protected image 92	11 Aperture..... 40, 42, 44	17 Progress indicator
6 DPOF print indicator 95	12 ISO..... 84	18 White balance 79
7 Source 13	13 Exposure compensation 77	19 White balance compensation 82



Notes

- The picture display may also display warnings and messages.
- Additional information can be viewed by pressing the **DISP.** button (page 36).

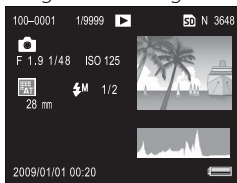



The Battery Level Indicator

Battery level is shown by the icon at the bottom right corner of the picture display.

Cautions

- The full battery indicator may not appear or may appear only briefly with NiMH batteries. Check the battery type before use.
-  may be displayed when the camera is powered by an AC adapter. This is normal and does not indicate a malfunction.

Icon	Description
 (green)	Battery fully charged.
 (green)	Battery partially discharged.
 (orange)	Low battery. Charge or replace as soon as possible.

Basic Photography and Playback

Read this section before using your camera for the first time.

■ First Steps.....	10
■ Taking Photographs.....	17
■ Viewing and Deleting Photographs.....	29

First Steps

Prepare the camera for use.

Charging the Battery

The rechargeable battery supplied with the camera is not charged at shipment. Charge the battery in the supplied BJ-6 battery charger before use.

1 Place the battery in the charger.

Place the battery label up with the "+" and "-" labels oriented to match the labels on the charger.

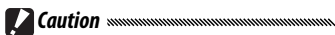

Caution //

Be sure the battery is in the correct orientation.

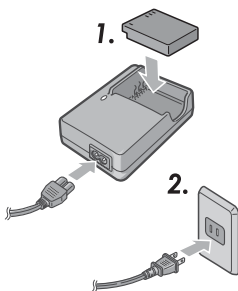

2 Plug the charger in.

The charger lamp will light while the battery charges. An exhausted battery will re-charge in about two hours at 25 °C.



Note //

If the charger lamp blinks, a battery or charger fault may have occurred. Unplug the charger and remove the battery.

3 Remove the battery.

Charging is complete when the charger lamp turns off. Unplug the charger and remove the battery.

Compatible Batteries

The camera can be used with a DB-65 rechargeable Li-ion battery (supplied; DB-60 rechargeable batteries can also be used) or with a pair of AAA alkaline or rechargeable nickel-metal hydride (NiMH) batteries.



Tip: Battery Capacity

Under normal conditions, about 370 shots can be taken with a fully-charged DB-65 battery. About 25 shots can be taken with a pair of fresh AAA alkaline batteries manufactured by Panasonic. These figures are based on tests conducted according to CIPA standards under the following conditions: temperature 23 °C (73 °F); picture display on; 10 shots taken with 30 seconds between shots and the flash fired with every other shot; and the cycle repeated after the camera has been turned off and then on again.



Cautions

- **Rechargeable Li-ion batteries:** Use only genuine DB-65 or DB-60 batteries. Do not use batteries not specifically designated by Ricoh for use in this camera.
- **Alkaline batteries:** Battery life varies with make and storage conditions. Capacity drops at low temperatures.
- **NiMH batteries:** NiMH batteries are not charged at purchase and gradually lose their charge over time. Charge before use. Note that performance may be impaired immediately after purchase or following an extended period of disuse, and that the batteries may need to be used and recharged two or three times before they will hold a charge.
- Manganese and Ni-Cd batteries can not be used.
- Batteries may be hot immediately after use. Before removing batteries, turn the camera off and wait for them to cool down.
- Remove the battery if the camera will not be used for extended periods.

Inserting the Battery

Be sure the camera is off before inserting or removing batteries.

1 Open the battery/card cover.

Unlatch (1) and open (2) the cover.



2 Insert the battery.

Using the battery to keep the battery latch pressed to one side, slide the battery in. The latch will click into place when the battery is fully inserted.

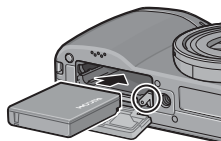

3 Close the battery/card cover.

Close (1) and latch (2) the cover.

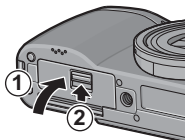

Caution ~~~~~

Be sure the cover is latched.

Removing the Battery

Unlatch and open the battery/card cover, then press and release the latch and remove the battery by hand, being careful not to drop it.

Tip: Inserting and Removing AAA Batteries ~~~~~

Insert in the orientation shown, press the cover closed, and slide the release lever to the closed position. To remove, simply unlatch and open the cover.

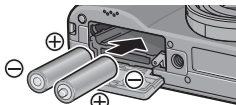

Caution ~~~~~

If the camera will not be used for an extended period, remove the batteries and store them in a cool dry place.

Inserting Memory Cards

Pictures can be stored in the camera's 88MB internal memory, or optional SD and SDHC memory cards can be used to store additional pictures. Internal memory is used for recording and playback if no card is inserted; if a card is inserted, the card will be used instead.

Before inserting or removing a memory card, be sure the camera is off. To insert a memory card:

1 Open the battery/card cover.

Unlatch (1) and open (2) the cover.



2 Insert the card.

Holding the memory card in the orientation shown, slide it in until it clicks into place.

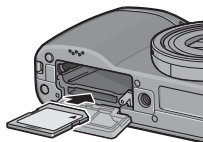

3 Close the battery/card cover.

Close (1) and latch (2) the cover.

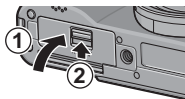

Removing Memory Cards

Unlatch and open the battery/card cover and press the memory card in to eject it. The card can then be removed by hand.

**Cautions**

- Pictures will not be recorded to internal memory when a memory card is inserted, even if the memory card is full.
- Keep the memory card contacts clean.

**Tip: Write Protection**

Memory cards can be protected by sliding the write-protection switch to “**LOCK**,” keeping data from being written to or deleted from the card and preventing the card from being formatted.

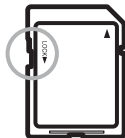

Pictures can not be taken when the memory card is locked; lock the card only to prevent accidental loss of data and be sure to unlock the card before shooting.

**Notes**

- Format memory cards before first use or after they have been used in a computer or other device (page 124). Be sure to back up any important data before formatting.
- See page 161 for information on memory card capacity.
- Pictures can be copied to memory cards from internal memory (page 97).

Turning the Camera on and Off

Shooting Mode

Press the **POWER** button to turn the camera on. The **POWER** button will light and the camera will play the start-up sound. The autofocus/flash lamp blinks for several seconds while the camera starts up.

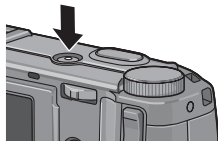



To turn the camera off, press the **POWER** button again. The number of pictures taken so far that day will be displayed before the camera turns off (zero is displayed if the camera clock is not set; if you turn the camera off after changing the clock, the camera will display the number of pictures taken since the clock was changed).



Cautions

- The camera may take slightly longer to start up if the flash is on.
- Changes to continuous (page 68), interval (page 75), and self-timer (page 26) settings are lost when the camera is turned off. Turning the camera off restores settings for “MY” modes to the values saved with **Reg. My Settings**. Other settings are unaffected.

Playback Mode

Press the  button for about a second to turn the camera on in playback mode. Press the  button again to exit to shooting mode.

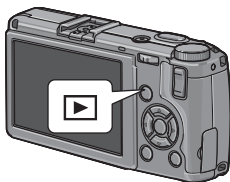

To turn the camera off, press the **POWER** button.

Tip: Auto Power Off

The camera will turn off automatically to save power if no operations are performed for the time selected in the **Auto Power Off** menu (see page 125).

Basic Setup

A language-selection dialog is displayed the first time the camera is turned on. Follow the steps below to choose a language and set the time and date. To exit before setup is complete, press **DISP**; the language, time, and date can be changed at any time in the setup menu (page 135).

1 Select a language.

Press **▲**, **▼**, **◀**, or **▶** to highlight a language and press **MENU/OK** to select.



2 Set the clock.

Press **◀** or **▶** to highlight the year, month, day, hour, minute, or date format and press **▲** or **▼** to change. After checking that the date is correct, press **MENU/OK**. A confirmation dialog will be displayed; press **MENU/OK** again to set the clock.

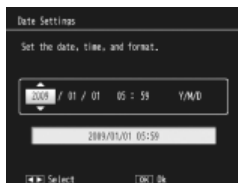

Default date and time

Notes

- If you leave the battery in the camera for at least two hours, the battery can be removed for about a week without resetting the clock or language selection.
- The time and date of recording can be printed on photographs (page 76).

Taking Photographs

After setting up the camera as described in “First Steps” (pages 10–16), you are ready to take your first photos. Press the **POWER** button to turn the camera on and rotate the mode dial to .

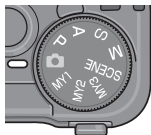

Holding the Camera

Hold the camera as shown below.

1 Hold the camera in both hands.

Hold the camera in both hands with your elbows lightly pressed against your body.

 **Caution** //

Be sure your fingers or hair or the camera strap do not obstruct the lens or flash.

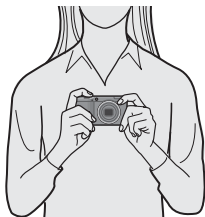

2 Get ready to shoot.

Put your finger on the shutter-release button.



Taking a Photograph

1 Focus.

Frame your subject in the center of the picture display and press the shutter-release button halfway to set focus and exposure.

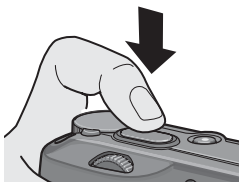
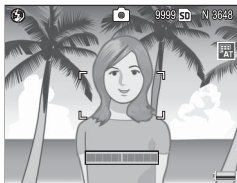

If the camera is unable to focus, the center focus frame blinks red and the autofocus/flash lamp blinks green.

If the camera is able to focus, the focus frames (up to nine) that contain objects that are in focus are shown in green.

Autofocus/flash lamp

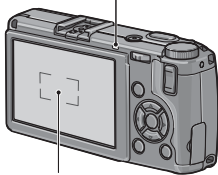

Focus frame

2 Take the picture.

Gently press the shutter-release button the rest of the way down to take the picture. The photograph you have just taken will be displayed in the picture display as it is recorded to the memory card or internal memory.

Tip: The Shutter-Release Button

The camera has a two-stage shutter-release button. To focus, lightly press the shutter-release button until you feel resistance. This is called “pressing the shutter-release button halfway.” Press the shutter-release button the rest of the way down to shoot.

Tip: Focus

The autofocus/flash lamp and the focus frame show whether the subject is in focus.

Focus status	Focus frame	Autofocus/flash lamp
Camera has not yet focused.	White	Off
Subject in focus.	Green	On (green)
Camera unable to focus.	Blinks (red)	Blinks (green)

The camera may be unable to focus on the following:

- Objects that lack contrast, such as the sky, a wall that is only one color, or the hood of a car
- Flat objects containing only horizontal lines
- Fast-moving objects
- Objects that are poorly lit
- Objects with bright reflections or backlighting
- Flickering objects, such as fluorescent lights
- Point light sources, such as light bulbs, spotlights, or LEDs



Note that one or more focus frames may be displayed in green if the camera is unable to focus with the above subjects; check focus in the picture display before shooting. If the camera is unable to focus, lock focus on another object at the same distance from the camera as your subject, then recompose the photograph and take the picture (page 21).

**Tip: Avoiding Blurred Pictures**



To prevent blurring caused by the camera moving when the shutter is released (“camera shake”), press the shutter-release button smoothly and gently. Blurring is particularly likely to occur if:

- The flash is off and lighting is poor, or
- The camera is zoomed in (page 22)

In situations in which photographs are especially prone to blurring caused by camera shake, a  icon will be displayed in the picture display. Hold the camera steady and try focusing again, or attempt one of the following remedies:

- Turning the flash on () or using auto flash (; see page 24)
- Choosing a higher ISO (page 84)
- Using the self-timer (page 26)

**Notes**

- If the flash will fire when the picture is taken, a pre-flash will be emitted to assist focus and exposure.
- You can choose how long pictures are displayed in the picture display after shooting. If desired, photographs can be displayed until the shutter-release button is pressed halfway (page 126).
- In  mode, a built-in **n**eutral **d**ensity (ND) filter is used for between f/8.0 and f/11. The smallest aperture available in  mode is f/11.

Focus Lock

Use focus lock to compose photographs in which the subject is not in the center of the frame. Focus lock can also be used if the camera is unable to focus (page 18).

1 Focus.

Position your subject in the center of the picture display and press the shutter-release button halfway to focus.

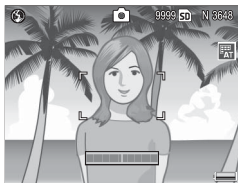

2 Recompose the photograph.

Keeping the shutter-release button pressed halfway to lock focus, recompose the photograph.

Final composition



Main subject



3 Take the picture.



Gently press the shutter-release button the rest of the way down to take the picture.







Caution

If the distance between the camera and subject changes while focus lock is in effect, focus again at the new distance.

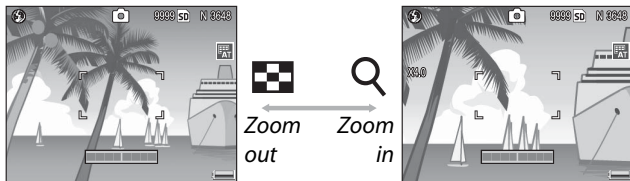
Digital Zoom

When **Digital Zoom** is selected for **Zoom Button** (page 122), the  button can be used to zoom in to a maximum of 4.0x. Use the  button to zoom out.



- 1 Assign digital zoom to the  and  buttons.**
Select **Digital Zoom** for the **Zoom Button** option in the setup menu (page 122).
- 2 Frame the picture using the  and  buttons.**
The zoom ratio is shown in the picture display.
- 3 Focus.**
Press the shutter-release button halfway to focus.
- 4 Take the picture.**
Gently press the shutter-release button the rest of the way down to take the picture.

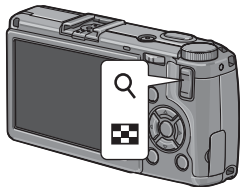



-  **Notes**
- If an option with a size of 3,648×2,736 is selected for **Picture Quality/Size**, **Auto Resize** can be selected for **Digital Zoom Image** (page 133).
 - Digital zoom is not available when a RAW-quality option is selected for **Picture Quality/Size** (page 57) or the camera is in dynamic range double shot mode (page 48).

Close-ups (Macro Mode)

Use macro mode for close-ups of small objects as close as 1.0 cm (0.4 in.) to the lens (at this distance, the area photographed will be about 26 × 19 mm/1.0 × 0.7 in.).

1 Press the button.

A  icon will be briefly displayed in the center of the picture display.  will then appear at the top of the display.

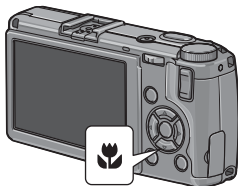

2 Focus.

Frame the subject in the picture display and press the shutter-release button half-way to focus.

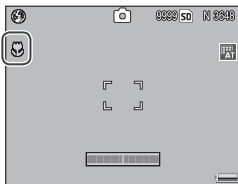

3 Take the picture.

Gently press the shutter-release button the rest of the way down to take the picture.

To exit macro mode, press the  button again.









Note

If an option other than **MF** or **Spot AF** is selected for **Focus** when the camera is in macro mode, the camera will focus using spot autofocus (page 59).

Flash Photography

The flash only fires when raised. Slide the ⚡ OPEN switch to raise the flash and press the ⚡ button to choose from the following flash modes:

Mode	Description
 Flash Off	The flash is off and will not fire.
 Auto	The flash fires automatically when required.
 Red-Eye Flash	Reduces “red-eye” in portraits taken with the flash.
 Flash On	The flash fires with every shot.
 Flash Synchro.	Combines the flash with slow shutter speeds. Use when taking portraits that include details of the background indoors or at night. Use of a tripod is recommended to prevent blur.
 Manual Flash	The flash fires with every shot; flash output is fixed at the level selected for Manual Flash Amount (page 73).

Note

The flash has a range of approximately 20 cm to 3.0 m (8 in.–10 ft.), measured from the front of the lens (auto ISO; see page 84).

Using the Built-in Flash

1 Raise the flash.

Slide the flash **OPEN** switch as shown.

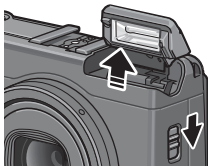

2 Select a flash mode.

Press the  button to select a flash mode. The flash mode icon is briefly displayed in the center of the picture display and then appears in the top left corner of the display.

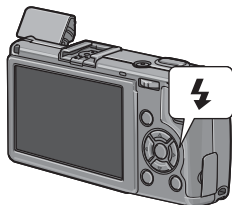

Note

The selected flash mode remains in effect until a new mode is chosen.

The autofocus/flash lamp blinks while the flash charges (if the camera is powered by AAA batteries, the picture display will turn off until charging is complete). Photos can be taken when the lamp stops blinking.

3 Focus and shoot.

If the flash is required, it will emit a pre-flash before each shot to help with focus and exposure.



Notes

- To close the flash when it is not in use, gently press the center of the flash cover down until it latches.
- The flash turns off automatically in dynamic double shot, movie, continuous, and bracketing modes.
- The built-in flash turns off automatically when an optional flash is used (pages 167, 168).



Cautions

- Do not use the built-in flash with conversion lenses or lens hoods.
- Do not use the flash unit in close proximity to your subject's eyes. Particular care should be observed when photographing infants. Do not direct the flash at the operator of a motor vehicle.

The Self-Timer

The camera offers a ten-second timer for self-portraits and a two-second timer to prevent blur caused by camera movement when the shutter-release button is pressed.

Note

By default, the self-timer is assigned to the **Fn2** button, but it can also be assigned to the **Fn1** button (the instructions that follow assume it is assigned to the **Fn2** button). The self-timer can only be used when assigned to a button (page 119).

1 Choose a self-timer mode.

Press the **Fn2** button once to select the ten-second timer and again to select the two-second timer. The current selection is displayed in the picture display. Pressing the button a third time turns the timer off.

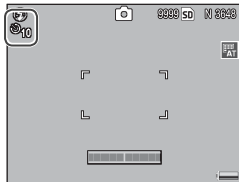

Note

The selected self-timer mode remains in effect until a new mode is chosen.

2 Start the timer.

Press the shutter-release button to lock focus and start the timer. If the ten-second timer is selected, the AF auxiliary light will light.

The Tilt Indicator

Use the tilt indicator to level the camera when photographing buildings or landscapes. It is particularly useful for compositions in which the horizon is visible.

1 Display level setting options.

Press and hold the  (DISP.) button until level setting options are displayed.

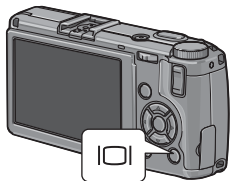

2 Highlight an option.

Press  or  to highlight an option:

Option	Description
Off	Tilt indicator not displayed.
Display	Tilt is shown in the picture display. The indicator turns orange when the camera is tilted; the amount and direction of rotation needed to bring it level is shown by the position of the indicator in the display (the indicator turns red if the angle is too great to be shown). The indicator turns green when the camera is level, either in the normal shooting orientation or rotated 90° to shoot pictures in "tall" orientation. Tilt is not shown if the display is off, indicators are hidden, or the framing grid is displayed (page 36).
Disp + Snd	As above, except that a beep sounds periodically when the camera is level.
Sound	A beep sounds periodically when the camera is level. The tilt indicator is not displayed in the picture display.

3 Select the highlighted option.

Press MENU/OK to select the highlighted option.

Understanding the Tilt Indicator



Green

Camera level



Orange

Tilt camera left to level

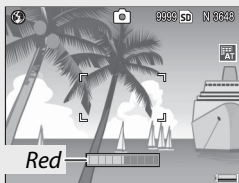

Red

Unable to measure tilt; camera rotated too far forward or back



Camera tilted 90° left



Note

Tilt indicator settings can also be adjusted in the setup menu (pages 113, 127).



Cautions

- The tilt indicator is not displayed when the camera is upside down, movies are being recorded, or the interval timer is on.
- Muting the camera speaker (pages 125–126) also mutes the beep that sounds to indicate that the camera is level.
- The tilt indicator is intended as a guide only and should not be used as a spirit level or in other applications in which a high degree of precision is required. Accuracy drops when the camera is in motion or you are shooting on a vehicle or other moving platform.

Viewing and Deleting Photographs

Pictures can be viewed in the picture display.



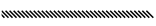

Viewing Photographs

Press the  button to display the last photograph viewed.

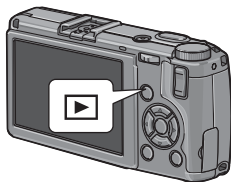
 **Tip: If the Camera Is Off** 

If the camera is off, press the  button for about a second to turn the camera on and start playback.



Press  to view photographs in the order recorded,  to view in reverse order. Press  to skip ahead ten frames,  to go back ten frames.

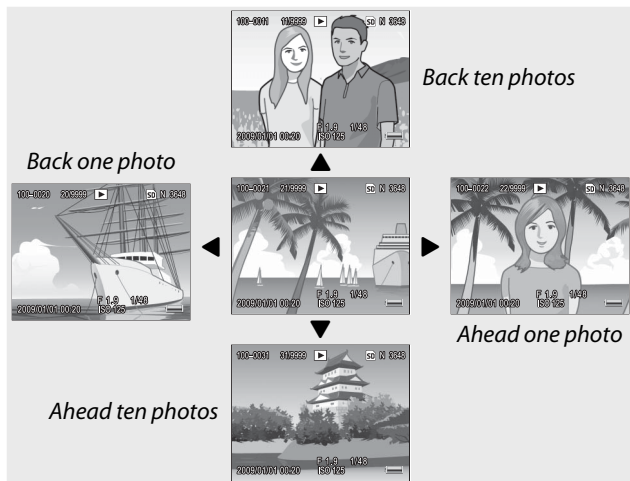

Press the  button again to exit to shooting mode.

**Caution: RAW Images**

The camera records JPEG copies of RAW images for display in the picture display. When a RAW image is selected for playback, the camera shows the JPEG copy and a RAW-mode indicator is displayed. If the JPEG copy has been deleted using a computer or other device, the camera will display a small preview of the RAW image, but you will not be able to view the image at larger magnifications. See pages 57, 58 for information on recording RAW images.

**Tip: Viewing Pictures in Shooting Mode**

Photographs are displayed in the picture display immediately after shooting. You can choose how long pictures are displayed using the **LCD Confirmation Time** option in the setup menu (page 126).



**Tip: Viewing the Pictures in Internal Memory**

If a memory card is inserted, the pictures on the memory card will be displayed; the pictures in internal memory can not be viewed even if the memory card is empty. The pictures in internal memory will only be displayed if no card is inserted in the camera.





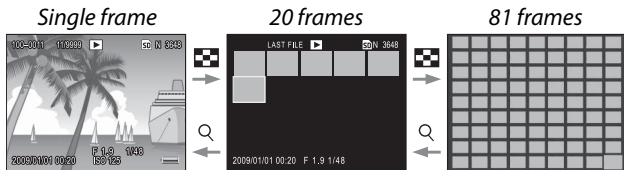
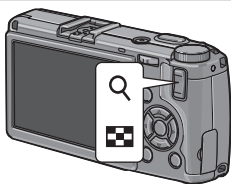

**Tip: Auto Rotate**

If **On** is selected for **Auto Rotate** in the setup menu, pictures will automatically be displayed in the correct orientation in the picture display (page 127).

Viewing Multiple Photographs

Use the  and  buttons to choose the number of photos displayed from one, 20, and 81. Multi-frame views can be used to select images for display or deletion.



In multi-frame views, press , , , and  to highlight photographs. In 20-frame view, press  or press the ADJ. lever in to view the highlighted frame full frame. In 81-frame view, press  to return to 20-frame view or press the ADJ. lever in to display the highlighted photo full frame.

Playback Zoom

Press the **Q** button or rotate the up-down dial to zoom in on the photo currently displayed full frame. To zoom in to the magnification selected with **One Press Zoom Ratio** (page 126), press the **ADJ.** lever in.

The following operations can be performed:

Use	To
Q	Zoom in.
Up-down dial	Rotate right to zoom in, left to zoom out.
MENU/OK	Zoom in to magnification selected for One Press Zoom Ratio . If picture is displayed at maximum magnification, pressing MENU/OK cancels zoom.
▲▼◀▶	View other areas of the image.
ADJ. lever	Press left or right to view other images at same zoom ratio.
☒	Cancel zoom.

Notes

- Maximum magnification varies with image size:

Image size (pixels)	Maximum magnification
2,048 × 1,536 or larger	16×
1,280 × 960	6.7×
640 × 480	3.4×

- Playback zoom is not available with movies or with photographs taken at settings of **S-Cont** or **M-Cont**.
- If **Setting2** is selected for **Playback Mode Dial Options** in the setup menu (page 123), the **ADJ.** lever and up-down dial can be used to view other areas of the image.



Deleting Photographs

Follow the steps below to delete unwanted photos.

Deleting Individual Photographs

1 Display a photograph you want to delete.

Display a photograph you want to delete in single-frame playback (page 29).

2 Press the button.

The options shown at right will be displayed (if the current image is not one you wish to delete, press ◀ or ▶ to display the desired photo).

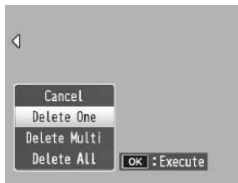

3 Highlight Delete One.

Press ▲ or ▼ to highlight **Delete One**.

4 Press MENU/OK.

A message is displayed during deletion. The options shown above will then be displayed; repeat Steps 2 and 3 to delete additional photographs, or highlight **Cancel** and press MENU/OK to exit.

Deleting All Files

To delete all files, press the  button to display delete options as described above and select **Delete All**. A confirmation dialog will be displayed; press ◀ or ▶ to highlight **Yes** and press MENU/OK.

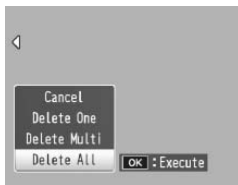

Deleting Multiple Files

Follow the steps below to delete multiple selected files.

1 Press the button.

In multi-frame playback, proceed to Step 2. In single-frame playback, the options shown at right will be displayed. Highlight **Delete Multi** and press MENU/OK.







2 Select **Sel. Individ.** or **Sel. Range**.



To select images one at a time, highlight **Sel. Individ.**, press MENU/OK, and proceed to Step 3. To select one or more ranges consisting of two images and all photographs between them, highlight **Sel. Range**, press MENU/OK, and proceed to Step 3.1. To exit at any time without deleting files, press DISP.



3 Select photographs.

Press , , , or  to highlight photos and press MENU/OK to select. Selected pictures are marked with  icons. To deselect a photo, highlight it and press MENU/OK again.



 **Tip: Selecting Ranges** 

To select one or more ranges consisting of two images and all photographs between them, press the **ADJ.** lever in and follow the steps below:

- 3.1** Press ▲, ▼, ◀, or ▶ to highlight the first image and press **MENU/OK** to select. The selected image is marked with a  icon. If you selected the wrong image, press **DISP.** and try again.



- 3.2** Press ▲, ▼, ◀, or ▶ to highlight the last image and press **MENU/OK** to select. The selected image and other images in the selected range will be marked with  icons.



Repeat Steps 3.1–3.2 to select additional ranges, or press the **ADJ.** lever in to return to Step 3 and select or deselect individual photographs.

- 4** Press .
- A confirmation dialog will be displayed.

- 5** **Select Yes.**
- Press ◀ or ▶ to highlight **Yes** and press **MENU/OK**.

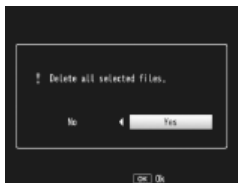

The (DISP.) Button

Use the  (DISP.) button to choose the information displayed in the picture display during shooting and playback.

Shooting Mode



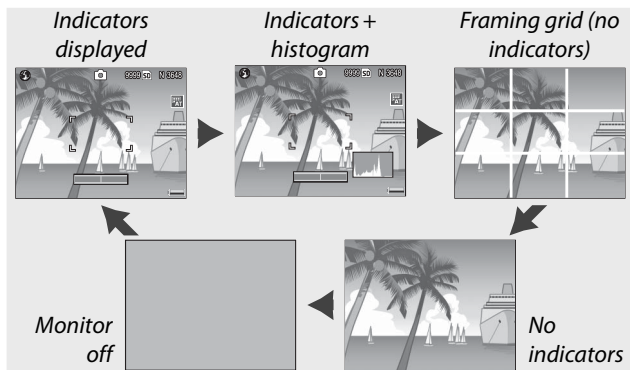



Press the  (DISP.) button to cycle through the following displays:



Tip: The Framing Grid

See page 128 for information on choosing a framing grid. The grid lines do not appear in the final photograph.

Notes

- If **Display** or **Display+Sound** is selected for **Level Setting**, a tilt indicator appears when indicators are displayed.
- When the picture display is off, pressing any of following turns the picture display on: the **ADJ.** lever, the **MENU/OK**,  (DISP.), and  buttons, the  and  buttons (except when **Off** is selected for **Zoom Button**; page 122), and the  and  buttons (manual focus mode only).

Playback Mode

Press the  (DISP.) button to cycle through the following displays:

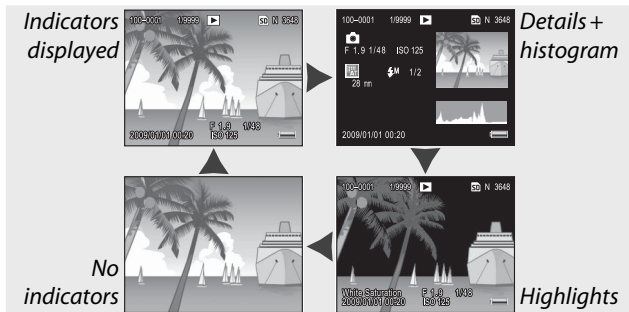

Tip: Highlights

The flashing portions of the highlights display mark “washed out” areas in which details may have been lost to overexposure. Check highlights after shooting in direct sunlight or in other conditions in which parts of the image may be overexposed. If it seems important details may have been lost, choose a lower exposure compensation value and shoot again (page 77). Note that the display is intended only as a guide and may not be entirely accurate.



Tip: The Histogram

The histogram is a graph showing the distribution of pixels of different brightness in the image. Brightness is plotted on the horizontal axis, with shadows at the left and highlights at the right. The vertical axis gives the number of pixels. The histogram can be used to assess exposure and check for loss of detail in highlights and shadows without the brightness of your surroundings affecting your judgement. A histogram in which pixels are clustered on the right indicates that the image may be overexposed, while a histogram in which pixels are clustered on the left indicates that the image may be underexposed.



Overexposed



Underexposed

If the image appears to be incorrectly exposed, you may be able to use exposure compensation to correct exposure in subsequent photographs of the same subject (page 77; note that exposure compensation may be insufficient to produce the correct exposure in some cases). The histogram can also be used as a guide when adjusting contrast in photographs after shooting (pages 101, 102).

The histogram is intended as a guide only and may not be completely accurate, particularly in cases in which the flash is used or ambient lighting is poor.

Reference

Read this section for more information on camera functions.

■ More on Photography	40
■ Movies	87
■ More on Playback.....	91
■ Printing Photographs	106
■ The Setup Menu	112
■ Copying Pictures to a Computer.....	136
■ Technical Notes	150

More on Photography

This section provides information on P, A, S, M, **SCENE**, and “MY” modes and on using shooting menu options.

Mode P: Program Shift

When the mode dial is rotated to P (program shift), you can use the up-down dial to choose from several combinations of shutter speed and aperture, all of which produced the same exposure.

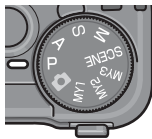

1 Choose mode P.

Rotate the mode dial to P. The shooting mode is shown by an icon in the display.



2 Measure exposure.

Press the shutter-release button halfway to measure exposure. The current shutter speed and aperture appear in the display.

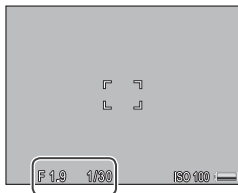

3 Choose shutter speed and aperture.

Remove your finger from the shutter-release button and rotate the up-down dial to select a combination of shutter speed and aperture.

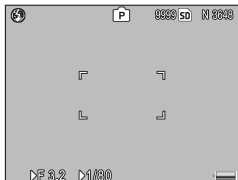

**Note**

Shutter speed and aperture can be adjusted for ten seconds after you remove your finger from the shutter-release button.

4 Take the photograph.

Gently press the shutter-release button all the way down to take the photograph.

**Note: The Exposure Program**

The exposure program (ISO 100, flash off) is shown below. The shaded area gives the combinations of shutter speed and aperture available at each exposure value (EV).

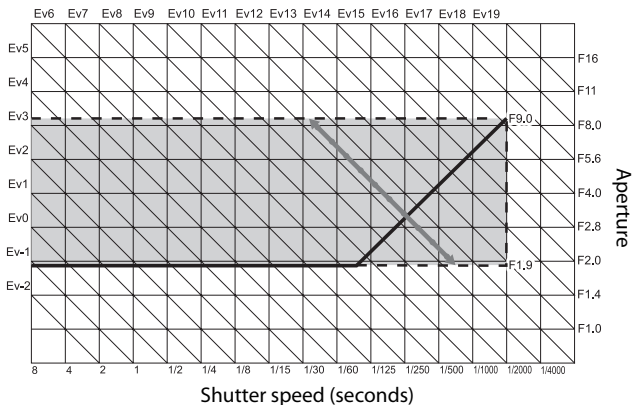

Mode A: Aperture Priority

In mode A (aperture priority), you choose the aperture and the camera selects the shutter speed. Choose large apertures (low f-numbers) to emphasize the main subject by blurring background and foreground details. Choose small apertures (high f-numbers) to bring both the background and main subject into focus.

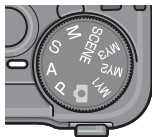

1 Choose mode A.

Rotate the mode dial to A. The current aperture is displayed in orange.

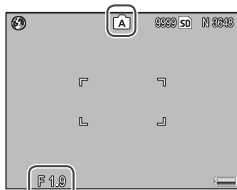

2 Choose an aperture.

Rotate the up-down dial to choose an aperture. Your selection only takes effect when the photo is taken; the effect can not be previewed in the picture display.

3 Press the shutter-release button halfway.

Press the shutter-release button halfway to set focus and exposure. The shutter speed selected by the camera will be displayed in the picture display.



4 Take the photograph.

Gently press the shutter-release button the rest of the way down to shoot.

Note

If auto aperture shift is on (page 85), the camera will adjust aperture for optimal exposure.

Mode M: Manual Exposure

In mode M (manual exposure), you use the up-down dial to choose aperture and the ADJ. lever to select a shutter speed.

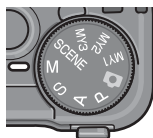

1 Choose mode M.

Rotate the mode dial to M. The shooting mode, exposure indicator, and current aperture and shutter speed appear in the display.

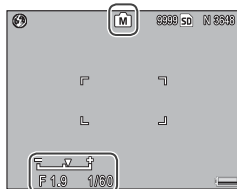

2 Choose an aperture and shutter speed.

Rotate the up-down dial to choose an aperture and press the ADJ. lever left or right to select a shutter speed (if desired, the roles of the two controls can be reversed; see page 123). The effects can be previewed in the picture display and are reflected in the exposure indicator (if the image would be under- or over-exposed by more than 2 EV, the effects can not be previewed and the indicator will turn orange).



3 Focus.



Press the shutter-release button halfway to focus.

4 Take the photograph.

Gently press the shutter-release button the rest of the way down to shoot.







Notes

- If **Auto** or **Auto-Hi** is selected for **ISO Setting** (page 84), ISO will be fixed at 100 while the camera is in manual exposure mode.
- Choose slower shutter speeds for longer exposure times. To reduce blur caused by camera shake, hold the camera steadily in both hands or use a tripod. The picture display turns off while the shutter is open. *At speeds of 10 s or slower, the camera automatically processes photographs to remove noise, increasing the time needed to record images to about twice the shutter speed.*
- Autoexposure (AE) lock is not available in manual exposure mode. If **AE Lock** is selected for **Set Fn1 Button** or **Set Fn2 Button** in the setup menu, pressing the affected button in manual exposure mode will set shutter speed or aperture to a value close to that needed for optimal exposure. Similarly, if **Exposure Comp.** is selected for **Zoom Button** in the setup menu, pressing the  and  buttons will not display exposure compensation options in manual exposure mode, but will instead set shutter speed or aperture to a value close to that needed for optimal exposure. This is useful when you want to use optimal exposure as a starting point for modifying exposure. The **One Press M Mode** option in the setup menu determines whether shutter speed or aperture is altered to achieve optimal exposure.

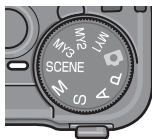
SCENE Mode: Matching Settings to the Scene

Select **SCENE** mode to shoot movies or to choose from one of the following subject types. Camera settings are automatically optimized for the selected subject type.



Option	Description
 Dynamic Range	Choose for natural contrast when photographing subjects that are partly in the shade on a sunny day and other high-contrast scenes (page 48). A tripod is required; results are not guaranteed with subjects that are in motion.
 Skew Correct Mode	Reduce the effects of perspective when photographing rectangular objects, such as message boards or business cards (page 51).
 Text Mode	Make black-and-white photographs of text or drawings on notepaper or a white board (page 52).
 Movie	Shoot movies with sound (page 87).

To select a scene mode option:

1 Rotate the mode dial to **SCENE**.

The option currently selected for **SCENE** mode appears in the display.



2 Press MENU/OK.

A menu of scene mode options will be displayed.

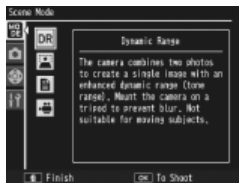

3 Select an option.

Press ▲ or ▼ to highlight an option and press MENU/OK to return to shooting mode with the selected option shown at the top of the display.

4 Shoot.

- **Dynamic range double shot:** See page 48.
- **Skew correct mode:** See page 51.
- **Text mode:** See page 52.
- **Movie mode:** See page 87.



Tip: Using the Menus

To access the shooting and setup menus in **SCENE** mode, press the **MENU/OK** button to display the scene mode menu and press ◀ to highlight the mode tab. Press ▲ or ▼ to highlight the shooting menu tab (page 54), key custom settings tab (page 112), or setup menu tab (page 112), and press ▶ to place the cursor in the selected menu. See pages 55–56 for information on the shooting menu options available in each mode.

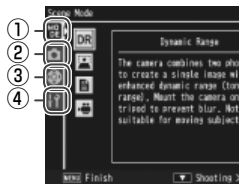

- ① Mode tab
- ② Shooting menu tab
- ③ Key custom settings tab
- ④ Setup menu tab

SCENE Mode: Dynamic Range Double Shot

Each time the shutter-release button is pressed, the camera takes two shots at different exposures, then combines the areas that are correctly exposed to create a single composite image with natural contrast, reducing loss of detail in highlights and shadows. Use to photograph scenes that contain both sunlight and shade or other high-contrast subjects.

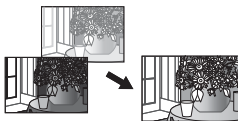

Cautions

- The flash turns off, digital zoom can not be used, and RAW options can not be selected for **Picture Quality/Size** (page 57).
- The desired effect may not be achieved if the scene is too bright or too dark.
- Moving subjects may be blurred.
- Flicker from fluorescent lights may affect colors and brightness.

Tip: Dynamic Range

“Dynamic range” refers to the range of tones that can be expressed by the camera, which is narrower than that visible to the naked eye. In high-contrast scenes, this may result in loss of detail in highlights and shadows. Dynamic range double shot creates a smooth transition from highlights to shadows for natural contrast.

1 Mount the camera on a tripod.

Note

Dynamic range double shot requires more time to create an exposure than other modes, and an  icon is displayed to show that photos may be blurred. Use a tripod. Note that the camera may move when the shutter-release button is pressed, even if mounted on a tripod. This can be prevented by using the self-timer (page 26) or an optional CA-1 cable switch wired remote shutter release.

2 Focus.

Press the shutter-release button halfway to set focus, exposure, and white balance.



3 Shoot.

Gently press the shutter-release button the rest of the way down. The camera will take two pictures and combine them to create a single image with an enhanced dynamic range.



Shooting Menu Options

The following shooting menu options are available only in dynamic range double shot mode:

- **Dynamic Range Expansion:** Choose amount by which dynamic range is enhanced.
- **Plus Normal Shooting:** Choose **On** to record two copies of each photo, one with normal exposure and another with enhanced dynamic range.



Copy with enhanced dynamic range

+



Unmodified copy

Follow the steps below to adjust these options in dynamic range double shot mode.

1 Display the shooting menu.

Press **MENU/OK** to display the scene-mode menu. Press **◀** to highlight the mode tab, press **▼** to highlight the shooting menu tab, and press **▶** to place the cursor in the shooting menu.

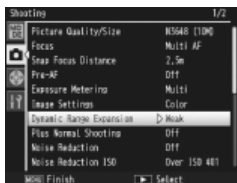

2 Select a menu item.

Press **▲** or **▼** to highlight **Dynamic Range Expansion** or **Plus Normal Shooting** and press **▶** to display options for the highlighted item.

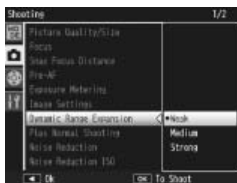

3 Select an option.

Press **▲** or **▼** to highlight an option and press **MENU/OK** to select.



Tip: Plus Normal Shooting

When photographs taken with **On** selected for **Plus Normal Shooting** are displayed in the picture display after shooting, both the enhanced and unmodified copies appear with histograms showing tone distribution. If **Hold** is selected for **LCD Confirmation**

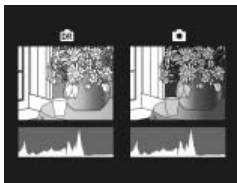

Time in the setup menu (page 126), the images will be displayed until the shutter-release button is pressed halfway.

To take pictures in skew correct mode, frame the subject so that it occupies as much of the frame as possible and press the shutter-release button to take the photograph. If the camera is able to detect an object that can be used to correct perspective, a message will be displayed with the object shown by an orange frame. The camera can detect up to five objects; to select a different object, press **▶**, or press **▲** to record the photograph without correcting perspective. If the camera is unable to detect a suitable subject, an error message will be displayed and the photograph will be recorded without modification.

**Caution: Skew Correct Mode**

The camera records two images each time the shutter is released: the unmodified photograph and a copy that has been processed to correct perspective. No photograph will be taken if memory is insufficient to record two images. The camera may be unable to correct perspective if:

- The subject is out of focus.
- The four edges of the subject are not clearly visible.
- There is little contrast between the subject and the background.
- The background contains many fine details.

**Tip: Skew Correction**

The **Skew Correction** option in the playback menu can be used to correct perspective in existing photographs (page 98).

To take pictures in text mode:

1 Adjust contrast.

Press the ADJ. lever in to display the menu shown at right. Press ▲ or ▼ to highlight an option and press the ADJ. lever or MENU/OK to select the highlighted option and clear the menu from the display.



Tip: Adjusting Contrast

Contrast can also be adjusted using the **Density** option in the shooting menu (page 56).

2 Take the photograph.

Press the shutter-release button halfway to focus, then gently press it the rest of the way down to take the photograph.

“MY” Modes: Using Custom Settings

To take photos using settings saved with the **Reg. My Settings** > **MY1** option in the setup menu key custom settings tab (page 114), rotate the mode dial to **MY1**. Select **MY2** to take photos using the settings saved with **MY2**, **MY3** to take photos using the settings saved with **MY3**.

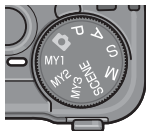

1 Rotate the mode dial to MY1, MY2, or MY3.

The shooting mode saved using **Reg. My Settings** will be displayed in the picture display.



Note

Menu settings can be freely adjusted in “MY” modes. The settings saved with **Reg. My Settings** are restored when another mode is selected or the camera is turned off.

Tip: Choosing a Shooting Mode

To choose a shooting mode in “MY” mode without changing other settings, use the **Switch Shooting Mode** option in the shooting menu (page 86). **Switch Shooting Mode** is not available in “MY” modes for which a scene mode is selected.

2 Take the photograph.

See the section on the selected shooting mode for more information.

The Shooting Menu

Use the ▲, ▼, ◀, ▶, and MENU/OK buttons to navigate the menus.

1 Display the shooting menu.

In modes other than **SCENE**, pressing the MENU/OK button in shooting mode displays the shooting menu.

 **Tip: SCENE Mode** ~~~~~

In **SCENE** mode, pressing MENU/OK displays the mode menu; press ◀ to highlight the mode tab, ▼ to display the shooting menu, and ▶ to place the cursor in the menu.

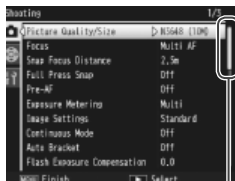

Scroll bar shows position in menu

2 Select a menu item.

Press ▲ or ▼ to highlight a menu item and press ▶ to display options for the highlighted item.



3 Select an option.

Press ▲ or ▼ to highlight an option. Press MENU/OK to select and exit to shooting mode, or press ◀ to select and return to the shooting menu.

The items available in the shooting menu vary with the shooting mode.

P, A, S, M, MY1, MY2 and MY3 Modes

Option	Default	Page	Option	Default	Page
Picture Quality/Size	N3648 (10M)	57	Noise Reduction ISO	Over ISO 401	74
Focus	Multi AF	59	Interval Shooting	—	75
Snap Focus Distance	2.5 m	64	Date Imprint	Off	76
Full Press Snap	On	64	Exposure Compensation ¹	0.0	77
Pre-AF	Off	65	White Balance	Multi-P AUTO	79
Exposure Metering	Multi	65	White Balance Compensation	A: 0; G: 0	82
Image Settings	Standard	66	ISO Setting	Auto	84
Continuous Mode	Off	68	Restore Defaults ²	—	85
Auto Bracket	Off	70	Auto Aperture Shift ³	Off	85
Flash Exposure Compensation	0.0	72	Switch Shooting Mode ⁴	—	86
Manual Flash Amount	1/2	73	1 Not available in mode M.		
Flash Synchro Settings	1st Curtain	73	2  mode only.		
Noise Reduction	Off	74	3 Mode A only.		
			4 Mode MY1, MY2 or MY3 only.		

SCENE Mode: Movie

Option	Default	Page	Option	Default	Page
Movie Size	640	89	Pre-AF	Off	65
Frame Rate	30 Frame/Sec	89	White Balance	Auto	79
Focus	Multi AF	59	White Balance Compensation	A: 0, G: 0	82
Snap Focus Distance	2.5 m	64			

SCENE Mode: Dynamic Range Double Shot

Option	Default	Page	Option	Default	Page
Picture Quality/Size	N3648 (10M)	57	Noise Reduction	Off	74
Focus	Multi AF	59	Noise Reduction ISO	Over ISO 401	74
Snap Focus Distance	2.5 m	64	Date Imprint	Off	76
Pre-AF	Off	65	Exposure Compensation	0.0	77
Exposure Metering	Multi	65	White Balance	Multi-P AUTO	79
Image Settings	Standard	66	White Balance Compensation	A: 0; G: 0	82
Dynamic Range Expansion	Weak	49	ISO Setting	Auto	84
Plus Normal Shooting	Off	49			

SCENE Mode: Skew Correct

Option	Default	Page	Option	Default	Page
Picture Quality/Size	N1280 (1M)	57	Flash Exposure Compensation	0.0	72
Focus	Multi AF	59	Flash Synchro Settings	1st Curtain	73
Snap Focus Distance	2.5 m	64	Date Imprint	Off	76
Full Press Snap	On	64	Exposure Compensation	0.0	77
Pre-AF	Off	65	White Balance	Multi-P AUTO	79
Exposure Metering	Multi	65	ISO Setting	Auto	84
Image Settings	Standard	66			

SCENE Mode: Text

Option	Default	Page	Option	Default	Page
Density	Normal	46, 52	Pre-AF	Off	65
Size	N3648 (10M)	57	Date Imprint	Off	76

Picture Quality and Size

Picture quality (RAW, fine, and normal) and size (dimensions in pixels) determine the number of photographs that can be stored in internal memory or on a memory card (page 13). The following options are available:

Option	Quality	Size	Description
RAW (10M) ¹	RAW	3,648 × 2,736	Produces images adapted for further processing or editing on a computer.
RAW 3:2 (9M) ^{1,2}		3,648 × 2,432	
RAW 1:1 (7M) ^{1,2}		2,736 × 2,736	
F3648 (10M)	Fine	3,648 × 2,736 ³	Produces images that can be printed at larger sizes or cropped on a computer.
N3648 (10M)	Normal		
F3:2 (9M) ²	Fine	3,648 × 2,432	
N3:2 (9M) ²	Normal		
F1:1 (7M) ²	Fine	2,736 × 2,736	
N1:1 (7M) ²	Normal		
N3264 (8M)		3,264 × 2,448	
N2592 (5M)		2,592 × 1,944	Produces images suitable for printing.
N2048 (3M)		2,048 × 1,536 ³	
N1280 (1M) ⁴		1,280 × 960	Allows more photos to be stored.
N640 (VGA) ⁴	640 × 480	Produces small images suited to e-mail or the web and allows more photos to be stored.	

1 Not available in dynamic range double shot mode.

2 Edges of display blacked out to show crop in picture display.

3 One of two options available in text mode.

4 One of two options available in skew correct mode.



Tip: Picture Quality



The camera supports the following picture qualities:

- **Normal:** JPEG compression is used to reduce file size.
- **Fine:** Compression is reduced for improved quality. File size increases, reducing number of photos that can be recorded.
- **RAW:** Raw image data are saved in DNG format; JPEG copies are also created. The camera displays only the JPEG copy; DNG files can be viewed and edited on a computer using the supplied Irodio Photo & Video Studio Software (Windows only) or commercially-available applications that support the DNG format.

Unlike normal- and fine-quality images, RAW images are not compressed. This increases file size but avoids the loss of quality associated with JPEG compression. Note the following when shooting RAW images:

- Some settings can not be used, as detailed in the section for the affected setting. **Image Settings** and **Date Imprint** options apply only to JPEG copies and have no effect on the DNG images.
- The size and quality of the JPEG copies recorded with DNG images can be selected using the **RAW/JPEG Setting** option in the setup menu (page 131).
- The number of RAW photographs that can be taken in a single burst in continuous mode varies with the option selected for **Noise Reduction** (page 74). Up to five photographs can be taken when noise reduction is disabled; when noise reduction is enabled, this number drops to four.

Choose how the camera focuses. By default, the camera uses autofocus; other options are listed below.

Option	Description
Multi AF	The camera selects the focus area with the closest subject, preventing out-of-focus shots by keeping the camera from focusing on the background.
Spot AF	Focus on the subject in the center of the frame.
 MF (manual focus)	Focus manually (page 60).
 Snap	Focus is fixed at distance selected with Snap Focus Distance (page 64) for quick shutter response.
 ∞ (infinity)	Fix the focus distance at infinity when photographing distant scenes.

In the case of **MF**, **Snap**, and ∞ , the current selection is shown by an icon in the picture display.



Tip: Depth of Field

Depth of field is the distance in front of and behind the focus point that appears to be in focus. Small apertures (high f-numbers) increase depth of field, bringing more of the scene into focus; large apertures (low f-numbers) decrease depth of field, emphasizing the main subject by blurring the foreground and background. At settings of **MF**, **Snap**, and ∞ , the focus bar shows depth of field in shooting modes **M**, **A**, and **P** (in mode **P**, depth of field is only shown when the shutter-release button is pressed halfway and aperture values are displayed).

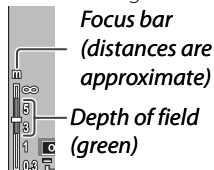

Note

The **Fn** buttons can be used to switch back and forth between autofocus and manual or snap focus (page 121).

Focus: MF (Manual Focus)

Manual focus can be used to lock focus over a series of photographs or to focus when the camera is unable to focus using autofocus.

Note

Manual focus is not available in text mode (page 46).

1 Select MF (manual focus).

Select **MF** in the **Focus** menu. The focus mode and focus bar (page 59) are displayed in the picture display.

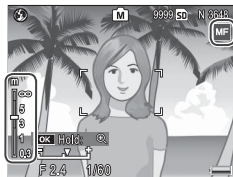

2 Choose the focus distance.

Press **▲** to increase the focus distance, **▼** to decrease.

To zoom in on the subject in the center of the picture display and check focus, press and hold the **MENU/OK** button. Press and hold the button again to return to the normal shooting display.

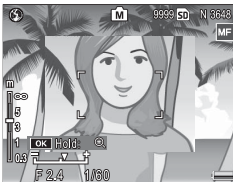

3 Take the picture.

See the section on the selected shooting mode for more information.

Choosing the Focus and Metering Target

Target selection can be used to set focus and exposure for off-center subjects without moving the camera, making it easier to use a tripod.

1 Activate target selection.

Press the **ADJ.** lever in and then press the lever left or right to highlight . Press **▲** or **▼** to highlight one of the following options and press **MENU/OK** to select.



Option	Description
AE/AF	Spot metering and spot autofocus; choose the focus and exposure target.
AF	Spot autofocus; choose the focus target. Exposure is metered using the option selected for Exposure metering (page 65).
AE	Spot metering; choose the metering target. Focus is set using the option selected for Focus (page 59).
Off	Target selection off.

2 Position the target.

Using the **▲**, **▼**, **◀**, and **▶** buttons, position the cross hairs over your subject and press **MENU/OK** (to return to the target selection menu, press **DISP.**).



3 Take the picture.

Press the shutter-release button halfway to set focus and/or exposure for the selected subject and then gently press the shutter-release button the rest of the way down to take the picture.



Notes

- Target selection is not available in manual focus mode (page 60).
- The selected target remains in effect until a new target is selected. Note that target will be reset if you choose a new option in the target-selection menu or select manual focus.
- When the mode dial is rotated to **SCENE**, the focus target for macro mode can be selected by pressing the **ADJ.** lever in, selecting , and then using the ▲, ▼, ◀, and ▶ buttons to position the cross-hairs as described on page 63.
- The **Fn** buttons can be used for focus target selection in macro mode (see below). Note that if the **Fn** buttons have been used to select the focus target, the **ADJ.** lever can not be used for target selection until the target is reset.



Macro Target Selection

If **Macro Target** is assigned to the **Fn1** or **Fn2** button (pages 121–122), you can select macro mode by pressing the chosen button in shooting mode. The cross-hairs shown at right will be displayed; use the ▲, ▼, ◀, and ▶ buttons to position the cross-hairs over your subject and press **MENU/OK** (to exit without moving the target, press **DISP.**). Press the shutter-release button halfway to focus on the selected target and then gently press the shutter-release button the rest of the way down to take the picture.



Note that if the **ADJ.** lever has been used to select the focus target, the **Fn** buttons can not be used for target selection until the target is reset. Target selection can be reset by pressing the  button.

Snap Focus Distance

Select the distance at which the camera focuses when **Snap** is selected for **Focus** (page 59) or **Full Press Snap** is on (see below). Choose from 1 m (3.3 ft.), 2.5 m (8.2 ft.), 5 m (16.4 ft.), and ∞ (infinity).



Note

When **Snap** is selected for **Focus** or **Full Press Snap** is on, the snap focus distance can also be selected by pressing **▲** and rotating the up-down dial.

Full Press Snap

Take photographs without pausing to focus the camera when **Multi AF** or **Spot AF** is selected for **Focus** (page 59).

Option	Description
Off	The camera focuses normally.
On	If the shutter-release is pressed all the way down in one motion, the camera will take a picture at the focus distance selected for Snap Focus Distance . Choose when quick shutter response is required.
On (Auto-Hi ISO)	As for On , except that ISO sensitivity is automatically set to Auto-Hi (page 84).



Tip: Autofocus

The camera will focus normally if you pause with the shutter-release button pressed halfway.



Cautions

- Full press snap is not available in macro mode or when **MF**, **Snap**, or ∞ is selected for **Focus**.
- Care is required to avoid blur caused by camera movement.

Pre-AF

If **On** is selected when **Multi AF** or **Spot AF** is selected for **Focus** (page 59), the camera will continue to focus even when the shutter-release button is not pressed halfway (the focus range, however, is narrower than for normal focus). This may decrease the time needed to focus when a picture is taken, potentially improving shutter response.





Cautions

- Pre-AF is not available when **MF**, **Snap**, or ∞ is selected for **Focus**.
- Using pre-AF increases the drain on the battery.

Exposure Metering

Choose how the camera measures exposure.





Option	Description
Multi	The camera meters exposure in 256 areas of the frame.
 Center	The camera meters the entire frame but assigns the greatest weight to the center. Use when the subject in the center of the frame is brighter or darker than the background.
 Spot	The camera meters only the subject in the center of the frame, ensuring that it is correctly exposed even when it is markedly brighter or darker than the background.

Settings of **Center** and **Spot** are shown by an icon in the picture display.



Image Settings

Control contrast, sharpness, and vividness (color depth) or take monochrome photographs.

Option	Description
 Vivid	Take strong, vivid photos with heightened contrast and sharpness and maximum vividness.
Standard	Normal contrast, sharpness, and vividness.
 Black & White	Take photos in black and white. Contrast and sharpness can be adjusted manually.
 B&W (TE) (toning effect)	Create monochrome photos with a sepia, red, green, blue, or purple tint. Vividness, contrast, and sharpness can be adjusted manually.
 Setting 1  Setting 2	Make individual adjustments to vividness, contrast, sharpness, colors and hue to create custom settings that can be recalled as desired.

Note

Contrast has no effect in dynamic range double shot mode.

At settings other than **Standard**, the current selection is shown by an icon in the picture display.



To make individual adjustments to the settings for **Black & White**, **B&W (TE)**, **Setting 1**, or **Setting 2**, highlight the desired option and press **▶**.

1 Adjust custom color reproduction settings.

- **Black & White:** Press **▲** and **▼** to highlight an option and press **◀** and **▶** to change.

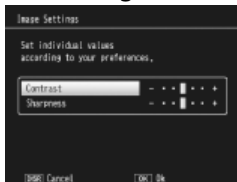

- **B&W (TE):** Adjust vividness, contrast, and sharpness as described above. To choose a tint, highlight **Toning Effect** and press **▶**. Press **▲** and **▼** to highlight an option and press **◀** to select.
- **Setting1/Setting2:** Adjust vividness, contrast, and sharpness as described above. To adjust individual colors, highlight **Colors** and press **▶**. Press **▲** and **▼** to highlight an option and press **◀** and **▶** to change. Press **MENU/OK** to exit when settings are complete.

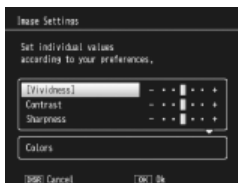
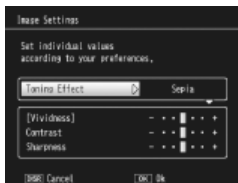

2 Press MENU/OK.

Press **MENU/OK** to return to the **Image Settings** menu when settings are complete.

3 Exit to shooting mode.





Press **MENU/OK** to exit to shooting mode, or press **◀** and then press **MENU/OK**.

The option currently selected for **Image Settings** will be displayed in the picture display.

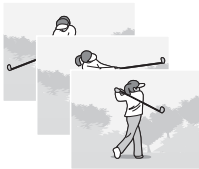

Continuous Mode

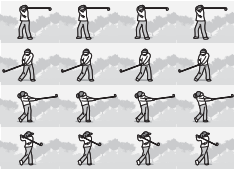
Shoot photographs one at a time or in continuous sequence. The following options are available:

- **Off:** One photo is taken each time the shutter-release button is pressed.
-  **Continuous:** The camera records photographs one after the other while the shutter-release button is pressed. 
-  **S-Cont** (stream continuous): While the shutter-release button is pressed, the camera shoots up to 16 frames at about 7.5 frames per second and joins them to form a single image 3,648 × 2,736 pixels in size. About 2 s are required to shoot the entire sequence. 
-  **M-Cont** (memory-reversal continuous): The camera shoots while the shutter-release button is pressed, but only the last 16 frames (about the last two seconds of shooting) are recorded, creating a single image 3,648 × 2,736 pixels in size.

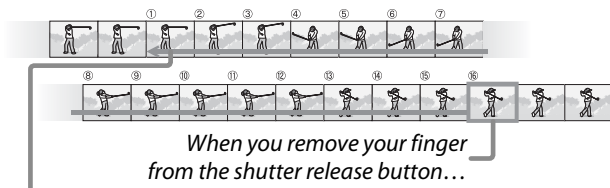

...the camera records the frames taken in the last two seconds (frames ① to ⑯).

At settings other than **Off**, the current selection is shown by an icon in the picture display.



Caution

Digital zoom is available at settings of **S-Cont** and **M-Cont** even if **Auto Resize** is selected for **Digital Zoom Image**.



Notes

- At settings other than **Off**, the flash turns off automatically, focus and exposure are fixed with the first shot in each series, and **Auto** white balance is used in place of **Multi-P AUTO** (page 79).
- ISO settings of **ISO 100** or **ISO 64** will be set to **Auto** while **S-Cont** or **M-Cont** are in effect.





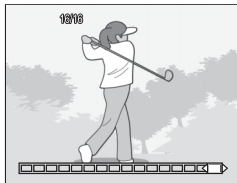

Tip: Viewing S-Cont and M-Cont Images with Playback Zoom

Zoom can be used to view the individual frames of **S-Cont** and **M-Cont** images during playback. Pressing the **Q** button while an image taken with either of these options is displayed in single-frame playback displays the first frame in the sequence; use the **◀** and **▶** buttons to display other frames. Your current position in the sequence is shown by strip at the bottom of the display (the **DISP.** button can be used to hide the strip; see page 36). Press **MENU/OK** to exit.

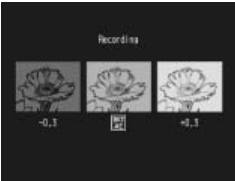

Auto Bracket

Vary exposure, white balance, or color to record two or three images “bracketing” current settings.

Option	Description
 ON ±0.3	<p>Each time the shutter-release button is pressed, the camera takes three photos: one underexposed by 0.3 EV, a second at current exposure settings, and a third overexposed by 0.3 EV. Choose when you find it difficult to judge the correct exposure.</p>  <p style="text-align: center;"><i>Display after shooting</i></p>
 ON ±0.5	<p>As above, except that the camera varies exposure by 0.5 EV with each shot instead of 0.3 EV.</p>
 WB-BKT	<p>The camera records three copies of each photo: one with a “warm,” reddish cast, a second at the white balance currently selected in the shooting menu (page 79), and a third with a “cool,” blueish cast. Choose when you find it difficult to select the correct white balance.</p>  <p style="text-align: center;"><i>Display after shooting</i></p>
 CL-BKT	<p>Record photos in both black-and-white and color or in black-and-white, color, and tinted monochrome (page 71).</p>

The current selection is shown by an icon in the picture display.



Notes

- Bracketing is not available when an option other than **Off** is selected for **Continuous**. White balance bracketing is not available when shooting monochrome photographs.
- White balance bracketing and color bracketing are not available when a RAW-quality option is selected for **Picture Quality/Size** (page 57).
- The flash turns off automatically when bracketing is in effect.
- **Auto** white balance is used in place of **Multi-P AUTO** when exposure bracketing is in effect.

CL-BKT: Color Bracketing

The number and type of photographs recorded when **CL-BKT** is selected for **Auto Bracket** depends on the option chosen for **CL-BKT Black & White (TE)** in the setup menu (page 131):

- **Off:** The camera records two copies of each photograph, one in black and white and a second in color.
- **On:** The camera records three copies of each photograph, one in black and white, a second in color, and a third using the tint selected for **B&W (TE)** in the **Image Settings** menu (pages 66–67).



B&W (TE) copy

Tip: Contrast, Sharpness, and Color Depth

The contrast, sharpness, and vividness of the images in the bracketing sequence are determined by the options selected in the **Image Settings** menu (pages 66–67). The black-and-white copy is recorded at the settings most recently selected for **Black & White**, the tinted monochrome copy at the settings most recently selected for **B&W (TE)**, and the color copy at the setting currently selected for **Image Settings** (if **Black & White** or **B&W (TE)** is selected, the color copy will be recorded at a setting of **Standard**).

Flash Exposure Compensation

Adjust flash level by -2.0 to $+2.0$ in steps of $\frac{1}{3}$ EV. Selecting **Flash Exposure Compensation** in the shooting menu displays the slider shown at right; press \blacktriangle or \blacktriangledown to choose a flash exposure compensation value and press **MENU/OK**.



Flash exposure compensation is displayed in the picture display except when the flash is off.



Note

See page 24 for information on using the flash.

Caution

Flash exposure compensation may have no effect outside the range of the flash (page 24).

Manual Flash Amount

Choose amount of light produced by the flash in manual flash mode (page 24). Flash output is expressed as a fraction of full power (all values are approximate):

FULL 1/1.4 1/2 1/2.8 1/4 1/5.6 1/8 1/11 1/16 1/22 1/32 1/64

Flash level is displayed in the picture display in manual flash mode.



Note

Flash exposure compensation is not available in manual flash mode.



Cautions

- In manual mode, flash level is not automatically adjusted according to lighting conditions.
- Do not direct the flash at a person operating a motor vehicle or use the flash close to the subject's eyes. Particular care should be observed when photographing infants.

Flash Synchro Settings

Choose how the flash synchronizes with the shutter.

- **1st Curtain:** The flash fires at the beginning of the exposure. Recommended in most situations.
- **2nd Curtain:** The flash fires at the end of the exposure. This option produces trails of light behind moving light sources.

Noise Reduction

Choose **Weak** or **Strong** to reduce “noise” (random variations in brightness and color) in photographs taken at high ISO sensitivities. The minimum ISO sensitivity at which noise reduction applies can be selected using **Noise Reduction ISO** (see below).

NR is displayed when noise reduction is on.



Notes

- When a RAW-quality option is selected for **Picture Quality/Size**, noise reduction applies only to the JPEG copy, not to the DNG file.
- The time needed to record photographs varies with the option selected for **Noise Reduction**.

Noise Reduction ISO

Select the minimum ISO sensitivity at which noise reduction applies when **Weak** or **Strong** is selected for **Noise Reduction**. Choose from **All** (noise reduction applies at all ISO sensitivities), **Over ISO 201**, **Over ISO 401**, **Over ISO 801**, and **ISO 1600**.

Interval Shooting

To take photos automatically at intervals of from five seconds to one hour, select **Interval Shooting** in the shooting menu and follow the steps below:

1 Choose an interval.

Press ◀ and ▶ to highlight hours, minutes, or seconds and press ▲ and ▼ to change. Press MENU/OK to return to shooting mode.

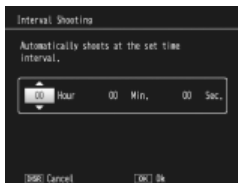

Interval will be displayed in the picture display.



2 Start shooting.

Press the shutter-release button. Photographs will be taken automatically at the selected interval.

3 End shooting.

Press MENU/OK to end shooting when all the desired photographs have been taken.



Cautions

- The interval timer is not available in **SCENE** mode.
- The interval resets to zero when the camera is turned off.
- If the time needed to record photographs is longer than the selected interval, the next photograph will not be taken until recording is complete.

**Notes**

- Use a fully-charged battery or optional AC adapter and be sure that sufficient space remains in internal memory or on the memory card. Interval timer photography ends automatically when the number of exposures remaining reaches zero.
- Photographs can be taken at any time by pressing the shutter-release button.
- If **Continuous** or **M-Cont** is selected for **Continuous Mode**, continuous shooting turns off automatically.

Date Imprint

Imprint the date (YY/MM/DD) or date and time (YY/MM/DD hh:mm) on photographs as they are taken.

An indicator is displayed in the bottom right corner of the picture display when date imprint is on.

**Notes**

- Date imprint is not available when the clock is not set. Set the clock (page 16) before using date imprint.
- The date can not be imprinted on movies.
- When a RAW-quality option is selected for **Picture Quality/Size**, the date is imprinted only on the JPEG copy, not the DNG file.
- The date is permanently imprinted on the image and can not be removed.

Exposure Compensation

The camera automatically adjusts exposure for the subject in the center of the frame, producing optimal exposure even when the subject is backlit. Exposure compensation may however be required in situations such as the following:

- **Very bright backlighting:** Subjects that are very strongly backlit may be underexposed. Try increasing exposure compensation.
- **The frame is dominated by very bright objects:** The subject may be underexposed. Try increasing exposure compensation.
- **The frame is mostly dark** (for example, a spotlight subject on a darkened stage): The subject may be overexposed. Try reducing exposure compensation.

Exposure compensation can be adjusted from the shooting menu or using the **ADJ.** lever.

The Shooting Menu

Selecting **Exposure Compensation** in the shooting menu displays the slider shown at right; press ▲ or ▼ to choose an exposure compensation value and press **MENU/OK**.

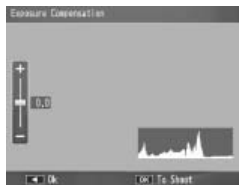

The ADJ. Lever

If exposure compensation is assigned to the **ADJ.** lever (page 119), exposure compensation can be adjusted as described below.

1 Display the exposure compensation slider.

With the camera in shooting mode, press the **ADJ.** lever in and press ◀ or ▶ or press the **ADJ.** lever left or right until the exposure compensation slider is displayed.

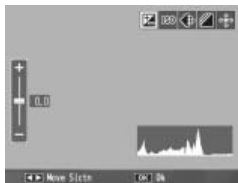

2 Adjust exposure compensation.

Press ▲ or ▼ to choose an exposure compensation value. Press the shutter-release button to take a picture or press the **ADJ.** lever or **MENU/OK** to return to shooting mode.

At settings other than **0.0**, exposure compensation is displayed in the picture display.









Caution

Exposure compensation is not available in mode **M**.

White Balance

At the default setting of **Multi-P AUTO**, the camera automatically adjusts white balance so that a white subject will appear white regardless of the color of the light source. It may however be necessary to match white balance to the light source under mixed lighting or when photographing a subject that is a solid color.

Option	Description
Auto	The camera adjusts white balance automatically.
 Multi-P AUTO	The camera adjusts white balance to account for differences in lighting in separate areas of the frame (in continuous mode, this option is equivalent to Auto).
 Outdoors	Use when shooting in daylight under clear skies.
 Cloudy	Use when shooting in daylight under cloudy skies.
 Incandescent Lamp	Use with incandescent lighting.
 Fluorescent Lamp	Use with fluorescent lighting.
 Manual Settings	Measure white balance manually (page 80).
 Detail	Make fine adjustments to white balance (page 81).

At settings other than **Auto**, the current selection is shown by an icon in the picture display.



Cautions

- Auto white balance may not produce the desired results with scenes lacking white objects. This can be corrected by adding a white object to the scene before shooting.
- Options other than **Auto** may not produce the desired results when the flash is used. Select **Auto** when using the flash.

White balance can be selected in the shooting menu (page 79) or assigned to the **ADJ.** lever (page 119) and adjusted as described below:

1 Display white balance options.

With the camera in shooting mode, press the **ADJ.** lever in and press ◀ or ▶ or press the **ADJ.** lever left or right until white balance options are displayed.

2 Select a white balance option.

Press ▲ or ▼ to select an option. Press the shutter-release button to take a picture or press the **ADJ.** lever or **MENU/OK** to return to shooting mode.

Manual: Measuring White Balance

To measure a value for white balance:

1 Select **Manual Settings**.

Highlight  **Manual Settings** in the white balance menu.



2 Measure white balance.

Frame a blank piece of paper or other white object so that it fills the frame and press the **DISP.** button. Repeat Steps 1–2 until the desired effect is achieved.

3 Press **MENU/OK**.

Press **MENU/OK** to return to shooting mode.



Note

Selecting an option other than **Manual Settings** resets manual white balance.

Detail: Making Fine Adjustments to White Balance

To make fine adjustments to white balance:

1 Select Detail.

Highlight  **Detail** in the white balance menu and press the **DISP.** button.



2 Choose a setting.

Press **▲** or **▼** to choose a white balance. Press **MENU/OK** when settings are complete.



3 Return to shooting mode.

Press **MENU/OK** to return to shooting mode.



Note
Selecting an option other than **Detail** resets detail white balance.

White Balance Compensation

Compensate for color casts by modifying white balance on the green-magenta or blue-amber axis. The modifications apply to the option currently selected for white balance and to all options selected while the modifications are in effect.

Selecting **White Balance Compensation** in the shooting menu (page 54) displays the controls shown at right. Choose white balance compensation using the ▲, ▼, ◀, or ▶ buttons, or press the **DISP.** button to reset white balance compensation to a neutral value. Press **MENU/OK** to save changes and exit, or press the **DISP.** button twice to cancel.

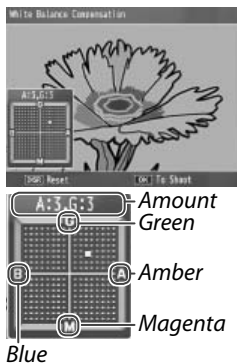

White balance compensation is shown in the picture display.





Notes

- White balance compensation can be assigned to the **ADJ.** lever (page 119). To reset, highlight **Reset** and press **MENU/OK**.
- White balance compensation can also be assigned to the **Fn** buttons (pages 121–122).
- When the mode dial is rotated to **SCENE**, white balance compensation is only available in movie and dynamic range double shot modes.
- The **White Balance Compensation** option in the playback menu (page 103) does not use the same values as the shooting menu option.



ISO Setting

Adjust the camera's sensitivity to light. Higher values can be used for faster shutter speeds when the subject is poorly lit, preventing blur.

- **Auto:** The camera automatically adjusts sensitivity according to brightness, the distance to the subject, and the options selected for macro mode and picture quality and size.
- **Auto-Hi** (high sensitivity auto): As above, except that the camera selects higher sensitivities when the subject is poorly lit. The maximum sensitivity can be selected in the setup menu (page 125).
- **ISO 64–ISO 1600:** Sensitivity is set to the selected value.

The current sensitivity is shown in the picture display (if **Auto** or **Auto-Hi** is selected, the sensitivity selected by the camera is shown when the shutter-release button is pressed halfway).



Sensitivity can be selected in the shooting menu (page 54) or assigned to the **ADJ.** lever (page 119) and adjusted as described below:

1 Display ISO sensitivity options.

With the camera in shooting mode, press the **ADJ.** lever in and press ◀ or ▶ or press the **ADJ.** lever left or right until ISO sensitivity options are displayed.

2 Select an ISO sensitivity option.

Press ▲ or ▼ to select an option. Press the shutter-release button to take a picture or press the **ADJ.** lever or **MENU/OK** to return to shooting mode.



Notes

- “Noise” (random variations in brightness and color) may appear in photographs taken at high sensitivities.
- The sensitivity displayed in the picture display in **Auto** and **Auto-Hi** modes may differ from the actual value. If the flash is used, a sensitivity of **Auto** is equivalent to ISO 125, regardless of the value displayed in the picture display. The range of sensitivities available in **Auto** mode when the flash is off is shown below:

Picture size	ISO sensitivity			Picture size	ISO sensitivity		
	Default	Min.	Max.		Default	Min.	Max.
640	100	64	283	2592	100	64	154
1280			238	3264			
2048			176	3648			

Restore Defaults

To restore default shooting menu settings (pages 55–56), rotate the mode dial to and select **Restore Defaults** in the shooting menu. A confirmation dialog will be displayed; highlight **Yes** and press **MENU/OK** to restore default values and exit to shooting mode.

Auto Aperture Shift

When **On** is selected, the camera will automatically adjust aperture to prevent overexposure in mode **A**.



Note

Auto aperture shift is available only in mode **A**.

Switch Shooting Mode

When the mode dial is rotated to a “MY” mode (page 53), you can use this option to switch between , P, A, S, and M modes without rotating the mode dial to a new setting. This option is only available in “MY” modes and is not displayed if the shooting mode currently selected for **Reg. My Settings** is a scene mode.

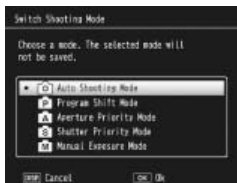

Movies

This section describes how to record and view movies.

Recording Movies

Shoot movies with sound. Movies are stored as AVI files.

1 Rotate the mode dial to **SCENE**.

The option currently selected for **SCENE** mode appears in the display.

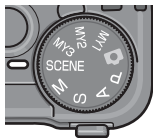

2 Press **MENU/OK**.

A menu of scene mode options will be displayed.



3 Select .

Press **▲** or **▼** to highlight  (movie) and press **MENU/OK** to exit to movie mode.



4 Shoot.

Press the shutter-release button to begin recording; press again to end. Recording ends automatically when memory is full.



Cautions

- Sounds made by the camera may be recorded with the movie.
- Movies may be up to 90 minutes in length or 4 GB in size. Depending on the type of memory card used, shooting may end before this length is reached. The maximum total length of all movie files that can be stored in internal memory or on a memory card varies with the options selected for **Movie Size** and **Frame Rate** (page 89).



Notes

- The flash can not be used.
- The camera focuses when the shutter-release button is pressed to begin recording.
- The amount of time remaining is calculated based on the amount of memory available and may not diminish at an even rate.
- Shooting menu options differ from those available in other modes (page 55).
- Charge the battery before shooting or use an optional AC adapter. For long recordings, choose memory cards with high write speeds and check the amount of memory available before shooting.

Choosing the Frame Size and Frame Rate

Movies consist of a series of images (frames) that are played at high speed to create the illusion of motion. To choose a frame size (the size of each frame in pixels) or frame rate (the rate at which the frames are recorded), select  mode and follow the steps below:

1 Display the shooting menu.

Press **MENU/OK** to display the scene menu. Press **◀** to highlight the mode tab, press **▼** to highlight the shooting menu tab, and press **▶** to place the cursor in the shooting menu.

2 Select **Movie Size** or **Frame Rate**.

Highlight **Movie Size** or **Frame Rate** and press **▶** to display options for the selected item.

3 Highlight an option.

- **Movie Size:** Choose **640** (640×480 pixels) or **320** (320×240 pixels).
- **Frame Rate:** Choose **30 Frames/Sec** (30fps) or **15 Frames/Sec** (15fps).

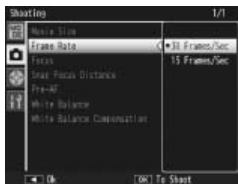

4 Exit to shooting mode.

Press **MENU/OK**. The selected option will be displayed in the picture display.





Viewing Movies

Follow the steps below to view movies.

1 Press .

Press the  button to display pictures in the picture display.







2 Display the movie.

Use the , , , and  buttons (page 29) to scroll through pictures until the first frame of the movie is displayed. Movies are indicated by a  icon.



3 Start playback.

Press the **ADJ.** lever in to start playback. Progress is shown in the playback display. The following operations can be performed:

To	Press	Description
Advance/ rewind	 / 	Hold Q to fast forward,  to rewind. If movie is paused, movie will advance or rewind one frame; keep button pressed for slow advance or rewind.
Pause/ resume	ADJ.	Press the ADJ. lever in to pause; press again to resume.
Adjust volume	 / 	Press  to increase volume,  to decrease.

More on Playback

This section details the options in the playback menu and describes how to view pictures on a TV.

The Playback Menu

To use the playback menu, press the  button to start playback and follow the steps below.

1 Display the playback menu.

Press the **MENU/OK** button to display the playback menu.

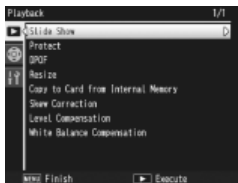

2 Select a menu item.

Press **▲** or **▼** to scroll through the menu and press **▶** to display options for the highlighted item.

The playback menu contains the following options:

Option	Page	Option	Page
Slide Show	92	Copy to Card from Internal Memory	97
Protect	92	Skew Correction	98
DPOF	95	Level Compensation	100
Resize	97	White Balance Compensation	103



Note

The setup menu can be accessed from the playback menu (page 112).

Slide Show

Selecting this option starts an automated slide show. Pictures are displayed at three second intervals in the order recorded. When a movie is displayed, movie playback begins automatically; the slide show resumes when playback is complete.

The slide show repeats until stopped; press any button to end the slide show.

Protect

Protect pictures from accidental deletion. Protected files are indicated by the icon shown at right.



Caution

Formatting erases all files, including protected files.

Protecting Individual Pictures

To protect or remove protection from individual files, play the picture back and select **Protect** in the playback menu to display the options shown at right (if the desired image is not displayed, press ◀ or ▶ to view other pictures). Highlight **1 File** and press MENU/OK.

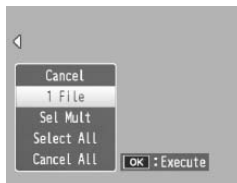

Changing the Protect Status of Multiple Files

Follow the steps below to change the protect status of multiple selected files.

1 Select **Protect** in the playback menu.

In multi-frame playback, proceed to Step 2. In single-frame playback, the options shown at right will be displayed. Highlight **Sel Mult** and press **MENU/OK**.

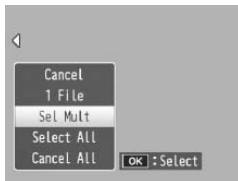

2 Select **Sel. Individ.** or **Sel. Range**.

Select **Protect** in the playback menu to display the options shown at right. To select images one at a time, highlight **Sel. Individ.**, press **MENU/OK**, and proceed to Step 3. To select one or more ranges consisting of two images and all photographs between them, highlight **Sel. Range**, press **MENU/OK**, and proceed to Step 3.1.

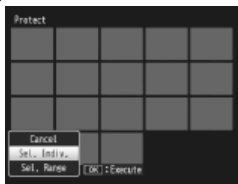

3 Select photographs.

Press **▲**, **▼**, **◀**, or **▶** to highlight photos and press **MENU/OK** to select. Protected pictures are marked with icons. To remove protection from a photo, highlight it and press **MENU/OK** again.



 **Tip: Selecting Ranges**

To select one or more ranges consisting of two images and all photographs between them, press the **ADJ.** lever in and follow the steps below:

3.1 Press ▲, ▼, ◀, or ▶ to highlight the first image and press **MENU/OK** to select. The selected image is marked with an icon. If you selected the wrong image, press **DISP.** and try again.



3.2 Press ▲, ▼, ◀, or ▶ to highlight the last image and press **MENU/OK** to select. The selected image and other images in the selected range will be marked with icons.



Repeat Steps 3.1–3.2 to select additional ranges, or press the **ADJ.** lever in to select or deselect individual photographs as described in Step 3.

4 Press the Fn2 button.

A message will be displayed while the camera protects the selected files. The camera will then return to normal playback.

Protecting or Removing Protection from All Files

To protect all files, select **Protect**, highlight **Select All** and press **MENU/OK**. To remove protection from all files, highlight **Cancel All** and press **MENU/OK**.

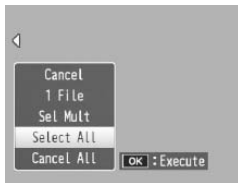

DPOF: Selecting Pictures for Printing

To request professional prints of the photographs on a memory card, first use this option to create a digital “print order” listing the photos you wish to print and the number of prints, and then take the memory card to a digital print service center that supports the DPOF standard.



Note

If a photograph created using a RAW picture-quality option is selected for printing, only the JPEG copy will be printed.



Tip: DPOF

DPOF (**D**igital **P**rint **O**rders **F**ormat) is a standard used to specify the photos to be printed and the number of prints. Photos selected for printing are marked with a DPOF print indicator (page 7).

Selecting Individual Photos for Printing

To add a photo to or remove it from the print order, play the picture back and select **DPOF** in the playback menu to display the options shown at right (if the desired image is not displayed, press ◀ or ▶ to view other pictures). Highlight **1 File** and press **MENU/OK**.

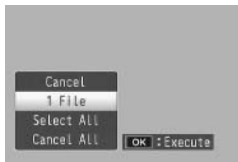

Selecting All Photos for Printing

To select all photos for printing, select **DPOF**, highlight **Select All** and press **MENU/OK**. To remove all photos from the print order, highlight **Cancel All** and press **MENU/OK**.

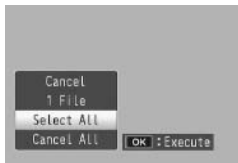

Multi-Frame Playback

To select multiple photographs for printing:

1 Select **DPOF**.

Press **MENU/OK** in multi-frame playback to display the playback menu. Highlight **DPOF** and press **▶**.

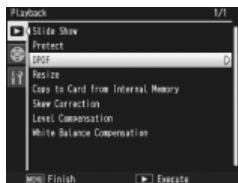

2 Select photos and choose the number of prints.

Press **◀** or **▶** to highlight additional photos and **▲** or **▼** to choose the number of prints. To remove a photograph from the print order, press **▼** until the number of prints is zero.

3 Press **MENU/OK**.

A message will be displayed while the camera creates the print order. The camera will then return to multi-frame playback.

Note

For information on removing all photos from the print order, see page 95.

Resize: Creating Small Copies of Photographs

To create a small copy of the current photograph, select **Resize** in the playback menu (page 91) and choose a size. Fine- and normal-quality photos larger than 1,280×960 pixels can be copied at sizes of **N1280** or **N640**, while **N1280** pictures can be copied at a size of **N640**. Movies and RAW-quality photos can not be resized.



Notes

- All copies have an aspect ratio of 4:3. Copies created from photos with an aspect ratio of 3:2 or 1:1 have a black border.
- See page 57 for information on choosing the size of photographs during shooting.

Copy to Card from Internal Memory

To copy all files from internal memory to a memory card, insert the memory card in the camera and select **Copy to Card from Internal Memory** in the playback menu (page 91). A message will be displayed while copying is in progress; the camera will return to playback when copying is complete.



Notes

- If the space available on the memory card is insufficient to hold all the files in internal memory, a message will be displayed. To copy only those files that will fit in the space available, highlight **Yes** and press **MENU/OK**; to exit without copying any files, select **No**.
- Files can not be copied to internal memory from a memory card.

Skew Correction

Create copies that have been processed to reduce the effects of perspective on rectangular objects, such as message boards or business cards.

1 Display the photo.

Display the photo to be copied in playback mode.

2 Select **Skew Correction**.

Press **MENU/OK** to display the playback menu, highlight **Skew Correction**, and press **▶**. If the camera is able to detect an object that can be used to correct perspective,

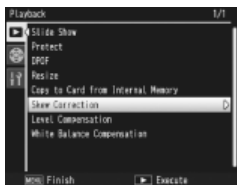

a message will be displayed with the object shown by an orange frame. The camera can detect up to five objects; to select a different object, press **▶**, or press **▲** to exit without correcting perspective. If the camera is unable to detect a suitable subject, an error message will be displayed.

3 Press **MENU/OK**.

A message will be displayed while the camera copies the photo. Copying takes from about 2 to 46 seconds, depending on image size (page 99).



Caution

Skew correction is available only with still images taken with this camera. It is not available with movies or with photos taken with **S-Cont** or **M-Cont** selected for **Continuous**. When used with photos taken with a RAW option selected for picture quality (page 57), skew correction applies only to the JPEG copy.



Notes

- The copy is the same size as the original. The time needed to create a copy increases with image size:

Size	Time (approx.)	Size	Time (approx.)
3,648 × 2,736	21 sec.	2,048 × 1,536	8 sec.
3,264 × 2,448	17 sec.	1,280 × 960	5 sec.
2,592 × 1,944	12 sec.	640 × 480	2 sec.

To reduce the time required, create a small copy of the original using **Resize** (page 97) and perform skew correction on the copy.

- Skew correction can also be performed during shooting (pages 46, 51).

Level Correction

Create copies that have been processed to adjust brightness and contrast. Correct brightness and contrast automatically (see below) or make manual adjustments using a histogram (pages 101–102).

Auto: Automatic Level Correction

1 Display the photo.

Display the photo to be copied in playback mode.

2 Select **Level Compensation**.

Press **MENU/OK** to display the playback menu, highlight **Level Compensation**, and press **▶**.

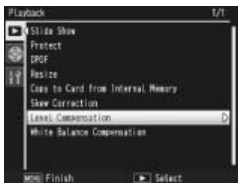

3 Select **Auto**.

Highlight **Auto** and press **▶**.

If the camera is able to create a copy, a preview will be displayed with the original image displayed at upper left, the corrected copy at right. If the camera can not create a copy, an error message will be displayed and the camera will exit to the playback menu.



4 Press **MENU/OK**.

Press **MENU/OK** to copy the image (to exit without creating a copy, press **DISP.**). A message will be displayed while the camera copies the photo.

Manual: Manual Level Correction

Display the photo to be copied and select **Level Compensation** > **Manual** in the playback menu to display a preview as described on the preceding page, then follow the steps below.

1 Select the black point, white point, or mid-point.

The manual preview contains a histogram showing how pixels of different brightnesses are distributed in the image, with dark pixels (shadows) on the left and bright pixels (highlights) on the right. Press the **ADJ.** lever in to cycle through the black point, mid-



*From left to right:
black point, mid-
point, white point*

point, and white point and press ◀ or ▶ to position the selected point for enhanced brightness and contrast as described on the following page. For help, press the **Fn2** button; press the button again to return to the preview display.

2 Press MENU/OK.

Press **MENU/OK** to copy the image (to exit without creating a copy, press **DISP.**). A message will be displayed while the camera copies the photo.

Tips: Choosing the Black Point, White Point, and Mid-Point

- **Adjusting brightness:** To make the image brighter, move the mid-point to the right. Moving the mid-point to the left makes the image darker.



- **Correcting exposure:** If the image is overexposed, move the black point to the right until it lines up with the darkest pixel in the histogram (see right). If the image is underexposed, move the white point to the left until it lines up with the brightest pixel. You can then move the mid-point left or right to adjust brightness.



Correcting overexposure

- **Increasing contrast:** To increase contrast, align the black point and white point with the darkest and brightest pixels as shown at right. You can then move the mid-point left or right to adjust brightness.

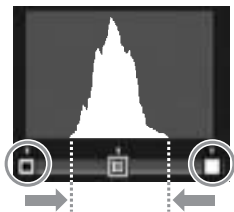

Cautions

- Level correction is available only with still images taken with this camera. It is not available with movies or pictures taken using **S-Cont** or **M-Cont**. The desired results may not be achieved with monochrome images or photographs taken in text mode.
- Although level correction can be applied multiple times, the compression applied every time a copy is saved will result in a drop in image quality.

White Balance Compensation

Create copies with modified white balance.

1 Display the photo.

Display the photo to be copied in playback mode.

2 Select **White Balance Compensation**.

Press **MENU/OK** to display the playback menu, highlight **White Balance Compensation**, and press **▶**.

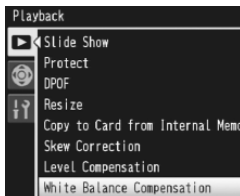

3 Adjust white balance.

Use the **▲**, **▼**, **◀**, or **▶** buttons to adjust white balance, or press **DISP.** to reset white balance compensation to a neutral value (to view or hide help, press the **Fn2** button).



4 Press **MENU/OK**.

Press **MENU/OK** to copy the image (to exit without creating a copy, press **DISP.** twice). A message will be displayed while the camera copies the photo.



Cautions

- White balance compensation is available only with still images taken with this camera. It is not available with movies or pictures taken using **S-Cont** or **M-Cont**. The desired results may not be achieved with monochrome images.
- Although white balance compensation can be applied multiple times, the compression applied every time a copy is saved will result in a drop in image quality.

Viewing Pictures on TV

To view pictures on a TV, connect the camera using the supplied A/V cable.

1 Turn the camera off.

Be sure the camera is off before connecting or disconnecting the A/V cable.

2 Connect the A/V cable to the TV.

Insert the white plug into the audio input connector, the yellow plug into the video input connector. Be sure the plugs are securely connected. *Do not use force.*

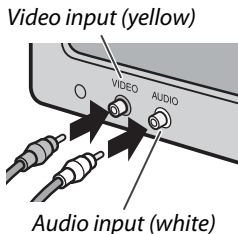

3 Connect the camera.

Open the terminal cover and plug the cable into the A/V cable connector. *Do not use force.*

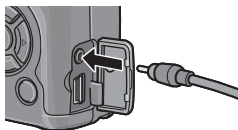

4 Tune the television to the video channel.

Select video input. See the television manual for details.

5 Turn the camera on.

Press the  button for about a second to turn the camera on in playback mode. The camera picture display and speaker will turn off and photos and movies will be played back on the TV.

**Caution**

Do not use force or tug the A/V cable when handling the camera with the A/V cable connected.

**Notes**

- The camera can be connected to the video input connector on a video recorder and pictures recorded to video or DVD.
- The camera supports the following video standards: NTSC (used in North America, the Caribbean, parts of Latin America, and some East Asian countries) and PAL (used in the United Kingdom and much of Europe, Australia, New Zealand, and parts of Asia and Africa). SECAM is not supported. Where possible, the camera is set to the standard used in your country or region before shipment; before connecting the camera to a device that uses a different video standard, choose the appropriate video mode (page 135).

Printing Photographs

The camera can be connected to a printer via the supplied USB cable and photographs printed directly from the camera without using a computer.



Caution

Movies can not be printed. If a photograph created using a RAW picture-quality option is selected for printing, only the JPEG copy will be printed.



Note

The camera conforms to PictBridge, a standard widely used for direct printing, and direct printing is consequently only available with PictBridge-compliant printers. See the documentation provided with your printer for information on whether it supports PictBridge.

Connecting the Camera

Connect the camera to the printer using the supplied USB cable.

1 Turn the camera off.

Be sure the camera is off before connecting or disconnecting the USB cable.

2 Connect the USB cable to the printer.

Connect the USB cable to the printer and turn the printer on.

3 Connect the camera.

Open the terminal cover and plug the cable into the USB cable connector.

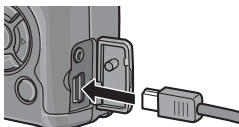

Press the **ADJ.** lever in. The camera will turn on and the message shown at right will be displayed; press the **ADJ.** lever in again immediately.



Note

If you do not press the **ADJ.** lever in while the above message is displayed, it may in some cases be replaced after two seconds by a message stating that the camera is connecting to a computer. Turn the camera off and press the **ADJ.** lever in again.

The message will be replaced by the PictBridge playback display shown at right (if the PictBridge playback display does not appear, the camera is still establishing a connection to the printer).

Caution

Do not use force when connecting the USB cable or when handling the camera with the cable connected.

Printing

Photographs can be printed one at a time or multiple photos can be selected for printing. If a memory card is inserted, the pictures will be printed from the memory card; otherwise pictures will be printed from internal memory.

Caution ~~~~~

Do not disconnect the USB cable while printing is in progress.

Note ~~~~~

If an error is displayed during printing, check the printer and take the appropriate action.

Printing Photos One at a Time

To print a selected photograph:

1 Select a photo.

Press ◀ or ▶ until the desired photo is shown in the Pict-Bridge playback display and press the **ADJ.** lever in. The menu shown at right will be displayed; highlight **1 File** and press **MENU/OK**.

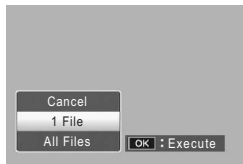

Tip: Printing One Copy of All Photos ~~~~~

To print one copy of all photos, press the **ADJ.** lever to display the options shown above and select **All Files**.

2 Adjust printer settings.

The menu shown at right will be displayed; highlight an item and press **▶** to view the options available, or choose **Printer Select** to use the default setting for the current printer (the options available vary with the type of printer; items not supported by the connected printer can not be selected). Press **▲** or **▼** to highlight an option and press **MENU/OK** to select and return to the direct print menu.

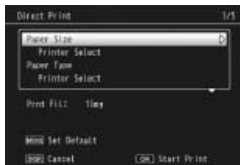

Item	Description
Paper Size	Choose the paper size.
Paper Type	Choose the paper type.
Layout	Choose the number of pictures per page.
Date Print	Include the time and date of recording. See page 16 for information on selecting the order in which the time and date are displayed. If the picture was taken using Date Imprint (page 76), only the imprinted date will be printed.
File Name Print	Include the file name.
Optimize Image	Choose whether the printer optimizes photo data.
Print Size	Choose the print size.
Print Quality	Choose the print quality.
Report Print*	Print a report.
Printing Quantity	Choose the number of copies.
Toner Saving*	Use less toner during printing.
1-Side/2-Sides*	Print on one or both sides of the paper.

* Ricoh printers only. Visit <http://www.ricoh.com/> for details.

**Note**

To select the highlighted option as the default for the current printer when the camera is connected, press the **ADJ.** lever in. The menu shown at right will be displayed; highlight **Set** and press **MENU/OK**. Select **Cancel** to exit without changing the default setting.



3 Start printing.

To start printing, press **MENU/OK** when the direct print menu shown in Step 2 is displayed. A message is displayed during printing; to exit before printing is complete, press the **DISP.** button. The PictBridge playback display will appear when printing is complete.

To print multiple photographs:

1 Press the  button.

Photographs will be displayed in multi-frame playback.

2 Select a picture.

Highlight a picture and press MENU/OK.

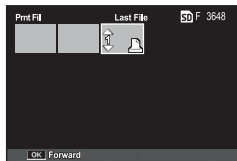

3 Choose the number of prints.

Press ▲ or ▼ to choose the number of prints. Selected pictures are marked with a  icon; to deselect a photograph, press ▼ until the number of prints is zero.

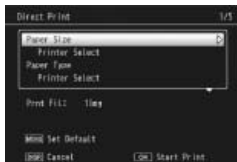

4 Select additional photos.

Press ◀ or ▶ to highlight additional photographs and press ▲ or ▼ to choose the number of prints.

5 Adjust printer settings.

Press MENU/OK to display the direct print menu. Adjust settings as described on pages 109–110.

6 Start printing.

To start printing, press MENU/OK when the direct print menu is displayed. A message is displayed during printing; to exit before printing is complete, press the DISP. button. The PictBridge playback display will appear when printing is complete.

The Setup Menu

The setup menu can be accessed from the shooting and playback menus (pages 54 and 91).

1 Display the menus.

Press **MENU/OK** to display the menu for the current mode (page 133; in scene mode, a **MODE** tab will be displayed).

2 Select a setup menu tab.

Press **◀** to highlight the tab for the current menu and press **▲** or **▼** to highlight the key custom settings tab (page 113) or the setup menu tab (page 113). Press **▶** to place the cursor in the selected tab.

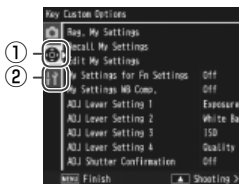

① *Key custom settings tab*

② *Setup menu tab*

3 Select a menu item.

Press **▲** or **▼** to highlight a menu item and press **▶** to display options for the highlighted item.

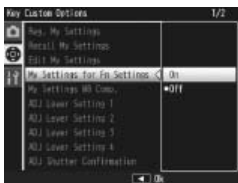



4 Select an option.

Press **▲** or **▼** to highlight an option and press **MENU/OK** to select and exit (the procedure may differ for some items; see the page for the item in question).

The key custom settings tab contains the following options:

Option	Default	Page	Option	Default	Page
Reg. My Settings	—	114	ADJ Shutter Confirmation	Off	121
Recall My Settings	—	116	Set Fn1 Button	AF/MF	121
Edit My Settings	—	117	Set Fn2 Button	Self-timer	121
My Settings for Fn Settings	Off	118	Zoom Button	Exposure Comp.	122
My Settings WB Comp.	Off	118	Power Button Lamp	On	122
ADJ Lever Setting 1	White Balance	119	Playback Mode Dial Options	Setting1	123
ADJ Lever Setting 2	ISO	119	M Mode Dial Options	Setting1	123
ADJ Lever Setting 3	Quality	119	One Press M Mode	Aprtr Priority	123
ADJ Lever Setting 4	Image Settings	119			

The setup menu tab contains the following options:

Option	Default	Page	Option	Default	Page
Format [Card]	—	124	Fn Button Display	On	129
Format [Internal Memory]	—	124	Show My Setting Name	Off	129
LCD Brightness	—	124	Shooting Info. Display Frame	Off	129
ISO Auto-High Settings	AUTO 400	125	Information Display Mode	Off	130
AF Auxiliary Light	On	125	CL-BKT Black & White (TE)	On	131
Auto Power Off	5 Min.	125	RAW/JPEG Setting	Fine	131
Operation Sounds	All	125	Color Space Set	sRGB	132
Volume Settings	 (medium)	126	Digital Zoom Image	Normal	133
LCD Confirmation Time	0.5 seconds	126	Store Menu Cursor Position	Off	133
One Press Zoom Ratio	9.8×	126	Card Sequence No.	On	134
Auto Rotate	On	127	Date Settings	—	135
Level Setting	Display	27, 127	Language/言語	(Varies*)	135
Grid Guide Display Options		128	Video Out Mode	(Varies*)	135

* Varies with country or region of purchase.

Key Custom Settings/Setup Menu Options

The options available in the key custom settings and setup menu tabs are described on the pages that follow.

Reg. My Settings

Settings saved using **Reg. My Settings** can be recalled by rotating the mode dial to **MY1**, **MY2**, or **MY3**, allowing you to easily create and recall up to six sets of settings for frequently-encountered shooting conditions.

1 Adjust settings.

Set the camera to the desired settings. The following settings can be stored:

- **Camera settings:** Shooting mode (📷, P, A, S, M, or **SCENE**), aperture (modes A and M), shutter speed (modes S and M), focus position for manual focus, and scene, macro, flash, self-timer and display modes.
- **Shooting menu options:** All options except **Interval Shooting**, **Auto Aperture Shift**, and **Switch Shooting Mode**. White balance compensation will be stored if **My Settings WB Comp.** is on (page 118).
- **Setup menu options:** **ISO Auto-High Settings**, function button settings (if **My Settings for Fn Settings** is on; see page 118), **Level Setting**, **Grid Guide Display Options**, **Shooting Info. Display Frame**, **CL-BKT Black & White (TE)**, and **Digital Zoom Image**.

2 Select **Reg My Settings**.

Highlight **Reg. My Settings** in the setup menu key custom settings tab and press ►.

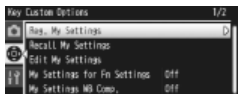

3 Save settings.

To assign the settings to **MY1**, **MY2**, or **MY3** on the mode dial, highlight **MY1**, **MY2**, or **MY3** and press **MENU/OK** (to exit without saving settings, press the **DISP.** button).

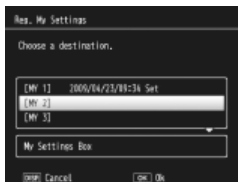

To save the settings to a “box” to be recalled and assigned to the mode dial at a later date (page 116), select **My Settings Box** and press ►. Highlight the desired box and press **MENU/OK**.

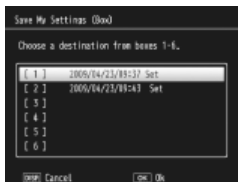

Unnamed boxes will be named using the current date. If the box has already been assigned a name, the dialog shown at right will be displayed. Select **Yes** to use the current name, **No** to use a name based on the current date.



Recall My Settings

Copy settings from a “box” to MY1, MY2, or MY3.

1 Select a destination.

Highlight the destination for the stored settings (**MY1**, **MY2**, or **MY3**) and press **▶**.

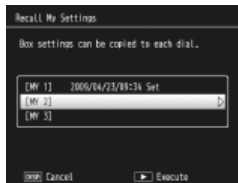

2 Select the source.

Highlight the settings “box” that will be assigned to the selected position on the mode dial and press **MENU/OK**.

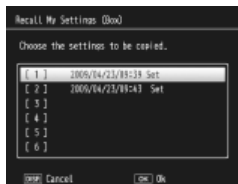

To exit without assigning settings to the mode dial, press the **DISP.** button.



Caution

If **Edit My Settings** is used to edit boxes that are currently assigned to the mode dial, the changes will be reflected when the mode dial is rotated to the position assigned to the box. Changes to settings assigned directly to **MY1**, **MY2**, or **MY3** are not however reflected in the boxes currently assigned to the mode dial, and if the boxes are subsequently changed, these changes will not be reflected in the settings assigned to **MY1**, **MY2**, or **MY3**.

Edit and rename settings saved with **Reg. My Settings**.

1 Select settings.

To edit the settings assigned to MY1, MY2, or MY3 on the mode dial, highlight **MY1**, **MY2**, or **MY3** and press **▶**.

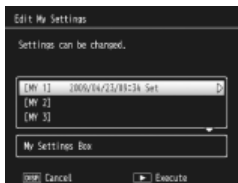

To edit "box" settings, select **My Settings Box** and press **▶**. Highlight the desired box and press **▶**.

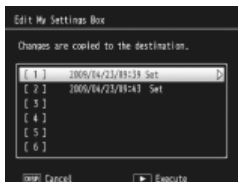

2 Edit settings.

Press **▲** or **▼** to highlight items and press **▶** to edit (see the section for each item in this manual for more information). After editing each item, press **◀** to return to the settings list, where you can edit additional settings.



3 Save changes and exit.

Press **MENU/OK** to save changes and exit (to exit without saving changes, press **DISP.**).



Tip: Naming My Settings

Select **Name** in Step 2 to rename the current combination of settings. The current name is highlighted in the name area; to edit the current name, press ◀ or ▶ to position the cursor in the name area and press ▼ to place the cursor in the keyboard area (to delete the current name, press ▼ while the name is highlighted). Highlight characters using ▲, ▼, ◀, or ▶ and press **MENU/OK** to enter the highlighted character at the current cursor position (to delete the character at the current cursor position, select **[Delete]**). Press **Fn2** to switch between upper and lower case. Names can be up to 32 characters long. Press the **ADJ.** lever in to use the new name, or press **DISP.** to exit without renaming the settings.



My Settings for Fn Settings

Select **On** to include the options assigned to the Fn buttons (page 121) in the settings saved with **Reg. My Settings**.

My Settings WB Comp.

Select **On** to include white balance compensation (page 82) in the settings saved with **Reg. My Settings**.

ADJ Lever Setting

Assign up to four frequently-used options to the **ADJ.** lever for quick access in **C**, **P**, **A**, **S**, and **M** modes. At shipment, the **ADJ.** lever can be used for white balance (page 79), sensitivity (page 84), picture quality (page 57), and image setting (page 66), but it can also be used for white balance compensation (page 82), focus (page 59), metering (page 65), continuous (page 68), bracketing (page 70), flash compensation (page 72), manual flash amount (page 73), and exposure compensation (page 77). The **ADJ.** lever can also be used to select white balance in **WB**, **WB** and **DR** modes, contrast in **CON** mode, and exposure compensation in **EXP** and **DR** modes.

Using the ADJ. Lever

To select an option currently assigned to the **ADJ.** lever:

1 Display options.

With the camera in shooting mode, press the **ADJ.** lever in and press the lever left or right or press **◀** or **▶** to view the options assigned to the lever.



2 Select an option.

Press ▲ or ▼ to highlight an option and press the **ADJ.** lever in or press **MENU/OK** to select.



Tip

Keep the **ADJ.** lever pressed to page rapidly through the available options.

ADJ Shutter Confirmation

Select **On** to use the shutter-release button to select the highlighted option when using the **ADJ.** lever.

Set Fn Button

Choose the functions assigned to the Fn (function) buttons: ◀ (Set Fn1 Button) and ☺ (Set Fn2 Button).

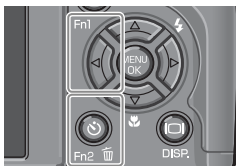



Option	Description
AF/MF	Switch between multi or spot AF and manual focus (page 59). ^{1,2}
AF/Snap	Switch between multi or spot AF and snap focus (page 59). ²
AE Lock	Lock exposure. ^{3,4}
JPEG>RAW	If a fine- or normal-quality option is selected for Picture Quality/Size , pressing the Fn button selects a RAW option with the same aspect ratio (page 57). ^{2,4,5,6}
Color>B&W	Select Black & White for Image Settings (page 66). ^{2,4}
Color>TE	Select B&W (TE) for Image Settings (page 66). ^{2,4}
Exposure Comp.	Display the exposure compensation slider (page 77). ^{2,4}
White Balance	Display white balance options (page 79). ²
WB Correction	Display white balance compensation controls (page 82). ^{2,5}
ISO	Display ISO sensitivity options (page 84). ^{2,4}
Quality	Display options for picture quality and/or size (page 57) or movie size (page 89).

1 If focus is locked in autofocus mode (page 59), selecting manual focus sets the focus distance to the distance at which focus is locked.

2 Not available when  is selected in **SCENE** mode.

3 Exposure can not be locked in mode **M**. Pressing the **Fn** button in mode **M** sets shutter speed and aperture to values close to those needed for optimal exposure.

4 Not available when  is selected in **SCENE** mode.



5 Not available when  is selected in **SCENE** mode.

6 Not available when **DR** is selected in **SCENE** mode.

Option	Description
Focus	Display focus options (page 59). ²
Image Settings	Display image setting options (page 66). ^{2,4}
Expo. Metering	Display exposure metering options (page 65). ^{2,4}
Cont. Mode	Display continuous shooting options (page 68). ^{2,4,5,6}
Auto Bracket	Display bracketing options (page 70). ^{2,4,5,6}
Macro Target	Position the focus target in macro mode (page 63).
Flash Comp.	Display the flash compensation slider (page 72). ^{2,4,6}
Flash Amount	Adjust manual flash output (page 73). ^{2,4,5,6}
Self-timer	Set the self-timer (page 26). ⁴

By default, **AF/MF** is assigned to the ◀ button and **Self-timer** to the ⌚ button.

Zoom Button

Choose the role played by the  and  buttons. Choose from none (off), digital zoom (page 22), exposure compensation (page 77), and white balance (page 79).

Caution

Digital zoom is not available when a RAW-quality option is selected for **Picture Quality/Size** (page 57).

Power Button Lamp

If **On** is selected, the power button LED will light when the camera is turned on.

Playback Mode Dial Options/M Mode Dial Options

Choose the roles played by the ADJ. lever and up-down dial during playback zoom and in mode M.

	Playback Mode Dial Options		M Mode Dial Options	
	Setting1	Setting2	Setting1	Setting2
ADJ. lever	Next/previous frame	Scroll left/right	Shutter speed	Aperture
Up-down dial	Zoom in/out	Scroll up/down	Aperture	Shutter speed

One Press M Mode

When exposure compensation is assigned to the **Q** and **☒** buttons (page 122) or AE lock is assigned to an **Fn** button (page 121), pressing the affected button in manual exposure mode sets shutter speed and/or aperture to values close to those needed for optimal exposure. This option determines whether shutter speed or aperture is adjusted to achieve optimal exposure.

- **Aprtr Priority:** Aperture remains at the selected value; shutter speed is adjusted for optimal exposure.
- **Shtrr Priority:** Shutter speed remains at the selected value; aperture is adjusted for optimal exposure.
- **Program:** Both aperture and shutter speed are adjusted for optimal exposure.



Note

In manual exposure mode, exposure compensation can not be performed with the zoom buttons, nor can AE lock be performed with the **Fn** buttons.

Format [Card]/Format [Internal Memory]

Select **Format [Card]** to format the memory card before first use, after using it in another device, or if a card error is displayed when the card is inserted in the camera. Select **Format [Internal Memory]** if a message is displayed prompting you to format internal memory.

Cautions

- *Formatting permanently deletes all data on the card or in internal memory.* Before formatting, copy any data you wish to keep to a computer (page 136).
- Selecting **Format [Card]** when no memory card is inserted displays an error message. Turn the camera off and insert a memory card.

Tip: Write Protection

To prevent memory cards from being formatted, slide the write-protect switch to the “LOCK” position (page 14). Restore the switch to its original position to resume normal operation.

LCD Brightness

Selecting this option displays the control shown at right. Press **▲** or **▼** to adjust picture display brightness and press **MENU/OK** to return to the setup menu. Press **MENU/OK** again to exit to shooting or playback mode.



Note

The brightness display shows the view through the lens (shooting mode) or the most recently viewed picture (playback mode; if no picture is available for playback, no image will be shown in the brightness display).

ISO Auto-High Settings

Choose the maximum sensitivity selected by the camera when **Auto-Hi** is selected for **ISO Setting** in the shooting menu (page 84). Choose from settings of ISO 200 (**AUTO 200**), 400 (**AUTO 400**), 800 (**AUTO 800**) or 1600 (**AUTO 1600**).



Note

“Noise” (random variations in brightness and color) may appear in photographs taken at high sensitivities.

AF Auxiliary Light

If **On** is selected, the AF auxiliary light will light to assist the focus operation when the subject is poorly lit.

Auto Power Off

Choose the delay before the camera turns off automatically to save power when no operations are performed. Select from **Off** (the camera does not turn off automatically), 1 minute, 5 minutes, and 30 minutes.

Operation Sounds

Choose when the camera plays a sound.

Option	Description
All	Sounds are played at startup, when the shutter is released, when the camera focuses, and when an error occurs. If Sound or Disp + Snd is selected for Level Setting (page 27), the camera will also beep at regular intervals when the camera is level.
Level Sound	If Sound or Disp + Snd is selected for Level Setting , the camera will beep at regular intervals when the camera is level.
Shutter Sounds	Sounds are played when the shutter is released or an error occurs. If Sound or Disp + Snd is selected for Level Setting , the camera will beep at regular intervals when the camera is level.

Volume Settings

Select the volume for the sounds described above under “Operation Sounds.” Choose from (off), (low), (medium), and (high).

LCD Confirmation Time

Choose how long photographs are displayed in the picture display after shooting. Select from 0.5, 1, 2, and 3 seconds, **Hold** (photograph is displayed until shutter-release button is pressed halfway and can be viewed with playback zoom or deleted; see pages 32 and 33), and **Off** (photographs are not displayed in the picture display after shooting).

One Press Zoom Ratio

Select the magnification at which pictures are displayed when zoomed in using the **MENU/OK** button or **ADJ.** lever (page 32). Choose from 5.7×, 9.8×, and 16×.

Note

Maximum magnification varies with image size:

Image size (pixels)	Maximum magnification
2,048 × 1,536 or larger	16×
1,280 × 960	6.7×
640 × 480	3.4×

If the magnification would be greater than the maximum magnification, pictures will be displayed at the maximum magnification.

Auto Rotate

Select **On** to automatically display pictures in the correct orientation during playback.



Caution

Movies, pictures shot with **Continuous Mode** set to **S-Cont** or **M-Cont**, and pictures taken with the camera upside down or tilted sharply forward or back are not rotated for display in the picture display. Pictures are not rotated during slide shows, in multi-frame playback, or when displayed on a TV, nor are they rotated when the camera is upside down or if the camera is rotated during playback zoom or while skew correction is in progress.



Note

During bracketing or when recording pictures with **Continuous** selected for **Continuous Mode**, the camera only records the orientation for the first photograph in each series. The remaining photographs will not be displayed in the correct orientation if the camera was rotated during shooting.

Level Setting

Choose tilt indicator settings (page 27).

Grid Guide Display Options

Choose the type of framing grid available in shooting mode (page 36).

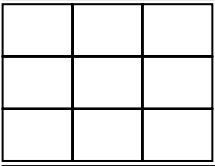
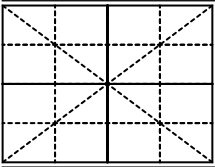
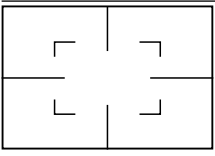
Item	Description
	A three-by-three grid for “rule of thirds” composition.
	A four-by-four grid with diagonal lines running from corner to corner makes it easy to find the center of the subject. Use for architectural photography or photographing products for display.
	A two-by-two grid with the center of the frame left clear to make it easier to view the subject. Use if your subject is in motion.

Fn Button Display

Select **On** to display the options currently assigned to the Fn buttons when the camera is turned on, when shooting mode is selected, or when a new mode is selected with the mode dial.

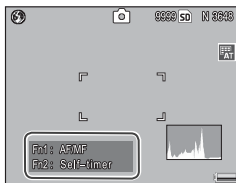

Show My Setting Name

Select **On** to display the name of the settings assigned to the current position on the mode dial when the dial is rotated to MY1, MY2, or MY3.



Shooting Info. Display Frame

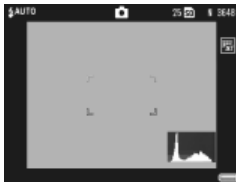

Select **On** to display shooting icons in a frame surrounding the view through the lens (page 6), making it easier to frame photographs in the picture display. The frame is not displayed in movie mode.



Information Display Mode

Select **On** to display shooting information in the picture display when the picture display is off (page 36), allowing you to adjust camera settings while using an optional external viewfinder (page 162) to frame photographs. The view through the lens is not displayed.







Shooting information can be displayed by:

- pressing the  or  button,
- rotating the mode dial to a new position,
- using the up-down dial,
- pressing the **ADJ.** lever left or right,
- pressing the **Fn1** or **Fn2** button, or
- pressing the flash **OPEN** switch ( **OPEN**) to raise the flash.

The display turns off if the shutter-release button is pressed halfway or no operations are performed for a few seconds.



Notes

- Regardless of the setting chosen, the picture display turns on when any of the following buttons are pressed: the **ADJ.** lever, the **MENU/OK**,  (**DISP.**), and  buttons, the  and  buttons (except when **Off** is selected for **Zoom Button**; page 122), and the  and  buttons (manual focus mode only).
- The tilt indicator is not displayed when the picture display is off.

CL-BKT Black & White (TE)

Choose the number and type of copies created with color bracketing (page 71). Select **On** to record three copies of each shot (one in black and white, a second in color, and a third using a monochrome tint), **Off** to record two copies (one in black and white and the second in color).



Note

Regardless of the setting chosen, three copies of each photograph will be recorded if **B&W (TE)** is selected for **Image Settings**.

RAW/JPEG Setting

Choose the quality and size of JPEG copies recorded when a RAW-quality option is selected for **Picture Quality/Size** (page 57). Select **Fine** or **Normal** to record a fine- or normal-quality copy of the same dimensions as the RAW image, **N640 (VGA)** to record a normal-quality copy 640 × 480 pixels in size.



Note

If a RAW-quality option with an aspect ratio of 3:2 or 1:1 is selected for **Picture Quality/Size** when **N640** is selected, black bands will be added above and below or to either side of the JPEG copies to give them an aspect ratio of 4:3.

Color Space Setting

Choose the color space used to record photographs. **sRGB** is widely used to reproduce digital images but offers a smaller gamut of colors than **AdobeRGB**.

Caution

The Adobe RGB color space was developed by Adobe Systems, Inc., and is compatible with the default color space used in Adobe Photoshop and other image editing software. Note, however, that colors will only be reproduced correctly in software that supports the Adobe RGB color space. Note too that specialized equipment is required to print the full range of colors in the Adobe RGB gamut; when printed using consumer household printers or digital photo print services, colors will generally be less vivid than in photographs that use the sRGB color space.

Digital Zoom Image

If **Normal** (the default option) is selected for **Digital Zoom Image** and an option with a size of 3,648×2,736 is selected for **Picture Quality/Size**, digital zoom will enlarge image data from the center of the frame to create a picture 3,648×2,736 pixels in size, creating a slightly grainy image. To record pictures taken with digital zoom at actual size, select **Auto Resize**. The size at which the image will be recorded varies with the zoom ratio:

Zoom ratio	Size (pixels)	Zoom ratio	Size (pixels)
1.0×	3,648×2,736 (10M)	1.8×	2,048×1,536 (3M)
1.1×	3,264×2,448 (8M)	2.9×	1,280×960 (1M)
1.4×	2,592×1,944 (5M)	5.7×	640×480 (VGA)

The current picture size is displayed in the picture display when the camera is zoomed in.

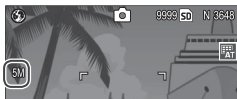

Caution

The option selected for **Digital Zoom** image only takes effect when **Digital Zoom** is selected for **Zoom Button** (page 122). **Auto Resize** has no effect when **S-Cont** or **M-Cont** is selected for **Continuous**, when a RAW-quality option is selected for **Picture Quality/Size**, or when  is selected in **SCENE** mode.

Store Menu Cursor Position

If **On** is selected, the most-recently accessed item will be highlighted when menus are displayed.

Card Sequence No.

Choose how the camera names image files when saving photographs to a memory card.

- **On:** Files names consist of "R" followed by a seven-digit number (e.g., "R0010001.jpg"), assigned in ascending order from 0010001 to 9999999. When a new memory card is inserted, file numbering continues from the last number used.
- **Off:** Files names consist of "RIMG" followed by a four-digit number (e.g., "RIMG0001.jpg"), assigned in ascending order from 0001 to 9999. When a new memory card is inserted, file numbering is reset to 0001.



Notes

- This option applies only to memory cards. The names of photos in internal memory consist of "RIMG" and a four-digit number.
- Photos copied to a computer using DL-10 (page 136) are given new names consisting of "RIMG" and a four-digit number.
- Photos taken with **AdobeRGB** selected for **Color Space Setting** (page 132) are indicated by file names beginning with an underscore (e.g., "_R010001.jpg" or "_RIMG001.jpg").



Caution

When **On** is selected, no further photographs can be stored if the memory card contains a folder numbered 999 and a file name ending in 9999; when **Off** is selected, no further photographs can be stored if the memory card contains a file numbered 9999. To take additional photos, format the card after copying its contents to a computer.

Date Settings

Set the camera clock (page 16).



Note

If you leave the battery in the camera for at least two hours, the battery can be removed for about a week without resetting the clock.

Language/言語

Choose the language in which camera messages and menus are displayed.

Option	Description	Option	Description
日本語	Japanese	Русский	Russian
English	English	简体中文	Simplified Chinese
Deutsch	German	繁體中文	Traditional Chinese
Français	French	한국어	Korean
Italiano	Italian	ไทย	Thai
Español	Spanish		

Video Out Mode

When connecting the camera to a TV or VCR (page 104), choose a video out mode that matches the standard used in the device. The camera supports NTSC and PAL; SECAM is not supported.

Copying Pictures to a Computer

This section describes how to copy pictures from the camera to your computer. Instructions for Windows may be found below; those for the Macintosh begin on page 148.



Note

The dialogs shown in this section may differ slightly from those displayed by your computer.

Windows

You can copy pictures to your computer by either of the following methods:

- Install the supplied DL-10 software (page 138) and use it to copy pictures as described on page 144.
- Copy pictures in Windows Explorer (page 145).



Caution

Pictures can not be copied from the camera to computers running Windows 98 or Windows 98SE. Use a card reader to copy pictures from a memory card (page 146).



Note

Detailed instructions may be found in the *Software User Guide* on the supplied CD (page ii).

System Requirements

Before using the supplied CD, check that your computer meets the following requirements. See the documentation provided with your computer for details.

OS	Windows 2000 Professional SP 4, Windows XP Home Edition/Professional SP 3, Windows Vista SP 1
CPU	Windows 2000/Windows XP: Pentium III 500 MHz or faster Windows Vista: Pentium III 1 GHz or faster
RAM	Windows 2000/Windows XP: 256 MB or more Windows Vista: 512 MB or more
Free disk space	A minimum of 160 MB required for installation
Video	1024 × 768 pixels or more with 16-bit color or better
Miscellaneous	<ul style="list-style-type: none">• Compatible CD-ROM drive• Compatible USB port



Cautions

- 64-bit operating systems, Windows 98, Windows 98SE, and Windows Me are not supported. Operating systems that have been upgraded from an earlier version are not supported, as USB may fail to function as expected. The supplied software may not function as expected with systems that have been patched or updated with Service Pack releases.
- Connect the camera directly to a built-in USB port. USB ports added via PCI-bus or other extension boards or cards are not supported. The camera may not function as expected when connected via a USB hub or keyboard.
- More RAM may be required when handling movies and other large files.

The Supplied CD

Inserting the supplied CD in a CD-ROM drive displays the dialog shown at right.

- **Installing the software:** Install the following software.



DL-10: Copy pictures to the computer in a single operation.

Irodio Photo & Video Studio: View, manage, edit pictures on the computer. For more information, see the **Help** menu in Irodio Photo & Video Studio or visit the following website: http://www.pixela.co.jp/oem/irodio/e/irodio_digitalphoto_videostudio/

USB driver: Connect earlier Ricoh cameras to computers running Windows 98, Windows 98 SE, Windows Me, or Windows 2000. Not required for this camera.

WIA driver: Connect earlier Ricoh cameras to computers running Windows XP or Windows Vista. Not required for this camera.

- **Browse User's Manual (Software Version):** View the *Software User Guide* in pdf format (page iv). Acrobat Reader or Adobe Reader is required; if necessary, install Adobe Reader as described on pages 141–142.
- **Browse CD-ROM Content:** View the contents of the CD, which include Adobe Reader (page 141). To install Irodio Photo & Video Studio without installing other software, open the "Irodio Photo & Video Studio" folder and double-click **Irodio Photo & Video Studio.exe**.

Installing the Software

Follow the steps on the next page to install the supplied software. Illustrations are from Windows XP.



Cautions

- If the camera is connected to the computer, disconnect the camera before beginning installation.
- Users of existing “Caplio” software should note that the “DC” software supplied with the camera replaces the following items in the Caplio software package:

Caplio software	DC software
RICOH Gate La	DL-10
Caplio Viewer	DU-10*
Caplio Server	SR-10*
Caplio Setting	ST-10*

* Not used by this camera.

If the above Caplio software is currently installed, you will be prompted to uninstall it before installing the supplied DC software. Follow the on-screen instructions. Installing the DC software replaces Caplio Viewer, Caplio Server, and Caplio Setting with the software listed above, which can be used in the same way as the Caplio versions (note that this software will not be installed if you uninstalled the Caplio software as described on page 143 before installing the DC software). Note that uninstalling the software for earlier Ricoh cameras may reset user preferences for DL-10 or RICOH Gate La.

- Administrator privileges are required for installation.
- DL-10 is for use in a stand-alone environment alone and can not be run over a network.

1 Insert the supplied CD.

Turn the computer on and insert the supplied CD in a CD-ROM drive.

- **Windows Vista:** An Autorun dialog will be displayed. Click **Run Autorun.exe** to display the installer dialog.
- **Other versions of Windows:** The installer dialog will be displayed automatically.



2 Click **Installing the software**.

- **Windows Vista:** A "User Account Control" dialog will be displayed. Click **Allow** to display a language-selection dialog.
- **Other versions of Windows:** A language-selection dialog will be displayed.

3 Select a language and click **OK**.

The dialog shown at right will be displayed. Click **Next**.

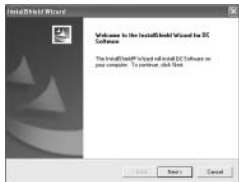

4 Select a destination.

The supplied software will be installed to the folder shown under **Destination Folder**. Click **Next**.



5 Install the software.

The Irodio Photo & Video Studio installer will start (depending on your computer, the splash screen at right may be displayed for some time before installation begins). Follow the on-screen instructions to install the supplied software.



6 Click Finish.

The dialog shown at right will be displayed when installation is complete. Click **Finish**.



7 Restart the computer.

A message will be displayed prompting you to restart your computer. Select **Yes, I want to restart my computer now** and click **Finish** to restart the computer.

8 Unblock DL-10.

A Windows security dialog will be displayed when the computer restarts. Click **Unblock** for DL-10.



Note

See page 143 for information on uninstalling the software.

Adobe Reader

Adobe Reader is required to view the *Software User Guide*. If Adobe Reader is not already installed, it can be installed from the supplied CD as described below.



Cautions

- Disconnect the camera before beginning installation.
- Administrator privileges are required.

1 Insert the supplied CD.

Turn the computer on and insert the supplied CD in a CD-ROM drive.

- **Windows Vista:** An Autorun dialog will be displayed. Click **Run Autorun.exe** to display the installer dialog.
- **Other versions of Windows:** The installer dialog will be displayed automatically.



2 Click **Browse CD-ROM Content**.

The contents of the CD will be displayed.

3 Install Adobe Reader.

Double-click the "Acrobat" folder and then double-click the folder for the language of your choice. Double-click the file beginning with "AdbbeRdr910" and follow the on-screen instructions. If a "User Account Control" dialog is displayed, click **Continue**.



Notes

- See the Adobe Reader **Help** menu for information on Adobe Reader.
- Installation of Adobe Reader 9.1 requires MSI (Microsoft Windows Installer) version 3.1 or later and either Microsoft Internet Explorer 6.0 or later or Firefox 2.0 or later. Microsoft Internet Explorer and Microsoft Windows Installer are available via Microsoft Update.

Uninstalling the Software

Follow the steps below to uninstall DC software or Irodio Photo & Video Studio.



Cautions

- Administrator privileges are required.
- Exit any applications that may be running before proceeding.

1 Open the “Add/Remove Programs” Control Panel.

Open the Windows “Start” menu and select **Control Panel** (Windows XP or Windows Vista) or **Settings > Control Panel** (Windows 2000). Double-click **Add/Remove Programs**.

2 Uninstall the software.

Select the software you wish to uninstall (**DC Software** or **Irodio Photo & Video Studio**) and click **Change/Remove**. A confirmation dialog will be displayed; click **OK**. If a message appears warning that a shared file has been detected, select **Don't display this message again** and click **Yes**.

Close any open windows when the uninstall process is complete. After uninstalling Irodio Photo & Video Studio, restart the computer.

If DL-10 is not installed, you can copy pictures to the computer as described below. The illustrations in this section are from Windows XP.

1 Turn the camera off.

2 Connect the supplied USB cable.

Connect the cable to the computer USB port and then to the camera. The camera will turn on automatically.

3 Copy files from the camera to the computer.

The camera will be listed as a removable drive in "My Computer" with pictures stored in folders as shown at right. If a memory card is inserted in the camera, the drive will be named as shown at right and

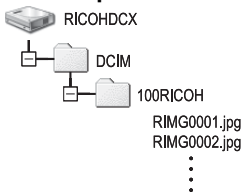

the contents of the memory card will be displayed. If no memory card is inserted, the drive will be named "RICOHDCI" and the contents of internal memory will be displayed. Copy pictures to the desired location on your computer.

Cautions

- Do not turn the camera off or disconnect the USB cable until copying is complete.
- Files in the destination folder with the same name as the pictures being copied will be overwritten. If necessary, rename files before copying begins.



SD Card Readers and PC Card Adapters

If the memory card is inserted in an *SD card reader* connected to the computer, or the memory card is inserted in a *PC card adapter* which is then inserted in a computer PC card slot, data can be read directly from the memory card (be sure that the reader or adapter is compatible with both the computer and the memory card). Pictures are stored on memory cards as shown below.

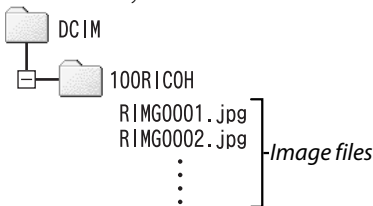

Caution

Do not use a computer to view or edit pictures on a memory card. Pictures that have been viewed or modified on a computer can no longer be displayed on the camera. Copy pictures to the computer for viewing and editing.

Disconnecting the Camera

Before disconnecting the camera from the computer, click the “Safely Remove Hardware” or “Unplug or Eject Hardware” icon in the taskbar (the illustration above shows the icon for Windows XP) and select **Safely Remove USB Mass Storage Device** or **Stop USB Mass Storage Device** from the menu that appears. You can then disconnect the USB cable.



Notes

- A warning may be displayed if the USB cable is disconnected without first removing the camera from the system as described above. Be sure to remove the camera from the system before disconnecting the cable.
- Confirm that transfer is complete before removing the camera from the system and disconnecting the cable.

Macintosh

The camera can be used with Mac OS 9.0–9.2.2 and Mac OS X versions 10.1.2–10.5.6.

Caution

The software on the supplied CD can not be installed on Macintosh computers. Macintosh computers can however be used to view the *Software User Guide* (note that Acrobat Reader is required to view the *Software User Guide* under Mac OS 9).

Copying Pictures to a Macintosh

To copy pictures to a Macintosh computer:

- 1 Turn the camera off.**
- 2 Connect the supplied USB cable.**
Connect the cable to the computer USB port.

Caution

Do not use force when connecting the cable or when handling the camera with the cable connected.

Connect the cable to the camera as shown. The camera will turn on automatically.

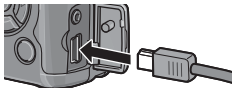
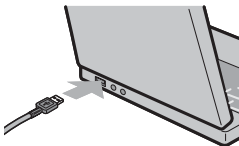

3 Copy files from the camera to the computer.

The camera will appear as a volume on the desktop with pictures stored in folders as shown at right. If a memory card is inserted in the camera, the drive will be named as shown at right and the contents of the memory card will be displayed. If no memory card is inserted, the drive will be named "RICOHDCI" and the contents of internal memory will be displayed. Copy pictures to the desired location on your computer.

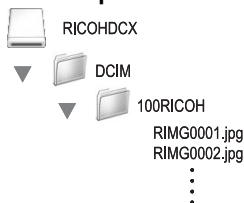

Disconnecting the Camera

Before disconnecting the camera from the computer, drag the camera volume into the Trash or select the camera volume and choose **Eject** from the **Special** menu (Mac OS 9) or **File** menu (Mac OS X). You can then disconnect the USB cable.



Notes

- A warning may be displayed if the USB cable is disconnected without first removing the camera from the system as described above. Be sure to remove the camera from the system before disconnecting the cable.
- Confirm that transfer is complete before removing the camera from the system and disconnecting the cable.
- Connecting the camera to a Macintosh computer may result in the creation of "FINDER.DAT" or ".DS_Store" files that will be listed by the camera as unmatched files. These files can be deleted without risk.

Troubleshooting

Error Messages



If an error message is displayed, take the steps listed below.

Message	Solution	Page
Insert card	No memory card inserted. Insert card.	13
Set date.	Camera clock not set. Set camera clock.	135
File Number Over Limit	Camera is out of file numbers. Insert another card.	13, 134
Unmatched File	Camera can not display file. Use computer to check file contents and delete file.	—
Insufficient memory. Continue?	Space on memory card is insufficient to copy all files. Insert another card.	13
Protected	File is protected and can not be deleted.	92
Card Is Write-Protected.	Card is write protected (locked). Unlock card.	14
Print settings cannot be set for this file.	File is a movie or other file that can not be selected for printing.	—
Insufficient Memory/ Capacity short	Insufficient memory to store additional files. Delete existing files or increase amount of memory available.	33, 124
	Maximum number of images selected for printing. Set number of prints for other images to zero.	96
Format internal memory.	Internal memory is not correctly formatted. Format internal memory.	124
Format card.	Card is not correctly formatted. Format card in camera.	124
Card Error	Format card. If message persists, card is faulty; discontinue use.	124
Writing Data	Camera is saving data. Wait until save is complete.	—
No File	No files available for playback.	—
Cannot Record	Memory is full. Use another card or remove card and use internal memory.	13, 14

Power Supply

Problem	Cause	Solution	Page
The camera does not turn on.	Battery is exhausted or not inserted.	Check that battery is correctly inserted. Charge battery (rechargeable battery only), insert fresh battery, or use AC adapter.	10, 12, 165
	Battery is incompatible.	Use supplied battery or compatible AAA batteries.	11
	AC adapter is not connected.	Check connection.	165
	Battery is not in correct orientation.	Insert battery in correct orientation.	12
The camera turns off during use.	Camera has turned off automatically to save power.	Turn camera on.	14
	Battery is exhausted.	Charge battery (rechargeable battery only), insert fresh battery, or use AC adapter.	10, 12, 165
	Battery is incompatible.	Use supplied battery or compatible AAA batteries.	11
The camera does not turn off.	Camera malfunction.	Remove and reinsert battery or disconnect and reconnect AC adapter.	12, 165
Low battery indicator displayed or camera turns off when battery has charge remaining.	Battery is incompatible.	Use supplied battery or compatible AAA batteries.	11
Battery can not be charged.	Battery has reached end of charging life.	Replace with a new battery.	12
Battery is quickly exhausted.	Ambient temperature is very high or very low.	—	—
	Poor lighting requires extensive use of flash.	—	—

Shooting

Problem	Cause	Solution	Page
No picture taken when shutter-release button is pressed.	Battery is exhausted.	Charge battery (rechargeable battery only), insert fresh battery, or use AC adapter.	10, 12, 165
	Camera is off or not in shooting mode.	Press POWER button to turn camera on or press  to select shooting mode.	14, 29
	Camera is in playback mode.	Press  to select shooting mode.	15, 29
	Shutter-release button was not fully pressed.	Press shutter-release button all the way down.	18
	Memory card is not formatted.	Format card.	124
	Memory card is full.	Insert new card or delete files.	13, 33
	Memory card has reached end of working life.	Insert new card.	13
	Flash is charging.	Wait until flash lamp stops blinking.	25
	Memory card is locked.	Unlock card.	14
Memory card contacts are dirty.	Clean with soft, dry cloth.	—	
Can not view photos after shooting.	Display time is too short.	Choose longer display time.	126
Picture display is blank.	Camera is off or picture display is dark.	Turn camera on or adjust picture display brightness.	14, 124
	Picture display is off.	Press DISP. to turn picture display on.	36
	A/V cable is connected.	Disconnect cable.	104
Camera unable to focus in autofocus mode.	Lens is dirty.	Clean with soft, dry cloth.	171
	Subject is not at center of frame.	Use focus lock.	21
	Subject not suitable for autofocus.	Use focus lock or manual focus.	21, 60
	Subject is too close.	Use macro mode or move away from subject.	23
Pictures are blurred.	Camera moved during shooting.	Use tripod or press elbows against torso.	17
	Lighting is poor and shutter speeds are slow.	Use the flash or choose higher ISO setting.	24, 84

Problem	Cause	Solution	Page
Flash does not fire or will not charge.	Flash is not raised.	Slide OPEN switch down to raise flash.	24
	Flash cover is not fully open.	Do not obstruct flash cover.	—
	Bracketing enabled or camera in continuous, dynamic range double shot, or movie mode.	Change camera settings.	48, 68, 70, 88
	Flash is off.	Raise flash and choose another flash mode.	24
	Battery is exhausted.	Charge battery (rechargeable battery only), insert fresh battery, or use AC adapter.	10, 12, 165
Flash does not illuminate subject.	Subject is more than 3.0 m/9.8 ft. from camera.	Move closer to subject.	24
	Subject is dark.	Increase flash output.	72
	Flash output is too low.	Increase flash output.	72
	Flash cover is not fully open.	Do not obstruct flash cover.	—
Photos are too bright.	Flash output is too high.	Reduce flash output, move away from subject, or use different light source.	72
	Photo is overexposed.	Use exposure compensation or choose faster shutter speed.	44, 77
	Picture display is too bright.	Adjust picture display brightness.	124
Photos are too dark.	Flash is off and subject is poorly lit.	Raise flash and choose another flash mode.	24
	Photo is underexposed.	Use exposure compensation or choose slower shutter speed.	44, 77
	Picture display is too dark.	Adjust picture display brightness.	124
Colors are unnatural.	Camera unable to adjust white balance for shooting conditions using auto white balance.	Include white object in photo or choose another white balance option.	79
Photo information not displayed.	Indicators are hidden.	Press DISP. to display indicators.	36
Picture display brightness changes during focusing.	Ambient lighting is poor or differs from that used for autofocus.	This is normal and does not indicate a malfunction.	—
Vertical streaks (“smear”) appear in photos.	Subject is bright.	This is normal and does not indicate a malfunction.	—

Problem	Cause	Solution	Page
Tilt indicator is not displayed.	Off or Sound selected for Level Setting.	Choose Display or Disp + Snd.	27
	Indicators are hidden.	Press DISP. to display indicators.	36
	The camera is upside down.	Hold the camera in the correct orientation.	17
Photo is not level, although tilt indicator showed that camera was level.	Camera was moving when photo was taken.	Do not take pictures from moving objects.	—
	Subject is not level.	Straighten subject.	—

Playback/Deletion

Problem	Cause	Solution	Page
Can not play pictures back.	Camera not in playback mode.	Press  .	15, 29
	A/V cable incorrectly connected.	Reconnect A/V cable.	104
	Video mode does not match TV.	Choose another video mode.	135
Can not view pictures on memory card.	Memory card empty or not inserted.	Insert card that has been formatted in camera and contains pictures recorded with camera.	13, 124
	Card was not formatted in camera.		
	Pictures were created with other device.		
	Memory card contacts are dirty.	Clean with soft, dry cloth.	—
	Card malfunction.	Insert another card. If you can view pictures on second card, first card has probably malfunctioned; discontinue use.	—
Picture display has turned off.	Battery is exhausted.	Charge battery (rechargeable battery only), insert fresh battery, or use AC adapter.	10, 12, 165
	Camera has turned off automatically to save power.	Turn camera on.	14
Can not delete file.	File is protected.	Remove protection.	92
	Memory card is locked.	Unlock memory card.	14
Can not format card.	Card is locked.		

Miscellaneous

Problem	Cause	Solution	Page
Can not insert memory card.	Card is not in correct orientation.	Insert in correct orientation.	13
Camera controls have no effect.	Battery is exhausted.	Charge battery (rechargeable battery only), insert fresh battery, or use AC adapter.	10, 12, 165
	Camera malfunction.	Turn camera off and then on again.	14
		Remove and reinsert battery or disconnect and reconnect AC adapter.	12, 165
Date is incorrect.	Clock is not set correctly.	Set clock to correct date and time.	135
Date has been reset.	Battery has not been inserted for about a week.	Set clock to correct date and time.	135
Camera does not turn off automatically.	Off selected for Auto Power Off .	Choose another setting.	125
Camera does not beep.	Beep is muted.	Choose another option for Volume Settings .	28, 126
Pictures are not displayed on TV.	Video mode does not match TV.	Choose another video mode.	135
	A/V cable not connected.	Connect A/V cable.	104
	TV is not tuned to VIDEO IN channel.	Tune TV to VIDEO IN channel.	—

2 Allow the Ricoh application Internet access.

In the “Windows Firewall” dialog, click the **Exceptions** tab and check whether DL-10 is listed under “Programs and Services.” If it is, place a check in the check box next to DL-10 and click **OK**. If it is not listed, click **Add Program...** to add DL-10 to the list of exceptions.

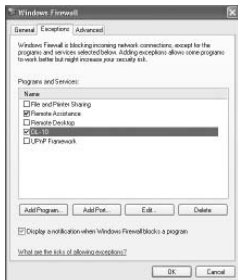

If you clicked Ask Me Later to block DL-10, a security alert will be displayed the next time the program starts. Click **Unblock** to remove the block.

Specifications

Effective pixels		Approximately 10 million
Image sensor		1/1.7" CCD (approximately 10.4 million total pixels)
Lens	Focal length	6.0 mm (35-mm format equivalent: 28 mm)
	Aperture (f-number)	f/1.9 – f/9 (ND filter used for apertures of f/8.0 – f/11 in auto shooting mode)
	Focus range (from lens)	Approx. 30 cm – ∞; approx. 1.0 cm – ∞ in macro mode
	Construction	8 elements in 6 groups (2 aspherical lens elements with 2 surfaces)
Zoom		4.0 × digital zoom; approx. 5.7 × auto resize zoom (VGA)
Focus mode		CCD-based multi and spot AF; MF; Snap; ∞; focus lock and AF-assist
Shutter speed	Photographs	180, 120, 60, 30, 15, 13, 10, 8, 6, 5, 4, 3.2, 2.5, 2, 1.6, 1.3, and 1 – 1/2000 s (upper and lower limits vary according to shooting and flash mode)
	Movies	1/30 – 1/2000 s
Exposure control	Metering	TTL-CCD metering in multi (256-segment), center-weighted, and spot modes with autoexposure lock
	Mode	Program AE, aperture priority AE, shutter priority AE, manual exposure
	Exposure compensation	Manual (+2.0 to –2.0 EV in increments of 1/3 EV); auto bracketing (–0.5 EV, ±0 EV, +0.5 EV and –0.3 EV, ±0 EV, +0.3 EV)
ISO sensitivity (Standard Output Sensitivity)		Auto, Auto-Hi, ISO 64, ISO 100, ISO 200, ISO 400, ISO 800, ISO 1600
White balance		Auto, Multi-P AUTO, Outdoors, Cloudy, Incandescent Lamp, Fluorescent Lamp, Manual Settings, Detail; white balance bracketing
Flash	Mode	Auto (flash fires when lighting is poor or subject is backlit), red-eye, on, slow sync, manual, off
	Range (built-in flash)	Approx. 20 cm – 3.0 m (ISO auto)
	Flash compensation	±2.0 EV in increments of 1/3 EV
Picture display		3.0" transparent LCD; approx. 920,000 pixels
Shooting mode		Auto, program shift, aperture priority, shutter priority, manual, scene (text, movie, skew correct, dynamic range double shot), "My Settings"
Picture quality ¹		Fine, Normal, RAW (DNG) ²
Image size (pixels)	Photographs	3648 × 2736, 3648 × 2432, 2736 × 2736, 3264 × 2448, 2592 × 1944, 2048 × 1536, 1280 × 960, 640 × 480
	Movies	640 × 480, 320 × 240
	Text mode	3648 × 2736, 2048 × 1536

Storage	SD/SDHC and MultiMedia memory cards; internal memory (approx. 88 MB)	
File size (approx.)	3648 × 2736	2,164 KB/frame (N), 3,738 KB/frame (F), 18.2 MB/frame (RAW)
	3648 × 2432	1,925 KB/frame (N), 3,325 KB/frame (F), 16.2 MB/frame (RAW)
	2736 × 2736	1,628 KB/frame (N), 2,809 KB/frame (F), 13.7 MB/frame (RAW)
	3264 × 2448	1,756 KB/frame (N)
	2592 × 1944	1,151 KB/frame (N)
	2048 × 1536	763 KB/frame (N)
	1280 × 960	447 KB/frame (N)
File format	640 × 480	106 KB/frame (N)
	Photographs	JPEG (Exif Ver. 2.21) ³ , RAW (DNG)
	Movies	AVI (OpenDML Motion JPEG compliant)
	Compression	JPEG baseline compliant (photographs and movies)
Other shooting options	Continuous shooting (continuous, S-Cont, M-Cont); self-timer (shutter release delay of approx. 10 s or 2 s); interval timer (intervals of 5 s to 1 hour in increments of 5 s) ⁴ ; color bracketing; B&W (TE); color space selection; noise reduction; histogram display; framing grid; depth-of-field indicator; tilt indicator; hot shoe	
Other playback options	Auto image rotation; multi-frame playback; playback zoom (up to 16×); resize	
Interface	USB 2.0 (High-Speed) Mini-B connector; Mass Storage ⁵ ; audio output 1.0 Vp-p (75 Ω)	
Video signal format	NTSC, PAL	
Power source	One DB-65 rechargeable battery (3.7V)	
	Two AAA alkaline or NiMH batteries	
	Optional AC-4c AC adapter (3.8V)	
Battery life (based on CIPA standard) ⁶	<ul style="list-style-type: none"> DB-65: approx. 370 shots AAA alkaline batteries: approx. 25 shots⁷ 	
Dimensions (W × H × D)	108.6 mm × 59.8 mm × 25.5 mm (excluding projections)	
Weight (approx.)	<ul style="list-style-type: none"> Camera (excluding battery, memory card, and strap): 188 g Battery and strap: 30 g 	
Tripod screw hole	1/4-20UNC	
Date storage time	Approx. 1 week	
Operating temperature	0 °C to 40 °C	
Operating humidity	85% or less	
Storage temperature	-20 °C to 60 °C	

- 1 The options available vary with image size.
- 2 A JPEG file is also recorded (the JPEG file may be a fine- or normal-quality file with the dimensions as the RAW file or a normal-quality file 640×480 pixels in size). RAW files use the standard DNG format promoted by Adobe Systems, Inc.
- 3 Compatible with the **D**esign rule for **C**amera **F**ile system (DCF, a JEITA standard) and DPOF. Full compatibility with other devices is not guaranteed.
- 4 Flash off.
- 5 Mass Storage is supported under Windows 2000, Windows XP, Windows Vista, Mac OS 9.0–9.2.2, and Mac OS X 10.1.2–10.5.6.
- 6 Measured according to CIPA standard. For reference only; actual number of shots varies greatly according to how camera is used.
- 7 Measured with Panasonic alkaline batteries.

Internal Memory/Memory Card Capacity

The following table lists the approximate number of frames or length of movies that can be stored in internal memory or on a memory card at different settings.

		Internal memory	1 GB	2 GB	4 GB	8 GB	16 GB	32 GB		
Photographs	RAW	4	51	104	204	417	836	1677		
	F	3,648 × 2,736	22	240	487	957	1957	3922	7867	
	N		38	414	842	1653	3379	6769	13579	
	RAW		5	57	116	229	469	939	1884	
	F	3,648 × 2,432	25	269	548	1077	2202	4412	8851	
	N		43	465	945	1856	3795	7602	15251	
	RAW		6	68	138	271	554	1110	2227	
	F	2,736 × 2,736	29	319	647	1270	2596	5202	10435	
	N		50	544	1097	2155	4405	8824	17702	
			3,264 × 2,448	47	512	1041	2045	4181	8376	16802
			2,592 × 1,944	72	775	1576	3094	6325	12671	25418
			2,048 × 1,536	109	1184	2363	4640	9486	19005	38125
			1,280 × 960	175	1888	3840	7541	15415	30882	61951
			640 × 480	705	7553	15359	30159	61643	123489	247716
Text mode	F	3,648 × 2,736	38	414	842	1653	3379	6769	13879	
	N	2,048 × 1,536	109	1184	2363	4640	9486	19005	38125	
Movies		640 × 480, 30 fps	51 s	9 min. 15 s	18 min. 49 s	38 min. 41 s	75 min. 31 s	151 min. 18 s	303 min. 31 s	
		640 × 480, 15 fps	1 min. 42 s	18 min. 20 s	37 min. 17 s	76 min. 41 s	149 min. 40 s	299 min. 50 s	601 min. 28 s	
		320 × 240, 30 fps	2 min. 12 s	23 min. 42 s	48 min. 13 s	99 min. 8 s	193 min. 30 s	387 min. 39 s	777 min. 37 s	
		320 × 240, 15 fps	4 min. 19 s	46 min. 19 s	94 min. 11 s	193 min. 41 s	378 min. 2 s	757 min. 18 s	1519 min. 7 s	



Notes

- The figures for movies are the total length that can be recorded. Each movie can be up to 90 minutes long (4 GB in size).
- The maximum number of shots that can be taken in a single burst is 999. If memory remains for more than 999 exposures, "999" is shown in the display.
- Depending on the subject, the number of pictures that can be taken may differ from the number of exposures remaining.
- Capacity varies with shooting conditions and the make of memory card.
- Use a high-speed memory card when shooting for extended periods.

Optional Accessories

The GR DIGITAL III can be used with the following optional accessories:



AC-4c AC adapter



DB-65 rechargeable battery

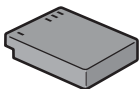

BJ-6 battery charger

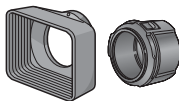

GH-2 hood and adapter

Includes a hood to prevent sunlight from entering the lens and an adapter for general-purpose filters with a diameter of 43 mm. Improves results with backlit subjects.



GW-2 wide conversion lens

A conversion lens with a focal length multiplier of 0.75x for wide-angle shots, giving a combined focal length of 21 mm (35-mm format equivalent). Requires GH-2. Case included.

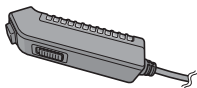

CA-1 cable switch

A wired remote shutter release that attaches to the camera USB connector.

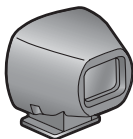

GV-1 external viewfinder

An optical viewfinder that attaches to the camera hot shoe. Frames offer coverage for 21 mm and 28 mm lenses (35-mm format equivalent). Case included.

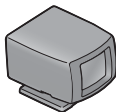

GV-2 mini external viewfinder

A compact optical viewfinder that attaches to the camera hot shoe. Frames offer coverage for 28 mm lenses (35-mm format equivalent) with marks for 1:1 aspect ratio. Case included.



GC-3 soft case



GC-4 soft case (can be used with GV-2)

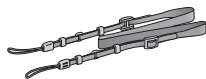

GS-1 or ST-2 neck strap



Notes

- Before using optional accessories, read the manual provided with the product.
- The built-in flash can not be used with conversion lenses or lens hoods.
- GH-1, GW-1, and GT-1 accessories for GR DIGITAL and GR DIGITAL II cameras can not be used.
- For the latest information on optional accessories, visit the Ricoh website (<http://www.ricohpmmc.com/>).



Tip: Attaching the Neck Strap

Remove the end of the neck strap from the buckle and attach the strap as shown at right.



Tip: The Ring Cap

Remove the ring cap before attaching a conversion lens or the lens hood and adapter.

- **To remove the ring cap:** Turn the camera off and rotate the cap counterclockwise until it can be removed.
- **To reattach the ring cap:** Turn the camera off and place the cap on the camera, keeping the marks on the camera body (①) and ring cap (②) aligned. Rotate the cap clockwise until it clicks into place.

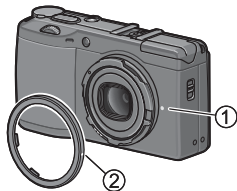

Camera System and Accessories

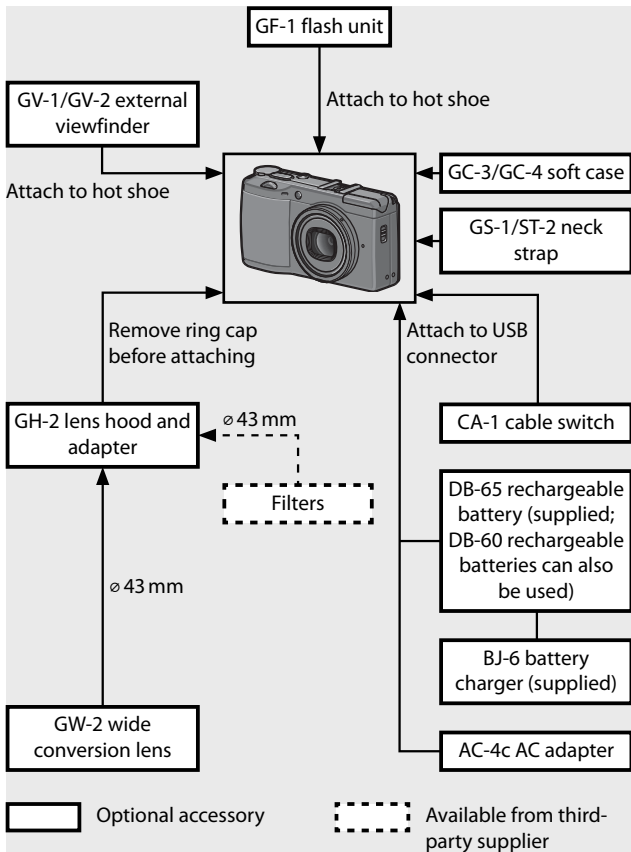

Using an Optional AC Adapter

An optional AC adapter is recommended for extended use or when the camera is connected to a computer. Be sure the camera is off before connecting the AC adapter.

1 Open the battery/card cover.

Unlatch (1) and open (2) the cover and remove any batteries.

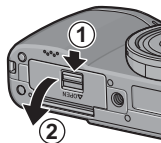

2 Insert the AC adapter coupler.

The battery latch will click into place when the coupler is fully inserted.

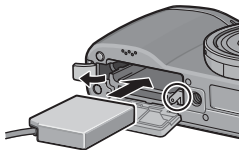

3 Place the cable in the cable channel.

Open the power (DC input) cable cover and place the power cable in the cable channel.

4 Close the battery/card cover.

Close (1) and latch (2) the cover.

Caution  Be sure the cover is latched.

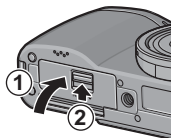

5 Plug the adapter in.

Attach the AC cable to the adapter and plug it in to a power outlet.

Caution  Be sure that both plugs are fully inserted.



Cautions

- Disconnect the AC adapter and unplug it from the power outlet when not in use.
- Data may become corrupted if the AC adapter is disconnected or power is interrupted while the camera is on.
- The battery indicator () may be displayed while the AC adapter is in use. This is normal, and you can continue using the camera.
- Do not pick up the camera by the cable when the AC adapter is attached.

Disconnecting the AC Adapter

Be sure the camera is off before disconnecting the AC adapter.

1 Unplug the adapter.

2 Open the battery/card cover.

Slide the release lever to "OPEN" and open the cover.

3 Remove the AC adapter coupler.

4 Close the battery/card cover.

Close and latch the cover.

The GF-1 Flash Unit

An optional GF-1 flash unit can be connected to the camera hot shoe.

1 Close the flash cover (page 25).

2 Attach the flash.

Turn the camera and the GF-1 off and attach the GF-1 to the camera hot shoe.



3 Turn the flash and camera on.



Note

If the optional flash unit icon is not displayed, turn the GF-1 and camera off and then remove and reattach flash.



Cautions

- Blur may occur at slow shutter speeds.
- Do not use the built-in flash when the GF-1 is attached. Failure to observe this precaution could cause injury or damage the product.

Other Flash Units

Use only flash units with one signal terminal, which must be an X-contact with a positive voltage of no more than 20V. Use a flash that covers the angle of view of the lens.

1 Close the flash cover (page 25).

2 Attach the flash.

Turn the camera and the optional flash unit off and attach the flash to the camera hot shoe.

3 Set aperture manually.

Turn the camera on, select mode A or M, and choose an aperture (pages 14, 43, 44).

4 Choose a manual ISO sensitivity setting.

Select an option other than **Auto** for ISO sensitivity (page 84).

5 Turn the flash on.

Turn the flash on and set it to auto mode. Set aperture and ISO sensitivity to the values selected with the camera. Take a test shot and adjust flash aperture and ISO settings as necessary.

Turn the optional flash unit off before removing it from the camera.

Cautions

- If the external flash is on, it will fire with every shot regardless to the flash mode selected with the camera. Turn the flash unit off to shoot without the flash.
- Optional flash units are in principle for use at ranges that exceed the range of the built-in flash. Using an optional flash unit at shorter ranges may result in overexposure.

Using the Camera Abroad

Using the AC-4c AC Adapter and BJ-6 Battery Charger

These products are for use with currents of 100–240V and 50 or 60Hz. Before travelling, purchase a travel adapter for connection to the type of outlets used at your destination. Do not use these products with electrical transformers, as this could damage the camera.

Warranty

This product was manufactured for use in the country of purchase, and the warranty is not valid in other countries. Should the product fail or malfunction while out of the country, the manufacturer assumes no responsibility for servicing the product locally or bearing any expenditure incurred thereby.

Television Playback

The supplied A/V cable can be used to connect the camera to televisions and monitors equipped with a video input terminal. The camera supports the NTSC and PAL video formats; before connecting the camera to a video device, select the appropriate video output mode.

Precautions for Use

- This product was manufactured for use in the country of purchase; the warranty is not valid in other countries. Should the product fail or malfunction while out of the country, the manufacturer assumes no responsibility for servicing the product locally or bearing any expenditure incurred thereby.
- Do not drop the camera or subject it to physical shocks. When carrying the camera, be careful that it does not strike other objects. Particular care is required to protect the lens and picture display.

- The flash may overheat if fired many times in succession. Do not use the flash more than necessary. Do not use the flash in close contact with your body or other objects. Failure to observe these precautions could result in burns or fire.
- Using the flash unit in close proximity to your subject's eyes could cause temporary visual impairment. Particular care should be observed when photographing infants. Do not direct the flash at the operator of a motor vehicle.
- Batteries may become hot with extended use. Wait for batteries to cool before removing them from the camera.
- The picture display may be difficult to read in direct sunlight.
- You may notice that picture display varies in brightness or contains pixels that do not light or that are always lit. This is common to all LCD monitors and does not indicate a malfunction.
- Do not apply force to the picture display.
- Abrupt changes in temperature may cause condensation, resulting in visible condensation inside the lens or camera malfunction. This can be avoided by placing the camera in a plastic bag to slow the temperature change, and removing it only after the air in the bag has reached the same temperature its surroundings.
- To prevent damage to the product, do not insert objects into the holes in the microphone and speaker coverings.
- Keep the camera dry and avoid handling it with wet hands. Failure to observe these precautions could result in product malfunction or electric shock.
- Take a test shot to ensure that the camera is functioning properly before using it on important occasions such as travel or weddings. We recommend that you keep this manual and spare batteries at hand.

**Tip: Avoiding Condensation**

Condensation is particularly likely to occur if you move to an area with a sharply different temperature, if humidity is high, in a cold room after the heater has come on, or where the camera is exposed to cold air from an air conditioner or other device.

Camera Care and Storage

Caring for the Camera

- Photographs can be affected by fingerprints and other foreign matter on the lens. Avoid touching the lens with your fingers. Remove dust or lint with a blower from a camera supply store, or gently clean the lens with a soft, dry cloth. Clean the picture display by wiping it with a soft cloth dampened with a small amount of any monitor cleaner that does not contain organic solvents.
- Clean the camera thoroughly after using it at the beach or handling cosmetics. Do not expose the camera to volatile substances such as thinner, benzene, or pesticides. Failure to observe this precaution could result in damage to the camera or its finish.
- In the unlikely event of malfunction, visit a Ricoh Repair Center.
- The camera contains high-voltage circuits. Do not disassemble.
- The picture display is easily scratched; avoid touching it with hard objects.

Storage

- Do not store the camera where it will be exposed to: extreme heat or humidity; large changes in temperature or humidity; dust, dirt, or sand; severe vibration; prolonged contact with chemicals, including mothballs and other insect repellent, or with vinyl or rubber products; strong magnetic fields (for example, in the vicinity of a monitor, transformer, or magnet).
- Remove the batteries if the product will be left unused for a long period of time.

Before Cleaning

Turn the camera off and remove the battery or disconnect the AC adapter.

Warranty and Servicing

1. This product is backed by a limited warranty. During the warranty period mentioned in the Warranty supplied with your camera, any defective parts will be repaired free of charge. In the event of a camera malfunction, contact the dealer from which you purchased the camera or your nearest Ricoh Repair Center. Please note that you will not be reimbursed for the cost of bringing the camera to the Ricoh Repair Center.
2. This warranty does not cover any damage resulting from:
 - 1 failure to follow the instructions in the instruction manual;
 - 2 repair, modification or overhaul not conducted by an authorized service center listed in the instruction manual;
 - 3 fire, natural disaster, act of God, lightning, abnormal voltage, etc.;
 - 4 improper storage (noted in the "Camera User Guide"), leaking of battery and other fluids, mold, or otherwise insufficient care of the camera.
 - 5 submergence in water (flooding), exposure to alcohol or other beverages, infiltration of sand or mud, physical shock, dropping of the camera, or pressure on the camera, and other unnatural causes.
3. After the warranty period has passed, you will be liable for all repair fees, including those incurred at an authorized service center.
4. You will be liable for all repair fees, even within the warranty period, if the warranty card is not attached or if the distributor's name or the purchase date have been changed or are not indicated on the card.
5. Expenses for overhaul and thorough inspection by special request of the customer will be charged to the customer, whether or not they are incurred during the warranty period.
6. This warranty only applies to the camera and not to the accessories, such as the case and strap, nor does it apply to the battery and other consumables provided.
7. Any consequential damages arising from failure of the camera, such as expenses incurred in taking pictures or loss of expected profit, will not be reimbursed whether they occur during the warranty period or not.
8. The warranty is only valid in the country in which the camera was purchased.
 - * The above provisions refer to repairs offered free of charge, and do not limit your legal rights.
 - * The intention of the above provisions is also described in the warranty card provided with this camera.
9. Parts essential to the servicing of the camera (that is, components required to maintain the functions and quality of the camera) will be available for a period of five years after the camera is discontinued.
10. Please note that if the camera is seriously damaged by flooding, submergence, infiltration of sand or mud, violent shocks or dropping, it may not be repairable, and restoration to its original condition may be impossible.



Notes

- Before sending the camera in for repair, check the battery and read the instruction manual again to ensure proper operation.
- Some repairs require a significant amount of time to complete.
- When sending the camera to a service center, please include a note which describes the defective part and the problem as precisely as possible.
- Remove all accessories not related to the problem before sending the camera to the service center.
- This warranty does not apply to data stored on memory cards or in internal memory.

NOTICES

USA FCC Part 15 Class B

The equipment has been tested and found to comply with the limits for a Class B digital device, pursuant to part 15 of the FCC Rules. These limits are designed to provide reasonable protection against harmful interference in a residential installation. This equipment generates, uses, and can radiate radio frequency energy and if not installed and used in accordance with the instructions, may cause harmful interference to radio communications. However, there is no guarantee that interference will not occur in a particular installation. If this equipment does cause harmful interference to radio or television reception, which can be determined by turning the equipment off and on, then user is encouraged to try to correct the interference by one or more of the following measures:

- Reorient or relocate the receiving antenna.
- Increase the separation between the equipment and receiver.
- Connect the equipment to an outlet on a circuit different from that to which the receiver is connected.
- Consult the dealer or an experienced radio/TV technician for help. (FCC 15.105B)

Changes or modifications not expressly approved by the party responsible for compliance could void the user's authority to operate the equipment. (FCC 15.21)

Properly shielded and grounded cables and connectors must be used for connection to a host computer in order to comply with FCC emission limits. (FCC 15.27)

An AC adapter with a ferrite core must be used for RF interference suppression.

COMPLIANCE INFORMATION STATEMENT

Product Name: DIGITAL CAMERA

Model Number: GR DIGITAL III

This device complies with Part 15 of the FCC Rules.

Operation is subject to the following two conditions:

- (1) This device may cause harmful interference, and
- (2) This device must accept any interference received, including interference that may cause undesired operation.

RICOH AMERICAS CORPORATION

5 Dedrick Place, West Caldwell NJ, 07006 Tel.: 1-800-225-1899

Note to Users in Canada

Note: This Class B digital apparatus complies with Canadian ICES-003

Remarque Concernant les Utilisateurs au Canada









Avertissement: Cet appareil numérique de la classe B est conforme à la norme NMB-003 du Canada.

IMPORTANT SAFETY INSTRUCTIONS—SAVE THESE INSTRUCTIONS

DANGER—TO REDUCE THE RISK OF FIRE OR ELECTRIC SHOCK, CAREFULLY FOLLOW THESE INSTRUCTIONS.

Index

Symbols

-  (auto) mode 4, 17–21
-  (delete) button 3, 33–35
-  (DISP.) button 3, 36, 37
-  (flash) button 3, 5, 24
-  (macro) button 3, 23
-  (playback) button 3, 15, 29, 91
-  (self-timer) button 3, 26
-  (enlarged view) button 3, 22, 31, 32, 122
-  (thumbnail display) button ..3, 22, 31, 32, 122

A

- A (aperture priority) mode 4, 42
- A/V cable ii, 104
- A/V cable connector 3, 104
- AAA 11–12, 159, 170, 171
- AC adapter 162, 165–166, 169
- ADJ Lever Setting** 119–120
- ADJ Shutter Confirmation** 120
- ADJ. lever 3, 5, 78, 119–120
- Adobe Reader 141–142, 148
- AF Auxiliary Light** 125
- AF auxiliary light 5, 26, 125
- Alert 156–157
- Alkaline 11–12, 159, 170, 171
- Aperture 40, 42, 43, 44, 85, 123, 158
- Auto Aperture Shift** 85
- Auto Bracket** 70–71
- Auto Power Off** 125
- Auto Rotate** 127
- Autofocus 18, 19, 59, 64, 65
- Autofocus/flash lamp 3, 14, 18, 25
- AVI 87

B

- Backlighting 77
- Battery
 - ... ii, 8, 10–12, 159, 164, 165, 170, 171
- Battery charger ii, 10, 165, 169
- Battery level 8

- Battery/card cover 3, 12, 13, 165
- Black-and-white 66–67, 70–71
- Blur 20
- Bracketing 70–71
- Brightness 100–102, 124

C

- Cable switch 162
- Caplio 139
- Card Sequence No.** 134
- Case, soft 163
- CD ii, 138, 140, 142
- CL-BKT Black & White (TE)** 131
- Clock 16
- Close-up 23
- Color 66–67, 70–71, 79, 82, 132
- Color Space Setting** 132
- Computer 136–149
- Connector cover...3, 104, 107, 144, 148
- Continuous Mode** 68–69
- Contrast 48–49, 66–67, 100–102
- Conversion lens, wide 162, 163
- Copy to Card from Internal Memory** 97
- Copying photographs 97, 136–149

D

- Date 16, 76
- Date Imprint** 76
- Date Settings** 16, 135
- DB-60 8, 10–12, 164, 170, 171
- DB-65 ...ii, 8, 10–12, 159, 164, 170, 171
- DC power cable cover 3, 165
- Defaults 55–56, 85
- Deleting photographs 33–35
- Density** 52
- Depth of field 42, 59
- Digital zoom 22
- Digital Zoom Image** 133
- DISP. button 3, 36, 37
- DL-10
 - ...137, 138, 139–141, 143, 145, 156–157
- DL-10, installing 139–141

DL-10, system requirements for	137
DL-10, unblocking.....	156–157
DL-10, uninstalling.....	143
DNG.....	58
DPOF.....	95–96
Dynamic range.....	48
Dynamic range double shot mode.....	48–50
Dynamic Range Expansion	49–50

E

Edit My Settings	117–118
Error message.....	150–155, 156–157
Exposure.....	18, 61–62, 70–71, 77–78, 102, 123
Exposure Compensation	77–78
Exposure lock.....	121
Exposure Metering	65
Exposure program.....	41

F

Fine picture quality.....	57, 58
Flash compensation.....	72
Flash cover.....	2, 24
Flash Exposure Compensation	72
Flash level.....	72
Flash mode.....	24
Flash OPEN switch.....	2, 24
Flash Synchro Settings	73
Flash, built-in.....	2, 24–25, 72, 73, 158, 170
Flash, manual.....	73
Flash, optional.....	167–168
Fn Button Display	129
Fn1 button.....	3, 119–120
Fn2 button.....	3, 119–120
Focus.....	18, 19, 59–65
Focus	58–63
Focus lock.....	21
Focus target.....	61–63
Format [Card]	124
Format [Internal Memory]	124
Formatting.....	124
Frame Rate	89
Frame size.....	89
Framing grid.....	36, 128

Full Press Snap	64
------------------------------	----

G

GF-1.....	167
Grid.....	36, 128
Grid Guide Display Options	128

H

Hand strap.....	ii
Highlights.....	37
Histogram.....	37, 38, 101–102
Hot shoe.....	ii, 162, 167, 168
Hot shoe cover.....	ii

I

Image Settings	66–67
Information Display Mode	130
Interval Shooting	75–76
Interval timer photography.....	75–76
Irodio Photo & Video Studio.....	iv, 138
ISO.....	74, 84–85, 125
ISO Auto-High Settings	125
ISO Setting	84–85

J

JPEG.....	58, 131, 159
-----------	--------------

K

Key custom options.....	113–123
-------------------------	---------

L

Language/言語	16, 135
LCD Brightness	124
LCD Confirmation Time	126
Lens.....	2, 17, 158, 171
Lens filter.....	162
Lens hood and adapter.....	162, 163
Level Compensation	100–102
Level Setting	127

M

M (manual) mode.....	4, 44–45
M Mode Dial Options	123
Mac OS.....	148–149
Macintosh.....	148–149
Macro mode.....	23

Manual Flash Amount	73
Manual focus.....	59, 60
Memory	
card	13–14, 97, 124, 134, 146, 161
Memory card reader.....	146
Memory, internal..	13, 14, 97, 124, 161
MENU/OK button	3, 54
Metering	61–62, 65
Microphone.....	2
Mode dial.....	2, 4, 40–53
Monochrome	66–67, 70–71
Movie mode	87–89
Movie playback.....	90
Movie Size	89
Multi-frame playback.....	31
MY modes.....	4, 53, 86, 130
My Settings for Fn Settings	118
My Settings WB Comp	118

N

Neck strap	163
Nickel-metal	
hydride.....	8, 11–12, 159, 170, 171
NiMH.....	8, 11–12, 159, 170, 171
Noise	74, 85
Noise Reduction	74
Noise Reduction ISO	74
Normal picture quality	57, 58
NTSC.....	105, 135

O

One Press M Mode	123
One Press Zoom Ratio	126
Operation Sounds	125

P

P (program shift) mode.....	4, 40–41
PAL	105, 135
PC card adapter.....	146
PictBridge.....	106
Picture display	
...3, 6–8, 36–37, 124, 130, 158, 170, 171	
Picture quality.....	57, 58
Picture Quality/Size	57–58
Picture size.....	57
Playback menu.....	91–103

Playback Mode Mode Dial

Options	123
Playback zoom	32
Playback, movies	90
Playback,	
photographs.....	29–32, 91–105
Playback, TV.....	104–105
Plus Normal Shooting	49–50
POWER button	2, 14, 15, 17, 122
Power Button Lamp	122
Pre-AF	65
Printing.....	76, 95–96, 106–111
Protect	92–94

R

RAW	30, 57, 58, 131
RAW/JPEG Setting	131
Recall My Settings	116
Rechargeable battery	ii, 10–12, 159
Reg. My Settings	114–115
Remote shutter release	162
Resize	97
Restore Defaults	85
RICOH Gate La.....	139
Ring cap.....	2, 163

S

S (shutter priority) mode.....	4, 43
<i>Safety Precautions</i>	ii
SCENE mode	4, 46–52
SD.....	13, 161
SDHC.....	13, 161
SECAM	105, 135
Security alert.....	156–157
Self-timer	26
Set Fn1 Button	121–122
Set Fn2 Button	121–122
Setup menu.....	124–135
Sharpness.....	66–67
Shooting Info Display Frame	129
Shooting menu	54–86
Show My Setting Name	129
Shutter	
speed.....	40, 42, 43, 44, 45, 123, 158
Shutter-release button	2, 17, 18, 19
Size	57

Skew.....	51, 98–99
Skew correct mode.....	51
Skew Correction	98–99
Slide Show	92
Snap Focus Distance	64
Software.....	139–141, 143
<i>Software User Guide</i>	ii, iv
Speaker	3, 27, 125–126
Specifications.....	158–160
Store Menu Cursor Position	133
Strap.....	ii, 163
Strap eyelet.....	ii, 2
Support.....	iv
Switch Shooting Mode	86

T

Text mode	52
Tilt indicator	27–28
Time and date.....	16, 76
Timer	26
Tripod screw hole.....	3, 48, 61
TV.....	104–105, 135, 169

U

Up-down dial.....	2, 5, 32, 123
USB cable.....	ii, 107, 144, 148
USB cable connector...3,	107, 144, 148

V

Video Out Mode	135
Viewfinder, external.....	130, 162
Viewing photographs ...	29–32, 104–105
Volume	90, 126
Volume Settings	126

W

Warranty	169, 172
White balance.....	77–83, 103
White Balance	79–81
White Balance Compensation (playback).....	103
White Balance Compensation (shooting).....	82–83
Windows.....	136–147, 156–157

Z

Zoom.....	22, 32
Zoom Button	122

Telephone Support Numbers in Europe

UK	(from within the UK)	02073 656 580
	(from outside of the UK)	+44 2073 656 580
Deutschland	(innerhalb Deutschlands)	06331 268 438
	(außerhalb Deutschlands)	+49 6331 268 438
France	(à partir de la France)	0800 88 18 70
	(en dehors de la France)	+33 1 60 60 19 94
Italia	(dall'Italia)	02 696 33 451
	(dall'estero)	+39 02 696 33 451
España	(desde España)	91 406 9148
	(desde fuera de España)	+34 91 406 9148

<http://www.service.riohpmmc.com/>

From environmental friendliness to environmental conservation and to environmental management

Ricoh is aggressively promoting environment-friendly activities and also environment conservation activities to solve the great subject of management as one of the citizens on our precious earth.

To reduce the environmental loads of digital cameras, Ricoh is also trying to solve the great subjects of "Saving energy by reducing power consumption" and "Reducing environment-affecting chemical substances contained in products".



If You Encounter a Problem with This Product

See "Troubleshooting" (page 150) in this manual. If the problem persists, contact a Ricoh office.

Ricoh offices	
RICOH COMPANY, LTD.	3-2-3, Shin-Yokohama Kouhoku-ku, Yokohama City, Kanagawa 222-8530, Japan http://www.ricoh.com/r_dc
RICOH AMERICAS CORPORATION	5 Dedrick Place, West Caldwell, New Jersey 07006, U.S.A. 1-800-22RICOH http://www.ricoh-usa.com/
RICOH INTERNATIONAL B.V. (EPMMC)	Oberrather Str. 6, 40472 Düsseldorf, GERMANY (innerhalb Deutschlands) 06331 268 438 (außerhalb Deutschlands) +49 6331 268 438 http://www.ricohpmmc.com/
RICOH UK LTD. (PMMC UK)	(from within the UK) 02073 656 580 (from outside of the UK) +44 2073 656 580
RICOH FRANCE S.A.S. (PMMC FRANCE)	(à partir de la France) 0800 88 18 70 (en dehors de la France) +33 1 60 60 19 94
RICOH ESPANA, S.A. (PMMC SPAIN)	(desde España) 91 406 9148 (desde fuera de España) +34 91 406 9148
RICOH ITALIA S.p.A. (PMMC ITALY)	(dall'Italia) 02 696 33 451 (dall'estero) +39 02 696 33 451
RICOH ASIA PACIFIC OPERATIONS LIMITED	21/F, One Kowloon, 1 Wang Yuen Street, Kowloon Bay, Hong Kong
Support for Irodio Photo & Video Studio	
North America (U. S. A.)	+1-800-458-4029 (toll free)
Europe	UK, Germany, France and Spain: +800-1532-4865 (toll free) Other countries: +44-1489-564-764
Asia	+63-2-438-0090
China	+86-21-5385-3786
Business hours: 9:00 AM to 5:00 PM	

Ricoh Company, Ltd.

Ricoh Building, 8-13-1, Ginza, Chuo-ku, Tokyo

104-8222, Japan

2009 August



EN (USA) GB (GB) AE (AE)



* 1 7 5 3 2 9 7 1 0 *

Free Manuals Download Website

<http://myh66.com>

<http://usermanuals.us>

<http://www.somanuals.com>

<http://www.4manuals.cc>

<http://www.manual-lib.com>

<http://www.404manual.com>

<http://www.luxmanual.com>

<http://aubethermostatmanual.com>

Golf course search by state

<http://golfingnear.com>

Email search by domain

<http://emailbydomain.com>

Auto manuals search

<http://auto.somanuals.com>

TV manuals search

<http://tv.somanuals.com>