

RICOH

RICOH PX

Camera User Guide

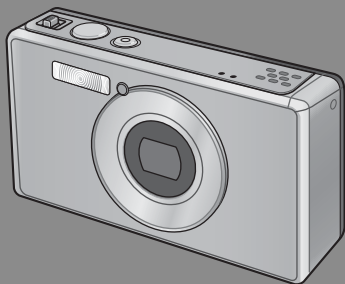

The serial number of this product is given on the bottom face of the camera.

Basic Operations

If you are using the camera for the first time, read this section.

This section provides a basic overview of how to turn on the camera, take pictures and play back pictures.

Advanced Operations

Read this section when you want to learn more about the different camera functions.

This section provides more detailed information about the functions used to take pictures and play back pictures, as well as information on how to customize the camera settings, print pictures, and use the camera with a computer.

The rechargeable battery needs to be charged before use. The battery is not charged at the time of purchase.

Preface

This manual provides information on how to use the shooting and playback functions of this product, as well as warnings on its use.

To make the best use of this product's functions, read this manual thoroughly before use. Please keep this manual handy for ease of reference.

Ricoh Co., Ltd.

Safety Precautions	Read all safety precautions thoroughly to ensure safe use.
Test Shooting	Please be sure to do some test shooting to make sure it is recording properly before normal use.
Copyright	Reproduction or alteration of copyrighted documents, magazines, music and other materials, other than for personal, home or similarly limited purposes, without the consent of the copyright holder is prohibited.
Exemption from Liability	Ricoh Co., Ltd. assumes no liability for failure to record or play back images caused by malfunction of this product.
Warranty	This product is manufactured to local specifications and the warranty is valid within the country of purchase. Should the product fail or malfunction while you are abroad, the manufacturer assumes no responsibility for servicing the product locally or bearing the expenditure incurred thereof.
Radio Interference	Operating this product in the vicinity of other electronic equipment may adversely affect the performance of both devices. In particular, operating the camera close to a radio or television may lead to interference. If interference occurs, follow the procedures below. <ul style="list-style-type: none">• Move the camera as far away as possible from the TV, radio or other device.• Reorient the TV or radio antenna.• Plug the devices into separate electrical outlets.

© 2011 RICOH CO., LTD. All rights reserved. This publication may not be reproduced in whole or in part without Ricoh's express written permission. Ricoh reserves the right to change the contents of this document at any time without prior notice.

Every effort has been made to ensure the accuracy of the information in this document. Should you nevertheless notice any errors or omissions, we would be grateful if you would notify us at the address listed on the back cover of this booklet.

Microsoft, Windows, Windows Vista®, Windows 7™, and Internet Explorer are registered trademarks of Microsoft Corporation in the United States of America and other countries. Macintosh and Mac OS are registered trademarks of Apple Inc. in the United States of America and other countries. Adobe, the Adobe logo, and Adobe Reader are trademarks of Adobe Systems Incorporated in the United States and other countries. MediaBrowser™ is a trademark of Pixela Corporation.

HDMI, the HDMI logo and High-Definition Multimedia Interface are trademarks or registered trademarks of HDMI Licensing LLC.

Eye-Fi, the Eye-Fi logo and Eye-Fi connected are trademarks of Eye-Fi, Inc.

All other trade names mentioned in this document are the property of their respective owners.

Safety Precautions

Warning Symbols

Various symbols are used throughout this instruction manual and on the product to prevent physical harm to you or other people and damage to property. The symbols and their meanings are explained below.



Danger

This symbol indicates matters that may lead to imminent risk of death or serious injury if ignored or incorrectly handled.



Warning

This symbol indicates matters that may lead to death or serious injury if ignored or incorrectly handled.



Caution

This symbol indicates matters that may lead to injury or physical damage if ignored or incorrectly handled.

Sample Warnings



The  symbol alerts you to actions that must be performed.



The  symbol alerts you to prohibited actions.

The  symbol may be combined with other symbols to indicate that a specific action is prohibited.

● Examples

 Do not touch  Do not disassemble

Observe the following precautions to ensure safe use of this equipment.

Danger



● Do not attempt to disassemble, repair or alter the equipment yourself. The high-voltage circuitry in the equipment poses significant electrical hazard.



● Do not attempt to disassemble, alter or directly solder the battery.



● Do not put the battery in a fire, attempt to heat it, use it in a high temperature environment such as next to a fire or inside a car, or abandon it.



● Do not attempt to pierce, hit, compress, drop, or subject the battery to any other severe impact or force.



● Do not use a battery that is significantly damaged or deformed.



● Do not short the battery by using a metal object to connect the positive and negative terminals. Do not store or transport the battery with metal objects such as necklaces or metal pens.



- Charge the battery using the designated USB cable or battery charger, and use only with compatible devices.



- Should the device overheat or emit smoke or an unusual smell, cease use immediately and take the device to your nearest dealer or service center.



- If fluid from a leaking battery enter your eyes, immediately flush the affected area with water from the tap or another clean source and seek medical attention. **Do not rub your eyes.**

Warning



- Turn off the power immediately in the event of abnormalities such as smoke or unusual odors being emitted. Remove the battery as soon as possible, being careful to avoid electric shocks or burns. If you are drawing power from a household electrical outlet, be sure to unplug the USB power adapter from the outlet to avoid fire or electrical hazards. Discontinue use of the equipment immediately if it is malfunctioning. Contact the nearest service center at your earliest convenience.



- Turn off the power immediately if any metallic object, water, liquid or other foreign object gets into the camera. Remove the battery and memory card as soon as possible, being careful to avoid electric shocks or burns. If you are drawing power from a household electrical outlet, be sure to unplug the USB power adapter from the outlet to avoid fire or electrical hazards. Discontinue use of the equipment immediately if it is malfunctioning. Contact the nearest service center at your earliest convenience.



- Avoid any contact with the liquid crystal inside the picture display, should the monitor be damaged. Follow the appropriate emergency measures below.
- SKIN: If any of the liquid crystal gets on your skin, wipe it off and rinse the affected area thoroughly with water, then wash well with soap.
- EYES: If it gets in your eyes, wash your eyes with clean water for at least 15 minutes and seek medical advice immediately.
- INGESTION: If any of the liquid crystal is ingested, rinse the mouth out thoroughly with water. Have the person drink a large amount of water and induce vomiting. Seek medical assistance immediately.



- Follow these precautions to prevent the battery from leaking, overheating, igniting or exploding.
- Do not use a battery other than those specifically recommended for the equipment.
- Do not carry or store together with metal objects such as ballpoint pens, necklaces, coins, hairpins, etc.
- Do not put the battery into a microwave or high pressure container.
- If leakage of battery fluid or a strange odor, color change, etc. is noticed during use or during charging, remove the battery from the camera or battery charger immediately and keep it away from fire.



- Please observe the following in order to prevent fire, electrical shock or cracking of the battery while charging.
- Use only the indicated power supply voltage. Also avoid the use of multi-socket adapters and extension cords.
- Do not damage, coil, or modify the USB cable, place the cable under heavy objects, or tug or forcibly bend the cable.
- Do not connect or disconnect the power plug with wet hands. Always grip the USB power adapter when disconnecting the USB cable.
- Do not cover equipment while charging.



- Keep the battery and SD memory card used in this equipment out of the reach of children to prevent accidental ingestion. Consumption is harmful to human beings. If swallowed, seek medical assistance immediately.



- Keep the equipment out of the reach of children.



- Do not touch the internal components of the equipment if they become exposed as a result of being dropped or damaged. The high-voltage circuitry in the equipment could lead to an electric shock. Remove the battery as soon as possible, being careful to avoid electric shocks or burns. Take the equipment to your nearest dealer or service center if it is damaged.



- When using the camera in kitchens or other areas where it may be exposed to steam or damp air, be sure that moisture does not penetrate the interior of the camera. Failure to observe this precaution could result in fire or electric shock.



- Do not use the equipment near flammable gases, gasoline, benzene, thinner or similar substances to avoid the risk of explosion, fire or burns.
- Do not use the equipment in locations where usage is restricted or prohibited as this may lead to disasters or accidents.



- Wipe off any dust that accumulates on the electrical plug as this may lead to fire.



- When travelling to other countries, do not use the camera with voltage converters or plug adapters. Failure to observe this precaution could result in fire, electric shock, or damage to the product.



- Use only at the listed voltage. Failure to observe this precaution could result in fire or electric shock.



- Do not damage, coil, or modify the USB cable, place the cable under heavy objects, or tug or forcibly bend the cable. Damage to the cable could result in fire or electric shock.



- Do not handle the plug with wet hands. Failure to observe this precaution could result in electric shock.



- When unplugging the device, pull on the plug, not the USB cable. Failure to observe this precaution could damage the USB cable, resulting in fire or electric shock.



- Should water, liquid, metal, or other foreign objects penetrate the casing, unplug the device immediately and take it to your nearest dealer or service center.
- Should device malfunction or emit an unusual noises or smells, unplug it immediately and take it to your nearest dealer or service center. Discontinue use if the device is malfunctioning or damaged.



- Do not disassemble. The device contains high-voltage circuits that could cause electric shock.



- Do not handle the plug during thunderstorms. Failure to observe this precaution could result in electric shock.



- Keep batteries out of reach of children.



- Cease charging if the battery fails to charge in the specified time.



- Do not place in microwave ovens or pressure cookers.



- Should the battery leak or produce an unusual smell, immediately remove it from the presence of flammable objects.

Caution



- Contact with fluid leaking from a battery can lead to burns. If part of your body comes in contact with a damaged battery, rinse the area with water immediately. (Do not use soap.)
If a battery starts to leak, remove it immediately from the equipment and wipe the battery chamber thoroughly before replacing it with a new battery.



- Plug the USB power adapter securely into the electrical outlet. Loose cords pose a fire hazard.



- Do not fire the flash at drivers of vehicles, as this may cause the driver to lose control and result in a traffic accident.



- For your safety, unplug the device during cleaning.
- Unplug the device when it is not in use.





- Do not cover equipment while charging. Failure to observe this precaution could result in fire.
- Do not short the metal parts of the camera terminals or USB cable. Failure to observe this precaution could cause fire.

Safety Precautions for Accessories

When using optional products, carefully read the instructions provided with the product before using that product.

Using the Manuals

The following two manuals are included with your RICOH PX.

	<p>"Camera User Guide" (This booklet)</p> <p>This guide explains the usage and functions of the camera. It also explains how to install the supplied software on your computer.</p>
	<p>"Software User Guide" (PDF file)</p> <p>This guide explains how to download images from the camera to your computer. The "Software User Guide" is available in the [MANUAL] folder in the internal memory of the camera.</p> <p>Each language has its own "Software User Guide".</p> <ul style="list-style-type: none">⊞ RICOHDCI (G:) + DCIM DCSOFT2 MAC MANUAL MEDIABRW <p>To copy the User Guide onto your computer, connect the camera to the computer using the supplied USB cable. See P.89 for more information.</p>

"MediaBrowser" image viewing and editing software (for Windows only) is stored in the camera's internal memory. For information on use, see the MediaBrowser online help or contact one of the following customer support centers:

North America (U.S.)

TEL: (Toll Free) +1-800-458-4029

Europe

UK, Germany, France and Spain: TEL: (Toll Free) +800-1532-4865

Other Countries: TEL: +44-1489-564-764

Asia

TEL: +63-2-438-0090

China

TEL: +86-21-5385-3786

Business hours: 9:00 AM to 5:00 PM

Contents

Safety Precautions	2
Using the Manuals	7
Contents	8

Basic Operations

13

Packing List	14
Optional Accessories	14
Names of Parts	15
Picture Display	17
Getting Ready	20
Loading the Rechargeable Battery and SD Memory Card	20
Charging the Rechargeable Battery	22
Turning the Power On/Off	24
Basic Setup	25
Basic Shooting	26
Focusing and Taking Pictures (Normal Mode)	26
Using the Zoom Function	28
Using the Flash	29
Using the Self-timer	30
Exposure Compensation	30
Playing Back Images	31
Viewing Your Images	31
Thumbnail View	31
Rating Pictures	32
Enlarging Images	33
Deleting Files	34
Deleting Multiple Files	35
Using the Menus	36
The Quick Shooting Menu	36
The Quick Playback Menu	36

1 Matching Settings to the Scene	38
Premium Shot	38
Taking Pictures in Premium Shot Modes.....	40
Favorite Premium Shot Modes.....	43
Creating New Premium Shot Modes	44
2 Shooting and Viewing Movies	45
Shooting Movies	45
Viewing Movies.....	46
3 More on Photography	47
Focus.....	47
Focus Lock	47
Focus Options.....	49
Subject Tracking.....	49
Preventing Blur	50
Blur Reduction.....	50
Using the Flash.....	50
Raising ISO	50
Modifying Color.....	51
White Balance.....	51
Manual.....	52
Image Settings.....	52
Taking a Series of Photos	53
Creating a Date Stamp.....	55
ISO Sensitivity.....	56
Digital Zoom.....	57
Auto Resize.....	57

4	More on Playback	59
	Hiding Images	59
	Selecting Images	59
	Hiding Images	60
	Creating Cropped Copies.....	61
	Trim	61
	Skew Correction.....	64
	Protecting Images from Accidental Deletion	65
	Selecting Multiple Files.....	65
	Selecting Pictures for Printing.....	66
	Re-ordering Favorites.....	67
	Viewing Pictures on TV	69
5	The Shooting Menu	71
	Using the Menu	71
	Shooting Menu Options.....	72
	Picture Quality/Size	72
	Continuous.....	72
	Focus.....	72
	Exposure Metering.....	72
	Image Settings	72
	Super Resolution.....	72
	White Balance	73
	ISO Setting	73
	Maximum for ISO Auto.....	73
	Exposure Compensation.....	73
	Movie Size	73
	Red-eye reduction	73
	Pre-AF.....	73
	Shake Correction.....	73
	Date Imprint.....	73
	Plus Normal Shooting.....	73
	Soft Focus Options.....	73
	Hue	74
	Vignetting.....	74
	Toy Color	74
	Reset premium shot settings.....	74
	Restore Defaults.....	74

6 The Playback Menu 75

Using the Menu	75
Playback Menu Options.....	76
Privacy Settings.....	76
Save My Settings: Premium Shots.....	76
Save premium shot	76
Resize.....	76
Trim.....	76
Skew Correction.....	76
Slide Show.....	77
Protect	77
Copy to Card from Int. Memory.....	77
DPOF.....	77
Reorder favorites	77

7 The Setup Menu 78

Using the Menu	78
Setup Menu Options.....	79
Quick menu display.....	79
Choose shooting info.....	79
Grid Guide Display	80
Playback info.....	80
Auto Rotate	80
Auto-protect faves	80
LCD Brightness.....	80
AF Auxiliary Light.....	80
Operation Sounds.....	81
Volume Settings	81
LCD Confirmation Time.....	81
Auto Power Off.....	81
Sleep Mode	81
LCD Auto Dim	81
Digital Zoom Image.....	82
Card Sequence No.	82
Date Settings.....	82
Language/言語	82
Video Out Mode.....	82
HDMI Output.....	83
Format [Card].....	83
Format [Internal Memory].....	83
Check Firmware Ver.....	83
Eye-Fi Connection Settings	83
Eye-Fi Connection Display.....	83

8 Direct Printing	84
About the Direct Print Function	84
Connecting the Camera to a Printer	84
Printing Still Images	85
Printing One or All Still Images	85
Printing Several Still Images.....	88
9 Downloading Images to Your Computer	89
For Windows	89
System Requirements for Using the Supplied Software.....	89
Installing Software	90
Copying Pictures to Your Computer	94
For Macintosh.....	96
Copying Pictures to Your Computer.....	96
10 Appendices	98
Troubleshooting.....	98
Error Messages	98
Camera Troubleshooting.....	99
Available Settings	104
Specifications	106
Number of Images That Can Be Stored.....	109
Defaults Settings/Functions Whose Defaults Are Restored	
When the Camera Is Turned Off.....	111
Optional Accessories	113
Battery Charger (BJ-10)	113
Using Your Camera Abroad	114
Cautions on Use.....	115
Care and Storage.....	118
Warranty and Servicing	120
Index	122

Basic Operations

If you are using the camera for the first time, read this section.

Packing List	14
Names of Parts	15
Picture Display	17
Getting Ready	20
Basic Shooting	26
Playing Back Images	31
Deleting Files	34
Using the Menus	36

Packing List

Open the package and make sure all the items are included.

* The actual appearance of items included may differ.

• RICOH PX

The serial number of the camera is provided on the bottom face of the camera.

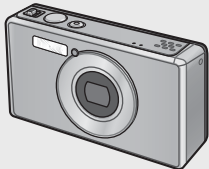

• Rechargeable Battery (DB-100)



- USB Cable
- USB Power Adapter
- Plug
- AV Cable
- Handstrap
- Warranty
- Camera User Guide



Note

Attaching the Plug

Before using the USB power adapter for the first time, connect the plug by sliding it into the USB power adapter until it clicks into place.

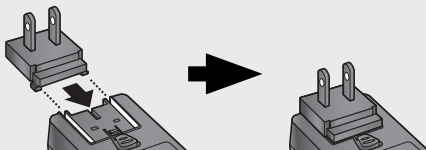

The shape of the plug depends on the country of sale.

Optional Accessories

• Rechargeable Battery (DB-100)

• Battery Charger (BJ-10)

• HDMI Cable (HC-1)

Used to connect your camera to a television compatible with HDMI.

• Protective Jacket (PJ-1)

Protects the camera from scratches.

• Neck Strap (ST-4)

A two-way, single-point attachment neck strap that also comes with a short strap.

If you are using the camera for the first time, read this section.

Names of Parts

Camera

Front View

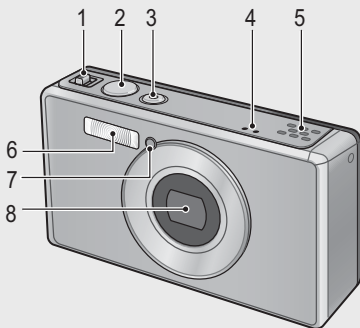

	Item Name	Refer to
1	Zoom Lever (Telephoto)/ (Wide-angle) (Enlarged View)/ (Thumbnail View)	P.28, 31, 33
2	Shutter Release Button	P.27
3	POWER Button/Indicator Lamp	P.24, 23
4	Microphone	P.45
5	Speaker	P.46
6	Flash	P.29
7	AF Auxiliary Light/Self-timer Lamp	P.80, 30
8	Lens	—



Note

Attaching the Handstrap/Neck Strap to the Camera

Thread the small end of the strap through the strap eyelet on the camera and loop the ends. Remove the end of the neck strap from the buckle and attach it as shown in the illustration.

- For the latest information on optional accessories, see the Ricoh website (<http://www.ricohmmc.com/>)

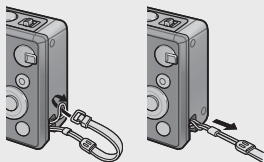

If you are using the camera for the first time, read this section.

Rear View

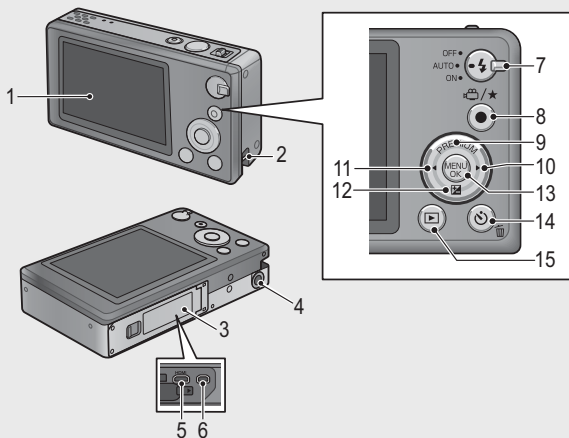

If you are using the camera for the first time, read this section.

	Item Name	Refer to
1	Picture Display	P.17
2	Strap Eyelet	P.14
3	Battery/Card Cover	P.20, 69, 90, 94, 96
4	Tripod Screw Hole	—
5	HDMI Micro Output Terminal (Type D)	P.69
6	Common Terminal for USB Port/AV Output	P.20, 69, 84, 90, 94, 96
7	Flash Dial	P.29
8	(Movie)/ (Favorites) Button	P.45, 32, 43, 44
9	PREMIUM/ Button	P.40
10	Button	—
11	Button	—
12	(Exposure Compensation)/ Button	P.30, 39
13	MENU/OK Button	P.36, 71, 75, 78
14	(Self-timer)/ (Delete) Button	P.30, 34
15	(Playback) Button	P.31

(*) The , , , and symbols in this manual indicate the up (PREMIUM), down (), left, and right buttons, respectively.



Picture Display

Example of Picture Display when Shooting Pictures

Still Image Mode

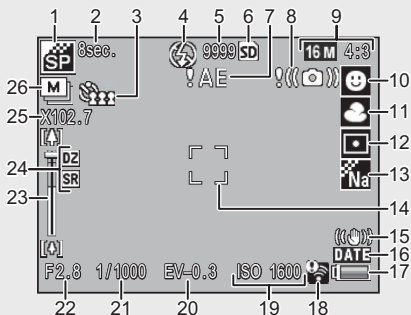

	Item Name	Refer to		Item Name	Refer to
1	Premium Shot Mode	P.38	14	AF Frame	P.48
2	[Fireworks] Exposure Time	P.38	15	Shake Correction	P.50
3	Self-timer	P.30	16	Date Imprint	P.55
4	Flash Mode	P.29	17	Battery Symbol	P.19
5	Remaining Number of Still Images	P.109	18	Eye-Fi Connection	P.19
6	Recording Destination	P.21	19	ISO Setting	P.56
7	Exposure Warning Indicator	P.101	20	Exposure Compensation	P.30
8	Camera Shake Warning Symbol	P.50	21	Shutter Speed	P.106
9	Image Size	P.72	22	Aperture	P.106
10	Focus Mode	P.48	23	Zoom Bar	P.28
11	White Balance	P.51	24	Super Resolution Zoom/ Digital Zoom	P.28, 57
12	Exposure Metering	P.72	25	Zoom Magnification/Auto Resize Zoom	P.28, 57
13	Image Settings	P.52	26	Continuous Mode	P.53

If you are using the camera for the first time, read this section.

Movie Mode

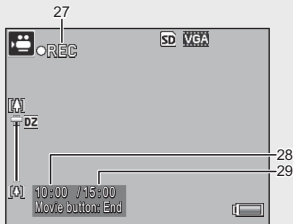

	Item Name	Refer to		Item Name	Refer to
27	Movie Recording Indicator	P.45	29	Remaining Recording Time	P.109
28	Recording Time	P.109			



Note

When the number of remaining shots is 10,000 or more, "9999" is displayed.

Example of Picture Display During Playback

Still Image Mode

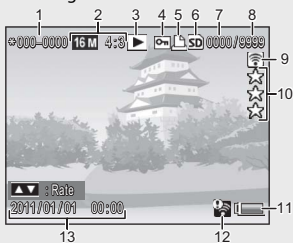

Movie Mode

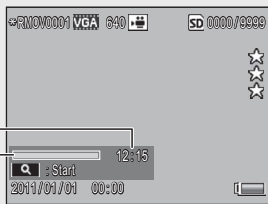

	Item Name	Refer to		Item Name	Refer to
1	File Number	—	9	Eye-Fi Transferred Images	P.19
2	Image Size	P.72	10	Rating	P.32
3	Mode Types	—	11	Battery Symbol	P.19
4	Protect	P.65	12	Eye-Fi Connection	P.19
5	DPOF	P.66	13	Date at Shooting	P.25
6	Playback Data Source	P.21	14	Recording Time or Lapsed Time	—
7	Number of Playback Files	—	15	Indicator	—
8	Total Number of Files	—			



Note

- A battery symbol appears at the lower right of the picture display to indicate the battery level.

Battery Symbol	Description
Green	Battery is sufficiently charged.
	Battery partially discharged. Recharging is recommended.
	Battery level is low. Recharge the battery.

- Transfer status is displayed during shooting and playback when an Eye-Fi card is used (P.22). Pictures that have been uploaded to a computer are indicated by a icon.

Symbol	Status	Symbol	Status
	Not connected		Connection stopped
	Connecting		Eye-Fi card information acquisition error ^(*)
	Waiting for data transfer		
	Transferring		

(*) Turn the camera off and then on again. If the problem persists, there may be a problem with the card.

- Additional photo information can be displayed by selecting [Detailed] for [Select info displayed] in the quick playback menu (P.36).

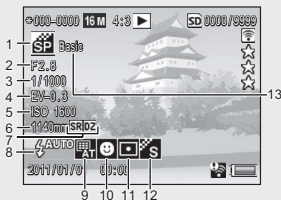

	Item Name	Refer to		Item Name	Refer to
1	Shooting Mode	—	8	Flash Mode	P.29
2	Aperture	P.106	9	White Balance	P.51
3	Shutter Speed	P.106	10	Focus Mode	P.48
4	Exposure Compensation	P.30	11	Exposure Metering	P.72
5	ISO Setting	P.56	12	Image Settings	P.52
6	Focal Length of the Zoom	P.28	13	Soft Focus Options/Hue/Vignetting/Toy Color	P.73, 74
7	Super Resolution Zoom/Digital Zoom	P.28, 57			

Getting Ready

Turn the power on and get ready to shoot.

Loading the Rechargeable Battery and SD Memory Card

Be sure the camera is off before proceeding.

1 Open the battery/card cover.

- Slide the latch in the direction shown and open the cover.



2 Insert the rechargeable battery and SD memory card.

- After checking that they are in the correct orientation, slide the card in until it clicks into place and insert the battery. The battery is fully inserted when the latch pops into place as shown. The camera will not turn on if the battery is not in the correct orientation.

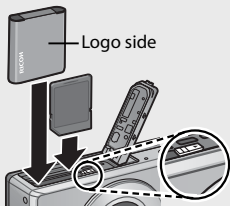

3 Close the cover.

- Close and latch the cover as shown.



Removing the Rechargeable Battery

After unlatching and opening the battery/card cover, release the battery latch to eject the battery. The battery can then be removed by hand. Be careful not to drop the battery when removing it from the camera.

Removing the SD Memory Card

Unlatch and open the battery/card cover. Push in the SD memory card and gently release to eject it. Pull the card out of the camera.

If you are using the camera for the first time, read this section.

**Caution**

- To prevent moisture or dust from entering the camera, close the battery/card cover securely.
- Before opening or closing the battery/card cover, choose a location free of water, sand, mud, and other foreign matter and remove any such matter as may be adhering to the camera.
- Make sure that the rechargeable battery and SD memory card are facing the right way when inserted into the camera. Inserting the rechargeable battery or SD memory card in the wrong direction and forcing close the battery/card cover may damage the camera, rechargeable battery or SD memory card.

About the Battery



The camera uses a rechargeable DB-100 battery (supplied). Do not use any other battery.

**Caution**



- The battery may become very hot immediately after operation. Turn the camera off and leave it to cool down sufficiently before removing the battery.
- Please remove the battery if you are not going to use the camera for a long period of time.
- Batteries should be disposed of under rules appointed by the government or the local authorities.

About SD Memory Cards (available in stores)

The camera can be used with SD, SDHC, and Eye-Fi memory cards (hereafter referred to as “SD memory cards”). SDXC cards can not be used.

 is displayed when a memory card is inserted; if no card is inserted,  will be displayed and pictures will be stored in the camera's internal memory.

**Formatting Memory Cards**

Use the [Format [Card]] option ( P.83) in the camera setup menu ( P.78) to format memory cards before first use or after they have been used in other devices. Note that this permanently deletes any images the card may contain; before formatting, copy the images you wish to keep to a computer or other device. Before formatting Eye-Fi cards, be sure the software supplied on the card has been installed to your computer.



Eye-Fi Cards

Eye-Fi X2 series cards (SD memory cards with built-in wireless LAN function) can be used. For more information on Eye-Fi cards, access the Web page of Eye-Fi (<http://www.eyefi/>).



Caution

- If an SD memory card is loaded, the camera does not record to the internal memory, even if the card is full.
- Take care not to get the contacts of the card dirty.
- This product is not guaranteed to support Eye-Fi card functions (including wireless transfer). In case of an issue with an Eye-Fi card, please check with the card manufacturer. Also, Eye-Fi cards can only be used in the country in which the cards were purchased. If it is unclear whether the card has been approved for use in the area, please check with the card manufacturer.



Write-protecting your images

Move the write-protection switch on the SD memory card to LOCK to prevent your still images from being accidentally erased or the card from being formatted.

Note that you cannot shoot images on a locked card because no data can be recorded to the card. Unlock the card before shooting.

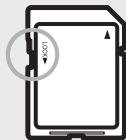

Charging the Rechargeable Battery

Charge the battery before use.

The battery can be charged by connecting it to a USB power adapter connected to an AC power outlet, or by connecting it to a computer. In either case, turn the camera off and connect the supplied USB cable to the camera USB/AV OUT terminal.

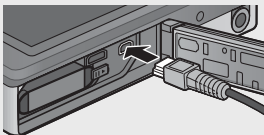

Using an AC Power Outlet

To charge the battery, connect the USB cable and plug the power adapter in. Charging will begin automatically.

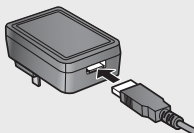

Using a Computer

The camera will display the dialog shown at right when connected to a computer. Highlight [Charge] and press the MENU/OK button. Charging will not begin if another option is selected.

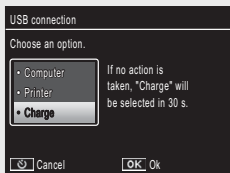

Note

The camera indicator lamp shows charging status as follows:

Indicator lamp	Description
Blinks about once a second	USB charging in progress
Off	Charging complete
Blinks rapidly (about twice a second) for 5 s and then turns off	Charging error or no battery inserted

Charging takes about 160 minutes when the camera is connected to a power outlet and about 240 minutes when it is connected to a computer (these figures assume a temperature of 25 °C; charging times may vary with the temperature, the current charge state, and the operations performed with the camera and/or computer).

Note the following when using a computer:

- Charging starts automatically if no operations are performed for over 30 s after the camera is connected.
- The battery will not charge if the computer is off or in sleep (standby) mode.
- If the battery has been left unused in the camera for an extended period before charging, there may be a delay before USB options are displayed or charging begins. Use the USB power adapter to charge the battery.

⚠ Caution

- Use only the supplied USB power adapter and USB cable.
- During charging, do not leave the camera in direct sunlight or subject it to extreme temperatures, strong shocks, or vibration.
- Disconnect the camera when charging is complete. Failure to observe this precaution could cause fire.
- Do not touch the contacts of rechargeable batteries with metal objects, as this could short the battery.
- Charge the battery at temperatures between 10 °C and 40 °C, but note that charging times may increase at temperatures between 10 °C and 15 °C. At temperatures below 10 °C, charging times may increase or the battery may not charge.
- When using a computer, connect the USB cable directly to the computer. Data can not be written to the camera memory card during charging. Accessing the camera during charging may increase the time needed for the battery to charge. Pressing the POWER button ends charging and turns the camera off.

Turning the Power On/Off

Press the POWER button to turn the camera on in shooting mode. A start-up sound will play and the picture display will turn on. To turn the camera off, press the POWER button again.

The number of pictures taken that day will be displayed before the camera turns off.





🔍 Note

A zero is displayed if the clock is not set.

Using the Camera in Playback Mode

Pressing and holding the  (Playback) button turns on the camera in playback mode, allowing you to start playback at once.

When the camera has been turned on with the  button, pressing the  button again turns the camera off.

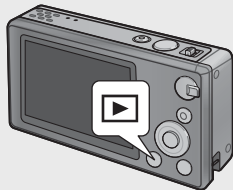



Sleep Mode and Auto Power Off

If no operations are performed for the time selected for the setup menu (P.78) [Sleep Mode] (P.81) or [Auto Power Off] (P.81) options, the picture display will dim or the camera will turn off automatically to save power.

Basic Setup

Setting the Language

A language-selection dialog is displayed the first time the camera is turned on. Highlight the desired language and press the MENU/OK button (to proceed without selecting a language, press).

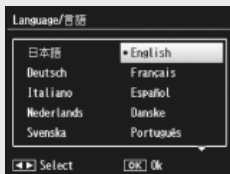

Setting the Date and Time

The dialog shown at right will be displayed; press or to highlight the year, month, hour, minute, second, or date format and press or to change.

Press the MENU/OK button when settings are complete. A confirmation dialog will be displayed; press the MENU/OK button again to set the camera clock.

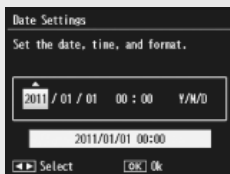

Note

- To stamp pictures with the time and/or date of recording, select [Date] or [Date/Time] for [Date Imprint] (P.73) in the shooting menu (P.71).
- To retain the date and time settings, load a battery with adequate remaining power for more than two hours.
- If the battery is removed for more than one week, the date and time settings will be lost. These settings must be made again.
- The language, date, and time can be changed at any time using the [Language/言語] (P.82) and [Date Settings] (P.82) items in the setup menu (P.78).

If you are using the camera for the first time, read this section.

Basic Shooting

Now you are ready.

Focusing and Taking Pictures (Normal Mode)

Normal mode is selected when the camera is turned on. In this mode, settings are automatically adjusted according to shooting conditions.

The shutter release button has two positions: the camera adjusts focus automatically when the button is pressed halfway and takes a picture when the button is pressed the rest of the way down (to take pictures without using autofocus, adjust focus settings as described on P.48).

- 1 Hold the camera with both hands and lightly press both elbows against your body.**



- Be sure your fingers or hair or the camera strap do not obstruct the lens, flash, or AF-auxiliary light.



If you are using the camera for the first time, read this section.

2 Position your subject in the center of the frame and press the shutter release button halfway to set focus, exposure, and white balance.

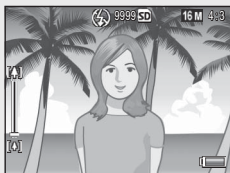

- If portrait subjects are detected, the camera will give priority to faces when setting focus.
- The focal distance is measured at a maximum of nine points. Green frames appear to indicate the positions that are in focus.

3 Gently press the shutter release button all the way.

- The still image you have taken appears momentarily on the picture display and is recorded to the internal memory or the SD memory card.



Note-----

If the camera is turned off in premium mode (👉 P. 38), the last selected premium shot mode will be restored the next time the camera is turned on. To return to normal shooting, press ◀▶ in the premium shot shooting display.



Shooting Close-Ups (Macro Shooting)-----

In normal mode, the camera automatically adjusts focus for subjects close to the lens. Shorter focus distances can be achieved by selecting [Loupe] (👉 P.38) in premium mode.

If you are using the camera for the first time, read this section.

Using the Zoom Function

To zoom in on your subject so that it fills more of the frame, select [T] (telephoto) with the zoom lever, or select [W] (wide angle) to zoom out for wider angles. The amount of zoom is shown by the zoom bar and zoom ratio in the picture display.

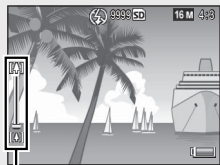
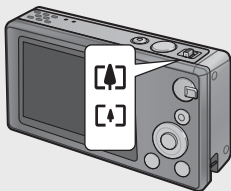

Zoom bar

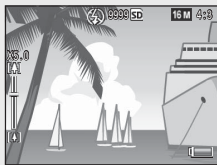
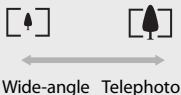

The white part of the zoom bar indicates the optical zoom (up to 5.0 \times); the green part of the zoom bar indicates the super resolution zoom (up to 2.0 \times). When using the super resolution zoom, the [SR] symbol appears on the picture display and the zoom ratio is displayed in green. The super resolution zoom allows you to enlarge the subject with less image deterioration.

Super resolution zoom

Optical zoom

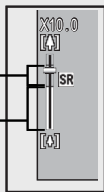

Note

The super resolution zoom is enabled when the [Normal] option is selected for [Digital Zoom Image] (P.82) in the setup menu (P.78).



Using the Digital Zoom

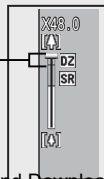

Depending on the shooting mode and the options selected in the shooting menu, you may be able to zoom in further on your subject when the zoom bar display reaches the border of the portion shown in yellow. After releasing the zoom lever, select [T] to zoom in on your subject using digital zoom (P.57).

Digital Zoom



Using the Flash

Use the flash dial to select a flash mode. The current flash mode is shown at the top of the display.

OFF		The flash will not fire.
AUTO		The flash fires automatically.
ON		The flash fires with every shot. (*)

(*) Note that the flash may not fire depending on the shooting mode or the options selected in the shooting menu (👉 P.104).

⚠ Caution

- The flash mode icon will blink for about five seconds while the flash charges; no photographs can be taken until charging is complete and the icon stops blinking.
- The camera may take longer to turn on when the flash is used.

📌 Note

- The auxiliary flash fires to increase the AE accuracy.
- To reduce "red-eye" caused by the flash, select [On] for [Red-eye reduction] (👉 P.73) in the shooting menu (👉 P.71).

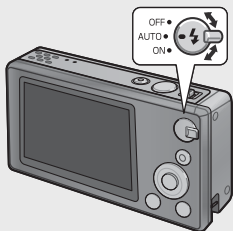

If you are using the camera for the first time, read this section.

Using the Self-timer

The camera offers a ten-second timer for self-portraits, a two-second timer to prevent blur caused by camera movement when the shutter release button is pressed, and a group timer for group portraits.

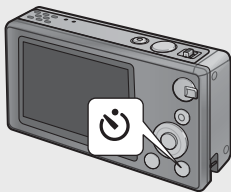



Before shooting, use the  (Self-timer) button to select a self-timer mode. The current setting is shown in the picture display.

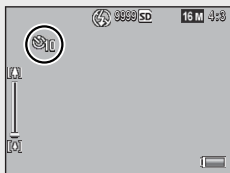



If the group timer is selected, the camera will take two shots five seconds apart; the self-timer lamp will blink for two seconds immediately before each shot. Focus is fixed at the position selected for the first shot.



Note



- The camera remains in self-timer mode even after the image is shot. To cancel the self-timer, press the  button and change the self-timer setting to [Self-Timer Off].
- When the ten-second timer is active, the self-timer lamp will light for eight seconds while the timer counts down and blink for the final two seconds before the picture is taken.
- When the self-timer is set to [2 seconds], the self-timer lamp does not light or blink.
- The options available depend on the shooting mode ( P.104).

Exposure Compensation

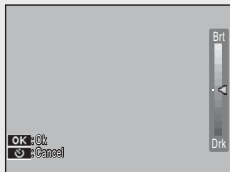
The  (Exposure Compensation) button can be used to adjust exposure if your subject is too dark or too bright. With the camera ready to shoot, press  and use the  and  buttons to increase or decrease exposure. Press the MENU/OK button when settings are complete.







Note

In some modes, the  button is used to adjust settings other than exposure ( P.39).

Playing Back Images

Viewing Your Images

To view an image in the picture display, press the  (Playback) button (to turn the camera on with a picture displayed, press and hold the  button).

Use the  and  buttons to view additional images or press the  button again to exit to shooting mode.

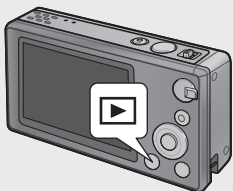

Thumbnail View

Use the zoom lever to choose from single-frame, 20-frame, 81-frame, and calendar views.

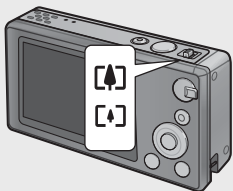

Single-frame view

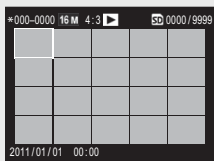

20 frames

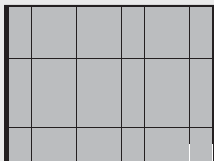

81 frames



Calendar view

If you are using the camera for the first time, read this section.

Multi-Frame Views

Use the ▲, ▼, ◀, and ▶ buttons to highlight images and press the MENU/OK button to view the highlighted image full frame.

Calendar View

Use the ▲, ▼, ◀, and ▶ buttons to highlight the desired date (only dates for which images exist can be selected) and press the MENU/OK button to view the first picture taken on the selected date full frame.



To view pictures taken in other months, highlight the current month and press ◀ or ▶.



Note

Holding the ★ (Favorites) button in the single-, 20-, and 81-frame views displays a calendar. If the camera is turned off when the calendar is displayed, the calendar will be displayed the next time playback mode is selected after the camera is turned on.

Rating Pictures

Press ▲ or ▼ to give the picture currently displayed in single-frame view a rating of from one to three stars. Ratings can be set for up to 9,999 pictures.



Viewing Favorites

To view pictures with a selected rating, press the ★ button during playback and choose the desired rating. Select [All ratings] to view all pictures with a rating of at least one star, or press ★ again to return to normal playback.





Note

- Favorites can be displayed in single- or 20-frame view.
- Ratings can be changed while favorites are displayed. The new rating will be reflected the next time favorites are displayed.
- Pictures can be re-ordered in the favorites display ( P.67).

Enlarging Images









To zoom in on photographs displayed in single-frame view, select  with the zoom lever. Maximum magnification varies with image size.

Image Size	Enlarged View (maximum magnification)
 4:3	3.4×
 4:3	6.7×
Image sizes other than those above	16×

Use the , , , and  buttons to view other areas of the image or select  with the zoom lever to view the image full frame.



Note

- Movies cannot be enlarged.
- Cropped copies ( P.61) can not be zoomed in to the magnifications stated above.

If you are using the camera for the first time, read this section.

Deleting Files

Use the  (Delete) button to delete files from internal memory or a memory card during playback.

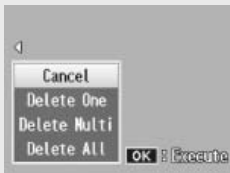
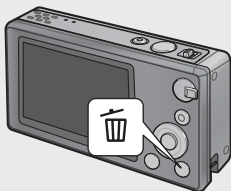

Single-frame view



Thumbnail view

Single-frame View

Available Settings	Description
Delete One	Delete the current image.
Delete Multi	Display images in 20-frame view and choose from [Sel. Individ.] and [Sel. Range] (see below).
Delete All	A confirmation dialog will be displayed; highlight [Yes] and press the MENU/OK button to delete all images in internal memory or on the memory card.

Thumbnail View



Available Settings	Description
Sel. Individ.	Delete selected images.
Sel. Range	Delete all images in selected ranges.

If you are using the camera for the first time, read this section.



Deleting Multiple Files

The following options are displayed when the  button is pressed in thumbnail view or [Delete Multi] is selected in single-frame view.

Sel. Individ.: Deleting Multiple Selected Files

- 1 Highlight images and press the MENU/OK button to select.**
 - Selected pictures are marked with  icons. To deselect a photo, highlight it and press the MENU/OK button again.
- 2 Press .**
 - A confirmation dialog will be displayed.
- 3 Highlight [Yes] and press the MENU/OK button.**

Sel. Range: Deleting All Files in Selected Ranges

- 1 Highlight the first picture in the range and press the MENU/OK button.**
 - An icon will appear on the picture; to deselect, highlight and press the  button.
- 2 Highlight the last picture in the range and press the MENU/OK button to mark all pictures in the selected range with  icons.**
 - Repeat Steps 1 and 2 until all the desired files have been selected.
- 3 Press .**
 - A confirmation dialog will be displayed.
- 4 Highlight [Yes] and press the MENU/OK button.**

If you are using the camera for the first time, read this section.

Using the Menus

Menus can be displayed by pressing the MENU/OK button during shooting or playback.

The Quick Shooting Menu

By default, pressing the MENU/OK button during shooting displays the quick shooting menu; to jump directly to the full shooting menu when the MENU/OK button is pressed, select [Off] for [Quick menu display] (P.79) in the setup menu (P.78).



Available Settings	Description
Volume Settings	Adjust the volume of the sounds produced by camera controls.
Picture quality/size	Adjust image size (P.72).
Adv. shooting options	View the full shooting menu (P.71), including the setup menu tab.

The Quick Playback Menu

By default, pressing the MENU/OK button during playback displays the quick playback menu; to jump directly to the full playback menu when the MENU/OK button is pressed, select [Off] for [Quick menu display] (P.79) in the setup menu (P.78).



Available Settings	Description
Select info displayed	Choose the photo information displayed during playback from [Simplified] (basic photo info P.18), [Detailed] (detailed photo info P.19), and [Off] (no photo info).
Privacy Settings	If [On] is selected, hidden images (P.59) will not be visible during playback.
Adv. PB options	View the full playback menu (P.75), including the setup menu tab.

If you are using the camera for the first time, read this section.

Advanced Operations

Read this section when you want to learn more about the different camera functions.

1	Matching Settings to the Scene	38
2	Shooting and Viewing Movies	45
3	More on Photography	47
4	More on Playback	59
5	The Shooting Menu	71
6	The Playback Menu	75
7	The Setup Menu	78
8	Direct Printing	84
9	Downloading Images to Your Computer	89
10	Appendices.....	98

1

2

3

4

5

6

7

8

9















10

















1 Matching Settings to the Scene

Premium Shot

Choose a premium shot mode to match settings to the scene.

Premium Shot Modes

 Cooking	Adjust brightness and hue to make food look delicious.
 Sweets	Take pictures with the edges artfully blurred, creating a rectangular or oval vignette in a white frame.
 Auction	Combine multiple photos to form a single image using the layout of your choice (👉 P.41).
 Party	Capture indoor background lighting; the flash can still be used to illuminate your main subject.
 Hand-Held Night Scn	Use for hand-held shots of night scenes.
 P mode	Choose for access to nearly all the options in the shooting menu (👉 P.71) when you want to adjust settings manually (👉 P.104).
 Portrait	Use for portraits. The camera automatically detects faces (up to eight) and adjust focus, brightness, and color.
 Night Portrait	Use when taking portrait pictures against a nightscape. The shutter speed slows down, so be careful of camera shake.
 Loupe	Optimize zoom for tighter-than-normal close-ups. Optical zoom cannot be used.
 Landscape	Use when taking scenery pictures with abundant greenery or blue sky.
 Beach	Take bright portraits on sunlit beaches or other brightly-lit expanses of sand.
 Snow	Reproduce natural lighting in shots of snowfields, with portrait subjects correctly exposed.
 Sports	Use when taking pictures of moving objects.
 Fireworks	Photograph fireworks. Press ▼ to choose from exposure times of two, four, and eight seconds. Before shooting, mount the camera on a tripod or rest it on a steady, level surface.

	Skew Correct Mode	Reduce the effects of perspective on posters, business cards, and other rectangular objects ( P.42).
	Pets	Photograph pets. The flash ( P.29), AF-auxiliary light ( P.80), and speaker ( P.81) turn off automatically and remain off while this mode is selected.
	Miniaturize	Use to create pictures that appear to be photos of dioramas ( P.43).
	Toy Camera	Take pictures that imitate the sharp contrast and saturated colors produced by toy cameras.
	High Contrast B&W	Use for grainy, high-contrast black-and-white shots.
	Soft Focus	Choose for soft focus effects similar to those created by soft focus lenses.
	Cross Process	Take photographs with colors that differ markedly from those of the actual subject. The colors can be selected using the [Hue] option ( P.74) in the shooting menu.
	Black & White	Take photos in black and white.
	Sepia	Take photos in sepia.
	MY1 – MY5	Save changes made using the ▼ button to create a custom mode ( P.44).



Note-----

The following settings can be adjusted by pressing ▼:

Mode	Settings
Cooking/Sweets/Auction	Brightness, hue
Fireworks	Exposure time
Miniaturize	Miniaturization options
Other modes	Brightness

Taking Pictures in Premium Shot Modes

1 Display premium shot modes.

- Press the PREMIUM button in shooting mode to display the premium shot mode selection dialog; depending on which style of list you last selected, the dialog will show either your favorite premium shot modes or a complete list.
- Press ▲ or ▼ to toggle between the two displays (if desired, you can change the order in which the options are listed in the “favorites” display (P.43)).

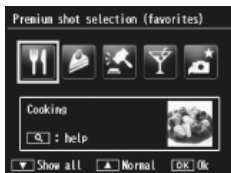
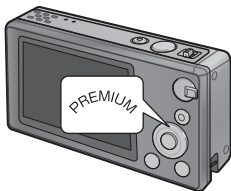

2 Highlight a premium shot mode.

- Press ◀ or ▶ to highlight a premium shot mode.

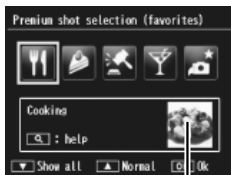

Sample image



Note

The sample image can be selected using the [Save premium shot] option (P.76) in the playback menu (P.75).

3 Select the highlighted mode.

- Press the MENU/OK button. In sweets or auction mode, you will be prompted to select a frame or layout; highlight the desired option and press the MENU/OK button.

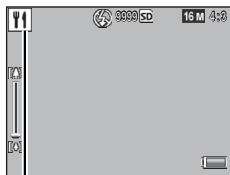

Mode icon

4 Adjust settings.

- Press ▼ to adjust settings for the current mode (P.39). If desired, the new settings can be saved as a custom mode (P.44).

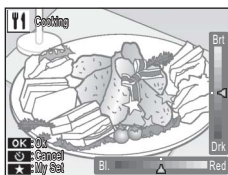

5 Take pictures.

Exiting to Normal Mode

To return to normal shooting mode, press ◀ or ▶ in the premium shot shooting display.

Auction Mode

Take one or more shots to create a picture using the selected layout. Each time the shutter is released, the camera will display a confirmation dialog; press the MENU/OK button to add the picture to the next frame in the layout.

When all the frames are full, press the MENU/OK button to complete the picture.

Note

Image size is fixed at [TM 4 : 3], file size at 500 KB or less.

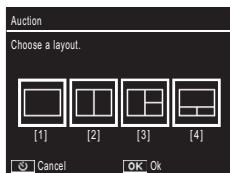

Skew Correct Mode

Reduce the effects of perspective on posters, business cards, and other rectangular objects.



1 Take a photograph.

- If the camera is able to detect an object that can be used to correct perspective, a message will be displayed with the object shown by an orange frame.
- The camera can detect up to five objects; to select a different object, press **▶**, or press **⊙** to record the photograph without correcting perspective.
- If the target area cannot be detected, an error message appears. The original image remains unchanged.

2 Save the modified copy.

- Press the MENU/OK button to save both the original image and a copy that has been processed to reduce the effects of perspective.



Note

You can also correct the skew of a previously shot still image (👉 P.64).



Caution

When [Skew Correct Mode] is selected, note the following:

- To shoot the subject as large as possible, position it so that the entire portion of the subject is visible on the picture display.
- The camera may fail to recognize the subject in the following cases:
 - When the image is out of focus
 - When four edges of the subject are not clearly visible
 - When it is hard to distinguish between the subject and background
 - When the background is complicated
- Two images, one before correction and the other after correction, are recorded. If the number of remaining shots is less than two, you cannot shoot the subject.
- The correction area may not be detected properly if the [Date Imprint] function (👉 P.55) is activated.

Shooting in Miniaturization Mode

This mode creates pictures that appear to be photos of dioramas. It is most effective when pictures are taken from a high vantage point.

Pressing ▼ in miniaturize mode displays miniaturization options. The areas that will not be in focus in the final photograph are shown in gray; press ▲ or ▼ to position the area that will be in focus and press ◀ or ▶ to adjust its width. Press the MENU/OK button to complete the operation and return to shooting mode.



Note

When the camera is held vertically, the area that will be in focus is shown in horizontal orientation.

Caution

The focus of the final image differs slightly from that in the image displayed immediately after shooting.

Favorite Premium Shot Modes

To add a premium shot mode to your list of favorites, highlight the mode in the complete list and press ★. You will be prompted to choose a mode to remove from your favorites; highlight a mode and press the MENU/OK button to replace it with the mode selected in the complete list.

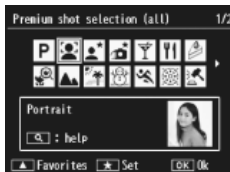

Creating New Premium Shot Modes

Modifications to premium shot modes can be saved in slots [MY1] through [MY5]. This operation can be performed during both shooting and playback.

Shooting Mode

Press **★** in the settings adjustment dialog for the current mode. You will be prompted to take a sample photo for the new mode; the current settings and sample image will be saved when you take the photo.

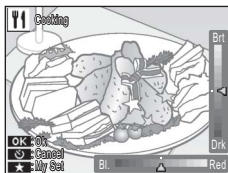

Playback Mode

Display a photo taken in premium shot mode in full-frame playback and select [Save My Settings: Premium Shots] (P.76) in the playback menu (P.75) to create a new premium mode using the adjustments in effect when the photo was taken.

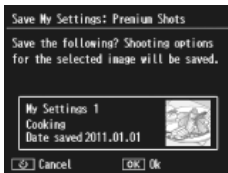

Note

- The sample image taken when settings are saved in shooting mode can not be viewed during playback.
- New modes are saved in order to slots [MY1] through [MY5]; if all the slots are full, you will be prompted to overwrite the settings in an existing slot. Highlight the desired slot and press the MENU/OK button.
- To choose a new sample image without modifying settings, use the [Save premium shot] option (P.76) in the playback menu (P.75).

1

Matching Settings to the Scene

2 Shooting and Viewing Movies

Shooting Movies

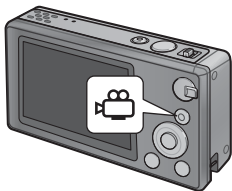

AVI format movies can be recorded with sound by pressing the  (Movie) button in normal or premium shot modes.

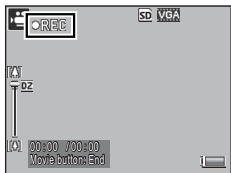

The camera will set focus and exposure and begin recording; a **[●REC]** icon blinks in the display while recording is in progress. Press  again to end recording.



Caution

- While shooting movies, operation sounds may be recorded.
- Movies may be up to 4GB in size or 29 minutes in length. Depending on the type of memory card used, shooting may end before this length is reached. The maximum total length of all movie files that can be stored depends on the capacity of the memory card ( P.109).
- Flicker may be visible in movies recorded under fluorescent lights.
- The maximum digital zoom ( P.57) available during movie recording is 2.8× for movies with a frame size of **[HD 1280]** and 4.0× for movies with a frame size of **[VGA 640]**.



Note

- The zoom lever can be used for digital zoom (P.57) during recording.
- Subject tracking AF can not be used.
- The camera shoots movies at 30 frames per second.
- The remaining recording time may not change uniformly because it is recalculated from the remaining memory capacity during movie recording.
- Depending on its level at the start of recording, the battery may become exhausted before recording is complete. It is recommended that you charge the battery before recording long sequences.
- A Speed Class 6 memory card is recommended when recording movies with [HD 1280] selected for [Movie Size].

Viewing Movies

Movies displayed in full-frame playback can be viewed by selecting **Q** with the zoom lever. Progress is shown by an indicator in the display.

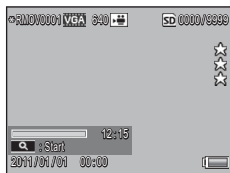

Fast Forward	Select [▶] with the zoom lever while playback is in progress.
Rewind	Select [◀] with the zoom lever while playback is in progress.
Pause/Playback	Press the ★ button.
Slow Playback	Keep the zoom lever at [▶] while playback is paused.
Slow Rewind	Keep the zoom lever at [◀] while playback is paused.
Next Frame	Select [▶] with the zoom lever while playback is paused.
Previous Frame	Select [◀] with the zoom lever while playback is paused.
Volume Adjustment	Press ▲ or ▼ while playback is in progress.

3 More on Photography

Focus

Autofocus may not produce the desired results with some subjects. In these cases, focus lock can be used to recompose the photograph after focusing on another subject at the same distance.

Focus Lock

Use focus lock if the camera is unable to focus or to compose photographs in which the subject is not in the center of the frame.

- 1 Position your subject in the center of the frame and press the shutter release button halfway to set focus, exposure, and white balance.**

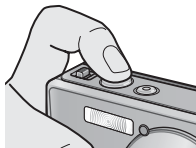

- The focal distance is measured at a maximum of nine points. Green frames appear to indicate the positions that are in focus.

- 2 Keeping the shutter release button pressed halfway to lock focus, recompose the photograph.**

Subject to be focused

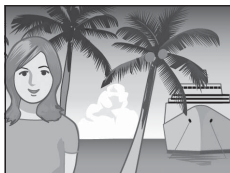

- 3 Gently press the shutter release button all the way.**



Caution

If the distance between the camera and subject changes while focus lock is in effect, lift your finger from the shutter release button and focus again at the new distance.



About Focusing

- The color and shape of the frame in the center of the picture display indicate whether the subject is in or out of focus.

Focus status	Frame color	Frame shape
Camera has not yet focused (Except Normal Mode, [Auction], [Portrait], [Pets]).	White	
Subject in focus.	Green	
Subject not in focus.	Red	(Flashing)

- It may be impossible to bring the following subjects into focus, or they may not be in focus even when the frame color is green.
 - Objects that lack contrast, such as the sky, a wall that is only one color, or the hood of a car.
 - Flat two-dimensional objects with only horizontal lines and no significant protrusions.
 - Quickly moving objects.
 - Things in poorly lit places.
 - Areas with strong backlighting, or reflections.
 - Things that flicker, such as fluorescent lights.
 - Point light sources, such as light bulbs, spotlights, or LEDs.

When you want to shoot subjects like this, first focus on an object the same distance as your subject and then shoot.

Focus Options

The [Focus] option in the shooting menu (📷 P.71) can be used to choose the focus mode according to your subject or creative intent.

⚠ **Caution**-----

The [Focus] menu or some of the options it contains may not be available in some modes (📷 P.104).

— Multi AF

Measures the distances from nine AF areas and focuses to the nearest AF area. Choose to prevent out-of-focus photos.



Face Pr.

The camera automatically detects and focuses on faces. Choose for portraits. If no faces are detected, the camera focuses using multi AF.



Track Subj.

The camera focuses when the shutter release button is pressed halfway and tracks the selected subject until a picture is taken or you remove your finger from the shutter release button. Choose for subjects that are in motion.

— Spot AF

Selects one AF area at the center of the picture display to allow the camera to focus on this area automatically.

Subject Tracking

In this mode, the camera focuses on the subject in the center of the picture display when the shutter release button is pressed halfway. The selected subject is shown by a green focus target.

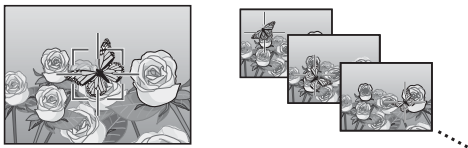

Focus will track the subject as it moves through the display, ending when you take a picture or lift your finger from the shutter release button.

⚠ **Caution**-----

- The camera may be unable to track subjects that are fast moving or poorly lit.
- The focus target will blink red if the camera is unable to locate the subject.
- If the subject leaves the frame, the target will blink red and focus tracking will end.

Preventing Blur

To prevent blur caused by the camera moving when the shutter is released (“camera shake”), press the shutterrelease button smoothly and gently.

Blur is particularly likely to occur if:



- the flash is off and lighting is poor, or
- the camera is zoomed in.

In situations in which photographs are especially prone to blurring caused by camera shake, the camera will display a  icon. The following are recommended to prevent blur.

3

More on Photography

Blur Reduction

Blur can be reduced by selecting [On] for [Shake Correction] in the shooting menu ( P.71). Note that this option may not be available in some modes ( P.104).



Caution

- Blur reduction has no effect on blur caused by subject movement (motion blur).
- Blur reduction is on by default.

Using the Flash

The flash can be activated by choosing a flash mode of [AUTO] or [ON] ( P.29).



Raising ISO









Blur can sometimes be prevented by choosing a higher ISO ( P.56), although note that “noise” (random variations in brightness and color) may appear in photographs taken at higher ISOs.

Modifying Color

Match colors to the light source or modify them to suit your creative intent.

White Balance

Colors can be adjusted using the [White Balance] option in the shooting menu ( P.71). At the default setting of [Multi-P AUTO], the camera automatically adjusts white balance so that a white subject will appear white regardless of the color of the light source. It may however be necessary to match white balance to the light source under mixed lighting or when photographing a subject that is a solid color. Note that [White Balance] may not be available in some modes ( P.104).

	AUTO Auto Adjusts the white balance automatically.
	Multi-P AUTO The camera automatically selects the optimal white balance according to the conditions of sun and shade or the flash illumination range.
	Outdoors Select this when shooting outdoors (sunny) and white balance fails to adjust properly.
	Cloudy Select this when shooting in cloudy weather or shade and the white balance fails to adjust properly.
	Incand. 1 Select this when shooting under incandescent light and white balance fails to adjust properly.
	Incand. 2 Select this when shooting under incandescent light (more reddish, compared with [Incand. 1]).
	Fluorescent Select this when shooting under fluorescent light and white balance fails to adjust properly.
	Manual Adjust the white balance manually.

**Note**

- Auto white balance may not produce the desired results with scenes lacking white objects. This can be corrected using manual white balance or by adding a white object to the scene before shooting.
- When options other than [Auto] or [Multi-P AUTO] are used with the flash, the final results may differ sharply from the view through the lens shown in the picture display.



Manual

- 1 Select [Manual].**
- 2 Frame a piece of paper or other white object under the lighting that will be used in the final photograph and press ★.**
 - The white balance is set.
- 3 Press the MENU/OK button.**
 - The symbol appears on the screen.
 - The effect of the selected white balance setting can be previewed in the picture display. Repeat the above steps until the desired effect is achieved.

**Note**

To cancel [Manual], select a setting other than [Manual].

Image Settings

The [Image Settings] option in the shooting menu ( P.71) can be used to adjust contrast, sharpness, and vividness. Note that [Image Settings] may not be available in some modes ( P.104).

**Vivid**

Take strong, vivid photos with higher contrast and sharpness and maximum vividness.

**Standard**

Creates an image with normal picture quality.

**Natural**

Choose for softer results with less contrast, sharpness, and vividness than seen in photos taken using [Standard].

Taking a Series of Photos

The [Continuous Mode] option in the shooting menu (👉 P.71) can be used to take photos one at a time or in continuous sequence (note that [Continuous Mode] may not be available in some modes 👉 P.104). The following options are available:

Off

One photo is taken each time the shutter release button is pressed.

Continuous

The camera records photographs one after the other while the shutter release button is pressed. When a picture taken in this mode is displayed in full-frame playback (👉 P.31), the other pictures in the sequence can be viewed by pressing ◀ or ▶.

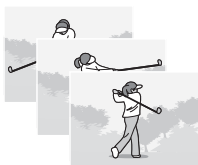

S-Cont (stream continuous)

While the shutter release button is pressed, the camera shoots up to 16 frames at about 7.5 frames per second and joins them to form a single image 4,608 × 3,456 pixels in size. About 2 s are required to shoot the entire sequence.



M-Cont (memory-reversal continuous)

The camera shoots while the shutter release button is pressed, but only the last 16 frames (about the last two seconds of shooting) are recorded, creating a single image 4,608 × 3,456 pixels in size.

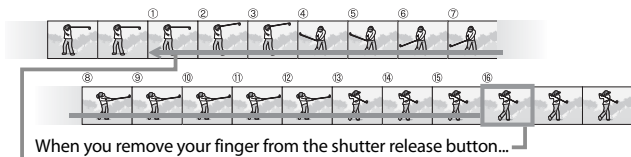

...the camera records the frames taken in the last two seconds (frames ① to ⑯).

**Caution**

- Digital zoom is available at settings of S-Cont and M-Cont even if [Auto Resize] is selected for [Digital Zoom Image] (P.82) in the setup menu (P.78).
- Turning the camera off resets [Continuous Mode] to [Off].

**Note**

- If a sequence shot with [M-Cont] contains less than 16 frames, the entire sequence will be recorded.
- At settings other than [Off], the flash turns off automatically and focus and exposure are fixed with the first shot in each series.
- If a file number of 9999 is reached during continuous shooting and [On] is selected for [Card Sequence No.] (P.82), the remaining photos in the sequence will be saved to a separate folder.

**Viewing S-Cont and M-Cont Images with Enlarged View**

Zoom can be used to view the individual frames of [S-Cont] and [M-Cont] images during playback. Selecting with the zoom lever while an image taken with either of these options is displayed in single-frame playback displays the first frame in the sequence; use the and buttons to view other frames. Press the MENU/OK button to exit.

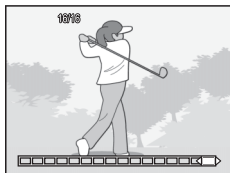
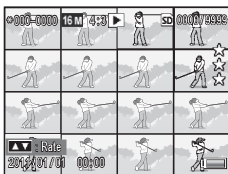

Creating a Date Stamp

Use the [Date Imprint] option in the shooting menu (P.71) to imprint the date (YY/MM/DD) or date and time (YY/MM/DD hh:mm) on photographs as they are taken.



Caution

- [Date Imprint] cannot be used with movies.
- The date imprinted in an image cannot be deleted.

Setting the Camera Clock

Use the [Date Settings] option in the setup menu (P.78) to set the camera clock.

1 Highlight [Date Settings] in the setup menu and press **▶** to display the date settings menu.

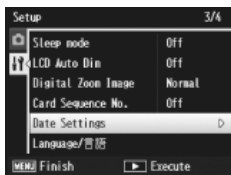

2 Press **◀** or **▶** to highlight the year, month, day, hour, minute, or date format and press **▲** or **▼** to change.

- You can cancel the setting by pressing the **⏪** button.

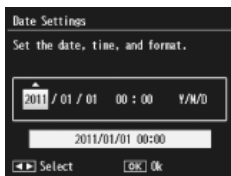

3 Check the information on the screen and then press the **MENU/OK** button.

- The confirmation screen appears.

4 Press the **MENU/OK** button.

- The date and time are set.

ISO Sensitivity

ISO sensitivity is a measure of the camera's sensitivity to light. A greater value means higher sensitivity. High sensitivity is suitable for shooting an object in a dark place or a fast-moving object while minimizing blurring.

ISO sensitivity is controlled using the [ISO Setting] option in the shooting menu (📷 P.71). When ISO setting is set to [Auto], the camera automatically changes the sensitivity according to the distance, brightness, zoom, macro settings, and picture quality/size. Choose settings other than [Auto] to fix ISO sensitivity at the selected value.

The upper limit for auto ISO sensitivity can be selected using the [Maximum for ISO Auto] (📷 P.73) in the shooting menu. Note that this option may not be available in some shooting modes (📷 P.104).

3

More on Photography



Note

- When [Auto] is selected for ISO sensitivity, the camera will select an ISO sensitivity between 100 and the value selected for [Maximum for ISO Auto].
- Images shot with a higher sensitivity may appear grainy.
- When [Auto] is selected for ISO sensitivity, the ISO value displayed when the shutter release button is pressed halfway may in some instances (for example, when the flash is used) differ from the value selected when the shutter is released.

Digital Zoom

When the camera is zoomed in to the maximum optical zoom position, digital zoom can be used for zoom factors of up to $4.8\times$ for still images, $2.8\times$ for movies with a frame size of [HD 1280], or $4.0\times$ for movies with a frame size of [VGA 640].

Digital zoom can be activated by briefly releasing the zoom lever when the zoom bar display reaches the portion shown in yellow at the top, and then returning the lever to [A]. While digital zoom is in effect, a [DZ] icon is displayed and the zoom factor is shown in yellow.

Depending on the shooting mode or the settings in the shooting menu, the digital zoom cannot be used (☞ P.104).

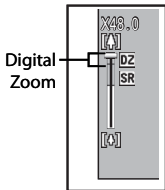

Auto Resize

Digital zoom normally enlarges image data from the center of the frame, creating a slightly grainy image. To record pictures at actual size, select [Auto Resize] for [Digital Zoom Image] in the setup menu (☞ P.78). The size at which the image will be recorded varies with the zoom ratio.

Auto resize can be activated by briefly releasing the zoom lever when the zoom bar display reaches the maximum optical zoom position, and then returning the lever to [A]. Image size will then change each time [Q] is selected. The current size is displayed above the zoom bar.

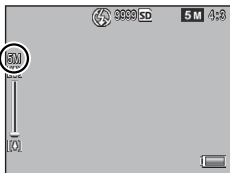

The auto resize zoom is enabled when [16M 4:3] is selected for [Picture Quality/Size] (☞ P.72), and the digital zoom is enabled in other cases.

Zoom Magnification and Recorded Image Size

Picture Quality/Size	Zoom Magnification	Focal Length ^(*)
16M 4:3	1.0×	140 mm
10M 4:3	1.3×	170 mm
5M 4:3	1.8×	240 mm
1M 4:3	3.6×	500 mm
VGA 4:3	7.2×	1000 mm

(*) Equivalent to that on a 35 mm camera



Caution-----

[Auto Resize] has no effect in skew correction or toy camera mode or when [S-Cont] or [M-Cont] is selected for [Continuous Mode].

4 More on Playback

Hiding Images

When [On] is selected for [Privacy Settings] in the quick playback (☞ P.36) or full playback menu (☞ P.75), the images selected for [Hide Images] will not be displayed.

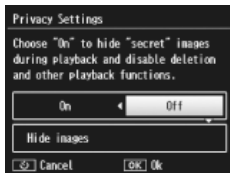

Selecting Images

To choose the images that will be hidden when privacy is enabled, highlight [Hide Images] in the [Privacy Settings] menu and press ►. Images are displayed in a 20-frame view; select [Sel. Individ.] or [Sel. Range].

Sel. Individ.: Selecting Individual Files

- 1 Highlight images and press the MENU/OK button to select.
 - Selected pictures are marked with icons. To deselect a photo, highlight it and press the MENU/OK button again.
- 2 Press ★ to complete the operation.

Sel. Range: Selecting Ranges

- 1 Highlight the first picture in the range and press the MENU/OK button.
 - An icon will appear on the picture; to deselect, highlight and press the ⏪ button.
- 2 Highlight the last picture in the range and press the MENU/OK button to mark all pictures in the selected range with icons.
 - Repeat Steps 1 and 2 until all the desired files have been selected.
- 3 Press ★ to complete the operation.

Hiding Images

To hide the images selected with [Hide Images], choose [On] in the [Privacy Settings] menu.



Note

When [On] is selected for [Privacy Settings], pictures can not be deleted using the  button (P.34), and the [Adv. PB options] option is not available in the quick playback menu.



Viewing Hidden Images

Select [Off] for [Privacy Settings] to reveal hidden images and return to normal playback.

Creating Cropped Copies

Cropped copies can be created using the [Trim] and [Skew Correction] options in the playback menu (☰ P.75).

Trim

Create a cropped copy of the current photograph.

Use the zoom lever to choose a crop size and the ▲, ▼, ◀, and ▶ buttons to position the crop.

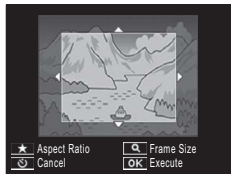

Press the MENU/OK button to save the cropped image to a separate file.

⚠ Caution

- You can only trim still images shot using this camera.
- You cannot trim movies.
- While you can trim an image repeatedly, the image is recompressed each time and there will be some decline in image quality.

📌 Note

- To choose the aspect ratio, press the ★ button in the crop display. Choose from aspect ratios of 4 : 3 and 1 : 1. Aspect ratios of 3 : 2 and 16 : 9 are not supported.
- The available settings for the trimming frame size differ depending on the original image size.

- The size of the image after cropping depends on the size of the original and the size of the crop (the first crop shown in the trimming display is the second largest crop; to display the largest crop, select  with the zoom lever).

Aspect ratio 4 : 3

Original image size	Trimming level	Trimmed image size
16M 4 : 3 (4608 × 3456)	1	4608 × 3456
	2, 3	3648 × 2736
	4 to 6	2592 × 1944
	7 to 10	1280 × 960
	11 to 14	640 × 480
14M 3 : 2 (4608 × 3072)	1 to 3	3648 × 2736
	4 to 6	2592 × 1944
	7 to 10	1280 × 960
	11 to 14	640 × 480
12M 1 : 1 (3456 × 3456)	1 to 3	2592 × 1944
	4 to 7	1280 × 960
	8 to 11	640 × 480
12M 16 : 9 (4608 × 2592)	1 to 3	2592 × 1944
	4 to 7	1280 × 960
	8 to 11	640 × 480
10M 4 : 3 (3648 × 2736)	1	3648 × 2736
	2 to 5	2592 × 1944
	6 to 9	1280 × 960
	10 to 13	640 × 480
5M 4 : 3 (2592 × 1944)	1 to 3	2592 × 1944
	4 to 7	1280 × 960
	8 to 12	640 × 480
4M 4 : 3 (2304 × 1708)	1, 2	2304 × 1728
	3 to 6	1280 × 960
	7 to 11	640 × 480
1M 4 : 3 (1280 × 960)	1 to 3	1280 × 960
	4 to 8	640 × 480
VGA 4 : 3 (640 × 480)	1 to 4	640 × 480

Aspect ratio 1 : 1

Original image size	Trimming level	Trimmed image size
16M 4 : 3 (4608 × 3456)	1 to 4	2736 × 2736
	5, 6	1536 × 1536
	7 to 10	960 × 960
	11 to 14	480 × 480
14M 3 : 2 (4608 × 3072)	1 to 3	2736 × 2736
	4 to 6	1536 × 1536
	7 to 10	960 × 960
	11 to 14	480 × 480
12M 1 : 1 (3456 × 3456)	1 to 4	2736 × 2736
	5, 6	1536 × 1536
	7 to 10	960 × 960
	11 to 14	480 × 480
12M 16 : 9 (4608 × 2592)	1 to 3	1536 × 1536
	4 to 7	960 × 960
	8 to 11	480 × 480
10M 4 : 3 (3648 × 2736)	1 to 3	2304 × 2304
	4 to 6	1536 × 1536
	7 to 9	960 × 960
	10 to 13	480 × 480
5M 4 : 3 (2592 × 1944)	1 to 3	1536 × 1536
	4 to 7	960 × 960
	8 to 11	480 × 480
4M 4 : 3 (2304 × 1728)	1, 2	1536 × 1536
	3 to 6	960 × 960
	7 to 11	480 × 480
1M 4 : 3 (1280 × 960)	1 to 3	960 × 960
	4 to 8	480 × 480
VGA 4 : 3 (640 × 480)	1 to 4	480 × 480

Skew Correction

Create copies that have been processed to reduce the effects of perspective on rectangular objects, such as message boards or business cards.

Caution

- You can only use skew correction for still images shot with this camera.
- You cannot use skew correction for movies.

Note











- If the camera is able to detect an object that can be used to correct perspective, a message will be displayed with the object shown by an orange frame. The camera can detect up to five objects.
- If the target area cannot be detected, an error message appears. The original image remains unchanged.
- To select another correction area, move the orange frame to the target area by pressing the  button.
- To cancel skew correction, press the  button. Even if you cancel skew correction, the original image remains unchanged.
- The image size does not change for skew corrected images.
- The time for skew correction increases with image size. To reduce the time required, perform skew correction on small copies created with the [Resize] option ( P.76).
- The following table shows the approximate time required for skew correction.

Image Size	Correction time	Image Size	Correction time
 4 : 3	Approx. 37 seconds	 4 : 3	Approx. 23 seconds
 3 : 2	Approx. 32 seconds	 4 : 3	Approx. 12 seconds
 1 : 1	Approx. 23 seconds	 4 : 3	Approx. 3 seconds
 16 : 9	Approx. 24 seconds	 4 : 3	Approx. 1 second

- Skew correction can also be performed during shooting ( P.42).

Protecting Images from Accidental Deletion

The [Protect] option in the playback menu (P.75) can be used to protect images from accidental deletion. To protect the current image, select [1 File].

To protect all images or remove protection from all images, choose [Select All] or [Cancel All].



Selecting Multiple Files

To change the protection status of multiple selected images, choose [Sel. Multiple]. Images are displayed in a 20- frame view; select [Sel. Indiv.] or [Sel. Range].

Sel. Indiv.: Selecting Individual Files

- 1 Highlight images and press the MENU/OK button to select.**
 - Selected pictures are marked with icons. To deselect a photo, highlight it and press the MENU/OK button again.
- 2 Press ★ to complete the operation.**

Sel. Range: Selecting Ranges

- 1 Highlight the first picture in the range and press the MENU/OK button.**
 - An icon will appear on the picture; to deselect, highlight and press the  button.
- 2 Highlight the last picture in the range and press the MENU/OK button to mark all pictures in the selected range with icons.**
 - Repeat Steps 1 and 2 until all the desired files have been selected.
- 3 Press ★ to complete the operation.**



Caution

Note that formatting deletes all files, including protected files.

Selecting Pictures for Printing

To request professional prints of the photographs on a memory card, first use the [DPOF] option in the playback menu (P.75) to create a digital “print order” listing the photos you wish to print and the number of prints, and then take the memory card to a digital print service center that supports the DPOF standard.

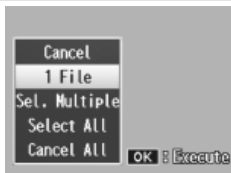

To add the current image to the print order, select [1 File]. Choose [Select All] to add all photos to the print order or [Cancel All] to remove all files from the print order.

Selecting Multiple Files

4

More on Playback

To change the print status of multiple selected images, choose [Sel. Multiple]. Images are displayed in a 20-frame view; highlight pictures and press ▲ or ▼ to choose the number of prints (press ▲ to increase, ▼ to decrease).

Press the MENU/OK button to exit when the operation is complete.



Note

To remove the DPOF settings for multiple still images, follow the same steps described above to set the number of copies to print to [0] for each image, and then press the MENU/OK button.

Re-ordering Favorites

The [Reorder favorites] option in the playback menu (☞ P.75) can be used to change the order in which your favorite pictures are listed. [Reorder favorites] is only available when favorites are displayed (☞ P.32).

1 Press the MENU/OK button.

- Press the MENU/OK button during favorites playback. The quick playback menu will be displayed (if [Off] is selected for [Quick menu display] ☞ P.79 in the setup menu ☞ P.78, the full playback menu will be displayed; proceed to Step 3).

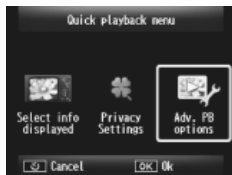

2 Select [Adv. PB options].

- Highlight [Adv. PB options] and press the MENU/OK button to display the full playback menu.

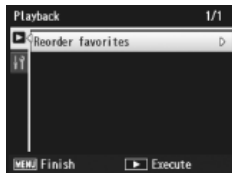

3 Select [Reorder favorites].

- Highlight [Reorder favorites] and press the MENU/OK button to display your favorites in a 20-frame view. Select [1 at a time] or [Multiple].

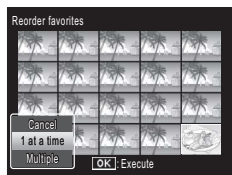

4 Select images.

- If you chose [1 at a time] in Step 3, highlight images and press the MENU/OK button to select or deselect. If you chose [Multiple], use the MENU/OK button to select the first and last images in each range. Selected files are marked with icons.

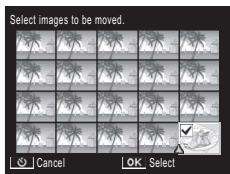

5 Choose a destination.

- Place the cursor at the point to which you wish to move the images.

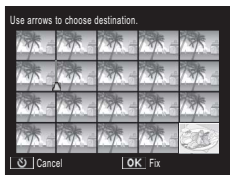

6 Press the MENU/OK button.

- The selected files will be moved to the cursor position. Repeat Steps 4–6 to move additional images, or press  to exit.

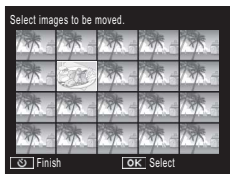

Note

The repositioned files are assigned the same rating as the image immediately after the cursor or, if the cursor is positioned after the last image, the same rating as the last image.

Viewing Pictures on TV

To view pictures on a TV, connect the camera using the supplied AV cable.

1 Securely connect the AV cable to the Video In terminal on the television.

- Connect the white plug of the AV cable to the audio input terminal (white) of the TV unit and the yellow plug to the video input terminal (yellow).

Video Input Terminal (yellow)

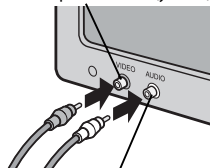

Audio Input Terminal (white)

2 Turn the camera off and securely connect the cable to the common terminal for USB port/AV output of the camera.

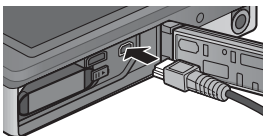

3 Set the television to Video mode (Set the input to Video).

- For details, see the documentation that came with the television.

4 Press the POWER button, or press and hold the (Playback) button to turn the camera on.

Caution

- The USB/AV OUT terminal should be used only with cables specifically designated for this purpose. Connecting a cable to a terminal for which it is not intended could result in product malfunction.
- When the AV cable is connected to the camera, the picture display and the speaker output turn off.
- Do not force the AV cable into the terminal.
- Do not apply excessive force with the AV cable connected.
- When using the AV cable, do not move the camera with the AV cable.



Note

- You can connect the AV cable to the Video In terminal on your video recorder and record what you have shot to a video recorder.
- The camera supports the following video standards: NTSC and PAL. Where possible, the camera is set to the standard used in your country or region before shipment; before connecting the camera to a device that uses a different video standard, choose the appropriate video mode (👉 P.82).



Connecting the Camera to an HDMI Device

The camera can be connected to HDMI devices using an HDMI cable (available separately). See the television manual for details, but note the following:

- The camera HDMI micro connector should be used only with HDMI cables specifically designated for use with this camera. Product malfunction could result if the connector is used with other cables.
- Do not use force when connecting the HDMI cable. Do not tug the cable or move the camera while the cable is connected.
- If the cable is connected or disconnected while multiple images are displayed, pictures will be displayed full frame. Menu display is not affected.
- Sounds made by camera controls are played over the camera speakers, while audio recorded with movies is played by the TV.
- HDMI resolution is set to [AUTO]. Choose another setting for [HDMI Output] if images are displayed in low resolution (👉 P.83).

5 The Shooting Menu

The shooting menu is used to adjust shooting options.

Using the Menu

1 Press the MENU/OK button in shooting mode.

- The quick shooting menu will be displayed (if [Off] is selected for [Quick menu display] P.79 in the setup menu P.78, the full shooting menu will be displayed; proceed to Step 3).



2 Highlight [Adv. shooting options] and press the MENU/OK button to display the full shooting menu.

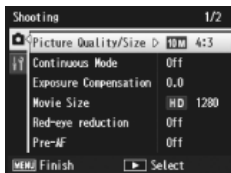

3 Press ▲ or ▼ to highlight the desired item.

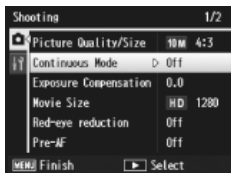

4 Press ► to view options for the highlighted item.

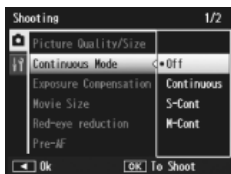

5 Press ▲ or ▼ to highlight the desired option.

6 Press the MENU/OK button to select the highlighted option and exit to shooting mode

- To select the highlighted option and return to the shooting menu, press ◀.

5

The Shooting Menu

Shooting Menu Options

Picture Quality/Size

 P.109

Adjust picture quality and size when taking pictures.

16M 4:3 4608×3456	12M 16:9 4608×2592	1M 4:3 1280×960
14M 3:2 4608×3072	10M 4:3 3648×2736	VGA 4:3 640×480
12M 1:1 3456×3456	5M 4:3 2592×1944	



Note

The sizes available vary with the shooting mode ( P.104).

Continuous Mode

 P.53

Shoot a burst of pictures.

Focus

 P.48

Choose a focusing mode.

Exposure Metering

You can change the metering method (the range to use for metering) used to determine the exposure value.



Multi

The entire shooting range is divided into 256 partitions, and each is metered to determine the overall exposure value.



Center

The entire image is metered, with emphasis on the center, to determine the exposure value.



Spot

Only the center of the image is metered to determine the exposure value.

Image Settings

 P.52

You can change the picture quality of an image, including the contrast, sharpness, color and vividness.

Super Resolution

Select [On] to enhance the resolution of photographs taken with the camera. Note that this increases the time needed to record images.









Note

This option does not apply to movies.



Shooting menu options

The options available in the shooting menu vary with shooting mode (normal or premium shot) and/or premium shot mode selected. See P.104 for details.

White Balance	 P.51
Adjust the white balance.	
ISO Setting	 P.56
Adjust ISO sensitivity.	
Maximum for ISO Auto	 P.56
Select the maximum value chosen by the camera when [Auto] is selected for [ISO Setting]. Use to prevent ISO sensitivity from being raised too high.	
Exposure Compensation	 P.30
Choose exposure compensation.	
Movie Size	 P.45
Choose the movie frame size.	
Red-eye reduction	
Select [On] to reduce "red eye" in portraits taken with the flash.	
Pre-AF	
If [On] is selected, the camera will continue to focus even when the shutter release button is not pressed halfway. This may decrease the time needed to focus when a picture is taken, potentially improving shutter response.	
Shake Correction	 P.50
Select [On] to reduce blur caused by camera shake.	
Date Imprint	 P.55
You can insert the date (YY/MM/DD) or the date and time (YY/MM/DD hh:mm) at the lower right of a still image. Select [Off] to turn date imprint off.	
Plus Normal Shooting	
Select [On] to save unprocessed copies of images taken in [Miniaturize], [Toy Camera], [High Contrast B&W], [Soft Focus], [Cross Process], [Black & White], and [Sepia] premium shot modes. When the images are displayed after shooting, the unprocessed copy is shown on the right, the processed copy on the left.	
Soft Focus Options	
Choose the amount of softening produced by the soft focus premium shot mode. Select from [Weak] and [Strong].	

Hue

Choose the hue of photographs created using the cross process premium shot mode. Select from [Basic], [Magenta], and [Yellow].



Caution

Depending on exposure and the option selected for white balance, [Magenta] and [Yellow] may not produce the desired results.

Vignetting

Choose the amount of vignetting in toy camera premium shot mode. Select from [Weak], [Strong], and [Off].

Toy Color

Select [On] to increase saturation in photographs taken in toy camera premium shot mode.

Reset premium shot settings

Highlight [Yes] and press the MENU/OK button to reset premium shot settings to their default values.

Restore Defaults

Select [Yes] and press the MENU/OK button to restore shooting menu settings to their default values.

6 The Playback Menu

The playback menu is used to manage existing pictures.

Using the Menu

1 Display an image.

- In the case of playback options that can be used with a selected image, display the image full frame before proceeding.
- This step is not required with [Privacy Settings] (P.76), [Slide Show] (P.77), or [Copy to Card from Int. Memory] (P.77).

2 Press the MENU/OK button.

- The quick playback menu will be displayed (if [Off] is selected for [Quick menu display] (P.79) in the setup menu (P.78), the full playback menu will be displayed; proceed to Step 4).



3 Highlight [Adv. PB options] and press the MENU/OK button to display the full playback menu.

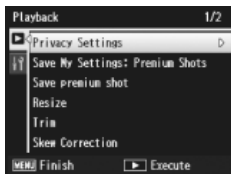

4 Press ▲ or ▼ to highlight the desired item.

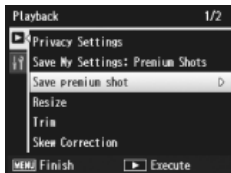

5 Press ► to view options for the highlighted item.

Playback Menu Options

Privacy Settings P.59



If [On] is selected, hidden images will not be displayed.

Save My Settings: Premium Shots P.44

Create a new premium shot mode using the settings for a photo recorded in premium shot mode.



Note



Settings for custom premium shot modes are reset when [Reset premium shot settings] ( P.74) is selected in the shooting menu ( P.71).

Save premium shot

Use the current photo as a sample image for the premium shot mode menu.



Note

Settings for custom premium shot modes are reset when [Reset premium shot settings] ( P.74) is selected in the shooting menu ( P.71).

Resize

Create resized copies of photos or other still images produced with the camera.

Original	Resized
16M 4:3/ 14M 3:2/ 12M 1:1/ 12M 16:9/ 10M 4:3/	1M 4:3/ VGA 4:3
5M 4:3/ 4M 4:3	
1M 4:3	VGA 4:3



Caution

Movies cannot be resized.

Trim P.61

This function allows you to trim a still image you have shot and then save it as a separate file.

Skew Correction P.64

Create copies that have been processed to reduce the effects of perspective on rectangular objects.

Slide Show

You can display the recorded still images and movie files sequentially on the screen.



Note

- Each still image is displayed for three seconds.
- Movies are played back in their entirety.

Protect

P.65

Protect images from accidental deletion.

Copy to Card from Int. Memory

Copy all data from internal memory to a memory card in a single operation.



Note

- If there is not enough space available on the destination memory card, a warning will be displayed. Select [Yes] to copy only those files for which there is sufficient space.
- It is not possible to copy the contents of an SD memory card to the internal memory.

DPOF

P.66

Select pictures for printing.

Reorder favorites

P.67

Change the order in which your favorite images are listed. This option is only available when favorites are displayed (P.32).

7 The Setup Menu

The setup menu can be accessed from the shooting (P.71) and playback (P.75) menus and is used to change basic camera settings.

Using the Menu

- 1 Press the MENU/OK button.**
 - The quick shooting or playback menu will be displayed (if [Off] is selected for [Quick menu display] P.79 in the setup menu, the full menu will be displayed; proceed to Step 3).



- 2 Highlight [Adv.shooting options] or [Adv. PB options] and press the MENU/OK button to display the full menu.**

- 3 Press ◀ to highlight the tab for the current menu.**

- 4 Press ▼ to highlight the setup menu tab.**

- 5 Press ▶ to position the cursor in the setup menu.**

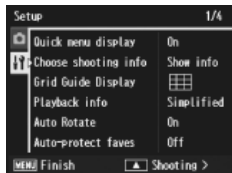

- 6 Press ▲ or ▼ to highlight the desired item.**

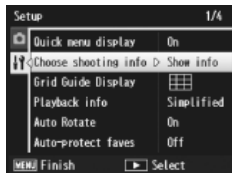

7 Press **▶** to view options for the highlighted item.

8 Press **▲** or **▼** to highlight the desired option.

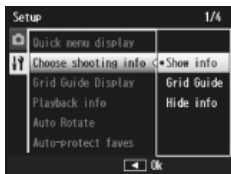

9 Press the MENU/OK button to select the highlighted option and exit to shooting or playback

- To select the highlighted option and return to the setup menu, press **◀**.
- In some cases, pressing the MENU/OK button may return you to the setup menu; press the MENU/OK button again to exit to shooting or playback.



Note

For some functions, the setting selection method may differ from what is explained here. For detailed operation, see the explanation of each function.



Setup Menu Options

Quick menu display

If [Off] is selected, the full shooting or playback menu will be displayed in place of the quick menus.

Choose shooting info

Choose the information displayed during shooting.

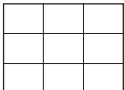
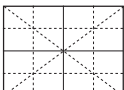
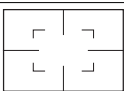

Available Settings	Display	Description
Show info		Display shooting information.
Grid Guide		Display the framing grid selected with [Grid Guide Display] (P.80) in the setup menu.
Hide info		Hide shooting information and the framing grid, making it easier to see the view through the lens.

Choose the type of framing grid available in shooting mode.

Available Settings	Description
	A three-by-three grid for "rule of thirds" composition.
	A four-by-four grid with diagonal lines running from corner to corner makes it easy to find the center of the subject. Use for architectural photography or photographing products for display.
	A two-by-two grid with the center of the frame left clear to make it easier to view the subject. Use if your subject is in motion.

Playback info

Choose the information displayed during playback.

Available Settings	Description
Simplified	Display basic photo info ( P.18).
Detailed	Display detailed photo info ( P.19).
Off	Hide photo info.

Auto Rotate

Select [On] to automatically display pictures in the correct orientation during playback.

Auto-protect faves

Select [On] to protect favorites ( P.32) from accidental deletion.

LCD Brightness

Press ▲ or ▼ to adjust the brightness of the picture display.

AF Auxiliary Light

If [On] is selected, the AF auxiliary light will light to assist autofocus.

Operation Sounds

Choose the sounds made by the camera.

Available Settings	Description
All	All sounds on.
Shutter Sounds	All sounds other than the shutter sound disabled.



Note

- If you try to perform an operation that cannot be performed, the beep sound is emitted regardless of the [Operation Sounds] setting.
- Regardless of the option selected, no sound is emitted in the [Pets] premium shot mode.

Volume Settings

The operation sound volume can be changed.



Note

Regardless of the option selected, no sound is emitted in the [Pets] premium shot mode.

LCD Confirmation Time

Choose how long photos are displayed after shooting (note that photos may be displayed longer than the selected time if noise reduction is required). Choose [Hold] to display photos until the shutter release button is pressed halfway. Photos displayed after shooting can be deleted (👉 P.34).

Auto Power Off

Choose how long the camera remains on when no operations are performed. The camera will not turn off automatically if [Off] is selected, when connected to a computer or printer, or while images are being transferred using Eye-Fi cards.

Sleep Mode

Choose how long the picture display remains lighted before it will automatically dim to save power. This feature is not available during the connection using AV cable or HDMI cable.



Note

With Sleep Mode set, [LCD Auto Dim] option is not available.

LCD Auto Dim

If [On] is selected, the picture display will automatically dim to save power if no operations are performed for about five seconds. This feature is not available in sleep mode.

Digital Zoom Image

 P.57

Choose [Auto Resize] to record pictures taken with digital zoom at actual size, [Normal] to enlarge image data from the center of the frame using both the digital zoom and the super resolution zoom.

Card Sequence No.

When you switch SD memory cards, you can set your camera to continue consecutive numbering from the previously loaded card.

Available Settings	Description
On (Continue numbering)	Files names consist of "R" followed by a seven-digit number (e.g., "R0010001.jpg"), assigned in ascending order from 0010001 to 9999999. When a new memory card is inserted, file numbering continues from the last number used.
Off (Do not continue numbering)	File numbering is assigned, from RIMG0001.jpg to RIMG9999.jpg, for each SD memory card. When the file name reaches RIMG9999, no more data can be recorded to that card.



Note

- This option applies only to memory cards.
- When images are transferred to a computer using DL-10 ( P.94), the file being transferred is renamed and saved.



Caution

When the file name reaches RIMG9999 or R9999999, no more files can be saved. In this case, move image data from the SD memory card to the memory of the computer or a storage medium, and then format the SD memory card.

Date Settings

 P.55

Set the camera clock.

Language/言語 *1

 P.25

You can change the language displayed on the screen.

Video Out Mode *1

You can view your still images and movies on a television screen by connecting your camera to a television with the AV cable that came with your camera. Select from NTSC (used in North America, the Caribbean, parts of Latin America, and some East Asian countries) and PAL (used in the United Kingdom and much of Europe, Australia, New Zealand, and parts of Asia and Africa). SECAM is not supported.

HDMI Output

You can select the resolution from [AUTO], [1080i], [720P], and [480P] for video output using the optional HDMI cable. For normal use, choose the [AUTO] option. If the video resolution actually shown on the display is low with the [AUTO] option, choose [1080i] or [720P] to achieve the better possible quality.

Format [Card]



Select [Yes] and press **★** to format the memory card.



Caution

When using Eye-Fi cards, install the software in the Eye-Fi card to your computer and then format the card.

Format [Internal Memory]

Select [Yes] and press **★** to format internal memory. If you have images in the internal memory that you do not want to delete, copy the images to the SD memory card before formatting the internal memory ( P.77).

Check Firmware Ver.

Display the firmware version of the camera. When the SD memory card contains the file for updating the firmware, the camera rewrites the program.

Eye-Fi settings*2

When using the SD memory card with wireless LAN function built-in (i.e., Eye-Fi card), the [On] option turns wireless LAN function on; the [Off] option turns wireless LAN function off and the SD memory card can be used without wireless LAN function. For more information on wireless LAN settings or Eye-Fi cards, please check the user manual, etc. for the devices using Eye-Fi cards.

Eye-Fi host ID*2

When the Eye-Fi card is in use, display the destination SSID.

*1 The default setting varies depending on where you purchased the camera.

*2 These settings are only displayed when using Eye-Fi card.

8 Direct Printing

About the Direct Print Function

The camera can be connected to a printer via the supplied USB cable and JPEG images printed directly from the camera without using a computer.



Note

- This camera uses PictBridge, an industry standard for Direct Printing.
- Your printer must be compatible with PictBridge to use the Direct Print function. For support information, see the documentation that came with the printer.

Connecting the Camera to a Printer

Connect your camera to a printer using the USB cable provided.

1 Make sure that the camera power is off.

2 Connect the common terminal for USB port/AV output of your camera to a printer using the USB cable provided.

- Turn on the printer if it is not already on.
- Your camera turns on automatically.

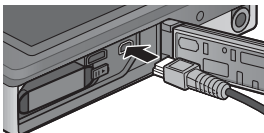

3 Use the camera ▲ and ▼ buttons to highlight [Printer] and press the MENU/OK button.

- Do not select [Computer] or [Charge] when the camera is connected to a printer.



Caution

- Do not force the USB cable into the terminal, or apply excessive force with the USB cable connected. Also, when using the USB cable, do not move the camera with the USB cable.
- Do not disconnect the USB cable with the camera power on.
- Do not connect other cable other than the USB cable provided.

Printing Still Images

You can print still images from the camera with a PictBridge-compatible printer. If a memory card is inserted, the pictures will be printed from the memory card; otherwise pictures will be printed from internal memory.



Caution

After making sure that the printing completes and the camera turns off, disconnect the USB cable to end the connection between the camera and the printer.



Note

If a [Printer error.] message appears during image transfer, check the printer status and take the appropriate action.

Printing One or All Still Images

- 1 Select an image for printing and press the MENU/OK button.
- 2 Select [1 File] or [All Files] and press the MENU/OK button.
 - The Direct Print menu appears.

3 Highlight the desired item and press ► to view additional options.

- When [Connecting...] is displayed, the connection to the printer is not yet established. When a connection is established, [Connecting...] disappears and [Direct Print] appears. Proceed with this step after the connection is established.
- The following items can be selected. Each item is available only when supported by the printer connected to the camera.

Item Name	Description
Paper Size	Sets the paper size.
Paper Type	Sets the paper type.
Layout	Sets the number of images printed on a sheet of paper. The number of images that can be laid out on a sheet of paper varies depending on the connected printer.
Date Print	Selects whether to print the date (shooting date). The date format can be set using the date/time option in the setup menu. If the picture was taken using [Date Imprint] (P.55), only the imprinted date will be printed.
File Name Print	Selects whether to print the file name.
Optimize Image	Selects whether to optimize the image data (still image) prior to printing on the printer.
Print Size	Sets the print image size.
Print Quality	Sets the print quality.
Report Print*	Prints on forms.
Printing Quantity	Sets the print quantity.
Toner Saving*	Selects whether to conserve toner by using less ink during printing.
1-Side/2-Sides*	Selects whether to print on both sides of the paper. During duplex printing, one copy is printed for each still image. Only one copy is printed even if you selected more than one copy to print in Step 3 on P.88.

* Each item is available only when supported by the Ricoh printer connected to the camera.

**Note**

- To specify the settings as the default settings next time the camera is connected to the printer, press the ★ button in Step 3. Select [Yes] and press the MENU/OK button.
- To use the settings last set the next time the camera is connected to the printer, select [No].







4 Select an option and press the MENU/OK button.

- The display returns to the Direct Print menu.
- Repeat Steps 3 and 4 to change other settings as required.

5 Press the MENU/OK button.

- The selected still images are sent to the printer and the [Sending...] screen appears.
- Pressing the ⏪ button cancels the operation.
- When the images have been sent to the printer, the display returns to the Direct Print playback mode screen and printing starts.

Printing Several Still Images

- 1** Select  with the zoom lever to display pictures in multi-frame playback.
- 2** Select an image and press the MENU/OK button.
- 3** Press  or  to choose the number of prints.
 - Press  to increase the number of prints, or press  to decrease the number of prints.
 - Repeat Steps 2 and 3 to select additional images.
- 4** Press the MENU/OK button.
 - The Direct Print menu appears.
- 5** Highlight items and press  to view additional options.
 - See Steps 3 and following on P.86.



Note

- Only images with a printer symbol () are printed. If you cancel printing and then try to print again, make sure that the printer symbol is on the images you want to print.
- The same still image can also be printed several times on a single sheet.
- The available items vary depending on the functions of the printer.
- To print images using the printer's default settings, select [Printer Select] on the detailed options screen.

9 Downloading Images to Your Computer

The screen images shown here may differ from the images displayed on your computer depending on your computer OS.

For Windows

You can copy pictures to your computer with or without DL-10 software, which is available in the internal memory of the camera. The following software are installed with the DL-10 installation.

Software	Description
DL-10	Downloads images collectively to your computer.
MediaBrowser	Display, manage, and edit existing images.

Caution

- Administrator privileges are required for installation.
- DL-10 is not network-compatible. Use as a stand-alone application.

System Requirements for Using the Supplied Software

The software is stored in the camera's internal memory. Before using the supplied software, check that your computer meets the following requirements. See the documentation provided with your computer for details.

Operating Systems Supported	Windows XP Home Edition Service Pack 3/Professional Service Pack 3 Windows Vista Service Pack 2 Windows 7 (32- and 64-bit)
CPU	Pentium® IV: 1.6 GHz or faster Pentium® M: 1.4 GHz or faster Core™ 2 Duo: 1.5 GHz or faster
Memory	Windows XP: 512 MB or more Windows Vista/Windows 7: 1 GB or more
Hard drive space required for installation	300 MB or more
Display Resolution	1024 × 768 pixels or greater
Display Colors	65,000 colors or greater
USB Port	A USB port compatible with the above-mentioned computer



Caution

- Windows XP 64-bit and Windows Vista 64-bit are not supported.
- If your computer has an upgraded OS, the USB function may not work normally, so it will not be supported.
- The provided software may not operate properly if changes are made to the operating system, such as with patches and service package releases.
- The camera does not support connection to a USB port added by using an extension function (PCI bus or other).
- If used in conjunction with a hub or other USB devices, the software may not work properly.
- When dealing with movies and other large files, a larger memory environment is recommended.

Installing Software

Install the supplied software to your computer.



Caution

If you install the DC Software 2 with the DC Software having been already installed, DL-10 for the DC Software 2 is added to the Start-up folder.

1 Turn the camera power off, and pull the SD memory card out of the camera.

- With SD memory card in the camera, the software cannot be installed.

2 Connect the supplied USB cable to the computer.

3 Connect the USB cable to the common terminal for USB port/ AV output of the camera.

- The camera turns on automatically when a connection is established.

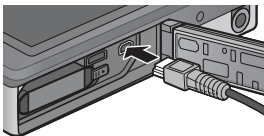

4 Use the camera ▲ and ▼ buttons to highlight [Computer] and press the MENU/OK button.

- [RICOHDCI(E:)] screen is displayed (E indicates the drive name).
- Note that charging will begin if no operations are performed for over 30 seconds. During charging, the camera controls can not be used and the camera will not function as a Mass Storage device; disconnect the USB cable and start over from Step 2.

5 Click [Start the digital camera software installer], and then click the [OK] button.

- [Digital camera software installer] screen appears.

Windows 7

- Click [Open folder to view files] and double-click [AUTORUN.EXE] from the displayed files.

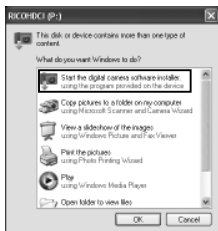

Use this button to install software required for batch downloading and editing of images.

Click this to display the Website for user registration.



6 Click [Installing the software].

Windows XP

- After a while, the [Choose Setup Language] screen appears.

Windows Vista/Windows 7

- If a [User Account Control] dialog is displayed, select [Yes] (Windows 7) or [Allow] (Windows Vista). If an icon appears on the task bar, click the icon to display the dialog. After a short pause, the [Choose Setup Language] dialog will be displayed.

7 Select a language and follow the on-screen instructions to complete installation.

- The MediaBrowser installer will start. To install MediaBrowser, accept the license agreement and follow the on-screen instructions.

8 Click [Unblock] for DL-10.

- For Windows 7, click [Allow access].

9 When a message appears asking you to restart your computer, select [Yes, I want to restart my computer now.] and then click [Finish].

- Your computer will restart automatically.
- After your computer restarts, a Windows security warning message appears.



Caution-----

- Do not force the USB cable into the terminal, or apply excessive force with the USB cable connected. Also, when using the USB cable, do not move the camera with the USB cable.
- Do not disconnect the USB cable with the camera power on.
- Do not connect other cable other than the USB cable provided.



Uninstalling the Software-----

- DC Software 2 and MediaBrowser can be uninstalled from [Control Panel] > [Programs and Features] (Windows 7 and Windows Vista; in category or home view, select [Control Panel] > [Programs] > [Uninstall a program]), or [Add or Remove Programs] (Windows XP).
- Administrator privileges are required.
- Quit any other programs that may be running before uninstalling the software.
- If you uninstall the DC Software 2 with the DC Software and the DC Software 2 have been already installed, DL-10 added to the Start-up folder can be deleted.

Viewing Software Manual

In the internal memory of the camera, "Software User Guide" (PDF file) is available. This guide explains how to download images from the camera to your computer. To view the guide, copy the guide onto your computer.

1 Open [My computer] with the camera connected to the computer.

- The internal memory of the camera appears as the drive.

2 Open [MANUAL] folder.

- Each language has its own "Software User Guide" (PDF file).

3 Copy the PDF file for your language directly to your hard disk.



Note-----

- Adobe Reader is required to display the operation manual (PDF file). Acrobat Reader or Adobe Reader need to be installed from the Adobe website if not installed on your computer.
- When the DL-10 Software has already been installed from the camera, select [Start] > [DC Software 2] > [Adobe Reader Download] to display the website for downloading.
- For details about Adobe Reader, see Help for Adobe Reader.

Copying Pictures to Your Computer

Follow the steps below to copy pictures to your computer.

⚠ **Caution**

To copy pictures stored in the SD memory card, insert the card first and then connect the camera to the computer.

1 **Connect the common terminal for USB port/AV output of the camera to the computer using the supplied USB cable.**

- Turn the camera off before connecting the USB cable.
- The camera turns on automatically when a connection is established.

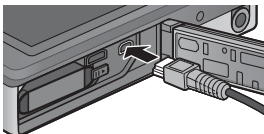

2 **Use the camera ▲ and ▼ buttons to highlight [Computer] and press the MENU/OK button.**

- Note that charging will begin if no operations are performed for over 30 seconds. During charging, the camera controls can not be used and the camera will not function as a Mass Storage device; disconnect the USB cable and start over from Step 1.

3 **Copy photos to the computer.**

If DL-10 is installed:

- DL-10 starts and image transfer begins automatically.
- Pictures are copied to the [Digital Camera] folder in [My Documents], where they are sorted into separate folders by date of recording. See the "Software User Guide" (PDF file) for more information.

If DL-10 is not installed:

- Copy files from the camera to the desired location.
- When an SD memory card is loaded, its files are displayed. Otherwise, files in the internal memory are displayed.
- When [Digital camera software installer] screen appears, click [×].

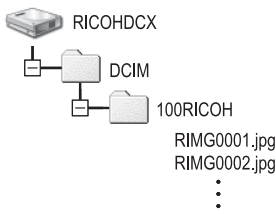

Example of the display
in Windows XP

4 Disconnect the USB cable when transfer is complete.

- Click the [Safely Remove Hardware] or [Unplug or Eject Hardware] icon in the taskbar (the illustration above shows the icon for Windows XP) and select [Safely Remove USB Mass Storage Device] or [Stop USB Mass Storage Device] from the menu that appears. You can then disconnect the USB cable.
- If the remove hardware icon is not displayed in Windows 7, click the  button in the taskbar.



Caution-----

Do not turn off the camera or disconnect the USB cable during image transfer.

Note-----

- “MediaBrowser” image viewing and editing software (for Windows only) is also included in the internal memory of the camera. You can download the information on how to use MediaBrowser from the displayed “Help”.
- For the latest information about MediaBrowser, access the Web page of Pixela Co., Ltd. (<http://www.pixela.co.jp/oem/mediabrowser/e/>).

For Macintosh

This camera supports the following Macintosh operating systems.

- Mac OS X 10.1.2 to 10.6.6

⚠ **Caution**

- The "Software User Guide" can be viewed on Macintosh computers.
- The "Software User Guide" is in pdf format. Copy the PDF file for your language from the [MANUAL] folder in the camera's internal memory to the computer hard disk.

Copying Pictures to Your Computer

Follow the steps below to copy pictures to your computer.

⚠ **Caution**

To copy pictures stored in the SD memory card, insert the card first and then connect the camera to the computer.

- 1 Connect the common terminal for USB port/AV output of the camera to the computer using the supplied USB cable.**

- Turn the camera off before connecting the USB cable.
- The camera turns on automatically when a connection is established.

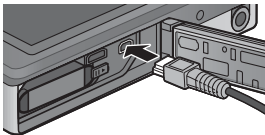

- 2 Use the camera ▲ and ▼ buttons to highlight [Computer] and press the MENU/OK button.**

- Note that charging will begin if no operations are performed for over 30 seconds. During charging, the camera controls can not be used and the camera will not function as a Mass Storage device; disconnect the USB cable and start over from Step 1.

3 Copy photos to the computer.

- Copy files from the camera to the desired location.
- When an SD memory card is loaded, its files are displayed. Otherwise, files in the internal memory are displayed.

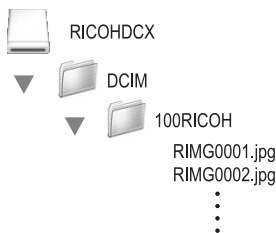

4 Disconnect the USB cable when transfer is complete.

- Drag the camera volume into the Trash and then disconnect the USB cable.

Caution-----

- Do not turn off the camera or disconnect the USB cable during image transfer.
- You can also click [Eject] on the [File] menu to cancel the connection.
- If the USB cable is disconnected without disabling the connection, the Unsafe Removal of Device screen may be displayed. Be sure to stop the connection before removing the USB cable.
- When you connect your camera to a Macintosh computer, a file called "FINDER.DAT" or ".DS_Store" may be created in your SD memory card, which will appear as [Unmatched File] on your camera. You can delete this file from the SD memory card if you wish.

10 Appendices

Troubleshooting

Error Messages

If an error message is displayed on the screen, check the information on the reference page and take the corresponding action.

Error Message	Cause and Solution	Refer to
Insert card.	No card is loaded. Insert a card.	P.20
Set date.	The date is not set. Set the date.	P.55
File number limit exceeded.	The file number limit has been exceeded. Use another card.	P.82
Unmatched File	This file cannot be displayed on the camera. Check the file contents on your computer, and then delete the file.	—
Insufficient memory. Continue?	Memory insufficient to copy all files. Use another card.	—
Protected	The file selected for deletion is protected.	P.65
Card Is Write-Protected.	The card is locked (write-protected). Unlock the card.	P.22
Cannot apply print settings.	This file (movie or other file) cannot be selected for printing.	—
Insufficient Memory	Files cannot be stored. Make sure there is sufficient memory or delete unwanted files.	P.34, P.83
	The image print number limit has been exceeded. Select an image and set the number to 0.	P.88
Format internal memory.	The internal memory requires formatting.	P.83
Format card.	The card is not formatted. Format the card with this camera.	P.83
Card Error	SDXC cards can not be used. If the card is not an SDXC card, format the card; if the message persists, the card may be faulty and should not be used.	P.83
Writing Data	Writing file to memory. Wait until writing finishes.	—
No File	There are no files that can be played back.	—
Out of memory. cannot record.	The number of remaining shots is 0. Switch to another card or the internal memory.	P.20
Can not —. *	Selected option can not be applied to image more than once, or image was created with different make of camera. If image was created with different make of camera, process image using original make of camera.	—



* "—" indicates the name of the process that can not be applied.

Camera Troubleshooting

Power Supply

Problem	Cause	Solution	Refer to
The camera does not turn on.	The battery is exhausted or not inserted.	Load the rechargeable battery correctly, or charge the battery.	P.20, P.22
	An unacceptable battery is used.	Use the dedicated rechargeable battery. Never use any other battery.	P.21
	The camera is automatically turned off by auto power off.	Turn the camera back on.	P.24
	The battery is loaded in wrong direction.	Load correctly.	P.20
	Because the camera overheated, the power was automatically turned off.	Wait until the temperature of the camera returns to normal. Do not attempt to cool the camera suddenly.	—
The camera turns off during use.	The camera was left unattended and unused, so auto power off turned it off.	Turn the camera back on.	P.24
	Battery is exhausted.	Charge the rechargeable battery.	P.22
	An unacceptable battery is used.	Use the dedicated rechargeable battery. Never use any other battery.	P.21
The camera does not turn off.	Camera malfunction	Remove the battery and load it again.	P.20
The battery has been fully charged, but: <ul style="list-style-type: none">• The battery symbol is displayed, indicating a low battery level.• The camera turns off.	A (manganese dry cell or other) unacceptable battery is used.	Use the dedicated rechargeable battery. Never use any other battery.	P.21
Cannot charge the battery.	Battery has reached the end of its useful life.	Replace with a new rechargeable battery.	P.20
Battery runs out quickly.	It is being used at extreme high or low temperatures.	—	—
	Many shots are being taken in dark places or other location requiring extensive use of flash.	—	—

Shooting

Problem	Cause	Solution	Refer to
The camera does not shoot even if you press the shutter release button.	Battery is exhausted.	Charge the rechargeable battery.	P.22
	The camera is not on.	Press the POWER button to turn the camera on.	P.24
	The camera is in playback mode.	Press the  (Playback) button to select the shooting mode.	P.31
	The shutter release button is not pressed all the way.	Press the shutter release button all the way.	P.27
	The SD memory card is not formatted.	Format the card.	P.83
	The SD memory card is full.	Load a new card, or delete unwanted files.	P.34, P.20
	The SD memory card has reached the end of its useful life.	Load a new SD memory card.	P.20
	The flash is charging.	Wait until the flash mode symbol stops blinking.	P.29
	The SD memory card is locked.	Unlock the card.	P.22
Unable to view the shot image.	The contact surface of the SD memory card is dirty.	Wipe with a soft, dry cloth.	—
	The image confirmation time is too short.	Lengthen the image confirmation time.	P.81
Images do not appear on the picture display.	The camera is not on, or the picture display is dark.	Turn the camera on, or adjust the brightness of the picture display.	P.24, P.80
	The VIDEO/AV cable is connected.	Disconnect the VIDEO/AV cable.	—
Camera is unable to focus.	The lens is dirty.	Wipe clean with a soft, dry cloth.	—
	The subject is not in the center of the shooting range.	Shoot with focus lock.	P.47
	It is a hard-to-focus subject.	Shoot with focus lock.	P.47
Although the camera is not in focus, the green frame appears in the center of the picture display.	The camera incorrectly focused because the distance to the subject is too close.	Move away from the subject.	—
The picture is blurred. (The  symbol appears.)	You moved the camera when pressing the shutter release button.	Hold camera in both hands with your elbows pressed lightly against your torso. Use a tripod. Use the camera shake correction function.	P.26 P.50
	When shooting in a dark place (such as indoors), the shutter speed slows down and pictures become easily blurred.	Use the flash. Raise the ISO setting. Use the camera shake correction function.	P.29 P.56 P.50

Problem	Cause	Solution	Refer to
The flash does not fire. Or, the flash cannot charge.	The flash is disabled: <ul style="list-style-type: none"> • when [Fireworks], [Landscape], or [Pets] is selected in premium shot mode, • during movie recording, and • during continuous shooting. 	To shoot with the flash, change the settings or mode.	P.29, P.104
	The flash is set to [OFF].	Select [ON] or [AUTO].	P.29
	Battery is exhausted.	Charge the rechargeable battery.	P.22
Even though the flash fired, the picture is dark.	The distance to the subject exceeds the flash range.	Get closer to your subject and shoot. Change the flash mode or the ISO setting.	P.56
	The subject is dark.	Correct the exposure.	P.30
The image is too bright.	The light intensity of the flash is not appropriate.	Move away from the subject or use a different light source.	—
	Subject is overexposed. (The [! AE] symbol appears.)	Correct the exposure.	P.30
	The brightness of the picture display is not appropriate.	Adjust the brightness of the picture display.	P.80
The image is too dark.	The flash is off and the subject is poorly lit.	Select [ON] or [AUTO].	P.29
	The subject is underexposed. (The [! AE] symbol appears.)	Correct the exposure.	P.30
	The brightness of the picture display is not appropriate.	Adjust the brightness of the picture display.	P.80
The image lacks natural color.	The picture was shot in conditions that made it difficult for auto white balance to adjust the white balance.	Add a white object to the composition, or use a white balance setting other than auto.	P.51
The date or recording information does not appear on the screen.	The screen display function is set to no display.	Choose a different option for [Choose shooting info].	P.79
The brightness of the picture display changes during AF.	Ambient lighting is poor or differs from that used for autofocus..	This is normal.	—
Vertical streaks ("smear") appear in photos.	Subject is bright.	This is normal and does not indicate a malfunction.	—
Self timer lamp does not light.	[Pets] is selected in premium shot mode.	Choose another mode.	P.40
The quick shooting menu is not displayed.	[Off] is selected for [Quick menu display].	Select [On] for [Quick menu display].	P.79

Playback/Deleting

Problem	Cause	Solution	Refer to
Cannot play back, or the playback screen does not appear.	The camera is not in playback mode.	Press the  (Playback) button.	P.31
	The HDMI/AV cable is not connected properly.	Connect properly.	P.69
	The [Video Out Mode] setting is incorrect.	Set it to the correct format.	P.82
The contents of the SD memory card cannot be played back, or the playback screen does not appear.	No SD memory card is loaded, or an SD memory card with no stored images is loaded.	Load a card with stored images.	—
	You played back an SD memory card that was not formatted with this device.	Load a card that was formatted and recorded with this device.	P.20, P.83
	You played back an SD memory card that was not recorded normally.	Load a normally recorded card.	P.20
	The contact surface of the SD memory card is dirty.	Wipe with a soft, dry cloth.	—
	There is something wrong with the SD memory card.	Play back images from another card and if there is nothing wrong with the card, the camera is okay. There may be something wrong with the card, so do not use it.	—
The picture display turned off.	Battery is exhausted.	Charge the rechargeable battery.	P.22
	Having been left unused, the camera has entered sleep mode or turned itself off to save power.	Use camera controls. If the camera is off, turn it on.	P.24
A file cannot be deleted.	The file is protected.	Unprotect the file.	P.65
	[On] is selected for [Auto-protect faves].	Turn [Auto-protect faves] off or give the files a zero star rating.	P.80 P.32
	The SD memory card is locked.	Unlock the card.	P.22
Cannot format the SD memory card.	The SD memory card is locked.	Unlock the card.	P.22
The quick playback menu is not displayed.	[Off] is selected for [Quick menu display].	Select [On] for [Quick menu display].	P.79
The playback menu contains few options.	The menu was displayed during favorites playback.	Display the menu after returning to normal playback.	P.32

Other Problems

Problem	Cause	Solution	Refer to
Cannot load the SD memory card.	The card is facing the wrong way.	Load correctly.	P.20
The camera does not operate even when the buttons are pressed.	Battery is exhausted.	Charge the rechargeable battery.	P.22
	Camera malfunction	Press the POWER button to turn the camera off, and then press the POWER button to turn the camera on again.	P.24
		Remove the battery and load it again.	P.20
The date is incorrect.	The correct date/time are not set.	Set the correct date/time.	P.55
The set date disappeared.	The battery was removed.	If the battery is removed for more than one week, the date setting will be lost. Make the settings again.	P.55
Auto power off does not work.	Auto power off is set to [Off].	Set the time for auto power off.	P.81
The operation sound cannot be heard.	[Pets] is selected in premium shot mode.	Choose another mode.	P.40
	The operation sound volume is turned off.	Use [Volume Settings] to set the volume to a setting other than mute.	P.81
Images do not appear on the TV.	The [Video Out Mode] setting is incorrect.	Set it to the correct format.	P.82
	The AV cable is not connected.	Connect the AV cable properly.	P.69
	The TV is not correctly set to VIDEO IN.	Check that the TV is correctly set to VIDEO IN.	—

Available Settings

The following table lists the settings available in each shooting mode.

		Normal	PREMIUM						
			P						
	(Flash)	✓	✓	✓*1	✓*1	✓	✓*1	✓	✓
	(Self-timer) *5	✓	✓	✓	✓	✓*2	✓	✓*2	✓*2
	Digital Zoom	✓	✓	✓	✓	✓	✓	✓	✓
Shooting Menu	Picture Quality/Size	✓	✓	✓	✓	—*3	✓	✓	✓*4
	Continuous Mode *7,8	✓	✓	—	—	—	—	—	—
	Focus *9,10	—	✓	—	✓	✓	✓	—	—
	Exposure Metering	—	✓	—	—	—	—	✓	✓
	Image Settings	—	✓	—	—	—	—	—	—
	Super Resolution	—	✓	—	—	—	—	—	—
	White Balance	—	✓	—	✓	✓	—	—	—
	ISO Setting	—	✓	✓	—	—	—	✓	✓
	Maximum for ISO Auto	—	✓	✓	—	—	—	✓	✓
	Exposure Compensation	✓	✓	✓	✓	✓	✓	—	—
	Movie Size	✓	✓	✓	✓	✓	✓	✓	✓
	Red-eye reduction	✓	✓	—	—	—	—	—	—
	Pre-AF	✓	✓	—	✓	✓	✓	✓	✓
	Shake Correction	—	✓	✓	✓	—	✓	✓	✓
	Date Imprint	✓	✓	✓	✓	✓	✓	✓	✓
	Plus Normal Shooting	—	—	—	—	—	—	—	—
	Soft Focus Options	—	—	—	—	—	—	—	—
	Hue	—	—	—	—	—	—	—	—
	Vignetting	—	—	—	—	—	—	—	—
	Toy Color	—	—	—	—	—	—	—	—
Reset premium shot settings	✓	✓	✓	✓	✓	✓	✓	✓	
Restore Defaults	✓	—	—	—	—	—	—	—	

*1 Red-eye reduction is automatically enabled when [ON] or [AUTO] is selected.

*2 [Group portrait] is not available.

*3 Fixed at [4M 4 : 3].

*4 [14M 3 : 2] and [12M 16 : 9] are not available.

*5 Fixed at [1M 4 : 3].

*6 Only [1M 4 : 3] or [VGA 4 : 3] is available.

*7 When an option other than [Off] is selected, the flash turns off and [Multi-P Auto] white balance functions as [Auto].

*8 If [S-Cont] or [M-Cont] is selected, ISO sensitivity is adjusted automatically when [ISO 100] and [ISO 200] is selected for [ISO Setting]. Image size is fixed at [6M 4 : 3].

*9 [Spot AF] is used if [Multi AF] is selected during digital zoom.

*10 When [Face Pr.] is selected, the camera automatically optimizes white balance and no icon is displayed. If no face is detected, the camera focuses using [Multi AF].

✓: Available —: Not available

PREMIUM															
									mini	Toy	HBW	Soft		BW	SP
✓	—	✓	✓	✓	—	✓	✓	—	✓	✓	✓	✓	✓	✓	✓
✓*2	✓*2	✓	✓	✓*2	✓*2	—	✓*2	✓*2	✓*2	✓	✓	✓	✓	✓	✓
✓	✓	✓	✓	✓	✓	—	✓	✓	✓	✓	✓	✓	✓	✓	✓
✓	✓	✓	✓	✓	✓	—*5	✓*6	✓	✓	✓	✓	✓	✓	✓	✓
—	—	—	—	✓	—	—	—	—	—	—	—	—	—	—	—
—	—	✓	✓	✓	—	—	✓	—	✓	✓	✓	✓	✓	✓	✓
✓	—	—	—	—	—	✓	✓	—	✓	✓	✓	✓	✓	✓	✓
✓	—	—	—	—	—	✓	✓	—	—	—	—	—	—	—	—
✓	✓	—	—	✓	—	—	✓	✓	✓	✓	—	✓	✓	—	—
✓	—	—	—	—	—	✓	✓	✓	✓	✓	✓	✓	✓	✓	✓
✓	—	—	—	—	—	✓	✓	✓	✓	✓	✓	✓	✓	✓	✓
✓	✓	✓	✓	✓	—	—	✓	✓	✓	✓	✓	✓	✓	✓	✓
✓	✓	✓	✓	✓	✓	✓	✓	✓	✓	✓	✓	✓	✓	✓	✓
—	—	✓	✓	✓	—	—	—	—	—	✓	✓	✓	✓	✓	✓
✓	—	✓	✓	✓	—	✓	✓	—	✓	✓	✓	✓	✓	✓	✓
✓	✓	✓	✓	✓	—	✓	✓	✓	✓	✓	✓	✓	✓	✓	✓
✓	✓	✓	✓	✓	✓	✓	✓	✓	✓	✓	✓	✓	✓	✓	✓
—	—	—	—	—	—	—	—	—	✓	✓	✓	✓	✓	✓	✓
—	—	—	—	—	—	—	—	—	—	—	—	✓	—	—	—
—	—	—	—	—	—	—	—	—	—	—	—	—	✓	—	—
—	—	—	—	—	—	—	—	—	✓	—	—	—	—	—	—
—	—	—	—	—	—	—	—	—	✓	—	—	—	—	—	—
✓	✓	✓	✓	✓	✓	✓	✓	✓	✓	✓	✓	✓	✓	✓	✓
—	—	—	—	—	—	—	—	—	—	—	—	—	—	—	—

Specifications

Camera

No. of effective pixels (camera)		Approx. 16.00 million effective pixels
Image Sensor		1/2.3" CCD (Approx. 16.40 total million pixels)
Lens	Focal Length	5 mm to 25 mm (equivalent to 28 mm to 140 mm on a 35-mm camera)
	F-aperture	F3.9 to F5.4
	Shooting Distance	Normal shooting: Approx. 3 cm to ∞ (Wide-angle), 50 cm to ∞ (Telephoto) or 3 cm to ∞ (Loupe) (from the front of the lens)
	Lens Construction	13 elements in 10 groups
Zoom Magnification *1,2		Optical zoom at 5.0×, Super resolution zoom at 2.0×, Digital zoom at 4.8×, Auto resize zoom at approx. 7.2× (VGA image)
Focus Modes		Multi AF (Contrast AF method)/Spot AF (Contrast AF method)/Face-priority Multi AF/Subject tracking AF (with AF Auxiliary Light)
Blur Reduction		Image Sensor Shift Image Stabilizer
Shutter Speed	Still Image	8, 4, 2, 1 to 1/2000 seconds (The upper and lower limits differ for each shooting mode and flash mode.)
	Movie	1/30 to 1/2000 seconds
Exposure Control	Exposure Metering Mode	Multi Light Metering (256 segments)/Center-weighted Light Metering/Spot Metering
	Exposure Mode	Program AE
	Exposure Compensation	Manual exposure compensation (+2.0 to -2.0 EV in 1/3 EV steps)
	Exposure Range (auto mode, center-weighted metering)	Wide angle: 3.2 – 17.7 EV Telephoto: 4.1 – 19.4 EV (Exposure range for auto ISO calculated using values for ISO 100.) Note: At 6.0 EV or lower, each drop of 1.0 EV is associated with a 0.5 EV drop in brightness. Brightness drops by no more than -1.0 EV.
	ISO Sensitivity (Standard Output Sensitivity)	Auto/ISO 100/ISO 200/ISO 400/ISO 800/ISO 1600/ISO 3200
White Balance Mode		Auto/Multi-pattern Auto/Outdoors/Cloudy/Incandescent 1/Incandescent 2/Fluorescent/Manual
Flash	Flash Mode	AUTO/ON/OFF; red-eye reduction is available using [Red-eye reduction]
	Built-in flash Range	Approx. 20 cm – 3.5 m (Wide-angle) or 50 cm – 3.0 m (Telephoto) (auto ISO with a maximum of ISO 1600, measured from the front of the lens)
	Charging Time	Approx. 5 seconds
Picture Display		2.7" Transmissive LCD, approx. 230,000 dots

Shooting Mode		Normal/Movie mode/Premium shot mode (P mode/Portrait/Night. Port./Hand-Held Night Scn/Party/Cooking/Sweets/Loupe/Landscape/Beach/Snow/Sports/Fireworks/Auction/Skew Correct Mode/Pets/Miniaturize/Toy Camera/High Contrast B&W/Soft Focus/Cross Process/Black & White/Sepia)
Number of Recorded Pixels	Still Image	4608 × 3456, 4608 × 3072, 3456 × 3456, 4608 × 2592, 3648 × 2736, 2592 × 1944, 2304 × 1728, 1280 × 960, 640 × 480
	Movie	1280 × 720, 640 × 480
Recording Media		SD memory card, SDHC memory card (up to 32 GB), Internal memory (approx. 40 MB)
Recording Data Capacity	4608 × 3456	Approx. 5842 KB/screen
	4608 × 3072	Approx. 5196 KB/screen
	3456 × 3456	Approx. 4389 KB/screen
	4608 × 2592	Approx. 4402 KB/screen
	3648 × 2736	Approx. 3685 KB/screen
	2592 × 1944	Approx. 2292 KB/screen
	2304 × 1728	Approx. 1838 KB/screen
	1280 × 960	Approx. 817 KB/screen
Recording File Format	Still Image	JPEG (Exif Ver. 2.3) *3
	Movie	AVI (Open DML Motion JPEG Format Compliant)
	Compression Format	JPEG Baseline Format Compliant (Still image, movie)
Other Major Shooting Functions		Continuous mode, Self-timer (operation time: approx. 10 seconds, approx. 2 seconds, Group portrait), Grid guide display
Other Major Playback Functions		Thumbnail view, Favorites playback, Privacy Settings, Resize, Skew Correction, Trim, Slide show, DPOF
Interface		USB2.0 (High-Speed USB) Mini-B, Mass storage-compatible *4, AV output 1.0Vp-p (75 Ω), HDMI Micro Output Terminal (Type D)
Video Signal Format		NTSC, PAL
Power Supply		Rechargeable Battery (DB-100): 3.7V
Battery Consumption *5		Usage time of DB-100: approx. 300 pictures (When [Sleep Mode] is set to [Off] *6)
Dimensions (W × H × D)		100 mm × 55 mm × 21.3 mm (excluding projections; measured according to CIPA guidelines)
Weight		Approx. 156 g (including memory card and supplied battery) Approx. 136 g (camera only)
Tripod Hole Shape		1/4-20UNC

Date Maintain Time	Approx. 1 week
Water resistance/ Dust resistance	JIS/IEC waterproof grade 8, JIS/IEC dustproof grade 6 (IP68); can be used underwater to a depth of 3 m for up to 60 minutes at a time
Operating Temperature	0°C to 40°C
Operating Humidity	90% or less
Storage Temperature	-20°C to 60°C

- *1 The following table shows the minimum shooting distance and shooting range at different zoom positions:

Zoom position	Focal Length ^(*)	Minimum Shooting Distance (from the front of the lens)	Shooting Range
Wide-angle	28 mm	Approx. 3 cm	Approx. 46 mm × 35 mm
Telephoto	140 mm	Approx. 50 cm	Approx. 142 mm × 107 mm (when super resolution zoom/digital zoom is not used)
	280 mm	Approx. 50 cm	Approx. 71.0 mm × 53.3 mm (when 2.0× super resolution zoom/digital zoom is not used)
	1344 mm	Approx. 50 cm	Approx. 14.8 mm × 11.1 mm (when 2.0× super resolution zoom/4.8× digital zoom is used)

(*) Equivalent to that on a 35 mm camera

- *2 The following are the minimum focal lengths and shooting ranges for [Loupe] mode (the minimum shooting distance in [Loupe] mode is 3 cm):

Focal Length ^(*)	Shooting Range
28 mm	Approx. 46 mm × 35 mm
56 mm	Approx. 23.2 mm × 17.4 mm (when 2.0× super resolution zoom/digital zoom is not used)
269 mm	Approx. 4.8 mm × 3.6 mm (when 2.0× super resolution zoom/4.8× digital zoom is used)

(*) Equivalent to that on a 35 mm camera

- *3 Compatible with DCF and DPOF. DCF is the abbreviation for "Design rule for Camera File system," a JEITA standard. (Full compatibility with other devices is not guaranteed.)
- *4 Mass storage mode is supported by Windows XP, Windows Vista, Windows 7 and Mac OS X 10.1.2–10.6.6.
- *5 The number of remaining shots is based on the CIPA standard and may vary depending on usage conditions. This is for reference only.
- *6 You can take approximately 320 shots when [Sleep Mode] is set to [10 seconds].

Rechargeable Battery (DB-100)

Nominal Voltage	3.7V
Rated Capacity	950 mAh (minimum), 1000 mAh (typical)
Operating Temperature	0°C to 40°C
Dimensions (W × H × D)	34.2 mm × 37.5 mm × 6.8 mm
Weight	Approx. 19 g

Number of Images That Can Be Stored

The following table shows the approximate number of images that can be recorded in the internal memory and onto an SD memory card at various image size and picture quality settings.

Mode	Image Size	Internal Memory	1GB	2GB	4GB	8GB	16GB	32GB
Normal Premium shot (excluding [Hand-Held Night Scn] and [Auction])	16M 4:3	6	153	312	612	1252	2508	5032
	14M 3:2	7	173	351	689	1409	2823	5664
	12M 1:1	8	204	415	815	1666	3339	6698
	12M 16:9	8	204	415	815	1666	3339	6698
	10M 4:3	10	242	491	965	1973	3953	7930
	5M 4:3	15	373	758	1490	3045	6101	12238
	1M 4:3	43	1059	2118	4160	8505	17039	34181
	VGA 4:3	169	4028	7681	15082	30828	61759	123888
Movie	HD 1280		3 min. 3 s	6 min. 14 s	12 min. 14 s	25 min. 1 s	50 min. 7 s	100 min. 33 s
			7 s	14 s	14 s	1 s	7 s	33 s
	VGA 640		8 min. 55 s	18 min. 8 s	35 min. 38 s	72 min. 50 s	145 min. 54 s	292 min. 41 s
		22 s	55 s	8 s	38 s	50 s	54 s	41 s
[S-Cont]/ [M-Cont]	16M 4:3	6	153	312	612	1252	2508	5032
Premium shot ([Hand-Held Night Scn])	4M 4:3	19	465	945	1856	3795	7602	15251
Premium shot ([Auction])	1M 4:3	93	2237	4389	8619	17617	35294	70800



Note

- The maximum recording time is the estimated total recording time. Movies may be up to 4GB in size or 29 minutes in length.
- A Speed Class 6 memory card is recommended when recording movies with [HD 1280] selected for [Movie Size].
- The maximum number of consecutive shots that can be taken using continuous mode is 999. When the number of remaining shots is 1000 or more, "999" is displayed on the picture display.
- The number of remaining shots displayed on the picture display may differ from the actual number of shots, depending on the subject.
- Movie recording time and the maximum number of still pictures may vary depending on the capacity of the recording destination (internal memory or SD memory card), shooting conditions, and the type and manufacturer of the SD memory card.
- Choose image size according to how the picture will be used:

Image Size	Description
16M 4 : 3 / 14M 3 : 2 /	• For creating large prints. • For downloading to a computer for trimming and other processes.
12M 1 : 1 / 12M 16 : 9 /	
10M 4 : 3	• For creating prints.
5M 4 : 3	
1M 4 : 3	• For shooting a large number of pictures.
VGA 4 : 3	• For shooting a large number of pictures.
	• For attaching to e-mail.
	• For posting on a website.



Defaults Settings/Functions Whose Defaults Are Restored When the Camera Is Turned Off

Turning the camera off may reset some function settings to their defaults. The table below indicates whether or not the function is reset to its default when the camera is turned off.

○: setting is saved ×: setting is reset

	Function		Default Settings
Shooting	Picture Quality/Size	○	16M 4 : 3
	Picture Quality/Size (Sweets)	○	12M 1 : 1
	Picture Quality/Size (Skew Correct Mode)	○	1M 4 : 3
	Continuous Mode	×	Off
	Focus	○	Multi AF
	Exposure Metering	○	Multi
	Image Settings	○	Standard
	Super Resolution	○	Off
	White Balance	○	Multi-P AUTO
	ISO Setting	○	Auto
	Maximum for ISO Auto	○	AUTO 1600
	Exposure Compensation	○	0.0
	Movie Size	○	HD 1280
	Red-eye reduction	○	Off
	Pre-AF	○	On
	Shake Correction	○	On
	Date Imprint	○	Off
	Plus Normal Shooting	○	Off
	Soft Focus Options	○	Strong
	Hue	○	Basic
	Vignetting	○	Weak
	Toy Color	○	On
	Premium shot	○	Cooking
	Self-Timer	×	Self-Timer Off
	Brightness/color (Cooking, Sweets, Auction)	○	Brightness: 0/ Color: Neutral
	Vignette (Sweets)	○	Rectangular
	Layout (Auction)	○	Single
	Exposure time (Fireworks)	○	4 Sec
	Area in focus (Miniaturize)	×	Width: Medium/ Position: Center

○: setting is saved ×: setting is reset

	Function		Default Settings
Playback	Volume Adjustment	○	—
Setup	Quick menu display	○	On
	Choose shooting info	○	Show info
	Grid Guide Display	○	
	Playback info	○	Simplified
	Auto Rotate	○	On
	Auto-protect faves	○	Off
	LCD Brightness	○	—
	AF Auxiliary Light	○	On
	Operation Sounds	○	All
	Volume Settings	○	 (Medium)
	LCD Confirmation Time	○	0.5 seconds
	Auto Power Off	○	5 minutes
	Sleep Mode	○	Off
	LCD Auto Dim	○	On
	Digital Zoom Image	○	Normal
	Card Sequence No.	○	Off
	Date Settings	○	—
	Language/言語	○	(*)
	Video Out Mode	○	(*)
	HDMI Output	○	AUTO
Eye-Fi settings	○	On	

(*) The default setting varies depending on where you purchased the camera.

Optional Accessories

Battery Charger (BJ-10)

The BJ-10 can be used to recharge DB-100 rechargeable batteries. Insert the battery with the ⊕ and ⊖ labels oriented to match the labels on the charger and plug the charger in.

Charging status is indicated by the charger lamp as shown in the table below. Unplug the charger when charging is complete.

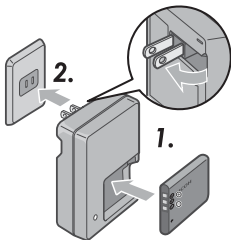

Charger Lamp	Description
Lit	Charging
Off	Charging complete
Flashing	The battery charger terminal may be soiled or the battery charger/battery may be faulty. Unplug the battery charger from the power outlet, and remove the battery.

Charging time varies with charge state; an exhausted battery will recharge in about 180 minutes at 25 °C.



Note

- Risk of explosion if battery is replaced by an incorrect type.
- Dispose of used batteries according to the instructions.
- Use only the lithium-ion batteries of the series DB-100 which our company supplies.
- Do not use the specialized electrical power cord with other products.
- Do not subject the appliance to strong shock.
- Do not use in a place which is extremely hot or cold or a place subject to strong vibrations.
- Do not use in a place which receives direct sunlight and could reach high temperatures.
- When you have finished charging the batteries, pull out the plug from the household electrical outlet. If you leave the plug in the household electrical outlet it can cause fire.
- Do not let the contact parts of the rechargeable batteries touch each other. This can cause a short circuit.
- The BJ-10 is for use at temperatures between 10 °C and 40 °C. At temperatures below 10 °C, charging times may increase or the battery may not charge.

Using Your Camera Abroad

USB Power Adapter/Battery Charger (Model BJ-10)

The battery charger can be used in regions with a current of 100-240V, 50 Hz/60 Hz. If you are going to travel to a country that uses a different shaped wall outlet/plug, please consult your travel agent on a plug adapter suitable for wall outlets in your country of destination.

Do not use electrical transformers. It may damage the camera.

Warranty

This product was manufactured for use in the country in which it was purchased. The warranty is only valid in the country in which the camera was purchased. Should the product fail or malfunction while you are abroad, the manufacturer assumes no responsibility for servicing the product locally or bearing the expenditure incurred therefore.

Playback on Television in Other Regions

Playback is possible on televisions (or monitors) equipped with a video input terminal. Please use the AV cable provided.

This camera is compatible with both NTSC and PAL television formats. Set the video format on the camera to match that of the television you are using.

When you go abroad, set your camera to the local video format.

Cautions on Use

Camera

Waterproofing

- This camera conforms to the specifications for JIS/IEC waterproof grade 8 and JIS/IEC dustproof grade 6 (IP68).
- Do not use underwater at depths below 3 m or for more than 60 minutes at a time.
- Water may seep from the cracks in the cover after the camera has been used in the rain or washed. This however does not indicate a leak, as the camera is protected by a double casing.
- The internal mechanisms of the camera are neither waterproof nor dust-proof.
- Should water enter the inside of the camera, remove the batteries immediately and contact the Ricoh Repair Center.

Cautions on Use

- When opening and closing the battery/card cover or terminal cover, take care to prevent any water, sand, mud, dust, or other foreign matter that may have adhered to the camera from entering the interior of device. If possible, avoid opening or closing the camera at the seaside or near other bodies of water or on a beach or in other sandy locations.
- Water may adhere to the inside of the covers while they are open. Dry the inside of the covers before use.
- Do not leave the camera in places where there are extremes of temperature or humidity, such as in a closed car, at the seashore, or in a bathroom.
- If any foreign object (metal, water, liquid) gets inside the camera, stop using the camera immediately. Turn the power off, remove the battery and memory card, and consult your nearest dealer or Ricoh Repair Center.
- Before using the camera, confirm that the battery and memory card are fully inserted and latched.
- This product was manufactured for use in the country in which it was purchased. The warranty is only valid in the country in which the camera was purchased.
- Should the product fail or malfunction while you are abroad, the manufacturer assumes no responsibility for servicing the product locally or bearing the expenditure incurred therefore.
- Be sure not to drop or apply any sudden force to the camera.
- While you are carrying the camera, be careful not to hit it against other objects. Take special care to not hit the lens and picture display.
- Firing the flash consecutively may heat the firing unit. Do not fire it consecutively more than necessary.

- Do not touch the flash and keep foreign objects away from the firing unit. Doing so can cause burns and fires.
- Do not fire the flash near eyes. It could cause visual impairment (particularly for infants).
- Do not fire the flash near the driver of a vehicle to avoid causing accidents.
- The battery may become hot after extended use. Touching the battery immediately after use could result in burns to your fingers.
- If the picture display or panel is exposed to sunlight, they may become washed out and images may become hard to view.
- The picture display and panel may contain some pixels that do not remain lit up continually in part or at all. Also, the brightness may become uneven because of the characteristics of LCDs. These are not failures.
- Do not forcefully press the surface of the picture display.
- In an environment where the temperature changes suddenly, condensation may occur in the camera, resulting in troubles such as fogging of the glass surface or malfunctions of the camera. If this occurs, place the camera in a bag to slow the temperature change as much as possible. Take it out of the bag after the temperature difference from the atmosphere has decreased to a fairly small amount. If condensation occurs, remove the battery and memory card, and wait until the moisture has dried before using the camera.
- To avoid damaging the connectors, do not put any objects into the camera's microphone or speaker holes.
- Before taking any important pictures (such as at weddings, on trips abroad, etc.), test the camera to check operation and ensure proper functioning. We recommend that you keep this manual and spare battery on hand.



Conditions in which condensation may easily occur: -----

- When the camera is moved to an environment where the temperature differs greatly.
- In humid places.
- In a room immediately after being heated, or when the camera is exposed directly to cooled air from an air-conditioner or another similar appliance.

Rechargeable Battery

- The battery is not waterproof. Keep dry.
- The DB-100 is a lithium-ion battery.
- Charge the battery before use since the battery is not fully charged when it is shipped.
- The characteristics of lithium batteries are such that, at cold temperatures, the performance of even fully charged cells will decrease, reducing the available shooting or playback time. Counter this by keeping the batteries warm in a pocket next to your body before use or by having a spare charged battery available.
- Remove the battery from the camera and charger when not in use. These devices consume a small amount of power even when off and may draw the battery down to the point that it can no longer be used. Note that the camera clock will be reset after the battery has been removed for about a week. Reset the clock before use.
- When storing for an extended period of time, charge for 30 minutes at least once a year, draining it complete before storing it again.
- Store the battery in a cool, dry place. A temperature range of 15°C to 25°C is optimal. Avoid extremely hot or cold locations.
- Do not immediately charge a fully recharged battery a second time.
- Charge the battery at ambient temperatures between 10°C and 40°C. Performance may drop at higher temperatures, while at lower temperatures capacity may drop.
- Batteries that no longer hold a charge have reached the end of their service life and must be replaced.
- At 25°C, the battery charges in about 160 minutes when the supplied AC-U1 USB power adapter is used, or in about 180 minutes when charged using an optional BJ-10 battery charger.

Care

- Please note that if fingerprints, dirt, etc. get onto the lens, picture quality will suffer.
- When dust or dirt does get on the lens, do not touch it directly with your fingers, and either use a blower (available in stores) to blow it off, or a soft cloth to gently dust it off. Special care should be taken for the lens barrel.
- To remove salt, sand, or other foreign matter, confirm that the battery/card cover is securely closed and rinse the camera in a bowl or wash-basin filled with tap water. Use a dry, soft cloth to wipe the camera dry. Be sure to clean the camera in fresh water following underwater use; failure to observe this precaution could impair the product's water resistance.
- Any sand or other foreign matter should be removed from the rubber seal with a dry, soft cloth. Foreign matter can damage the seal, impairing water resistance. If the foreign matter can not be removed or the seal is damaged, request replacement from a Ricoh repair center.
- To ensure continued water resistance, it is recommended that the rubber seal be replaced once every two years whether it is damaged or not. Replace the seal once a year if you regularly use the camera underwater or in locations exposed to sand or dust.
- In the unlikely event that your camera fails to work properly, please consult your Ricoh Repair Center.
- There are high voltage circuits in this camera. As this is dangerous, do not dismantle this camera under any circumstances.
- Do not get volatile substances, such as thinner, benzene, or pesticides on your camera. This may cause a change in quality, paint to peel, etc.
- As the surface of the picture display is easily scratched, do not rub hard objects against it.
- Clean the surface of the picture display by wiping gently with a soft cloth containing a small amount of display cleaner (that does not contain organic solvents) sold in stores.

Use and Storage

- Please avoid using or storing your camera in the following kinds of places, as this may damage the camera.
 - In high heat and humidity, or where there is severe change in temperature or humidity.
 - Places with a lot of dust, dirt or sand.
 - Places with severe vibration.
 - Places where it is in direct contact with vinyl or rubber products or chemicals, including mothballs or other insect repellent, for long periods of time.
 - Places with strong magnetic fields (near a monitor, transformer, magnet, etc.).
- Store your camera in a dust-free camera bag, etc. to prevent dust or dirt from getting on the camera. Also, avoid carrying the camera without a case (in your pocket, etc.) to help to keep free from dust or fiber particles.
- Remove the battery if you are not going to use the camera for a long period of time.

Precautions regarding care of your camera

1. Be sure to turn the power off.
2. Remove the batteries before caring for your camera.

Warranty and Servicing

1. This product is backed by a limited warranty. During the warranty period mentioned in the Warranty supplied with your camera, any defective parts will be repaired free of charge. In the event of a camera malfunction, contact the dealer from which you purchased the camera or your nearest Ricoh Repair Center. Please note that you will not be reimbursed for the cost of bringing the camera to the Ricoh Repair Center.
2. This warranty does not cover any damage resulting from:
 - ① failure to follow the instructions in the instruction manual;
 - ② repair, modification or overhaul not conducted by an authorized service center listed in the instruction manual;
 - ③ fire, natural disaster, act of God, lightning, abnormal voltage, etc.;
 - ④ improper storage (noted in the "Camera User Guide"), mold, or otherwise insufficient care of the camera.
 - ⑤ the entry of water, dirt, sand, or other foreign matter, salt damage, or damage caused by falls, shocks, pressure, or other non-natural causes while the cover is open.
3. After the warranty period has passed, you will be liable for all repair fees, including those incurred at an authorized service center.
4. You will be liable for all repair fees, even within the warranty period, if the warranty card is not attached or if the distributor's name or the purchase date have been changed or are not indicated on the card.
5. Expenses for overhaul and thorough inspection by special request of the customer will be charged to the customer, whether or not they are incurred during the warranty period.
6. This warranty only applies to the camera and not to the accessories, such as the case and strap, nor does it apply to the battery and other consumables provided.
7. Any consequential damages arising from failure of the camera, such as expenses incurred in taking pictures or loss of expected profit, will not be reimbursed whether they occur during the warranty period or not.
8. The warranty is only valid in the country in which the camera was purchased.
 - * The above provisions refer to repairs offered free of charge, and do not limit your legal rights.
 - * The intention of the above provisions is also described in the warranty card provided with this camera.
9. Parts essential to the servicing of the camera (that is, components required to maintain the functions and quality of the camera) will be available for a period of five years after the camera is discontinued.
10. Please note that if the camera is seriously damaged by flooding, submergence, infiltration of sand or mud, violent shocks or dropping, it may not be repairable, and restoration to its original condition may be impossible.



Note

- Before sending the camera in for repair, check the battery and read the instruction manual again to ensure proper operation.
- Some repairs require a significant amount of time to be completed.
- When sending the camera to a service center, please include a note which describes the defective part and the problem as precisely as possible.
- Remove all accessories not related to the problem before sending the camera to the service center.
- This warranty does not apply to data stored on an SD memory card or in internal memory.

INFORMATION TO THE USER

USA FCC Part 15 Class B

This equipment has been tested and found to comply with the limits for a Class B digital device, pursuant to part 15 of the FCC Rules. These limits are designed to provide reasonable protection against harmful interference in a residential installation. This equipment generates, uses and can radiate radio frequency energy and if not installed and used in accordance with the instructions, may cause harmful interference to radio communications. However, there is no guarantee that interference will not occur in a particular installation. If this equipment does cause harmful interference to radio or television reception, which can be determined by turning the equipment off and on, the user is encouraged to try to correct the interference by one or more of the following measures:

- Reorient or relocate the receiving antenna.
- Increase the separation between the equipment and receiver.
- Connect the equipment into an outlet on a circuit different from that to which the receiver is connected.
- Consult the dealer or an experienced radio/TV technician for help. (FCC 15.105B)

Changes or modifications not expressly approved by the party responsible for compliance could void the user's authority to operate the equipment. (FCC 15.21)

Properly shielded and grounded cables and connectors must be used for connections to host computer in order to comply with FCC emission limits. (FCC 15.27)

An AC adapter with a ferrite core must be used for RF interference suppression.

COMPLIANCE INFORMATION STATEMENT

Product Name: DIGITAL CAMERA

Model Number: RICOH PX

This device complies with Part 15 of the FCC Rules.

Operation is subject to the following two conditions:

- (1) This device may not cause harmful interference, and
- (2) This device must accept any interference received, including interference that may cause undesired operation.

RICOH AMERICAS CORPORATION

5 Dedrick Place, West Caldwell NJ, 07006 Tel.: 1-800-225-1899

Note to Users in Canada

Note: This Class B digital apparatus complies with Canadian ICES-003

Remarque Concernant les Utilisateurs au Canada

Avertissement : Cet appareil numérique de la classe B est conforme à la norme NMB-003 du Canada

IMPORTANT SAFETY INSTRUCTIONS-SAVE THESE INSTRUCTIONS

DANGER-TO REDUCE THE RISK OF FIRE OR ELECTRIC SHOCK, CAREFULLY FOLLOW THESE INSTRUCTIONS.

Index

A

Add Premium Shots To Favorites	43
Adobe Reader	93
Adv. PB Options	36, 75
Adv. Shooting Options	36, 71
AF Auxiliary Light	15, 80
Auction	38, 41
Auto-protect Faves	80
Auto Power Off	25, 81
Auto Resize	57
Auto Rotate	80
AV Cable	14, 69

B

Battery	20, 22
Battery/Card Cover	16, 20
Battery Charger	14, 113
Beach	38
Black & White	39

C

Calendar View	32
Camera Shake	50
Card Sequence No.	82
Check Firmware Ver.....	83
Choose Shooting Info.....	79
Common Terminal for USB Port/AV Output.....	16, 69, 84, 90, 94, 96
Continuous.....	53
Continuous Mode	53, 72
Cooking	38
Copy to Card from Int. Memory	77
Cross Process.....	39

D

Date Imprint	73
Date Settings.....	25, 82
Delete.....	34
Delete Button.....	16, 34
Digital Zoom.....	28, 57
Digital Zoom Image.....	57, 82
Direct Print.....	84
DL-10	89
DPOF	66, 77

E

Enlarged View	33
Error Messages	98
Exposure Compensation	73
Exposure Compensation Button.....	16, 30
Exposure Metering	72
Eye-Fi Card	19, 22
Eye-Fi Host ID.....	83
Eye-Fi Settings	83

F

Favorites	32
Favorites Button.....	16, 32, 43, 44
Fireworks	38
Flash	15, 29, 50
Flash Dial.....	16, 29
Focus	49, 72
Focus Lock.....	47
Format [Card]	83
Format [Internal Memory].....	83

G

Grid Guide Display	80
--------------------------	----

H

Hand-Held Night Scn.....	38
Hand strap	14
HDMI Micro Output Terminal.....	16
HDMI Output.....	83
High Contrast B&W.....	39
Hue.....	74

I

Image Settings	52, 72
Indicator Lamp	15, 23
Internal Memory	109
ISO Setting	50, 56, 73

L

Landscape.....	38
Language/言語	25, 82
LCD Auto Dim.....	81
LCD Brightness	80
LCD Confirmation Time	81
Lens	15
Loupe	38

M

M-Cont	53
Macro	27
Manual	52
Maximum For ISO Auto	73
MediaBrowser	89
MENU/OK Button.....	16, 71, 75, 78
Microphone	15
Miniaturize	39, 43
Movie	45
Movie Button.....	16, 45
Movie Size	73

N

Night Portrait.....	38
Normal Shooting Mode.....	41

O

Operation Sounds.....	81
Optical Zoom	28

P

Party	38
Pets	39
PictBridge	84
Picture Display	16, 17
Picture Quality/Size	36, 72
Playback Button.....	16, 24, 31
Playback Info.....	80
Playback Menu.....	75
Playback Mode.....	24
Plug	14
Plus Normal Shooting.....	73
P Mode	38
Portrait.....	38
POWER Button.....	15, 24
Pre-AF.....	73
PREMIUM Button	16, 40
Premium Shot.....	38
Privacy Settings.....	36, 59, 76
Protect	65, 77

Q

Quick Menu Display.....	79
Quick Playback Menu.....	36, 75
Quick Shooting Menu	36, 71

R

Rate	32
Rechargeable Battery.....	20, 22
Red-eye Reduction.....	73
Reorder Favorites.....	67, 77
Reset Premium Shot Settings	74
Resize	76
Restore Defaults	74

S

S-Cont	53
Save My Settings: Premium Shots ..	44, 76
Save Premium Shot.....	76
SD Memory Card.....	20, 21, 109
Select info displayed.....	36
Self-timer	30
Self-timer Button.....	16, 30
Self-timer Lamp.....	15
Sepia.....	39
Setup Menu	78
Shake Correction	50, 73
Shooting Menu.....	71
Shutter Release Button	15
Skew Correction	64, 76
Skew Correct Mode.....	39, 42
Sleep Mode	25, 81
Slide Show	77
Snow.....	38
Soft Focus.....	39
Soft Focus Options	73
Speaker	15
Sports.....	38
Subject Tracking.....	49
Super Resolution.....	72
Super Resolution Zoom.....	28
Sweets	38

T

Thumbnail View.....	31
Toy Camera.....	39
Toy Color.....	74
Trim	61, 76
Tripod Screw Hole.....	16

U

USB Cable	14, 23, 84, 90, 94, 96
USB Power Adapter	14, 23

V

Video Out Mode.....	82
Vignetting.....	74
Volume Settings.....	36, 81

W

White Balance	51, 73
---------------------	--------

Z

Zoom.....	28
Zoom Lever	15, 28, 31, 33

Telephone Support Numbers in Europe

UK	(from within the UK) (from outside the UK)	0203 239 6327 +44 203 239 6327
Deutschland	(innerhalb Deutschlands) (außerhalb Deutschlands)	06331 268 438 +49 6331 268 438
France	(à partir de la France) (en dehors de la France)	0800 88 18 70 +33 1 60 60 19 94
Italia	(dall'Italia) (dall'estero)	02 4004 7319 +39 02 4004 7319
España	(desde España) (desde fuera de España)	900984912 +49 6331 268 440

<http://www.service.ricohpmmc.com/>

From environmental friendliness to environmental conservation and to environmental management

Ricoh is aggressively promoting environment-friendly activities and also environment conservation activities to solve the great subject of management as one of the citizens on our precious earth.



To reduce the environmental loads of digital cameras, Ricoh is also trying to solve the great subjects of "Saving energy by reducing power consumption" and "Reducing environment-affecting chemical substances contained in products".

If a problem arises

First of all, see "Troubleshooting" (☞ P.98) in this manual. If the issues still persist, please contact a Ricoh office.

Ricoh Offices	
RICOH COMPANY, LTD.	3-2-3, Shin-Yokohama Kouhoku-ku, Yokohama City, Kanagawa 222-8530, JAPAN http://www.ricoh.com/r_dc/
RICOH AMERICAS CORPORATION	5 Dedrick Place, West Caldwell, New Jersey 07006, U.S.A. 1-800-22RICOH http://www.ricoh-usa.com/
RICOH INTERNATIONAL B.V. (EPMCM)	Oberrather Straße 6, D-40472 Düsseldorf, GERMANY (innerhalb Deutschlands) 06331 268 438 (außerhalb Deutschlands) +49 6331 268 438 http://www.ricoh.com/r_dc/
RICOH ASIA PACIFIC OPERATIONS LIMITED	21/F, One Kowloon, 1 Wang Yuen Street, Kowloon Bay, Hong Kong
About MediaBrowser	
North America (U.S.)	(Toll Free) +1-800-458-4029
Europe	UK, Germany, France and Spain: (Toll Free) +800-1532-4865 Other Countries: +44-1489-564-764
Asia	+63-2-438-0090
China	+86-21-5385-3786
Business hours: 9:00 AM to 5:00 PM	

Ricoh Company, Ltd.
Ricoh Building, 8-13-1, Ginza, Chuo-ku, Tokyo
104-8222, Japan
2011 April



Printed in China



Download from www.Somanuals.com. All Manuals Search And Download. *L762 2971A*

Free Manuals Download Website

<http://myh66.com>

<http://usermanuals.us>

<http://www.somanuals.com>

<http://www.4manuals.cc>

<http://www.manual-lib.com>

<http://www.404manual.com>

<http://www.luxmanual.com>

<http://aubethermostatmanual.com>

Golf course search by state

<http://golfingnear.com>

Email search by domain

<http://emailbydomain.com>

Auto manuals search

<http://auto.somanuals.com>

TV manuals search

<http://tv.somanuals.com>