



OPERATOR'S MANUAL

Random Orbit Sander

Model RS240

DOUBLE INSULATED

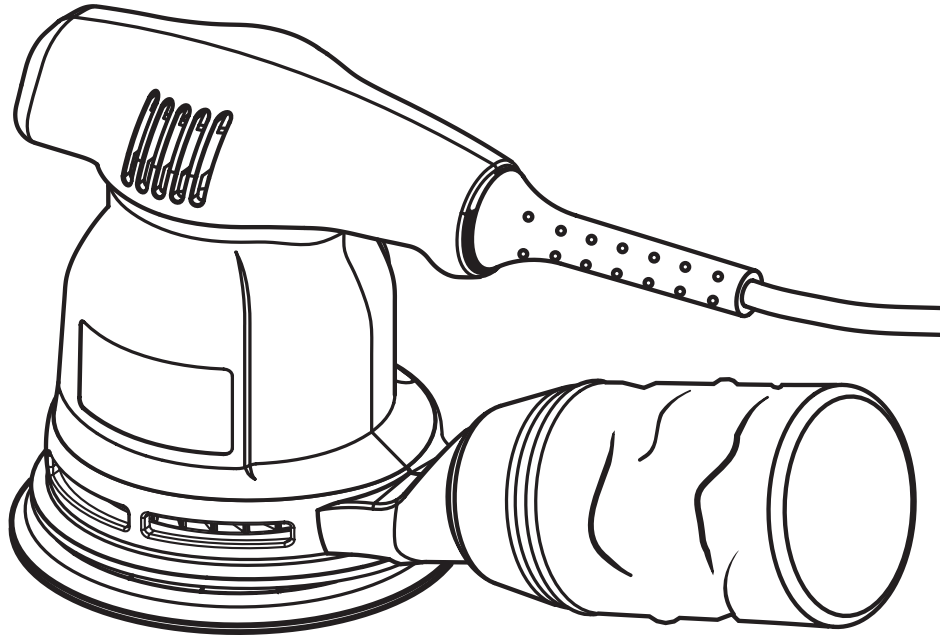

SPECIFICATIONS:

Sanding disc diameter	5 in. (127 mm)
No load speed	12,500 opm
Diameter of orbit	3/32 in. (2.5 mm)
Rating	120 volts, 60 Hz, AC 2.4 Amperes
Net Weight	2.75 lbs.

THANK YOU FOR BUYING A RYOBI RANDOM ORBIT SANDER.

Your new Random Orbit Sander has been engineered and manufactured to Ryobi's high standard for dependability, ease of operation, and operator safety. Properly cared for, it will give you years of rugged, trouble-free performance.

⚠ CAUTION: Carefully read through this entire operator's manual before using your new sander.

Pay close attention to the Rules for Safe Operation, Warnings, and Cautions. If you use your sander properly and only for what it is intended, you will enjoy years of safe, reliable service.

Thank you again for buying Ryobi tools.

SAVE THIS MANUAL FOR FUTURE REFERENCE

TABLE OF CONTENTS

■ Product Specifications	1
■ Table Of Contents	2
■ Rules For Safe Operation	2-4
■ Features	5
■ Unpacking and Operation	6-9
■ Optional Accessories	9
■ Maintenance	10
■ Parts Ordering / Service	12

RULES FOR SAFE OPERATION

The purpose of safety symbols is to attract your attention to possible dangers. The safety symbols, and the explanations with them, deserve your careful attention and understanding. The safety warnings do not by themselves eliminate any danger. The instructions or warnings they give are not substitutes for proper accident prevention measures.

SYMBOL	MEANING
--------	---------



SAFETY ALERT SYMBOL:

Indicates danger, warning, or caution. May be used in conjunction with other symbols or pictographs.



DANGER: Failure to obey a safety warning will result in serious injury to yourself or to others. Always follow the safety precautions to reduce the risk of fire, electric shock and personal injury.



WARNING: Failure to obey a safety warning can result in serious injury to yourself or to others. Always follow the safety precautions to reduce the risk of fire, electric shock and personal injury.



CAUTION: Failure to obey a safety warning may result in property damage or personal injury to yourself or to others. Always follow the safety precautions to reduce the risk of fire, electric shock and personal injury.

NOTE: Advises you of information or instructions vital to the operation or maintenance of the equipment.

DOUBLE INSULATION

Double insulation is a concept in safety, in electric power tools, which eliminates the need for the usual three-wire grounded power cord. All exposed metal parts are isolated from the internal metal motor components with protecting insulation. Double insulated tools do not need to be grounded.



WARNING:

The double insulated system is intended to protect the user from shock resulting from a break in the tool's internal wiring. Observe all normal safety precautions related to avoiding electrical shock.

IMPORTANT

Servicing of a tool with double insulation requires extreme care and knowledge of the system and should be performed only by a qualified service technician. For service we suggest you return the tool to your nearest **RYOBI AUTHORIZED SERVICE CENTER** for repair. When servicing use only identical Ryobi replacement parts.



WARNING:

Do not attempt to operate this tool until you have read thoroughly and understand completely all instructions, safety rules, etc. contained in this manual. Failure to comply can result in accidents involving fire, electric shock, or serious personal injury. Save operator's manual and review frequently for continuing safe operation, and instructing others who may use this tool.

RULES FOR SAFE OPERATION

READ ALL INSTRUCTIONS

1. **KNOW YOUR POWER TOOL.** Read operator's manual carefully. Learn its applications and limitations as well as the specific potential hazards related to this tool.
2. **GUARD AGAINST ELECTRICAL SHOCK** by preventing body contact with grounded surfaces. For example: Pipes, radiators, ranges, refrigerator enclosures.
3. **KEEP GUARDS IN PLACE** and in working order.
4. **KEEP WORK AREA CLEAN.** Cluttered areas and benches invite accidents.
5. **AVOID DANGEROUS ENVIRONMENT.** Don't use power tool in damp or wet locations or expose to rain. Keep work area well lit.
6. **KEEP CHILDREN AND VISITORS AWAY.** All visitors should wear safety glasses and be kept a safe distance from work area. Do not let visitors contact tool or extension cord.
7. **STORE IDLE TOOLS.** When not in use tools should be stored in a dry and high or locked-up place - out of the reach of children.
8. **DON'T FORCE TOOL.** It will do the job better and safer at the rate for which it was designed.
9. **USE RIGHT TOOL.** Don't force small tool or attachment to do the job of a heavy duty tool. Don't use tool for purpose not intended - for example - A circular saw should never be used for cutting tree limbs or logs.
10. **WEAR PROPER APPAREL.** Do not wear loose clothing or jewelry that can get caught in the tool's moving parts and cause personal injury. Rubber gloves and nonskid footwear are recommended when working outdoors. Wear protective hair covering to contain long hair and keep it from being drawn into nearby air vents.
11. **ALWAYS WEAR SAFETY GLASSES.** Everyday eyeglasses have only impact-resistant lenses; they are **NOT** safety glasses.
12. **PROTECT YOUR LUNGS.** Wear a face or dust mask if operation is dusty.
13. **PROTECT YOUR HEARING.** Wear hearing protection during extended periods of operation.
14. **DON'T ABUSE CORD.** Never carry tool by cord or yank it to disconnect from receptacle. Keep cord from heat, oil and sharp edges.
15. **SECURE WORK.** Use clamps or a vise to hold work. It's safer than using your hand and it frees both hands to operate the tool.
16. **DON'T OVERREACH.** Keep proper footing and balance at all times. Do not use while standing on a ladder or unstable support.
17. **MAINTAIN TOOLS WITH CARE.** Keep tools sharp at all times, and clean for best and safest performance. Follow instructions for lubricating and changing accessories.
18. **DISCONNECT TOOLS.** When not in use, before servicing, or when changing or adjusting attachments, blades, bits, cutters, sandpaper, etc., all tools should be disconnected from power supply.
19. **REMOVE ADJUSTING KEYS AND WRENCHES.** Form habit of checking to see that keys and adjusting wrenches are removed from tool before turning it on.
20. **AVOID ACCIDENTAL STARTING.** Don't carry plugged-in tools with finger on switch. Be sure switch is off when plugging in.
21. **MAKE SURE YOUR EXTENSION CORD IS IN GOOD CONDITION.** When using an extension cord, be sure to use one heavy enough to carry the current your product will draw. An undersized cord will cause a drop in line voltage resulting in loss of power and overheating. A wire gage size (A.W.G.) of at least 16 is recommended for an extension cord 100 feet or less in length. A cord exceeding 100 feet is not recommended. If in doubt, use the next heavier gage. The smaller the gage number, the heavier the cord.



Look for this symbol to point out important safety precautions. It means attention!!! Your safety is involved.

RULES FOR SAFE OPERATION

22. **OUTDOOR USE EXTENSION CORDS.** When tool is used outdoors, use only extension cords suitable for use outdoors. Outdoor approved cords are marked with the suffix W-A, for example - SJTW-A or SJOW-A.
23. **NEVER USE THIS OR ANY POWER SANDER FOR WET SANDING OR LIQUID POLISHING.** Failure to comply can result in electrical shock causing serious injury or worse.
24. **KEEP HANDS AWAY FROM SANDING AREA.**
25. **NEVER USE IN AN EXPLOSIVE ATMOSPHERE.** Normal sparking of the motor could ignite fumes.
26. **INSPECT TOOL CORDS PERIODICALLY** and if damaged, have repaired at your nearest authorized service center. Stay constantly aware of cord location.
27. **INSPECT EXTENSION CORDS PERIODICALLY** and replace if damaged.
28. **KEEP HANDLES DRY, CLEAN, AND FREE FROM OIL AND GREASE.** Always use a clean cloth when cleaning. Never use brake fluids, gasoline, petroleum-based products or any strong solvents to clean your tool.
29. **STAY ALERT.** Watch what you are doing and use common sense. Do not operate tool when you are tired. Do not rush.
30. **CHECK DAMAGED PARTS.** Before further use of the tool, a guard or other part that is damaged should be carefully checked to determine that it will operate properly and perform its intended function. Check for alignment of moving parts, binding of moving parts, breakage of parts, mounting, and any other conditions that may affect its operation. A guard or other part that is damaged should be properly repaired or replaced by an authorized service center unless indicated elsewhere in this instruction manual.
31. **DO NOT USE TOOL IF SWITCH DOES NOT TURN IT ON AND OFF.** Have defective switches replaced by an authorized service center.
32. **INSPECT FOR** and remove all nails from lumber before sanding.
33. **DRUGS, ALCOHOL, MEDICATION.** Do not operate tool while under the influence of drugs, alcohol, or any medication.
34. **WHEN SERVICING USE ONLY IDENTICAL RYOBI REPLACEMENT PARTS.**
35. **MAKE THE WORKSHOP CHILD-PROOF** with padlocks, master switches, or by removing starter keys.
36. **POLARIZED PLUGS.** To reduce the risk of electric shock, this tool has a polarized plug (one blade is wider than the other). This plug will fit in a polarized outlet only one way. If the plug does not fit fully in the outlet, reverse the plug. If it still does not fit, contact a qualified electrician to install the proper outlet. Do not change the plug in any way.
37. **SAVE THESE INSTRUCTIONS.** Review them frequently and use them to instruct others who may use this tool. If you loan someone this tool, loan them these instructions also.



WARNING:

Some dust created by power sanding, sawing, grinding, drilling, and other construction activities contains chemicals known to cause cancer, birth defects or other reproductive harm. Some examples of these chemicals are:

- lead from lead-based paints,
- crystalline silica from bricks and cement and other masonry products, and
- arsenic and chromium from chemically-treated lumber.

Your risk from these exposures varies, depending on how often you do this type of work. To reduce your exposure to these chemicals: work in a well ventilated area, and work with approved safety equipment, such as those dust masks that are specially designed to filter out microscopic particles.

FEATURES

KNOW YOUR SANDER

See Figure 1.

Before attempting to use your sander, familiarize yourself with all operating features and safety requirements.



WARNING:

If any parts are missing do not operate your sander until the missing parts are replaced. Failure to do so could result in possible serious injury.

SWITCH

This tool is equipped with a simple switch control. To turn your sander **ON**, depress the switch button as shown in Figure 1. Depress the switch button in the opposite direction to turn your sander **OFF**.

Your sander has a comfortable palm grip that provides easy handling and positive control and is suitable for sanding with coarse, medium, and fine grit sanding disc.

CONVERSION PAD

Converts the standard sanding pad from use with pressure sensitive sanding discs for use with velcro type sanding discs.

RANDOM ORBIT

The random orbit motion provides overlapping sanding movements by combining orbital and turning motion. These overlapping sanding movements provide fast cutting action with excellent sanding results.

ELECTRICAL CONNECTION

Your sander has a precision built electric motor. It should be connected to a **power supply that is 120 volts, 60 Hz, AC only (normal household current)**. Do not operate this tool on direct current (DC). A substantial voltage drop will cause a loss of power and the motor will overheat. If your tool does not operate when plugged into an outlet, double-check the power supply.



WARNING:

Do not allow familiarity with your sander to make you careless. Remember that a careless fraction of a second is sufficient to inflict severe injury.

APPLICATIONS

(Use only for the purposes listed below)

- Sanding on wood surfaces.
- Removing rust from and sanding steel surfaces.

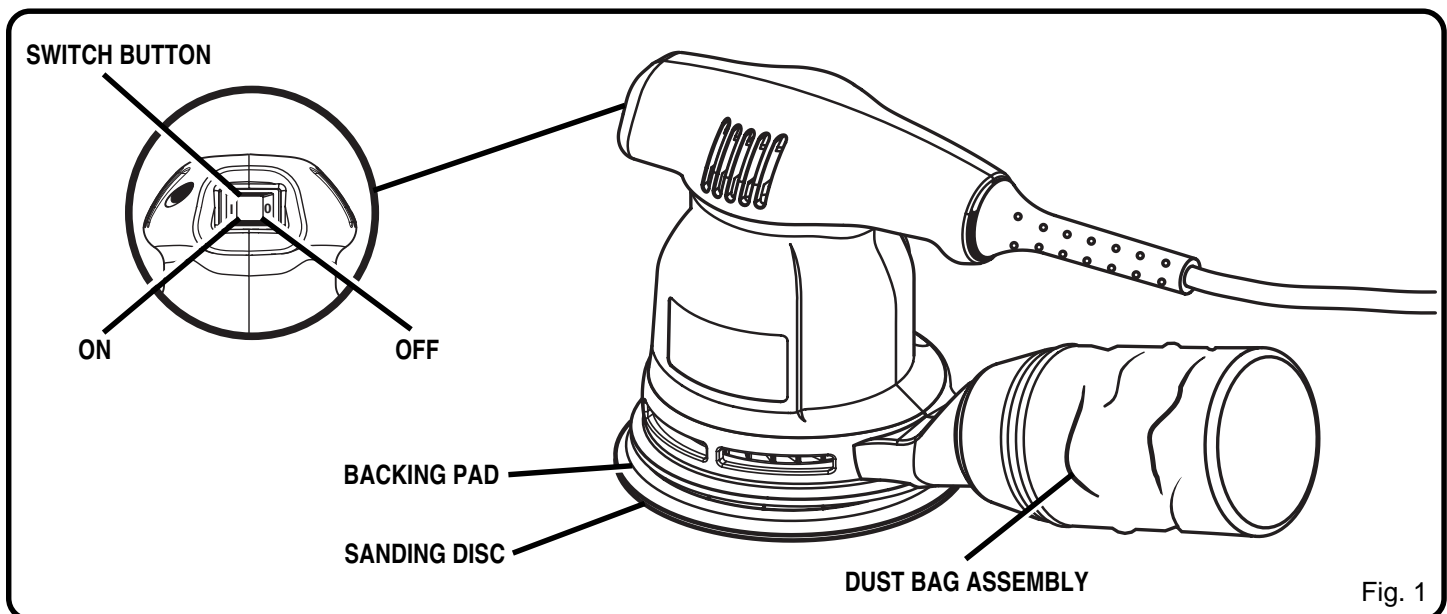

Fig. 1



WARNING:



The operation of any sander can result in foreign objects being thrown into your eyes, which can result in severe eye damage. Before beginning power tool operation, always wear safety goggles or safety glasses with side shields and a full face shield when needed. We recommend Wide Vision Safety Mask for use over eyeglasses or standard safety glasses with side shields.

UNPACKING

- Carefully remove the sander, and accessories from box. Make sure all items listed in the Packing List are included.
- Do not discard the packing material until you have carefully inspected and satisfactorily operated sander.
- Examine all parts and accessories to make sure that no breakage has occurred during shipping. Any damaged part should be replaced before attempting to use the tool.

PACKING LIST

Sanding Disc (quantity 3)
Conversion Pad (for velcro type sanding discs)
Dust Bag Assembly
Warranty Card
Operator's Manual

OPERATION

The backing pad on your sander provides the capability to use sanding discs with pressure sensitive adhesive backing material. You also receive a conversion pad which allows use of sanding discs with velcro type backing material.

WARNING:

Your sander should never be connected to power supply when you are assembling parts, making adjustments, assembling or replacing sanding disc, cleaning, or when not in use. Disconnecting your sander will prevent accidental starting that could cause serious personal injury.

TO ATTACH PRESSURE SENSITIVE ADHESIVE SANDING DISC

See Figure 2.

- Unplug your sander.

WARNING:

Failure to unplug your sander could result in accidental starting causing possible serious personal injury.

- Carefully peel paper backing from the pressure sensitive adhesive type sanding disc.
- Align holes in sanding disc with holes in backing pad, then carefully press sticky side of disc against pad as tight as possible.

NOTE: Holes in sanding disc must line up with holes in the backing pad in order for the dustless feature of your sander to function properly.

NOTE: It is recommended that you clean backing pad occasionally by brushing lightly with a small brush. Dust build-up on backing pad could cause sanding disc not to stick properly.

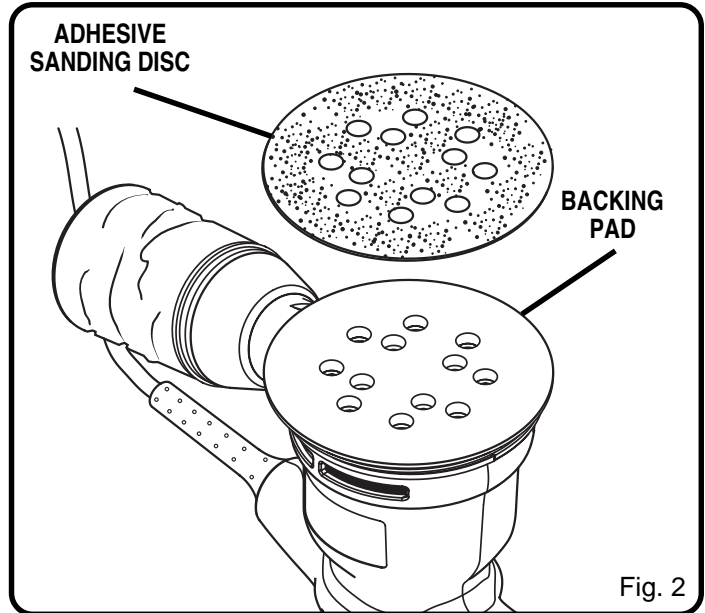

SANDING DISC SELECTION

Selecting the correct size grit and type sanding disc is an extremely important step in achieving a high quality sanded finish. Aluminum oxide, silicon carbide, and other synthetic abrasives are best for power sanding. Natural abrasives, such as flint and garnet are too soft for economical use in power sanding.

In general, coarse grit will remove the most material and finer grit will produce the best finish in all sanding operations. The condition of the surface to be sanded will determine which grit will do the job. If the surface is rough, start with a coarse grit and sand until the surface is uniform. Medium grit may then be used to remove scratches left by the coarser grit and finer grit used for finishing of the surface. Always continue sanding with each grit until surface is uniform.

OPERATION

REMOVING SANDING DISC BEFORE STORAGE

Do not store your sander with the sanding disc installed. Heat generated from sanding causes the pressure sensitive adhesive to flow and form a tight bond between the backing pad and sanding disc.

Removing the sanding disc soon after you have finished a sanding operation avoids letting the adhesive set up. If the sanding disc is left on the backing pad for an extended period of time after use, the adhesive will set up and cause the sanding disc to become difficult to remove.

It may also tear when removing. When this situation occurs, it becomes difficult to clean the backing pad for the next sanding disc.

NOTE: If you forget to remove the sanding disc after a sanding operation, sand for a few minutes to soften the adhesive backing before attempting to remove sanding disc.

TO ATTACH CONVERSION PAD AND VELCRO TYPE SANDING DISC

The conversion pad provided with your sander has a pressure sensitive adhesive backing material. It is applied by the same method as pressure sensitive adhesive paper.

- Unplug your sander.



WARNING:

Failure to unplug your sander could result in accidental starting causing possible serious personal injury.

- Carefully peel paper backing from the conversion pad and align with holes in backing pad. Firmly press sticky side of conversion pad against backing pad. Your sander is now ready to use velcro type sanding discs.
- Align holes in velcro type sanding disc with holes in conversion pad, then carefully press fuzzy side of sanding disc against pad as tight as possible.

NOTE: Velcro type sanding discs can be reused for the life of the sanding abrasive. It is recommended that you keep the sanding disc backing and the conversion pad clean to provide the best attachment. Clean occasionally by brushing lightly with a small brush.

DUSTLESS SANDING

See Figures 3 and 4.

The dust bag assembly provides a dust collection system for your sander. It can be installed by slipping it over the blower exhaust with a twisting motion. Sanding dust is drawn up through the holes of the sanding disc to collect in the dust bag during sanding operation.

NOTE: For more efficient operation, empty dust bag when no more than half full. This will permit the air to flow through the bag better.



WARNING:

To prevent the possibility of sanding dust or foreign objects being thrown into your face or eyes, never attempt to use your sander without the dust bag properly installed. Sanding dust or foreign objects being thrown into your face could result in possible serious personal injury.

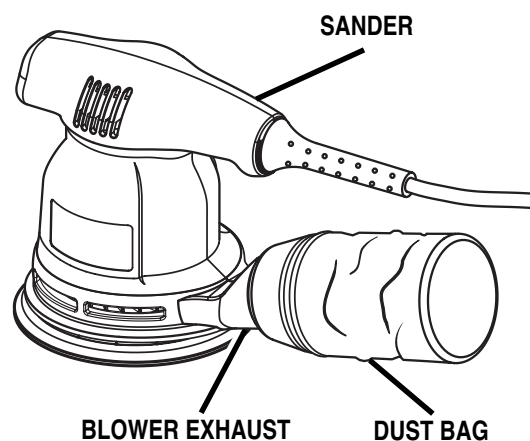

Fig. 3

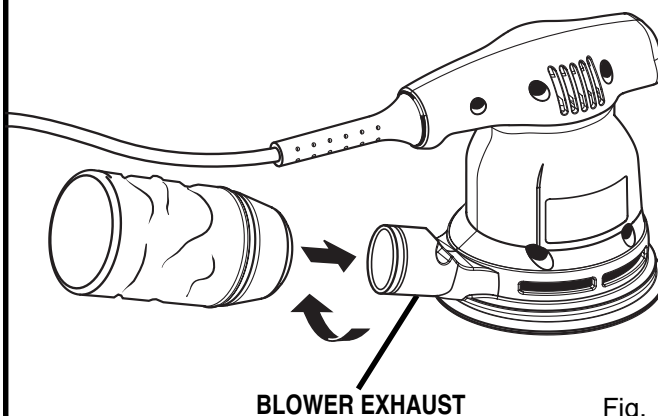

Fig. 4

OPERATION

ATTACHING SANDER TO VACUUM

When sanding for an extended period of time, you can easily attach the dust collection system of your sander to a vacuum.

TO ATTACH:

See Figure 5.

- **Unplug your sander.**

WARNING:

Failure to unplug your sander could result in accidental starting causing possible serious personal injury.

- Remove dust bag from sander.
- Attach vacuum hose to blower exhaust as shown in Figure 5.

NOTE: Vacuum hose fits inside blower exhaust.

- Connect sander and vacuum to power supply.

WARNING:

When sander is not connected to vacuum, always install dust bag back on sander. Failure to do so could cause sanding dust or foreign objects to be thrown into your face or eyes which could result in possible serious injury.

EXTENSION CORDS

The use of any extension cord will cause some loss of power. To keep the loss to a minimum and to prevent tool from overheating, use an extension cord that is heavy enough to carry the current the tool will draw.

A wire gage size (A.W.G.) of at least **16** is recommended for an extension cord 100 feet or less in length. When working outdoors, use an extension cord that is suitable for outdoor use. The cord's jacket will be marked **WA**.

CAUTION:

Keep extension cords away from the sanding area and position the cord so that it will not get caught on lumber, tools, etc., during sanding.

WARNING:

Check extension cords before each use. If damaged replace immediately. Never use tool with a damaged cord since touching the damaged area could cause electrical shock resulting in serious injury.

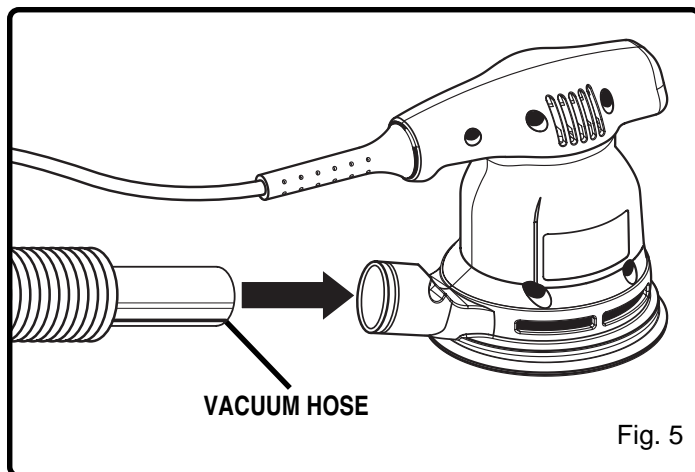

WARNING:

Do not use this product as a component of other products. Also, do not use attachments or accessories not recommended for use with this product. Any such use could result in possible serious personal injury.

CAUTION:

To ensure proper brake operation after extended use, periodically check its operation by removing the sanding disc and running your sander without load (off the workpiece). The backing pad should not take longer than 6 seconds to stop. If it takes longer than 6 seconds to stop, return the sander to your nearest **RYOBI AUTHORIZED SERVICE CENTER** for repair.

WARNING:

Do not wear loose clothing or jewelry when operating sander. They could get caught in moving parts causing serious injury. Keep head away from sander and sanding area. Hair could be drawn into sander causing serious injury.

WARNING:

Before connecting your sander to power supply source, always check to be sure the switch is not in **ON** position. Failure to do so could result in accidental starting of your sander resulting in possible serious injury.

OPERATION

PREPARING FOR OPERATION



CAUTION:

Be careful not to let your hand cover the air vents.

SANDING

See Figures 6 and 7.

Clamp or otherwise secure the work to prevent it from moving under your sander.



WARNING:

Unsecured work could be thrown towards the operator causing injury.

Place sander on workpiece so that all of sanding disc surface is in contact with workpiece. Start your sander and move it slowly over workpiece making successive passes in parallel lines, circles, or crosswise movements. Upon completion of sanding operation, turn sander off and wait until sanding disc comes to a complete stop before removing from workpiece.

DO NOT FORCE. The weight of the unit supplies adequate pressure, so let the sanding disc and sander do the work. Applying additional pressure only slows the motor, rapidly wears sanding disc and greatly reduces sander speed. Excessive pressure will overload the motor causing possible damage from motor overheating and can result in inferior work. Any finish or resin on wood may soften from the frictional heat. Do not allow sanding on one spot too long as the sander's rapid action may remove too much material, making the surface uneven.

Extended periods of sanding may tend to overheat the motor. If this occurs, turn sander off and wait until sanding disc comes to a complete stop, then remove it from workpiece. Remove your hand from vent area, remove sanding disc, then with your hand removed from vent area, turn sander on and run it free without a load to cool motor.

Flush sanding can be performed with your sander. As shown in Figure 7, the front edge of your sander allows flush sanding. Upon completion of sanding operation, turn sander off and wait until sanding disc comes to a complete stop before removing from workpiece.

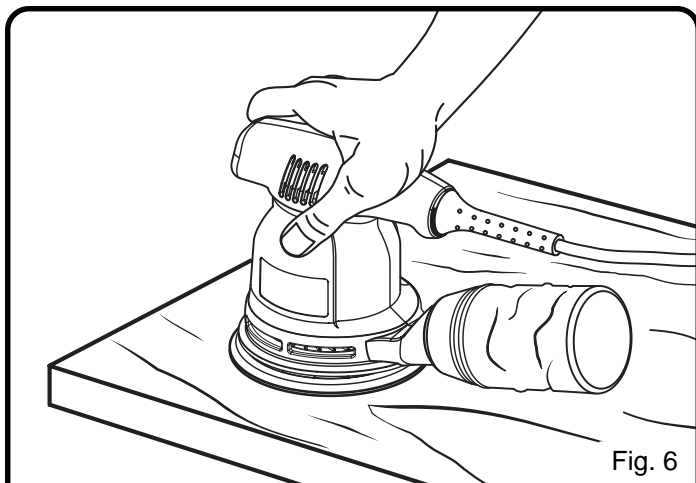

Fig. 6

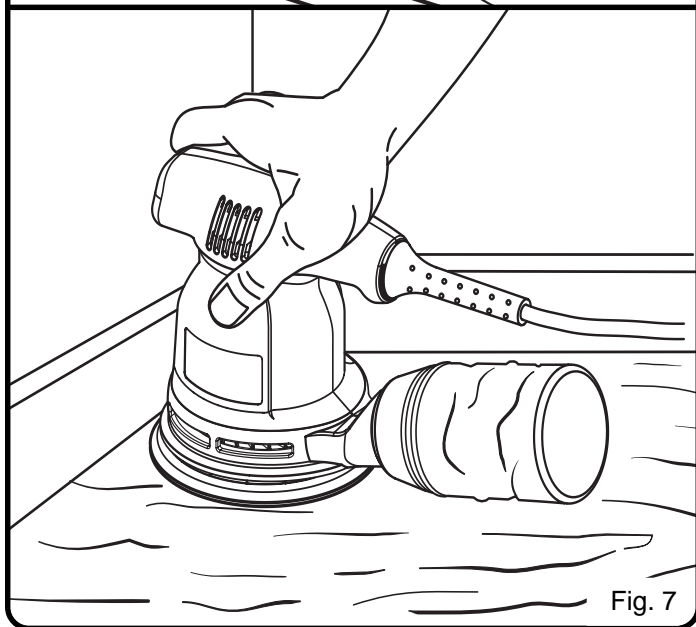

Fig. 7

OPTIONAL ACCESSORIES

The following recommended accessories are current and were available at the time this manual was printed:

4601500	15 Grit Sanding Disc	5 Per Pack	4600150	150 Grit Sanding Disc	5 Per Pack
4600040	40 Grit Sanding Disc	5 Per Pack	4600220	220 Grit Sanding Disc	5 Per Pack
4600060	60 Grit Sanding Disc	5 Per Pack	4600320	320 Grit Sanding Disc	5 Per Pack
4600080	80 Grit Sanding Disc	5 Per Pack	4600600	600 Grit Sanding Disc	5 Per Pack
4600100	100 Grit Sanding Disc	5 Per Pack	4600503	Conversion Pad	2 Per Pack

All individual sanding grits are available in handy five sheet packs.

MAINTENANCE

WARNING:

When servicing use only identical Ryobi replacement parts. Use of any other parts may create a hazard or cause product damage.

CLEANING DUST BAG ASSEMBLY

See Figures 8 and 9.

As previously mentioned, for more efficient operation, empty dust bag when no more than half full. This will permit the air to flow through the bag better.

TO EMPTY DUST BAG:

- **Unplug your sander.**

WARNING:

Failure to unplug your sander could result in accidental starting causing possible serious personal injury.

- Remove dust bag from sander and shake out dust. See Figure 8.
- For a more thorough cleaning of the dust bag, remove dust bag from frame, as shown in figure 9, and shake out dust.
- Replace dust bag over frame then install dust bag on sander.

GENERAL

Avoid using solvents when cleaning plastic parts. Most plastics are susceptible to damage from various types of commercial solvents and may be damaged by their use. Use clean cloths to remove dirt, carbon dust, etc.

WARNING:

Do not at any time let brake fluids, gasoline, petroleum-based products, penetrating oils, etc. come in contact with plastic parts. They contain chemicals that can damage, weaken, or destroy plastic.

When electric tools are used on fiberglass boats, sports cars, wallboard, spackling compounds, or plaster, it has been found that they are subject to accelerated wear and possible premature failure, as the fiberglass chips and grindings are highly abrasive to bearings, brushes, commutators, etc. Consequently, it is not recommended that this tool be used for extended work on any fiberglass material, wallboard, spackling compounds, or plaster. During any use on fiberglass it is extremely important that the tool is cleaned frequently by blowing with an air jet.

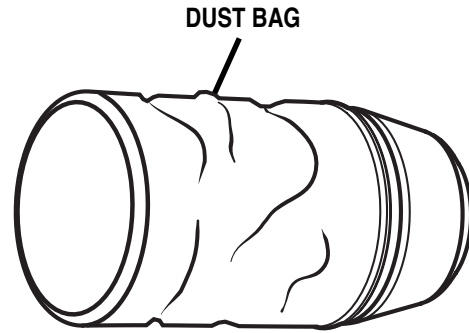

Fig. 8

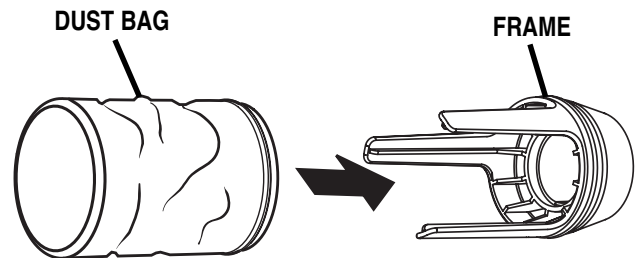

Fig. 9

WARNING:

Always wear safety goggles or safety glasses with side shields during power tool operation or when blowing dust. If operation is dusty, also wear a dust mask.

LUBRICATION

All of the bearings in this tool are lubricated with a sufficient amount of high grade lubricant for the life of the unit under normal operating conditions. Therefore, no further lubrication is required.



OPERATOR'S MANUAL

Random Orbit Sander

Model RS240

Double Insulated

EXTENSION CORD CAUTION

When using a power tool at a considerable distance from a power source, be sure to use an extension cord that has the capacity to handle the current the tool will draw. An undersized cord will cause a drop in line voltage, resulting in overheating and loss of power. Use the chart to determine the minimum wire size required in an extension cord. Only round jacketed cords should be used.

When working with a tool outdoors, use an extension cord that is designed for outside use. This is indicated by the letters "WA" on the cord's jacket.

Before using any extension cord, inspect it for loose or exposed wires and cut or worn insulation.

**Ampere rating

(on tool data plate) 0-2.0 2.1-3.4 3.5-5.0 5.1-7.0 7.1-12.0 12.1-16.0

Cord Length	Wire Size (A.W.G.)					
25'	16	16	16	16	14	14
50'	16	16	16	14	14	12
100'	16	16	14	12	10	—

CAUTION:

Keep the extension cord clear of the working area. Position the cord so that it will not get caught on workpiece, tools, or other obstructions while you are working with a power tool.

***Used on 12 gauge - 20 amp circuit.*

• SERVICE

Now that you have purchased your tool, should a need ever exist for repair parts or service, simply contact your nearest Ryobi Authorized Service Center. Be sure to provide all pertinent facts when you call or visit. Please refer to the Service Center insert or call 1-800-525-2579 in the United States or 1-800-265-6778 in Canada for your nearest Ryobi Authorized Service Center.

• MODEL NO. AND SERIAL NO.

The model number and serial number of this tool will be found on a plate attached to the motor housing.

Please record the serial number in the space provided below.

- MODEL NUMBER RS240
- SERIAL NUMBER _____

RYOBI AMERICA CORP.

1424 Pearman Dairy Road Anderson, SC 29625
 Post Office Box 1207 Anderson, SC 29622-1207
 Phone 1-800-525-2579

RYOBI CANADA INC.

Post Office Box 910
 Cambridge, Ontario N1R 6K2
 Phone 1-800-265-6778

Free Manuals Download Website

<http://myh66.com>

<http://usermanuals.us>

<http://www.somanuals.com>

<http://www.4manuals.cc>

<http://www.manual-lib.com>

<http://www.404manual.com>

<http://www.luxmanual.com>

<http://aubethermostatmanual.com>

Golf course search by state

<http://golfingnear.com>

Email search by domain

<http://emailbydomain.com>

Auto manuals search

<http://auto.somanuals.com>

TV manuals search

<http://tv.somanuals.com>