

"RS232/ASCII" communication system

Installation and user manual

English

Français

APC[®]

by Schneider Electric

 **i**

English version 1

Version française 7

5102907300-AE

990-5102907300AE



by Schneider Electric

Safety guidelines

If you encounter a problem while following the instructions in this manual, we recommend that you contact our after-sales support service.

On request, our after-sales support personnel can carry out the complete installation of your equipment.



It is imperative that the instructions in this manual be followed strictly.

Not adhering to these instructions may endanger personnel, result in damage to the UPS and render the manufacturer's warranty void.

All repair or maintenance operations must be carried out by our after-sales support personnel.

For more information on the **UPS**, please refer to its "installation and user manual". The **RS232/ASCII** option may be installed and operated by any person as long as the indications presented in this manual are complied with.

Consignes de sécurité

Si vous rencontrez un problème en suivant les procédures décrites dans ce manuel, nous vous recommandons de consulter notre service après-vente.

Si vous le souhaitez, ce service pourra se charger de l'installation de votre matériel.



Il est impératif de suivre rigoureusement les procédures décrites dans ce manuel.

Le non respect de ces procédures peut entraîner des dangers pour les personnes, occasionner des dommages sur l'ASI et annuler la garantie constructeur.

Toute opération de dépannage ou de maintenance doit être effectuée par nos services.

Pour plus de détails concernant l'**ASI**, se référer au "manuel d'installation et d'utilisation" fourni avec l'appareil. L'installation et l'exploitation du système de communication **RS232/ASCII** peut être réalisée par toute personne se conformant aux indications portées dans le présent manuel.

Sicherheitshinweise

Sollte es Probleme bei der Installation oder Mißverständnisse in dieser Anleitung geben, setzen Sie sich bitte mit dem APC by Schneider Electric Kundendienst in Verbindung.



Es ist wichtig, die Einzelschritte dieser Anleitung zu befolgen.

Ein Nichtbeachten kann zu Gefährdung von Personen, Schäden an der Anlage, sowie dem Verlust der Herstellergarantie führen.

Arbeiten, die das Öffnen der Geräte notwendig machen, dürfen nur von Elektro-Fachpersonal durchgeführt werden.

Für weitergehende Informationen zur **USV**-Anlage möchten wir auf die Bedienungs- und Installationsanleitung **USV** hinweisen. Die Installation und Nutzung des **RS232/ASCII** Kommunikationssystems kann von jeder Person vorgenommen werden, die sich an die Anweisungen des vorliegenden Handbuchs hält.

Consegne di sicurezza

Se incontrate difficoltà seguendo le procedure descritte in questo libretto, noi vi raccomandiamo di consultare il nostro servizio assistenza dopo vendita. Se lo desiderate, questo servizio potrà incaricarsi dell'installazione del vostro materiale.



E' imperativo seguire rigorosamente le procedure descritte in questo libretto. Se non si rispettano queste procedure puo' essere pericoloso per le persone, cagionare danni su ASI ed annullare la garanzia del costruttore. Tutte le operazioni di riparazione o di manutenzione devono essere effettuate dai nostri servizi.

Per maggiori dettagli concernente l'**UPS**, riferirsi al "libretto d'installazione e d'istruzioni" fornito con questo apparecchio. L'installazione e l'esercizio del sistema di comunicazione **RS232/ASCII** possono essere realizzati da un qualsiasi addetto, a condizione che vengano rispettate le indicazioni riportate nel presente manuale.

Consignas de seguridad

Si ocurre un problema al poner en práctica los procedimientos descritos en este manual, le recomendamos consultar nuestro servicio de postventa. Si así lo desea, este servicio podrá encargarse de la instalación de su equipo.



Es imperativo respetar rigurosamente los procedimientos descritos en este manual. No respetar estos procedimientos puede acarrear peligro para las vidas humanas, ocasionar perjuicios a SAI y anular la garantía del fabricante. Toda operación de reparación o mantenimiento debe ser efectuada por nuestros servicios.

Para mayores detalles sobre el **SAI**, consultar el "manual de instalación e instrucciones" suministrado con el aparato. La instalación y la explotación del sistema de comunicación **RS232/ASCII** puede ser realizado por cualquier persona que responda a las indicaciones específicas del presente manual.

Regras de segurança

Caso algum problema se apresente durante a execução dos procedimentos descritos neste manual, recomendamos consultar nosso serviço após venda. Este serviço poderá se encarregar da instalação do seu material, se você quiser.



É imperativo que os procedimentos descritos neste manual sejam seguidos rigorosamente. O desrespeito dos mesmos procedimentos pode ocasionar perigos para as pessoas, causar avarias no aparelho, e anular a garantia do fabricante. Toda operação de conserto ou de manutenção deve ser efetuada por nossos serviços.

Para mais detalhes concernentes ao aparelho, referir-se ao "manual de instalação e de utilização" fornecido com o aparelho. A instalação e a exploração do sistema de comunicação **RS232/ASCII** podem ser realizadas por qualquer pessoa que siga as instruções do presente manual.

Veiligheidsvoorschriften

Indien u een probleem mocht tegenkomen terwijl u de handleiding doorneemt, kunt u het beste contact opnemen met onze service afdeling. Op verzoek kan ons after sales support personeel de complete installatie van uw unit verzorgen.



Het is noodzakelijk dat u de instructies in deze handleiding strikt opvolgt. Het niet opvolgen van deze instructies kan het personeel in gevaar brengen, resulteren in schade aan de UPS en de garantie komt te vervallen. Alle reparatie- en onderhoudswerkzaamheden moeten uitgevoerd worden door ons service personeel.

Voor meer informatie betreffende de **UPS**, zie de "installatie- en gebruikershandleiding". Het **RS232/ASCII**-communicatiesysteem kan worden geïnstalleerd en gebruikt door elke persoon die de instructies uit deze handleiding strikt inachtneemt.

Sikkerhedsforskrifter

Pas på !
Skulle De støde på problemer under benyttelsen af apparatet, til trods for at De har fulgt anvisningerne i vores instruktionsbog, bør De henvende Dem til vores kundeservice. Hvis De ønsker det, kan vore teknikere foretage installationen af vore apparater.



Det er absolut nødvendigt at følge anvisningerne i instruktionsbogen. Hvis De ikke overholder dem, risikerer De at udsætte Deres personal for fare, at apparatet bliver beskadiget, og at garantien i så fald bortfalder. Reparation og vedligeholdelse bør kun foretages af vore teknikere.

Ønsker De mere detaljerede oplysninger vedrørende apparatet, kan De finde dem i vores instruktionsbog, som bliver leveret sammen med apparatet. Installeringen og brugen af kommunikationssystemet **RS232/ASCII** kan foretages af enhver der følger anvisningerne I denne manual.

Sikkerhedsforskrifter

Dersom det oppstår problemer under utførelsen av operasjonene som er beskrevet i håndboken, bør du ta kontakt med vår serviceavdeling. Om ønskelig kan vårt servicepersonale utføre installeringen.



Det er ytterst viktig at du følger fremgangsmåten som er beskrevet i håndboken, til punkt og prikke. Operasjoner utført i strid med disse retningslinjene kan forårsake personskader eller skader på apparatet og annullere fabrikantens garanti. Alle reparasjons- og vedlikeholdsinngrep må utføres av vårt servicepersonale.

Trenger du flere opplysninger om apparatet, kan du slå opp i "Håndbok for installering og bruk" som følger med apparatet. Installasjon og bruk av kommunikasjonssystemet **RS232/ASCII** kan utføres av alle som følger anvisningene i gjeldende håndbok.

Säkerhetsföreskrifter

Om Du stöter på problem vid tillämpningen av de instruktioner som beskrivs i bruksanvisningen, rekommenderar vi att Du kontaktar vår serviceverkstad.

Om så önskas kan personal från denna utföra installationen.



Det är mycket viktigt att Du noggrant följer instruktionerna i denna bruksanvisning.

Om instruktionerna inte följs kan materialet skadas och bli farlig att använda. Dessutom upphör tillverkarens garanti att gälla.

Reparationer och underhåll får endast utföras av kvalificerad fackman.

Mer utförlig information om materialet hittar Du i bruksanvisningen för installation och användning.

Installation och nyttjande av kommunikationssystemet **RS232/ASCII** kan genomföras av var och en som följer bruksanvisningen.

Turvallisuusohjeet

Jos törmäätte ongelmiin seuratessanne käsikirjassa kuvattuja toimintaohjeita, suosittelemme huoltopalvelumme puoleen kääntymistä.

Halutessanne voimme myös hoitaa laitteistonne koko asennuksen.



On ehdottoman tärkeää seurata tarkkaan käsikirjassa kuvattuja toimintaohjeita.

Laiminlyönti saattaa aiheuttaa henkilölle vaaratilanteen, laite voi vaurioitua ja rakentajan takuu peruuntua.

Kaikki korjaus- ja huoltotoimet on suoritettava oman henkilökuntamme kautta.

Laite mukana tulevasta "asentamista ja käyttöä käsittelevästä käsikirjasta" löydätte lisätietoja laitteesta.

RS232/ASCII-viestintäjärjestelmän saa asentaa ja sitä saa käyttää kuka tahansa, jos kyseinen henkilö noudattaa tämän käsikirjan ohjeita.

Contents

Description	
Checking	2
Storage	2
Packing	2
Function	2
Overview	3
Configuration of the RS232/ASCII card	
Configuration of RS232 link direction on channel J3	4
Configuration of RS232 link direction on channel J4	4
Choosing the "Plug&Play detection" or "information operation on mains 2" mode on channel J3	4
Choosing the "Plug&Play detection" or "information operation on mains 2" mode on channel J4	4
Installation / startup	5
Connecting status information and RS232 links	6

All APC by Schneider Electric products are protected by patents. They implement original technology which is not available to other competitors of APC by Schneider Electric.

To take evolving standards and technology into account, the technical characteristics contained in this document are not binding unless confirmed by APC by Schneider Electric.

This document may be reproduced only with the consent of APC by Schneider Electric.
Authorised copies must be marked "APC by Schneider Electric **RS232/ASCII** communication system installation and operating manual n° 51029073XT".

Description

Checking

The option you have purchased is made up of the following items:

- ▶ an installation and user manual for the **RS232/ASCII** communication system;
- ▶ an **RS232/ASCII** communication card;
- ▶ an serial RS232 DB9/DB9 communication cable compatible with "Plug&Play" Microsoft™;
- ▶ two screws for fixing the **RS232/ASCII** communication card on the UPS.

Storage

If the equipment is stored before use, leave your communication card in its original packing in a dry place (storage temperature: -40°C to +70°C).

Packing

Comply with current legislation regarding disposal of packing material.

Function

The **RS232/ASCII** communication card enables transmission to a computer tool of a set of data concerning UPS (Uninterruptible Power Supply) operating status. It is equipped with two communication channels which can be used simultaneously but completely independently from one another. It complies with the Microsoft™ "Plug&Play" standard for PC peripheral identification.

Both communication ports issue information in the form of an **RS232** serial link, supported by APC by Schneider Electric's own communication protocol. The software contained in **Solution-Pac**™ enable use of the data supplied by this protocol.

Both communication ports also issue the following information on the DB9 connector pins (see figure 2, page 12):

- ▶ operation on mains (as opposed to battery);
- ▶ operation on mains 2 (static switch or manual bypass);
- ▶ low battery warning;
- ▶ operation on UPS;
- ▶ operation on battery.

Overview

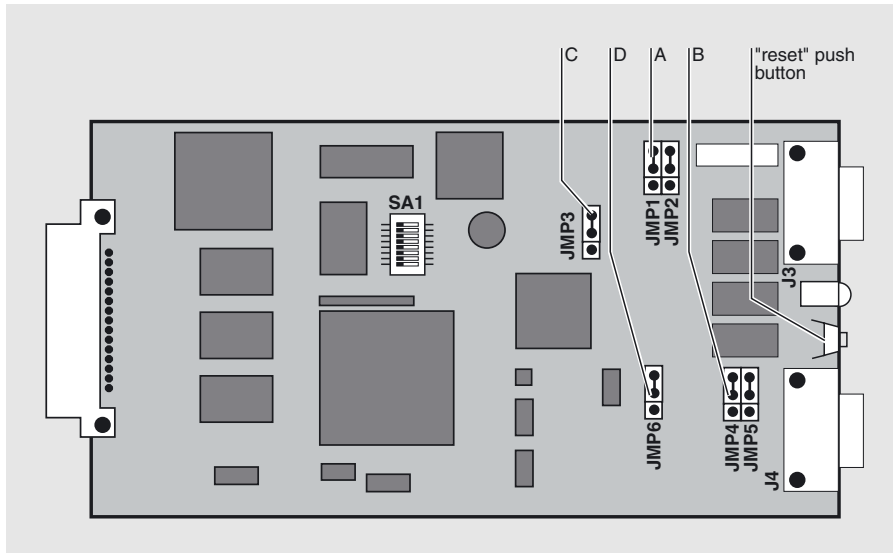

Fig. 1

Configuration of the RS232/ASCII card

Before fitting the card in its slot, you must set the parameters for the operating mode of channels J3 and J4 according to the applications connected.

The following configuration operations are possible:

- ▶ position of the Rx reception and Tx transmission signals;
- ▶ selection of the "contact indication" function or the "detection and reply to the Microsoft™ Plug&Play signal" function.

The parameters of the **RS232/ASCII** links cannot be set and are fixed as below:

- ▶ 2400 Bauds;
- ▶ 8 data bits;
- ▶ 1 stop bit;
- ▶ no parity.

The microswitches of the SA1 box are not used.

Configuration of RS232 link direction on channel J3

Detail A of figure 1

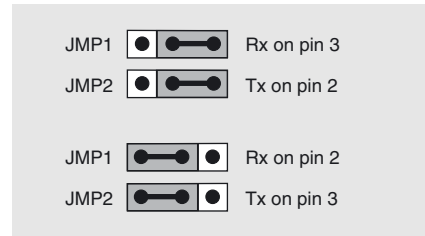

Configuration of RS232 link direction on channel J4

Detail B of figure 1

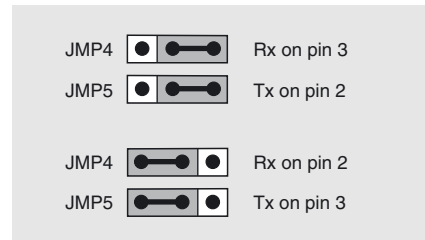

Choosing the "Plug&Play detection" or "information operation on mains 2" mode on channel J3

Detail C of figure 1

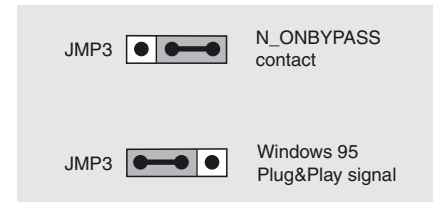

Choosing the "Plug&Play detection" or "information operation on mains 2" mode on channel J4

Detail D of figure 1

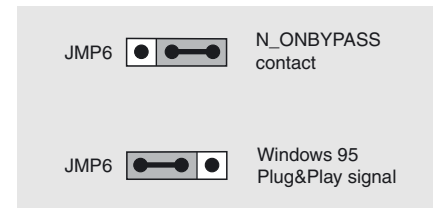

Installation / startup

You do not need to power down the UPS in order to install the **RS232/ASCII** communication card. This card is directly connected to the back of the rack reserved for the transverse communication cards. It can be inserted and withdrawn without any problem.

When it has assumed its operating position, a "reset" push button and a green LED are available to the operator who can then press the "reset" button to restart the **RS232/ASCII** card.

When the **RS232/ASCII** card is placed in the back of the UPS rack or after a card reset:

- ▶ the green LED flashes regularly every second during its startup phase;
- ▶ then, during its initialisation phase, it starts flashing faster and more irregularly;
- ▶ finally, in normal operation, it flashes whenever a measurement or status is modified in the UPS. If no changes take place in the process, the **RS232/ASCII** card remains on standby and flashes regularly every 3 seconds.

When the card is connected to a customer application, the LED flashes at the same pace as data exchange.

Warning for Solution-Pac™ users

According to the important power range of the **MGE™ Galaxy™ PW** UPS family and to the power supply quality required by the load, the following functions are not allowed for those devices:

- ▶ schedule On-Off,
- ▶ remote Off sequence,
- ▶ remote battery test sequence.

Although these functions are proposed by **Solution-Pac™** softwares, you can't run them successfully;

Connecting status information and RS232 links

The status information (see figure 2) is available on the DB9 socket connectors. The pins are as follows:

1. earth,
4. operation on mains (as opposed to battery),
5. common,
6. operation on bypass (static switch or manual bypass),
7. low battery warning,
8. operation on UPS,
9. operation on battery.

A remote stopping signal can be transmitted on pin 3 of each DB9: a high status (4 V to 20 V) of a minimum duration of 100 ms causes the time-delayed stopping of the UPS (absorbed current: 0.5 mA under 5 V).

Caution: the remote stopping signal is taken into account only if the UPS is operating on battery. This remote stopping function is not available on all the UPS.

Relay breaking capacity:
 $V_{max} = 30\text{ V}$
 $I_{max} = 200\text{ mA}$
n.o. : normally open,
n.c. : normally closed

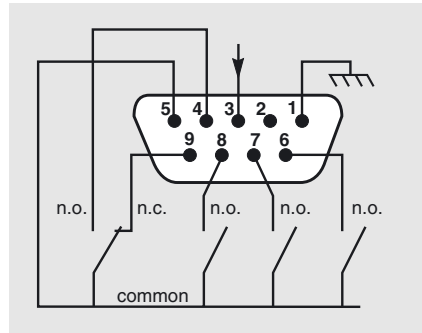

Fig. 2

Connecting the RS232 links

See detail B of figure 1 (page 9), jumpers JMP1 and JMP2 placed on the right.

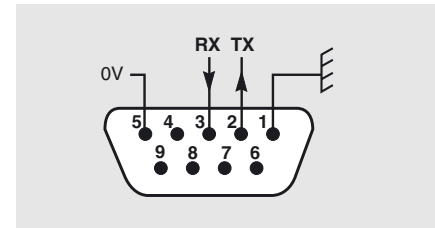

Fig. 3

See detail B of figure 1 (page 9), jumpers JMP1 and JMP2 placed on the left.

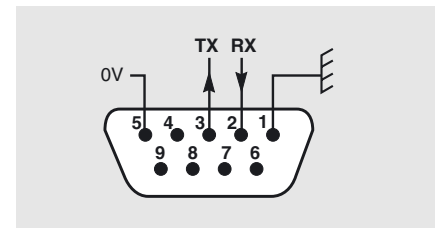

Fig. 4

Free Manuals Download Website

<http://myh66.com>

<http://usermanuals.us>

<http://www.somanuals.com>

<http://www.4manuals.cc>

<http://www.manual-lib.com>

<http://www.404manual.com>

<http://www.luxmanual.com>

<http://aubethermostatmanual.com>

Golf course search by state

<http://golfingnear.com>

Email search by domain

<http://emailbydomain.com>

Auto manuals search

<http://auto.somanuals.com>

TV manuals search

<http://tv.somanuals.com>