

# nEOCR\_BZT

Motor Protection Relay with built-in ZCT



**EOCR Samwaha EOCR**  
by Schneider Electric





**NEW**



GOD DESIGN

## Digital electronic motor protection relay for saving customer's cost, space and time. **EOCR with Built-in ZCT**

The world's first EOCR  
with built-in **ZCT**  
(bottom hole & terminal type)

- will save space, time and wiring through unique development design during installation.
- with compact size, possible to be applied to various panel size.
- the protection function added for high ground fault current.
- most suitable for low frequency circumstance (5Hz~, Inverter use)
- can cover wide range current through product innovation, so it leads to the decrease of customer's managing stocks and simplicity of replacement.

Samwha EOCR has been developing the products only related to EOCR for around 30 years, since established and now challenging the conquering of world market with the real speciality for EOCR that other companies never have.

Customer care center 1588-3473 | [www.eocr.com](http://www.eocr.com)

# nEOCR-BZT : i3BZ, 3BZ2, iFBZ, FBZ2



3DZ



FDZ



ZCT



3MZ



FMZ



3EZ



FEZ

## > Applications



### • Building

Office, commercial business, residence, school, hospital



### • Industrial facilities

Petrochemical, electronic, glass, steel, semiconductor, chemical, medicine, cement, paint

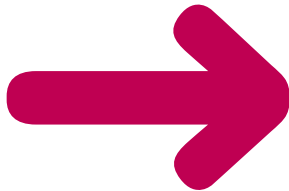

## High sensible built-in ZCT(0.03~10A)

Earth fault protection without external ZCT

- > **Control power**
  - 24 VDC
  - 85~260 VAC/DC, 50/60 Hz
- > **Rated current**
  - Over current : 0.5~80A (Definite)
  - GF current : 0.03A~10A
  - 5~200Hz Variable frequency measurement
- > **Composition by function**
  - Earth Fault
    - i3BZ, iFBZ (with Modbus RS-485)
    - 3BZ2, FBZ2 (without Modbus RS-485)
- > **Motor protection**
  - Thermal Overload
  - Over/under current
  - Stall/Jam
  - EF current
  - Phase loss/Imbalance
- > **Contact contact**
  - A-Type
    - 95-96(b), 97-98(a) : OL
    - 57-58(a) : GR
  - C-Type
    - 95-96(b), 97-98(a) : OL/GR
    - 07-08(a) : AL/UL/TO
- > **Network communication**
  - Modbus RS-485



- **Public institutions**  
Gas, water supply and drainage, airport, train, port

# EOCR-i3BZ/iFBZ/3BZ2/FBZ2

EOCR-i3BZ / iFBZ : Intelligent Digital Over-Current, Earth Fault Relay with built-in ZCT,  
EOCR-3BZ2 / FBZ2 : Economic Digital Over-Current, Earth Fault Relay with built-in ZCT

EOCR-i3BZ / i3BZ2 Bottom hole type



EOCR-iFBZ / iFBZ2 Bottom hole type



EOCR-i3BZi / 3BZ2 Terminal type



EOCR-iFBZ / iFBZ2 Terminal type



## General Features

- Earth fault detection by built-in ZCT
- Multifunctional motor protection for rated motor currents up to 80A (Definite Overcurrent protection) :  
Over Current, Under Current, Phase Loss, Phase Reversal, Stall, Jam, Current Imbalance, Earth Fault
- Thermal Inverse / Inverse overload protection up to 32Amps by integrated CTs.
- Real Time Processing / High Precision
- Ancillary Functions : Fail Safe, Alert("C" Type Only), Accumulated Running Hour, 3 Fault records & limitation of auto-reset attempt.
- Communication : Modbus-RTU/RS-485(i3BZ/iFBZ only)
- Reinforced Monitoring Function : Real Time Monitoring up to 400M, 3 Phase Current Display, Pre-alarm & Cause of Trip indication.
- Load ratio indication of Load Current to over-current threshold.
- Support Single-phase and 3 Phase Motor
- For iFBZ / FBZ2, normal operation except display is guaranteed when PDM is disconnected

# EOCR-i3BZ/iFBZ/3BZ2/FBZ2

EOCR-i3BZ / iFBZ : Intelligent Digital Over-Current, Earth Fault Relay with built-in ZCT,  
EOCR-3BZ2 / FBZ2 : Economic Digital Over-Current, Earth Fault Relay with built-in ZCT

## Protection functions

Item	Operating Condition & Setting Range	Operation Time
<b>Over Current (oc)</b>	Load current(In) exceeds threshold(Is) Setting Range : 0.5~80A(Def), 0.5~32A(Inv & th)	Definite(Def) : 0.2~30s Adjustable Inverse(Inv) & Thermal(th) : 1~30 Class
<b>Under Current (uc)</b>	Load current(In) less than threshold(uc) In <= uc uc should be less than oc Setting	oFF, 1~30s Adjustable
<b>Phase Loss (PL)</b>	max imbalance is more than 85% among 3 phase current, Enable or disable : Selectable	oFF, 0.5~5s Adjustable
<b>Reverse Phase(rP)</b>	Reversed phase sequence input on EOCR. Enable or disable : Selectable	Within 0.15s
<b>Stall (Sc)</b>	Active only in motor starting, In ≥ Stall threshold (Sc×OC). Setting Range : Adjustable 2~8 times of oc setting if Sc×OC doesn't exceed 250A	Immediately after D-Time elapsed
<b>Jam (JA)</b>	Active only in motor running, In ≥ Jam threshold (JA×OC). Setting Range : 1.5~8 times of oc setting if JA×OC doesn't exceed 250A	0.2~10s Adjustable
<b>Unbalance (ub)</b>	Current unbalance ≥ threshold 1~10s Adjustable. Setting Range : 10~50% Unbalance[%] = 100 × (Max phase current – Min phase current)/ Max phase current	1~10s Adjustable
<b>Earth Fault (EF)</b>	EF current(Ie) exceeds threshold(Ies) Setting Range : oFF, 0.03~10A	0.1~10s Adjustable

## Auxiliary functions

Password	Secure configuration, available only with i3BZ/iFBZ
Communication	Serial network communication for monitoring of metering, status, and fault history
Fail Safe	Enable/Disable fail-safe operation of OL trip output
Phase selection	Select a Single-phase motor or 3-Phase motor
Total Running-Hour	Record of total running from installation which cannot be modified or cleared
Running-Hour	Accumulated running hour from preset point which can be cleared to zero, when motor stops
Fault History	Records for recent 3 faults each phase current which stored in a non-volatile memory
Limitation of autoreset attempt	Block auto-reset if the reset count exceeds the pre-set count within 30 minutes

## Communication function (Applicable to i3BZ/iFBZ)

Item	Setting	Remark
<b>Protocol type</b>	Modbus RTU	
<b>Communication type</b>	RS-485	
<b>Baud rate</b>	1.2, 2.4, 4.8, 9.6, 19.2, 38.4 kbps	
<b>Maximum length of the bus</b>	Maximum 1.2KM	Depend on the environment
<b>Type of trunk cable</b>	RS-485 Shielded Twist 2-Pair Cable	

# EOCR-i3BZ/iFBZ/3BZ2/FBZ2

EOCR-i3BZ / iFBZ : Intelligent Digital Over-Current, Earth Fault Relay with built-in ZCT,  
EOCR-3BZ2 / FBZ2 : Economic Digital Over-Current, Earth Fault Relay with built-in ZCT

## Specifications

Model		i3BZ/iFBZ, 3BZ2/FBZ2	
Over Current	Rated Setting Range(A)	Definite TCC : 0.5~80A	
		Inverse & th TCC : 0.5~32A	
		*** CAUTION : Do not use any external CT	
Under Current	Rated Setting Range(A)	0.5A ~ less than oc setting	
Operating Time Characteristics		Definite(Def) / Inverse(Inv) / Thermal Inverse(th) <sup>*1)</sup>	
Time Setting	Definite	D-Time	0~200s
		O-Time	0.2~30s
	Inv & th (cLS)		1~30 Class
	Auto-Reset		0.5s~20min.
	Reset Mode		Manual Reset (H-r) / Electric Reset (E-r)
Control	Power Voltage	100~240VAC/DC(-15%, +10%, Free Voltage), 24VAC/DC(-15%, +10%) .	
	Frequency	50/60Hz	
	Power Consumption	Lower than 7VA	
Output	Capacity	3A/250VAC Resistive.	
	Composition	NO/NC common output : OL , NO output : GR	
Display	7 Segment LED	3 phase Amps, Cause of trip, Setting parameters indication.	
	Bar-graph	Load ratio (65 ~ 100%)	
Communication		Modbus-RTU/ RS-485 <sup>*2)</sup>	
Mounting		Panel Mounting (i3BZ/3BZ2) Flush Mounting (iFBZ/FBZ2)	
Insulation	Between Case & Circuit	Over DC500V 10MΩ	
Dielectric Strength	Between Case & Circuit	2KV, 50/60Hz, 1 Min.	
	Between Contacts	1KV, 50/60Hz, 1 Min.	
	Between Circuit	2KV, 50/60Hz, 1 Min	
Electrostatic Discharge(ESD)	: IEC61000-4-2	Level 3 : Air Discharge : ±8KV, Contact Discharge : ±6KV	
Radiated Disturbance	: IEC61000-4-3	Level 3 : 10V/m, 80 ~ 1000MHz	
Conducted Disturbance	: IEC61000-4-6	Level 3 : 10V, 0.15~80MHz	
EFT/Burst	: IEC61000-4-4	Level 3 : ±2KV, 1 Min	
Surge	: IEC61000-4-5	Level 3 : 1.2×50μs, ±4KV(0°, 90°, 180°, 270°)	
Emission	: CISPR11	Class A (Conducted and Radiated)	
Environment	Temperature	Store	-40°C ~ +85°C
		Operation	-20°C ~ +60°C
	Humidity	30~85% RH (Non-condensate)	
Dimension	Window Type	70W×74.5H×83.8D	
	Bottom Hole Type	70W×56.3H×108.1D	
Weight			i3BZ : 295g, iFBZ : 280g
			3BZ2 : 292g, FBZ2 : 276g
			PDM : 125g, 3M cable : 120g

\*1) : 3BZ2/FBZ2 has no thermal inverse protection

\*2) : 3BZ2/FBZ2 has no MODBUS Communication



# EOCR-i3BZ/iFBZ/3BZ2/FBZ2

EOCR-i3BZ / iFBZ : Intelligent Digital Over-Current, Earth Fault Relay with built-in ZCT,  
EOCR-3BZ2 / FBZ2 : Economic Digital Over-Current, Earth Fault Relay with built-in ZCT

## Time-current characteristic curve

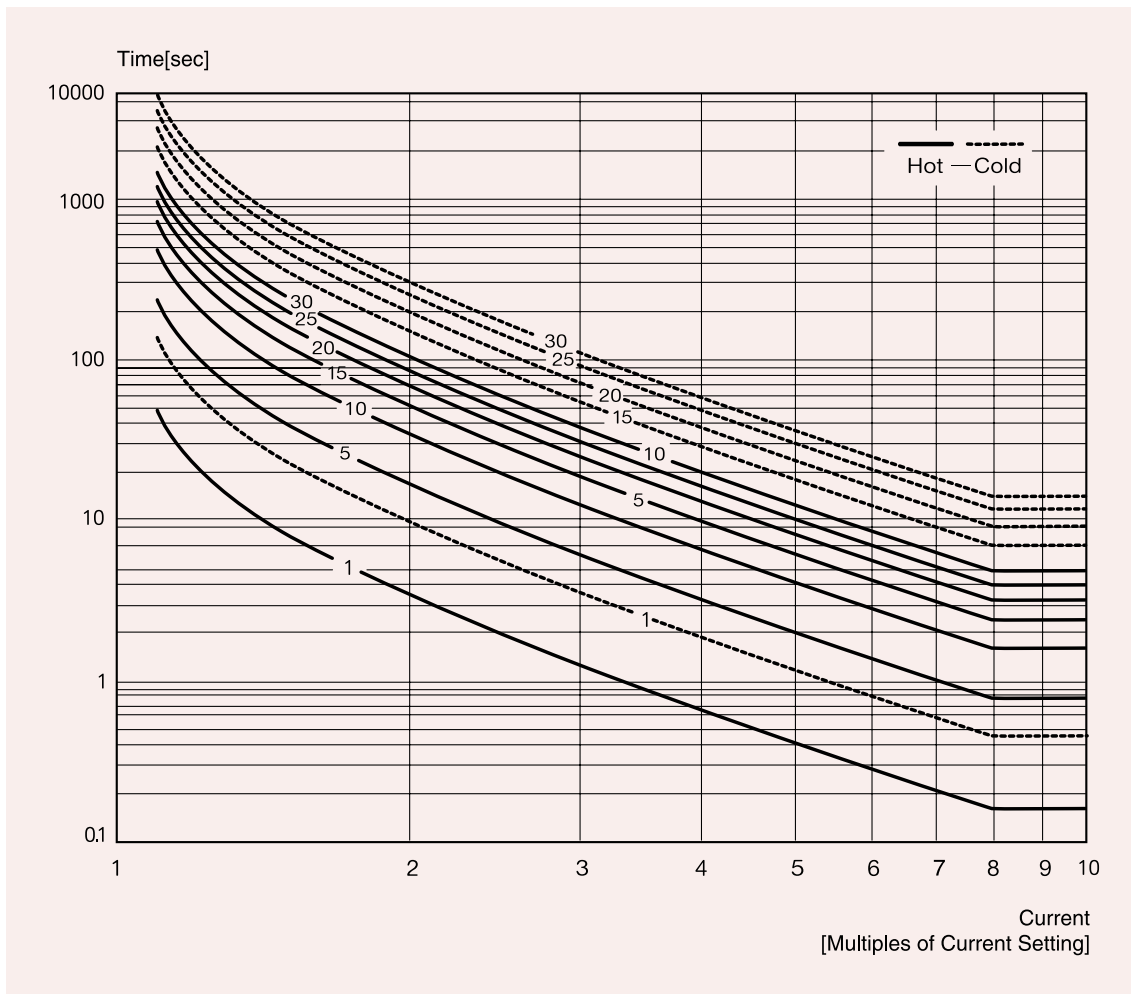

1. Inverse characteristic (0.5~32A)

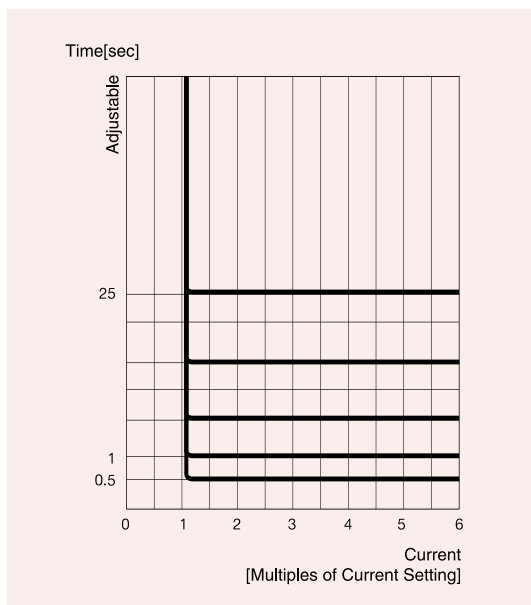

2. Definite characteristic

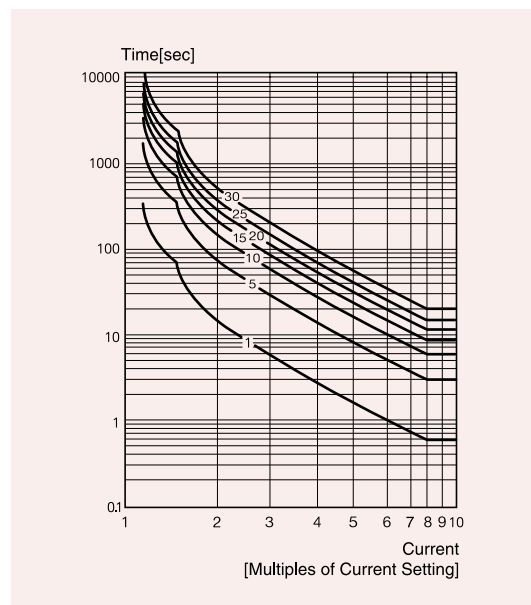

3. Inverse thermal characteristic (0.5~32A)

# EOCR-i3BZ/iFBZ/3BZ2/FBZ2

EOCR-i3BZ / iFBZ : Intelligent Digital Over-Current, Earth Fault Relay with built-in ZCT,  
EOCR-3BZ2 / FBZ2 : Economic Digital Over-Current, Earth Fault Relay with built-in ZCT

## Over current and time setting tips

### ● Over current

#### Setting tips in definite TCC mode

##### 1. Over current threshold (OC) :

- Set the OC at the rating current of a motor. To protect machine together, it is recommended to set at 110~120% of the actual normal operating current.

##### 2. Starting delay time (D-time)

- Set an expected start-up time to reach the normal current of load. If you do not know it, set to 15sec at first and start-up the motor to measure the time to reach the normal operation current by monitoring the displayed current and then set the time at 2 sec longer than the time measured. For a Y-D start, it's better to set time 2 sec longer than the preset time of the Y-Δ change timer.

##### 3. Operation time (O-time) : Set the trip delay time which activates and counts down under a fault condition.

#### Configuration tips when Inverse or Thermal Inverse characteristic is necessary

##### 1. Overcurrent threshold (oc) :

- This value is the basic current and from the point of 105% of oc, the inverse curve starts. Usually oc is set to the rated current of the motor.

##### 2. Starting delay time (D-time)

- Usually this value is set to zero. With zero D-time and Inverse is selected, first the cold curve is applied until the load current drops down the oc value, and then the hot curve is applied.

- But if the user wants fast trip with very high current during starting, set D-time other than zero. With non-zero D-time, the enabled STALL function detects very high current immediately after the D-time elapsed.

- If the Inverse is selected, and D-time is non-zero, the Inverse function is blocked during starting, and the hot curve is applied after D-time elapsed.

- If Thermal Inverse is selected, it detects overcurrent regardless of D-time. That is, thermal inverse is activated during motor starting as well as motor running.















##### 3. Operation time (O-time) :

- When Inverse or Thermal Inverse is selected, O-time setting determines the trip class. nEOCR supports trip class from 1 to 30. Refer to the graphical representation of Inverse or Thermal Inverse to check trip time.

※ Caution : Do not use any External CT

## Alert Operation Pattern (#3)

Do use this function by OL/GR common output.

Running Stage ALo Selection	Starting	Normal Operation	Higher than the preset Alert value	Trip
Aux 				
Flicker 				
Hold 				

## Fail-safe operation

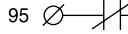
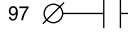
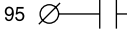
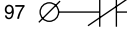
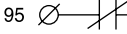
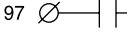
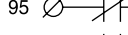
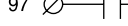
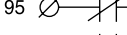
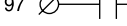
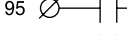
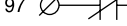
Fail-Safe	A1-A2 not powered	A1-A2 powered and under normal operation	A1-A2 powered and Tripped
ON	95  96 Close 97  98 Open	95  96 Open 97  98 Close	95  96 Close 97  98 Open
OFF	95  96 Close 97  98 Open	95  96 Close 97  98 Open	95  96 Open 97  98 Close

# EOCR-i3BZ/iFBZ/3BZ2/FBZ2

EOCR-i3BZ / iFBZ : Intelligent Digital Over-Current, Earth Fault Relay with built-in ZCT,  
EOCR-3BZ2 / FBZ2 : Economic Digital Over-Current, Earth Fault Relay with built-in ZCT

## Front face

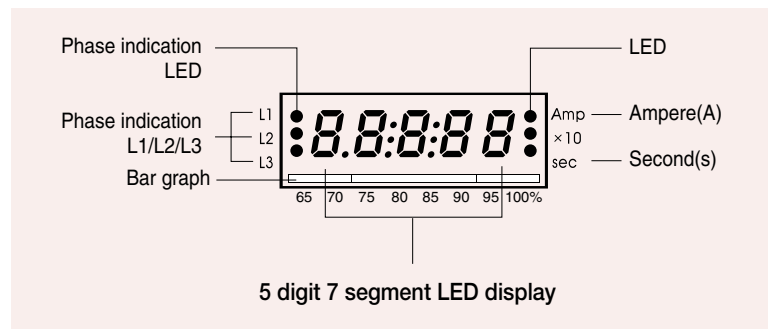
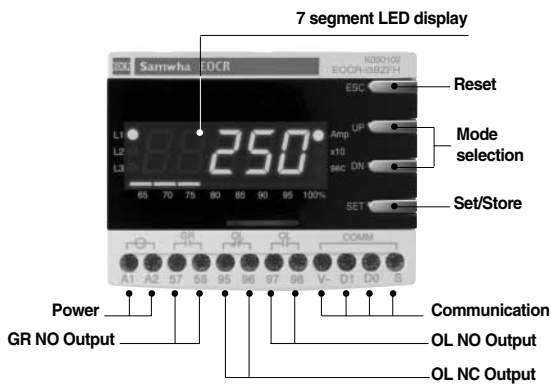

3 phase currents (In) and the leakage current are displayed every 2 seconds in sequence.



### Bar graph

- it shows the load factor to OC setting value by %
- % value = (running current/setting current) × 100%
- Min scale is 65%
- if the setting value is the rated motor current, it shows the load factor of the motor.

### Current display

- Shows the highest current among three phases for oc, Stall, Jam trips.
- Shows the lowest current among three phases for uc, Ub trips.
- Shows the lost phase for PL.
- Shows the phase and the current during running.

**Amp** : Ampere. LED is on when a current display.

**× 10** : Shows the unit changed to 10 times.

**Sec** : Second. LED is on when a time display.

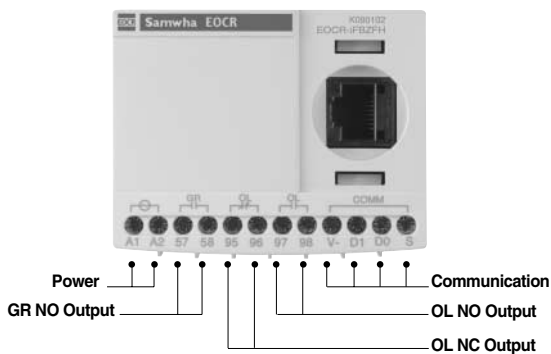

# EOCR-i3BZ/iFBZ/3BZ2/FBZ2

EOCR-i3BZ / iFBZ : Intelligent Digital Over-Current, Earth Fault Relay with built-in ZCT,  
EOCR-3BZ2 / FBZ2 : Economic Digital Over-Current, Earth Fault Relay with built-in ZCT

## 3 phase digital ammeter function

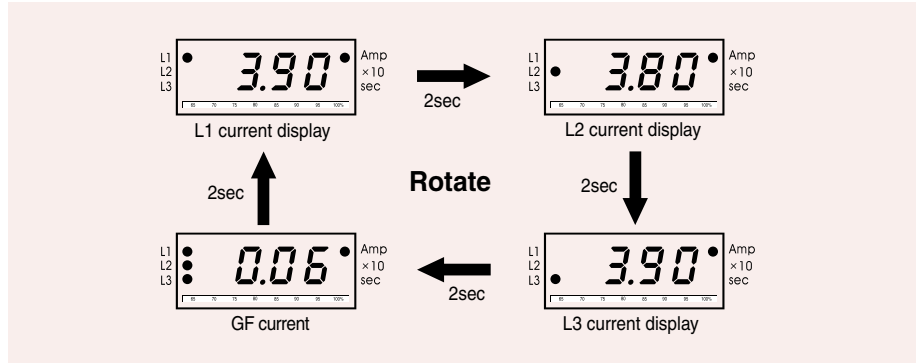

※Blocking display rotation can be done by pressing the SET button once during running. whenever press the SET button, the each phase current displays by turns. A fixed phase current display can be done by this.  
※Pressing the ESC button, it returns to the Auto current display rotation mode.

## Buttons and Setting Sequence

Button	Description
▲ UP ▼ DN	Navigate menus by pressing UP/DN button.
SET	Select a parameter to change, then the parameter starts blinking.
▲ UP ▼ DN	Modify a parameter value by pressing UP/DN button.
SET	Memorize the values in the relay by pressing SET button. blinking stops to show it's stored.
ESC	Pressing ESC button, it returns to the current display. Without pressing ESC button, it returns to the load current display in 50sec automatically.

※Fault history check : Pressing the ESC button more than 5sec, it displays the latest fault cause and the fault current or fault phase. Continuing to press DN button, you can see the current of L1(R), L2(S), L3(T), (GR) in turn. Press the DN button again to check the previous fault continually. In the latest fault display, the 100% LED of bar graph lights on and two LEDs of 95%, 100% lights on for the second fault display, three LEDs of 90%, 95%, 100% lights on for the oldest fault display. When you press the ECS button in this mode, it returns to the normal current display mode. The oldest fault record is over written when the number of fault to record exceeds three.

### ● Setting sequence

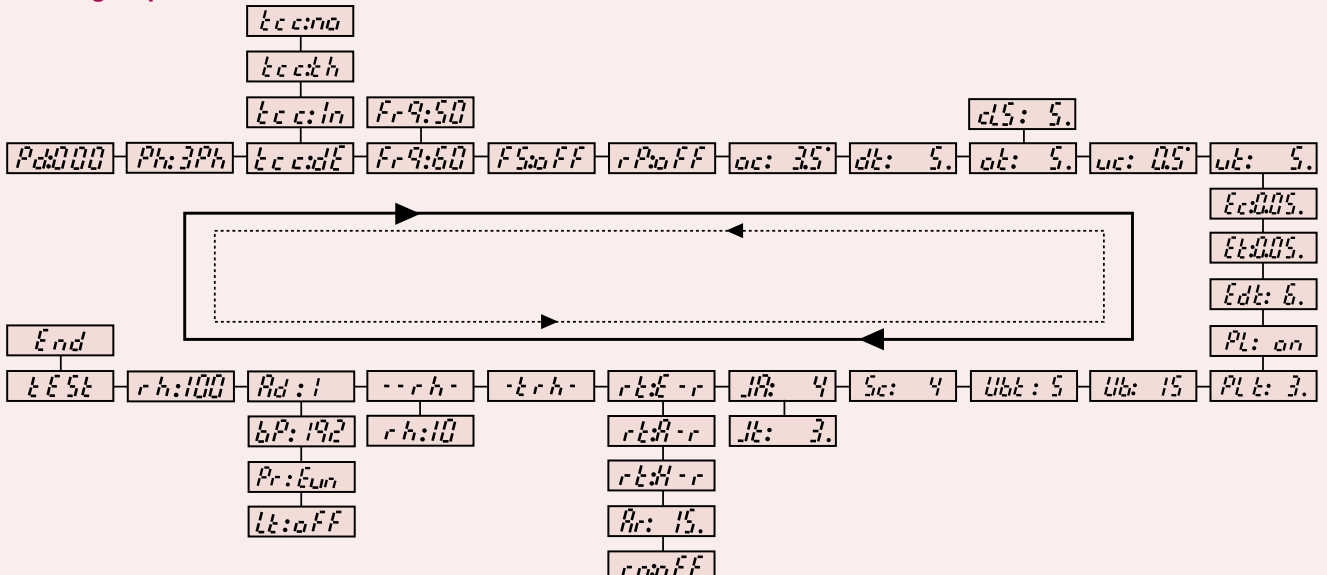



# EOCR-i3BZ/iFBZ/3BZ2/FBZ2

EOCR-i3BZ / iFBZ : Intelligent Digital Over-Current, Earth Fault Relay with built-in ZCT,  
EOCR-3BZ2 / FBZ2 : Economic Digital Over-Current, Earth Fault Relay with built-in ZCT

## Setting sequence and menu

No.	Menu	Parameter	Description	Default
1	Password	Pd:000	Use password other than zero for secured configuration. This feature enables limitation of setting modification by unauthorized person. Zero value is used for disabling password checking.	Pd:000
2	Selection of Phase	Ph: 3Ph Ph: 1Ph	"Ph:3Ph" mode for a 3 phase load, "Ph:1Ph" mode for a 1 phase load should be selected. If you select the "Ph:1Ph", RP, PL and Ub functions will be disabled and not displayed in the menu mode	Ph: 3Ph
3	TCC Selection	tcc:de tcc:ln tcc:th tcc:no	Time-Current Characteristic(TCC) setting. "dE" is for Definite TCC, "ln" is for Inverse TCC, "th" is for thermal inverse TCC. Refer to the time-current characteristic curve . If tcc=no, only overcurrent protection is disabled.	tcc:de
4	Frequency	Fr:9.60	Select 50 or 60 based on the system fundamental frequency.	Fr:9.60
5	Fail Safe	FS: on FS:oFF	Selection of Fail Safe(No volt release) operation for overload trip output, OL. Refer to Fail-Safe Operation	FS:oFF
6	Reversed Phase detection	rP: on rP:oFF	Enable or disable reverse phase detection	rP:oFF
7	Over Current Threshold	oc: 3.5	Threshold for Over Current protection which cannot be set below the under current threshold(uc).	oc: 5.0
8	Start Delay Time	dt: 5.	Motor Starting delay, OC, UC, Stall, Jam, Ub are blocked during starting but PL, RP, and thermal inverse are not blocked. For "ln" TCC mode, the cold curve is applied during before dt is activated and the hot curve is applied after the dt expired.	dt: 5.
9	Over Current Duration	ot: 5. tcs: 5	tcc:de the fault duration of definite overcurrent protection. tcc:ln the trip class for inverse overcurrent protection(refer to TCC curve) tcc:th the class for thermal overload protection based on the thermal image by load current (refer to TCC curve).	ot: 5.
10	Under Current Threshold	uc: 0.5	Threshold for Under Current protection. The setting should be higher than no-load current of a motor. The current value cannot be set higher than OC.	uc:oFF
11	Under Current Duration	ut: 5.	Fault duration for the Under Current Operation. If the setting of "oFF" in the "uc" mode is selected, this menu is not displayed	ut: 5.
12	Earth Fault (Ground Fault) Threshold	Ec:0.06	Threshold for Earth Fault protection. The capacitance leakage current of the motor and cable should be taken into account for the setting. The threshold value corresponds to the primary current of ZCT.	Ec: 0.5
13	Earth Fault Duration	Et:0.05.	Earth Fault duration TCC is always a definite characteristic for earth fault detection.	Et:1
14	EF starting Delay	Edt: 6.	Blocking time of Earth Fault detection during motor starting. oFF, 1-30s adjustable This timer is only active during motor starting.	Edt: 0.
15	Phase Loss	PL: on PL:oFF	Enable or disable Phase Loss(Single Phasing) detection. If the "Ph:1Ph" is selected, this menu is not displayed.	PL: on
16	Phase Loss Time	PLt: 3.	Fault duration for Phase Loss Operation . The setting range is 0.5-5 sec. if "PL:oFF" is selected, this menu is not displayed	PLt: 2.
17	Unbalance Threshold	Ub: 15	Threshold for Current Unbalance operation. To disable the function, set to "oFF", The setting range is 10-50%. Unbalance factor (%) = (max phase - min phase) / I <sub>max</sub> phase × 100%	Ub: 50
18	Unbalance fault duration	Ubt: 5	Unbalance fault duration for Current Unbalance operation. The setting range is 1-10 seconds.	Ubt: 5
19	Stall threshold	Sc: 4	Threshold for locked rotor detection during motor starting. The value is the multiples of the over current threshold(oc). If the locked rotor condition is detected, the trip relay operates in 0.5s after the "dt" expires. If dt=0, this function is disabled and not displayed in the menu.	Sc: 4
20	Jam threshold	JR: 4	Threshold for locked rotor detection during motor running. The value is the multiples of the over current threshold (oc)	JR: 4
21	Jam fault duration	Jt: 3.	Jam Fault duration	Jt: 5.

# EOCR-i3BZ/iFBZ/3BZ2/FBZ2

EOCR-i3BZ / iFBZ : Intelligent Digital Over-Current, Earth Fault Relay with built-in ZCT,  
EOCR-3BZ2 / FBZ2 : Economic Digital Over-Current, Earth Fault Relay with built-in ZCT

## Setting sequence and menu

No.	Menu	Parameter	Description	Default
22	Alert <sup>*1)</sup>	AL: 85 AL: oFF	Threshold of Alert output, set by % of the over current threshold (oc). If the load current is higher than this value, alert output(07-08 contact) is energized according to the setting of "ALo:XX".	AL: oFF
		ALo: A	If the load current is detected, alert output(07-08 contact) is energized. The alert threshold is no meaning for this operation. Refer to the Alert Operation Pattern.	
		ALo: F	If the load current is higher than the alert threshold, alert output(07-08 contact) repeats open for 1s and close for 1s (flickering), The flickering starts from the motor starting. Refer to the Alert Operation Pattern.	
		ALo: H	If the load current is higher than the alert threshold, alert output(07-08 contact) is closed (holding) and remains closed until the load current decrease under the alert threshold. The alert output is blocked during motor starting. Refer to the Alert Operation Pattern.	
		ALo:to	If the accumulated running hour is more than the Running Hour threshold, the alert output repeats close for 1s and open for 1s.	
		ALo:uc	The alert output is used only for under current protection. If this mode is selected, a trip by an under current fault is signaled through alert output(07-08), instead of overload trip output(95-96 or 97-98).	
23	Reset	rt: E-r	Fault reset by a power cycle or by pressing the ESC button.	
		rt: H-r	Fault reset only by pressing the ESC button.	
		rt: A-r Ar: 15.	Fault reset by a auto-reset timer, Setting range of the timer : 0.5sec-20min.	
		Ar: 20n	Also the fault can be reset by a power cycle or by ESC button.	
24	Reset Limitation	rn: 3	The maximum auto-reset number during 30 minutes in auto-reset mode. The auto-reset counter is stored in the non-volatile memory and is cleared by pressing ESC button when the counter reaches the limitation. To disable limitation, select "oFF". Setting range : oFF~5 times.	Ad: 1
25	Total Running Hour	-trh- 033	In this menu, toggle display, "-trh-" and the accumulated value, is activated. The accumulation starts from the installation and the user cannot clear the accumulated value. This display unit is 1 hour.	Not adjustable
26	Running Hour	--rh- 033	In this menu, toggle display, "--rh-" and the accumulated value, is activated. The user can clear the accumulated value by selecting the running hour threshold to "rh:oFF". When motor stops This display unit is 0.1 hour (6 minutes). By selecting "ALo:to", the user can get the alert signal through alert output(07-08) when the accumulated value is more than the running hour threshold.	Not adjustable
27	Running Hour Threshold	rh: 10.	Threshold for alert output when the user selects "ALo:to". The unit is 10 hours and this menu is not displayed when the motor is starting or running. Setting range : 10~9990 hours, oFF	rh: oFF
28	Communication <sup>*2)</sup>	Ad: 000	Modbus slave address. Range : 1 ~ 247.	Ad: 1
		bP: 19.2	Setting for Communication speed Range : 1.2Kbps, 2.4Kbps, 4.8Kbps, 9.6Kbps, 19.2Kbps, 38.4Kbps .	bP: 19.2
		Pr: Even Pr: odd	Parity setting Range : odd, even, non.	Pr: Even
		Lt: oFF	Duration for communication loss detection. Displays alarm when no new communication data is received for the duration. If "oFF" is selected, no monitoring for communication channel is activated. Setting range : 1~999 sec, oFF	Lt: oFF
29	Test Trip	tEst	When this menu activated, OL trip signal and enabled EF trip signal is generated when (3s+ot) expires. The display shows "End" when the test is done. By pressing ESC, returns to the load current display mode. This menu is not displayed when the motor is starting or running. Before (3s+ot) expires, pressing ESC or motor starting or running blocks the test trip and return to the load current display.	No parameter
30	End	End	This shows the end of test trip. Test result is stored in the fault record.	No parameter

\*1) This menu is only available in "C" Type.

\*2) These are applied to i3BZ & iFBZ only.

# EOCR-i3BZ/iFBZ/3BZ2/FBZ2

EOCR-i3BZ / iFBZ : Intelligent Digital Over-Current, Earth Fault Relay with built-in ZCT,  
 EOCR-3BZ2 / FBZ2 : Economic Digital Over-Current, Earth Fault Relay with built-in ZCT

## Trip cause indication and fault records

3 fault records including the trip cause and 3phase currents are stored in a non-volatile memory.

Trip Indication					
Trip			Indication after trip with UP/ DN button pressing		
Trip Cause	Indication	Contents of Indication	L1 LED on	L2 LED on	L3 LED on
Over current		OC Trip caused by r-phase current			
Phase loss		Phase Loss caused by r-phase lost			
Reverse Phase		Phase reversal trip			
Stall		Stall trip during motor starting caused by s-phase current			
Jam		Jam trip during motor running caused by r-phase current			
Imbalance		Imbalance trip caused by t-phase current			
Under Current		Under current trip caused by s-phase current			
Earth Fault		Earth Fault(Earth leakage) trip with Earth Fault current indication			
Limitation of auto-Reset		In 30minutes, the number of auto-reset exceeds the pre-set count	For emergency restart, manual reset by pressing ESC clears the reset counter to zero.		

## Control terminals

A type

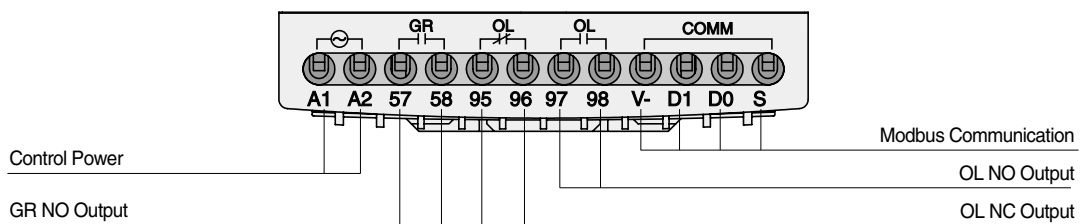

C type

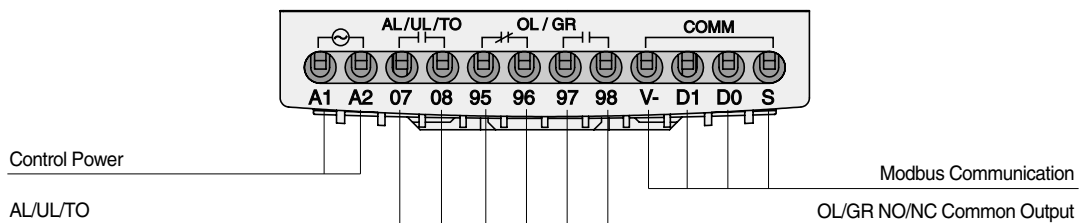

# EOCR-i3BZ/iFBZ/3BZ2/FBZ2

EOCR-i3BZ / iFBZ : Intelligent Digital Over-Current, Earth Fault Relay with built-in ZCT,  
 EOCR-3BZ2 / FBZ2 : Economic Digital Over-Current, Earth Fault Relay with built-in ZCT

## Wiring Examples

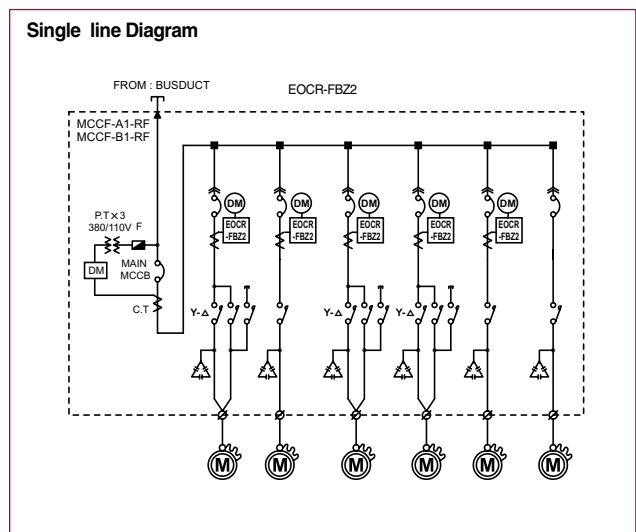
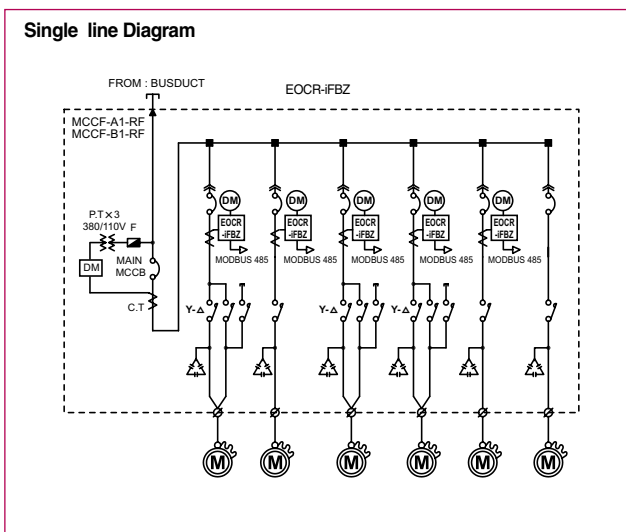
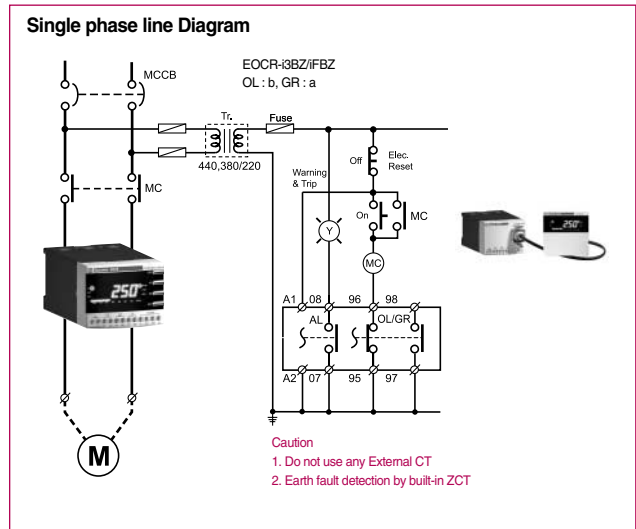
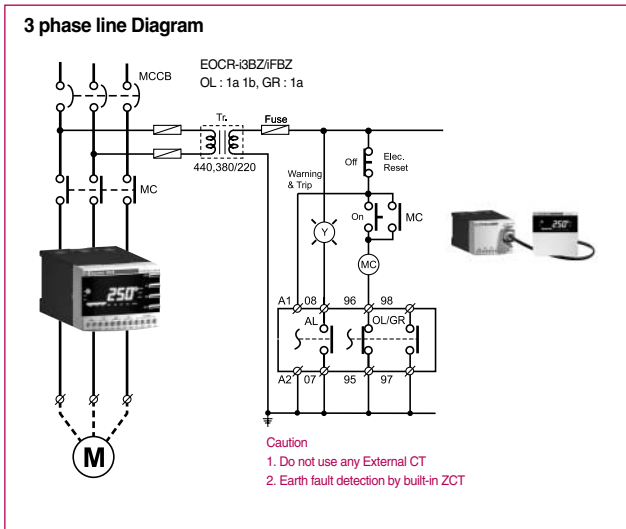
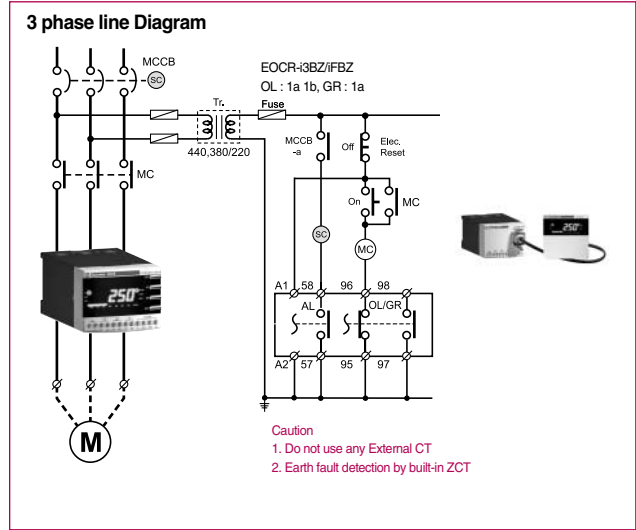
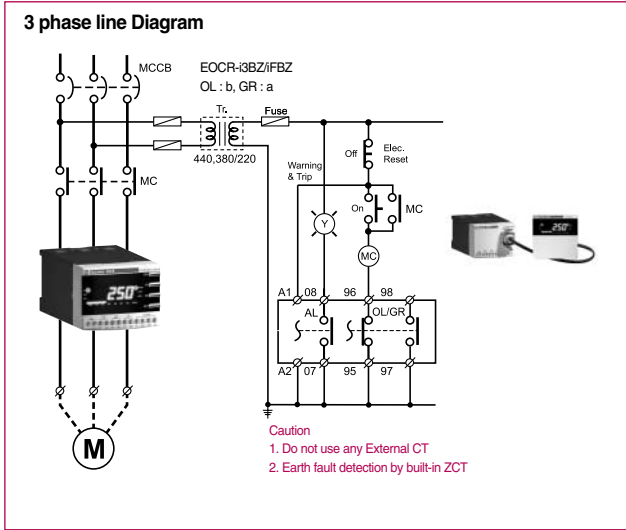









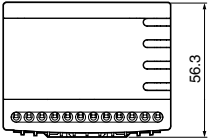
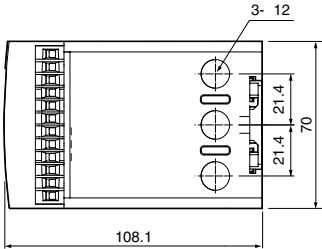
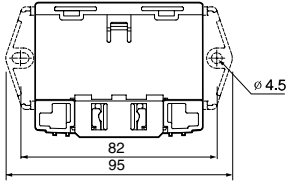

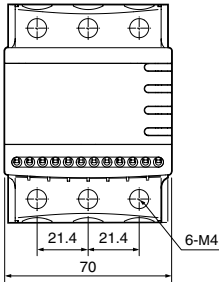
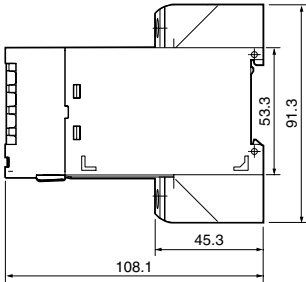
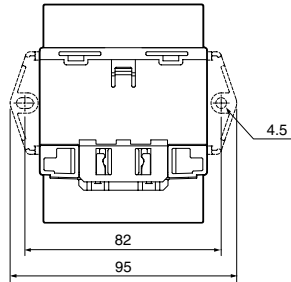
# EOCR-i3BZ/iFBZ/3BZ2/FBZ2

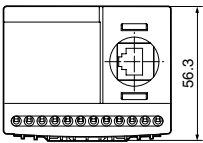
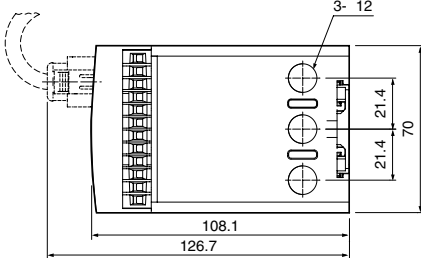
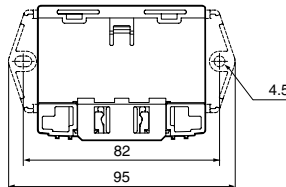
EOCR-i3BZ / iFBZ : Intelligent Digital Over-Current, Earth Fault Relay with built-in ZCT,  
EOCR-3BZ2 / FBZ2 : Economic Digital Over-Current, Earth Fault Relay with built-in ZCT

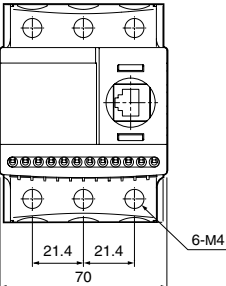
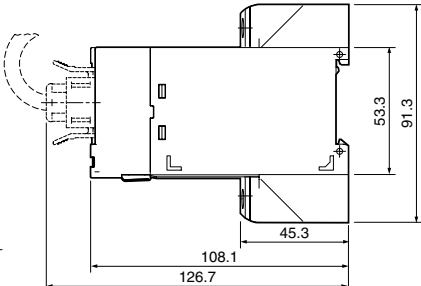
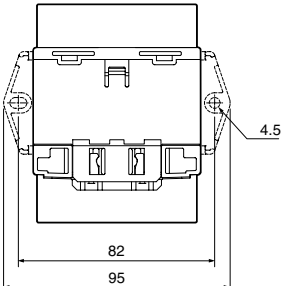
## Dimensions

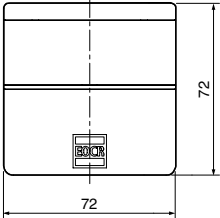
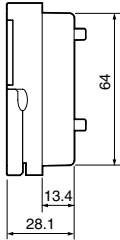
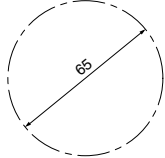
 <p>EOCR-i3BZ / 3BZ2 (Bottom Hole)</p>		 <p>PANEL &amp; DIN RAIL TYPE</p>	 <p>MOUNTING HOLE SIZE</p>
 <p>EOCR-i3BZ / 3BZ2 (Terminal Type)</p>		 <p>PANEL &amp; DIN RAIL TYPE</p>	 <p>MOUNTING HOLE SIZE</p>
 <p>EOCR-iFBZ / FBZ2 (Bottom Hole)</p>		 <p>PANEL &amp; DIN RAIL TYPE</p>	 <p>MOUNTING HOLE SIZE</p>
 <p>EOCR-iFBZ / FBZ2 (Terminal Type)</p>		 <p>PANEL &amp; DIN RAIL TYPE</p>	 <p>MOUNTING HOLE SIZE</p>
 <p>EOCR-PDM</p>			 <p>MOUNTING HOLE SIZE</p>

# EOCR-i3BZ/iFBZ/3BZ2/FBZ2

EOCR-i3BZ / iFBZ : Intelligent Digital Over-Current, Earth Fault Relay with built-in ZCT,  
EOCR-3BZ2 / FBZ2 : Economic Digital Over-Current, Earth Fault Relay with built-in ZCT

## Order Code

For nEOCR- order

**i 3 B Z - WR A U H L**

①                      ②                      ③                      ④                      ⑤                      ⑥

①	Basic Unit	i3BZ	Intelligent, panel mounting unit
		iFBZ	Intelligent, flush mounting unit
		3BZ2	Economic, panel mounting unit
		FBZ2	Economic, flush mounting unit
②	Current Range	WR	0.5~80A
③	Output relay	A	OL : 95-96 (NC output), 97-98 (NO output) GR : 57-58 (NO output)
		C	OL/GR : 95-96 (NC output), 97-98 (NO output) AL/UL/TO : 07-08
④	Control Voltage	B	DC/AC 24V(-15%, +10%)
		U	AC/DC 100~240V (-15%, +10%)
⑤	Wiring method	H	Through bottom-hole
		T	Through screw-terminal
⑥	Low frequency adaptation	L	For low system frequency (10Hz~100Hz)

For Cable order,

**C A B L E - RJ45 - 0 0 1**

①                      ②

①	Connector Type	RJ45	Only support RJ45 connector
②	Cable Length	00H	0.5M
		001	1M
		01H	1.5M
		002	2M
		003	3M
		Others	Special order up to 400M

## Modbus network setting

### Communication setting value

Please set the Modbus communication parameters by PCON or HMI for the communication.

- Slave address
- Baud rate
- Parity
- Communication loss timeout

### Slave address

The EOCR has slave addresses from 1 to 247.

The factory default setting is 1.

### Baud rate

The Communication speed provided is like below.

- 1.2kbps
- 2.4kbps
- 4.8kbps
- 9.6kbps
- 19.2kbps
- 38.4kbps

The factory default setting is 19.2kbps

### Parity setting

- Even
- Odd
- None

The factory default setting is even. Please refer to the table for the stop bit setting.

Parity setting	Stop bit
Even or Odd	1
None	2

### Communication loss timeout

It is the criteria to confirm the communication disconnection with a master like as PLC.

EOCR judges it as a communication disconnection error, if there is no call from the master during a certain preset time.

The time setting range is 1~999sec the factory default setting is OFF. The OFF means no communication error check. It is advised to set it at OFF, if there is no concern of communication disconnection or no needs of communication error check at ordinary times.

## RS485 bus connection

RS485 standard allows several different characteristics.

- Polarization
- Line terminator
- Number of slaves
- Length of the bus

There is a definition of Modbus presented in detail at the website of Modbus.org in 2002. Standard connection.

## Standard connection

The standard connection conforms to the Modbus specifications, especially 2 wire multidrop serial bus diagram, presented at the website of Modbus.org in 2002 (Modbus\_over\_serial\_line\_V1.pdf, Nov.2002). Simple wiring diagram is like below.

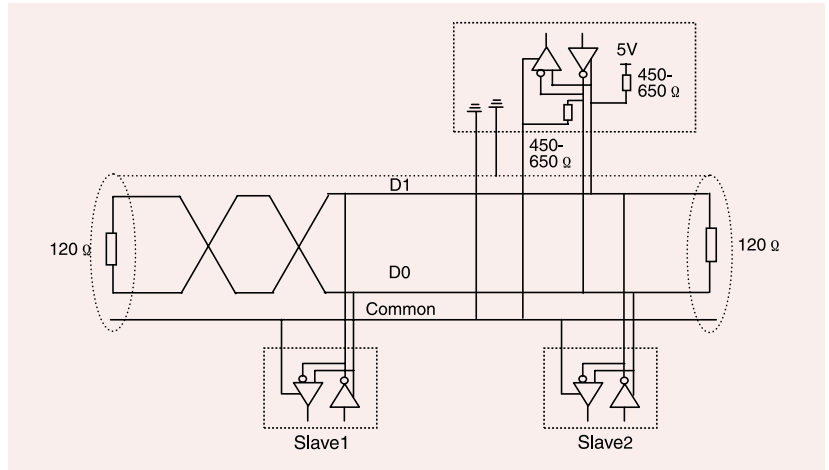

The characteristics is like below in case of a direct connection to the bus.

Items	Contents
<b>Type of trunk cable</b>	single, shielded, twisted pair cable. Min 3rd cable
<b>Maximum length of the bus</b>	1000m (3,2181 ft) (at 19.2kbps)
<b>Maximum number of stations without repeater</b>	32 stations (31 slaves)
<b>Maximum length of tapoffs</b>	<ul style="list-style-type: none"> <li>• 20m (66ft, at 1 tapoff)</li> <li>• 40m (131ft, divided by tapoff no. in Multi-Junction Box)</li> </ul>
<b>Bus polarization</b>	<ul style="list-style-type: none"> <li>• 450 - 650Ω Pullup resistor, 5V basis</li> <li>• 450 - 650Ω Pulldown resistor, Recommend the polarization to Master at Common. There is no polarization at RS485 of EOCR .</li> </ul>
<b>Line terminator</b>	120Ω Resistor, +/- 5%
<b>Common polarity</b>	YES (connect 1 protection ground minimum to the bus)



# Communication Guide

## Bus connection through a SCA type junction box

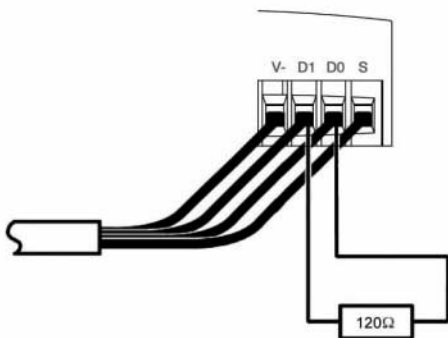
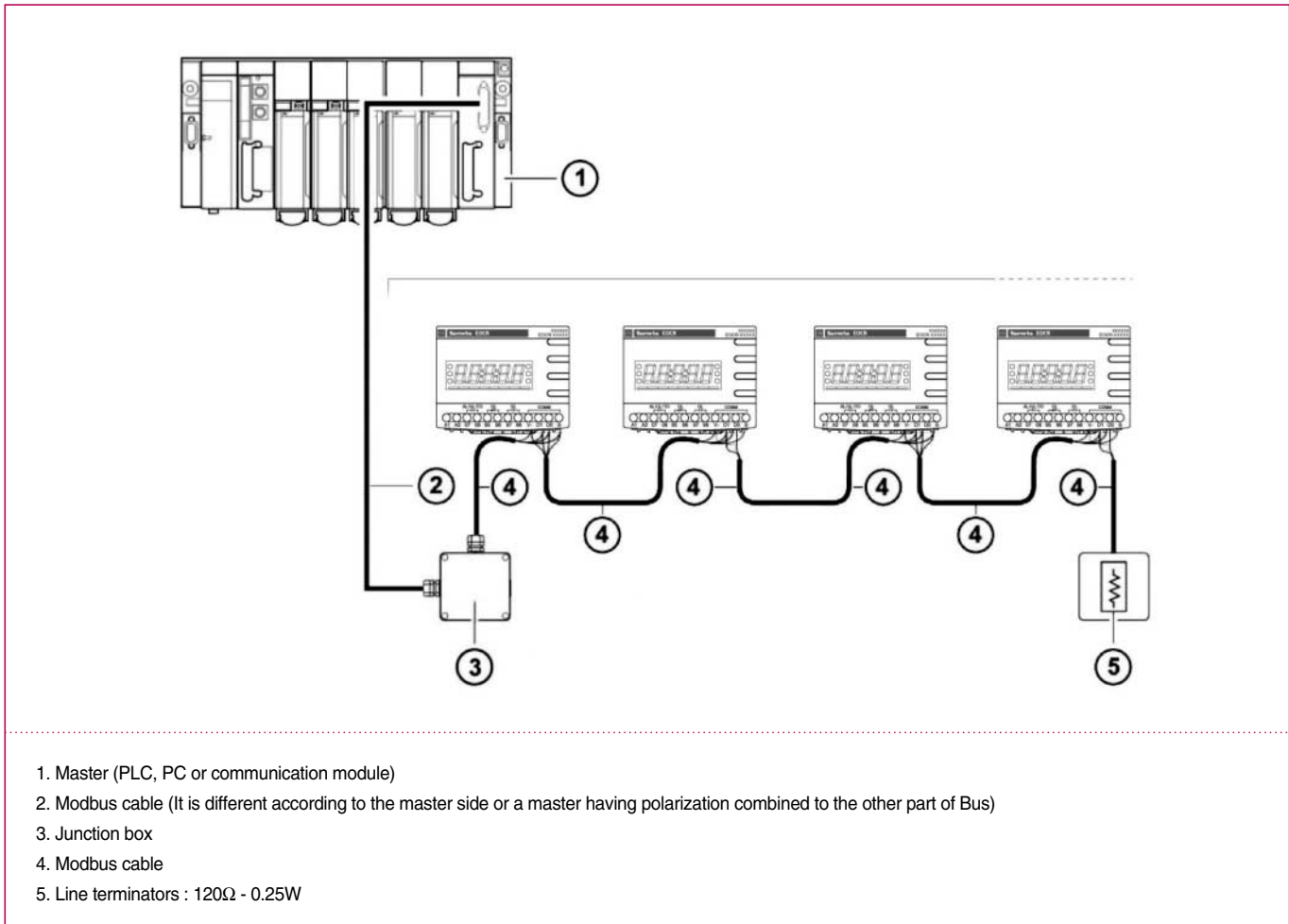

Please use a cable with 2pair shielded twisted conductors for Interface protection. It is advised to isolate the Modbus cable 30cm(11.8in) at least from a power cable. If necessary, intersect the Modbus cable to a power cable perpendicularly. Refer to the diagram in the left side for the line terminator wiring.

### ■ 2 wire MODBUS RJ45 connections

Pin on RJ45	Pin on nEOCR	EIA/TIA 485 name
4	D1	B/B'
5	D0	A/A'
8	V-	C/C'

Pin 'S' can be used for shield wire connection.



**+82-1588-3473**

[help@seocr.co.kr](mailto:help@seocr.co.kr)

**Samwha EOCR Ltd.**

**Head Office**

6<sup>th</sup> floor, Jeil Bldg., 94-46, Youngdeungpo-Dong 7Ka, Youngdeungpo-Ku, Seoul, Korea  
Tel. 82 2 3473 2340 / Fax 82 2 3473 1159

**Iksan Plant**

574, Yongie-dong, Iksan-shi, Junbuk, Korea  
Tel. 82 63 835 5033 / Fax 82 63 835 4175  
[www.eocr.com](http://www.eocr.com)

04/2009

## Free Manuals Download Website

<http://myh66.com>

<http://usermanuals.us>

<http://www.somanuals.com>

<http://www.4manuals.cc>

<http://www.manual-lib.com>

<http://www.404manual.com>

<http://www.luxmanual.com>

<http://aubethermostatmanual.com>

Golf course search by state

<http://golfingnear.com>

Email search by domain

<http://emailbydomain.com>

Auto manuals search

<http://auto.somanuals.com>

TV manuals search

<http://tv.somanuals.com>