

# Quantum Hot Standby Planning and Installation Guide

840 USE 106 00    Version 4.0

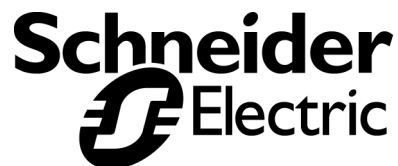



---

# Table of Contents

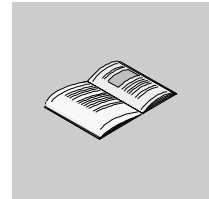

---

	<b>Safety Information</b> .....	<b>9</b>
	<b>About the Book</b> .....	<b>11</b>
<b>Chapter 1</b>	<b>Overview of Quantum Hot Standby</b> .....	<b>13</b>
	At a Glance .....	13
1.1	Control .....	15
	Introduction .....	15
	Primary and Standby Control .....	16
	Hardware Components in a Quantum Hot Standby System .....	17
	The CHS 110 Hot Standby Module .....	18
1.2	Operation .....	21
	Modes of Operation .....	21
1.3	Cabling .....	23
	Introduction .....	23
	Fiber Optic Cable .....	24
	The CHS 210 Hot Standby Kit .....	25
1.4	984 HSBY and IEC HSBY .....	26
	Introduction .....	26
	984 HSBY .....	27
	IEC HSBY .....	28
<b>Chapter 2</b>	<b>Theory of 984 Ladder Logic HSBY Operation</b> .....	<b>31</b>
	At a Glance .....	31
	How a 984 HSBY System Works .....	32
	System Scan Time .....	33
	The State RAM Transfer and Scan Time .....	36
	Default Transfer Area .....	38
	Customizing Options .....	40
	Custom Scans .....	41

---

<b>Chapter 3</b>	<b>Theory of IEC HSBY Operation. . . . .</b>	<b>43</b>
	At a Glance . . . . .	43
	IEC Hot Standby Definitions . . . . .	44
	How an IEC HSBY System Works. . . . .	46
	System Scan Time. . . . .	47
	State Ram Transfer and Scan Time . . . . .	51
	Layout of completely transferred state RAM in an IEC Hot Standby system. . . . .	53
<b>Chapter 4</b>	<b>Planning a Quantum Hot Standby System . . . . .</b>	<b>55</b>
	At a Glance . . . . .	55
	Guidelines for Planning a Hot Standby System. . . . .	56
	Electrical Safety Precautions . . . . .	57
	Remote I/O Cable Topologies . . . . .	58
	A Single Cable Configuration. . . . .	59
	A Dual Cable Configuration . . . . .	60
<b>Chapter 5</b>	<b>Installation . . . . .</b>	<b>61</b>
	How to Install a Hot Standby System. . . . .	61
<b>Chapter 6</b>	<b>Using a Quantum 984 HSBY System . . . . .</b>	<b>67</b>
	At a Glance . . . . .	67
6.1	Configuration . . . . .	69
	Introduction . . . . .	69
	Configuring 984 HSBY. . . . .	70
	Configuration Extension. . . . .	72
	CHS Instruction . . . . .	73
6.2	Using the CHS Instruction Block . . . . .	74
	Introduction . . . . .	74
	Using CHS Instruction Block . . . . .	75
	Command Register . . . . .	76
	Elements of the Nontransfer Area . . . . .	78
	Zoom screen of CHS Instruction . . . . .	80
	The Hot Standby Status Register . . . . .	81
	The Reverse Transfer Registers . . . . .	82
	Reverse Transfer Logic Example. . . . .	83
6.3	Using Configuration Extension. . . . .	85
	Introduction . . . . .	85
	Configuration Extension. . . . .	86
	Hot Standby Dialog . . . . .	87
	Bits in the Hot Standby Command Register . . . . .	88
	Keyswitch Override and Run Mode . . . . .	90
	A Software Control Example . . . . .	91
	Standby on Logic Mismatches . . . . .	92
	Transfer All State RAM . . . . .	94
	Hot Standby Status Register for Configuration Extension. . . . .	95
	Advanced Options . . . . .	96

---

---

	Defining the Transfer Area of State RAM . . . . .	97
	Transferring Additional State RAM Data . . . . .	100
	Scan Transfers . . . . .	102
6.4	Operation . . . . .	103
	Introduction . . . . .	103
	Starting Your Hot Standby System . . . . .	104
	Synchronizing Time-of-Day Clocks . . . . .	106
	While Your System Is Running . . . . .	108
<b>Chapter 7</b>	<b>Using a Quantum IEC Hot Standby System . . . . .</b>	<b>109</b>
	At a Glance . . . . .	109
7.1	Configuration . . . . .	111
	Introduction . . . . .	111
	Loading the Software . . . . .	112
	Controlling the Hot Standby System by Configuration Extension . . . . .	114
7.2	Hot Standby Dialog . . . . .	116
	Introduction . . . . .	116
	Hot Standby dialog . . . . .	117
	Specifying the Command Register . . . . .	118
	Hot Standby Command Register . . . . .	119
	Enable Keyswitch Override . . . . .	120
	Advanced Options Concept 2.5 . . . . .	122
	Standby on Logic Mismatch . . . . .	124
	Swapping Addresses at Switchover . . . . .	127
7.3	State RAM . . . . .	129
	Introduction . . . . .	129
	Nontransfer Area of State RAM . . . . .	130
	Hot Standby Status Register . . . . .	132
	Memory Partition . . . . .	133
	State RAM Size . . . . .	134
7.4	Section Transfer Control . . . . .	135
	Section Transfer Control . . . . .	135
7.5	Operation . . . . .	138
	Starting Your Hot Standby System . . . . .	138
7.6	Normal Operation . . . . .	140
	Introduction . . . . .	140
	Memory/Scantime optimization . . . . .	141
	Synchronizing Time of Day Clocks . . . . .	145
	While Your System Is Running . . . . .	146
<b>Chapter 8</b>	<b>Additional Guidelines for IEC Hot Standby . . . . .</b>	<b>147</b>
	At a Glance . . . . .	147
8.1	General Application Requirements . . . . .	149
	Introduction . . . . .	149
	Memory Savings . . . . .	150
	Memory Statistics . . . . .	151

---

---

	Memory Partition . . . . .	153
8.2	State RAM . . . . .	155
	Efficient Use of State RAM . . . . .	155
8.3	Efficiency Tips . . . . .	157
	Introduction . . . . .	157
	Use Constants Instead of Equal Literals . . . . .	158
	Use Constants Instead of Open Inputs . . . . .	159
	Programmed Logic. . . . .	161
	Reduce the Use Of Complex Data Structures . . . . .	162
<b>Chapter 9</b>	<b>Ethernet Hot Standby Solution. . . . .</b>	<b>163</b>
	At a Glance . . . . .	163
	Overview of Hot Standby Solution for NOEs . . . . .	164
	Hot Standby Topology . . . . .	166
	NOE Configuration and Hot Standby . . . . .	167
	IP Address Assignment . . . . .	168
	NOE Operating Modes and Hot Standby. . . . .	169
	Address Swap Times. . . . .	173
	Network Effects of Hot Standby Solution. . . . .	174
<b>Chapter 10</b>	<b>Maintenance . . . . .</b>	<b>177</b>
	At a Glance . . . . .	177
10.1	Health of a Hot Standby System . . . . .	179
	Introduction . . . . .	179
	Verifying Health of a Hot Standby System. . . . .	180
	Additional Checks . . . . .	181
10.2	Errors . . . . .	183
	Introduction . . . . .	183
	Startup Errors. . . . .	184
	Communications Errors . . . . .	185
	Board Level Errors. . . . .	186
10.3	Failures . . . . .	187
	Introduction . . . . .	187
	Detecting Failures in a Hot Standby System . . . . .	188
	Detecting Failures in the Primary Backplane . . . . .	189
	Detecting Failures in the Standby Backplane . . . . .	190
	Failure of Fiber Link from Primary Transmit to Standby Receiver. . . . .	191
10.4	Replacement . . . . .	192
	Introduction . . . . .	192
	Replacing a Hot Standby Module . . . . .	193
	Changing the Program and Performing a Program Update. . . . .	194
	Updating PLC System Executives in a 984 HSBY System . . . . .	198
	Updating PLC System Executives in an IEC HSBY System . . . . .	200
10.5	Testing . . . . .	201
	Forcing a Switchover . . . . .	201

---

---

<b>Chapter 11</b>	<b>Specifications for CHS 110 Hot Standby</b> . . . . .	<b>205</b>
	Specifications . . . . .	205
<b>Appendices</b>	. . . . .	<b>207</b>
	Appendices for Quantum Hot Standby Planning and Installation Guide . . . . .	207
<b>Appendix A</b>	<b>Com Act Error Patterns</b> . . . . .	<b>209</b>
	At a Glance . . . . .	209
	CHS 110 Hot Standby Module Error Patterns . . . . .	210
	CRP Remote I/O Head Processor Error Patterns . . . . .	211
<b>Appendix B</b>	<b>Fiber Optic Cable Guide</b> . . . . .	<b>213</b>
	At a Glance . . . . .	213
	Fiber Optic Cable . . . . .	214
	Other Tools . . . . .	216
<b>Appendix C</b>	<b>ProWORX Nxt Configuration</b> . . . . .	<b>217</b>
	ProWORX Nxt Hot Standby Configuration Extension . . . . .	217
<b>Index</b>	. . . . .	<b>223</b>





---

# Safety Information

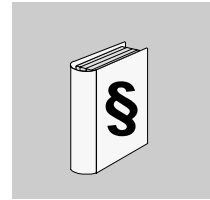

---

## Important Information

### NOTICE

Read these instructions carefully, and look at the equipment to become familiar with the device before trying to install, operate, or maintain it. The following special messages may appear throughout this documentation or on the equipment to warn of potential hazards or to call attention to information that clarifies or simplifies a procedure.



The addition of this symbol to a Danger or Warning safety label indicates that an electrical hazard exists, which will result in personal injury if the instructions are not followed.



This is the safety alert symbol. It is used to alert you to potential personal injury hazards. Obey all safety messages that follow this symbol to avoid possible injury or death.



## DANGER

DANGER indicates an imminently hazardous situation, which, if not avoided, **will result** in death, serious injury, or equipment damage.



## WARNING

WARNING indicates a potentially hazardous situation, which, if not avoided, **can result** in death, serious injury, or equipment damage.



## CAUTION

CAUTION indicates a potentially hazardous situation, which, if not avoided, **can result** in injury or equipment damage.

---

**PLEASE NOTE**

Electrical equipment should be serviced only by qualified personnel. No responsibility is assumed by Schneider Electric for any consequences arising out of the use of this material. This document is not intended as an instruction manual for untrained persons.

© 2003 Schneider Electric All Rights Reserved

---

---

## About the Book

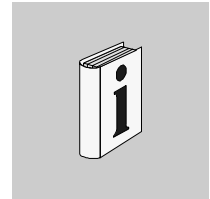

---

### At a Glance

**Document Scope** This manual contains complete information about programmable controller Hot Standby systems.

**Validity Note** This documentation applies to Concept.

### Related Documents

Title of Documentation	Reference Number
Quantum Automation Series Hardware Reference Guide	840 USE 100 00
Remote I/O Cable System Planning and Installation Guide	890 USE 101 00
Ladder Logic Block Library User Guide	840 USE 101 00
Modbus Plus Network Planning and Installation Guide	890 USE 100 00
Concept V 2.5 User's Manual	840 USE 493 00
Concept V 2.5 Installation Instructions	840 USE 492 00
Concept V 2.5 Block Library: IEC	840 USE 494 00
Concept V 2.5 Block Library: LL984	840 USE 496 00
Concept EFB User's Manual	840 USE 495 00

### Product Related Warnings

Schneider Electric assumes no responsibility for any errors that may appear in this document. If you have any suggestions for improvements or amendments or have found errors in this publication, please notify us.

No part of this document may be reproduced in any form or means, electronic or mechanical, including photocopying, without express written permission of the Publisher, Schneider Electric.

**User Comments**

We welcome your comments about this document. You can reach us by e-mail at [TECHCOMM@modicon.com](mailto:TECHCOMM@modicon.com)

---

---

# Overview of Quantum Hot Standby



---

## At a Glance

### Purpose

This chapter presents a brief overview of the Hot Standby system, including a description of Primary and Standby control, components, the Hot Standby module, LEDs and switches, modes of operation, 984 and IEC HSBY, and the application size.

Throughout the rest of this book the Quantum Hot Standby system is referred to as HSBY.

An HSBY system is based on two identically configured programmable logic controllers linked to each other and to the same remote I/O network. If one controller fails, the other assumes control of the I/O system.

### What's in this Chapter?

This chapter contains the following sections:

Section	Topic	Page
1.1	Control	15
1.2	Operation	21
1.3	Cabling	23
1.4	984 HSBY and IEC HSBY	26



# 1.1 Control

---

## Introduction

---

**Purpose** This section describes Primary and Standby Control for a Quantum Hot Standby system.

---

**What's in this Section?** This section contains the following topics:

Topic	Page
Primary and Standby Control	16
Hardware Components in a Quantum Hot Standby System	17
The CHS 110 Hot Standby Module	18

---

## Primary and Standby Control

---

### Description

The Quantum Hot Standby system is designed for use where downtime cannot be tolerated. The system delivers high availability through redundancy. Two backplanes are configured with identical hardware and software.

One of the PLCs acts as the Primary controller. It runs the application by scanning user logic and operating remote I/O.

The other PLC acts as the Standby controller. The Primary controller updates the Standby controller after each scan. The Standby is ready to assume control within one scan if the Primary fails.

Primary and Standby states are switchable. Either controller can be put into the Primary state, but to do this, the other must be in the Standby state. The remote I/O network is always operated by the Primary controller.

**Note:** A Quantum Hot Standby system supports only remote I/O. It does not support local I/O or distributed I/O (DIO).

### Role of the CHS 110 Hot Standby Module

Each controller is paired with a 140 CHS 110 00 Hot Standby module. The module monitors its own controller and communicates with the other Hot Standby module. The system monitors itself continuously. If the Primary controller fails, the Hot Standby module switches control to the Standby, which then becomes the Primary controller.

If the Standby controller fails, the Primary continues to operate without a backup.

---



---

## Hardware Components in a Quantum Hot Standby System

---

### Components

A Quantum Hot Standby system requires two backplanes, each with at least four slots. The backplanes must be equipped with identical, compatible Quantum:

- Programmable logic controller
- Remote I/O head processor
- CHS 110 Hot Standby module
- Cables (See *Fiber Optic Cable Guide*, p. 213)
- Power supply
- Other components, (Backplanes, I/O Modules, Splitters, as required)

The following illustration shows the hardware components in a Quantum Hot Standby System.

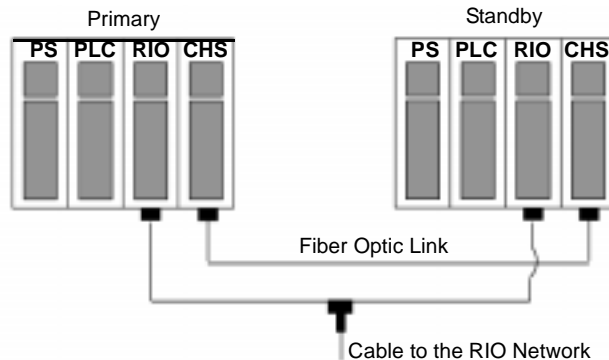

**Note:** The order of the modules in the backplanes must be the same.

---

## The CHS 110 Hot Standby Module

---

### Topology

The following diagram shows the module's front panel, which consists of:

- LED Display
  - Function Keyswitch
  - Designation slide switch
  - Update Button
  - Fiber optic cable ports
- 

### CHS 110 Front Panel Controls

The following figure shows the module's front panel.

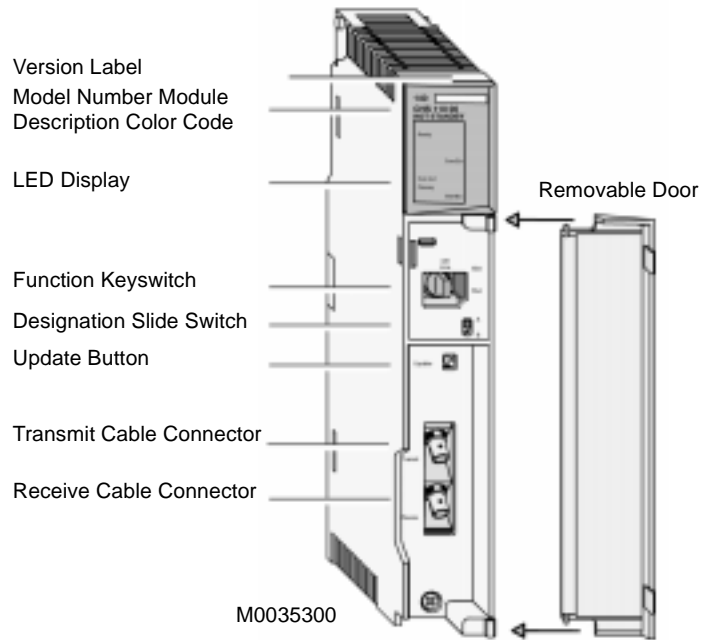

**LED Display**

The following illustration shows five status indicators on the face of each CHS 110 module.

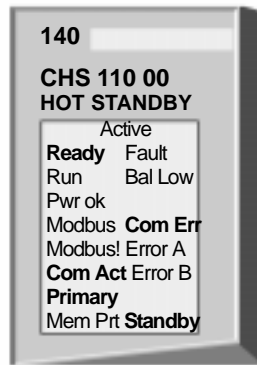

The following table shows the five status indicators.

Indicator	Color	Message
Ready	Green	If steady, power is being supplied to the module and it has passed initial internal diagnostic tests. If blinking, module is trying to recover from an interface error.
Com Act	Green	If steady, CHS 110 modules are communicating. If blinking, an error has been detected.
Primary	Green	Module is Primary controller.
Com Err	Red	Module is retrying CHS communications or CHS communications failure has been detected.
Standby	Amber	If steady, module is Standby controller, and is ready to assume Primary role if needed. If blinking, program update is in progress.

Error messages are discussed in detail in *Com Act Error Patterns*, p. 209.

**Function  
Keyswitch**

Beneath the LED display on the face of each CHS 110 control panel is a function keyswitch. It has three positions: Off Line, Xfer (transfer) and Run. You may use this switch to force transfer of control functions or to copy the full program from the Primary controller to the Standby.

The following illustration shows a function keyswitch with three positions: Off Line, Xfer and Run.

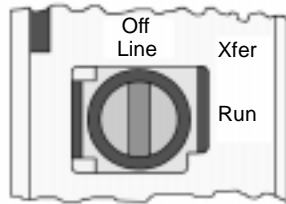

**Note:** For security or convenience, you can disable the function keyswitch with a software override. Once the keyswitch is disabled, you can set the module to run or offline mode with software. This can be especially helpful when the module is not easily accessible.

**Designation  
Slide Switch and  
Update Button**

A slide switch located below and to the right of the keyswitch is used to designate the controller as A or B. One unit must be designated as A and the other as B. Use the Standby Update Button to initiate the Primary to Standby program transfer. You must have the keyswitch in transfer mode.

**Note:** If the controllers are given identical designations, the system refuses to acknowledge them both. The first unit to power up will be recognized as the Primary controller. It is designated A or B according to its switch position. The second unit remains offline and the ComAct indicator flashes, indicating a startup error.

**Note:** Once the system is running, Primary control may be exchanged between the units regardless of which is designated as A or B.

---

## 1.2 Operation

---

### Modes of Operation

---

#### HSBY Modes of Operation

HSBY has three Modes of Operation:

1. Off Line Mode
2. Transfer Mode
3. Run Mode

These modes are described below.

---

#### Off Line Mode

This mode is used to take a controller out of service without stopping it or disconnecting power. If you turn the key on the Primary unit to Off Line, control switches to the Standby. If the Standby controller is taken offline, the Primary continues to operate without a backup.

---

#### Transfer Mode

This mode is used to request a program update of the Standby controller from the Primary controller. For a step-by-step description of the procedure refer to *Replacement, p. 192*.

The Primary controller is able to update the Standby without any interruption in its other functions. If the Primary unit is in Run mode and you hold down the update button on the Standby unit, the Hot Standby modules prepare to copy the full program of the Primary controller to the Standby unit. The program includes the configuration table, I/O map, configuration extensions, segment scheduler, user logic, all .EXE loadables, ASCII messages and the entire state RAM.

To complete the transfer, while continuing to press the update button, turn the key on the Standby to transfer. The Com Act LED extinguishes. Turn the key to the mode you want the Standby to assume after the update, Run or Off Line. The Standby indicator flashes. Release the update button.

The Standby indicator continues to flash during the update and while the Standby unit processes the update. If the unit is set to run mode, the Standby indicator returns to a steady amber. If the unit is set to offline mode, the Standby indicator extinguishes. Remove the key.

**Note:** If you turn the key on the Primary unit to transfer, the Hot Standby system ignores your action.

---

### **Run Mode**

When the keyswitch is in this position, the controller is active and is either serving as the Primary controller or is capable of taking over the Primary role, if needed. The keyswitch on both Hot Standby modules should be in the Run position at all times. When the Standby controller is in Run mode and the standby indicator is on, it is actively monitoring the status of the system and is ready to take control if the Primary unit fails.

---

---

## 1.3 Cabling

---

### Introduction

---

#### Purpose

This section describes cabling for CHS 110 Hot Standby modules.

---

#### What's in this Section?

This section contains the following topics:

Topic	Page
Fiber Optic Cable	24
The CHS 210 Hot Standby Kit	25

---

## Fiber Optic Cable

---

### Cable Connections

The CHS 110 Hot Standby modules are connected by a fiber optic cable. The cable has two identical strands. Each strand transmits a signal in only one direction. For this reason, each strand must be connected between the upper (transmit) port on one module and the lower (receive) port on the other.

If the cable is not connected properly, the Hot Standby modules are not able to communicate and the Hot Standby system does not function. The Primary controller operates without a backup. The Standby unit remains offline.

A 3 meter fiber optic cable is provided in the 140 CHS 210 00 Hot Standby kit. One strand of that cable is marked with the manufacturer's name. This is the only way to distinguish the two strands.

This illustration shows CHS 110 Hot Standby modules connected by a fiber optic cable.

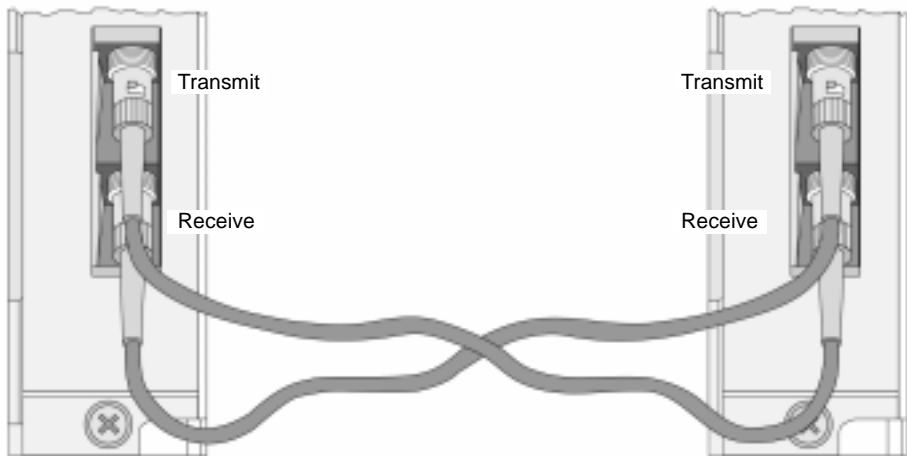



## The CHS 210 Hot Standby Kit

---

**Contents of Kit** Each 140 CHS 210 00 Hot Standby kit contains the following parts. Part numbers are listed in parentheses.

- Two CHS 110 Hot Standby modules with four fiber cable clasps (140 CHS 110 00)
  - A 3 meter duplex fiber optic cable (990 XCA 656 09)
  - Two coaxial splitters together with two tap terminators and four self-terminating F adapters (140 CHS 320 00)
  - A 3 1/2 in. diskette with the CHS loadable (140 SHS 945 00)
  - Quantum Hot Standby Planning and Installation Guide, 840 USE 106 00 Version 2
-

## 1.4 984 HSBY and IEC HSBY

---

### Introduction

---

**Purpose** This section describes 984 HSBY and IEC HSBY.

---

**What's in this Section?** This section contains the following topics:

Topic	Page
984 HSBY	27
IEC HSBY	28

---

## 984 HSBY

---

### 984HSBY

In a 984 HSBY system, the user application is written in 984 ladder logic. HSBY mode can be activated by implementation of a CHS loadable function block into logic, like the earlier PLC systems used the "HSBY" loadable function block. 984 HSBY may also be activated as a configuration extension that allows additional features to be configured. For details refer to *Using a Quantum 984 HSBY System*, p. 67.

---

### Architecture

Quantum 984 Hot Standby involves:

- Concept Version 2.1 or greater, Modsoft Version 2.3 or greater, Proworx Version 1.5 or greater
- All Quantum Controllers
- The existing CHS Modules and Execs (CHS 110 00)

Changes to the running application are possible only by download changes to the Primary controller, whereby the Standby goes offline until it gets updated again by using the UPDATE push button (refer to *Replacement*, p. 192).

---

### System Compatibility

#### Minimum Module Versions to Support 984 HSBY

Module	Version	PV / SV
140 CPU x13 0x	2.1	All
140 CPU 424 02	2.1	All
140 CPU x34 1x	All	All
140 CRP 93x 00	2.1	All
140 NOM 2xx 00	2.1	All

---

## IEC HSBY

---

### IEC HSBY Architecture

IEC Hot Standby means: Programming an application with the choice of 5 different IEC compliant languages; FBD, LD, SFC, IL and ST.

1. The IEC HSBY system uses the same hardware architectures as 984 HSBY system for its basic operations. For example, state RAM data transfer and switchover control are the same, but there are some differences compared to the 984 HSBY system.
  2. PLC firmware upgrade is allowed without shutting down the system with Concept 2.5 or higher. Earlier versions of Concept require shutting down the system to upgrade PLC firmware.
  3. RIO is serviced differently.
  4. With Concept 2.5 or higher, it is now possible to download the same application to Primary and to the Standby controller. The result is that the Hot Standby system will be fully setup (equalized) with identical applications in both controllers. Earlier versions of Concept require you to use the UPDATE bush button (refer to *Using a Quantum IEC Hot Standby System*, p. 109) on the CHS module in the Standby rack to equalize both controllers. Therefore, the same application including the configuration will be running in both controllers.
  5. There's no CHS function block used in IEC.
-

**Architecture**

As shown below, Quantum IEC Hot Standby involves:

- Concept Version 2.1 or greater
- Two High End Quantum Controllers (CPU 434 12 or CPU 534 14)
- The existing CHS Modules and Execs (CHS 110 00). The existing RIO Heads with version 2.0 Execs or greater (CRP 93x).
- All five IEC 1131 languages can be used, however 984 Ladder Logic cannot be used.

The following diagram shows the Quantum IEC Hot Standby Architecture

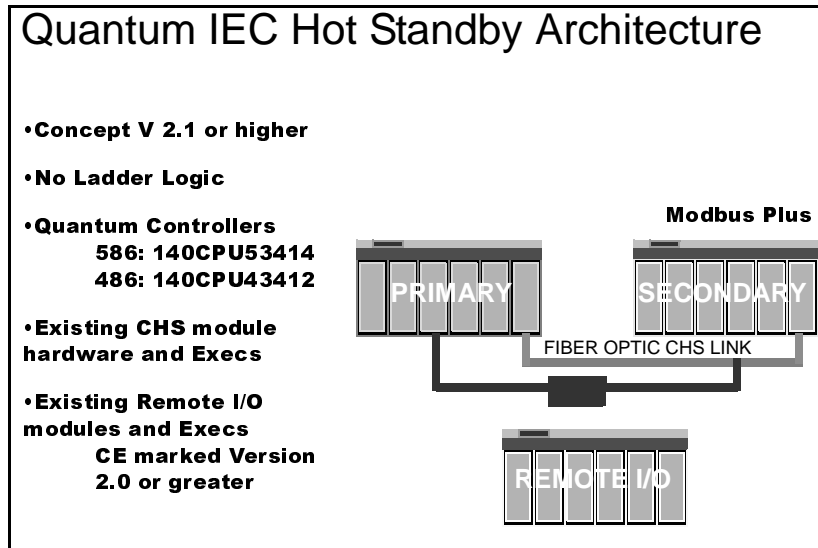

With Concept 2.1/2.2, changes to the running application are possible only by download changes to the Primary controller, whereby the Standby controller goes offline until it gets updated again by using the UPDATE push button (refer to *Updating PLC System Executives in an IEC HSBY System*, p. 200). Concept 2.5 supports the Logic Mismatch option on the Hot Standby Configuration Extension which allows the Standby controller to remain online with a different program than the Primary controller.

**Note:** Unlike Concept 2.1, with Concept 2.2/2.5 it is possible to make changes to the IEC logic offline and download them as online changes later. It is not necessary to be connected to the controller at the time of editing the IEC logic.

**Application size** For basic mechanisms (data and program transfer), the IEC HSBY and the 984 HSBY system operate in the same manner. The data transfer during normal operation, accomplished by copying the state RAM from the Primary to the Standby, causes differences in terms of application size. In IEC HSBY, a part of the state RAM is used to transport the IEC application data from the Primary to the Standby. Therefore the size of IEC application data cannot exceed the configured size of the state RAM itself. The absolute maximum for IEC application data is 128K (64K words of state RAM). For the size of an IEC application's executable code there is also a limit of 568K under Concept 2.1/2.2. The IEC application's executable code limit was increased to 1 Megabyte for Concept 2.5.

---

**Quantum IEC Hot Standby Overview**

- IEC Language programs only, no 984 Ladder Logic permitted
  - To bring a Standby on-line
    - Primary and Standby controller executives must be equal.
    - Primary and Standby IEC Projects must have the same name and the applications must be equal.
  - On-line changes to the Primary are permitted
    - With Concept 2.1/2.2, the Standby controller is taken off-line as soon as the first Primary on-line change is made. The Primary program must be transferred to the Standby before it can be brought back on-line.
    - Concept 2.5 supports Logic Mismatch in the Hot Standby configuration extension. This option allows the Standby controller to remain online with a different program than the primary controller.
  - Primary controller on-line changes may include
    - Addition of sections
    - Addition of DFBs allows pre-qualification of user changes in an office environment
  - Logic Mismatch
    - With Concept 2.1/2.2, it is not possible to load a new version of the application on Standby, bring it on-line, and transfer control to make it the new Primary.
    - Under Concept 2.5, with Logic Mismatch enabled, a new version of the application can be downloaded to the Standby controller and brought online. Control can then be transferred to the Standby controller to make it the new Primary controller.
  - To upgrade the controller Execs
    - With Concept 2.1/2.2, the process must be stopped. Then Primary and Standby controllers must be stopped and downloaded individually.
    - Under Concept 2.5, the controller executives can be upgraded while the process continues to run.
-

---

# Theory of 984 Ladder Logic HSBY Operation

# 2

---

## At a Glance

### Purpose

This chapter covers the 984 Hot Standby and its theory of operation.

### What's in this Chapter?

This chapter contains the following topics:

Topic	Page
How a 984 HSBY System Works	32
System Scan Time	33
The State RAM Transfer and Scan Time	36
Default Transfer Area	38
Customizing Options	40
Custom Scans	41

---

## How a 984 HSBY System Works

---

### 984 Theory

Both the Primary and the Standby backplanes contain a CHS 110 Hot Standby module. The modules monitor their own controller CPU and communicate with each other via fiber link. The Primary controller keeps the Standby informed of the current state of the application by transferring state RAM values to the Standby controller during every logic scan. RIO head communications are also verified.

---

### Stages of State RAM Transfer

A Hot Standby system transfers state RAM data from the Primary to the Standby controller while the Primary controller scans and solves the ladder logic application program. There are three steps in this transfer process:

1	Primary controller-to-Primary CHS 110 state RAM transfer.
2	Primary CHS 110-to-Standby CHS 110 state RAM transfer.
3	Standby CHS 110-to-Standby controller state RAM transfer.

---

### State RAM Transfer

The Primary CHS 110 Hot Standby module initiates the state RAM transfer operation. The module requests specified state RAM information from the Primary controller.

At the beginning of each scan, the Primary controller transfers the current state RAM data to the CHS 110 Hot Standby module.

As soon as the transfer (controller-to-CHS 110) finishes, the Primary controller resumes scanning user logic and servicing I/O. The state RAM data is simultaneously transferred from the Primary CHS 110 module to the Standby CHS 110 module over the fiber optic link at a rate of 10 megabaud. In turn, the Standby CHS 110 module transfers the state RAM data to the Standby controller.

<p><b>Note:</b> Schneider Electric defines State RAM as RAM memory that is used to hold register and discrete inputs and outputs and internal data storage. State RAM is allocated to the four different reference types: 0xxxx, 1xxxx, 3xxxx, and 4xxxx.</p>
---

---



## System Scan Time

### Effect on System Scan Time

When the ladder logic program being executed by the primary controller is longer than the CHS 110-to-CHS 110 transfer, the transfer does not increase total system scan time. However, if the ladder logic program is relatively short, the scan finishes before the CHS 110-to-CHS 110 data transfer and the data transfer increases total system scan time.

The following timing diagram shows how the transfer takes place.

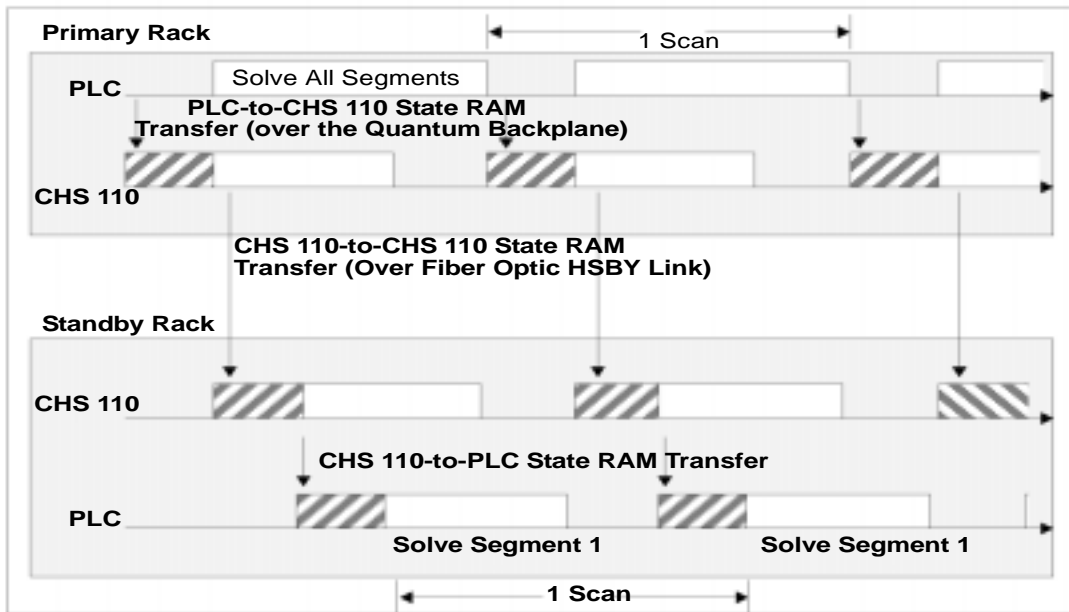

The effect on system scan time of any Hot Standby system depends very much on how much state RAM is going to be transferred from Primary to Standby. A Hot Standby system always has a higher scan time than a comparable standalone system because of the required PLC to CHS data transfer time.

Since the data transfer depends on the PLC type in the system, the following provides information that allows you to forecast a Hot Standby system's scan time:

- Calculation of overall scan time for a normal Hot Standby baseline configuration containing minimum logic as a reference
- Calculation of a PLC specific constant that expresses the increase of overall scan time related to an increase of state RAM memory to be transferred

The normal Hot Standby configuration contains:

- In the local rack: power supply (CPS), PLC (CPU), RIO Head (CRP 93x), Hot Standby module (CHS)
- In one remote IO drop equipped with 8 I/O modules, power supply (CPS) and remote adapter (CRA)
- Only the logic for the scan time evaluation

**PLC Scan Times**

The scan time increase with different PLCs, after adding HSBY, is outlined in the **Scan Time Increase** table below.

CPU - HSBY Baseline Configuration	Scantime Increase because of HSBY	Languages Supported
CPU x13 0x0x: 1536, 1x: 512, 3x: 3000, 4x: 1872	~ 25 ms	984 Ladder Logic only
CPU 424 020x: 1536, 1x: 512, 3x: 1212, 4x: 1872	~ 40 ms	984 Ladder Logic only
CPU 434 12 / CPU 534 140x: 1536, 1x: 512, 3x: 512, 4x: 1872	~ 40 ms	984 Ladder Logic only

**PLC to CHS Data Transfer Rate**

The investigation of the PLC specific data transfer rate in a Hot Standby system leads to the following results.

CPU x13 0x	1.6 ms / byte
CPU 424 02	2.0 ms / byte
CPU 434 12 / CPU 534 14	1.9 ms / byte

**State RAM**

The following table lists the number of bytes required for reference storage in state RAM.

Coil (0x)	3 bit
Discrete (1x)	3 bit
Input Register (3x)	2 bytes
Holding Register (4x)	2 bytes plus 2 bit

Based on the data shown in the tables above you may forecast the overall scan time of a Hot Standby system once you know how much state RAM is going to be transferred and the time required for a particular logic application to be executed in a standalone system.

**Example**

This example shows the effect of a configuration change from baseline as shown in the **Scan Time Increase Table** in *PLC Scan Times*, p. 34.

A particular HSBY application has a standalone scan time of 36 ms in a PLC of type CPU 424 02. The state RAM to be transferred consists of 3000 coils (0x), 2500 discrete inputs (1x), 2500 input registers (3x) and 8000 holding registers (4x).

The state RAM difference to the reference configuration is shown in the **Effects of a Configuration Change from Baseline** table below:

0x3000 - 1563 = 1464	1464*3/8	=549 Bytes
1x2500 - 512 = 1988	1988*3/8	= 746 Bytes
3x2500 - 1212 = 1288	1288*2	= 2576 Bytes
4x8000 - 1872 = 6128	6128*2 + (6128*2/8)	= 13788 Bytes
Total: 17659 bytes = scan time offset = 17659 * 1.6ms ~ 28ms		

This application therefore would have an overall scan time in Hot Standby:  
 40 ms (reference with CPU 424 02 0x) added by HSBY  
 + 36 ms (standalone scan time)  
 + 28 ms (offset through configuration increase)  
 =104 ms

**Note:** No matter how long your transfer takes, it does not cause a watchdog timeout.

## The State RAM Transfer and Scan Time

### Reduce Scan Time

This section describes manipulating the state RAM transfer to reduce scan time

**Note:** The state RAM transfer area contains all the state RAM values that are passed between the Primary and Standby controllers. The size of the transfer area may be as large as the total size of your controller's state RAM or a portion containing critical I/O reference data types.

As the simplified block diagram below shows, all 0x references in the state RAM transfer area are transferred first, then all 1x references, followed by all the 3x references, and finally all the 4x references:

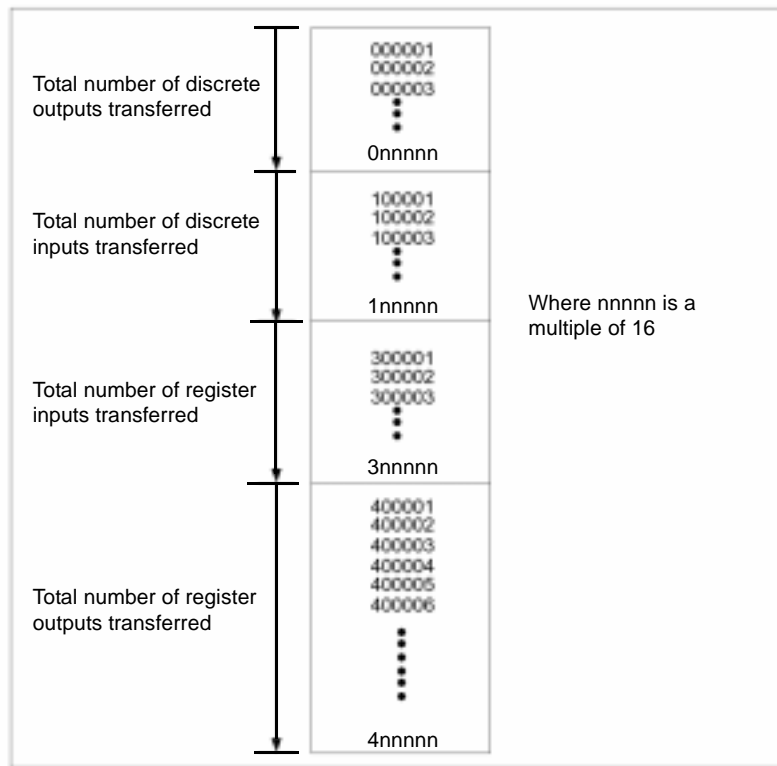

1. Reduce the reference configuration to minimum requirements (0x, 1x, 3x, 4x).  
Minimizing the state RAM area is one way to reduce scan time.
2. Another way is to define registers in a non-transfer area, an area contained within the state RAM transfer area but ignored during the actual state RAM transfer.
3. Use the HSBY configuration extension to define transfer amounts.

**Note:** If you are customizing the size of your state RAM transfer area, you must specify the number of each reference data type (0x, 1x, 3x, and 4x) as either 0 or a multiple of 16. In the case of the 4x registers, there must always be at least 16 registers allotted.

---

## Default Transfer Area

---

### **Automatic Transfer**

By default, the Hot Standby system automatically transfers the following from the Primary to the Standby controller on every scan:

- The first 8192 points of 0x output reference data
- The first 8192 points of 1x input reference data
- A total of 10K registers, of which 1K is allotted for 3x registers and 9K is allotted for 4x registers.

In any case, the number of 4x registers transferred is a multiple of 16 unless all 4x registers have been included. The number of 4x registers may slightly exceed the allotment in order to reach the next highest multiple of 16.

Any state RAM values above the limits shown in the following diagram are not included in the state RAM transfer area and therefore are not shared with the Standby controller. The state RAM values in the range above these limits must not contain the command register or control critical I/O.

The diagram below shows examples of the data transfer area for different configurations of 3x and 4x registers.

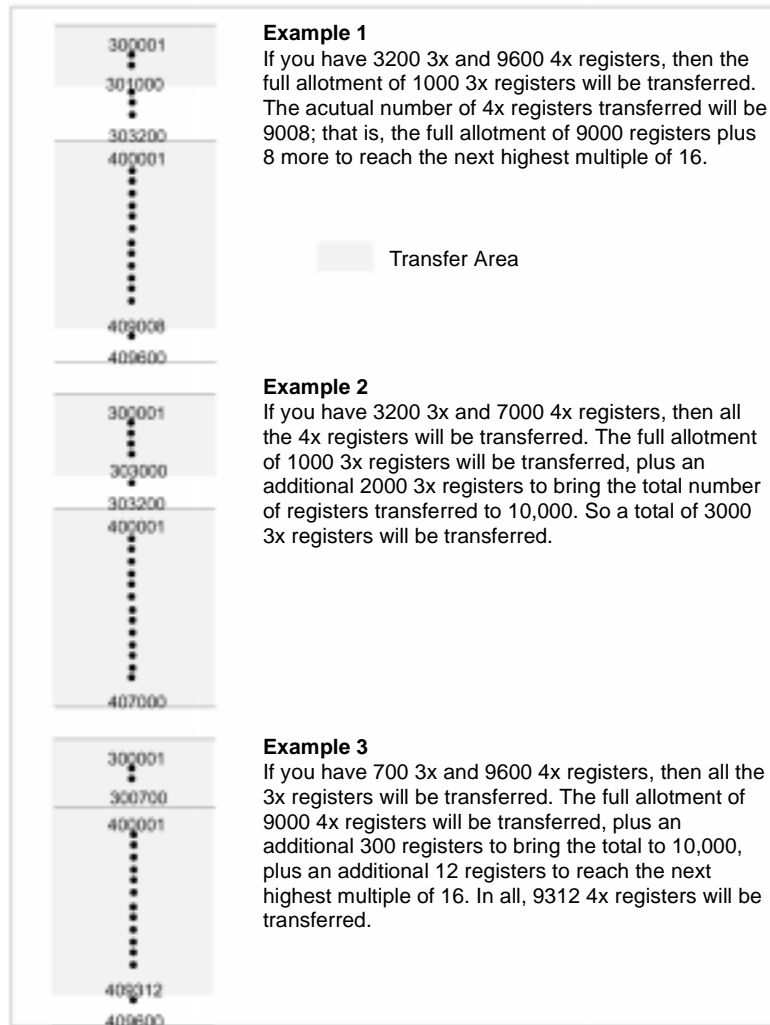

## Customizing Options

---

### Custom State RAM Transfer Area

If you want to set up a custom state RAM transfer area, you can control your transferred amounts using a Hot Standby configuration extension (refer to *Additional Guidelines for IEC Hot Standby*, p. 147). The configuration extension provides three alternatives to the default transfer area:

- You can define the number of 0x, 1x, 3x, and 4x reference data types that you want transferred in each scan.
- You can define a certain amount of reference data types to be transferred on each scan with additional data to be transferred in groups over multiple scans, beginning with 0x registers and proceeding in turn with 1x, 3x, and 4x registers.
- You can transfer all the configured reference data types in your system's state RAM on every scan.

These options allow you to design a transfer area that is as small as 16 4x output registers or large enough to encompass all of your controllers' state RAM (10K, 32K, or 64K, depending on the type of Quantum controllers you are using in your Hot Standby system).

The reference data of each type (0x, 1x, 3x, and 4x) is placed in the state RAM transfer area, starting at the lowest reference number (000001 for coils, 100001 for discrete inputs, 300001 for register inputs, and 400001 for register outputs). It is accumulated contiguously up to the amount of each data type you specify. The total number of each reference type in the state RAM transfer area must be a multiple of 16.

For example, if you indicate that the number of coils in the transfer area is 96, coils 000001... 000096 are transferred from the Primary to the Standby controller. Any 0x references beyond 000096 used in state RAM are not transferred.

The additional state RAM data to be sent over multiple scans can also be of any or all of the four reference data types, and must also be specified in multiples of 16. The additional reference data region for each data type starts at the lowest available reference number. For example, if 2048 coils are transferred on every scan (000001... 002048), and you schedule 1024 additional coils for transfer over multiple scans, references 002049... 003072 are used for the additional transfer data. The additional transfer is handled by specifying the number of scans over which you want to send the additional data. For example, if you specify two scans in which to transfer coils 002049... 003072, then coils 002049... 002560 are sent with coils 000001... 002048 on one scan and coils 002561... 003072 are transferred with coils 000001... 002048 on the next scan.

---



## Custom Scans

### Setting up Custom Scans

The following block diagram shows how the state RAM transfer area might be set up using multiple scans to transfer all the data.

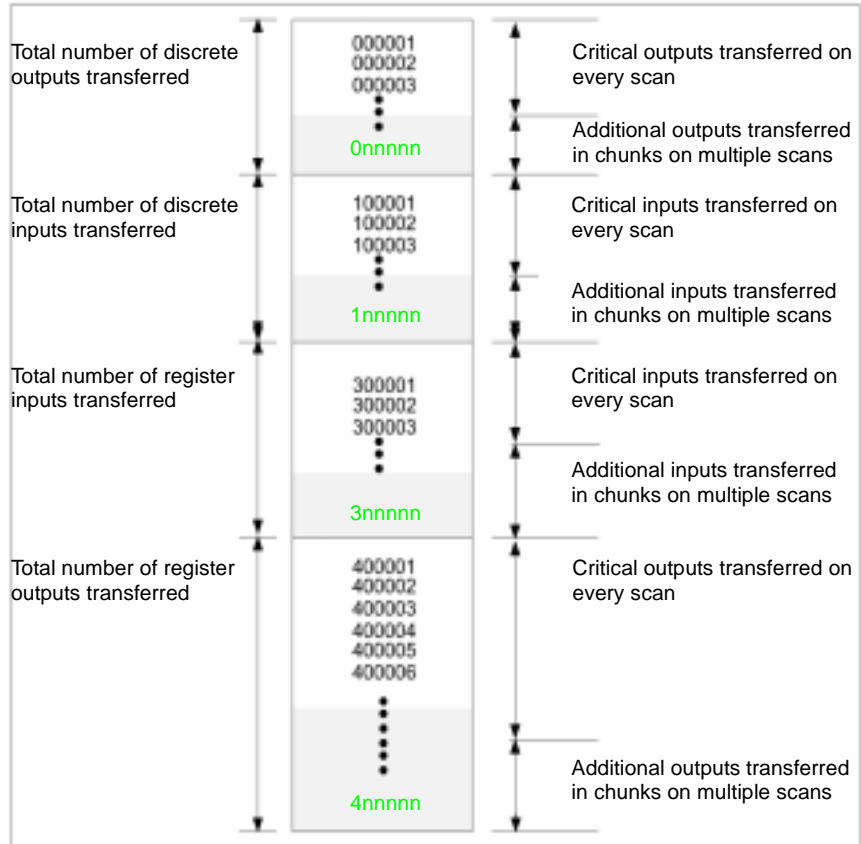



---

# Theory of IEC HSBY Operation

# 3

---

## At a Glance

### Purpose

This chapter presents the Theory of Operation for the IEC Hot Standby system.

### What's in this Chapter?

This chapter contains the following topics:

Topic	Page
IEC Hot Standby Definitions	44
How an IEC HSBY System Works	46
System Scan Time	47
State Ram Transfer and Scan Time	51
Layout of completely transferred state RAM in an IEC Hot Standby system	53

## IEC Hot Standby Definitions

---

### Definitions

The following are IEC Hot Standby definitions.

**Exec:** Quantum controller operating system with integrated IEC language support (IEC runtime system)

**Program Data:** A continuous memory block containing all program variables, including:

- Non-located IEC variables and constants declared in variable editor
- Links in FBD and LD sections
- Stack (loop) variables in IL and ST
- SFC states
- Literals
- Pointer lists
- Internal states of EFBs

**DFB Instance Data:** Multiple memory blocks containing:

- Internal data of each DFB instance
- Process diagnostics buffer
- Mirror buffer: 1 Byte per configured 0x/1x reference (only Concept 2.1 and older)
- Used references list: 1 Bit per configured 0x/1x reference

**IEC Heap:** One continuous memory block containing:

- Program data
- DFB instance data

**Maximum IEC Heap Size:** 128 KByte together with state RAM. If 10K Words (20 KByte) of state RAM are used already for I/O references the max. IEC heap size would be 128 KByte – 20 KByte = 108 KByte

**Currently used IEC Heap Size:** DFB instance data plus (configured) program data area size

**State Table:** Also called state RAM, controller references for both real world I/O and internal referenced (located) variables

**Project:** Concept program file containing controller configuration and IEC language control code

**Application:** Downloaded IEC language control code and data

---

**IEC Heap**

The most important new terms to understand in IEC Hot Standby are the IEC Heap, the Currently used IEC Heap Size and the Maximum IEC Heap Size.

---

**Program Data Area**

The program data area has a default size of 16 KByte whenever a new Concept project is created. Its size may be adjusted to the amount of memory that's really needed for a particular application. This can be done in the Memory Statistics Dialog while Concept is not connected to the PLC. This dialog can be activated through Online --> Memory Statistics.

Configure size of program data area at the Memory Statistics dialog in offline mode.

**Note:** Changing the configured size of the program data area results in a complete download of the application, no download changes are possible.

The maximum size of the IEC heap is the maximum amount of memory available for data in any particular IEC application. What this means in terms of IEC HSBY is shown in the diagram in *All State RAM transferred*, p. 52.

---

## How an IEC HSBY System Works

---

### IEC Theory

Both the Primary and the Standby backplanes contain a CHS 110 Hot Standby module. The modules monitor their own controller CPU and communicate with each other via fiber link. The Primary controller keeps the Standby informed of the current state of the application by transferring state RAM values to the Standby controller during every logic scan. RIO head communications are also verified.

---

### State RAM Transfer

A Hot Standby system transfers state RAM data from the Primary to the Standby controller while the Primary controller scans and solves the IEC logic application program. There are three steps in the transfer process:

Stage	Description
1	Primary controller-to-Primary CHS 110 state RAM transfer.
2	Primary CHS 110-to-Standby CHS 110 state RAM transfer.
3	Standby CHS 110-to-Standby controller state RAM transfer.

---

### State RAM Defined

**Note:** Schneider Electric defines State RAM as RAM memory that is used to hold register and discrete inputs and outputs and internal data storage. State RAM is allocated to the four different reference types: 0xxxx, 1xxxx, 3xxxx, and 4xxxx.

---

### State RAM Transfer Initiated

The state RAM transfer operation is initiated by the Primary CHS 110 Hot Standby module. The module requests specified state RAM information from the Primary controller.

At the beginning of each scan, the Primary controller transfers the current state RAM data to the CHS 110 Hot Standby module.

As soon as the controller-to-CHS 110 transfer finishes, the Primary controller resumes scanning user logic and servicing I/O. The state RAM data is simultaneously transferred from the Primary CHS 110 module to the Standby CHS 110 module over the fiber optic link at a rate of 10 megabaud. In turn, the Standby CHS 110 module transfers the state RAM data to the Standby controller.

---

## System Scan Time

---

### Effect on System Scan Time

The effect on system scan time of any Hot Standby system depends on how much state RAM is going to be transferred from Primary to Standby. A Hot Standby system always has a higher scan time than a comparable standalone system.

The following has been done to provide information that allows you to forecast a Hot Standby system's scan time:

- Calculation of overall scan time for a normal Hot Standby baseline configuration containing minimum logic as a reference
- Calculation of a PLC specific constant that expresses the increase of overall scan time related to an increase of memory to be transferred

The normal Hot Standby configuration state RAM contains:

- In the local rack: power supply (CPS), PLC (CPU), RIO Head (CRP 93x), Hot Standby module (CHS)
  - In one remote IO drop equipped with 8 I/O modules, power supply (CPS) and remote adapter (CRA)
  - Only the logic for the scan time evaluation
-

**Transfer diagram** The following shows a transfer diagram:

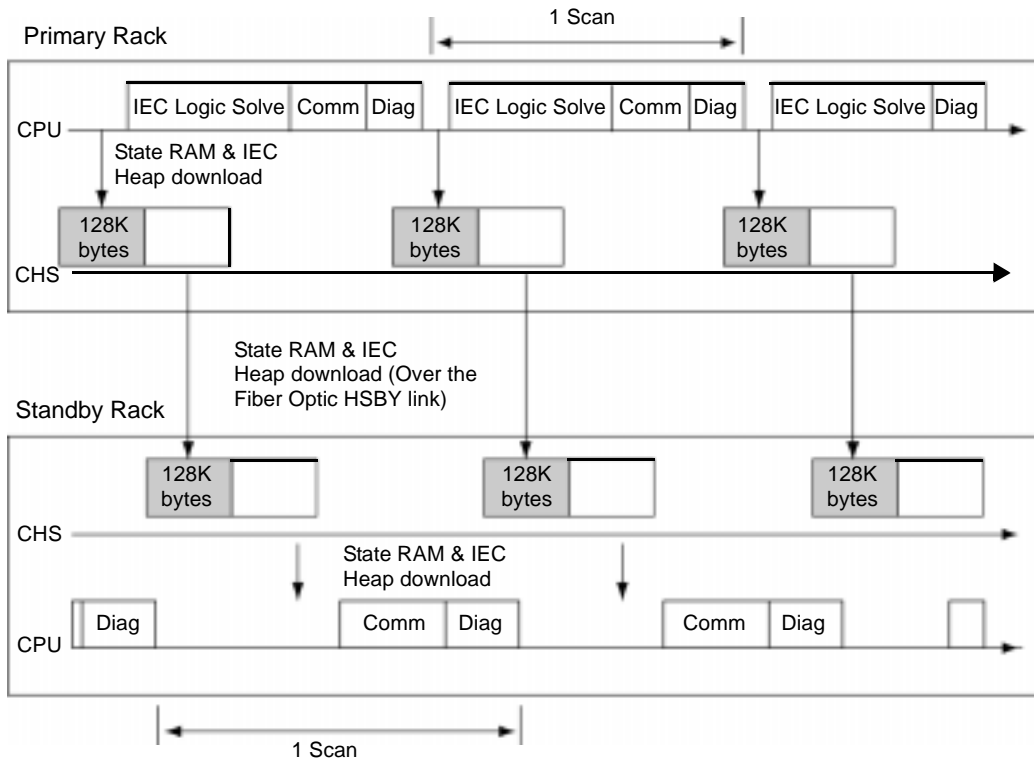

**Note:** The size of 128K bytes state RAM memory in the timing diagram being transferred with each scan is not a fixed value. It expresses the maximum amount of data handled by the CHS module during a data transfer. This is a hardware limitation. Therefore, the maximum State RAM limitation for the IEC user is 128 K bytes. Unlike a 984 HSBY system, the Standby controller doesn't solve any logic. With the new execs delivered with Concept 2.5, the Standby Controller solves logic in Section 1.



**Overall PLC Scan Time** The overall scan time for the IEC HSBY supporting PLC type is outlined in the **IEC Scan Time Increase Table** below.

<b>IEC Scan Time Increase</b>	
CPU - HSBY Baseline Configuration	Scantime Increase because of HSBY
CPU 434 12 / CPU 534 14 0x: 1536, 1x: 512, 3x: 512, 4x: 1872 IEC-HSBY registers (3x): 700	~ 40 ms

**PLC to CHS Data Transfer Rate** Calculating the PLC specific data transfer rate in a Hot Standby system leads to the following result.

CPU 434 12 / 534 14	1.9 ms / byte
---------------------	---------------

**State RAM** The following table lists the number of bytes required for reference storage

Coil (0x)	3 bits
Discrete (1x)	3 bits
Input Register (3x)	2 bytes
Holding Register (4x)	2 bytes plus 2 bits
IEC HSBY Register (3x)	2 bytes

**Example**

This example shows the effect of a configuration change from baseline as shown in the IEC Scan Time Increase Table (See *Overall PLC Scan Time*, p. 49).

A particular application has a standalone scan time of 25 ms in a PLC of type CPU 434 12. The state RAM to be transferred consists of 200 coils (0x), 300 discrete inputs (1x), 150 input registers (3x), 400 holding registers (4x) and 14000 IEC HSBY registers (3x).

The state RAM difference to the reference configuration is:

<b>Effects of a Configuration Change from Baseline</b>		
0x 200 - 1536 = - 1336	-1336*3/8	= - 501 Bytes
1x 300 - 512 = - 212	- 213*3/8	= - 80 Bytes
3x 150 - 512 = - 362	- 362*2	= - 724 Bytes
4x 400 - 1872 = - 1472	-1472*2 + ( - 1472*2/8)	= - 3312 Bytes
IEC Hot Standby regs 14000(3x) = 14000*2 = 28000 bytes Total = 28000 - 501 - 80 - 724 - 3312 = 23383 bytes Scan time offset = 23383*1.9ms ~ 44ms		

This application therefore would have an overall scan time in Hot Standby:

40 ms (reference with CPU 434 12/ 534 14)  
+ 25 ms (logic solve)  
+ 44 ms (offset through memory increase)  
= 109 ms

---

## State Ram Transfer and Scan Time

---

### Reduce Scan Time

The state RAM transfer area contains all the state RAM values that are passed between the Primary and Standby controllers. The size of the transfer area is as large as the total size of your controller's state RAM.

As the simplified block diagram below shows, all 0x references in the state RAM transfer area are transferred first, then all 1x references, followed by all the 3x references, and finally all the 4x references.

In the Quantum HSBY system, IEC HSBY does not allow customizing the transfer area. This means the whole state RAM is transferred in IEC HSBY, except for the nontransfer area, an area contained within the transfer area but ignored during the actual state RAM transfer. Placing registers in the nontransfer area is one way to reduce scan time because the Primary controller to CHS transfer time is shorter. With Concept 2.5, a new function called Section Transfer Control has been added which can be used to reduce scan time. See *Section Transfer Control*, p. 135 for further information on this feature.

<p><b>Note:</b> No matter how long your transfer takes, it does not cause a watchdog timeout.</p>
---

**All State RAM transferred**

The following diagram shows the state RAM transfer area.

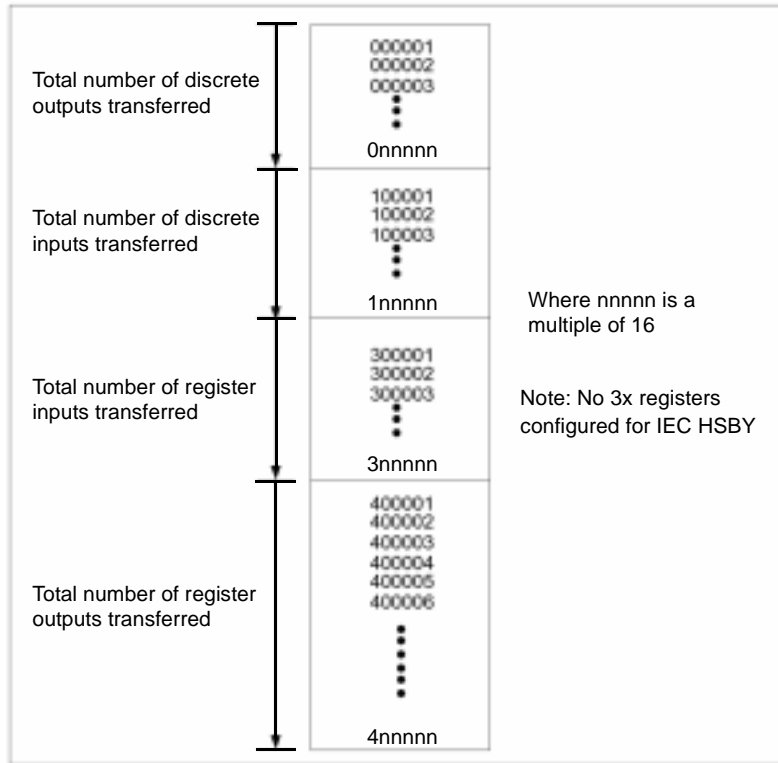

## Layout of completely transferred state RAM in an IEC Hot Standby system

### Layout of transferred RAM

The diagram below illustrates that a significant piece of the controller's state RAM is taken as a transfer buffer for copying the IEC heap from the Primary to the Standby controller. The transfer header is located at the very top of the transfer buffer. The transfer header contains information about the Primary's exec version, time synchronization information and the IEC application's version. This information allows the Standby controller, once it received the transfer buffer, to decide whether to remain online or go offline. When online, the Standby controller copies the Primary's IEC heap out of the transfer buffer into its internal memory, which ensures the Standby's IEC data consistency.

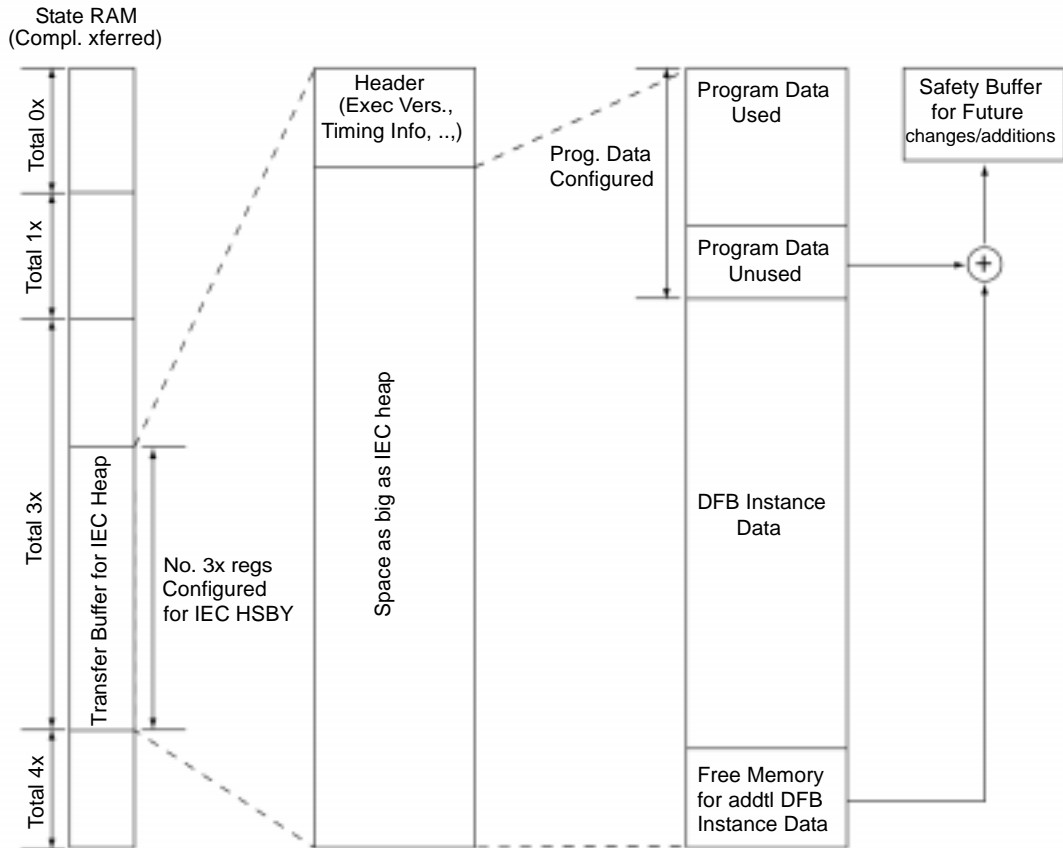



---

# Planning a Quantum Hot Standby System

# 4

---

## At a Glance

### Purpose

This chapter describes how to plan a Quantum Hot Standby System.

### What's in this Chapter?

This chapter contains the following topics:

Topic	Page
Guidelines for Planning a Hot Standby System	56
Electrical Safety Precautions	57
Remote I/O Cable Topologies	58
A Single Cable Configuration	59
A Dual Cable Configuration	60

## Guidelines for Planning a Hot Standby System

---

### Primary and Standby Controllers

Both the primary and the standby controller in your Hot Standby system must be ready to perform as a stand-alone controller in the event that its counterpart fails. Therefore, you should install them with equal care, according to Modicon's standard planning and installation guidelines. Refer to the *Quantum Automation Series Hardware Reference Guide*, 840 USE 100 00, and the *Remote I/O Cable System Planning and Installation Guide*, 890 USE 101 00, for details.

Design your system for safety first, then for economy. Be sure that you understand all the cautions and warnings in this manual before you begin to install your system. For the Hot Standby system to function, your component modules must meet the version requirements in *Overview of Quantum Hot Standby*, p. 13.

You must use identical modules in the primary and standby racks. If you have different models or different versions of the same model or different flash executive software, the Hot Standby system will not function properly.

**Note:** The order of the modules in the backplanes must be the same.

While the controllers and RIO heads must be Quantum models, the remote drops may use Quantum, 800 series, 500 series or 200 series I/O with corresponding drop processors.

### Positioning

The CHS 110 Hot Standby modules are connected by fiber optic cable. A 3 meter cable is supplied with the kit. However, the primary and standby backplanes may be placed as much as 1 km apart. If you will be placing the modules more than 3 m apart, use 62.5/125 micrometer cable with ST-style connectors. Refer to *Fiber Optic Cable Guide*, p. 213 for details.

If you intend to place the units more than 3 meters apart, you must consider the effect on the RIO network and any Modbus Plus network.

The controllers are linked to the RIO network by coaxial cable. The longer the distance between the controllers, the higher the grade of trunk cable required to maintain signal integrity. Refer to Chapter 3 of the *Remote I/O Cable System Planning and Installation Guide*, 890 USE 101 00, for details regarding cable grades, distances and signal integrity. If no coaxial cable will be sufficient to maintain signal integrity throughout the RIO network, fiber optic repeaters may be used to boost the signal. Refer to the *Modbus Plus Network Planning and Installation Guide*, 890 USE 100 00, for details on extending a Modbus Plus network.



## Electrical Safety Precautions

### Safety Precautions

	<p><b>WARNING</b></p>
	<p>To protect yourself and others against electric shock, obey your national electrical code and all applicable local codes and laws. When you plan the installation of the electrical cabinets which enclose the system's electronic components, be sure each cabinet is connected separately to earth ground and that each backplane is connected to solid ground within its cabinet.</p> <p><b>Failure to follow this precaution can result in death, serious injury, or equipment damage.</b></p>

## Remote I/O Cable Topologies

---

### Cable Connections

In each configuration:

- The cables connecting the RIO head processors to the RIO network must be fitted with self-terminating F adapters.
- An MA-0186-100 coaxial splitter must be installed between the RIO head processors and the RIO network.
- The remote drops must be connected to the trunk cable via an MA-0185-100 tap and a 97-5750-000 (RG-6) drop cable.
- The last tap on a trunk cable must be terminated with a 52-0422-000 trunk terminator. Remote drops must not be connected directly to the trunk cable.

Refer to the *Remote I/O Cable System Planning and Installation Guide*, 890 USE 1001 00, for details.

**Note:** If you are using a HSBY for data logging, the RIO heads must be configured and connected with coaxial cable.

- If you are using 984, you must configure 2 or more segments.
- If you are using IEC, you must configure 2 or more RIO drops.

**Note:** For illustrations of both single cable and double cable configurations, please see *A Single Cable Configuration*, p. 59 and *A Dual Cable Configuration*, p. 60.

---

## A Single Cable Configuration

### Diagram of a Single Cable Configuration

The following diagram shows a single cable configuration for the Quantum Hot Standby system.

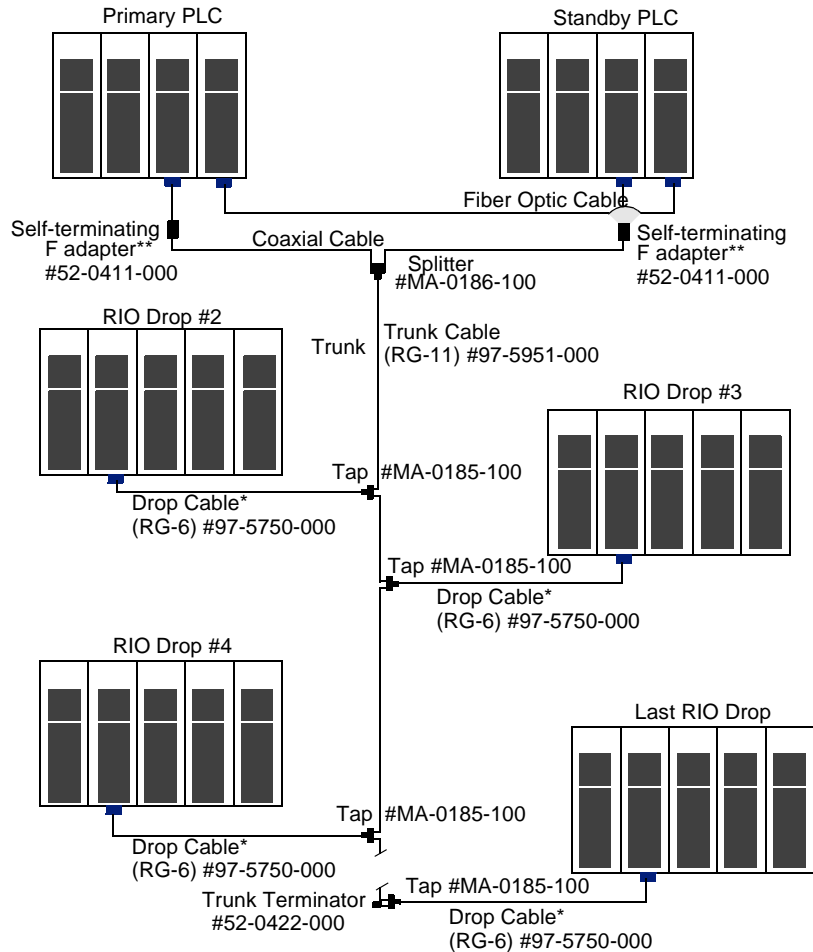

\*Premade RG-6 Drop Cable  
 50' (14m) AS-MBII-003  
 140' (43m) AS-MBII-004

\*\*140 CHS 320 00 kit includes:  
 2 Splitters  
 4 F Adapters  
 2 Terminators  
 See CHS 210 Hot Standby Kit for entire  
 HSBY kit contents (140 CHS 210 00).

## A Dual Cable Configuration

### Diagram of a Dual Cable Configuration

The following diagram shows a dual cable configuration for the Quantum Hot Standby system.

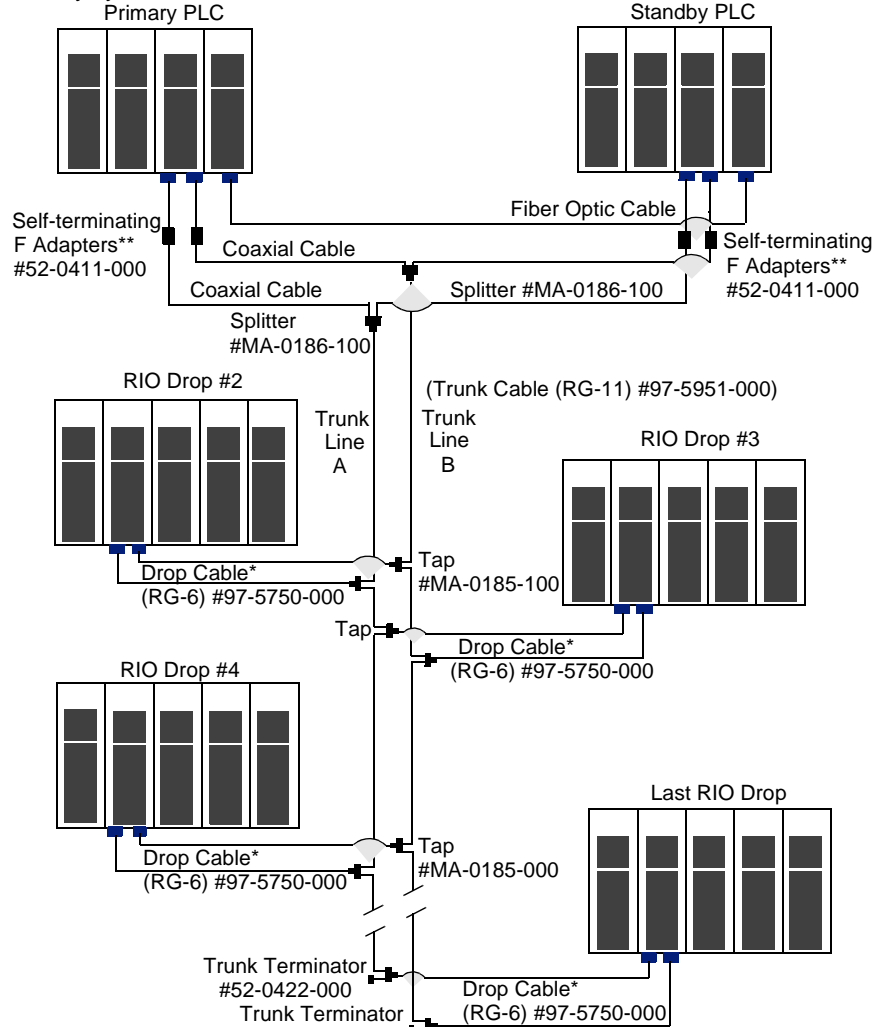

\*Premade RG-6 Drop Cable  
 50' (14m) AS-MBII-003  
 140' (43m) AS-MBII-004

\*\*140 CHS 320 00 kit includes:  
 2 Splitters  
 4 F Adapters  
 2 Terminators  
 See CHS 210 Hot Standby Kit for entire HSBY kit contents (140 CHS 210 00).

---

# Installation

# 5

---

## How to Install a Hot Standby System

### Procedure

This section discusses the procedure for installing a new Hot Standby system. For more detailed instructions, refer to the *Quantum Automation Series Hardware Reference Guide*, 840 USE 100 00 or the *Remote I/O Cable System Planning and Installation Guide*, 890 USE 101 00.

### Installing a Hot Standby System

- Install the power supplies, controllers, RIO head processors, hot standby modules and any option modules in the primary and standby backplanes. Be sure:
- The modules meet the version requirements listed in *Overview of Quantum Hot Standby*, p. 13.
- The modules in the primary backplane are identical to those in the standby backplane.

**Note:** The order of the modules in the backplanes must be the same.

- The rotary address switches on the back of each controller are set. The controllers may have different addresses. It is strongly recommended that the rotary address switches be set to the same address to eliminate any network address conflicts. The same advice applies to the NOM. For details on setting the switches, see the *Quantum Automation Series Hardware Reference Guide* or the *Remote I/O Cable System Planning and Installation Guide*.

The following diagram illustrates installation of a Hot Standby System.

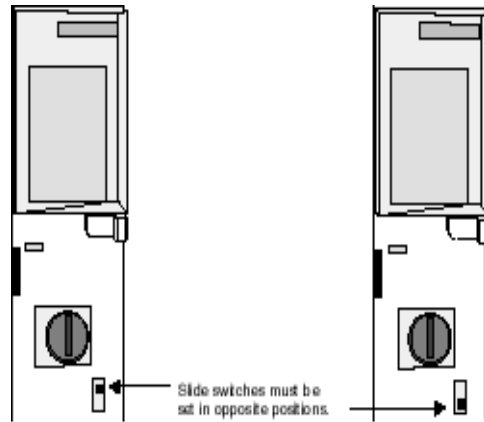

### Setting Designation Slide Switches

The designation slide switch on one Hot Standby module is set to A and the other is set to B.

	<b>CAUTION</b>
	<p style="text-align: center;"><b>HAZARD</b></p> <p>Before installing any controller in your Hot Standby system, be sure its battery has been disconnected for at least five minutes.</p> <p><b>Failure to follow this precaution can result in injury or equipment damage.</b></p>

**Note:** Be sure your system meets the power and grounding guidelines outlined in Appendix D of the Quantum Automation Series Hardware Reference Guide, 840 USE 100 00.

### Connect Network

The following diagram shows how to connect the network.

Step	Action
1	Install a splitter and a self-terminating F adapter between the primary RIO head processor and the RIO network.
2	Connect the coaxial cable link.
3	Connect the cable between the splitter, another self-terminating F adapter and the standby RIO head processor

## Network Connections

The following diagram illustrates the network connections.

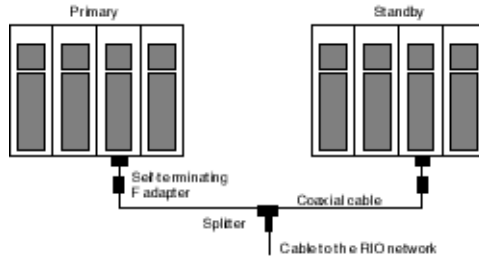

## Installing Coaxial Cable Link

Connect the fiber link between the Hot Standby modules, making sure the cable is properly crossed, so that the transmit cable connector of each module is linked to the receive cable connector of the other. Follow these instructions:

Remove the protective plastic coverings from the cable ports and the tips of the cable. Snap one of the fiber cable clasps onto the cable, carefully pressing the cable through the slot so that the wider end of the clasp is closest to the boot. The following diagram shows the installation of a coaxial cable link.

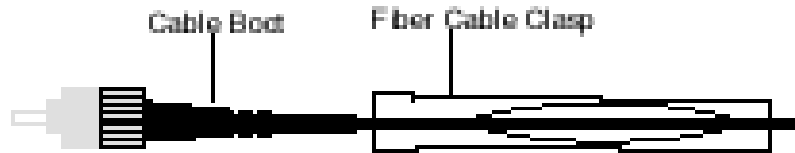

**Attaching the Fiber Cable Clasp to the Cable**

The key to installing the cable is to align the barrel, the locking ring and the connector, as shown in the diagram below.

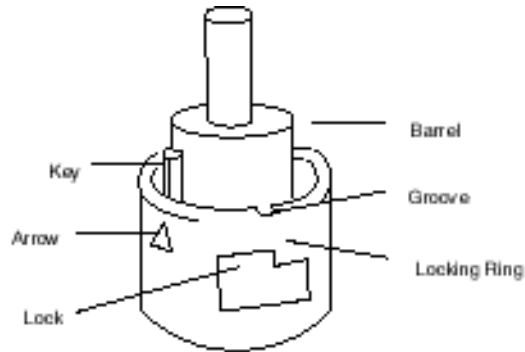

**Aligning the Key and Locking Ring**

The table below shows how to align the key and locking ring.

Step	Action
1	Turn the locking ring to align an arrow with the key.
2	Then align the key with the keyway. As a result, the locking tab, groove and lock should also be aligned.
3	Slide the clasp up to the locking ring.
4	Gripping the cable with the clasp, plug the cable into the lower (receive) cable connector. If it does not connect easily, realign the key with the arrow and try again.



### Diagram of Aligning Key and Locking Ring

The diagram below illustrates the alignment of the key and locking ring.

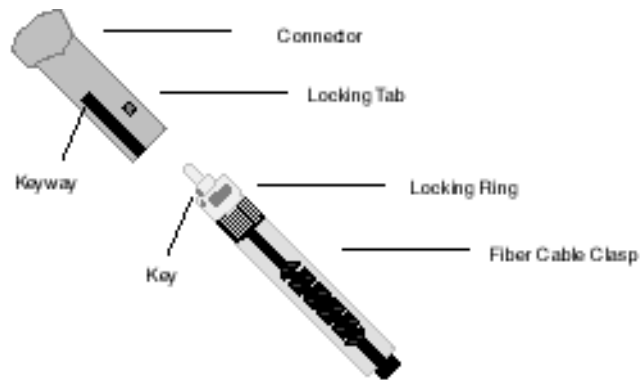

### Attaching the Cable

Turn the cable to the right, so that the tab locks securely. You may leave the fiber cable clasp on the cable for future use, but slide it off the boot of the cable to allow the module door to close.

Repeat this process with the remaining strand of cable and the upper (transmit) cable connector.

**Note:** Remember that each strand of cable must be connected to the upper (transmit) cable connector on one Hot Standby module and the lower (receive) cable connector on the other. If the cable is not properly connected, the modules will not be able to communicate and the Standby will remain offline.

**Note:** One strand of the cable provided in the CHS 210 Hot Standby kit is marked—for instance, with the manufacturer's name. This is the only way to distinguish the two strands.

**Adding Hot Standby Capability to an Existing System**

To add Hot Standby capability to an existing Quantum system, you must install a second backplane with modules identical to those in the original backplane. Keep the following requirements in mind:

You must remove any local I/O and distributed I/O networks from the original backplane, because they will not be supported at switchover.

The diagram below shows that local I/O must be removed.

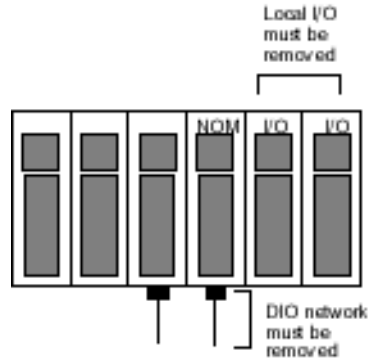

**Converting to Hot Standby System**

You need backplanes with at least four slots.

The components in both backplanes must meet the version requirements listed. You must install a splitter and a self-terminating F adapter between the original RIO head processor and the RIO network. A second cable runs from the splitter to the Standby RIO head processor, through a second self-terminating F adapter. In general, you may follow the installation directions in this Chapter. However, as a precaution, you should first stop the controller and disconnect power to the system.

---

---

# Using a Quantum 984 HSBY System

# 6

---

## At a Glance

### Purpose

This chapter reviews the procedures for operating a Quantum 984 HSBY System.

### What's in this Chapter?

This chapter contains the following sections:

Section	Topic	Page
6.1	Configuration	69
6.2	Using the CHS Instruction Block	74
6.3	Using Configuration Extension	85
6.4	Operation	103

---



---

## 6.1 Configuration

---

### Introduction

---

**Purpose** This section describes Hot Standby configuration.

**Note:** To ensure correct operation of the HSBY system, the user must I/O map at least 1 RIO drop and 1 I/O module. This will ensure the proper diagnostic information is transferred between Primary and Standby CRPs.

---

### What's in this Section?

This section contains the following topics:

Topic	Page
Configuring 984 HSBY	70
Configuration Extension	72
CHS Instruction	73

---

## Configuring 984 HSBY

---

### CHS software

To configure a 984 HSBY system, you must load the CHS software into the controllers. The software is included on a diskette in the Hot Standby kit. Once you have loaded the software, you can choose how to proceed. You may control your Hot Standby system through ladder logic or you can use a configuration extension.

---

### The CHS Loadable

The logic in the CHS loadable is the engine that drives the Hot Standby capability in a Quantum control system. The CHS loadable gives you the ability to:

- specify the Hot Standby command register, which is used to configure and control Hot Standby system parameters
- define a Hot Standby status register, which can be used to monitor the real machine status of the system
- implement a CHS instruction in ladder logic

Unlike HSBY (a comparable loadable used for Hot Standby configurations in 984 controllers), the CHS instruction does not have to be placed in a ladder logic program. However, the CHS software must be loaded into the Quantum controller in order for a Hot Standby system to be supported.

---

### Installing the CHS loadable into the 984 Environment

The following steps are only necessary if the CHS loadable is not already part of your 984 installation. The CHS loadable is provided on a 3 1/2 diskette (140 SHS 945 00) as part of your 140 CHS 210 00 Hot Standby kit. The file is named QCHSVxxx.DAT, where xxx is the three-digit version number of the software.

Step	Action
1	Insert the diskette in the disk drive.
2	Either create a new Concept project or open an existing one and have a PLC selected
3	With the menu command Project Configurator, open the configurator.
4	With Configure Loadables, open the dialog box Loadables.
5	Press the command button Unpack to open the standard Windows dialog box, Unpack Loadable File. Select the loadable file, click the button OK and it is inserted into the list box Available.

---

### Modsoft

If you are using Modsoft, refer to the *Modicon Quantum Hot Standby System Planning and Installation Guide*, 840 USE 106 00 Version 1, Paragraph 5.1.1.

---

**Controlling the Hot Standby System by CHS instruction**

If you are upgrading from a 984 Hot Standby system to a Quantum system, you may port your ladder logic program by first deleting the HSBY block, then relocating the program, and then inserting a CHS instruction. This requires the CHS loadable to be installed into your application.

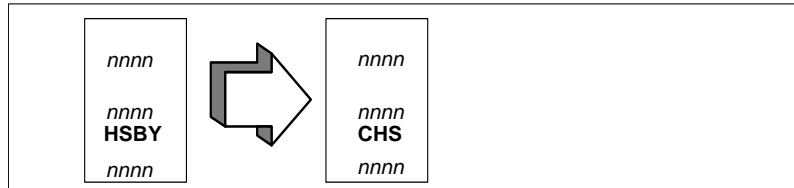

## Configuration Extension

---

### Controlling the Hot Standby System by Configuration Extension

With the Hot Standby configuration extension screens:

You can specify the parameters in the Hot Standby command register and customize the state RAM data transfer between the Primary and Standby units to help reduce scan time.

If you decide to control your system using the configuration extension, you still may want to program a CHS instruction in ladder logic. The CHS instruction allows you to use Zoom screens, which allows you to access and modify the command register while the system is running.

**Note:** If both a configuration extension and the CHS instruction are used, the configuration extension controls the Hot Standby system. The only function of the CHS instruction is to provide Zoom screens. The parameters in the configuration screens are applied by the controllers at startup. Once the controllers are running, the Zoom screens may be used to access and modify the command register. The changes are implemented during runtime, and can be seen in the status register. However, if the Hot Standby system is later stopped and then restarted, the parameters specified in the configuration extension screens go back into effect.

### Ladder Logic in a Hot Standby System

All ladder logic for Hot Standby functions should be in segment 1. Network 1 of segment 1 is reserved exclusively for the CHS instruction block and ladder logic directly associated with it.

- program all ladder logic specific to Hot Standby functions in segment 1 When the Hot Standby system is running, the Primary controller scans all segments, while the Standby controller scans only segment 1 of the configured ladder logic program. This has very important implications with respect to the way you configure system logic:
  - do not program I/O control logic in segment 1
  - do not schedule any I/O drops in segment 1
  - the Standby controller in a Hot Standby system must never execute I/O logic.
-



## CHS Instruction

### Using CHS Instruction

	<b>CAUTION</b>
	<p><b>Reschedule Segment Hazard</b></p> <p>To help protect against damage to application I/O devices through unexpected system actions, do not reschedule segment 1 via the segment scheduler.</p> <p><b>Failure to follow this precaution can result in injury or equipment damage.</b></p>

Segment 1 may contain the ladder logic for diagnostics and optional Hot Standby functions, such as time-of-day clock updates.

### Using the CHS Instruction to Control Your Hot Standby System

If you choose to use the CHS instruction in ladder logic to control the Hot Standby configuration, the instruction must be placed in network 1, segment 1 of the ladder logic program. The top node must be connected directly to the power rail by a horizontal short. No control logic, such as contacts, should be placed between the rail and the input to the top node. However, other logic may be placed in network 1. Remember, the ladder logic in the Primary and Standby controllers must be identical.

The three nodes in the CHS instruction define the command register, the first register in the nontransfer area, and the length of the nontransfer area.

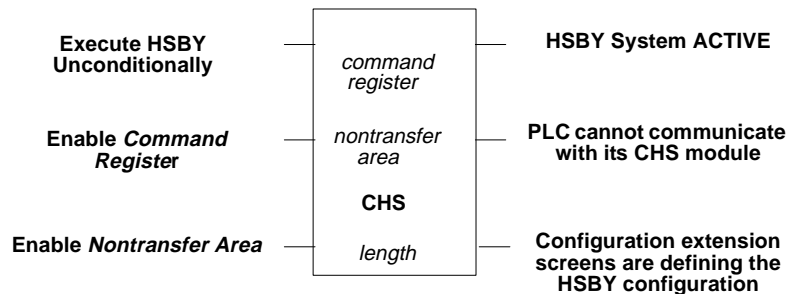

The bottom output node of the CHS instruction indicates whether the configuration extension screens have been activated and allows the parameters in the screens to override those in the CHS instruction at startup.

A detailed description of the CHS instruction is provided in the *Ladder Logic Block Library User Guide*.

## 6.2 Using the CHS Instruction Block

---

### Introduction

---

**Purpose** This section describes using the CHS Instruction Block.

---

**What's in this Section?** This section contains the following topics:

Topic	Page
Using CHS Instruction Block	75
Command Register	76
Elements of the Nontransfer Area	78
Zoom screen of CHS Instruction	80
The Hot Standby Status Register	81
The Reverse Transfer Registers	82
Reverse Transfer Logic Example	83

---

## Using CHS Instruction Block

### CHS Instruction Block

The command register is defined in the top node of the CHS instruction block. The bits in this register are used to configure and control various parameters of the Hot Standby system.

The command register must be a 4x register in the portion of the state RAM transfer area that is transferred from the Primary to the Standby controller on every scan. It also must be outside of the nontransfer area.

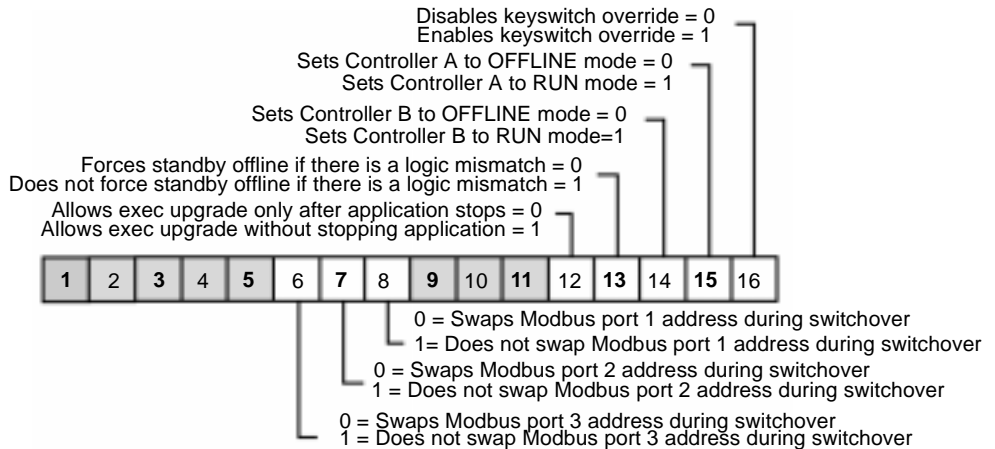

	<b>CAUTION</b>
	<b>Hot Standby Command Register Hazard</b>
	Take precautions to be sure the register you select as the Hot Standby command register is reserved for this purpose and not used for other purposes in ladder logic.
	<b>Failure to follow this precaution can result in injury or equipment damage.</b>

The values set for the bits in this register determine the system parameters at startup. The register can be accessed while the system is running using a reference data editor (RDE) or a Zoom screen on the CHS instruction in ladder logic.

## Command Register

---

### Command Register

	<b>CAUTION</b>
	<b>Command Register Hazard</b> If you use the command register to enable the keyswitch override while the Hot Standby system is running, the Primary controller immediately reads bits 14 and 15 to determine its own state and the state of the Standby. If both bits are set to 0, a switchover occurs and the former Primary CPU goes offline. The new Primary CPU continues to operate. <b>Failure to follow this precaution can result in injury or equipment damage.</b>

### The State RAM Transfer Area

The command register must be contained within the range of 4x registers in the state RAM transfer area.

A fixed block of up to 12K words in state RAM is specified as the transfer area. It consists of the following:

- All the 0x discrete outputs in state RAM up to a maximum of 8192, including their associated histories
- All the 1x discrete inputs in state RAM up to a maximum of 8192, including their associated histories
- If the total number of registers (3x and 4x combined) implemented in state RAM is 10,000 or less, then all the registers plus the up/down counter history table
- If the total number of registers (3x and 4x combined) implemented in state RAM is greater than 10,000, then a total of 10,000 is transferred, in accordance with the previously described formula. See *Default Transfer Area, p. 38*.

### Nontransfer Area Within the State RAM Transfer Area

You also must define a nontransfer area in the middle node of the the CHS instruction block. A nontransfer area:

- is a tool to reduce scan time
- is located entirely within the range of 4x registers in the state RAM transfer area which are transferred on every scan
- consists of a block of four or more 4x registers
- allows the user to monitor the status of the Hot Standby system (third register of non-transfer area)

Only 4x reference data can be placed in the nontransfer area. These designated registers are not transferred to the Standby controller, thus reducing scan time. The following block diagram shows how the nontransfer area exists with respect to the rest of the state RAM transfer area.

### Nontransfer Area Within the State RAM Transfer Area

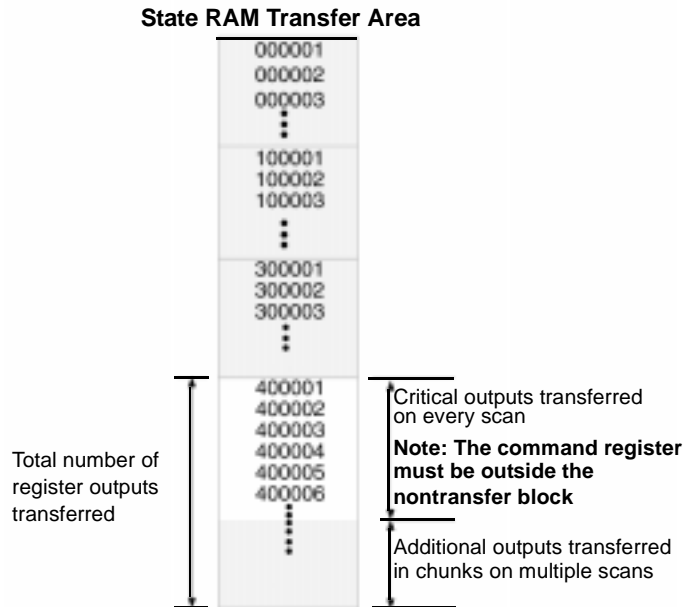

## Elements of the Nontransfer Area

**Nontransfer Area** The most important part of the nontransfer area is the Hot Standby status register. Once the system has been configured and is running, the status register becomes a valuable tool for monitoring the machine states of the two controllers. If you use software to change values in the command register, being able to see the result of those changes in the status register is very helpful.

The nontransfer area is defined in the middle and bottom nodes of the instruction block. The middle node specifies the first register in the nontransfer area. The bottom node specifies the length of the nontransfer area.

### Status Register

This PLC in OFFLINE mode = 0 1  
 This PLC running in primary mode = 1 0  
 This PLC running in standby mode = 1 1

The other PLC in OFFLINE mode = 0 1  
 The other PLC running in primary mode = 1 0  
 The other PLC running in standby mode = 1 1

PLCs have matching logic = 0  
 PLCs do not have matching logic = 1

This PLC's switch set to A = 0  
 This PLC's switch set to B = 1

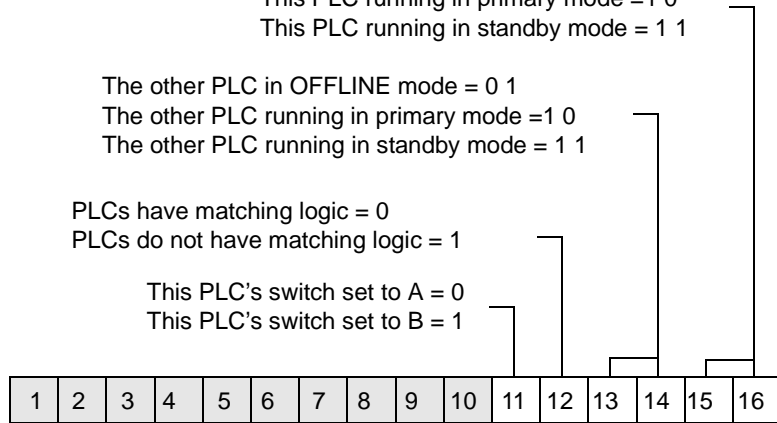

The nontransfer area must be at least four registers long. The first two registers in the nontransfer area are reserved for reverse transfer functions. The third register in the nontransfer area is the Hot Standby status register.

The fourth register and all other contiguous 4x registers specified for nontransfer are ignored when the state RAM values of the Primary controller are transferred to the Standby controller.

**Example of a Nontransfer Area** In the example, the nontransfer area begins at register 40010, as defined in the middle node. The length is 30 registers, as defined in the bottom node. Thus, the last register in the nontransfer area is 40039.

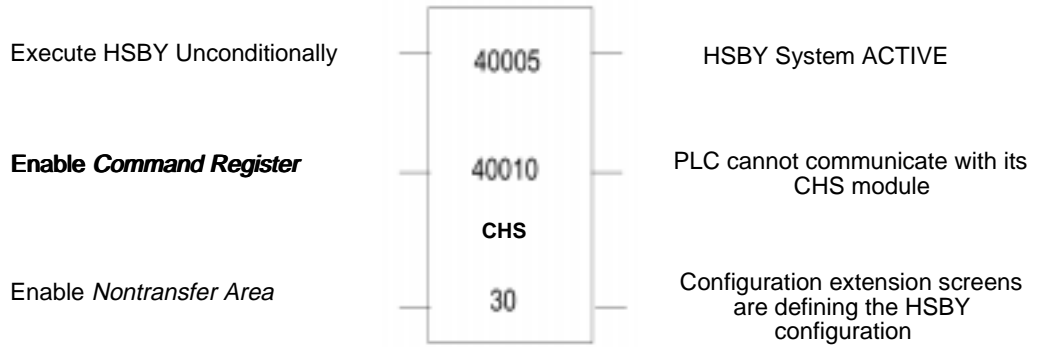

## Zoom screen of CHS Instruction

### Zoom Screen

When both a CHS instruction and the Hot Standby configuration extension are used, the parameters you set for the nontransfer area in the configuration extension screens must be identical to those in the CHS block.

**CHS : Quantum Hot Standby Control System** Page:  /2

Command Register	400001	INT	<input type="text" value="0"/>
Enable Key Switch Override	400001	BIT16	<input type="checkbox"/> Enable
Controller A in Run Mode	400001	BIT15	<input type="checkbox"/> Run Mode
Controller B in Run Mode	400001	BIT14	<input type="checkbox"/> Run Mode
Don't Force Standby offline if Logic Mismatch	400001	BIT13	<input type="checkbox"/> Don't Force
Allow Exec Upgrade Without Stopping	400001	BIT12	<input type="checkbox"/> Without Stopping
<div style="border: 1px solid black; padding: 2px; margin: 5px 0;"> <b>WARNING : Setting this Option overrides all safety checking between the primary and Hot Standby controllers. Use with extreme caution ! Reset it after use !</b> </div>			
Do not Swap Modbus port 1 address during Switchover	400001	BIT08	<input type="checkbox"/> No Swap
Do not Swap Modbus port 2 address during Switchover	400001	BIT07	<input type="checkbox"/> No Swap
Do not Swap Modbus port 3 address during Switchover	400001	BIT06	<input type="checkbox"/> No Swap

[ See Quantum Hot Standby Handbook for Layout of CMD Reg. ]



## The Hot Standby Status Register

### Hot Standby Status Register

The status register is register 40012, the third register in the nontransfer area. The command register, which is defined in the top node, has been placed outside the nontransfer area, as required.

The third register in the nontransfer area is the status register. Use this register to monitor the current machine status of the Primary and Standby controllers.

### Bits in the Hot Standby Status Register

In the example, the status register is 40012.

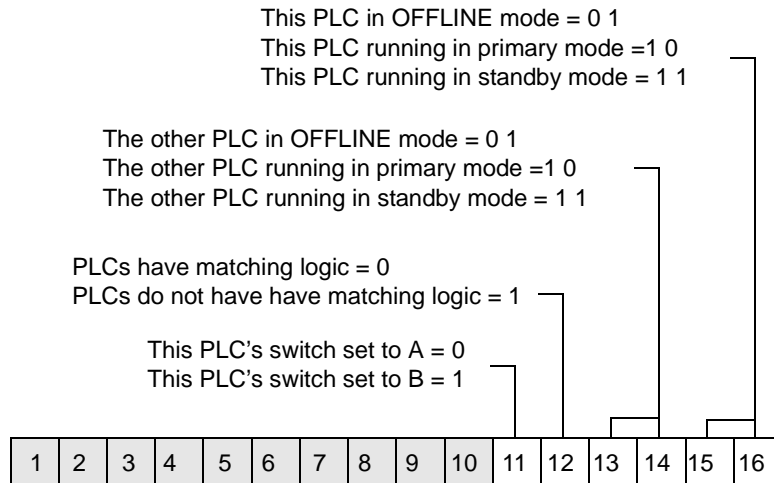

## The Reverse Transfer Registers

---

**Reverse Transfer** You can use the reverse transfer registers to transmit diagnostic data from the Standby controller to the Primary controller. When you choose to define a nontransfer area, registers  $4x$  and  $4x + 1$  in the nontransfer block are copied from the Standby to the Primary controller. This is opposite from the normal forward state table transfer from the Primary to the Standby.

If you choose not to use the reverse transfer registers, do not connect the CHS bottom input to the rail in your ladder logic program, so the inputs to these registers are not enabled.

---

## Reverse Transfer Logic Example

### A Reverse Transfer Logic Example

The following example shows I/O ladder logic for a Primary controller that monitors two fault lamps and the reverse transfer logic that sends status data from the Standby controller to the Primary. One fault lamp turns ON if the Standby memory protect is OFF; the other lamp turns ON if the memory backup battery fails in the Standby.

Network 1 of Segment 1

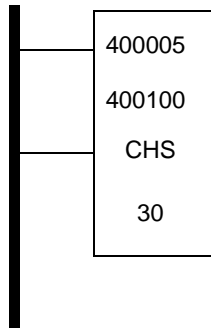

Network 2 of Segment 1

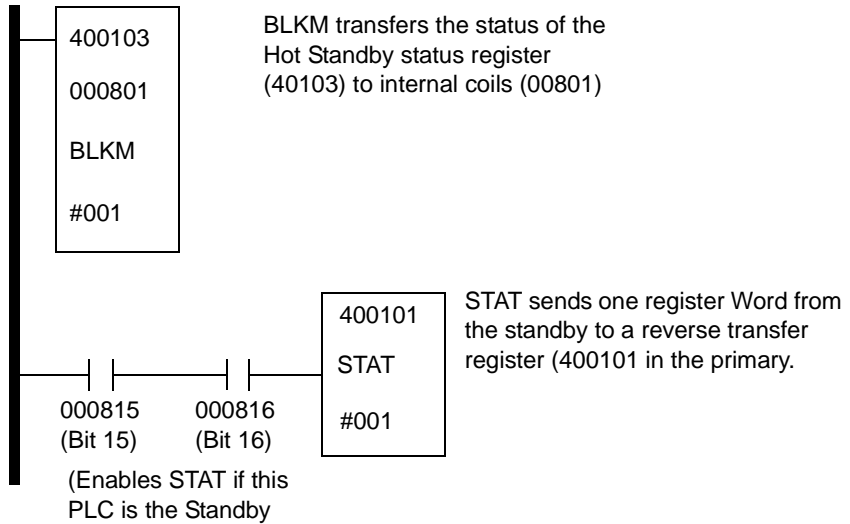

**Reverse Transfer Logic**

The logic in network 2 of segment 1 contains a BLKM instruction and a STAT instruction. The Standby enables the STAT. Bits 000815 and 000816 are controlled by bits 15 and 16 in the Hot Standby status register. The STAT instruction sends one status register word to 400101; this word initiates a reverse transfer to the Primary controller.

**Remote I/O Logic**

Internal coil bit 000715 (status bit 11) controls the STANDBY MEMORY PROTECT OFF lamp. Internal coil bit 000716 (status bit 12) controls the STANDBY BATTERY FAULT lamp.

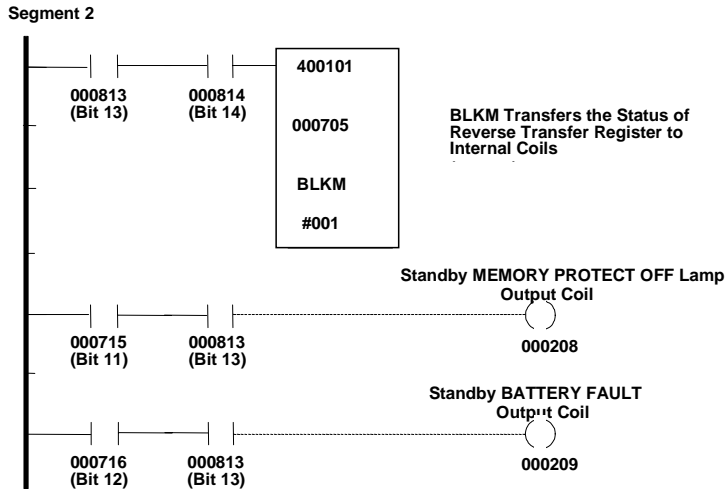

---

## 6.3 Using Configuration Extension

---

### Introduction

---

**Purpose** This section describes using the HSBY Configuration Extension.

---

**What's in this Section?** This section contains the following topics:

Topic	Page
Configuration Extension	86
Hot Standby Dialog	87
Bits in the Hot Standby Command Register	88
Keyswitch Override and Run Mode	90
A Software Control Example	91
Standby on Logic Mismatches	92
Transfer All State RAM	94
Hot Standby Status Register for Configuration Extension	95
Advanced Options	96
Defining the Transfer Area of State RAM	97
Transferring Additional State RAM Data	100
Scan Transfers	102

---

## Configuration Extension

---

### Hot Standby Dialog

The configuration of the 984 Hot Standby can be done with the Hot Standby dialog and/or with the CHS instruction of the LL984 instruction library.

Concept shown

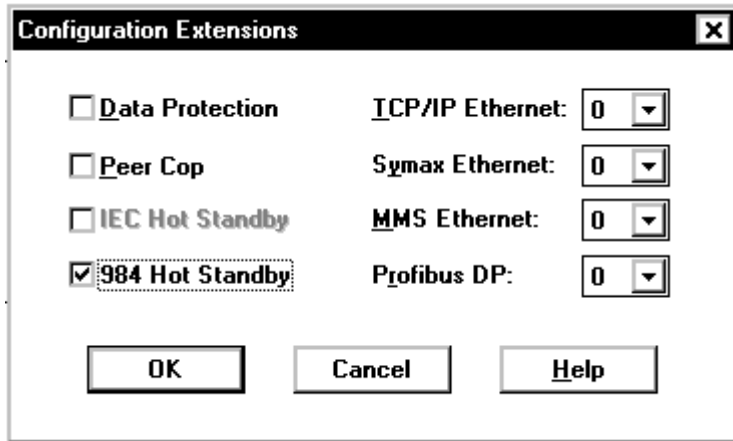

## Hot Standby Dialog

### Hot Standby Dialog in Concept

The Hot Standby dialog is shown below, it can be activated through Configure Hot Standby.

Concept shown

**Hot Standby** [X]

**Command Register**

Command Register: 4x 1

**Run Mode**

Controller A: Offline

Controller B: Offline

**Standby On Logic Mismatch**

Offline

Running

**Keyswitch Override**

Enable

**Swap Address at Switchover**

Modbus Port 1

Modbus Port 2

Modbus Port 3

**Advanced Options...**

**State RAM**

Transfer All State RAM

**Non-Transfer Area**

Start: 4x 0 Length: 0

**Options...**

**OK** **Cancel** **Help**

## Bits in the Hot Standby Command Register

### Specifying the Command Register

The command register is used to control various parameters of the Hot Standby system.

### Command Register

The command register is specified in the first entry field of the Hot Standby dialog. By default, the command register is set to 400001. If register 400001 is used elsewhere, enter another number greater than 0. The number you enter becomes the 4x command register. For example, if you enter 14, the hot Standby command register is 400014.

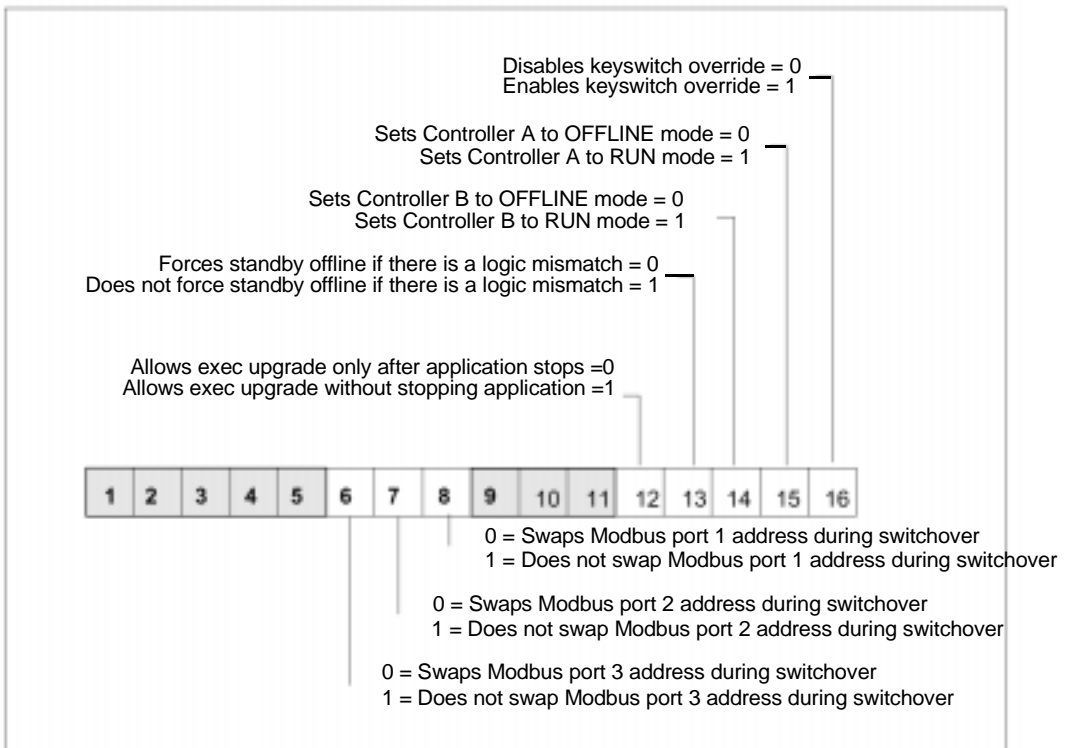



You may enter any number in the range 1... n, where n is the last configured 4x register. However:

- The command register must be part of the area of state RAM that gets transferred from the Primary to the Standby controller on every scan.



- Therefore, the number you specify for the command register must be in the range of 4x registers you specify in the State RAM area in State RAM dialog. If you are using the 12K option, the command register must be one of the first 9000 4x registers.
- The command register must not be within the range of the nontransfer area, which you specify in the nontransfer area of the Hot Standby dialog.

	<b>CAUTION</b>
	<b>Hot Standby Command Register Hazard</b> Be sure the register you select as the Hot Standby command register is reserved for this purpose and not used for other purposes elsewhere in user logic. <b>Failure to follow this precaution can result in injury or equipment damage.</b>

	<b>CAUTION</b>
	<b>Hot Standby Dialog Hazard</b> If you intend to use the Hot Standby dialog to configure the command register and the CHS instruction to modify the command register during runtime, make sure that you specify the same register as the command register in Hot Standby dialog and the top node of the CHS block. If you use different numbers for the command register, the changes that you make via the Zoom screen are not applied to the real Hot Standby command register. <b>Failure to follow this precaution can result in injury or equipment damage.</b>

## Keyswitch Override and Run Mode

---

### Keyswitch and Run

You may choose to override the keyswitch on the front panel of the CHS 110 modules for security or convenience. If you override the keyswitch, the command register becomes the means for taking the CHS 110 modules on or offline. By default, the keyswitch override is disabled. The Hot Standby dialog allows you to enable it.

---

### Keyswitch Override

If you enable the keyswitch override, the Offline/Running operating mode of the controllers at startup is determined by the values you set to bits 14 and 15 of the command register. These bits are represented as the Run Mode for controller A and B (depends on designation slide switch). Remember, that when the keyswitch override is enabled you can not initiate a program update (program xfer) at the CHS 110 module in the Standby rack.

As long as the keyswitch override is disabled, the settings for the Run Mode can be ignored.

	<b>CAUTION</b>
	<b>Keyswitch Override Hazard</b> If you use the Zoom screen or RDE to enable the keyswitch override while the Hot Standby system is running, the Primary controller immediately reads bits 14 and 15 to determine its own state and the state of the Standby. <b>Failure to follow this precaution can result in injury or equipment damage.</b>

If both bits are set to 0, a switchover occurs and the former Primary CPU goes offline. The new Primary CPU continues to operate.

---

## A Software Control Example

### Using Software Control

For example: you enabled the keyswitch override and set the operating mode of controller B to Offline. Now the system is powered up and you want to put controller B in RUN mode.

The keyswitch does not work, so you must rely on user logic. There are three ways you can proceed:

Option 1	<b>Change the setting on the Hot Standby dialog. To do this, you must shut down the system and make the necessary change in the dialog, then power up the system again. Download the new configuration.</b>
Option 2	Connect Concept to your Primary controller. Call up the reference data editor (RDE). Place the Hot Standby command register and the Hot Standby status register in the RDE. The operating mode of controller B is determined by the state of bit 14 of the command register. If controller B is offline, bit 14 is set to 0. To put the controller in RUN mode, change the state of bit 14 to 1. Controller B immediately goes into RUN mode if all other HSBY requirements are healthy.
Option 3	If you have programmed a CHS instruction into the ladder logic: Connect Concept to your Primary controller. In the editor, place the cursor on the top node of the CHS instruction and invoke the Zoom screen (CTRL+D). Check the Run Mode checkbox for parameter Controller B in Run Mode and controller B immediately goes into RUN mode. The advantage of options 2 and 3 is that the Hot Standby system does not have to be shut down in order to change its status. If you find the use of the Zoom screen more comfortable than the RDE, consider programming a CHS instruction into ladder logic for purposes such as this.

## Standby on Logic Mismatches

---

### Logic Program

To function properly, the Primary and the Standby controller in a Hot Standby system must be solving an identical logic program, which is updated on every scan by a state RAM data transfer between the two controllers.

By default, the Standby controller is set to go offline if a mismatch is detected between its user logic and that of the Primary controller. Switchover cannot occur while the Standby controller is Offline.

The radio buttons provide you with the option to override this default. If you change the parameter in this field from Offline to Running, the Standby controller remains online if a logic mismatch is detected between its logic program and that of the Primary controller.

	<b>CAUTION</b>
	<b>Mismatch Hazard</b> A mismatch in the I/O map or configuration is not allowed under any circumstances. <b>Failure to follow this precaution can result in injury or equipment damage.</b>

	<b>CAUTION</b>
	<b>Switchover Hazard</b> If switchover occurs when the radio button is set to Running and there is a logic mismatch between the two controllers, the Standby controller will assume Primary responsibilities and will start solving a different logic program from the previous Primary controller. <b>Failure to follow this precaution can result in injury or equipment damage.</b>

---

**Swap Address at Switchover**

In a Hot Standby system, the Modbus ports on the Primary controller may have MEM addresses in the range of 1 to 119. This allows an offset of 128 for comparable ports on the Standby controller, with 247 the maximum number of addresses. For example, if controller A is the Primary controller and its two Modbus ports have addresses 1 and 2, then the default addresses for the comparable ports on Standby controller B are 129 and 130. By default, this offset is maintained between port addresses in the event of switchover. For example, if controller B becomes the Primary controller as the result of switchover, its Modbus ports assume the addresses of 1 and 2, and the comparable ports on controller A assume addresses 129 and 130.

The check boxes allow you to change this default condition on any or all of the Modbus ports on the two controllers in your Hot Standby system.

Modbus ports on the two controllers in your Hot Standby system. For example: if you deselect the parameter Modbus Port 1, then no offset is maintained at switchover and after switchover the two ports have the same address. Thus if controller A is the Primary controller and its Modbus port 1 address is 1, then that port address remains 1 after a switchover occurs. Likewise, if controller B becomes the Primary controller as a result of switchover, its Modbus port 1 address is also 1.

**Note:** If you change the selections, the port addresses are not affected until a switchover occurs.

**Modbus Plus Port Address Swapping at Switchover**

In a Quantum Hot Standby system, the Modbus Plus port addresses on the Standby controller are offset by 32 from the comparable ports on the Primary controller. For example, if controller A is the Primary controller and its Modbus Plus port has address 1, then the address for the corresponding port on Standby controller B is 33. The numerical range for addresses for both ports is 1 through 64. Thus, if the port on the Primary controller has address 50, then the address for the corresponding port on the Standby cannot be 82, so it is 18 (that is, 50 minus 32).

These addresses are automatically swapped at switchover; you do not have the option to change the offset or prevent the addresses from being swapped.

**Note:** The Quantum Hot Standby system swaps Modbus Plus addresses almost instantaneously at switchover. This means that host devices polling the Quantum controller can be assured that they are always talking to the Primary controller and that the network experiences no downtime during switchover.

## Transfer All State RAM

---

### "Transfer All State RAM" check box

It is not possible to define a special State RAM or additional State RAM range to be transferred if this check box is activated.

---

### Nontransfer Area

The nontransfer area contains the Hot Standby status register, which is used to monitor the states of both controllers. It also contains a pair of registers which may be used for reverse transfer operations. You may include other 4x registers in the nontransfer area to reduce scan time.

The Start: field is used to specify the first 4x register in the nontransfer area. The Length: field is used to define the number of contiguous registers in the nontransfer block. If you choose to define a nontransfer area, the range of legal values for this entry field is 4 ... n, where n is the number of configured 4x registers. However, when defining the nontransfer area, you must meet these requirements:

- The nontransfer area must be located entirely within the area of 4x registers scheduled for transfer on every scan. The transfer area is defined in the State RAM dialog.
- The command register (first entry of the Hot Standby dialog) must be outside the nontransfer area.

**Note:** If you are also programming a CHS instruction in LL984, the parameters you set for the nontransfer area in the Hot Standby dialog must be identical to those in the CHS block.

---

### Hot Standby Status Register

- The third register in the nontransfer area is the Hot Standby status register. Use this register to monitor the current machine status of the Primary and Standby controllers.
-

## Hot Standby Status Register for Configuration Extension

### Status Register for Configuration extension

Note: Bits 1 and 2 are used only in conjunction with a configuration extension.

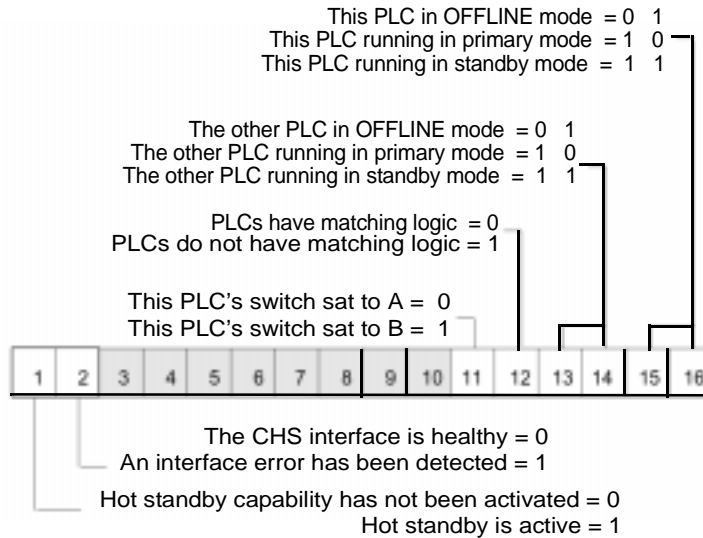

## Advanced Options

---

### Advanced Options button

When pressing the Advanced Options button in the Hot Standby dialog, you get the opportunity to allow different firmware versions on the Primary and Standby controller while running in full Hot Standby mode.

Concept shown



This lets you upgrade the controllers step by step to a new firmware version without having to shutdown the system. Since this is only necessary in rare situations, it is recommended that you disable this mode by configuration and to enable it by the reference data editor or Zoom screen when needed. By default, the controllers must have the same versions of firmware. This means the Standby controller would not go online while having a newer or older firmware version than the one on the Primary controller.

---



## Defining the Transfer Area of State RAM

**Additional RAM** With 984 Hot Standby, you may define additional state RAM (0x, 1x, 3x, and 4x registers) that are transferred in groups over multiple logic scans.

**State RAM dialog** To open the State RAM dialog, deactivate Transfer All State RAM and then use the Options button. State RAM associated with all critical I/O also should be transferred in every scan. Additional state RAM can be grouped and transferred over multiple scans.

### Concept shown

If you use the CHS instruction to configure the Hot Standby system, you are unable to transfer any more than 12K words, even though the total amount of state RAM could be as much as 64K words. You can limit the number of 4x registers being transferred by selecting a block of registers as part of the nontransfer area, but you cannot limit the number of 0x, 1x, or 3x registers in the transfer area.

**Note:** The command register must be located in the area of state RAM which is transferred in every scan.

### Hot Standby Dialog

Using the Hot Standby dialog, you have a great deal more flexibility in determining how much or how little State RAM gets transferred. You also can manage how much gets transferred in all scans and how much gets transferred in pieces over multiple scans.

The parameter you select in the Transfer field of the State RAM determines the flexibility you have in defining your state RAM transfer area. You may choose from two options:

- 12K
- User Defined

**Note:** The remaining entry fields of the dialog may or may not be used depending on which one of these two parameters you choose.

**Note:** No matter which option you choose, remember that the command register must be included in the block of registers transferred on every scan.

---

### 12K Option

The 12K option mimics the CHS instruction. It gives you a predefined state RAM transfer area with a predetermined maximum of each reference data type to be transferred. The predefined transfer area consists of the following:

- All the 0x discrete outputs in state RAM up to a maximum of 8192, including their associated histories.
- All the 1x discrete inputs in state RAM up to a maximum of 8192, including their associated histories.
- If the total number of registers (3x and 4x combined) implemented in state RAM is 10 000 or less, then all the registers plus the up/down counter history table.
- If the total number of registers (3x and 4x combined) implemented in state RAM is greater than 10 000, then 10 000 registers transfer in accordance with the formula described in *System Scan Time*, p. 33.

If you choose the 12K option, the State RAM and Additional State RAM area become irrelevant. You can not customize the transfer area or transfer additional data in groups over multiple scans. Any entries in these fields are ignored.

---

## User Defined Option

The User Defined option lets you specify the amount of each reference data type that you want to be transferred on each scan. If the Transfer Additional State RAM check box is activated, it allows you to transfer additional data.

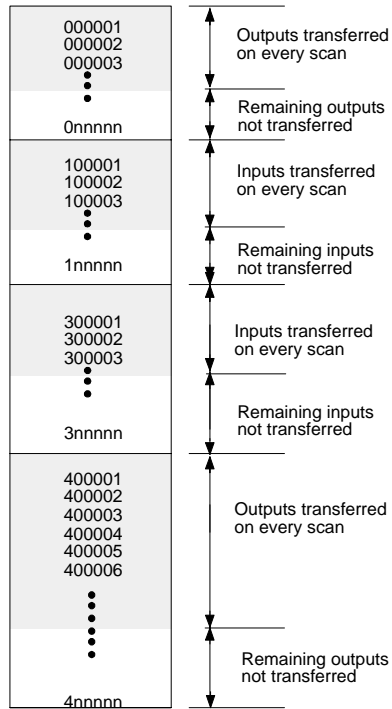

## User Defined State RAM Transfer

Use the State RAM area to define the size of the data range. All of the reference data that you specify in this area is transferred from the Primary to the Standby controller on every scan (except the defined nontransfer area). All reference data items must be 0 or specified in multiples of 16. A minimum of 16 4x registers is required. The maximum amount of state RAM to be transferred on every scan can be as much as the total amount of available state RAM (10K, 32K, or 64K, depending on the type of Quantum controller).

## Transferring Additional State RAM Data

---

### Additional Data

If the Transfer Additional State RAM check box is activated, additional State RAM could be transferred.

In the Additional State RAM area, enter the number of 0x, 1x, 3x, and 4x data references that you want to be transferred as additional state RAM. All reference data items must be specified in multiples of 16. You must enter a value of 16 or greater for at least one of the four reference data types.

	<b>CAUTION</b>
	<b>Transfer Additional State RAM Hazard</b> If you choose Transfer Additional State RAM, you must specify additional data to be transferred or the controller will not start. <b>Failure to follow this precaution can result in injury or equipment damage.</b>

Use the Extra Transfer Time entry field to specify the number of scans over which you want the additional data to be transferred. In general, the system divides the number of reference data elements specified in the fifth entry field by the number of scans specified in the sixth entry field. Accordingly, it divides the data into groups that are transferred contiguously over the specified number of scans. These groups of data are transferred with the regular state RAM data that has been scheduled on every scan.

---

**Additional Data** The diagram below illustrates transfer of additional State RAM data.

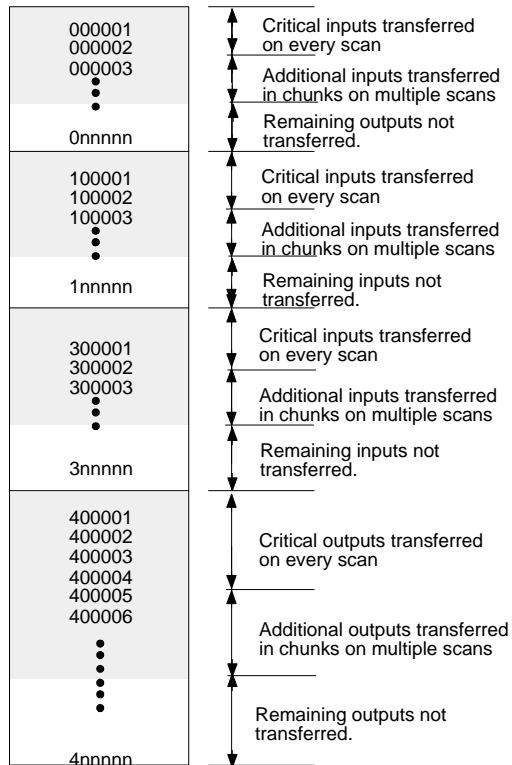

The system transfers additional data in the following order:

- All 0x references first
- All 1x references second
- All 3x references third
- All 4x references last

## Scan Transfers

---

### Data Type

A minimum of 512 equivalent words of each data type specified in the Additional State RAM area are sent in a scan, unless there are less than 512 words of that data type left to be transferred. For example, if you specify 528 additional registers to be transferred over three scans, the system will send the data faster than expected. The first 512 additional registers are transferred in the first scan, and the remaining 16 registers are transferred in the second scan. On the third scan, the process begins again, sending the first 512 additional registers.

---

---

## 6.4 Operation

---

### Introduction

---

**Purpose** This section describes Hot Standby operation.

---

**What's in this Section?** This section contains the following topics:

Topic	Page
Starting Your Hot Standby System	104
Synchronizing Time-of-Day Clocks	106
While Your System Is Running	108

---

## Starting Your Hot Standby System

---

### Preconditions

**Note:** Start one controller at a time.

Be sure...

- The controller you are starting first has been fully programmed.
- The function keyswitch on the CHS 110 module is in the Run position.
- The designation slide switches on CHS 110 modules are in opposite positions.  
The first controller to power up will automatically become the primary controller, regardless of its designation as A or B.

### Starting the System

The following chart provides the appropriate steps for starting your Hot Standby system.

Step	Action
1	Turn on power to the first backplane.
2	Download the program to the controller.
3	Start the controller in that backplane.
4	Turn on power to the second backplane.
5	Download the program to the standby controller. If the switches on the controllers are set to the same address, you will not be able to download the program. Use the keyswitch program update procedure.
6	Start the standby controller.
7	Check the LED display. If the system is functioning normally, the display should match "Indicators of a Properly Functioning Hot Standby System", shown in the illustration below. On the CHS 110 module, all three indicators should be steady, not blinking. A blinking Com Act light signals that your system has detected an error. On the corresponding CRP module, the Ready indicator is a steady green. The Com Act indicator on the primary unit should also be a steady green, while the Com Act indicator on the standby RIO head should be blinking slowly.



## LED Display Indicators of a Properly Functioning Hot Standby System

The following graphic shows LED display indicators of a properly functioning Hot standby system.

Primary  
Backplane

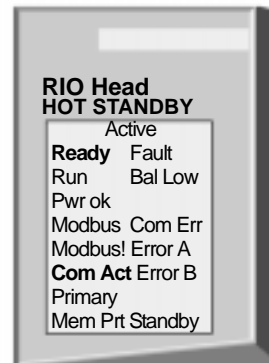
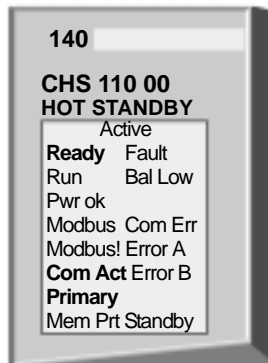

Standby  
Backplane

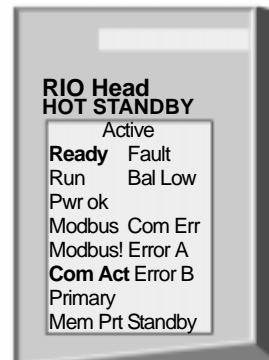
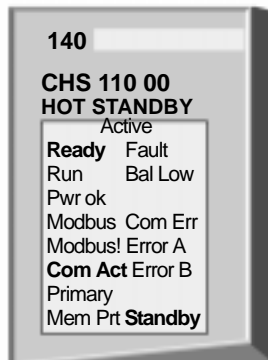

## Synchronizing Time-of-Day Clocks

---

### **Clock Synchronization**

In a Hot Standby system, the Primary and Standby controllers have their own time-of-day clocks. They are not synchronized. At switchover, the time of day changes by the difference between the two clocks. This could cause problems if you are controlling a time-critical application.

To solve this problem, program the Standby controller to reset its clock from the state table provided by the Primary controller. If you are controlling your system via configuration extension screens, put the logic for time synchronization first. Otherwise, put the logic for time synchronization in segment 1, but do not put it in network 1.

Since both controllers run the same program, you must read CHS status register bits 12...16 to be sure that only the standby clock is resetting. If bits 12...16 are 01011, you know three things:

- which controller is the Standby
- that the remaining controller is the Primary
- that both controllers are running the same logic

If these conditions are true, then the logic should clear bit 2 and set bit 1 of the time-of-day control register. The clock in the Standby controller will be reset from the state table of the Primary controller at the end of a scan and bit 1 will be cleared.

**Note:** Be sure that the registers for synchronizing the time-of-day clocks are included in the state RAM transfer area.

The following diagram shows synchronizing time-of-day clocks.

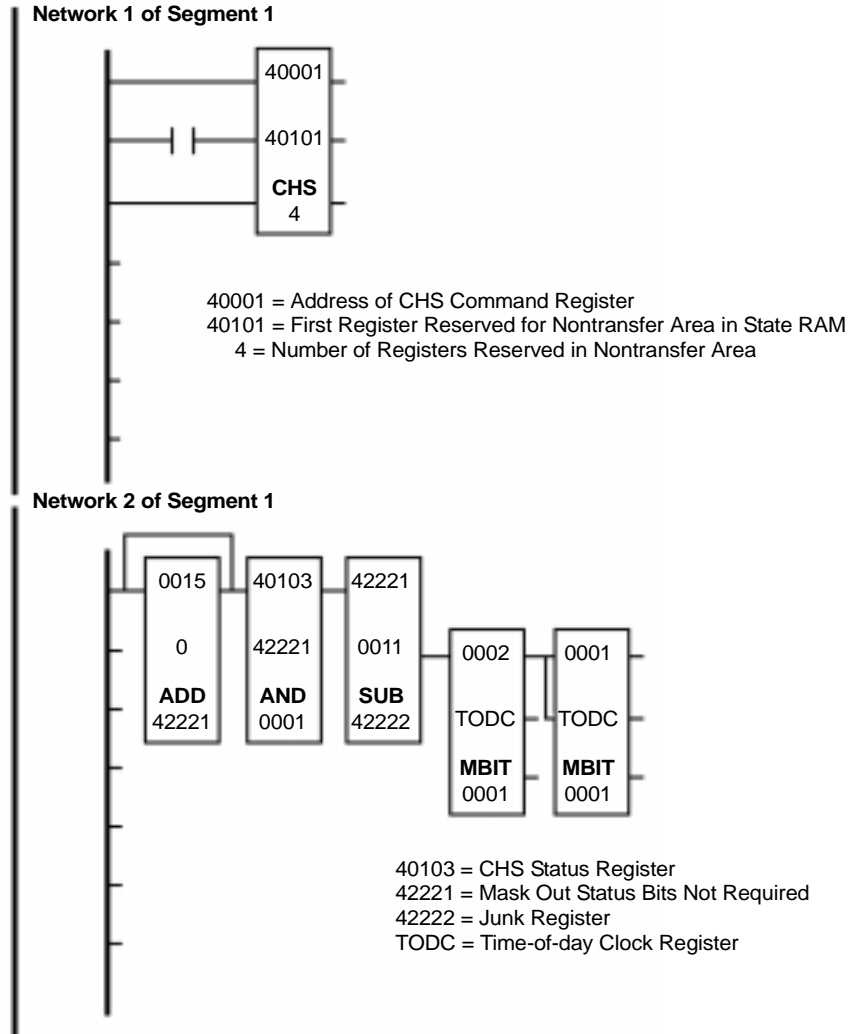

## While Your System Is Running

---

### **Constant Internal Monitoring**

After your Hot Standby system has been started and is running normally, it will continue to function automatically. It constantly tests itself for faults and is always ready to transfer control from the Primary to the Standby, if it detects a fault. While the system is running, the primary CHS module will automatically transfer a predetermined amount of state RAM to the Standby unit each scan. This ensures that the Standby is ready to take control if needed.

If one or both of the links between the Hot Standby modules are broken, the Primary controller will function as though no backup is available.

If the Primary controller fails, the Standby automatically assumes control of the remote I/O network. If the Primary controller recovers from failure, it assumes Standby responsibilities. If it cannot recover, it remains offline.

If the Standby controller fails, it goes offline. The Primary controller functions as a stand-alone and continues to manage the I/O networks.

---

---

# Using a Quantum IEC Hot Standby System

# 7

---

## At a Glance

### Purpose

This chapter presents operating procedures for the IEC HSBY.

### What's in this Chapter?

This chapter contains the following sections:

Section	Topic	Page
7.1	Configuration	111
7.2	Hot Standby Dialog	116
7.3	State RAM	129
7.4	Section Transfer Control	135
7.5	Operation	138
7.6	Normal Operation	140



---

## 7.1 Configuration

---

### Introduction

---

**Purpose** This section describes Quantum IEC Hot Standby configuration.

**Note:** To ensure correct operation of the HSBY system, the user must I/O map at least 1 RIO drop and 1 I/O module. This will ensure the proper diagnostic information is transferred between Primary and Standby CRPs. (Remote I/O Processor.)

### What's in this Section?

This section contains the following topics:

Topic	Page
Loading the Software	112
Controlling the Hot Standby System by Configuration Extension	114

---

## Loading the Software

---

### Loading and Concept 2.5

Starting with Concept 2.5, the CHS loadable is a part of the Concept install. If you are using Concept 2.5 and for some reason the loadable is deleted, it can be reinstalled using the following procedure.

---

### Load Software into Controllers

To configure a Quantum Hot Standby system, load the CHS software into the controllers. The software is included on a diskette in the Hot Standby Kit. Once you have installed the software, you can activate the IEC Hot Standby configuration extension.

---

### Installing the CHS loadable into the Concept Environment

The following steps are only necessary if the CHS loadable is not already part of your Concept installation. The CHS loadable is provided on a 3 1/2" diskette (140 SHS 945 00) as part of your 140 CHS 210 00 Hot Standby kit. The file is named QCHSVxxx.DAT, where xxx is the three-digit version number of the software.

Step	Action
1	Insert the diskette in the disk drive.
2	Either create a new Concept project or open an existing one and have a PLC selected
3	With the menu command Project Configurator, open the configurator.
4	With Configure Loadables, open the dialog box Loadables.
5	Press the command button Unpack to open the standard Windows dialog box, Unpack Loadable File. Select the loadable file, click the button OK and it is inserted into the list box Available.

---



**Concept  
Loadables  
Installation  
Screen**

The following diagram shows a Concept loadables installation screen.

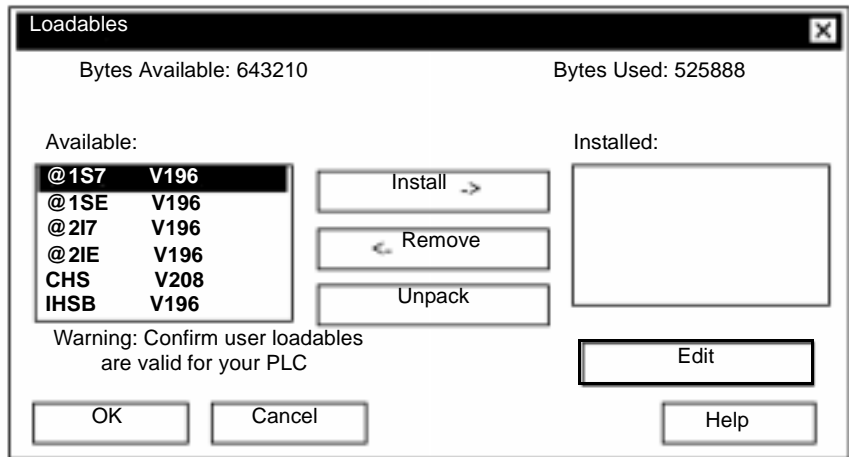

The CHS loadable is now part of the Concept environment and may be installed into a project configuration whenever needed.

## Controlling the Hot Standby System by Configuration Extension

---

### Configuration Extension

Use the Hot Standby Concept configuration extension screen as follows:

- Specify the parameters in the Hot Standby command register
- Define a nontransfer area to help reduce scan time

The parameters in the configuration screens are applied by the controllers at startup. You can change the settings/behavior of the IEC Hot Standby system after already having downloaded the configuration to the controller. Do this either by setting or resetting the particular bits of the Hot Standby command register or by using the Hot Standby specific EFBs of the "System" library.

**Note:** If the Hot Standby system is later stopped and then restarted, the parameters specified in the configuration extension screens go back into effect.

### IEC Logic in a Hot Standby System

In the Concept 2.1/2.2 Hot Standby system, there is no logic executed in the Standby controller. This is different from the 984 Hot Standby system, where the Standby controller executes the logic of segment 1.

In the Concept 2.5 Hot Standby system, the Standby controller executes section 1 logic; this is similar to the way segment 1 is handled in a 984 Hot Standby System. Section 1 may contain logic for diagnostic and optional Hot Standby functions, such as battery coil status. Do not program I/O control logic in section 1.

---

## Using the Configuration Extensions screen

The Configuration Extension offers two check boxes regarding Hot Standby. Since you are using the IEC environment, check the IEC Hot Standby check box. When exiting the Configuration Extension dialog with OK, the CHS Hot Standby loadable is automatically added to the project, but this requires the loadable being part of the Concept environment (refer to *Loading the Software*, p. 112). There is a second loadable with the name IHSB added as well. It is needed for the program transfer from Primary to Standby.

In turn, when the IEC Hot Standby check box is unchecked, the CHS and IHSB loadables are removed from the project automatically.

The following diagram shows the Configuration Extensions dialog box.

Concept  
Configuration extensions dialog (IEC Hot Standby activated)

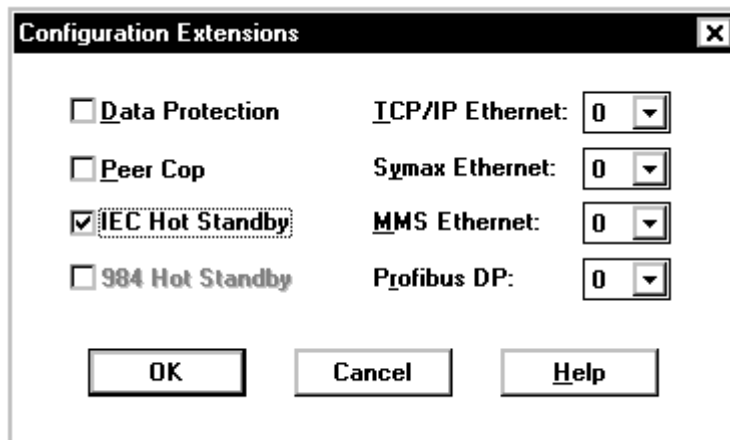

IEC Hot Standby ensures that the Primary and Standby controllers contain identical IEC applications so that backup is always available in case of a Primary controller failure. The configuration of the IEC Hot Standby must be done with the Hot Standby dialog.

## 7.2 Hot Standby Dialog

---

### Introduction

---

#### Purpose

This section describes the Quantum Hot Standby Dialog.

---

#### What's in this Section?

This section contains the following topics:

Topic	Page
Hot Standby dialog	117
Specifying the Command Register	118
Hot Standby Command Register	119
Enable Keyswitch Override	120
Advanced Options Concept 2.5	122
Standby on Logic Mismatch	124
Swapping Addresses at Switchover	127

---

## Hot Standby dialog

### Activation of Hot Standby Dialog

The Hot Standby dialog is shown below, it can be activated through Configure Hot Standby.

#### Concept 2.5 shown

The screenshot shows a dialog box titled "Hot Standby dialog" with a close button (X) in the top right corner. The dialog is divided into several sections:

- Command Register:** A text field labeled "Command Register: 4x" with the value "1" entered.
- Run Mode:** Two dropdown menus for "Controller A:" and "Controller B:", both set to "Offline".
- Standby On Logic Mismatch:** Two radio buttons: "Offline" (selected) and "Running".
- Swap Address at Switchover:** Three checked checkboxes: "Modbus Port 1", "Modbus Port 2", and "Modbus Port 3". There is also an unchecked checkbox for "Enable Keyswitch Override" and an "Advanced Options..." button.
- State RAM:** A section containing a "Non-Transfer Area" with two text fields: "Start: 4x" (value "0") and "Length:" (value "0").

At the bottom of the dialog are three buttons: "OK", "Cancel", and "Help".

## Specifying the Command Register

### Bits in the Hot Standby Command Register

The command register controls various parameters of the Hot Standby system.

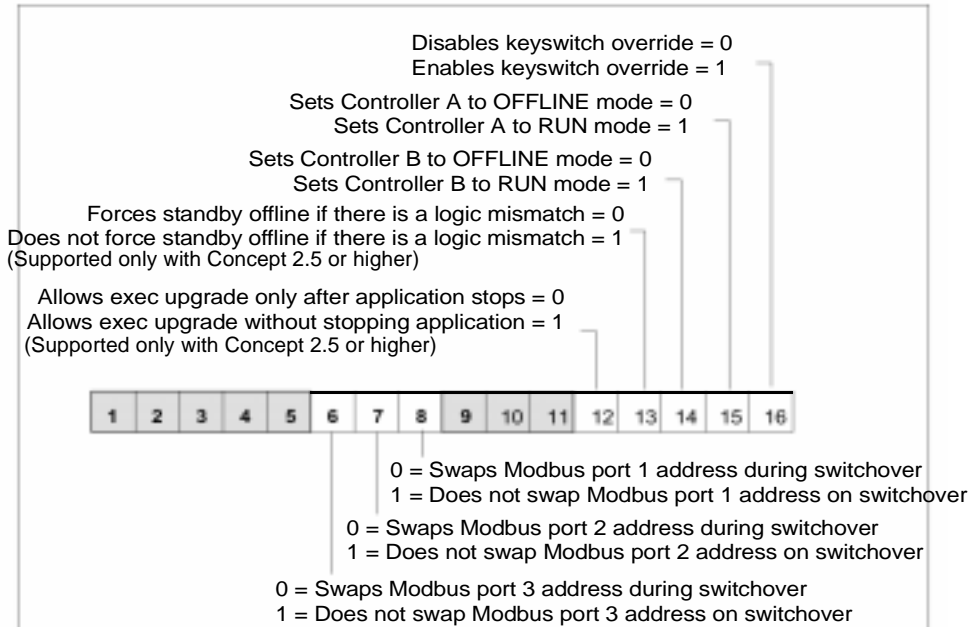

**Note:** Bit 16 in Modicon convention (shown in the diagram above) is bit 0 in IEC convention. Setting bit 16 means writing a 0x0001 into the command register.

### Specify Command Register

The command register is specified in the first entry field of the Hot Standby dialog. By default, the command register is set to 400001. If register 400001 is used elsewhere, enter another number greater than 0. The number you enter becomes the 4x command register. For example, if you enter 14, the hot Standby command register is 400014.

## Hot Standby Command Register

---

### Range

You may enter any number in the range 1 ... n, where n is the last configured 4x register. However:

- the command register must be part of the area of state RAM that gets transferred from the Primary to the Standby controller on every scan.
- therefore the command register must not be within the range of the nontransfer area, which you specify in the nontransfer area of the Hot Standby dialog.

	<b>CAUTION</b>
	<p><b>Hot Standby Command Register Hazard</b></p> <p>Be sure the register you select as the Hot Standby command register is reserved for this purpose and not used for other purposes elsewhere in user logic</p> <p><b>Failure to follow this precaution can result in injury or equipment damage.</b></p>

### Keyswitch Override and Run Mode

You may choose to override the keyswitch on the front panel of the CHS 110 modules for security or convenience. If you override the keyswitch, the command register becomes the means for taking the CHS 110 modules on or offline. By default, the keyswitch override is disabled. The Hot Standby dialog allows you to enable it.

If you enable the keyswitch override, the Offline/Running operating mode of the controllers at startup are determined by the values you set to bits 14 and 15 of the command register. These bits are represented as the Run Mode for controller A and B (depending on the designation slideswitch). Remember, that when the keyswitch override is enabled you cannot initiate a program update (program xfer) at the CHS 110 module in the Standby rack.

As long as the keyswitch override is disabled the settings for the Run Mode may be ignored.

---

## Enable Keyswitch Override

---

### Keyswitch Override

	<b>CAUTION</b>
	<b>Animation Mode or Reference Data Editor Hazard</b> If you use the animation mode or reference data editor (RDE) of Concept to enable the keyswitch override while the Hot Standby system is running, the Primary controller immediately reads bits 14 and 15 to determine its own state and the state of the Standby. <b>Failure to follow this precaution can result in injury or equipment damage.</b>

If both bits are set to 0, a switchover occurs and the former Primary backplane goes offline. The new Primary backplane continues to operate.

---

### A Software Control Example

For example:

You have enabled the keyswitch override and set the operating mode of controller B to Offline. Now the system is powered up and you want to put controller B in RUN mode.

The keyswitch does not work, so you must rely on user logic. There are two ways you can proceed.

---



**Options for  
Software Control  
Example**

## Option 1

Stage	Description	Comment
1	Change the setting on the Hot Standby dialog.	To do this, you must shut down the system and make the necessary change in the dialog, then power up the system again.
2	Download the new configuration.	

## Option 2

Stage	Description	Comment
1	Connect Concept to your Primary controller.	
2	Call up the Reference Data Editor (RDE).	
3	Place the Hot Standby command register and the Hot Standby status register in the RDE.	The operating mode of controller B is determined by the state of bit 14 of the command register. If controller B is offline, bit 14 is set to 0.
4	To put the controller in RUN mode, change the state of bit 14 to 1.	Controller B immediately goes into RUN mode.
<b>Note: The advantage of option 2 is that the Hot Standby system does not have to be shut down in order to change its status.</b>		

## Advanced Options Concept 2.5

---

### Advanced Options button

When selecting the Advanced Options button in the Hot Standby dialog you get the opportunity to allow different firmware versions on the Primary and Standby controller while running in full Hot Standby mode.

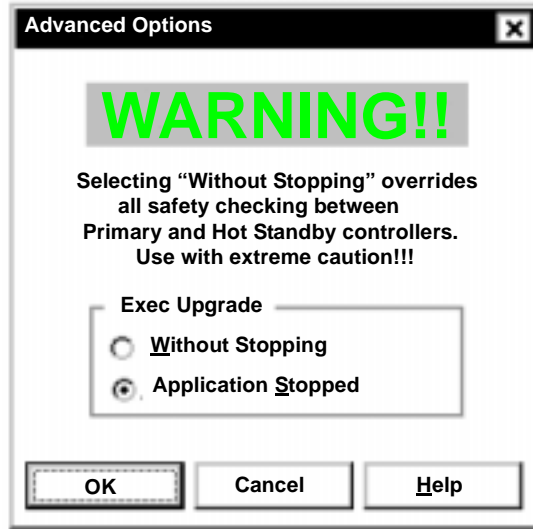

This lets you upgrade the controllers step by step to a new firmware version without having to shutdown the system. Since this is only necessary in rare situations, it is recommended that you disable this mode by configuration and to enable it by the reference data editor when needed. By default, the controllers must have the same versions of firmware. This means the Standby controller would not go online while having a newer or older firmware version than the one on the Primary controller.

**Note:** This option is available only in Hot Standby systems already running with Concept 2.5.

## IEC HSBY System Executive Upgrade Procedure

The following table shows the steps to upgrade the controller's executive in an IEC HSBY system. **Note:** You must first have both controllers running in Concept 2.5.

Step	Action
1	Connect to the Primary controller with Concept and use the reference data editor to set bit 12 of the Hot Standby command register to 1.
2	Disconnect from the Primary controller.
3	Use the Executive Loader to download the new executive to the Standby controller.
4	Connect to the Standby controller with Concept and download the project. <b>NOTE:</b> Projects developed with versions of Concept earlier than 2.5 must be imported into Concept 2.5 using the Converter.
5	Start the Standby controller.
6	Verify that the Standby controller is in Run Mode and the CHS module indicates that the Standby Controller is now in Standby mode.
7	Disconnect from the controller.
8	Initiate a Hot Standby switchover using the Key Switch.
9	Download the Executive to the new Standby Controller using the Executive loader.
10	Use the transfer button on the CHS module to transfer the program to the Standby controller. Verify that the Standby controller is in Run Mode and the CHS mode indicates that the Standby Controller is now in Standby Mode.
11	The Hot Standby Controller Executives have now been upgraded <b>without stopping the process.</b>

## Standby on Logic Mismatch

---

### Overview

To function properly, the Primary and the Standby controller in a Hot Standby system must be solving an identical program, which is updated on every scan by a state RAM data transfer between the two controllers.

By default, the Standby controller is set to go Offline if a mismatch is detected between its program and that of the Primary controller. Switchover cannot occur while the Standby controller is Offline.

	<b>CAUTION</b>
	<b>I/O Map / Configuration Hazard</b> A mismatch in the I/O map or configuration is not allowed under any circumstances. <b>Failure to follow this precaution can result in injury or equipment damage.</b>

	<b>CAUTION</b>
	<b>Switchover Hazard</b> If switchover occurs when the radio button is set to Running and there is a logic mismatch between the two controllers, the Standby controller will assume Primary responsibilities and will start solving a different logic program from the previous Primary controller. <b>Failure to follow this precaution can result in injury or equipment damage.</b>

### Logic Mismatch for Concept 2.5

Concept 2.5, and the new PLC Executives delivered with it, support the Standby on Logic Mismatch option in the Hot Standby Configuration Extension. Logic mismatch allows you to make online changes to the program of the Standby or Primary controller while the HSBY system continues to run the process. The Standby on Logic Mismatch option also allows up to date process data to be transferred from the Primary controller after download of the modifications.

---

**Updating Project  
Section Data**

All DATA of a section will be fully updated every scan if it is equal to its counterpart on the Primary controller. Section DATA will not be updated at all if it is not equal to its counterpart on the Primary controller.

The section data that is updated if the sections are equal on Primary and Standby controllers is:

- Internal states of Elementary Function Blocks (EFBs) used in the section (Timers, Counters, PID, etc.)
- All Derived Function Block (DFB)-Instance data blocks of each DFB instantiated in the section including nested DFBs

Hot Standby behavior for the section update process is:

- With matching logic, all section data gets updated on the Standby controller
  - After you do an online change to a section, none of its local data gets updated. To get it updated again, the controllers' logic has to be equalized via the CHS transfer button or a complete download to the Primary controller with differing logic.
  - It is not possible to make online changes to one controller and the same online changes to the other controller to get matching logic again. To equalize both controllers, you should either push the Transfer button of the CHS module or do a complete download to the controller which did not receive the download changes.
  - The change of a literal during animation (called quickwrite) will cause the whole section not to be updated or transferred to the Standby Controller.
-

### Updating Project Global Data

With a logic mismatch, project global data will be updated with every scan. Global data that do not exist on both controllers is not updated.

The project global data that is updated includes:

- All variables **declared** in the Variable-Editor
- All Constants **declared** in the Variable Editor
- All section and transition variables

Hot Standby behavior for project global data updating is:

- All declared variable/constant will be updated every scan as long as they are declared on both controllers
- If a complete download is done to the controller that did not receive the download change, then both controllers will have equal logic and therefore the Standby controller gets updated fully.
- If, due to a download change, a project global variable/constant has been deleted first, and then **redeclared**, this variable/constant would be treated as a **NEW** variable/constant, even if the same name is used. The update procedure must be followed to bring the controllers to an equalized state.

**Note:** This is true whether these variables/constants are used in the controller program or not. Unused variables consume space and require time to be transferred from the Primary to the Standby controller. It is not recommended to have many variables that are defined but not used in the Primary controller program.

---

### Nontransfer Area of State RAM

Although customizing transfers is not an option, you should designate a block of 4x registers as the nontransfer area. These registers are ignored when state RAM values are transferred from the Primary controller to the Standby. Placing registers in the nontransfer area is one way to reduce scan time because the Primary PLC to CHS transfer time is shorter. See *State RAM*, p. 129 for more detail.

---

---

## Swapping Addresses at Switchover

---

### Modbus Port Swap Address at Switchover

In a Hot Standby system, the Modbus ports on the Primary controller may have MEM addresses in the range of 1 to 119. This allows an offset of 128 for comparable ports on the Standby controller, with 247 the maximum number of addresses. For example, if controller A is the Primary controller and its two Modbus ports have addresses 1 and 2, then the default addresses for the comparable ports on Standby controller B are 129 and 130. By default, this offset is maintained between port addresses in the event of switchover. For example, if controller B becomes the Primary controller as the result of switchover, its Modbus ports assume the addresses of 1 and 2, and the comparable ports on controller A assume addresses 129 and 130.

The three check boxes allow you to change this default condition on any or all of the Modbus ports on the two controllers in your Hot Standby system.

For example, if you deselect the parameter Modbus Port 1, then no offset is maintained at switchover and after switchover the two ports have the same address. Thus if controller A is the Primary controller and its Modbus port 1 address is 1, then that port address remains 1 after a switchover occurs. Likewise, if controller B becomes the Primary controller as a result of switchover, its Modbus port 1 address is also 1.

<p><b>Note:</b> If you change the selections, the port addresses are not affected until a switchover occurs.</p>
--

### Modbus Plus Port Address Swapping at Switchover

In a Quantum Hot Standby system, the Modbus Plus port addresses on the Standby controller are offset by 32 from the comparable ports on the Primary controller. For example, if controller A is the Primary controller and its Modbus Plus port has address 1, then the address for the corresponding port on Standby controller B is 33. The numerical range for addresses for both ports is 1 through 64. Thus, if the port on the Primary controller has address 50, then the address for the corresponding port on the Standby can not be 82, so it will be 18 (that is, 50 minus 32).

These addresses are automatically swapped at switchover; you do not have the option to change the offset or prevent the addresses from being swapped

**Note:** The Quantum Hot Standby system swaps Modbus Plus addresses almost instantaneously at switchover. This means that host devices which are polling the Quantum controller can be assured that they are always talking to the Primary controller and that the network has no downtime during switchover.

### **IP Address Swapping at Switchover**

The Quantum network option module NOE 771 (Ethernet TCP/IP) supports address swapping at switchover when used in a Hot Standby system. This behaves pretty much like the address swap of the Modbus Plus ports, except that the offset is 1 instead of 32. So when having the NOE 771 installed with an IP address of AAA.BBB.CCC.DDD configured, the module in the Primary rack is going to take that one. The module in the same slot of the Standby rack takes address AAA.BBB.CCC.(DDD+1). In case DDD = 254, (DDD+1) is going to be 1, and at switchover the modules exchange their IP addresses. The address swap feature of the NOE 771 cannot be controlled, it is always activated.

**Note:** NOE 771 XX is the only Ethernet option module that supports the IP address swap, all other NOEs will take the IP address that's being configured for them, no matter if they reside in the Standby or Primary rack.  
NOE 771 XX modules must be configured in the same slot of the Primary and Standby Backplanes.  
NOE 771 XX requires minimum firmware revision 1.10 or higher.

**Note:** Even if the built in I/O-Scanner of the NOE 771 00 module is used for data exchange or I/O modules, this mechanism does not provide full uninterrupted communication in case of a switchover. Some connection losses may occur and/or some non-actual data may be provided by the I/O-Scanner. Therefore, Schneider Electric does not recommend applying this feature for I/O serving.

### **Nontransfer Area of State RAM**

Although customizing transfers is not an option, you should designate a block of 4x registers as the nontransfer area. These registers are ignored when state RAM values are transferred from the Primary controller to the Standby. Placing registers in the nontransfer area is one way to reduce scan time because the Primary PLC to CHS transfer time is shorter. See *State RAM*, p. 129 for more detail.



---

## 7.3 State RAM

---

### Introduction

---

**Purpose** This section describes Quantum IEC Hot Standby State RAM.

---

**What's in this Section?** This section contains the following topics:

Topic	Page
Nontransfer Area of State RAM	130
Hot Standby Status Register	132
Memory Partition	133
State RAM Size	134

---

## Nontransfer Area of State RAM

---

**Nontransfer Area** The nontransfer area contains the Hot Standby status register, which is used to monitor the states of both controllers. You may include other 4x registers in the nontransfer area to reduce scan time.

The **Start:** field is used to specify the first 4x register in the nontransfer area. The **Length:** field is used to define the number of contiguous registers in the nontransfer block. If you choose to define a nontransfer area, the range of legal values for this entry field is 4... n, where n is the number of configured 4x registers. However, when defining the nontransfer area, the command register (first entry of the Hot Standby dialog) must be outside the nontransfer area.

The following block diagram shows how the nontransfer area exists with respect to the rest of the state RAM transfer area.

### State RAM Transfer Area

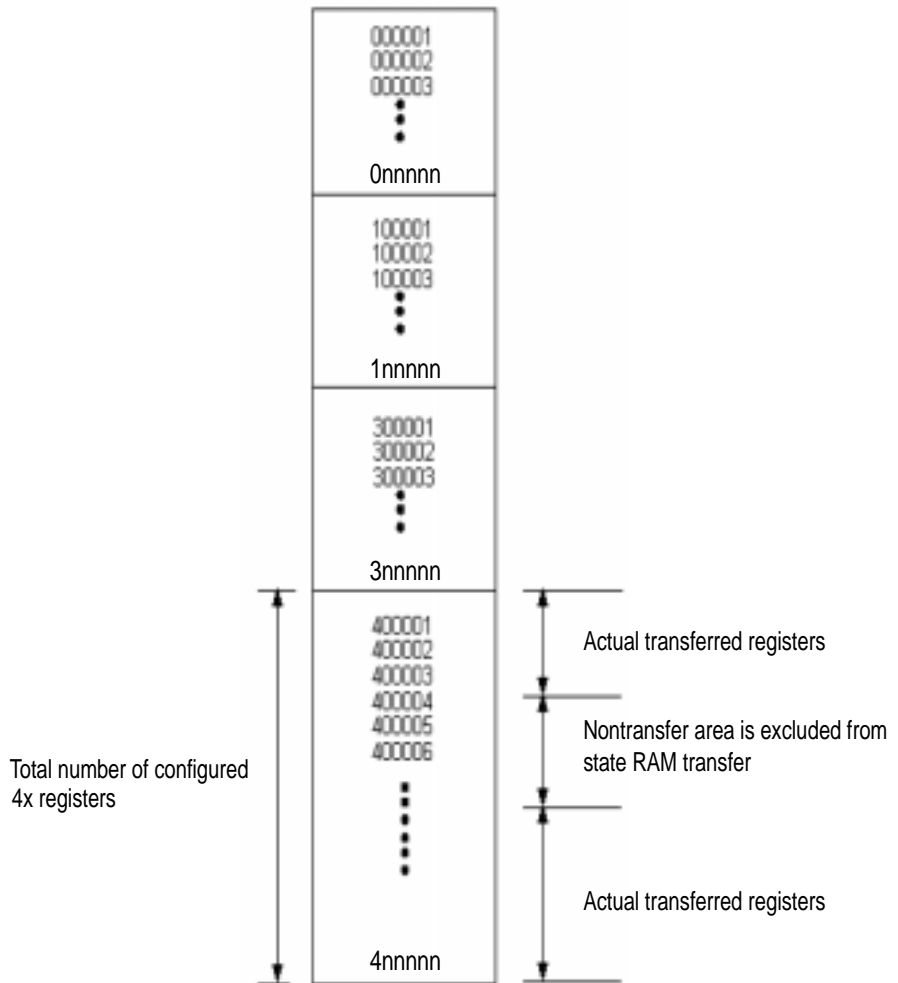

**Note:** The command register must not be placed in the nontransfer area. No more than one block can be defined as the nontransfer area.

## Hot Standby Status Register

### Hot Standby Status Register

The third register in the nontransfer area is the Hot Standby status register. Use this register to monitor the current machine status of the Primary and Standby controllers.

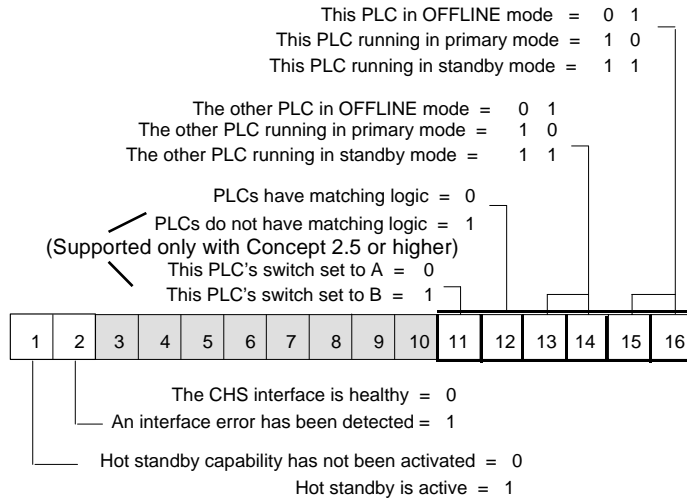

**Note:** Bit 16 in Modicon convention (shown in the diagram above) is bit 0 in IEC convention. Setting bit 16 means writing a 0x0001.

### IEC Heap Size

As described in *Theory of IEC HSBY Operation*, p. 43, the IEC Heap is transferred from the Primary to the Standby controller through a reserved partition of state RAM. This partition consists of a contiguous block of 3x registers, they are the so called IEC HSBY Registers. Since they are part of state RAM, they are never more than 64K words (128 KByte). To ensure full data consistency in case of a switchover, all data of the Primary's IEC application must be transferred to the Standby in every scan. The IEC heap, which contains all the to-be-transferred data, may not be bigger than the transfer buffer that carries the IEC heap from the Primary to the Standby controller (64K words).

## Memory Partition

### IEC HSBY Registers

The number of IEC HSBY Registers (size of transfer buffer) is set to the maximum whenever the IEC Hot Standby configuration extension is activated the first time for a particular project. So after having the IEC Hot Standby configuration extension activated, the state RAM is fully occupied with the default values for 0x, 1x, 3x, 4x and the remaining maximum for IEC HSBY Registers (3x). The dialog that follows shows how the number of IEC HSBY Registers can be modified. The diagram below shows a PLC Memory Partition.

Concept shown

The screenshot shows a dialog box titled "PLC Memory Partition" with a close button (X) in the top right corner. The dialog contains the following information:

<b>Maximum State Memory:</b>	65024
<b>State Memory Used:</b>	65018
<b>State Memory Usage:</b>	99 %
<b>Discretes</b>	
<u>C</u> oils (0xxxx):	<input type="text" value="1536"/>
<u>D</u> iscrete Inputs (1xxxx):	<input type="text" value="512"/>
<b>Registers</b>	
<u>I</u> nter registers (3xxxx):	<input type="text" value="512"/>
<u>H</u> olding registers (4xxxx):	<input type="text" value="1872"/>
<b>IEC Hot Standby Data</b>	
<u>I</u> nter registers (3xxxx):	<input type="text" value="52016"/>

At the bottom of the dialog are three buttons: **OK**, **Cancel**, and **Help**.

**Note:** The higher the number of IEC HSBY Registers (IEC Hot Standby Data in the above dialog) the bigger the transfer buffer for the IEC heap and therefore the bigger the IEC application may be. See *State RAM*, p. 155.

## State RAM Size

### State RAM Size

**Note:** The size of the configured state RAM in an IEC Hot Standby project has a significant impact on the system's scan time. Once a logic scan is finished, the next does not start before all state RAM data has been transferred to the CHS module.

Once the number of IEC HSBY Registers has been set, you may deactivate the IEC Hot Standby configuration extension and activate it again later, the number of IEC HSBY registers remains the same.

The following diagram shows the IEC State RAM Map.

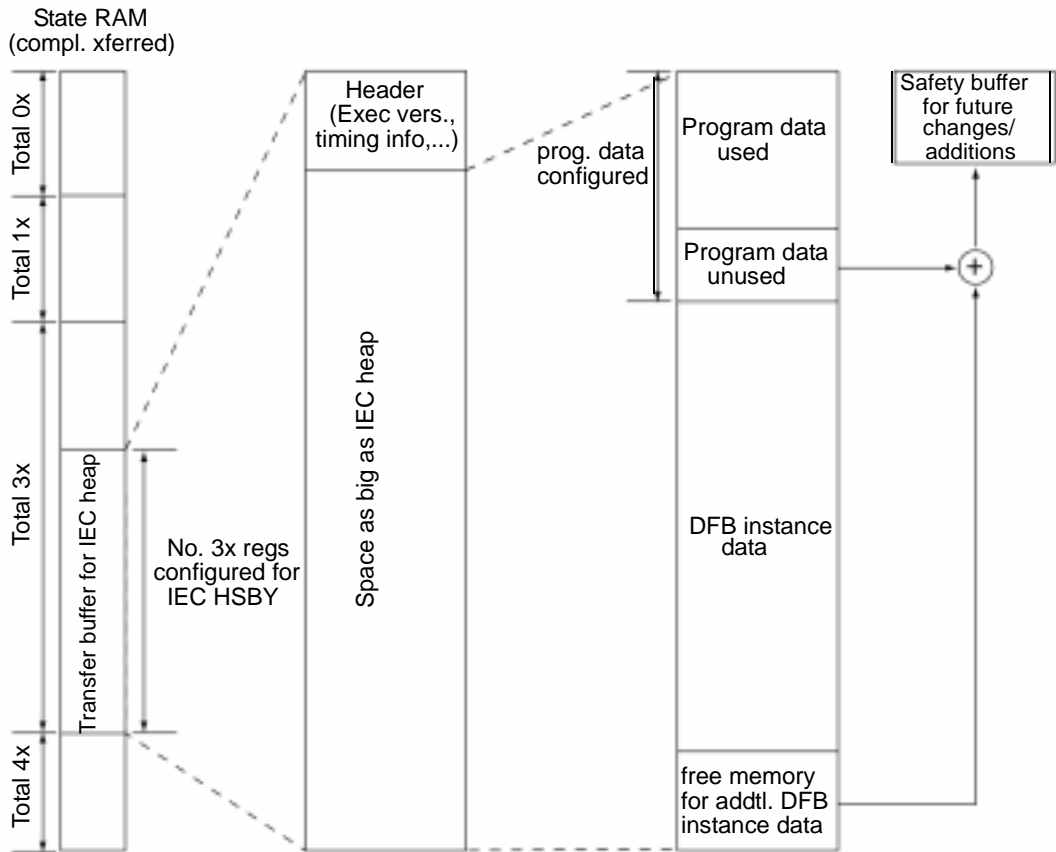

---

## 7.4 Section Transfer Control

---

### Section Transfer Control

---

**Section Transfer Control Description** A new function has been added with Concept 2.5 that allows the selection of section(s) that will not be transferred from the Primary controller to the Standby controller with the exception of SFC sections. SFC sections are always transferred every scan.

A benefit of selecting section(s) to not be transferred is that it allows you to reduce the number of IEC Hot Standby registers in the configuration and thus reduce Hot Standby scan time. The type of sections that should be selected for non-transfers are those that do not have to be updated for every scan, i.e., Section that loads recipe. This new function should be used along with guidelines for optimizing an IEC application for IEC Hot Standby Operation to reduce HSBY scan time found in *Additional Guidelines for IEC Hot Standby*, p. 147.

---

### Using Section Transfer Control

The use of this feature requires initial planning of your Hot Standby project to insure that logic not requiring an update fore every scan is segregated into its own section(s) so that they can be selected for non-transfer. Logic elements that can be used in non-transfer sections are those that have no internal states (e.g., contacts, coils, etc.). Logic elements that should not be used in non-transfer sections are those that have internal states (e.g., timers, counters, etc.) since the internal state needs to be updated on every scan.

After sections are selected for nontransfer, the number of IEC Hot Standby registers can be reduced. To insure that you have enough IEC Hot Standby registers configured, go to the Memory Prediction dialog to view Hot Standby Memory usage. See *Normal Operation*, p. 140. Additionally, you can perform an analyze program under the project menu item. If you do not have enough IEC Hot Standby registers, then you will receive an error message. This message will indicate the minimum number of registers needed. A safety buffer should be added to this value to configure space for future program modifications. The reduction of the IEC Hot Standby registers is a change in the configuration and requires a complete download of the project (i.e. the Hot Standby process has to be stopped). Selecting sections to be not transferred without reducing IEC Hot Standby registers has no effect on the Hot Standby scan time.

The section data that will not be transferred when its Update (Hot Standby) control is set to no Update are:

- internal states of EFBs used in the section
- links

All DFB-Instance data blocks of each DFB instantiated in the section including nested DFBs local Variables inside any DFB instantiated in the section. Section Hot Standby transfer status is changed using the Project Browser. Offline with Hot Standby project open, open the Project Browser. With your mouse, select the section whose Hot Standby transfer status you want to modify and right click. Click on Update (Hsby) to change Transfer State. The Project Browser can also be used to view a project's section(s) Hot Standby Transfer State. Sections that will not be transferred will have a "!" to the left of the section name. See the screen shot of the Project Browser below.

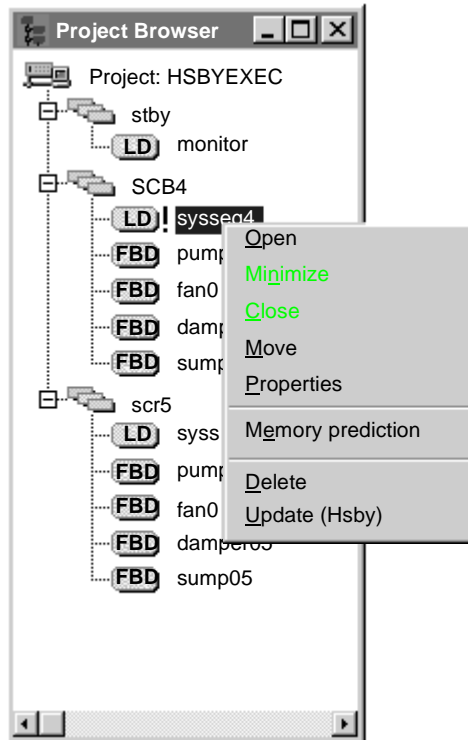



**Transfer Status Byte**

The Section Hot Standby Transfer Status Byte can be read by an operator panel or by Data Acquisition System. The purpose of the byte is to provide feedback to the Application to indicate whether the Section Data is being transferred to the Standby controller. If a fault occurs, then the Primary Controller Application or the SCADA System will take appropriate measures to indicate a fault.

A fault could occur if:

- the programmer disables the section from transferring
- modifications are made to the sections but changes are not downloaded to both controllers. This would cause the primary and the standby sections to be different.
- the Standby controller is not present

In the example below, the section name is LD1. To access this in the Primary Controller application you would use the variable LD1.hsbyState.

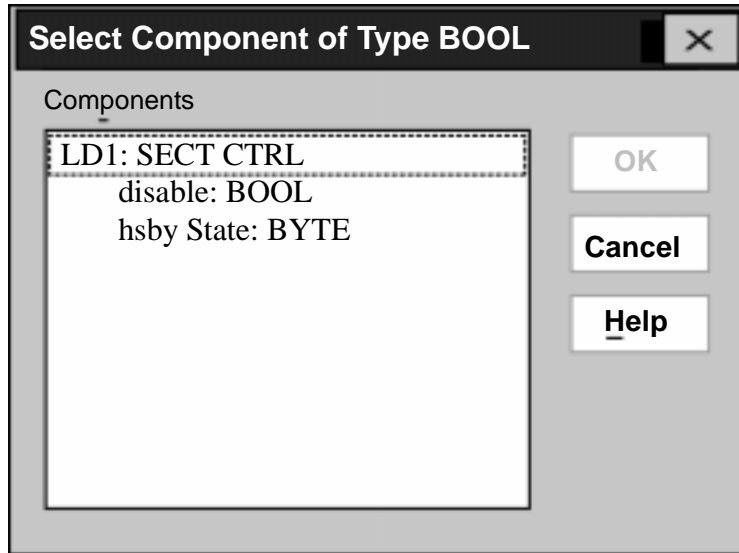

## 7.5 Operation

---

### Starting Your Hot Standby System

---

#### Preconditions

**Note:** Start one controller at a time.

Be sure

- the controller you are starting first has been fully programmed;
  - the function keyswitch on the CHS 110 module is in the Run position;
  - the designation slide switches on CHS 110 modules are in opposite positions.
- 

#### Starting the System

The first controller to power up, automatically becomes the Primary controller, regardless of its designation as A or B.

Step	Action
1	Turn on power to the first backplane.
2	Start the controller in that backplane.
3	Turn on power to the second backplane.
4	Transfer the program from the Primary to the Standby controller by putting the keyswitch in transfer position and pressing the update push button on the Standby's CHS module (refer to <i>Using a Quantum 984 HSBY System, p. 67</i> ).

---

**Start Standby**

The following table shows the steps to starting Standby.

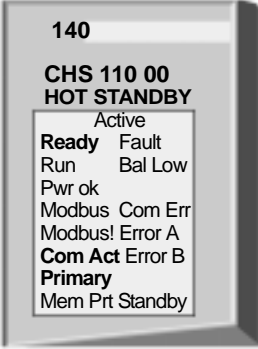
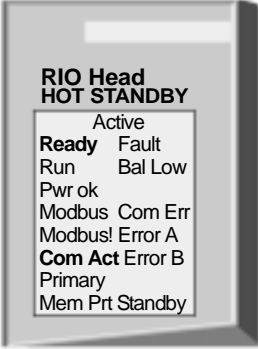
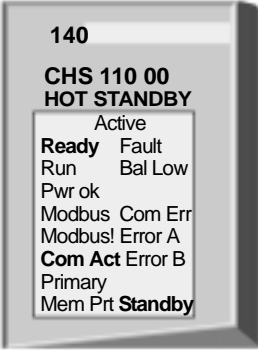
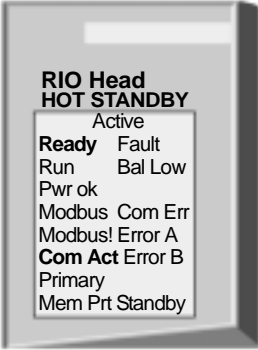
Step	Action
1	Start the Standby controller.
2	<p>Check the LED display. If the system is functioning normally, the display should be as follows:</p> <ul style="list-style-type: none"> <li>● On the CHS 110 module, all three indicators should be steady, not blinking. A blinking Com Act light signals that your system has detected an error.</li> <li>● On the corresponding CRP module, the Ready indicator is a steady green.</li> <li>● The Com Act indicator on the Primary unit should also be a steady green, while the Com Act indicator on the Standby RIO head should be blinking slowly</li> </ul> <p>Illustrations of the Primary and Standby Backplanes are shown below.</p> <div style="display: flex; flex-wrap: wrap;"> <div style="width: 50%;"> <p><b>Primary Backplane</b></p>  </div> <div style="width: 50%;">  </div> <div style="width: 50%;"> <p><b>Standby Backplane</b></p>  </div> <div style="width: 50%;">  </div> </div>

## 7.6 Normal Operation

---

### Introduction

---

**Purpose** This section describes Quantum IEC Hot Standby normal operation.

---

**What's in this Section?** This section contains the following topics:

Topic	Page
Memory/Scantime optimization	141
Synchronizing Time of Day Clocks	145
While Your System Is Running	146

---

## Memory/Scantime optimization

**IEC State RAM Map**      An illustration of the IEC State RAM Map.

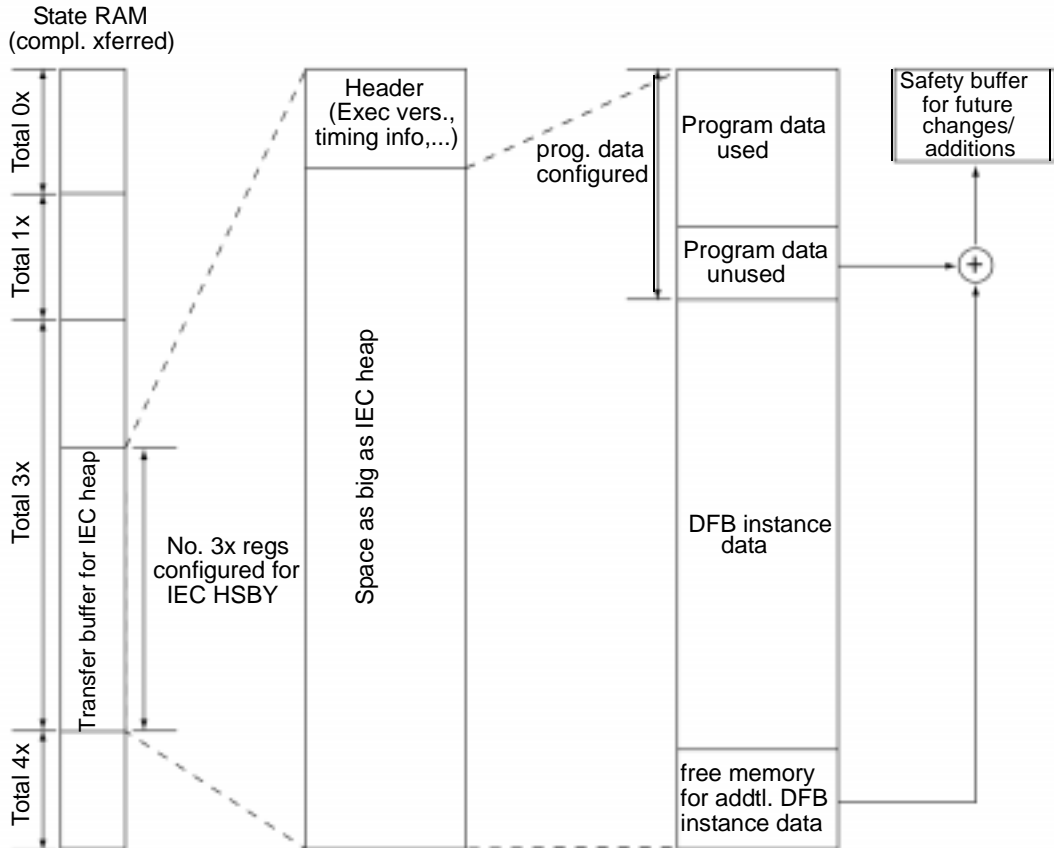

**IEC application data**

To maintain consistency of the IEC application's data between the Primary and Standby controllers the IEC heap is transferred through a reserved area in the 3x-register range, the so called IEC HSBY Registers. The size of this reserved area is assigned in the PLC Memory Partition dialog (refer to *Additional Guidelines for IEC Hot Standby*, p. 147). The size of the IEC HSBY Registers can never be smaller than the size of the IEC heap (application data), otherwise the copy-and-transfer mechanism does not work.

The size of the configured state RAM has a significant impact on a Hot Standby system's scan time: The more memory (state RAM) that is transferred on every scan, the slower the scan (for details refer to *Theory of IEC HSBY Operation*, p. 43). If future modifications to the IEC application are expected to be small, the safety buffer can be correspondingly less, reducing the general memory transfer size. The term "future modification" focuses on changes to the system that do not need the Primary controller to be stopped, which is a "download change".

You should try to reduce the size of configured 3x-Registers for IEC usage by adjusting it to what's really used in terms of your particular needs regarding future modifications. That's why the term "safety buffer" is used with IEC Hot Standby. The diagram above illustrates that the unused parts of the program data and DFB instance data areas make up the safety buffer. The important thing is that the size of the safety buffer is a configuration item, therefore it cannot change without shutting down the system, just as with any other configuration change.

---

**Memory Prediction Dialog**

To help optimize the size of the safety buffer and therefore the total amount of IEC HSBY Registers to be transferred, use the Memory Prediction dialog to determine an appropriate final configuration. This optimization with Concept 2.5 can be done offline.

The Memory Prediction dialog shows in the Hot Standby Memory section the numbers of bytes configured and used. To determine the number of 3X registers, divide the number of bytes by two. As shown below, there are 10000 IEC HSBY registers configured and 78.3% of them are used. There is, therefore, a safety buffer of approximately 22% of the registers to allow for future application changes. After making changes to the IEC HSBY registers in the configuration, reinvoke the Memory Prediction dialog to view the effect on the Hot Standby Memory.

A screenshot of the Memory Prediction dialog is shown below.

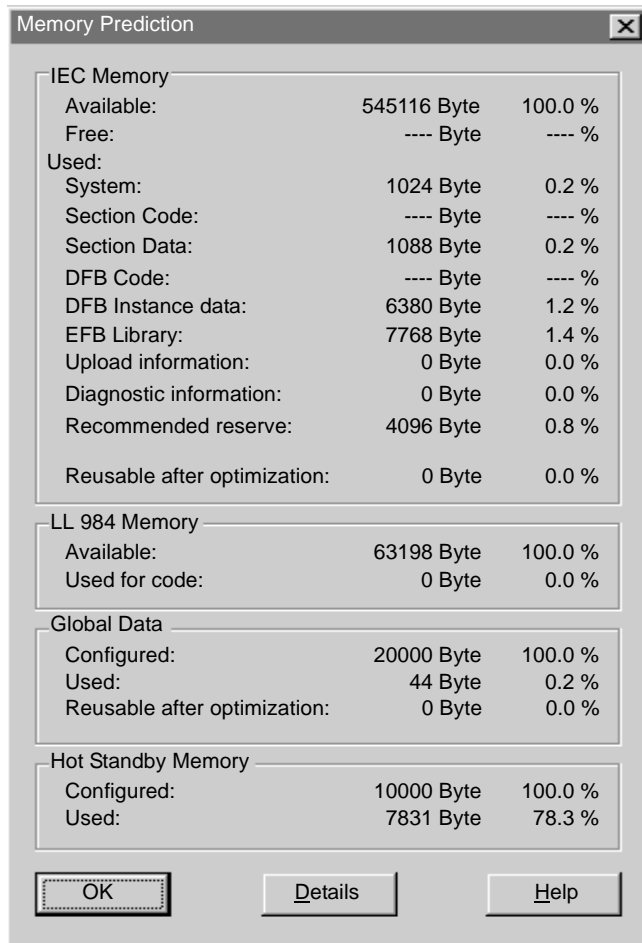

**Memory Statistics**

Memory Statistics HSBY (online) used for downsizing the number of 3x-Registers for IEC Hot Standby data.

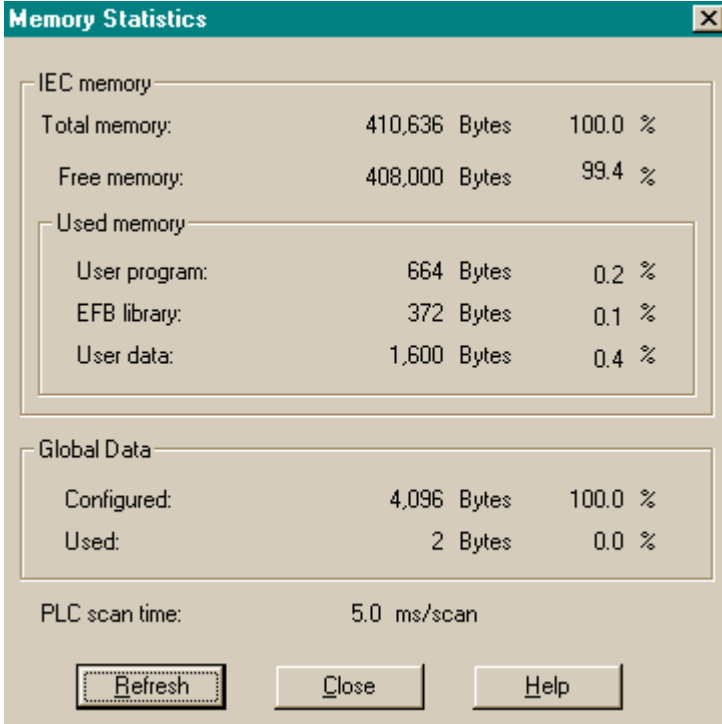

The screenshot shows a dialog box titled "Memory Statistics" with a close button (X) in the top right corner. The dialog is divided into three main sections: "IEC memory", "Used memory", and "Global Data".

IEC memory		
Total memory:	410,636 Bytes	100.0 %
Free memory:	408,000 Bytes	99.4 %

Used memory		
User program:	664 Bytes	0.2 %
EFB library:	372 Bytes	0.1 %
User data:	1,600 Bytes	0.4 %

Global Data		
Configured:	4,096 Bytes	100.0 %
Used:	2 Bytes	0.0 %

PLC scan time: 5.0 ms/scan

Buttons: Refresh, Close, Help



## Synchronizing Time of Day Clocks

### Primary and Secondary controller time-of-day clocks

In a Hot Standby system, although the Primary and Secondary controllers have their own time-of-day clocks, they are not implicitly synchronized. At switchover, the time of day changes by the difference between the two clocks. This could cause problems if you are controlling a time-critical application.

Assign the time-of-day clock eight 4x registers in the Specials dialog of the configurator. Be sure that none of these 4x registers resides in the nontransfer area, all of them need to be transferred to the Standby controller after each scan. Then use somewhere in the IEC logic the 'SET\_TOD' EFB, which resides in the system library under the HSBY group.

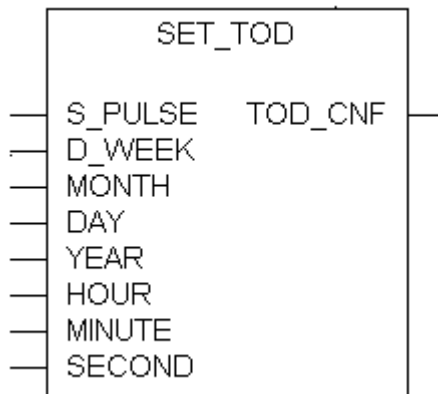

### Elementary Function Block (EFB) to set the PLC's time-of-day clock

While the full IEC Hot Standby system is running, meaning the Standby controller is also online, your application logic should trigger (rising edge of the S\_PULSE input) the EFB. This would then not only set the time-of-day clock in the Primary, but the one in the Standby as well, at the same time. The trigger on the clocks might again run at slightly different speeds, this time-set process should be repeated periodically, for example within a period of 1 minute.

## While Your System Is Running

---

### **Constant Internal Monitoring**

After your Hot Standby system has been started and is running normally, it continues to function automatically. It constantly tests itself for faults and is always ready to transfer control from the Primary to the Standby if it detects a fault.

---

### **Regular Data Transfers**

While the system is running, the module automatically transfers all state RAM to the Standby unit at the end of each scan. This ensures that the Standby is aware of the latest conditions and is ready to take control if needed.

If one or both of the links between the Hot Standby modules is not functioning, the Primary controller functions as though no backup is available.

If the Primary controller fails, the Standby automatically assumes control of the remote I/O network. If the Primary controller recovers from failure, and a power cycle is completed, then it assumes Standby responsibilities. If it cannot recover, it remains offline.

If the Standby controller fails, it goes offline. The Primary controller functions as a standalone and continues to manage the I/O networks.

---

---

# Additional Guidelines for IEC Hot Standby



# 8

---

## At a Glance

### Purpose

This Chapter discusses optimizing an IEC application to run better in an IEC Hot Standby environment, and specifically, how to save data memory. This includes existing and newly developed IEC applications.

### What's in this Chapter?

This chapter contains the following sections:

Section	Topic	Page
8.1	General Application Requirements	149
8.2	State RAM	155
8.3	Efficiency Tips	157



---

## 8.1 General Application Requirements

---

### Introduction

---

**Purpose** This section describes general application requirements for an IEC Hot Standby system.

---

**What's in this Section?** This section contains the following topics:

Topic	Page
Memory Savings	150
Memory Statistics	151
Memory Partition	153

---

## Memory Savings

---

**Memory Savings** The reasons that memory savings are important to IEC Hot Standby are:

- The full amount of data memory is restricted to what the IEC HSBY Register can be set to, which can never exceed 64K words (128K).
- The bigger the configured state RAM is, the higher the overall scan time. Since the IEC HSBY Registers are part of the state RAM, the overall scan time gets lower with every saved byte of data memory.

The restriction of the size of executable code to a maximum of 568K is not important, since any IEC application is closer to the limit of 128K of data than to the limit of 568K executable code. Therefore all optimization in terms of either making a bigger IEC application fit into the IEC Hot Standby environment or just to make an existing application run faster in IEC Hot Standby mode will decrease the size of data memory.

---

### Assessing Existing IEC Applications

The assessment of an existing IEC application that will be put into IEC Hot Standby mode is fairly simple. Just download the application to the CPU 534 14 or 434 12 or into the 32 bit simulator with one of the Quantum CPUs selected. This requires having IEC Hot Standby not activated in the configuration. Once the application is downloaded, you can view the memory consumption in the Memory Statistics dialog while being "Equal" connected to the PLC (or the simulator).

The diagram below shows the Memory Statistics dialog after having an example application downloaded to the PLC. The consumption for executable code of this particular application is:

357,724 bytes (user program)  
+14,980 bytes (EFB library)  
= 372,704 bytes (used for executable code)

The executable code's size is less than the limit of 568K, therefore the application fits the IEC Hot Standby requirements.

---

## Memory Statistics

### Memory Statistics

The following screen shows memory statistics.  
Concept shown

Memory Statistics		
Total memory:	488,048 Bytes	100.0 %
Free memory:	61,040 Bytes	12.5 %
<b>Used memory</b>		
User program:	357,724 Bytes	73.3 %
EFB library:	14,980 Bytes	3.1 %
DFB instance data:	54,304 Bytes	11.1 %
<b>Program Data</b>		
Configured:	28,000 Bytes	100.0 %
Used:	22,496 Bytes	80.3 %
PLC scan time:	8.8 ms/scan	
<input type="button" value="Refresh"/> <input type="button" value="Close"/> <input type="button" value="Help"/>		

### Data Memory

The consumption of data memory is:

54,305 bytes (DFB instance data)  
 + 22,496 bytes (program data used)  
 = 76,801bytes (used for data)

**Data Memory,  
Continued**

This value alone is not enough to verify whether or not the application fits, since we need to know how many IEC HSBY Registers (3x) can be reserved to carry the data from the Primary to the Standby controller. The diagram below shows that 11,022 words out of 65,024 are already taken for I/O references and located variables. Therefore the maximum for IEC HSBY Registers would be  $65,024 - 11,022 = 54,002$  words  $\sim 108,000$  bytes. This is more than what is actually used for application data (76,801 bytes), so that the application would fit IEC Hot Standby requirements.

The maximum size of the safety buffer for future modifications would be:  
 $108,000 - 76,801 = 31,199$  bytes which is  $(31,199 / 76,801) \sim 41\%$   
Depending on how much safety buffer is required for this particular application, the final size of the IEC HSBY Registers could be determined. That, together with the table presented in *Theory of IEC HSBY Operation*, p. 43, would give an idea about the application's overall scan time when operated in IEC Hot Standby mode.

---



## Memory Partition

**Memory Partition** The following screen shows a PLC Memory Partition.  
Concept shown

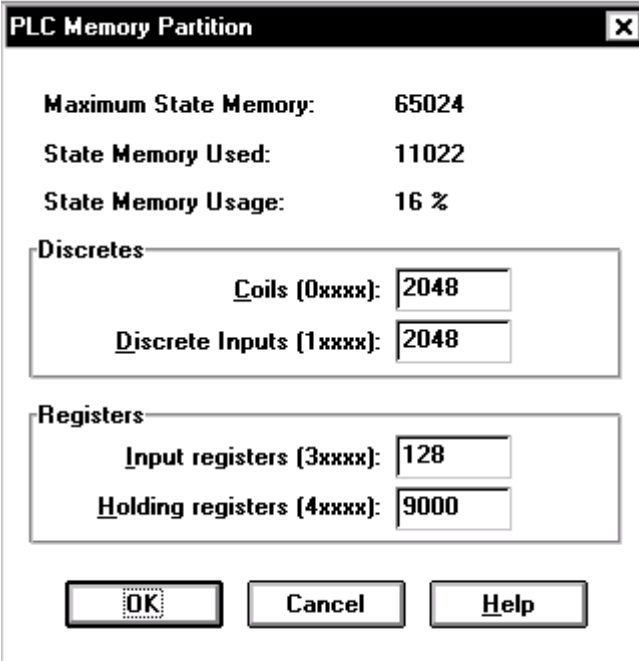

The screenshot shows a dialog box titled "PLC Memory Partition" with a close button (X) in the top right corner. The dialog displays the following information:

<b>Maximum State Memory:</b>	<b>65024</b>
<b>State Memory Used:</b>	<b>11022</b>
<b>State Memory Usage:</b>	<b>16 %</b>

Below this, there are two sections with input fields:

**Discretes**

<b>Coils (0xxxx):</b>	<input type="text" value="2048"/>
<b>Discrete Inputs (1xxxx):</b>	<input type="text" value="2048"/>

**Registers**

<b>Input registers (3xxxx):</b>	<input type="text" value="128"/>
<b>Holding registers (4xxxx):</b>	<input type="text" value="9000"/>

At the bottom of the dialog are three buttons: **OK**, **Cancel**, and **Help**.

### IEC Applications Optimization

Optimization of IEC Hot Standby applications concentrates on two issues:

- Very efficient use of state RAM for purposes other than IEC HSBY Registers (See #1, following)
- Very efficient use of IEC application data (See #2, following)

**IEC Applications  
Optimization,  
Continued**

1. There are 64K words of state RAM as a maximum for IEC HSBY Registers in an IEC Hot Standby application. Using as little state RAM as possible for other purposes besides IEC HSBY Registers, allows running medium sized IEC applications in IEC Hot Standby mode. When using the IEC application data very efficiently, the size of the application can grow from medium to large.
  2. To optimize an IEC application to consume as little memory as possible takes some effort and may reduce the maintainability of the application. Therefore you should always try to reduce data memory to what is needed. The efficient use of the State RAM, as described in the following section, should be considered whenever possible. It provides large data memory benefits compared to the work needed to achieve it.
-

---

## 8.2 State RAM

---

### Efficient Use of State RAM

---

#### Configured State RAM Registers

Since in IEC Hot Standby, all the configured state RAM registers and bits are transferred on every scan from the Primary to the Standby, it is worth having every part of that area provide a purpose for the application. Sometimes application designers decide to have gaps between the I/O references of each RIO drop, for future changes, but usually those gaps never get filled up, so there is always a certain amount of unused state RAM references. However, unused references require memory space, and are transferred every scan, which increases the overall scan time.

The better method is to assign contiguous I/O references without gaps. This means the designer should not be concerned about the actual reference number an I/O point occupies. Just give it a number and a name, and reference it in the IEC logic by name. This way, whenever the actual state RAM reference number changes, it would not have any impact on the logic itself, because the name does not change. The positive effect is that all the configured state RAM is actually used and Ram size therefore minimized.

In Concept 2.1, this downsizing of the configured state RAM is especially important with coils (0x) and discretets (1x). In that and earlier versions of Concept, these state RAM references are not accessed directly, but rather indirectly through the so called "Mirror Buffer". This is a continuous block of memory (part of DFB instance data) in which, at the beginning of every scan the 0x and 1x states are copied (mirrored). At the end of every scan, the states of the mirror buffer are copied back into the 0x and 1x area. During the scan the IEC logic accesses the mirrors of the 0x and 1x references, instead of accessing them directly. The data memory behind the mirror buffer is that every coil and discrete is represented by a byte in the mirror buffer, not by a bit. The reason for this was to facilitate generation of the IEC application executable code.

**Note:** In Concept 2.1 each configured 0x/1x reference consumes per default 1 byte of the DFB instance data area, which is IEC data and is going to be transferred from Primary to Standby on every scan and that in turn extends the overall scan time. It does not matter whether a particular discrete reference is used in IEC logic or not, when it's configured it takes one byte in the mirror buffer.

**Configured State  
RAM Registers,  
Continued**

With Concept 2.2 the mirror buffer does not exist anymore, but it's still worth not having significantly more state RAM references configured than actually used. The actual use of state RAM references should concentrate on I/O purposes only and not on storing some application data, just to make it accessible for a SCADA system. The better way would be to use any kind of application related data, which includes everything except I/O points, pure IEC variables (non located variables). The connection to the SCADA system can then be accomplished more easily with an OPC (OLE for Process Control) server, that accesses certain application data by name and not by location. This method of SCADA connection is very flexible and reliable and saves state RAM, which is good for IEC Hot Standby applications.

---

**Efficient Use of  
IEC Application  
Data**

There is one thing that can reduce the IEC application data consumption better than anything else:

Program only what's really necessary to control a particular process. When learning about IEC compliant programming and the different EFBs in the different libraries, concentrate on which EFBs not to use. This will help you reduce the size of an application to the necessary minimum.

---

---

## 8.3 Efficiency Tips

---

### Introduction

---

**Purpose** This section describes efficiency tips for the IEC Hot Standby.

---

**What's in this Section?** This section contains the following topics:

Topic	Page
Use Constants Instead of Equal Literals	158
Use Constants Instead of Open Inputs	159
Programmed Logic	161
Reduce the Use Of Complex Data Structures	162

---

## Use Constants Instead of Equal Literals

---

### Equal Literals

In the diagram below, when multiple EFB instances use the same fixed value as input, they are using equal literals. This is not much logic, but there is already a lot of data to save, actually it's 12 bytes. The trick is to declare a constant of type REAL with the value 1.0 and use that in the logic instead of always assigning equal literals to the inputs.

The point is: Every literal, no matter what value it has, is stored separately in data memory (program data area), this brings up the advantage that it could be modified due to a download change. Literals are rarely modified, therefore the modified logic in the diagram below would be more appropriate.

The four times allocated literal with the value 1.0 has been replaced with a one time allocated constant that has the value 1.0 as well. This little change saved 12 bytes of data memory, since the type REAL takes 4 bytes and now needs to be allocated 3 times less.

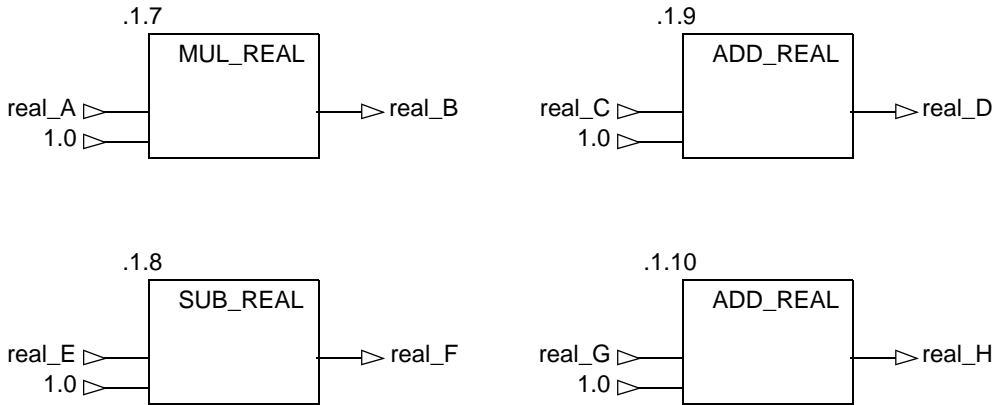

## Use Constants Instead of Open Inputs

### Programmed Logic

The number of unused pins should be reduced to the absolute minimum, so as to not waste any memory for hidden allocated memory that is used nowhere. But there are some cases where this is just not possible, as in the example below.

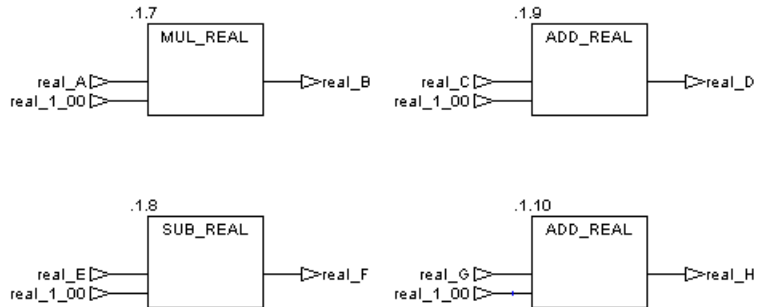

Therefore the logic should look like the diagram below.

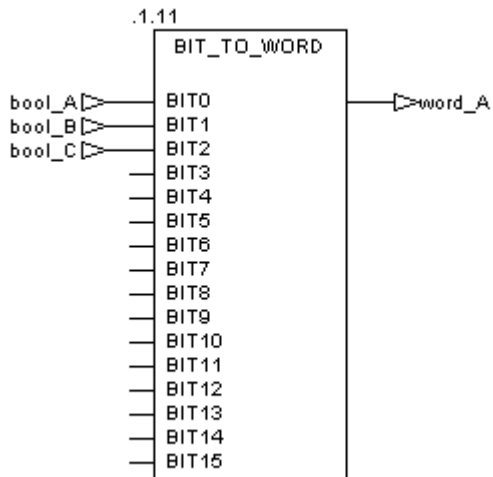

**Programmed  
Logic, Continued**

The only problem with logic programmed like that is, for every open pin there is as much memory allocated as its data type requires. In this case there are 13 bytes of unused memory allocated. To reduce those 13 bytes to just 1 byte means connecting a constant to every open pin that makes the logic work as if the pin was open. This is always equivalent to zero, or FALSE in this case.

Therefore, the logic should look like the diagram below.

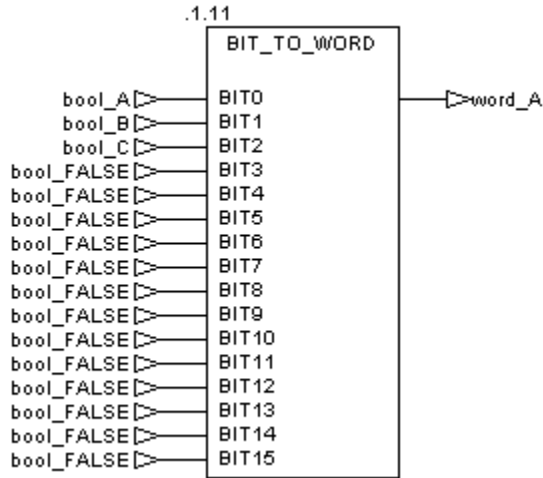



## Programmed Logic

---

### **Reduce DFB Instances**

Every DFB instance consumes a certain amount of overhead data memory, which grows with the number of input and output pins. To make the ratio between the fixed overhead and the DFB internal logic's data as small as possible, DFBs should be used only when they cover a really big part of specialized logic. That means when a DFB contains just one section with a few blocks of FBD/LD or a few lines of IL/ST logic, you should probably consider replacing it with a macro that links the DFB-logic directly to the program logic. Although if a DFB is used just a few times, like 1 to 10 times, consider not changing it, since the data memory savings might be too small to be worth the work.

When some complicated logic has to be implemented, especially when it comes to numeric algorithms, none of the IEC languages allow a really data efficient implementation. Therefore, when a DFB should cover some of those kinds of logic, it is worth implementing it as an EFB instead. EFBs are implemented in C, C++ language, which allows highly effective implementations of any kind of logic. To implement EFBs, Schneider Electric offers the Concept-EFB-Toolkit. But it should be noted, that EFBs do not allow animation of their internal data at runtime like DFBs do.

Even with EFBs you should avoid having any unused input and output pins, because every pin takes the data memory that its data type requires.

---

## Reduce the Use Of Complex Data Structures

---

### **Reduce Use of Complex Data Structures**

Usually, when complex data structures are used, the probability that each of its members are actually used is fairly low. Additionally, when complex data structures are passed as variables or links, each superfluous input/output pin, link or variable has a lot more impact on data consumption than when using primitive data types. This is especially true whenever the "MOVE" EFB is involved, of which the usage should be reduced to the absolute minimum, or to none at all. Whenever the result of some preceding logic gets assigned to a variable, make sure that this variable is the final target for that value, not just an intermediate storage. Intermediate variables are often used for loosening the logic between different sections. However, it makes sense to reduce the full amount of global variables, not only in terms of data memory savings, but also in terms of application overview.

Handle the selection of arrays as data types for variables carefully, since the selected array is often bigger than needed.

The choice of all different IEC compliant languages is made for a good reason. For many different application problems, the best way to solve them depends heavily on what language has been selected for its implementation. Of course, the language selection is also a matter of the preferences of the programmers and those who maintain the application. The user should be free in his decision about which of the IEC languages to select for his particular application.

Because of the different focus of the IEC compliant languages, it is difficult to compare them. It should be mentioned, however, that the SFC language consumes more data in accomplishing a stepwise program execution compared than what one would expect from the implementation of that feature in another language. The overall data consumption of SFC steps ranges between 20 to 25 bytes per step, which does not include any data from transition sections.

---

---

# Ethernet Hot Standby Solution

# 9

---

## At a Glance

### Purpose

This chapter describes configuring and then using the Hot Standby solution with the NOE 771xx product line which supports Ethernet communication. The chapter covers solution-relevant topics such as IP Address assignment, NOE modes and Hot Standby states, address swap times, and network effects on the Hot Standby solution.

### What's in this Chapter?

This chapter contains the following topics:

Topic	Page
Overview of Hot Standby Solution for NOEs	164
Hot Standby Topology	166
NOE Configuration and Hot Standby	167
IP Address Assignment	168
NOE Operating Modes and Hot Standby	169
Address Swap Times	173
Network Effects of Hot Standby Solution	174

---

## Overview of Hot Standby Solution for NOEs

---

### Please Note

The Quantum Hot Standby system supports up to four NOE 771 Ethernet connections. For a more detailed description of the physical set up of a Hot Standby system, refer to the *Quantum NOE 771 xx Ethernet Modules User Guide*, 840USE11600, Chapter 9, "Hot Standby".

---

### Description of the Hot Standby Solution

The Hot Standby solution provides bumpless transfer of I/O using remote I/O. The NOE Hot Standby support now allows automation IP Address change. Both controllers are configured identically. One controller is the Primary NOE; the other controller, the Secondary NOE. In case of a failure, the controllers switchover and the system recovers quickly.

The NOEs coordinate the swapping of IP addresses. After closing both the client and the server connections, each NOE sends a swap UDP message to its peer NOE. The sending NOE then waits a specified timeout (500 ms) for the peer swap of UDP messages. Either after receiving the messages or after a timeout, the NOE changes its IP address.

**Note:** NOEs must communicate with each other in order to swap IP Addresses. Schneider Electric recommends that you connect the primary and Secondary NOEs to the same switch because

- Communication failures between the NOEs increases the time to swap
- Connecting two NOEs to the same switch, minimizes the probability of a communication failure

**Note:** Schneider Electric recommends that a switch is used to connect the NOEs to each other or to the network. Schneider Electric offers switches; please contact a local sales office for more information.

The NOE waits for either a change in the controller's Hot Standby state or the swap of UDP messages. Then the NOE performs one of two Hot Standby actions. If the NOE:

1. Detects that the new Hot Standby state is either primary or standby:  
The NOE changes the IP address
2. Receives a swap UDP message:  
The NOE transmits a Swap UDP message and swaps the IP address

---

All client/server services (I/O Scanner, Global Data, Messaging, FTP, SNMP, and HTTP) continue to run after the switchover from the old to the new Primary NOE.

**Note:** Failure of an NOE module is not a condition for the primary system to leave the primary state.

### Hot Standby and NOE Module Functionality

The NOE 771 family provides different Ethernet services. Some services are enabled or disabled in a Hot Standby system. The following table shows which services are enabled and disabled.

Service	NOE 771 x0	NOE 771 x1
I/O Scanning	Disabled	Enabled
Global Data	N/A	Enabled
Modbus Messaging	Enabled	Enabled
FTP/TFTP	FTP Enabled	Enabled
SNMP	Enabled	Enabled
HTTP Server	Enabled	Enabled
DHCP	N/A	Disabled

## Hot Standby Topology

### Hot Standby Interconnection

The following diagram shows a Hot Standby system the relationship between the two redundant systems. Two CHS 110 modules are connected via a fiber optic link. The RIOs are connected both to each other and to the RIO Drops.

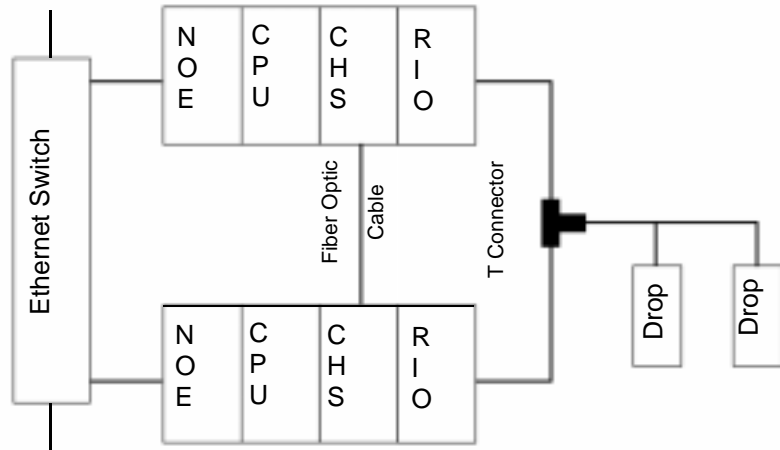

**Note:** The following three items are important.

1. The two systems must be identical.
2. The order of the modules in each rack must be the same.
3. The software revisions must be the same.

In the preceding diagram the NOEs are connected to the same switch. Connecting to the same switch is recommended but not required. Connecting to the same switch is recommended because the NOEs communicate with each other in order to swap the IP address.

There are two reasons for connecting to the same switch:

- If a failure to communicate between the NOEs occurs, the time to swap increases.
- Therefore to minimize the probability of a failure, connect the two NOEs to the same switch.

The other requirement for the switches is that they are on the same sub network.

## NOE Configuration and Hot Standby

---

### **TCP/IP Configuration**

When an NOE goes into service the first time, the NOE attempts to get its IP Address from a BOOTP server. If no BOOTP server is available, the NOE derives its IP Address from its MAC address. Connecting to a BOOTP server or deriving the IP Address from a MAC address allows you a connection to the NOE, that enables you to download a project to the PLC.

All standard rules apply to IP addressing with the additional restriction that the IP address cannot be greater than 253 or broadcast address minus 2. Also, no other device can be assigned the configured IP + 1 address.

---

## IP Address Assignment

---

### Configuring the NOE

The NOE can be configured to work in conjunction with the Hot Standby controller. Since the Primary and Secondary controllers must have an identical configuration, the configured IP Addresses will be the same. The NOE's IP Address is either the configured IP Address or the configured IP Address +1. The IP Address is determined by the current local Hot Standby state.

In the Offline state, the IP Address is determined by whether or not the other controller is in transition to the Primary state.

**Note:** For a Hot Standby system, the two IP Addresses will be consecutive.

The following table shows the IP Address assignments.

Hot Standby State	IP Address
Primary	Configured IP Address
Standby	Configured IP Address + 1
Transition from Primary to Offline	Configured IP Address, if peer controller <b>does not</b> go to Primary
Transition from Standby to Offline	Configured IP Address + 1

**Note:** Offline - Results depend on whether or not the other controller is detected as in transition into the primary state. If Current IP is the configured IP Address, then change the IP Address to the configured IP Address + 1.

### IP Address Transparency

For continued Ethernet communication, the new Primary NOE must have the same IP Address as the former Primary NOE. The IP Address in the Secondary NOE (an NOE in the secondary state) is IP Address + 1.

The NOEs integrated in the Hot Standby configuration coordinate this swapping IP Address with the management of Ethernet services used.

**Note:** Do not use the address IP + 1. For a Hot Standby system, do not use consecutive addresses of the configured IP Address. If you configure the last IP Address (255), NOE returns diagnostic code "Bad IP configuration".



## NOE Operating Modes and Hot Standby

---

**The NOE Modes**    The NOE modes are

- **Primary Mode**  
The Hot Standby state is primary, and all services are active.
- **Secondary Mode**  
The Hot Standby state is standby, and all server services are except DHCP.
- **Standalone Mode**  
Occurs when NOE is in a non redundant system, or if the CHS module is not present or is not healthy.
- **Offline Mode**  
CPU is stopped.  
CHS module is in Offline mode.

The Hot Standby and the NOE operating mode are synchronized by the conditions described in the following table.

CHS Module Status	HSBY State	NOE Operating Mode
Present and Healthy	Primary	Primary
Present and Healthy	Standby	Secondary
Present and Healthy	Offline	Offline
Present and Healthy	Unassigned	Standalone
Not present or unhealthy	N/A	Standalone

Any one of four events will affect the NOE operating mode. These four events occur when the NOE is powered-up, when an NOE executes a Hot Standby switchover, when an NOE goes to offline mode, or when a new application is downloaded to the NOE.

---

### Power-Up and IP Address Assignment

The process of powering up affects the NOE's IP Address assignment. To clarify what happens during a power-up, the following two sections describe the power-up effects on IP Address assignment and Ethernet services.

An NOE obtains its IP Address assignment at power-up as follows:

If the HSBY state is ...	Then the IP Address assigned is ...
Unassigned	Configured IP Address
Primary	Configured IP Address
Secondary	Configured IP Address + 1
Unassigned to Offline	See the <i>Offline Mode at Power-up Sequence</i> table following

If two NOEs power-up simultaneously, a "resolution algorithm" determines the Primary NOE, and after determining the Primary NOE, the "resolution algorithm" assigns the configured IP Address to the Primary NOE and then assigns the configured IP Address + 1 to the Secondary NOE.

**Offline Mode at Power-up Sequence** table:

Offline Mode at Power-up Sequence	Result
Controller A powers-up before controller B	<ul style="list-style-type: none"> <li>● IP Address of controller A is configured IP Address</li> <li>● IP Address of controller B is the configured IP Address + 1</li> </ul>
Both controller A and controller B power-up at the same time	The resolution algorithm will assign controller A the configured IP address and will assign controller B the configured IP address + 1.

The NOE performs a "duplicate IP" test by issuing an ARP request to the configured IP Address. If a response is received within 3 seconds, the IP Address remains at the Default IP and blinks a diagnostic code.

If no IP configuration exists, the NOE remains in standalone mode, and the IP Address must be obtained from either a BOOTP server or from a MAC address.

## Power-Up and Ethernet Services

The process of powering up affects the status of client/server services. To clarify what happens during a power-up, the following section describes the power-up effects on the Ethernet services.

The following table shows how the status of an NOE service is affected by the Hot Standby state.

HSBY State	Status of NOE Services					
	Client Services		Client/ Server Services	Server Services		
	I/O Scanner	Global Data		Modbus Messaging	FTP	SNMP
Unassigned	Run	Run	Run	Run	Run	Run
Primary	Run	Run	Run	Run	Run	Run
Secondary	Stop	Stop	Run	Run	Run	Run
Offline	Stop	Stop	Run	Run	Run	Run

## Hot Standby Switchover

The following steps describe how NOEs coordinate the Hot Standby switchover.

Step	Action
1	NOE A (installed in a HSBY rack) detects that its local controller changed from Primary to Offline.
2	NOE A changes its HSBY state from Primary to Offline with the same Ethernet services running, starts its watch-dog timer (with 500 ms timeout setting), and expects from its peer NOE an UDP request to swap the IP Address.
3	NOE B (installed in peer HSBY rack) detects that its local controller changed state from Secondary to Primary.
4	NOE B stops all Ethernet services, sends an UDP request to its peer NOE (NOE A) for the synchronization of the IP Address swap, starts its watch-dog timer (with 500 ms timeout setting), and then waits for an UDP response from its peer NOE.
5	Once NOE A receives the UDP request from NOE B (or after its watch-dog timer times out), it stops all Ethernet services, sends an UDP response to NOE B (no UDP response is sent to NOE B for watch-dog timeout case), swaps IP Address as Secondary, and starts Secondary services.
6	As soon as NOE B receives the UDP response from NOE A (or after its watch-dog timer times out), it swaps IP Addresses and starts Ethernet services as Primary.
7	After NOE A senses that its local controller changes state from Offline to Standby, it changes to Secondary accordingly.

Step	Action
8	The Secondary NOE now becomes the Primary NOE.
9	Primary NOE opens all client connections and listens for all server connections and re-establishes those connections.
10	Simultaneously, Secondary NOE listens for all server connections and re-establishes those connections.

---

**Additional Switchover Information**

The following list provides additional information about the NOE's IP addressing process resulting from a Hot Standby switchover.

- Some MSTR/IEC Function blocks will not complete their transaction as a result of the IP Address swap.  
In this case, the MSTR/IEC Function block will return the error code 0x8000.
  - While the NOE is in the process of performing the above actions, a new MSTR/IEC Function block may become active.  
No resources are available to service the new MSTR/IEC Function block.  
Therefore, the NOE will **not** service this new MSTR/IEC Function block, and all three output lines will be low.
- 

**Going to Offline**

When either the CPU stops or the Hot Standby state goes to offline mode, two events occur:

1. NOE mode goes to Offline
2. NOE uses the IP Address of the present configuration

**IP Address Assignment and Going Offline**

HSBY State	IP Address Assigned Is ...
Primary to Offline	Configured IP Address, if other controller <b>does not</b> go to Primary
Standby to Offline	Configured IP Address + 1

---

## Address Swap Times

### Description

The following table details what the "time for an Address swap" comprises, such as the time to close connections, time to swap IP addresses, or time to establish connections.

The following table shows the swap time for each of the Ethernet services.

Service	Typical Swap Time	Maximum Swap Time
Swap IP Addresses	6 ms	500 ms
I/O Scanning	1 initial cycle of I/O Scanning	500 ms + 1 initial cycle of I/O scanning
Global Data	For times, please see the 840USE11600, <i>Quantum NOE 771 xx Ethernet Modules User Guide</i>	500 ms + 1 CPU scan
Client Messaging	1 CPU scan	500 ms + 1 CPU scan
Server Messaging	1 CPU scan + the time of the client reestablishment connection	500 ms + the time of the client reestablishment connection
FTP/TFTP Server	The time of the client reestablishment connection	500 ms + the time of the client reestablishment connection
SNMP	1 CPU scan	500 ms + 1 CPU scan
HTTP Server	The time of the client reestablishment connection	500 ms + the time of the client reestablishment connection

## Network Effects of Hot Standby Solution

---

### Overview

The Hot Standby solution is a powerful feature of NOEs, a feature that increases the reliability of your installation. Hot Standby uses a network, and using the Hot Standby feature over a network can affect the behavior of

- Browsers
- Remote and Local clients
- I/O Scanning service
- Global Data service
- FTP/TFTP server

The following are factors you may encounter while using the Hot Standby solution.

---

### Browsers

**Note:** In Hot Standby configuration the NOE's I/O scanner is enabled.

If a browser requests a page and during the process of downloading that page an IP Address swap occurs, the browser will either hang or time out. Click the **Refresh** or **Reload** button.

---

### Remote Clients

Hot Standby swaps affect remote clients.  
An NOE will reset under the following conditions:

- **Remote Connection Request during Hot Standby Swap**  
If a remote client establishes a TCP/IP connection during a Hot Standby swap, the server closes the connection using a TCP/IP reset.
- **Hot Standby Swap during Remote Connection Request**  
If a remote client makes a connection request and a Hot Standby swap occurs during the connection request, the sever rejects the TCP/IP connection by sending a reset.
- **Outstanding Requests**  
If there is an outstanding request, the NOE will not respond to the request, but the NOE will reset the connection.

The NOE will do a Modbus logout if any connection has logged in.

---

### Local Clients

During a swap, the NOE will reset all client connections using a TCP/IP reset.

---

**I/O Scanning Service**

The I/O Scanning provides the repetitive exchange of data with remote TCP/IP nodes I/O devices. While the PLC is running the Primary NOE sends Modbus Read/Write, read or write request to remote I/O devices, and transfer data to and from the PLC memory. In the secondary controller, the I/O scanning service is stopped. When the Hot Standby swap occurs, the Primary NOE closes all connections with I/O devices by sending a TCP/IP reset. The I/O scanning service in this NOE is standby.

After the swap, the new Primary NOE re-establishes the connection with each I/O devices. It restarts the repetitive exchange of data with these re-connections.

---

**Global Data (Publish/Subscribe) Service**

The Hot Standby NOE is one station within a distribution group. Distribution groups exchange application variables. Exchanging application variables allows the system to coordinate all the stations in the distribution group. Every station publishes local application variable in a distribution group for all other stations and can subscribe to remote application variables independent of the location of the producer. The communication port has only one multicast address.

In this network service, the Hot Standby controllers are viewed like only one station. The Primary NOE publishes the Hot Standby application variables and receives the subscription variables. The Secondary NOE global data service is in a stopped state.

When the Hot Standby swap occurs, the Primary NOE stops the Global Data service. The NOE does not publish the local variable during a swap. And after the swap, the new Primary NOE starts to publish application variables and to receive the subscription variables.

---

**FTP/TFTP Server**

The File Transfer Protocol/Trivial File Transfer Protocol (FTP/TFTP) server is available as soon as the module receives an IP address. Any FTP/TFTP client can logon to the module. Access requires the correct user name and password. Hot Standby allows only one active FTP/TFTP client session per NOE module. When the Hot Standby swap occurs, the Primary and Secondary NOEs close the FTP/TFTP connection. If a user sends an FTP/TFTP request during the swap, the communication is closed.

Whenever you re-open communication, you must re-enter a user name and a password.

---





---

# Maintenance

# 10

---

## At a Glance

### Purpose

This chapter discusses maintenance procedures for the HSBY system.

### What's in this Chapter?

This chapter contains the following sections:

Section	Topic	Page
10.1	Health of a Hot Standby System	179
10.2	Errors	183
10.3	Failures	187
10.4	Replacement	192
10.5	Testing	201



---

## 10.1 Health of a Hot Standby System

---

### Introduction

---

**Purpose** This section describes checking the health of a Hot Standby System.

---

**What's in this Section?** This section contains the following topics:

Topic	Page
Verifying Health of a Hot Standby System	180
Additional Checks	181

---

## Verifying Health of a Hot Standby System

---

**Health Messages** The Hot Standby modules exchange a health message approximately every 10 ms. If the Primary has an error, the Standby is notified and assumes the Primary role. If the Standby has an error, the Primary continues to operate as a standalone. The RIO head processors also verify communication with one another periodically.

---

**Automatic Confidence Tests** The system automatically performs two kinds of confidence tests on the Hot Standby modules:

- Startup tests
- Run time tests

---

**Startup Tests** The system performs four startup tests:

- Prom checksum
- RAM data test
- RAM address test
- Dual port RAM test

If the module fails any of these tests, it remains offline and does not communicate with the other Hot Standby module. To retest the system, the power must be turned off and on again.

---

**Run Time Tests** These tests are performed whenever the Ready indicator is on. They are executed in small groups to prevent delays in scan time.

The system performs three kinds of run time confidence tests:

- Prom checksum
- RAM data test
- RAM address test

---

## Additional Checks

---

### **Checking on a Redundant Power Supply**

If you have a redundant power supply, you may use the STAT block to check its operation. The redundant power supply must be I/O mapped for its status to be displayed. The I/O module status section of the STAT block begins at word 12.

---

### **Responding to and Recognizing Errors**

When a CHS 110 Hot Standby module experiences an error, it takes its controller offline. It does not communicate with the other CHS 110 module or take part in state RAM data transfers.

The LEDs on the front panel of the module can help you locate the source of the error. The display pattern tells you which controller is experiencing problems and what kind of error is occurring. There are four kinds of errors associated with the Hot Standby system:

- Startup errors
- Communication errors
- Communication errors
- Interface errors
- Board-level errors

For each type of error, try the suggested remedies in the order given. If no remedy suggested here resolves the error, call Schneider Electric customer support at 1-800-468-5342 for further directions.

---

**Safety  
Precautions**

Before you begin, take the following safety precautions:

	<b>WARNING</b>
	<b>ELECTRIC SHOCK HAZARD</b> To protect yourself and others against electric shock, allow no one to touch energized high voltage circuits (such as 115V AC). Before connecting or disconnecting any high voltage component, open and padlock open the disconnect switch which provides power to that component. <b>Failure to follow this precaution can result in death, serious injury, or equipment damage.</b>

	<b>WARNING</b>
	<b>Avoid Damage to Application I/O Devices</b> To avoid damage to application I/O devices through unexpected system action while disconnecting any remote I/O cable, disconnect only the feed through terminator from the module, leaving the terminator connected to its cable. <b>Failure to follow this precaution can result in death, serious injury, or equipment damage.</b>

<b>Note:</b> Before you replace any module in either backplane, be sure that the spare module is compatible with the Hot Standby system. Be sure that you use the correct terminator.
---

---

---

## 10.2 Errors

---

### Introduction

---

#### Purpose

This section will help you determine component failure and causes.

---

#### What's in this Section?

This section contains the following topics:

Topic	Page
Startup Errors	184
Communications Errors	185
Board Level Errors	186

---

## Startup Errors

---

### LED Display for a Startup Error

When the Hot Standby system detects a mismatch between the Primary and Standby controllers, it reports a startup error. The mismatch may be in the configuration, including segment scheduler, I/O map or designation slide switch positions. The LEDs display the error pattern. The Ready indicator is a steady green, while the Com Act indicator blinks.

If the LEDs indicate a startup error and if you have difficulty determining why, you can access some startup error codes through software. Refer to Chapter 3 of the *Quantum Automation Series Hardware Reference Guide* for details.

---

### Troubleshooting

Take the following troubleshooting steps:

Step	Action
1	Be sure the designation slide switches on the CHS 110 modules are in opposite positions.
2	Be sure the configuration tables in the Primary and Standby controllers are identical.
3	Be sure the segment schedulers in the Primary and Standby controllers are identical.
4	Be sure the I/O maps in the Primary and Standby controllers are identical.

---



## Communications Errors

### LEDs

If the CHS 110 module detects a communications error, the LEDs display the following pattern:

LED display for a communications error.

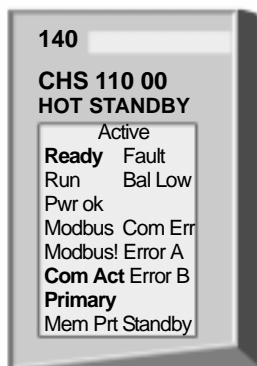

### Troubleshooting

1. Be sure the fiber optic cables are connected properly and functioning correctly
2. If the fiber optic cables are in good condition, replace the faulty CHS 110 module.

### Interface Errors

If the Hot Standby module detects certain errors in its interface with the controller, the LED display goes out momentarily as the module tries to recover. It either returns to a ready state or reports the error with a blinking Com Act indicator. The Com Act error patterns are described in *Com Act Error Patterns, p. 209*.

### Troubleshooting

1. If you used the CHS function block, disable it and restart the system. If the Ready indicator comes on, the problem is in the CHS 110 module. If you used a configuration extension screen, go offline and change the configuration to a standalone system. Reload the program. Restart the system. If the Ready indicator comes on, the problem is in the CHS 110 module.
2. If you have replaced the Hot Standby module and the problem still occurs, replace the other components, one at a time.
3. If the problem still occurs, replace the backplane.

## Board Level Errors

---

### PROM, RAM, UART

Board level errors include PROM checksum, RAM data, RAM address and UART errors. If the Hot Standby module detects one of these errors, it displays the following pattern:

---

### LED Display for a Board Level Error

The diagram below shows a LED Display for a Board Level Error.

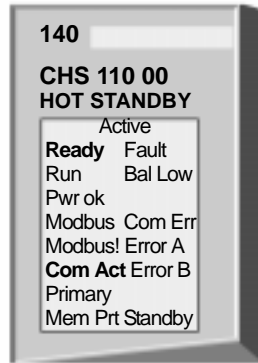

### Troubleshooting

The Ready indicator is a steady green, while the Com Act indicator blinks. This is the same pattern the module displays for a startup error. Follow the troubleshooting procedures for a startup error. If the module does not recover, replace it. Replace the faulty CHS 110 module.

---

---

## 10.3 Failures

---

### Introduction

---

**Purpose** This section helps you determine component failure and causes.

---

**What's in this Section?** This section contains the following topics:

Topic	Page
Detecting Failures in a Hot Standby System	188
Detecting Failures in the Primary Backplane	189
Detecting Failures in the Standby Backplane	190
Failure of Fiber Link from Primary Transmit to Standby Receiver	191

---

## Detecting Failures in a Hot Standby System

---

### **Main Components of the Primary Backplane**

If one of the main components of the Primary backplane fails, control shifts to the Standby. If a component fails in the Standby backplane, the Standby goes offline. Likewise, if the fiber cable link between the Hot Standby modules fails, the Standby goes offline.

This section helps you determine which component failed. When you have replaced that component, you must cycle power, with one exception. After cycling power, if the backplane is now operating, it assumes the Standby role. If the failure was in the fiber cable, the backplane may return to Standby mode without cycling power. If replacing the component does not solve the problem, call Schneider Electric customer support at 1-800-468-5342 for further directions.

---

## Detecting Failures in the Primary Backplane

**Troubleshooting Components** To determine which component failed, compare the status of the controller, Hot Standby module and RIO head to the chart below:

Controller	CHS 110	RIO Head	Failure Type	Description
Stops	All LEDs off except READY OR COM ACT displays error pattern	All LEDs off except READY	READY on and COM ACT blinks four times	The Interface error patterns are described in <i>Com Act Error Patterns, p. 209</i>
Runs as offline	All LEDs off except READY OR COM ACT displays error pattern	All LEDs off except READY	CHS 110	The Com Act error patterns are described in (See <i>Com Act Error Patterns, p. 209</i> )
Stops	All LEDs off except READY	All LEDs off except READY OR COM ACT displays error pattern	RIO Head	The Com Act error patterns are described in <i>Com Act Error Patterns, p. 209</i>
Stops	All LEDs off except READY	READY on and COM ACT blinks four times	RIO Cable Failure at Primary End	In a dual cable system, if only one cable fails, the Error A or Error B indicator on the RIO head lights instead and the system continues to operate. When the RIO cable fails at the Primary end, input data may be reset to 0 for one scan because the communication failure to the drop occurs before the broken link is detected.

## Detecting Failures in the Standby Backplane

### Troubleshooting Components

To determine which component failed, compare the status of the controller, Hot Standby module and RIO head to the chart below.

Controller	CHS 110	RIO Head	Failure	Description
Stops	All LEDs off except READY OR COM ACT displays error pattern	All LEDs off except READY OR READY on and COM ACT blinks once a second	Controller	The Interface error patterns are described in <i>Com Act Error Patterns, p. 209</i>
Runs as offline	COM ACT displays error pattern	READY on and COM ACT stops blinking	CHS 110	The Com Act error patterns are described in <i>Com Act Error Patterns, p. 209</i>
Stops	All LEDs off except READY	COM ACT displays error pattern	RIO Head	After you have replaced the module and cycled power, you must perform a program update, to ensure that the controllers have identical programs. Error codes for a blinking Com Act indicator are listed in <i>Com Act Error Patterns, p. 209</i>
Stops	All LEDs off except READY	READY on and COM ACT blinks four times	RIO Cable Failure at Standby End	In a dual cable system, the RIO head gives no indication if only one cable has failed.
Runs as offline	READY and COM ACT on	COM ACT stops blinking	Failure of Fiber Link from Standby Transmit to Primary Receive	
Runs as offline	READY and COMERR on	COM ACT stops blinking	Failure of Fiber Link from Primary Transmit to Standby Receive	Refer to following description.

## Failure of Fiber Link from Primary Transmit to Standby Receiver

---

**Fiber Optic Cable** Replace the cable and restart the controller. The unit should return to Standby mode. If it does not, cycle the power on the Standby unit.

If the cable has been connected improperly (i.e., the transmit port of the Primary is linked to the transmit on the Standby), two error patterns are possible.

- If the program has already been loaded in the Standby controller and both controllers are running, then the Ready and Com Err indicators light on the Standby CHS 110 module.
- If the program has not yet been loaded in the Standby and you attempt to load it using the program update procedure, then the Ready indicator lights and the Standby blinks.

If both fiber links fail, the Com Err indicator lights on the Standby CHS 110. Again, replace the cable and restart the controller. The unit should return to Standby mode. If it does not, cycle the power on the Standby unit.

---

## 10.4 Replacement

---

### Introduction

---

**Purpose** This section describes replacing a Hot Standby module.

---

**What's in this Section?** This section contains the following topics:

Topic	Page
Replacing a Hot Standby Module	193
Changing the Program and Performing a Program Update	194
Updating PLC System Executives in a 984 HSBY System	198
Updating PLC System Executives in an IEC HSBY System	200

---



## Replacing a Hot Standby Module

### Hot Swap and the Hot Standby System

Hot swapping any key module in the Primary or Standby backplane forces that backplane offline. When the module is in the Primary backplane, this causes switchover.

Key modules include the controller, remote I/O head processor and the Hot Standby module.

Any time you hot swap a module, you must cycle power to the backplane to ensure proper system initialization. If you have hot swapped the controller, you must also perform a program update, using the proper procedure.

You may replace a CHS 110 module while the Hot Standby system is running, as long as the module is in the current Standby backplane and you follow the procedure below

	<b>CAUTION</b>
	<p><b>Primary Backplane Hazard</b></p> <p>Do not attempt to hot swap the CHS 110 module in the Primary backplane.</p> <p><b>Failure to follow this precaution can result in injury or equipment damage.</b></p>

Hot swapping any key module in the Primary or Standby backplane forces that backplane offline. When the module is in the Primary backplane, this causes switchover.

### Replacement Procedure

The following table shows the replacement procedure.

Step	Action
1	Power down the backplane.
2	Disconnect the fiber optic cable from the module and remove it from the backplane.
3	Install the new module and reconnect the fiber optic cable.
4	Restore power to the backplane.

## Changing the Program and Performing a Program Update

---

### Updating the Primary and Standby

The program includes the configuration table, I/O map, configuration extensions, segment scheduler, all .EXE loadables and the entire state RAM, including user logic.

**Note:** Program downloads:

- Change program means: a complete program change.
- Update program means: to update the user logic

If you reprogram your Primary controller or replace the Standby controller, you may use the update feature to copy the full program of the Primary controller to the Standby. This feature not only saves time, but also ensures that the controllers have identical user logic.

If program changes include any of the above, or replacing the Standby controller, the Standby must be in dim awareness before a keyswitch update can be performed

**Note:** A program update can only be performed from the Primary controller to the Standby. The Standby controller cannot update the Primary.

**Note:** To put the Standby into dim awareness, remove the battery for at least 5 minutes.

	<b>CAUTION</b>
	<b>Battery Hazard</b> Whenever installing a new controller, be sure its battery has been disconnected for at least five minutes. <b>Failure to follow this precaution can result in injury or equipment damage.</b>

---

	<b>CAUTION</b>
	<b>Program Change Hazard</b> To change the program, you must stop both controllers and take the Standby controller Off Line. <b>Failure to follow this precaution can result in injury or equipment damage.</b>

**Before You Begin:**

To download a new program to your Primary controller, you must stop the Standby controller as well.

The Standby CHS 110 module must be in Off Line mode. Make any changes to the program. Then follow the steps below to copy the new program to the Standby controller.

---

## Updating Standby Procedure

The following table demonstrates how to update the Standby procedure.

Step	Action
1	Put the Primary controller in Run mode. Be sure the Standby controller is still stopped and Off Line.
2	Push the update button on the Standby unit. Hold the button down.
3	Turn the key on the Standby CHS 110 module to Xfer. This prepares the Standby unit to receive the update

Updating Standby

The diagram illustrates the physical components of the CHS 110 module. Each unit features a rotary key with four positions: 'Off Line', 'Xfer', 'Run', and 'Stop'. On the left unit, the key is turned to 'Run', and the 'Off Line' indicator light is illuminated. On the right unit, the key is turned to 'Xfer', and the 'Off Line' indicator light is illuminated. Below the key is a small slide switch. A horizontal double-headed arrow labeled 'Update Button' points to a button located below the slide switch on both units. A text label with arrows pointing to the slide switches states: 'Slide switches must be set in opposite positions.'

Step	Action
4	<p>Turn the key to the mode you want the Standby unit to be in after the update, Run or Off Line.</p> <p><b>Result:</b> The amber Standby indicator begins to blink.</p>  <p style="text-align: center;">Updating Standby</p> <p>Slide switches must be set in opposite positions.</p> <p style="text-align: center;">Update Button</p>
5	<p>Release the update button.</p> <p><b>Result</b> The Primary controller begins copying its full program to the Standby. The Standby indicator on the Standby unit continues to blink as the module processes the update. When the update is completed, the CHS 110 Hot Standby module instructs the Standby controller to return to the mode you have set, Run or Off Line. If the Standby unit is in Run mode, the Standby and Com Act lights are lit. If the Standby unit is offline, neither indicator is lit. The Standby now has a program identical to the Primary unit.</p>
6	<p>Remove the key and store it in a secure place.</p>

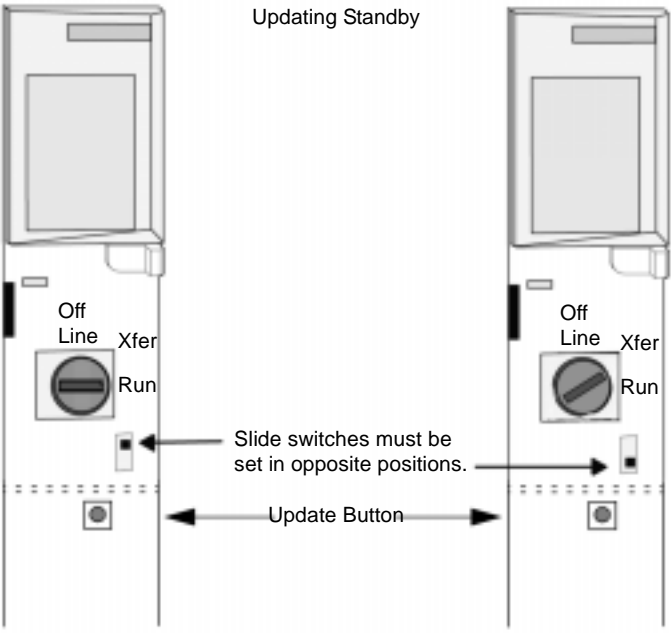
## Updating PLC System Executives in a 984 HSBY System

### Updating PLC System Executives

Bit 12 in the Hot Standby command register can be set to 1 to facilitate an executive upgrade while one of the controllers in the Hot Standby system continues to operate

	<b>CAUTION</b>
	<p><b>Overriding the Safety Checking Protection Hazard</b></p> <p>Setting bit 12 to 1 overrides the safety checking protections between the Primary and Standby controllers in your Hot Standby system. It is important to reset the bit to 0 as soon as the executive upgrade operation is complete.</p> <p><b>Failure to follow this precaution can result in injury or equipment damage.</b></p>

Even if it is possible to have this command register parameter be prepared for this operation, it is strongly recommended not to have it set by configuration extension and to set it only when needed. To do this, you can either use a Zoom screen on a CHS instruction block in ladder logic or call up the Hot Standby command register in the Reference Data Editor (RDE).

### Upgrading the PLC executives while Hot Standby system is running

If you want to access the command register via a Zoom screen, make sure that a CHS instruction has been inserted in ladder logic before the system is powered up. While the Hot Standby system is running, connect to the Primary controller with Concept. Go to the LL984 Editor and call up the Zoom screen when having the CHS instruction inserted.

**Steps to Upgrade  
PLC executives  
while Hot  
Standby is  
running**

Step	Action
1	Call up the Hot Standby command register, either in a Zoom screen or in the RDE. If you are using the Zoom screen, select the Without Stopping option for bit 12. If you are using the RDE, set the value of bit 12 in the Hot Standby command register to 1.
2	Disconnect from the PLC and start the Firmware Loader Utility.
3	Perform a firmware download to the standby controller.
4	Do a program update from the Primary to the Standby controller as described in <i>Using a Quantum 984 HSBY System, p. 67</i> or <i>Using a Quantum IEC Hot Standby System, p. 109</i> . At this point, you have a new system executive in the Standby controller with the correct ladder logic and state RAM values.
5	Initiate a Hot Standby switchover.
6	Perform a firmware download to the new Standby controller.
7	Refer to Concept V 2.2 User's Manual, 840 USE 483 00. Now both the Primary and the Standby controllers have the new system executive installed, and both are running the same logic program with the same state RAM values. If you initiate another switchover, the controller that was originally the Standby becomes the Standby again. <b>Note:</b> Some Exec upgrades may be because of new versions of Concept and in certain cases the project may have to be converted before downloading.
8	Reconnect to the Primary controller and reset bit 12 of the Hot Standby command register back to 0 via either the Zoom screen or the RDE.

## Updating PLC System Executives in an IEC HSBY System

### Updating PLC System Executives

In a Pre Concept 2.5 IEC Hot Standby System it's not possible to update the PLC system executives without shutting down the process. Instead you must follow the steps in the table below.

Concept 2.5 IEC Hot Standby System allows the upgrading of the controllers executives without shutting down the system. See Advanced Options, Section B122.

	<b>CAUTION</b>
	<p><b>Executing the Steps Hazard</b></p> <p>Following the procedural steps in order is critical for the safety and reliability of your Hot Standby system.</p> <p><b>Failure to follow this precaution can result in injury or equipment damage.</b></p>

### Quantum IEC Hot Standby Controller Exec Upgrade Procedure

The following table shows the steps in a Quantum IEC Hot Standby Controller Exec Upgrade Procedure.

Step	Action
1	Stop the process being controlled.
2	Stop both controllers.
3	Load the new Execs in both controllers.
4	Download the project to the primary controller. <b>Note:</b> Some Exec upgrades may be because of new versions of Concept and in certain cases the project may have to be converted before downloading. <b>Note:</b> The Primary controller must be started.
5	Load the project into the Standby Controller via the fiber optic CHS link in Transfer mode.
6	Start the Standby Controller. <b>Note:</b> You can do this by using the CHS fiber optic update procedure, without using Concept. <b>Result:</b> The IEC Hot Standby System will now come up and run in Normal Recommended Operation.



---

## 10.5 Testing

---

### Forcing a Switchover

---

#### Testing a Hot Standby Switchover

To test your Hot Standby system, you may force a switchover manually or through software.



**Note:** In systems with scan times of 200 ms or greater and more than 15 RIO drops, it is recommended that the drop holdup time be increased to 1.5 seconds to ensure that communication with remote drops is maintained during switchover.

---

#### Forcing a Switchover Manually

Take the following steps to force a switchover manually.

Step	Action
1	Be sure that the Standby controller has been fully programmed.
2	Place the function keyswitch on the CHS 110 Hot Standby module in the Run position.
3	Observe that the Standby indicator on the CHS 110 module is steady amber.
4	Be sure that the designation slide switch on one Hot Standby module is in position A and that the switch on the other Hot Standby module is in position B.

Step	Action
5	<p>Confirm that the keyswitch on both Hot Standby modules has not been overridden by software.</p> <p><b>After Taking the Primary Controller Offline</b></p> <div style="display: flex; justify-content: space-around;"> <div style="text-align: center;"> <p>Primary</p>  </div> <div style="text-align: center;"> <p>Standby</p>  </div> </div>
6	<p>Turn the key on the Primary Hot Standby module to Off Line.</p> <p><b>Result:</b> Standby should now be functioning as the Primary controller.</p>
7	<p>Check to see that all LED indicators are normal and all application devices are functioning properly. The Standby indicator should be extinguished and the Primary indicator should be a steady green.</p>

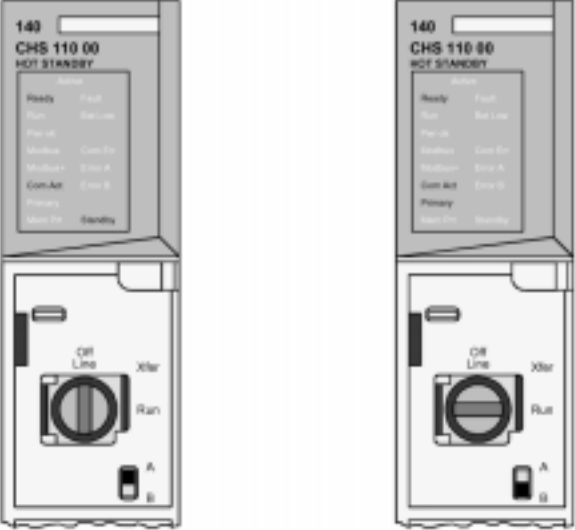
Step	Action
8	<p>Return the key on the original Primary unit to the Run position. The Standby indicator should come on.</p> <p><b>Bringing the Original Primary Unit Back Online</b></p>  <p>The image contains two side-by-side diagrams of a control panel for a CHS 110 00 unit. Each diagram shows a control panel with a digital display at the top and a large rotary selector knob below it. The display shows '140' and 'CHS 110 00' with 'HOT STANDBY' below it. Below the display is a grid of indicator lights labeled 'Ready', 'Fault', 'Run', 'Off Line', 'Pre-Op', 'Standby', 'Com-Act', 'Primary', and 'Standby'. Below the knob is a label 'Off Line' and 'Run'. Below the knob is a small indicator light labeled 'A' and 'B'. The left diagram shows the knob in the 'Off Line' position and the 'Standby' indicator lit. The right diagram shows the knob in the 'Run' position and the 'Standby' indicator lit.</p>

### Forcing a Switchover Through Software

You can force a switchover using the RDE or, if you have programmed a CHS instruction in ladder logic, a Zoom screen. The instructions are the same; however, in the RDE you are working with the command and status registers, while in the Zoom screen you are working with the command and status pages.

Step	Action
1	Addressing the Primary controller: Check the status register or page to be sure one unit is designated A and the other is B. Be sure that both the Primary and the Standby controllers are in run mode and that the function keyswitch override has been enabled.
2	In the command register or on the command page, take the Primary controller offline.
3	<p>If you are operating on a Modbus Plus network, the programming panel is automatically communicating with the Primary controller. If you are operating via the Modbus or Modbus Port directly connected to the original primary controller, you must reconnect the programming cable to the new Primary controller and then log in again, due to the port address swap.</p> <p>Result: The status should now show that the original Primary controller is offline and that the Standby is now functioning as the Primary unit. Refer to <i>Command Register, p. 76</i>.</p>
4	Check the LED displays on the Hot Standby modules to confirm that the switchover has taken place. The Primary indicator on the original Primary unit should be extinguished, while the Primary indicator on the original Standby unit should be a steady green.
5	In the command register or on the command page, return the original Primary unit to RUN mode. The status register or page and the LED display on the front panel of the Hot Standby module should now show that unit in Standby mode.

---

# Specifications for CHS 110 Hot Standby

11

---

## Specifications

### Specifications for CHS 110 Hot Standby

<b>Electrical</b>	
Electrostatic Discharge (IEC 801-2)	8 kV air/ 4 kV contact
RFI Immunity (IEC 801-3)	27 - 1000 MHz, 10 V/m
Bus Current Required (Typical)	700 mA
<b>Operating Conditions</b>	
Temperature	0 to 60° C
Humidity	0 to 95% Rh noncondensing @ 60C
Altitude	15,000 ft. (4500 m)
Vibration	10 - 57 Hz @ 0.075 mm d.a. 57 - 150 Hz @ 1 g
<b>Storage Conditions</b>	
Temperature	-40 to +85° C
Humidity	0 to 95% Rh noncondensing @ 60° C
Free Fall	1 m unpackaged
Shock	3 shocks/axis, 15 g, 11 ms
<b>Agency Approvals</b>	
Electrical	UL 508 CE CSA 22.2-142 FM Class I Div 2 pending



---

# Appendices



---

## Appendices for Quantum Hot Standby Planning and Installation Guide

### At a Glance

The appendices for the Quantum Hot Standby Planning and Installation Guide are included here.

### What's in this Appendix?

The appendix contains the following chapters:

Chapter	Chapter Name	Page
A	Com Act Error Patterns	209
B	Fiber Optic Cable Guide	213
C	ProWORX Nxt Configuration	217





---

# Com Act Error Patterns



---

## At a Glance

### Purpose

This Appendix describes error patterns for the HSBY.

### What's in this Chapter?

This chapter contains the following topics:

Topic	Page
CHS 110 Hot Standby Module Error Patterns	210
CRP Remote I/O Head Processor Error Patterns	211

## CHS 110 Hot Standby Module Error Patterns

---

### CHS 110 Error Patterns

The following table shows the number of times the Com Act indicator blinks for each type of error and the codes possible for that group (all codes are in hex).

Number Blinks	Code	Error
1	6900	error in additional transfer calculation
2	6801	ICB frame pattern error
2	6802	head control block error
2	6803	bad diagnostic request
2	6804	greater than 128 MSL user loadables
4	6604	powerdown interrupt error
4	6605	UART initialization error
5	6503	RAM address test error
6	6402	RAM data test error
7	6301	PROM checksum error
8	C101	no hook timeout
8	C102	read state RAM timeout
8	C103	write state RAM timeout
8	C200	powerup error

---

## CRP Remote I/O Head Processor Error Patterns

### Error Patterns

The following table shows error patterns.

Number Blinks	Code	Error
Slow (steady)	0000	requested kernel mode
2	6820	hcb frame pattern error
2	6822	head control block diag error
2	6823	mod personality diag error
2	682A	fatal start IO error
2	682B	bad read IO pers request
2	682C	bad execute diag request
2	6840	ASCII input xfer state
2	6841	ASCII output xfer state
2	6842	IO input comm state
2	6843	IO output comm state
2	6844	ASCII abort comm state
2	6845	ASCII pause comm state
2	6846	ASCII input comm state
2	6847	ASCII output comm state
2	6849	building 10 byte packet
2	684A	building 12 byte packet
2	684B	building 16 byte packet
2	684C	illegal IO drop number
3	6729	984 interface bus ack stuck high
4	6616	coax cable initialization error
4	6617	coax cable dma xfer error
4	6619	coax cable dumped data error
4	681A	coax cable DRQ line hung
4	681C	coax cable DRQ hung
5	6503	RAM address test error
6	6402	RAM data test error
7	6300	PROM checksum error (exec not loaded)
7	6301	PROM checksum error
8	8001	kernel PROM checksum error

<b>Number Blinks</b>	<b>Code</b>	<b>Error</b>
8	8002	flash prog / erase error
8	8003	unexpected executive return

---

---

# Fiber Optic Cable Guide



# B

---

## At a Glance

### Purpose

This Appendix describes specifications for the fiber optic cable.

### What's in this Chapter?

This chapter contains the following topics:

Topic	Page
Fiber Optic Cable	214
Other Tools	216

---

## Fiber Optic Cable

---

### Recommendations

Schneider Electric recommends the use of up to 1 km of 62.5/125 graded index, duplex, multimode glass fiber for all applications. Most 62.5/125 cables are rated at 3.5dB loss per km.

We recommend using a 3 mm diameter cable for your hot Standby system, because the fiber cable clasps used to maneuver the cable into the ports are designed to be used with 3 mm cable.

The following cable meets these recommendations.

Vendor	Part Number	Description
AMP	502086-1	Black
AMP	502908-1	Beige

### Connectors

You need four ST bayonet-style connectors per cable. Suggested connectors include:

Vendor	Part Number	Description
AMP	503571-1	Epoxy, -20 to +75C
AMP	503415-1	Epoxy, -20 to +75C
AMP	501380	Epoxy, -30 to +705C
3M	6105	Epoxy, -40 to +805C
3M	6100	Hot Melt, -40 to +605C

### Termination Kits

Suggested kits include:

Vendor	Part Number	Description
AMP	501258-7	Epoxy, 110 Vac, only for AMP connectors
AMP	501258-8	Epoxy, 220 Vac, only for AMP connectors
3M	8154	Epoxy, 110 or 220 Vac, only for 3M connectors
3M	6150	Hot Melt, 110 or 220 Vac, only for 3M connectors

---

**Other Tools**

Suggested Tools include:

Vendor	Part Number	Description
3M (photodyne)	9XT	Optical Source Driver (hand-held, requires light source)
3M (Photodyne)	1700-0850-T	Optical Light Source (850 nm, ST connectors, for 9XT)
3M	17XTA-2041	Power Meter (hand-held)
3M	7XE-0660-J	Optical Light Source (660 nm, visible, for 9XT: use to troubleshoot raw fiber, requires FC/ST patch cord)
3M	BANAV-FS-0001	FC/ST Patch Cord (connects FC connector on 7XE to ST)
3M	8194	Bare Fiber Adapter, ST compatible (permits use of above source and meter to test raw fiber; two required)

## Other Tools

---

### Other Tools

Suggested tools include

Vendor	Part Number	Description
3M (Photody ne)	9XT	Optical Source Driver (hand-held, requires light source)
3M (Photody ne)	1700-0850-T	Optical Light Source (850 nm, ST connectors, for 9XT)
3M Photodyn e	17XTA-2041	Power Meter (hand-held)
3M	7XE-0660-J	Optical Light Source (660 nm, visible, for 9XT: use to troubleshoot raw fiber, requires FC/ST patch cord)
3M	BANAV-FS-0001	FC/ST Patch Cord (connects FC connector on 7XE to ST)
3M	8194	Bare Fiber Adapter, ST compatible (permits use of above source and meter to test raw fiber; two required)

---



---

## ProWORX Nxt Configuration

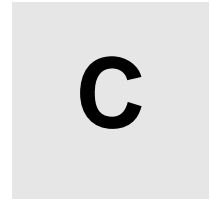

---

### ProWORX Nxt Hot Standby Configuration Extension

#### Description

Use the Hot Standby Configuration Extension dialog to specify Hot Standby configuration parameters for a Quantum Hot Standby System. It allows the type of state ram to be transferred between primary and standby PLC, the non-transfer area (Ver. 2.xx Quantum PLCs with CHS loadable) and the command register. It is activated from the Network Editor. Select Config Extension on the Configuration menu and select HSBY Extension from the Tree Control.

---

**Configuration Extensions Dialog Screen**

Go to the ProWORX Configuration Extensions Dialog Screen. In the left window pane, highlight <config extensions> <Hot Standby (Quantum)>

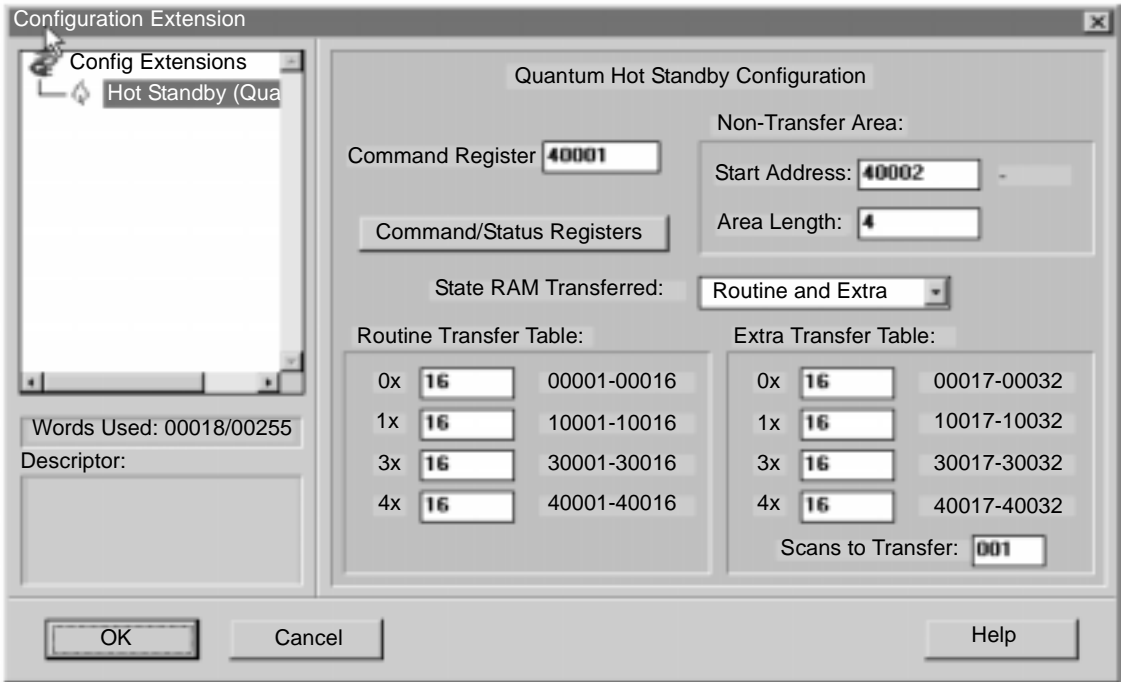

**Field and functions**

The following table describes the functions of the fields of the <config extensions> <Hot Standby (Quantum)> dialog screen

Field	Function
Command Register	Use to specify the 4x register that will be used as the command register. Use this register to control various parameters of the Hot Standby system
Non-Transfer Area; Start Address	Use to specify first 4x register of a group of registers that will not be transferred from primary to standby PLC.
Non-Transfer Area; length	Use with the start address to specify the number of 4x registers that will not be transferred
State RAM Transferred	Use to select State Ram transfer options: <ul style="list-style-type: none"> <li>● All State Ram: all configured state ram transferred</li> <li>● Routine only: all state ram defined in routine transfer table</li> <li>● Default (12K): <ul style="list-style-type: none"> <li>● All 0x and 1X discretes up to 8192 each transferred</li> <li>● All 3x and 4x registers configured transferred if combined they total less than 10000</li> <li>● 1000 3x and all 4x registers (up to combined total of 1000) transferred, if configured combined total of 3x and 4x registers is greater than 1000</li> </ul> </li> <li>● Routine and Extra: all state ram defined in routine transfer table and extra transfer table</li> </ul>
Routine Transfer Table	Use to define the state ram (0x,1x,3x,4x) to be transferred every scan. Each input must be a multiple of 16 and 4x requires minimum of 16.
Extra Transfer Table	<ul style="list-style-type: none"> <li>● Use to define the state ram (0x,1x,3x,4x) to be transferred in multiple scans. Each input must be a multiple of 16.</li> <li>● Scans to Transfer: Used to specify the number of scans in which to transfer the extra state ram</li> </ul>

**Description**

The Command/Status Registers dialog is used to control or monitor various parameters of a Quantum Hot Standby system.

**Command/  
Status Registers  
dialog screen**

Go to the ProWORX Command/Status Registers Dialog Screen.

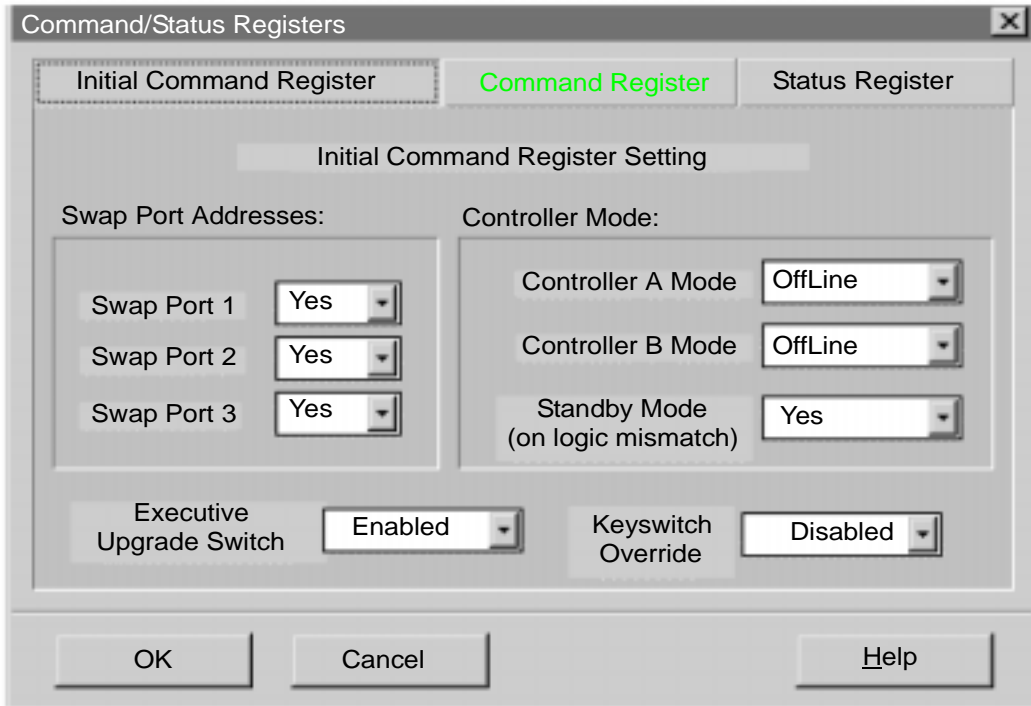

**Field and functions**

The following table describes the functions of the fields of the Command/Status Registers dialog screen:

Field	Function
Swap Port 1	Use to specify if Modbus Port 1 address on primary PLC will change to the standby PLC Modbus Port 1 address when a switchover from primary to standby occurs. The 2 options for this field are: <ul style="list-style-type: none"> <li>● Yes - address changes on switchover</li> <li>● No - address does not change on switchover</li> </ul>
Swap Port 2	Use to specify if Modbus Port 2 address on primary PLC will change to the standby PLC Modbus Port 2 address when a switchover from primary to standby occurs. The 2 options for this field are: <ul style="list-style-type: none"> <li>● Yes - address changes on switchover</li> <li>● No - address does not change on switchover</li> </ul>
Swap Port 3	Use to specify if Modbus Port 3 address on primary PLC will change to the standby PLC Modbus Port 3 address when a switchover from primary to standby occurs. The 2 options for this field are: <ul style="list-style-type: none"> <li>● Yes - address changes on switchover</li> <li>● No - address does not change on switchover</li> </ul>
Controller A Mode	Use to specify the operating mode for the PLC at startup when the keyswitch override is enabled. There are 2 options for this field: <ul style="list-style-type: none"> <li>● Offline</li> <li>● Run</li> </ul>
Controller B Mode	Use to specify the operating mode for the PLC at startup when the keyswitch override is enabled. There are 2 options for this field: <ul style="list-style-type: none"> <li>● Offline</li> <li>● Run</li> </ul>
Standby Mode (on logic mismatch)	Use to specify Standby PLC's state if a mismatch is detected between its logic program and the Primary PLCs logic program. The 2 state options are: <ul style="list-style-type: none"> <li>● Yes – Online Standby with logic mismatch</li> <li>● No – Offline with logic mismatch</li> </ul>

<b>Field</b>	<b>Function</b>
Executive Upgrade Switch	Use to specify if the PLC has to be stopped to download new executive to PLC. The 2 options are: <ul style="list-style-type: none"><li>● Yes – PLC has to be stopped</li><li>● No – PLC does not have to be stopped</li></ul>
Keyswitch Override	Use to specify if the keyswitch on CHS 110 modules is disabled (command register controls online/offline state of PLCs). The 2 options are: <ul style="list-style-type: none"><li>● Disabled – keyswitch controls online/offline state</li><li>● Enabled – control register controls online/offline state</li></ul>

---

---

# Index

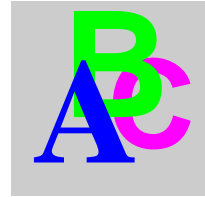

---

## Numerics

984 HSBY, 27, 67

## A

advanced options, 96

## C

cable

- diagrams, 59
- distances, 56
- topologies, 58

CHS 110 Hot Standby module, 16, 28, 32, 46  
startup, 104

CHS 210 Hot Standby kit, 25

CHS instruction, 70

coaxial cable

- diagrams, 58
- permissible lengths, 56

coaxial splitters

- required in RIO network, 58

Com Act

- indicator, 139
- LED, 105

command register

- diagram, 118
- must not be in nontransfer area, 77

complex data structures, 162

configuration extension

- controlling the Hot Standby system, 72
- dialog screen, 218
- using configuration extension screens, 115
- using to control Hot Standby system, 114

connectors, 214

CRP Remote I/O, 211

## D

DFB instance

- data, 44
- reducing, 161

## E

elementary function block, 145

error patterns, 210

Exec, 44

## F

fiber optic cable

- connecting, 24
- permissible lengths, 56

fiber optic repeaters

- for extending coaxial cable in RIO network, 56

**H**

health message, 180  
Hot Standby  
    Theory of Operation, 164  
Hot Standby kit, 24  
Hot Standby status register, 78, 132  
Hot Standby system  
    cable diagrams, 58  
    distance between modules, 56  
    installation, 61  
    normal operation, 108  
    planning guidelines, 56  
    startup, 104  
    timing, 173  
    topology, 166  
hot swapping, 193  
HSBY, 13

**I**

IEC heap, 44, 128  
IEC HSBY, 28  
IEC logic, 114  
IP address, 128

**K**

keyswitch, 20  
    override, 119

**L**

ladder logic, 72  
    application program, 32  
LED display  
    during normal operation, 105  
    recognizing errors, 181  
logic scan, 32, 46

**M**

MAC address, 128  
maximum IEC heap size, 44

**N**

nontransfer area of state RAM  
    command register must not be placed in  
    the nontransfer area, 76  
    placing registers, 128

**O**

off line mode, 21

**P**

primary controller, 16, 28  
program data, 44  
program update, 194, 200

**R**

reduce scan time, 36  
redundant power supply, 181  
reference data editor, 121  
remote I/O network  
    cable requirements, 56  
    diagrams, 58  
    hardware required, 58  
reverse transfer registers, 82  
run mode, 22  
run time confidence tests, 180

**S**

scan time, 142  
self-terminating F adapters  
    required in RIO network, 58  
slide switch, 20  
standby controller, 16, 28  
    failure, 108  
Standby LED, 105  
startup error, 184  
state RAM, 30  
    IEC HSBY, 46  
    stages of transfer, 32  
state RAM transfer  
    automatic, 108



- state RAM transfer area
  - defined, 76
- status register, 94
- switchover
  - automatic, 108
  - swapping addresses, 93
- system scan time, 33, 47

## T

- time-of-day clocks
  - synchronizing, 106
- timing
  - diagram, 33
- transfer
  - buffer, 53
- transfer mode, 21
- transfer process, 32
- troubleshooting, 184
- trunk terminator
  - required in RIO network, 58



## Free Manuals Download Website

<http://myh66.com>

<http://usermanuals.us>

<http://www.somanuals.com>

<http://www.4manuals.cc>

<http://www.manual-lib.com>

<http://www.404manual.com>

<http://www.luxmanual.com>

<http://aubethermostatmanual.com>

Golf course search by state

<http://golfingnear.com>

Email search by domain

<http://emailbydomain.com>

Auto manuals search

<http://auto.somanuals.com>

TV manuals search

<http://tv.somanuals.com>