

# Zelio Logic 2 Smart Relay User Manual

SR2MAN01

11/2007

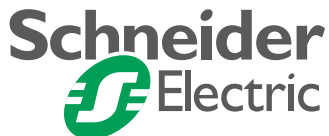

---

# Table of Contents

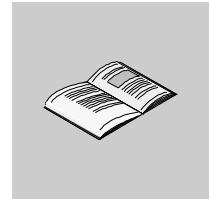

---

	<b>Safety Information</b> .....	<b>7</b>
	<b>About the Book</b> .....	<b>9</b>
	<b>Part I Initial Power up and Discovering</b> .....	<b>11</b>
<b>Chapter 1</b>	<b>Initial Power up and Discovering</b> .....	<b>13</b>
	Safety .....	14
	Presentation of the Smart Relay Front Panel .....	17
	Characteristics and Connections .....	19
	Control Keys on the Front Panel of the Smart Relay .....	20
	Examples .....	23
	<b>Part II Functions Accessible from the Front Panel</b> .....	<b>29</b>
<b>Chapter 2</b>	<b>Overview of the Functions Accessible from the Front Panel</b> . . .	<b>31</b>
	Functions Accessible from the Front Panel of the Smart Relay .....	31
<b>Chapter 3</b>	<b>Input/Output Screen</b> .....	<b>33</b>
	Inputs-Outputs Screen .....	34
	TEXT and DISPLAY screen .....	36
<b>Chapter 4</b>	<b>PROGRAMMING Menu</b> .....	<b>39</b>
	Rules for Entering Ladder Diagrams .....	41
	Method for Entering a Contact or Coil .....	43
	Entering a Link .....	45
	Entry of Function Block Parameters .....	47
	Deletion and Insertion of Diagram Lines .....	49
<b>Chapter 5</b>	<b>PARAMETERS Menu</b> .....	<b>51</b>
	PARAMETERS Menu .....	51
<b>Chapter 6</b>	<b>MONITORING Menu</b> .....	<b>53</b>
	MONITORING Menu .....	53
<b>Chapter 7</b>	<b>RUN/STOP Menu</b> .....	<b>55</b>
	RUN/STOP Menu .....	55

---

---

<b>Chapter 8</b>	<b>CONFIGURATION Menu</b> .....	<b>57</b>
	PASSWORD Menu .....	58
	FILTER Menu .....	61
	Zx KEYS Menu .....	62
	WATCHDOG CYCLE Menu .....	63
<b>Chapter 9</b>	<b>CLEAR PROGRAM Menu</b> .....	<b>65</b>
	CLEAR PROG Menu .....	65
<b>Chapter 10</b>	<b>TRANSFER Menu</b> .....	<b>67</b>
	TRANSFER Menu .....	67
<b>Chapter 11</b>	<b>VERSION Menu</b> .....	<b>73</b>
	VERSION Menu .....	73
<b>Chapter 12</b>	<b>LANGUAGE Menu</b> .....	<b>75</b>
	LANGUAGE Menu .....	75
<b>Chapter 13</b>	<b>DEFAULT Menu</b> .....	<b>77</b>
	FAULT Menu .....	77
<b>Chapter 14</b>	<b>CHANGE DATE/TIME Menu</b> .....	<b>81</b>
	CHANGE DATE/TIME Menu .....	81
<b>Chapter 15</b>	<b>CHANGE SUMMER/WINTER Menu</b> .....	<b>83</b>
	CHANGE SUMMER/WINTER Menu .....	83
<b>Part III</b>	<b>LD Language</b> .....	<b>85</b>
<b>Chapter 16</b>	<b>LD Language Elements</b> .....	<b>87</b>
	Introduction .....	88
	Discrete Inputs .....	89
	Zx Keys .....	91
	Auxiliary Relays .....	93
	Discrete (DISCR) Outputs .....	98
	Timers .....	101
	Counters .....	111
	Fast Counter .....	118
	Counter Comparators .....	128
	Analog Comparators .....	129
	Clocks .....	134
	Texts .....	138
	LCD Screen Backlighting .....	140
	Change to Summer / Winter Time .....	141
	Modbus Inputs/Outputs .....	143
	Message .....	144

---

---

<b>Part IV</b>	<b>Creating and Debugging an Application</b> . . . . .	<b>147</b>
	Presentation . . . . .	147
<b>Chapter 17</b>	<b>Implementing a Basic Application</b> . . . . .	<b>149</b>
	Presentation of Ladder Diagrams . . . . .	150
	Using the Reverse Function . . . . .	152
	Notation Used by the Smart Relay . . . . .	155
	Application: Implementing a Two-way Switch . . . . .	157
<b>Chapter 18</b>	<b>Debugging an Application</b> . . . . .	<b>165</b>
	Introduction . . . . .	166
	Dynamic Mode Ladder Diagrams . . . . .	168
	Dynamic Mode Function Block Parameters . . . . .	170
	Dynamic Mode Menus . . . . .	171
	Smart Relay Reaction to a Power Failure . . . . .	172
<b>Chapter 19</b>	<b>Backup and Transfer of Ladder Diagrams"</b> . . . . .	<b>175</b>
	Saving and Transferring Ladder Diagrams . . . . .	175
<b>Chapter 20</b>	<b>Sample Application</b> . . . . .	<b>177</b>
	Specifications . . . . .	178
	Specification Analysis . . . . .	179
	Implementing the Solution . . . . .	181
<b>Part V</b>	<b>Diagnostics</b> . . . . .	<b>185</b>
<b>Chapter 21</b>	<b>Diagnostics</b> . . . . .	<b>187</b>
	Smart Relay Messages . . . . .	188
	Frequently Asked Questions . . . . .	189
<b>Appendices</b>	. . . . .	<b>191</b>
<b>Appendix A</b>	<b>Compatibility</b> . . . . .	<b>193</b>
	Compatibility between the version of the programming software and the version of the firmware on the smart relay . . . . .	194
	Compatibility between the memory cartridges and the version of the firmware on the smart relay . . . . .	195
<b>Index</b>	. . . . .	<b>197</b>

---

# Safety Information

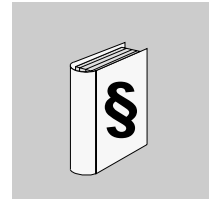

---

## Important Information

### NOTICE

Read these instructions carefully, and look at the equipment to become familiar with the device before trying to install, operate, or maintain it. The following special messages may appear throughout this documentation or on the equipment to warn of potential hazards or to call attention to information that clarifies or simplifies a procedure.



The addition of this symbol to a Danger or Warning safety label indicates that an electrical hazard exists, which will result in personal injury if the instructions are not followed.



This is the safety alert symbol. It is used to alert you to potential personal injury hazards. Obey all safety messages that follow this symbol to avoid possible injury or death.

### **DANGER**

DANGER indicates an imminently hazardous situation, which, if not avoided, **will result** in death or serious injury.

### **WARNING**

WARNING indicates a potentially hazardous situation, which, if not avoided, **can result** in death, serious injury, or equipment damage.

### **CAUTION**

CAUTION indicates a potentially hazardous situation, which, if not avoided, **can result** in injury or equipment damage.

---

**PLEASE NOTE**

Electrical equipment should be installed, operated, serviced, and maintained only by qualified personnel. No responsibility is assumed by Schneider Electric for any consequences arising out of the use of this material.

© 2007 Schneider Electric. All Rights Reserved.

---

---

# About the Book

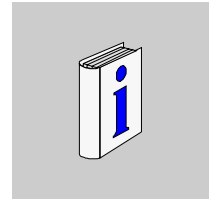

---

## At a Glance

**Document Scope** This manual describes the use of functions accessible from the front panel of the smart relay.

This document is divided into 5 parts and addresses the following topics:

- Part I: Powering up and Discovering the Smart Relay
  - General presentation of the smart relay
- Part II: Functions Accessible from the Front Panel
  - Description of the interface and the menus of the smart relay
- Part III: LD Language
  - Description of automation functions available for programming in LADDER
- Part IV: Creating, Debugging and Saving an Application
  - Example of programming
  - Presentation of tools for debugging and saving an application
- Part V: Diagnostics
  - Help for finding solutions to operating problems

---

**Validity Note** The information in this manual applies only to smart relays of the **Zelio 2** series.

---

**User Comments** We welcome your comments about this document. You can reach us by e-mail at [techpub@schneider-electric.com](mailto:techpub@schneider-electric.com)

---

---

# Initial Power up and Discovering



---

## Presentation

### Subject of this Section

This section presents the operation and main characteristics of the smart relay.

### What's in this Part?

This part contains the following chapters:

Chapter	Chapter Name	Page
1	Initial Power up and Discovering	13



---

# Initial Power up and Discovering

# 1

---

## Presentation

### Subject of this Chapter

This chapter presents the operation and main characteristics of the smart relay.

### What's in this Chapter?

This chapter contains the following topics:

Topic	Page
Safety	14
Presentation of the Smart Relay Front Panel	17
Characteristics and Connections	19
Control Keys on the Front Panel of the Smart Relay	20
Examples	23

---

## Safety

---

### Preliminary Advice

Preliminary advice and general safety precautions relating to installing smart relays:

- Remember that only qualified personnel are authorized to implement the smart relay.
- Read this instruction sheet and the User Guide to learn the procedures prior to installing, wiring, operating, maintaining of controlling the smart relay.
- The end user should keep this User Guide and the product instructions sheet.
- Install the smart relay by following the instructions in the instruction bulletin and the User Guide. Improper installation may result in failure or malfunction of the smart relay.
- Make the necessary ground and short circuit the connections.
- Check the operating conditions, as described in the User Guide. If you are unsure of the technical characteristics, contact Schneider Electric.
- Fluctuations or variations in the power supply voltage should not exceed the tolerance thresholds stated in the technical characteristics, as they may lead to operating failures and potentially dangerous situations.
- Take any steps necessary to ensure that an application interrupted by a power failure continues to operate correctly after restoring power and make sure also that no dangerous situation whatsoever arises.
- Take any steps necessary to prevent involuntary activation of the relay.
- Automation and control devices must be installed in areas where they are protected against any risk of involuntary activation.
- Ensure that all connections to the control system meet applicable safety standards.
- Ensure that you comply with all applicable standards for emergency stop systems in order to avoid potentially dangerous situations. Ensure that releasing the emergency stop system does not cause the automated system to suddenly restart.
- Install the smart relay only in environments described in the User Guide. Do not use the smart relay in environments subject to excessive temperatures, elevated relative humidity, condensation, corrosive gases, or excessive shocks.
- The smart relay should be used in "Pollution level 2" environments. This level defines the effect of pollution on the insulation.
- Definition of level 2 Pollution: Only non-conductive pollution arises, except for occasional temporary conductivity caused by condensation. Do not use smart relays in environments lower than those specified in IEC Standard 60664-1.
- Use appropriate wires according to current and voltage requirements. Tighten the screws of the terminal according to the specified torque.
- Use an IEC 60127 approved fuse, in conformity with the requirements for current and voltage, to protect the power line and output circuits. This is not required when a device including a smart relay is intended for Europe.
- Use an EU-approved switch. This is not required when a device including a smart relay is intended for Europe.

 **DANGER****RISK OF ELECTRIC SHOCK, EXPLOSION OR ELECTRIC ARCING**

Power off the smart relay prior to installing, removing, wiring, maintaining or inspecting a smart relay system.

**Failure to follow this instruction will result in death or serious injury.**

 **WARNING****RISK OF EXPLOSION**

Precautions:

- Compliant with standard CSA C22.2 No 213: This equipment is designed for use in Class 1, Division 2, Groups A, B, C, D or in non-dangerous locations only. Replacement of components may compromise the suitability to this specified environment.
- Ensure that the power voltage and its tolerances are compatible with those of the smart relay.
- Do not disconnect the equipment as long as the power supply has not been cut off or the zone is not safe.
- This product contains a battery. Do not place the smart relay in fire.

**Failure to follow this instruction can result in death, serious injury, or equipment damage.**

 **WARNING****RISK OF ELECTRIC SHOCK OR FIRE**

Precautions:

- The smart relay is solely intended for installation in an enclosure. Do not install the smart relay outside of an enclosure.
- Ensure that no metal fragment or wiring material falls into the enclosure of the smart relay. Foreign bodies may lead to fire, material damage or malfunction.

**Failure to follow this instruction can result in death, serious injury, or equipment damage.**

## **WARNING**

### **INVOLUNTARY OPERATION OF EQUIPMENT**

Precautions:

- Power off the smart relay prior to installation, deinstallation, wiring, maintenance or operation of the unit.
- The emergency stop and the locking circuits should be configured in the software program of the smart relay.
- In the event of failure of the relays or transistors in the output modules of the smart relay, the outputs should remain activated or deactivated. For output signals that might lead to serious accidents, install a control circuit external to the smart relay.
- Install the modules according to the environmental operation conditions specified in the instruction bulletin.
- Do not attempt to dismantle, repair or modify the smart modules.
- Use an IEC 60127 approved fuse, in conformity with the requirements for current and voltage, to protect the power line and output circuits.

**Failure to follow this instruction can result in death, serious injury, or equipment damage.**

## **WARNING**

### **RISK OF UNEXPECTED OPERATION**

Special case of the use of the SR2COM01 modem communication extension. Sending commands may lead to modification of the status of smart relay outputs or accidental enabling of controlled equipment.

It is important to:

- Know how the commands will affect the process or the controlled equipment,
- Take any preventive measures necessary to ensure safety when making modifications.

**Failure to follow this instruction can result in death, serious injury, or equipment damage.**

## Presentation of the Smart Relay Front Panel

### Introduction

Smart relays are designed to simplify the electrical wiring of intelligent solutions. A smart relay is very simple to implement. Its flexibility and its high performance allow users to save significant amounts of time and money.

This User's Guide is intended for people who do not have an in-depth knowledge of automation systems and who would like to be able to implement smart relays.

### Description of the Smart Relay Front Panel

The illustration below presents the elements of the front panel of the smart relay:

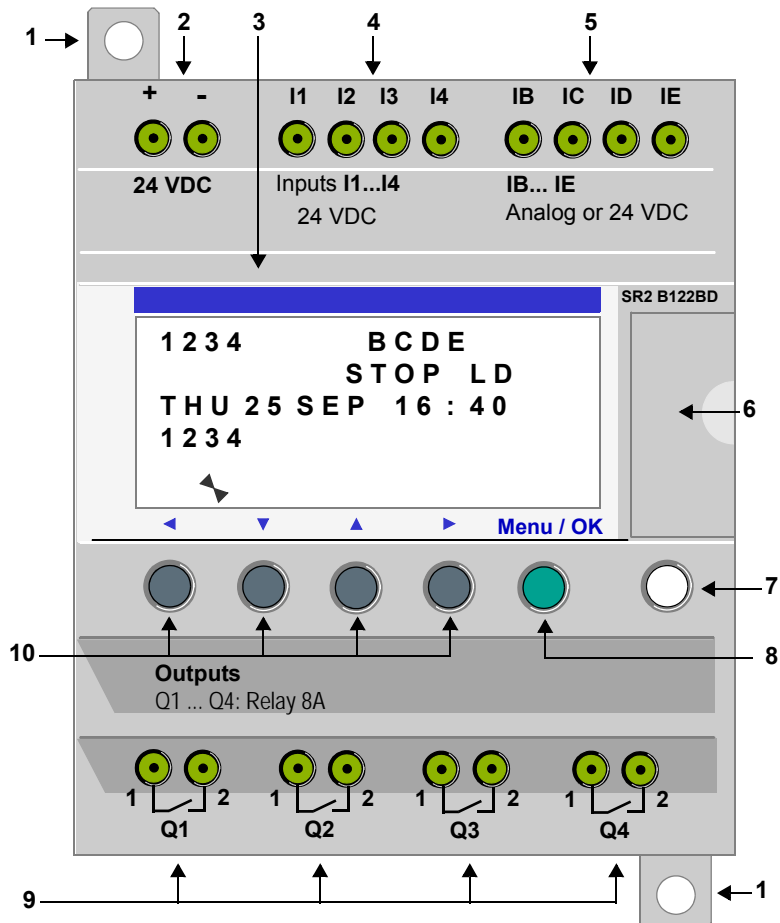

Prompt	Element
1	Retractable mounting feet.
2	Screw terminal block for the power supply.
3	LCD display, 4 lines, 18 characters.
4	Screw terminal block for discrete inputs.
5	Screw terminal block for analog inputs. 0-10 Volts, usable in discrete input mode depending on model.
6	Slot for backup memory or PC connection cable.
7	<b>Shift</b> key (white).
8	<b>Menu/OK</b> key (green) for selection and confirmation.
9	Relay output screw terminal block.
10	Navigation keys (gray) or after configuring Z pushbuttons.

**Description of the LCD**

The illustration below presents an example of LCD display elements when displaying the INPUT-OUTPUT screen:

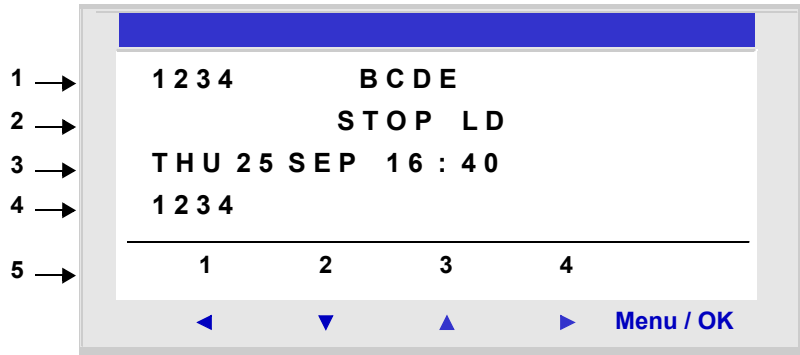

Prompt	Element
1	Input status* display (B...E represent the analog inputs, also may be used as DISCR).
2	Display of the operating mode (RUN/STOP) and programming mode (LD/FBD).
3	Display of the date (day and time for products with clock).
4	Output status display.
5	Contextual menus / pushbuttons / icons indicating the operating modes.

\* An ACTIVE input or output is displayed in reverse video.

## Characteristics and Connections

### Introduction

Here is detailed information on the characteristics of DC smart relay connections.

### Recommended connection

It is recommended to connect the smart relay to a regulated DC power supply:



### Possible Connection

It is possible to connect the smart relay to a rectified filtered regulated power supply:



Provided that it verify the following characteristics, according to the type of smart relay:

SR2 ... BD	SR2 ... JD
U max < 30 V	U max < 14,4 V
U min > 19.2 V	U min > 10.4 V

### Prohibited Connection

It is **prohibited** to connect the smart relay to a rectified non-filtered power supply:



## Control Keys on the Front Panel of the Smart Relay

---

### Description

The keys located on the front panel of the smart relay are used to configure, program and control the application and monitor the application's progress.

Illustration:

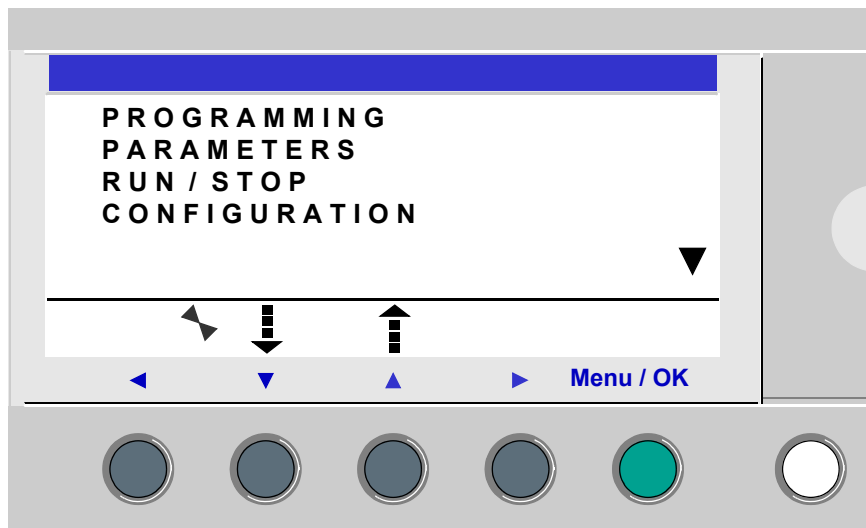

**Note:** The LCD screen is lit for 30 seconds when the user presses any of the buttons on the front panel.

### Shift Key

The **Shift** key is the white key located on the right side of the LCD screen.

When the **Shift** key is pressed, a contextual menu is displayed above the Z keys (Ins, Del, Param, etc.).

### Menu/OK Key

The Menu/OK key is the green key located below the LCD screen on the right side. This key is used for all confirmations: Menu, sub-menu, program, parameter, etc.

---



**Zx Keys**

The Zx keys are the gray keys aligned from left (Z1) to right (Z4) and located under the LCD. The arrows indicating the movement direction associated with navigation are marked above the keys.

The navigation keys are used to move left or right, down or up.

The position on the screen appears as a flashing zone:

- Square for a position that corresponds to a contact (only in programming mode),
- Round for a link (only in programming mode).

<p><b>Note:</b> When the keys may be used for other actions apart from navigation, a contextual menu bar is displayed (e.g.: 1, 2, 3 and 4 as Zx-type keys).</p>
--

---

## Contextual Menus

When the cursor is placed on a modifiable parameter, if the **Shift** key is pressed, a contextual menu appears.

Illustration:



Using the contextual menu functions:

- **+ / -**: Used to scroll through the various possible values of the selected field (types of inputs, outputs, automation functions, numbers, numerical values, etc),
- **Ins.:** Inserts a line,
- **Del.:** Deletes the selected element, or the entire line if it is empty,
- **Param.:** Displays the specific parameter screen for the automation function (visible only if the automation function contains a parameter),
- **← ↑ ↓ →**: Direction of the connection (visible only if the cursor is placed over a link box),
- **1 2 3 4**: This line appears when the keys are used as Zx key-type inputs in a program.

Illustration:

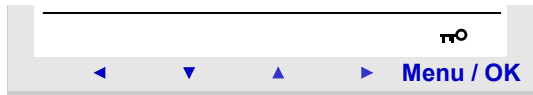

The key indicates that the program is password-protected.

Illustration:

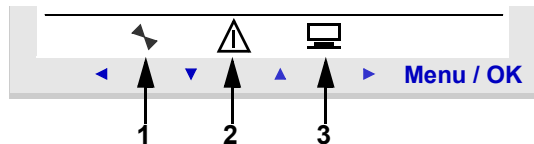

- 1: Indicates the state of the smart relay. In RUN it is in motion, in STOP it is immobile.
- 2: Indicates that faults have appeared (see FAULT menu).
- 3: The smart relay is physically connected to the programming software.



## Examples





### Introduction

We will now see two examples of how to use the smart relay's keys.

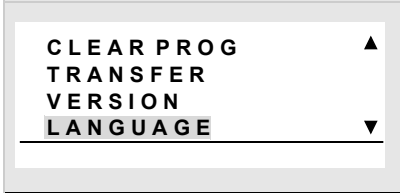
### Language Selection

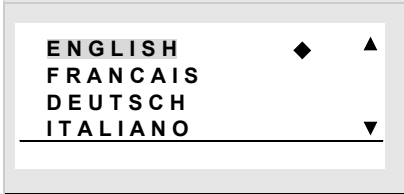
Example 1: Here are details on how to select the language of the smart relay:



Step	Action
1	<p>Powering up On initial powering-up, the INPUT-OUTPUT screen is displayed (See: <i>Inputs-Outputs Screen, p. 34</i>). By default, the selected language is English. <b>View:</b></p> 
2	<p>From the INPUT-OUTPUT screen, enter the MAIN menu , then go to the CONFIGURATION menu <b>LANGUAGE</b>, by pressing 7 times on the down navigation  key.</p> <p><b>View:</b></p>  <p><b>Note:</b> the selected command flashes.</p>

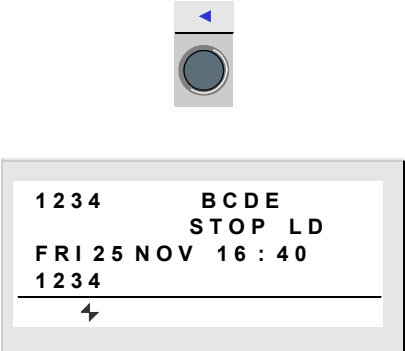



Step	Action
3	<p data-bbox="443 199 806 224">Enter in the language selection menu.</p> <div data-bbox="779 237 906 342" style="text-align: center;">  </div> <p data-bbox="443 358 502 383"><b>View:</b></p> <div data-bbox="640 394 1044 586" style="text-align: center;">  </div> <p data-bbox="443 602 1184 626"><b>Note:</b> The activated option flashes and it is also indicated by a black diamond.</p>
4	<p data-bbox="443 638 1130 662">Select and confirm the language (the selection is shown in flashing text).</p> <div data-bbox="651 675 1034 781" style="text-align: center;">  or  then  </div> <p data-bbox="443 797 1195 854">The <b>Menu/OK</b> button is used to confirm the selection of the new language. The display returns to the MAIN menu when the smart relay is in STOP mode.</p> <p data-bbox="443 854 502 878"><b>View:</b></p> <div data-bbox="640 891 1044 1083" style="text-align: center;">  </div>

Step	Action
5	<p data-bbox="422 199 1057 224">Return to the INPUT-OUTPUT screen using the left navigation key.</p> <p data-bbox="422 358 481 383"><b>View:</b></p>  <p>The diagram illustrates the navigation key and the resulting display screen. The navigation key consists of a small square button with a blue left-pointing arrow above a larger circular button. The display screen is rectangular and contains the following text: '1 2 3 4' on the first line, 'BCDE' on the second line, 'STOP LD' on the third line, 'FRI 25 NOV 16 : 40' on the fourth line, '1 2 3 4' on the fifth line, and a lightning bolt symbol on the sixth line. A horizontal line is positioned between the fourth and fifth lines of text.</p>

**Modification of Date and Hour**

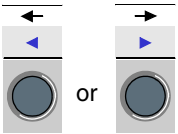
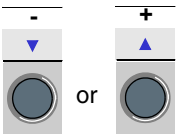
Example 2: Here are details on procedure to follow to modify the date and time of the initial power up or following a long lasting power failure.

Step	Action
1	<p>From the INPUT-OUTPUT screen, enter the <b>MAIN</b> menu, then go to the <b>CHANGE D/H</b> menu:</p> <div style="text-align: center;">  then  </div> <p>9 times in LD mode 7 times in FBD mode</p> <p><b>View:</b></p> <div style="border: 1px solid black; padding: 5px; width: fit-content; margin: 0 auto;"> <p style="text-align: center;">VERSION LANGUAGE DEFAULT <b>CHANGE D/H</b> ▼</p> </div>
2	<p>Enter the date and hour configuration menu:</p> <div style="text-align: center;">  </div> <p><b>View:</b></p> <div style="border: 1px solid black; padding: 5px; width: fit-content; margin: 0 auto;"> <p style="text-align: center;">CHANGE D/H THU 07 JUL 2003 16 : 27 30 s CAL ± 02 secs /WK</p> </div>

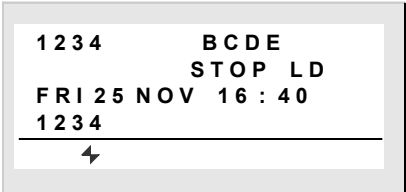
Step	Action
3	<p>Select the parameter to modify using the arrows (the selection is highlighted by the blinking of the parameter):</p>  <p>Modify the parameter using the navigation keys:</p>  <p>Then confirm with the <b>Menu/OK</b> key:</p>  <p>The <b>Menu/OK</b> button is used to confirm the modifications. The display returns to the MAIN menu when the smart relay is in STOP mode).</p> <p><b>View:</b></p> 
4	<p>Return to the INPUT-OUTPUT screen</p>  <p><b>View:</b></p> 

---

## Functions Accessible from the Front Panel



---

### At a Glance

#### Subject of this Section

This section describes the functions that can be accessed from the front panel of the smart relay.

#### What's in this Part?

This part contains the following chapters:

Chapter	Chapter Name	Page
2	Overview of the Functions Accessible from the Front Panel	31
3	Input/Output Screen	33
4	PROGRAMMING Menu	39
5	PARAMETERS Menu	51
6	MONITORING Menu	53
7	RUN/STOP Menu	55
8	CONFIGURATION Menu	57
9	CLEAR PROGRAM Menu	65
10	TRANSFER Menu	67
11	VERSION Menu	73
12	LANGUAGE Menu	75
13	DEFAULT Menu	77
14	CHANGE DATE/TIME Menu	81
15	CHANGE SUMMER/WINTER Menu	83



---

## Overview of the Functions Accessible from the Front Panel

# 2

---

### Functions Accessible from the Front Panel of the Smart Relay

---

#### Description

From the front panel of the smart relay, you may:

- Program (in LD mode),
- Configure,
- Control the application,
- Monitor the performance of the application.

Illustration:

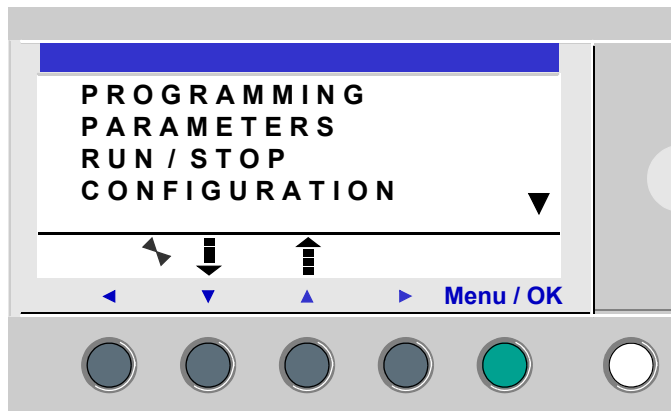



The line flashes to indicate where you are positioned.

The up triangle ▲ on the right side of the LCD screen indicates that possible up options exist. The down triangle ▼ indicates that possible down options exist.

To return to the previous menu, press left navigation key.

**Note:** The LCD screen is lit for 30 seconds when the user presses any of the buttons on the front panel.

**Managing Menus** The inputs-outputs screen is displayed by default whether the mode be **LD** or **FBD**. Pressing the **Menu/OK** key switches the display from the inputs-outputs screen to the main menu.

The menu on the first row which is selected by default (flashing). The  and  navigation keys can be used to place the cursor over the other menus.

Press the green **Menu/OK** key to display the screen corresponding to the selected menu or to move onto the first sub-menu.

---

**Differences Between LD and FBD Modes**

Certain menus are specific to either LD or FBD mode.

Menu	LD	FBD
PROGRAMMING	✓	
MONITORING	✓	
PARAMETERS	✓	✓
RUN / STOP	✓	✓
CONFIGURATION		
PASSWORD	✓	✓
FILTER	✓	✓
Zx KEYS	✓	
WATCHDOG CYCLE	✓	✓
CLEAR PROG.	✓	
TRANSFER	✓	✓
VERSION	✓	✓
LANGUAGE	✓	✓
FAULT	✓	✓
CHANGE D/T	✓	✓
CHANGE SUMM/WINT	✓	✓

---

**Configuring Extensions**

Extensions added to the smart relay may only be configured from the programming software. See on-line help of the programming software for more information.

---

---

# Input/Output Screen



# 3

---

## At a Glance

### Subject of this Chapter

This chapter describes the characteristics of the **input-output** screen.

### What's in this Chapter?

This chapter contains the following topics:

Topic	Page
Inputs-Outputs Screen	34
TEXT and DISPLAY screen	36

## Inputs-Outputs Screen

### Description

The inputs-outputs screen is the highest-level interface. It is displayed by default, when no (**TEXT** or **DISPLAY**) display function is active and regardless of:

- The programming type: **LD** or **FBD**,
- the mode: **STOP** or **RUN**.

Illustration:

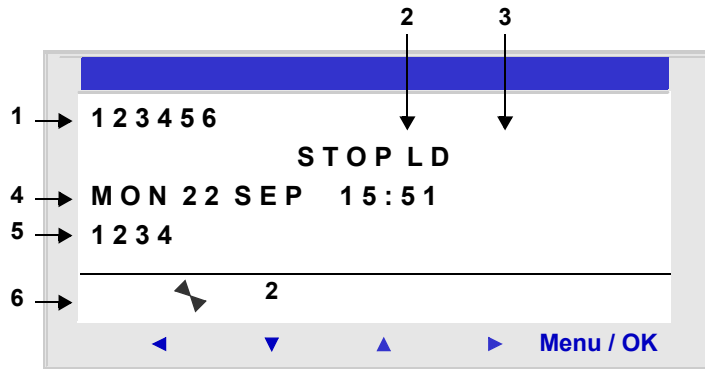

The inputs-outputs screen can be used to view:

1. the state of the inputs: 1 to 9, A to P,
2. The mode used: LD/FBD,
3. The Operating mode: RUN / STOP,
4. The date and time for products with a clock,
5. the state of outputs: 1 to 9, A to G,
6. Z push buttons: 1 to 4.

In Simulation mode or Monitoring mode when the program is in **RUN**, the active states of the inputs and outputs are indicated in reverse video.

**Access to the Main Menu**

Pressing the **Menu/OK** key switches the display from the inputs-outputs screen to the main menu:

- PROGRAMMING (**LD STOP** mode),
- MONITORING (**LD RUN** mode),
- PARAMETERS,
- RUN / STOP,
- CONFIGURATION (STOP mode),
- CLEAR PROG. (**LD STOP** mode),
- TRANSFER (STOP mode),
- VERSION,
- LANGUAGE,
- FAULT,
- CHANGE D/T,
- CHANGE SUMM/WINT.

The display automatically returns to the inputs-outputs menu on exiting all other menus and sub-menus.

---

## TEXT and DISPLAY screen

### Description

The display functions are used to display text or numerical values (current value, preset value, etc.) on the LCD display instead of the **INPUTS-OUTPUTS**:

- In **LD** mode: A **TEXT** function is active,
- in **FBD** mode: A **DISPLAY** function is active.

Illustration:

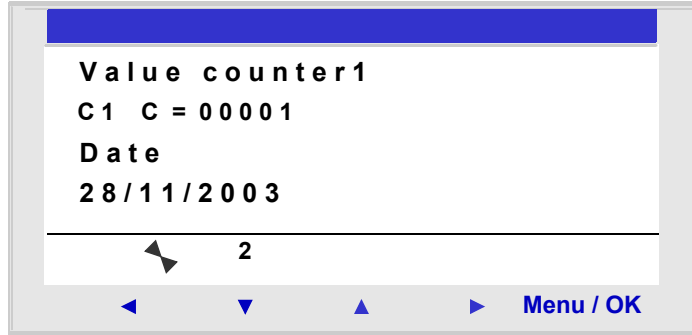

If several display functions are active simultaneously:

- In **LD** mode: The highest block number is displayed. There are 16 TEXT-type blocks numbered from 1 to 9 then from A to G,
- In **FBD** mode: The superposition of all of the FBD DISPLAY screens is displayed, for up to 32 blocks. If more than 32 FBD DISPLAY blocks are active, the screens of the 32 FBD DISPLAY blocks with the lowest numbers are superposed.

**Note:** The display functions are programmable only from the programming software (see the on-line help for the programming software for more information).

### Switching Between the Screens

Switching between the screens

It is however possible to go from the TEXT (LD) or DISPLAY (FBD) screen to the INPUTS-OUTPUTS screen and vice-versa.

To do this, proceed as follows:

Step	Step
Action	Press and hold down the <b>Shift</b> key and press the <b>Menu/OK</b> key.

## Modify Displayed Values

In **RUN** mode, when the TEXT / DISPLAY screen is displayed, it is possible to modify, from the front panel, the displayed values whose modification was authorized in the block function parameters window.

To do this, proceed as follows:

Step	Step
Action	Press the <b>Shift</b> key (white key) to display the contextual menu. <b>Result:</b> <b>Param</b> is displayed at the bottom of the screen.
2	Press the <b>▶</b> key (without releasing the <b>Shift</b> key) to display the contextual menu. <b>Result:</b> The parameter which can be modified flashes and the following contextual menu is displayed: 
3	Select the parameter to be modified using the navigation keys <b>◀</b> and <b>▶</b> from the contextual menu (the value which are available for modification flash).
4	Modify the parameter value with the <b>+</b> ( <b>▲</b> ) and <b>-</b> ( <b>▼</b> ) keys from the contextual menu.
5	Confirm the changes by pressing the <b>Menu/OK</b> key. <b>Result:</b> The display returns to the INPUTS-OUTPUTS screen or the TEXT / DISPLAY screen.

---

# PROGRAMMING Menu

# 4

---

## Presentation

### Subject of this Chapter

This chapter describes the characteristics of the **PROGRAMMING** menu specific to **LD mode** / smart relay in **STOP** mode.

This function lets the user enter the ladder diagrams that will work on the smart relay.

This program is written only using a ladder diagram LD.

Illustration:

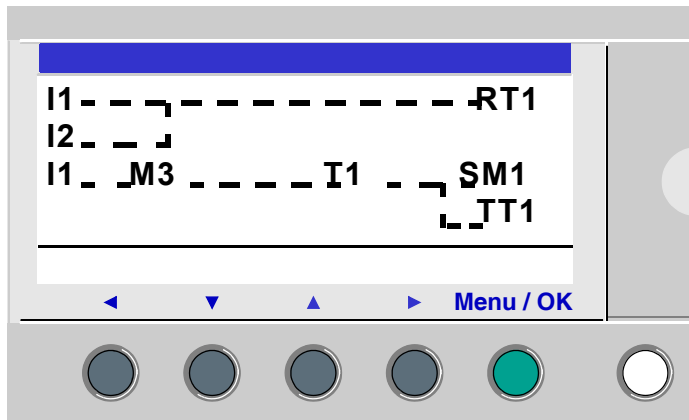

**Note:** The smart relays to which have been added an Input/Output extension are programmable only in **FBD mode** from the programming software. See on-line help of the programming software for more information.



**What's in this Chapter?**

This chapter contains the following topics:

<b>Topic</b>	<b>Page</b>
Rules for Entering Ladder Diagrams	41
Method for Entering a Contact or Coil	43
Entering a Link	45
Entry of Function Block Parameters	47
Deletion and Insertion of Diagram Lines	49

---

## Rules for Entering Ladder Diagrams

### Description

A smart relay allows you to enter 120 line Ladder diagrams.

The smart relay's display screen is used to display these lines, 4 at a time, in the following manner:

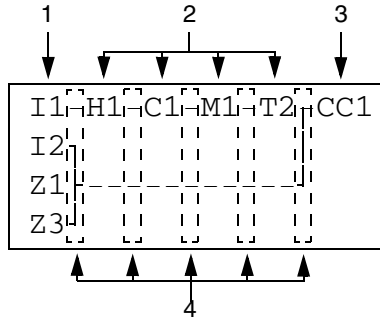

Prompt	Element
1	Column reserved for contacts (conditions).
2	Column reserved for contacts (conditions) and for links.
3	Column reserved for coils (actions).
4	Column reserved for links.

Each line comprises 5 fields each with 2 characters reserved for contacts (conditions). The 4 central columns can also accept links. The last three-character column is reserved for coils (actions).

Links must be entered between the contact and coil columns.

A ladder diagram is entered into the smart relay using the front panel keys (see *Control Keys on the Front Panel of the Smart Relay, p. 20*).

**Data Entry Rules** Make sure you respect the following rules when you enter a ladder diagram:

Rules	Incorrect	Correct
Each coil must only be entered once in the right hand column	<pre> I1----- [Q1 I2-I3-----TT1 T1----- [Q1 Z1●                     </pre>	<pre> I1]----- [Q1 T1] I2-I3-----TT1 Z1●                     </pre>
Elements used as contacts may be entered as many times as necessary in the 5 left hand columns.		<pre> I1-----TT1 T1----- [Q1 I3-T1----- [M2 I1-M2----- [Q2                     </pre>
Links must always run from left to right.	<pre> I1-I2-I3]       ]       [I4-I5-I6- [Q1                     </pre>	<pre> I1-I2-I3----- [M1 M1----I4-I5-I6- [Q1                     </pre>
If <b>S</b> coils (SET) are used in a diagram, also use an <b>R</b> (Reset) coil.	If no <b>R</b> (Reset) coils are used, the corresponding coil will always be set to 1.	An <b>R</b> (Reset) coil must be used for reset purposes.

**Note:** Smart relays run programs from top to bottom and from left to right.

## Method for Entering a Contact or Coil

### Description

**Note:** Accessible only in **LD mode** / smart relay in STOP mode.

This section describes the procedures for performing the following operations:

- Entering an element,
- Modifying an element,
- Deleting an Element.

This is valid for : contact or coil elements, whether the parameters can be set or not.



### Entering an Element

When entering an element, the following rules must be observed:

- **Contact:** In any column except the last,
- **Coil:** Only in the last column.

The presence of a square, flashing cursor means an element can be inserted.

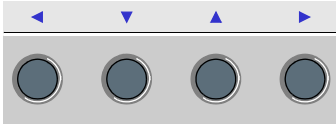
Entry procedure:

Step	Action
1	<p>Place the flashing cursor at the required location. The navigation keys can be used move the cursor in the direction of the arrows on the navigation keys ◀ ▼ ▶ ▶.</p> <p>Illustration:</p> 
2	<p>Press the <b>Shift</b> key to display the contextual menu.</p> <p>Illustration:</p>  <p>By simultaneously pressing <b>Shift</b> and one of the ▼ ▲ (- and +) keys, the first letter of the element is inserted: <b>I</b> for a contact and <b>Q</b> for a coil, followed by the number <b>1</b>.</p>
3	<p>Choose the type of element desired by pressing simultaneously on <b>Shift</b> and + or -. This makes the different types of elements scroll down cyclically, in the following order:</p> <ul style="list-style-type: none"> <li>• For the contacts: I, i, Z, z, M, m, Q, q, T, t, C, c, K, k, V, v, A, a, H, h, W, w, S, s.</li> <li>• For the coils: M, Q, T, C, K, X, L, S.</li> </ul> <p>See the chapter <i>LD Language Elements</i>, p. 87.</p>

Step	Action
4	Release the <b>Shift</b> key to have access to the navigation keys: ◀ ▼ ▲ ▶. Pressing the ▶ key places the cursor over the corresponding number 1.
5	Simultaneously hold down the <b>Shift</b> and + keys to increment the number of the element (2, 3, 4,..., 9, A, etc.). <b>Note:</b> The numbers for functional blocks are limited to the number of blocks of the type available in the smart relay. In the case of extensible smart relays, the inputs and outputs numbers are used to program the extension to maximum size. In entering a contact, once this step is completed, the entry is terminated. In entering a coil, you must additionally select the function of the coil.
6	Release the <b>Shift</b> key to have access to the navigation keys: ◀ ▼ ▲ ▶.
7	<b>Steps 7 to 9 are only necessary when entering a coil.</b> Position the cursor on the function of the coil by pressing twice on the ◀ key.
8	Select the desired function by pressing simultaneously on the <b>Shift</b> key and the + or - key. This will scroll through the different coil functions available.
9	Release the <b>Shift</b> key to have access to the navigation keys: ◀ ▼ ▲ ▶.

**Note:** Confirming some function block coils will bring-up a function block parameter setting screen.

### Modifying an element,

To modify an existing control diagram element, simply:

- Position the pointer over the element to modify: Step 1 in the previous table,
- Select the desired new element: Steps 3 to 6.

### Initialization

Status of contacts on program initialization:

- A contact in normally-open mode (direct state) is inactive,
- A contact in normally-closed mode (reverse state) is active,

### Deleting an Element

To delete an element, simply:

- Place the cursor over the element to delete: Step 1,
- Simultaneously press the **Shift** and **Menu/OK** keys.

Two scenarios are possible, depending on the position of the cursor at the time of the deletion:

- Cursor over an element: the element is deleted,
- Cursor over an empty position of the line: the whole line is deleted.

**Note:** Generally, the deleted element must be replaced by a link.

## Entering a Link

### Description

**Note:** Accessible only in **LD mode** / smart relay in STOP mode.



This section describes the procedures for performing the following operations:

- Entering links between elements,
- Deleting links between elements,
- Replacing a link with a contact.

### Entering a Link

Links are entered exclusively using the round flashing cursor.

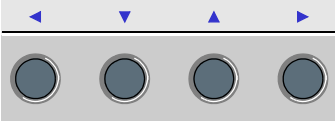
Entry procedure:

Step	Action
1	<p>Place the flashing cursor at the required location. The navigation keys can be used to move the cursor in the direction of the arrows on the navigation keys ◀ ▼ ▲ ▶.</p> <p>Illustration:</p> 
2	<p>Press the <b>Shift</b> key to display the contextual menu.</p> <p>Illustration:</p> 
3	<p>Trace connections by simultaneously pressing the <b>Shift</b> key and the navigation keys: ← ↑ ↓ →.</p> <p><b>Shift</b> and → to trace a connection to the position of the next contact or to the coil at the end of the line.</p> <p><b>Shift</b> and ↑ ↓ to trace perpendicular connections to the previous or next line.</p>
4	<p>Release the <b>Shift</b> key to have access to the navigation keys: ◀ ▼ ▲ ▶.</p>
5	<p>Repeat the operation as many times as necessary to link the elements together according to your requirements.</p>

- Modifying a Link** To modify an existing link, simply:
- Place the cursor over the link to modify: step **1**
  - Modify the link: Steps **2** to **5**.
- 

- Deleting a Link** To delete a link, simply:
- Place the cursor over the element to delete: step **1**.
  - Simultaneously press the **Shift** and **Menu/OK** keys.
- Two scenarios are possible, depending on the position of the cursor at the time of the deletion:
- Cursor over a link: The link is deleted,
  - Over an empty position of the line: The whole line is deleted.
- 

- Replacing a Link with a Contact** To replace a link with a contact, simply:
- Place the cursor (flashing square) over the link to transform: step **1**.
  - Follow the element entry (see *Method for Entering a Contact or Coil*, p. 43) procedure: Steps **3** to **6**.
-

---

## Entry of Function Block Parameters

---

### Description

**Note:** Accessible only in **LD mode** / smart relay in STOP mode.

When entering a control diagram, the parameters of the configurable automation functions must be completed.

The automation functions with parameters are the following:

- Auxiliary relays (see *Auxiliary Relays*, p. 93) (latching),
- Discrete Outputs (see *Discrete (DISCR) Outputs*, p. 98) (latching),
- Clocks (see *Clocks*, p. 134),
- Analog Comparators (see *Analog Comparators*, p. 129),
- Timers (see *Timers*, p. 101),
- Counters (see *Counters*, p. 111),
- Fast counters (see *Fast Counter*, p. 118).

### Accessibility of parameters

Function block parameter setting can be accessed:

- When entering the command diagram line,
  - From the **PARAMETERS** menu if the block has not been padlocked.
-



### Entering Parameters on Creation of the Block

Parameters are entered in the same way, whatever the parameters screen:

Step	Action
1	<p>Enter the desired automation function: Step 1 of the element entry (see <i>Method for Entering a Contact or Coil, p. 43</i>) procedure.</p> <p>When the function has parameters, <b>Param</b> appears in the contextual menu (when the <b>Shift</b> key is pressed).</p> <p>Illustration:</p> 
2	<p>Press and hold down the <b>Shift</b> key and press on <b>Param</b> (key ►).</p> <p><b>Result:</b> The function's parameter screen appears.</p>
3	Use the navigation keys to move to the cursor over the modifiable parameters: ◀ ▶.
4	Modify the value of the parameter using the + and - keys, holding down <b>Shift</b> .
5	Confirm the modifications by pressing <b>Menu/OK</b> , which will open the confirmation window. Confirm again by pressing the <b>Menu/OK</b> key to save.

### Modifying the Parameters of Existing Blocks

To modify the parameters of an existing element, simply:

Step	Action
1	Use the navigation keys to move the cursor over the element to modify: step 1 of the element entry (see <i>Method for Entering a Contact or Coil, p. 43</i> ) procedure.
2	At the same time, hold down <b>Shift</b> and the <b>Param</b> key to open the parameter window.
3	Carry out steps 3 to 5 above.

## Deletion and Insertion of Diagram Lines

### Deletion

**Note:** Accessible only in **LD mode** / smart relay in STOP mode.

Diagram lines are deleted line-by line. The procedure is the following:

Step	Action
1	Place the cursor over the line to delete.
2	Delete all the elements in the line (see <i>Method for Entering a Contact or Coil, p. 43</i> ): (Links, contacts and coils) to obtain an empty line.
3	Press the <b>Shift</b> key to display the contextual menu. Illustration: 
4	Confirm by pressing <b>Menu/OK</b> . Simultaneously pressing <b>Shift</b> and <b>Del</b> opens the confirmation window.

**Note:** It is possible to delete all diagram lines contained in the smart relay. In order to do this, select the **CLEAR PROG.** option from the main menu, and confirm the deletion of all the control diagram lines.

### Insertion

The procedure is the following:

Step	Action
1	Place the cursor over the line located immediately below the line to create.
2	Press the <b>Shift</b> key to display the contextual menu.
3	Press the <b>Ins</b> key (while holding down the <b>Shift</b> key) to create the line.

---

## PARAMETERS Menu



---

### PARAMETERS Menu

#### Description

This menu is used to enter and modify the application parameters directly on the screen using the smart relay keys. This function can be accessed in the two modes: **LD** and **FBD**, but the contents will be specific to the mode used.

If there are non-locked parameters to display they are listed in the window; otherwise a **NO PARAMETER** message appears.

---

#### LD mode

Functions with parameters in LD mode:

- Auxiliary relays (see *Auxiliary Relays*, p. 93) (latching),
- Discrete Outputs (see *Discrete (DISCR) Outputs*, p. 98) (latching),
- Clocks (see *Clocks*, p. 134),
- Analog Comparators (see *Analog Comparators*, p. 129),
- Timers (see *Timers*, p. 101),
- Counters (see *Counters*, p. 111),
- Fast counter (see *Fast Counter*, p. 118).

Only those functions used in the program and with parameters are listed in the **PARAMETERS** menu.

---

**FBD mode**

Functions with parameters in FBD mode:

- Numerical Constant-Type Inputs,
- Clocks,
- Gain,
- Timers: TIMER A/C, TIMER B/H, TIMER Li,
- Counters: PRESET COUNT,
- Fast counter,
- CAM block.

To access the parameters of the FBD blocks, you must know end enter the block number. This number appears in the programming software on the wiring sheet at the top right corner of the block.

Only those functions used in the program and with parameters are listed in the **PARAMETERS** menu.

**Parameter Modification**

Parameter modification procedure:

Step	Action
1	Place the cursor over the <b>PARAMETERS</b> menu in the main menu (PARAMETERS flashing) and confirm by pressing the <b>Menu/OK</b> button. <b>Result:</b> The parameters window opens to the first parameter.
2	Select the function to modify. To access the required function, scroll through the function block numbers (navigation keys ▼ and ▲) until you reach the right one.
3	Select the parameter to modify. The ◀ and ▶ keys are used to place the cursor over the parameter to modify.
4	Modify the parameter using the + and - keys (▲ and ▼) of the contextual menu.
5	Confirm the modifications by pressing <b>Menu/OK</b> , which will open the confirmation window.
6	Confirm again twice by pressing <b>Menu/OK</b> to save. <b>Result:</b> The display returns to the INPUTS-OUTPUTS screen in RUN mode and to the MAIN menu in STOP mode.

**Parameters in RUN Mode**

It is therefore possible to modify parameters in RUN mode dynamically as long as they are not locked.

The modifications can be made:

- From the **PARAMETERS** (see *PARAMETERS Menu, p. 51*) menu,
- From the **MONITORING** (see *MONITORING Menu, p. 53*) (LD) menu: Move the pointer over the function to be modified using the navigation keys and open the parameters window from the contextual menu (**Shift** key).

---

# MONITORING Menu

6

---

## MONITORING Menu

### Description

**Note:** Accessible only in **LD mode** / smart relay in RUN mode.

**MONITORING** mode can be used to obtain a dynamic view of the state of the smart relay inputs/outputs.

In this mode the wiring diagram appears as it does in the PROGRAMMING (see *PROGRAMMING Menu, p. 39*) menu (smart relay in STOP mode), but appear in reverse video when inputs or outputs are activated (white on black background).

Illustration:

```
I1-i2-----[Q1]
IB-----TT1
T1-----[Q2]
H1-----[M1]
```

This mode is also used to dynamically modify the values of automation function parameters if these are not locked.

---

**Parameter  
Modification**

To modify the parameters, proceed as follows:

Step	Action
1	Use the navigation keys to move the cursor over the element to modify: Step 1 of the element entry (see <i>Method for Entering a Contact or Coil, p. 43</i> ) procedure.
2	At the same time, hold down <b>Shift</b> and the <b>Param</b> key to open the parameter window.
3	Use the navigation keys to move to the cursor over the modifiable parameters: ◀ ▶.
4	Change the parameter value using the keys + and -.
5	Confirm the modifications by pressing <b>Menu/OK</b> , which will open the confirmation window. Confirm a second time by pressing <b>Menu/OK</b> to save.
6	Confirm again with <b>Menu/OK</b> . <b>Result:</b> Return to the parameter screen.
7	Confirm again with <b>Menu/OK</b> . <b>Result:</b> Return to the LD diagram screen.

---

---

# RUN/STOP Menu

# 7

---

## RUN/STOP Menu

### Description

This function is used to start or stop the program in the smart relay:

- In **STOP** mode: The program is stopped and the outputs disabled,
- In **RUN** mode (with or without initialization of latching parameters): The program is executed.

### Startup

In STOP mode, when accessing the RUN/STOP menu, the interface proposes the following three choices for starting the program:

- **WITH LATCHING INIT**: All current values (counters, timers, etc.) are reset to zero before the program starts (default selection),
- **WITHOUT LATCHING INIT**: Current values for which the **Latching** option has been activated are kept,
- **NO**: The program has not been started.

### Illustration:

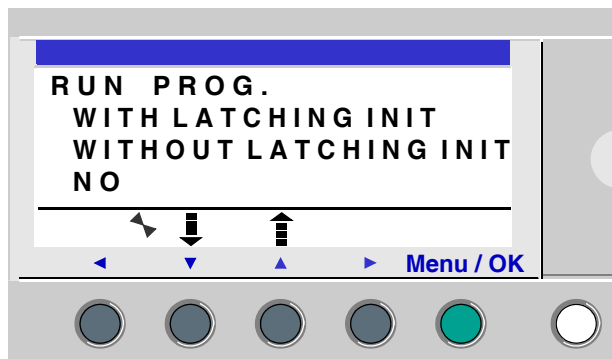

The navigation keys ▼ ▲ are used to change the selection.

When the mode has been validated with the **Menu/OK** key, the display moves to the **INPUT-OUTPUT** screen.

**Off**

In RUN mode, when accessing the RUN/STOP menu, the interface asks the user to confirm the request to stop the program:

- **YES:** The program stops (selected by default),
- **NO:** The program does not stop.

**Illustration:**

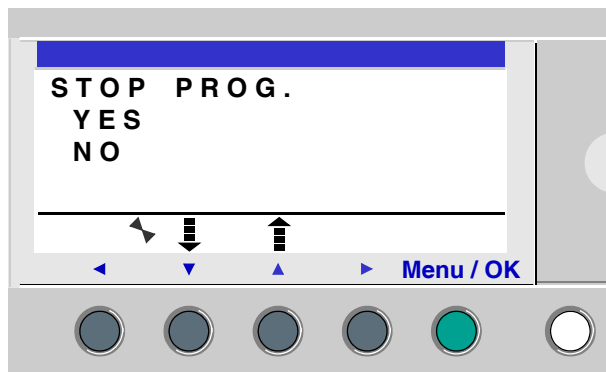

The navigation keys ▼ ▲ are used to change the selection.

When the mode has been confirmed with the **Menu/OK** key, the display moves to the **INPUT-OUTPUT** screen.

**Smart Relays Without Screen**

For smart modules without screen, a green LED located on the front panel of the module is an indicator light:

- If the LED flashes slowly (3 Hz), the module is in RUN mode (even if there is non-blocking fault).
- If the LED flashes rapidly (5 Hz), the module is in STOP mode with fault.
- If the LED stays lit, the module is powered-up and in STOP mode.

**Note:** On power up, the smart relay is in RUN mode, unless there is a blocking fault.

**Note:** To release a blocking fault, power off the module, then power it up again.



---

# CONFIGURATION Menu



---

## Presentation

### Subject of this Chapter

The **CONFIGURATION** menu provides access to the following 4 functions:

- PASSWORD,
- FILTER,
- Zx KEYS,
- WATCHDOG & CYCLE

This chapter describes the characteristics of these functions.

**Note:** Use the navigation key to return to the main menu ◀.

**Note:** If the program is password-protected, (key displayed in the contextual menu), the user must enter the password before any action can take place in the sub-menus.

**Note:** The **CONFIGURATION** menu is only available in STOP mode.

### What's in this Chapter?

This chapter contains the following topics:

Topic	Page
PASSWORD Menu	58
FILTER Menu	61
Zx KEYS Menu	62
WATCHDOG CYCLE Menu	63

## PASSWORD Menu

### Description

If the program is password-protected (key icon appears), the user must enter the password to perform certain operations.

The password protects access to the following menus:

- PROGRAMMING (**LD STOP** mode),
- MONITORING (**LD RUN** mode),
- CONFIGURATION (STOP mode),
- CLEAR PROG. (**LD STOP** mode),
- MODULE TRANSFER > MEM (STOP mode).
- MEM TRANSFER > MODULE (**LD STOP** mode depending on the choice of the programmer <sup>(1)</sup>, FBD STOP mode).

**Note:** <sup>(1)</sup> The programmer can configure the application to protect access to this menu in LD mode, .

Illustration:

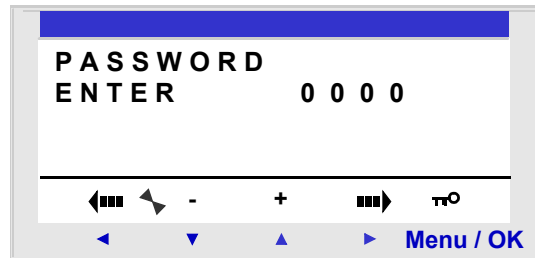

Activating the password also involves usage limitations in the programming software:

- Modification of the program contained in the smart relay,
- Rereading of the program contained in the smart relay,
- Destruction by transferring another program.
- Monitoring,

**Note:** If you lose a password, the solution is to overwrite the program from the programming software; see the on-line help of the programming software.

- Transferring/Clearing the program,
- Module/Update module Firmware, for more information about the compatibility of the firmware, see *Compatibility between the version of the programming software and the version of the firmware on the smart relay*, p. 234.

**Note:** It is possible to quit the screen without entering a password by using a combination of the **Shift** key (white key) and the **Menu/Ok** key (green key).

**Note:** To return to the main menu from the CONFIGURATION menu, use the navigation key **◀**.

**Entering Password**

Initially, the key is not displayed and each digit is set to 0.

The **ENTER** message appears in the window.

Entry procedure:

Step	Action
1	Use the navigation keys to select the digit to enter: <b>◀ ▶</b> .
2	Select the value of the digit using the <b>+</b> and <b>-</b> keys of the contextual menu.
3	Confirm the password with the <b>Menu/OK</b> key, which opens the confirmation window.
4	Confirm again with the <b>Menu/OK</b> key. <b>Result:</b> The display returns to the MAIN menu.

**Note:** Henceforth the key is displayed in the contextual menu line.

**Removing Password**

To cancel the password, follow the same procedure used to enter it.

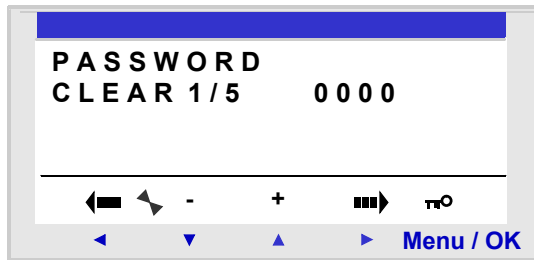

Initially, the key icon is displayed, meaning: Smart relay protected.

The message **CLEAR** and the number of attempts **1 / 5** appear in the window.

The following scenarios may arise:

- **Password correct:** The password is then inhibited, and the smart relay returns to the PASSWORD menu,
- **Password incorrect:** The **CLEAR** counter is incremented.

Illustration:

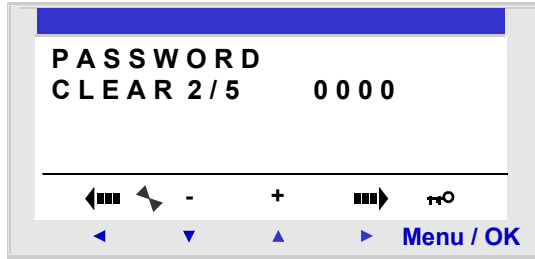

If an incorrect password is entered **5** times consecutively, the security function is locked for 30 minutes.

During this period, if the power supply to the smart relay fails, the countdown will start again on power up.

Illustration:

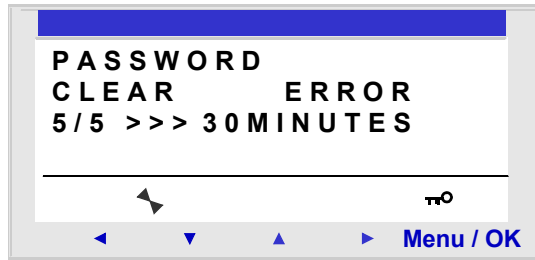

### Modifying Password

To modify the password, simply cancel the old password and enter a new one.

---

## FILTER Menu

### Description

This function is used to detect more quickly any changes in states of Discrete inputs.

Two choices are available:

- Fast,
- Slow.

Response time:

Filtering	Commutation	Response time
Slow	ON → OFF	5 milliseconds
	OFF → ON	3 milliseconds
Fast	ON → OFF	0.5 milliseconds
	OFF → ON	0.3 milliseconds

This selection can only be made when the smart relay is in STOP. By default, the smart relays are configured in SLOW.

**Note:** This function is available on smart relays with a direct voltage power supply.

**Note:** to return to the main menu from the CONFIGURATION menu, use the navigation key ◀.

### Filter-Type Selection

The current type is indicated by the selection symbol (black diamond).

Procedure for selection of filter type:

Step	Action
1	Select the type of filtering using the ▼ ▲ keys (the selection will flash).
2	Confirm with <b>Menu/OK</b> . <b>Result:</b> the display returns to the MAIN menu.

## Zx KEYS Menu

---

### Description

**Note:** Only accessible in **LD mode**.

The **Zx KEYS** option is used to activate or deactivate the use of the navigation keys as pushbuttons.

Different functions can be obtained depending on the state of this option:

- **Inactive:** The keys are only available for setting, configuring and programming the smart relay.
- **Active:** they can also be used in a control diagram.  
In this configuration, they operate as pushbuttons: Zx keys (see *Zx Keys, p. 91*), without the need to use a terminal input contact.

**Note:** To return to the main menu from the CONFIGURATION menu, use the navigation key ◀.

### Zx Keys in RUN Mode

By default, the Zx keys are used as navigation keys.

In RUN mode, when the inputs-outputs screen, TEXT screen or DISPLAY screen is active, the numbers of the Zx keys used in the program are displayed in the contextual menu line.

To activate the key, simply select the required key ◀ ▼ ▲ ▶.

Illustration:

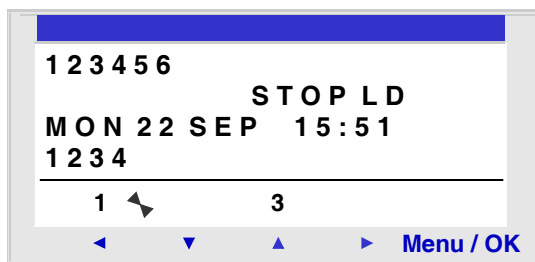

**Note:** The function is inactive in Parameters mode, Monitoring and all the function block parameter and configuration screens.

## WATCHDOG CYCLE Menu

### Description

The duration of a program cycle depends on its length and complexity: In particular, the type and number of inputs-outputs and the number of extensions.

The program is executed periodically at regular time intervals. This time interval is called the **cycle** time.

The program will only execute completely if the cycle time is greater than the program execution time.

The cycle period is configurable in the : **CONFIGURATION** → **CYCLE WATCHDOG** menu. This period may be set from 6 to 90 milliseconds in 2-millisecond steps.

The default value of the cycle period is 10 milliseconds.

Illustration:

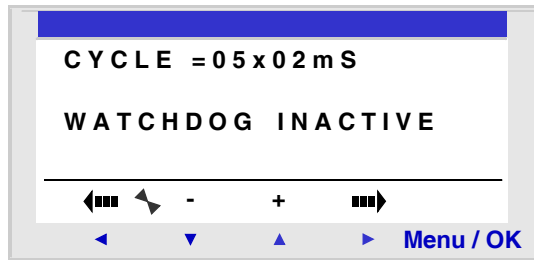

**Note:** Make sure that:

- Input variations that are too rapid are not masked by cycle time that is too slow,
- The speed of output variations is compatibles with system commands.

If the duration of the execution cycle of the program and the embedded software functions exceeds the cycle time value selected by the programmer, the WATCHDOG can be used to operate a specific action.

**Note:** In certain dialog phases, the cycle times are increased by the communication times between the PC and the smart relay. No guarantee can be made concerning the real cycle times during this operating mode. The WATCHDOG is always inhibited in this smart relay operating mode.

**Note:** To return to the main menu from the CONFIGURATION menu, use the navigation key ◀.

**Actions**

The WATCHDOG can perform the following different actions:

- **INACTIVE:** normal operating mode,
  - **ALARM:** A warning state is set and the warning number corresponding to **Cycle time overrun** is accessible in the **FAULT** menu,
  - **ERROR:** the program stops (STOP mode) and the error number corresponding to: **Cycle time overrun** is accessible in the **FAULT** menu.
- 

**Cycle Time**

The cycle time may be set from 6 to 90 milliseconds in 2-millisecond steps.

To adjust this period, adjust the step multiplier factor by 2 milliseconds using the + and - keys of the contextual menu. This factor is between 3 and 45.

<b>C Y C L E = 0 5 x 0 2 m S</b>
----------------------------------

The multiplier factor is adjusted depending on the shortest sampling period of the inputs.

---

**WATCHDOG Configuration**

Procedure:

Step	Action
1	Configure the <b>CYCLE</b> parameter using the + and - keys of the contextual menu.
2	Confirm the entry using one of the keys: ◀ or ▶. <b>Result:</b> The <b>CYCLE</b> parameter is confirmed and the <b>WATCHDOG</b> parameter is selected (it flashes).
3	Configure the <b>WATCHDOG</b> parameter using the + and - keys of the contextual menu.
4	Confirm your changes by pressing the <b>Menu/OK</b> key. <b>Result:</b> The display returns to the MAIN menu.

---



---

## CLEAR PROGRAM Menu

9

---

### CLEAR PROG Menu.

#### Description

**Note:** Accessible only in **LD mode**.

This function is used to clear the entire program.

**Note:** If the program is protected (key displayed), the user must enter the password (see *PASSWORD Menu, p. 58*) before being able to delete the program.

#### Clearing the Program

On opening, NO is selected by default.

Procedure:

Step	Action
1	Select the <b>YES</b> choice using the navigation keys ▼ and ▲.
2	Confirm the clear command by pressing the <b>Menu/OK</b> key. <b>Result:</b> the display returns to the MAIN menu.

---

## TRANSFER Menu

10

---

### TRANSFER Menu

#### Description

This function is used to:

- Load the firmware and the application contained in the smart relay into the backup memory.
- load firmware and application from the backup memory to the smart relay.

This backup memory can then be used to load the firmware and the application into another smart relay.

Illustration:



**Note:** The backup memory is provided as an option.

**Note:** Insertion and extraction of the backup memory may be performed even when the smart relay is powered up.  
For smart relays without screens, detection of the memory may only be performed on power up of the smart relay, if the memory is inserted when the smart relay is powered on, it will not be acknowledged.

**Note:** If the application is protected (key icon displayed), the user must enter the password before being able to save the program.

**Note:** if an application is already present in the backup memory, it will be overwritten by the new transfer (no test is performed to check the memory is free).

**Note:** It is not possible to directly transfer an application created with version V2 of the programming software from the SR2 MEM01 memory to the smart relay if this latter contains version V3 firmware.

In this case, see what action you should take in the section Program incompatible with firmware of the module (see *Application incompatible with firmware on the smart relay, p. 70*).

For more information about the compatibility of the memory cartridges, see *Compatibility between the memory cartridges and the version of the firmware on the smart relay, p. 195*.

### Module → Backup Memory Transfer

Procedure for transferring the application, from the smart relay to the backup memory:

Step	Action
1	Insert the EEPROM cartridge (SR2 MEM02) into the slot provided.
2	Select the transfer type: <b>MEMORY&gt;ZELIO</b> using the navigation keys ▼ ▲.
3	Confirm the transfer command with the <b>Menu/OK</b> key. (Enter the password if the program is password-protected).
4	Wait for the transfer to end. Display: >>> <b>MEMORY</b> then <b>TRANSFER. OK</b> when it is complete.
5	Confirm again by pressing <b>Menu/OK</b> key to exit the menu. <b>Result:</b> The display returns to the INPUTS-OUTPUTS screen in RUN mode and to the MAIN menu in STOP mode.

**Backup Memory**  
→ **Module**  
**Transfer**

Procedure for transferring the application, from the backup memory to the smart relay, for a **smart relay with LCD and keyboard**:

Step	Action
1	Insert the EEPROM cartridge (SR2 MEM02) with the program to be transferred into the slot provided.
2	Select the transfer type: <b>MEMORY&gt;ZELIO</b> using the navigation keys ▼ ▲.
3	Confirm the transfer command with the <b>Menu/OK</b> key.
4	Wait for the transfer to end. Display: > > > <b>MODULE</b> then <b>TRANSFER. OK</b> when it is complete.
5	Confirm again by pressing <b>Menu/OK</b> to exit the menu. <b>Result:</b> the display returns to the INPUTS-OUTPUTS screen in RUN mode and to the MAIN menu in STOP mode.

Procedure for transferring the application, from the backup memory to the smart relay, for a **smart relay without LCD or keyboard**:

Step	Action
1	Since the smart relay <b>is not powered-on</b> , insert the EEPROM cartridge (SR2 MEM02) into the slot provided.
2	Power up the smart relay. During the transfer, the LED display is off.
3	Wait for the transfer to end. During the transfer, the LED display is off, then at the end of the transfer the LED flashes.
4	<ul style="list-style-type: none"> <li>● If the flashing is slow (3 Hz), the transfer has been successful, the smart relay is in RUN, remove the EEPROM cartridge (SR2 MEM02).</li> <li>● If the flashing is rapid (5Hz), the transfer has failed due to incompatibility between the configuration necessary for the program to be transferred and that of the smart relay.</li> </ul>

**Note:** When the smart relay is in STOP mode, the LED display is lit and does not flash.

**Possible Errors**

Below are the possible errors and, for each case, the messages that are displayed:

- **Absence of backup memory**

Error message:

TRANSFER ERROR: NO MEMORY

- **Configurations of the hardware and program to transfer incompatible**

Error message:

TRANSFER ERROR: CONFIG INCOMPAT (hardware or software reference numbers).

Refer to the *DEFAULT Menu*, p. 77 chapter to consult the error number and clear it.

**Note:** The transfer of one module program to another via a memory card is only possible between smart relays with the same reference. For example, it is impossible to transfer a program from a module with a clock to a module that does not have one.

**Application incompatible with firmware on the smart relay**

If the application stored in backup memory SR2 MEM01 was created with a version of the programming software that is incompatible (see *Compatibility between the memory cartridges and the version of the firmware on the smart relay*, p. 195) with the firmware of the target smart relay, proceed as follows:

Step	Action
1	Load the application from the backup memory to a smart relay with compatible firmware. <b>Note:</b> If no smart relay has firmware that is compatible with the application, use the programming software version that was used to create the application to load compatible firmware into the target smart relay:
2	Use the version of the programming software that was used to create the application to load it from the smart relay toward the PC.
3	Save the application uploaded in step 2.
4	Launch the latest version of the programming software.
5	Open the application saved in step 3. <b>Result:</b> The programming software converts the application.
6	Load the converted application and the associated firmware to the target smart relay.

**Use of SR2  
MEM01 and SR2  
MEM02**

On SR2 MEM01, only the program is loaded whereas on SR2 MEM02 the program and the corresponding firmware is loaded.

Consequently:

- With the SR2 MEM01 memory cartridge, you can perform:
  - A smart relay to memory transfer if the version of the firmware on this relay is strictly lower than 3.09.
  - A memory to smart relay transfer if the program contained in the SR2 MEM01 memory cartridge is loaded from a smart relay that has the same version of firmware as the smart relay to which you want to load the cartridge.
- With the SR2 MEM02, memory cartridge, you can perform:
  - A smart relay to memory transfer if the version of the firmware on this relay is equal to or higher than 3.09.
  - A memory to smart relay transfer if the version of the firmware on the relay to which you want to load the cartridge is higher than 3.09.

For more information about the compatibility of the memory cartridges, see *Compatibility between the memory cartridges and the version of the firmware on the smart relay, p. 195.*

---

---

## VERSION Menu

11

---

### VERSION Menu

#### Description

This function is used to precisely identify the version of each system component:

- Type of hardware,
- Firmware,
- LD functions,
- FBD functions.

Illustration:

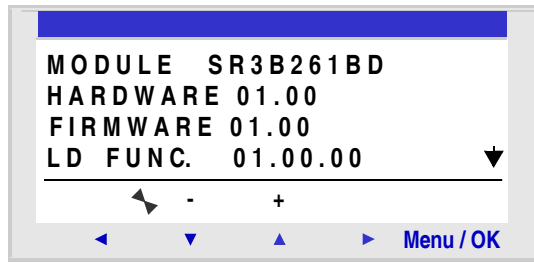

This information is available for the smart relay, but also for the connected extensions.

The ▼ symbol is present in the bottom right, indicating the existence of extensions connected to the smart module.

Illustration:

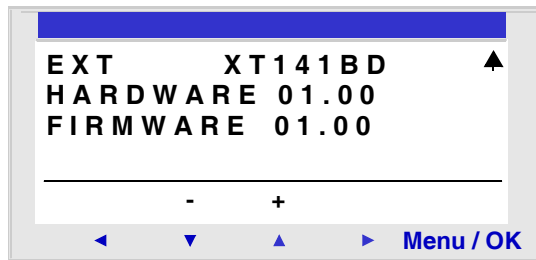

To quit, press the **Menu/OK** button, the display returns to the INPUTS-OUTPUTS screen in RUN mode and to the MAIN menu in STOP mode.

---



---

# LANGUAGE Menu

12

---

## LANGUAGE Menu

### Description

This function is used to select the language used by the smart relay.

All messages may be viewed in 6 languages:

- English,
- French,
- German,
- Italian,
- Spanish,
- Portuguese.

Illustration:

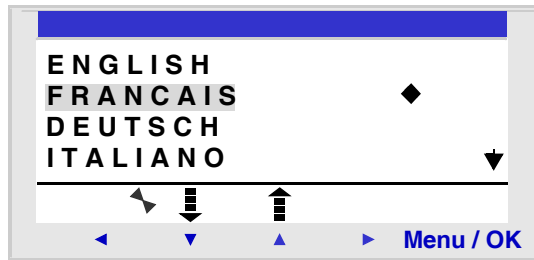

### Language Selection

The current language is indicated by the selection symbol (black diamond).

Language selection procedure:

Step	Action
1	Select the language using the navigation keys: ▼ and ▲ (the selection flashes).
2	Confirm with the <b>Menu/OK</b> key. <b>Result:</b> The display returns to the INPUTS-OUTPUTS screen in RUN mode and to the MAIN menu in STOP mode.

---

## DEFAULT Menu

13

---

### FAULT Menu

#### Description

This function is used to:

- Display on the LCD screen the type of fault detected by the firmware of the smart relay (error or warning: Watchdog overrun, *see WATCHDOG CYCLE Menu, p. 63*, cycle time too high, etc.),
- Reset the fault counter to zero.

Illustration:

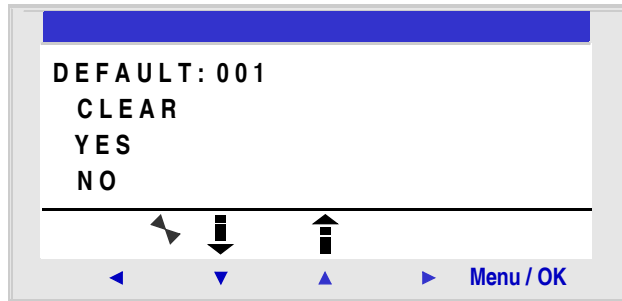

#### Reset to Zero of the Fault Counter

To reset the fault counter to zero, proceed as follows:

Step	Action
1	Select the <b>YES</b> choice using the navigation keys ▼ and ▲.
2	Confirm the clear command by pressing the <b>Menu/OK</b> key. <b>Result:</b> The display returns to the INPUTS-OUTPUTS screen in RUN mode and to the MAIN menu in STOP mode.

**Fault Types** Below, the description of possible faults:

Number	Type of fault
000	<b>No faults</b>
001	<b>Fault in writing to EEPROM</b> This fault defines the transfer problems between the memory cartridge and the smart relay. If this fault occurs frequently, contact the after-sales service.
002	<b>Clock write fault</b> If the fault occurs frequently, contact the after-sales service.
004	<b>Overload on solid state relay outputs</b> Once a transistor output reaches a temperature of 170°C, the group of 4 outputs to which it belongs is deactivated. To make this group of outputs operational, the cause of the over current (short-circuit, etc.) must first be deleted, and then the fault cleared from the FAULT menu (see <i>FAULT Menu</i> , p. 77).
050	<b>Smart relay firmware is damaged</b> Reload the firmware on the smart relay and the user application. If this problem persists, contact the after-sales service.
051	<b>Watchdog overflow</b> Warning or error according to the selection made in the menu (smart relay display) or in the configuration window (programming software). The cycle time in the smart relay is too short compared with the application program execution time programmed in the smart relay. If the application requires cycle time or strict sampling of the smart relay inputs/outputs, lengthen the application cycle time in the smart relay. To do this, either set the parameters in the CONFIGURATION menu (smart relay display) or in the configuration window (programming software). If the application does not require the cycle time, you must choose: <b>No WATCHDOG Action</b> , in the CONFIGURATION menu.
052	<b>The smart relay has executed an unknown operation</b> If the fault is permanent, reload the firmware on the smart relay and the user application. If this problem persists, contact the after-sales service.
053	<b>Link fault between smart relay and bus-type extension</b> Check operation of the extension (connection, power supply, fault).
054	<b>Link fault between smart relay and input/output-type extension</b> Check operation of the extension (connection, power supply and fault).
058	<b>A fault has been detected in the firmware (software specific to the smart relay) or on the smart relay hardware.</b> If the fault is permanent, reload the firmware on the smart relay and the user program. If this problem persists, contact the after-sales service.
059	<b>At the beginning of RUN on the smart relay application: The application cannot switch to RUN because it is incompatible with the smart relay physically connected to the power supply.</b> If this problem occurs, contact the after-sales service.
060	<b>At the beginning of RUN on the smart relay application: Program incompatible with the bus extension physically connected to the power supply.</b> If this problem occurs, contact the after-sales service.

---

Number	Type of fault
061	<b>At the beginning of RUN on the smart relay application: Program incompatible with the Input/Output extension physically connected to the power supply.</b> If this problem occurs, contact the after-sales service.
062	<b>Version (or build number) incompatibility when loading a program from the backup memory</b> If this problem occurs, contact the after-sales service.
063	<b>Hardware configuration incompatibility when loading a program from the backup memory</b> If this problem occurs, contact the after-sales service.

---

---

## CHANGE DATE/TIME Menu

14

---

### CHANGE DATE/TIME Menu

#### Description

This function is used to configure the date and time of the smart relays that have a clock.

Illustration:

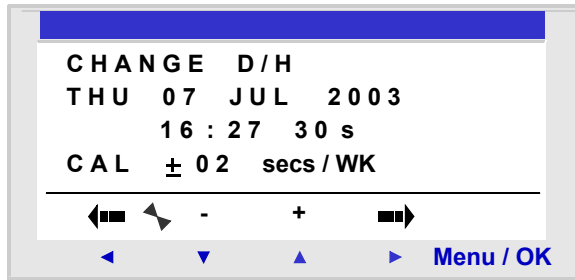

The modifiable parameters are:

- Day / week / month / year,
- Hour, minutes, seconds,  
Values are recorded by pressing the **Menu/Ok** key; if you wish to specify the time more accurately, you should complete the entry of modifications with minutes and seconds.
- CAL: Calibration of the internal clock of the smart relay in seconds per week.

**Clock Calibration** The quartz that controls the real-time clock of the smart relay has a variable monthly drift depending on the environmental conditions of the smart relay.

The maximum value for this drift is approximately one minute per month.

To estimate this drift, proceed by observing the drift on the smart relay clock with respect to a standard reference clock for a few weeks or more.

**Example:**

If you wish to compensate this drift, you can for example make a -15 second correction per week to compensate for a + 60 second drift per month. This compensation is executed on Sunday at one O'clock in the morning.

**Note:** This correction serves no purpose if the smart relay is subject to long power interruptions or major variations in temperature.

---

**Clock Configuration**

Procedure:

Steps	Description
1	Select the parameter to modify using the navigation keys ◀ and ▶. <b>Result:</b> The selected parameter flashes. (When you enter this mode, the day value is selected)
2	Modify the value of the parameter. The + and - keys of the contextual menu can be used to change the current value.
3	Confirm the changes by pressing the <b>Menu/OK</b> key. <b>Result:</b> The display returns to the MAIN menu.

**Note:** The smart relay contains a software module that determines the day of the week when the user selects the day of the month in the year.

**Note:** You are not allowed to modify the hour by a product between 2:00 and 3:00 AM for the days of the change from summer to winter time (at 3:00 it is 2:00)

---

---

## CHANGE SUMMER/WINTER Menu

15

---

### CHANGE SUMMER/WINTER Menu

#### Description

This function is used to change the time range automatically: Summer/winter, for smart relays with a clock.

Illustration:

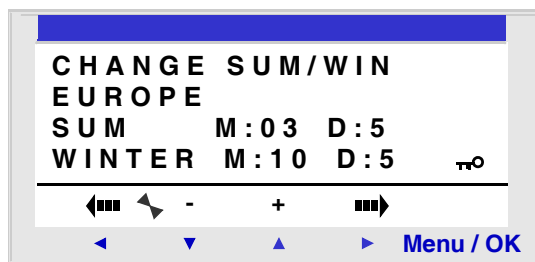

The following operating modes are possible:

- **NO:** no change,
- **Automatic:** The change takes place automatically, the dates are preset according to the geographic zone:
  - EUROPE: Europe,
  - USA.
- **OTHER ZONE:** (MANUAL) the change takes place automatically, but you must specify, for summer and winter:
  - The month: **M**,
  - The Sunday: **D** (1, 2, 3, 4 or 5) when the change takes place.

**Configuration of the Time Change**

To configure automatic time change, proceed as follows:

Step	Action
1	Select the parameter to modify using the navigation keys ◀ and ▶. <b>Result:</b> The selected parameter flashes.
2	Modify the parameter value. The + and - keys of the contextual menu are used to change the current value.
3	Confirm the changes by pressing the <b>Menu/OK</b> key. <b>Result:</b> The display returns to the MAIN menu.

---



---

# LD Language



---

## At a Glance

### Subject of this Section

This section describes the use of LD (Ladder Diagram) programming language for the smart relay.

### What's in this Part?

This part contains the following chapters:

Chapter	Chapter Name	Page
16	LD Language Elements	87

---

# LD Language Elements

# 16

---

## At a Glance

### Subject of this Chapter

This chapter describes the different automation functions of the LD language.

### What's in this Chapter?

This chapter contains the following topics:

Topic	Page
Introduction	88
Discrete Inputs	89
Zx Keys	91
Auxiliary Relays	93
Discrete (DISCR) Outputs	98
Timers	101
Counters	111
Fast Counter	118
Counter Comparators	128
Analog Comparators	129
Clocks	134
Texts	138
LCD Screen Backlighting	140
Change to Summer / Winter Time	141
Modbus Inputs/Outputs	143
Message	144

---

## Introduction

### Description

In **LD** programming mode, an application can be created from the interface of the front panel of the smart relay.

Here is detailed information on all possible elements of a ladder diagram in **LD** mode that are recognized and used by smart relays.

To better understand the functions performed by each element, where necessary a directly usable example is included.

### Composition of Ladder Diagrams

Smart relays accept 120-line diagrams.

- Each line is comprised of a maximum of 5 contacts.
- Contacts must be attached to one coil, and the coil is not necessarily on the same line.

**Note:** When an application requires more than five contacts to activate an action, the auxiliary relays may be used.

### Sample Ladder Diagram

Below is an example of a ladder diagram, as it appears on the display of the front panel of a smart relay:

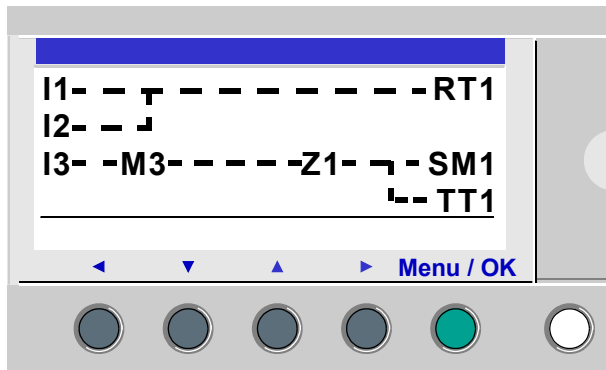

## Discrete Inputs

### Description

The **Discrete Inputs** can be used exclusively as contacts in the program.

These contacts represent the status of the input for the smart relay connected to a sensor (push button, switch, sensor, etc.).

The contact number corresponds to the number of terminals of the associated input: 1 to 9, then A to R (except for letters I, M and O) according to the smart relay and the possible extension.

### Use as a Contact

This contact may use the direct state of the input (normally open mode) or its inverse state (mode normally closed), see below.

#### Normally open mode:

Symbol of a normally open contact:

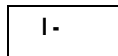

A normally open contact corresponds to the use of the **direct** state of the input. If the input is **supplied**, the contact is said to be **conducting**.

Example: Using a pushbutton to switch a lamp on and off.

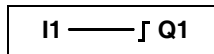

If input **1** is supplied, contact **I1** is closed, and coil **Q1** is activated.

#### Normally closed mode:

Symbol of a normally closed contact:

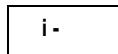

A normally closed contact corresponds to the use of the **reverse** state (logical complement of the direct state) of the input. If the input is **supplied**, the contact is said to be **non-conducting**.

Example: Controlling a lamp using an input in reverse state.

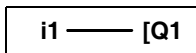

If input **1** is supplied, contact **i1** is open, and coil **Q1** is non-activated.

**Modification of the state of a contact**

To modify a contact from the front panel of the smart relay (the programming window is displayed on the screen), simply:

- Place the cursor over the letter of the contact,
  - Proceed as indicated in the paragraph *Modifying an element*, p. 44, to scroll through the possible contact types (I for a normally open contact, i for a normally closed contact).
- 

**Initialization**

Status of contacts on program initialization:

- The direct state is inactive,
  - The reverse state is active.
-

## Zx Keys

---

### Description

The navigation keys behave exactly like the **I** physical inputs (Discrete inputs). The only difference is that they do not correspond to smart relay connection terminals, but to the four gray buttons on the front panel.

They are used as pushbuttons, and can only be used as contacts.

---

### Use as a Contact

This contact may use the direct state of the key (normally open mode) or its inverse state (mode normally closed), see below.

#### Normally open mode:

Symbol of the normally open contact, representing a key:

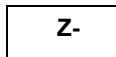

The **normally open** mode corresponds to the use of the direct state of the key. If the key is **pressed**, the corresponding input is said to be **conducting**.

#### Normally closed mode:

Symbol of the normally closed contact, representing a key:

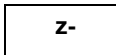

The **normally closed** mode corresponds to the use of the reverse state (logical complement of the direct state) of the key. If the key is **pressed**, the corresponding input is said to be **non-conducting**.

---

### Example

Creating a switch operated by the **Z1** key and **Q1** output:

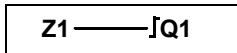

Each time the Z1 key is pressed, the Q1 output changes state.

---

### **Deactivation of Zx Keys**

By default the **Zx Keys** are active. They may be deactivated in one of the following ways:

- From the smart relay front panel: Using : **CONFIGURATION** → **Zx KEYS** menu, see *Zx KEYS Menu*, p. 62
- From the programming software: See on-line help of the programming software for more information.

**Note:** When the smart relay is in RUN mode, if the **Zx Keys** have been deactivated, they cannot be used for inputs in the program, but can be only used for navigating the menus.

---

### **Modification of the State of a Contact**

To modify a contact from the front panel of the smart relay (the programming window is displayed on the screen), simply:

- Place the mouse over the letter representing the contact,
- Proceed as indicated in the paragraph *Modifying an element*, p. 44, to scroll through the possible contact types (**Z** for a normally open contact, **z** for a normally closed contact).

---

### **Initialization**

Status of contacts on program initialization:

- Normally open mode (direct state) is inactive,
  - Normally closed mode (reverse state) is active.
-

## Auxiliary Relays

---

**Description**      **Auxiliary relays** marked **M** behave in exactly the same way as **Q Discrete outputs** (see *Discrete (DISCR) Outputs, p. 98*), but do not have an electrical output contact. They can be used as internal variables.

There are 31, numbered from 1 to 9 and from A to Y except for letters I, M, O.

All auxiliary relays can be used, in the program, indifferently either as a coil or contact. They can be used to latch a state to be used in the form of the associated contact.

---



**Use as a Coil**

To use an auxiliary relay as a coil, 4 modes are available:

- Contactor mode,
- Impulse relay mode,
- Latch mode,
- Unlatch mode.

**Contactor mode:**

Symbol of an auxiliary relay, used as a coil in contactor mode:

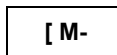

The relay is energized if the contacts to which it is connected are conducting. Otherwise it is not energized.

**Impulse relay mode:**

Symbol of an auxiliary relay, used as a coil in impulse relay mode:

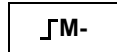

Pulse energization, the coil changes state on each pulse it receives.

**Latch mode:**

Symbol of an auxiliary relay, used as a coil in latch mode:

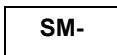

The **SET** relay, also called the latch relay, is energized as soon as the contacts to which it is connected are conducting, then stays set even if later the contacts are no longer conducting.

This behavior is identical to that of an RS logic flip-flop.

**Unlatch mode:**

Symbol of an auxiliary relay, used as a coil in latch mode:

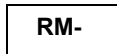

The **RESET** relay, also called the unlatch relay, is deactivated when the contacts to which it is connected are conducting. It remains deactivated even if later the contacts are no longer conducting.

**Note:** for reasons of increasing compatibility for programs operating with Zelio 1, the four types of mode for any given Q output coil or M auxiliary relay can be used in the same wiring diagram in Zelio 2.

**Use as a Contact** Auxiliary relays can be used as contacts as many times as necessary.

This contact may use the direct state of the relay (normally open mode) or its inverse state (mode normally closed), see below.

**Normally open mode:**

Symbol of an auxiliary relay, used as a contact in normally open mode:

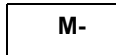

A relay used as **normally open contact** corresponds to the use of the direct state of the relay. If it is **powered**, the contact is said to be **conducting**.

**Normally closed mode:**

Symbol of an auxiliary relay, used as a contact in normally closed mode:

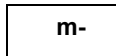

An auxiliary relay used as a **normally closed contact**, corresponds to the use of the reverse state (logical complement of the direct state) of the relay. If it is **powered**, the contact is said to be **non-conducting**.

---

**Example**

In the following example turning on and off a lamp is conditioned by the status of the 6 following inputs: I1, I2, I3, I4, I5 and IB.

The is on when:

- The I1, I4, I5 and IB inputs are set to the state 1,

and

- The I2, I3 are set to state 0.

Because the smart relay does not allow more than five contacts on a line, auxiliary relays are used to control the lamp.

You choose to memorize the state of inputs I1, I4, I5 and IB using the auxiliary relay M1 and memorize the state of inputs I2 and I3 using the auxiliary relay M2. The lamp is controlled by relays M1 and M2, used respectively as normally open contact and as normally closed contact.

Illustration:

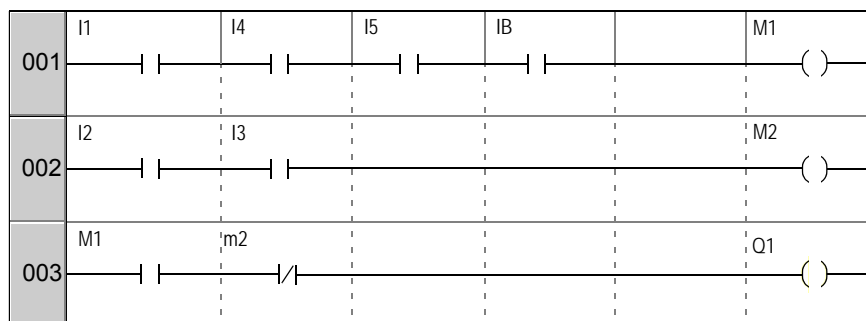
**Modifying the Mode of a Coil or a Contact**

To modify the operating mode of a coil or a contact from the front panel of the smart relay (the programming window displayed on screen), simply:

- Position the cursor on the symbol representing the coil mode or on the letter of the contact,
- Proceed as indicated in the paragraph *Modifying an element*, p. 44, to scroll through the possible modes for a coil or contact types possible (**M** for normally open contact, **m** for a normally closed contact).

**Initialization**

Status of contacts on program initialization:

- Normally open mode (direct state) is inactive,
- Normally closed mode (reverse state) is active.

**Latching**

By default, after a power failure, the relay is in the state that corresponds to program initialization.

To restore the state of the output backed up during power loss, the latching must be activated:

- From the front panel: From the **PARAMETERS** (see *PARAMETERS Menu, p. 51*) window,

or

- In the programming software: Enable the **Latching** option in the parameters window associated with the relay.
-

## Discrete (DISCR) Outputs

### Description

**Discrete Outputs** correspond to the smart relay output relay coils (connected to the actuators). These outputs are numbered from 1 to 9, then from A to G, according to the smart relay and any extensions.

Any Discrete output can be used, in the program, indifferently either as a coil or a contact.

### Use as a Coil

To use a Discrete output as a coil, four modes are available:

- Contactor mode,
- Impulse relay mode,
- Latch mode,
- Unlatch mode.

#### Contactor mode:

Symbol of a Discrete output, used as a coil in contactor mode:

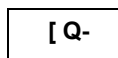

The coil is energized if the contacts to which it is connected are conducting. Otherwise it is not energized.

#### Impulse relay mode:

Symbol of a Discrete output, used as a coil in impulse relay mode:

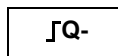

Pulse energization, the coil changes state on each pulse it receives.

Example: Switching a lamp on and off with a pushbutton:

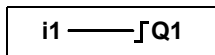

A push button is connected to input **I1** and a lamp to output **Q1**. Every time the button is pressed, the lamp switches on or off.

**Latch mode:**

Symbol of a Discrete output, used as a coil in latch mode:

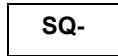

The **Set** coil, also called the latch coil, is energized as soon as the contacts to which it is connected are conducting, then stays set even if later the contacts are no longer conducting.

This behavior is identical to that of an RS logic flip-flop.

Example: Switching a lamp on and off with two pushbuttons: See Latching Mode below.

**Unlatch mode:**

Symbol of a Discrete output, used as a coil in unlatch mode:

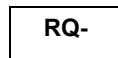

The **RESET** coil, also called the unlatch coil, is deactivated when the contacts to which it is connected are conducting. It remains inactive even if later the contacts are no longer conducting.

Example: Switching a lamp on and off with two pushbuttons: See Unlatch Mode

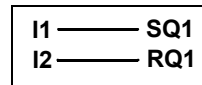

BPI1 is connected to input I1. BPI2 to input I2. The lamp is controlled by output Q1. The lamp turns on when pushbutton BPI1 is pressed, and it turns off when pushbutton BPI2 is pressed.

**Note:** Output use rule:

- An output may only be used at one single point in the program as a coil.
- If a SET coil is used for a Discrete output, it is advisable to provide a RESET coil for this output. The RESET coil takes priority over the SET coil.  
The use of a Set coil on its own is only justified for activating an alarm signal that can be reset only by an INIT + ON action from the program.

**Note:** For reasons of upward compatibility for programs operating with Zelio 1 smart relays, the four types of modes for any given Q output coil or M auxiliary relay can be used in the same wiring diagram in Zelio 2.  
In this case, the operating mode is determined by the coil activated first.

**Use as a Contact** An output can be used as an auxiliary contact as many times as necessary. This contact may use the direct state of the output (normally open mode) or its inverse state (normally closed mode), see below.

**Normally open mode:**

Symbol of a Discrete output, used as a contact in normally open mode:

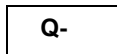

An output used as a **normally open** auxiliary contact corresponds to the use of the direct state of the output. If it is **powered**, the contact is said to be **conducting**.

**Normally closed mode:**

Symbol of a Discrete output, used as a contact in normally closed mode:

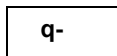

An output used as a **normally closed** auxiliary contact corresponds to the use of the reverse state (logical complement of the direct state) of the output. If it is **powered**, the contact is said to be **non-conducting**.

---

**Modifying the Mode of a Coil or a Contact**

To modify the operating mode of a coil or a contact from the front panel of the smart relay (the programming window displayed on screen), simply:

- Position the mouse on the symbol representing the coil output mode or on the letter of the contact representing the output,
  - Proceed as indicated in the paragraph *Modifying an element*, p. 44, to scroll through the possible modes for coils or contact types possible (**Q** for normally open contact, **q** for a normally closed contact).
- 

**Initialization**

Status of contacts on program initialization:

- Normally open mode (direct state) is inactive,
  - Normally closed mode (reverse state) is active.
- 

**Latching**

By default, after a power failure, the relay is in the state that corresponds to program initialization.

Activate latching to restore the state of the output backed up during power loss:

- From the front panel: from the **PARAMETERS** (see *PARAMETERS Menu*, p. 51) window,
- or
- In the programming software: Enable the **Latching** option in the parameters window associated with the output.
-

## Timers

---

### Description

Use the **Timers** function to delay, prolong and control actions over a predetermined period. Durations can be set using one or two preset values, according to the type of timer.

There are 11 types of timers:

- On delay (A),
- On delay, stop by reset (A),
- Off delay (C),
- On pulse one shot: Pulse calibrated on the command input (B) falling edge.
- Timing after pulse: calibrated on falling edge of the command input (W),
- Flasher unit, control held down synchronously (D),
- Flasher unit, Press to start/stop, Synchronous (D),
- Time on addition (T),
- A/C,
- Flasher unit, control held down asynchronously (L),
- Flasher unit, Press to start/stop, Asynchronous (I),

Refer to the Timing Diagrams paragraph for the description of different types of timers.

The smart relay has 16 timer function blocks, numbered from 1 to 9 then from A to G.

Each block has a reset input, a command input and an output used to indicate timer time-out.

---



## Use of Coils

Two coils are associated with each timer:

- Coil **TT**: **Command Input**,
- Coil **RC**: **Reset Input**,

The use of these coils is described below.

### Command input:

Symbol of the Command input coil of a timer:

**TT-**

Each type involves a specific operation, which can be used to manage all possible scenarios in an application.

### Reset input:

Symbol of the Command input coil of a timer:

**RT-**

Energization of the coil causes a reset of the current timer value: contact T is deactivated and the function is ready for a new timer cycle.

**Note:** this coil is only necessary for pulse start/stop type timers.

---

**Use as a Contact** The contact associated with the timer indicates whether the timer has stopped. It may be used as many times as necessary in the program. It may be used according to 2 modes: normally open or normally closed, described below.

**Normally open mode:**

Symbol of the normally open contact associated with a timer:

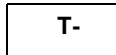

A normally open contact corresponds to the use of the direct state of the output of the Timer function block. If this output is **active**, the contact is said to be **conducting**.

**Normally closed mode:**

Symbol of the normally closed contact associated with a timer:

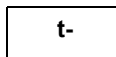

A normally closed contact corresponds to the use of the reverse state (logical complement of the direct state) of the output of the Timer function block. If this output is **active**, the contact is said to be **non-conducting**.

**Configuration from Front Panel**

The block's parameter settings can be accessed either when entering the command line or from the **PARAMETERS** menu if the block has not been padlocked.

The parameters to enter are the following:

- Timer type,
- Preset value(s),
- Time unit,
- Parameter lock,
- Latching.

**Type of timer:**

This parameter allows you to choose the type of timer function from among the 11 types available. Each type is represented by a letter:

- A: Active, control held down,
- a: Active, Press to start/stop,
- C: Off delay
- A/C: Combination of A and C,
- B: On pulse one shot: Pulse calibrated on the command input rising edge,
- W: Timing after pulse: Pulse calibrated on the command input falling edge,
- D: Flasher unit, control held down synchronously,
- d: Flasher unit, Press to start/stop, Synchronous,
- L: Flasher unit, control held down asynchronously,
- l: Flasher unit; Press to start/stop, Asynchronous
- T: Time on addition.

**Preset value:**

Depending on the type of timer, there can be 1 or 2 preset values:

- 1 only preset value (types: A, a, C, B, W, D, d and T):

**t**

: on-delay or off-delay according to type.

- 2 only preset value (types: A/C, L and I):

**A**

: Timer on-delay in the case of A/C type; active state in the case of flasher units L and I.

**B**

: Timer off-delay in the case of A/C type; inactive state in the case of flasher units L and I.

**Time unit:**

This is the time unit for the preset value. There are five possibilities:

Unit	Symbol	Form	Maximum value
1/100 of a second	<b>s</b>	00.00 s	00.00 s
1/10 of a second	<b>S</b>	000.0 s	00.00 s
Minutes : Seconds	<b>M : S</b>	00 : 00	99 : 99
Hour : Minute	<b>H : M</b>	00 : 00	99 : 99
Hours Only for type T.	<b>H</b>	0 000 h	9,999 h

**Parameter lock:**

Symbol of the **Parameter Lock** parameter:



Verrouillé



Non verrouillé

Locking prevents the modification of locked parameters from the front panel of the smart relay via the PARAMETERS menu.

**Latching:**

By default, if a power break occurs while a timer function block is running, any information on time already elapsed is lost. When the supply voltage returns, the time function block is reinitialized and ready for a new operating cycle.

If the application requires it, the time elapsed before the power break can be memorized using the **Latching** parameter.

Symbol of the **Latching** parameter:



This function is used to save the state of the timer's current values and memorize the elapsed time in the event of a power break.

**Illustration:** Configuring a counter from the front panel of the smart relay:

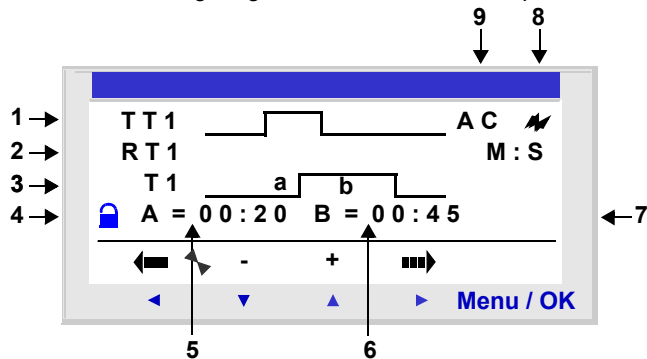

Description:

Number	Parameter	Description
1	<b>Command input</b>	Command input timing diagram.
2	<b>Reset input</b>	Reset input timing diagram.
3	<b>Timer output</b>	Timer output timing diagram.
4	<b>Parameter lock</b> 	This parameter is used to lock the counter parameters. When the block is locked, the preset value no longer appears in the PARAMETERS menu.
5	<b>Timer on-delay</b>	Timer on-delay of the A/C timer.
6	<b>Timer off-delay</b>	Timer off-delay of the A/C timer.
7	<b>Time unit</b>	Time unit for the preset value.
8	<b>Latching</b>	Backup of state of the current counter value in the event of a power cut.
9	<b>Timer type</b>	Type of timer used.

**Timing Diagrams** Timing diagrams are provided here to illustrate the various behaviors of the Timer function block, according to the type of timer chosen:

**Active, control held down (type A):**

The following diagram shows the operation of the type A timer:

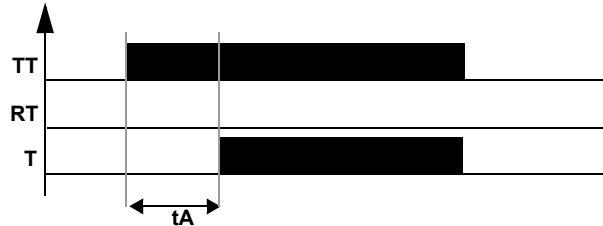

**Active, Press to start/stop (type a):**

The following diagram shows the operation of the type a timer:

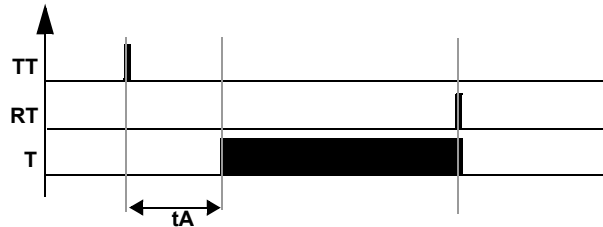

**Note:** each pulse on the TTx input resets the current timer value to 0.

**Off delay (type C):**

The following diagram shows the operation of the type C timer:

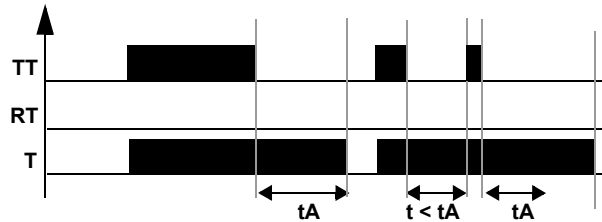

**A/C: Combination of A and C,**

The following diagram shows the operation of the type A/C timer:

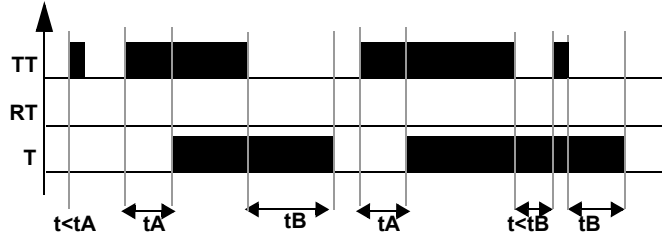
**On pulse one shot (type B):**

The following diagram shows the operation of the type B timer:

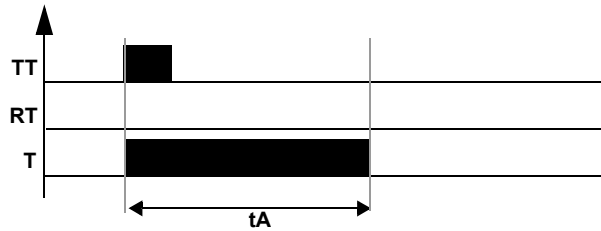
**Timing after pulse (type W):**

The following diagram shows the operation of the type W timer:

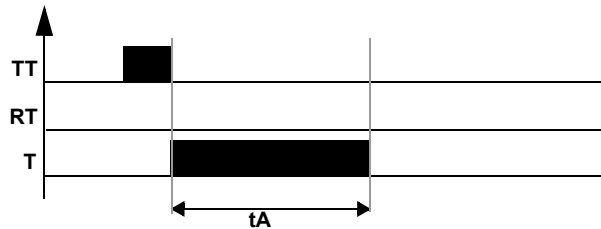

**Flasher unit, control held down synchronously (type D):**

The following diagram shows the operation of the type D timer:

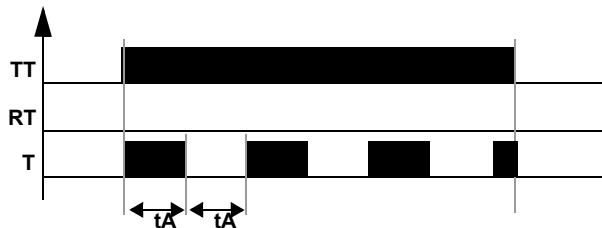
**Flasher unit, Press to start/stop, Synchronous (type d):**

The following diagram shows the operation of the type d timer:

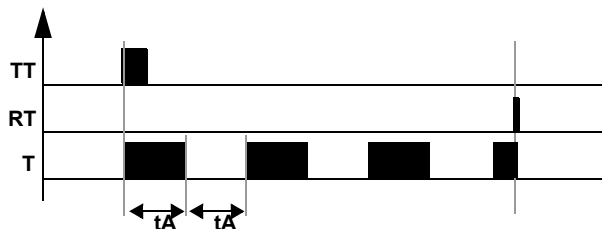

**Note:** each pulse on the TTx input resets the current timer value to 0.

**Flasher unit, control held down asynchronously (type L):**

The following diagram shows the operation of the type L timer:

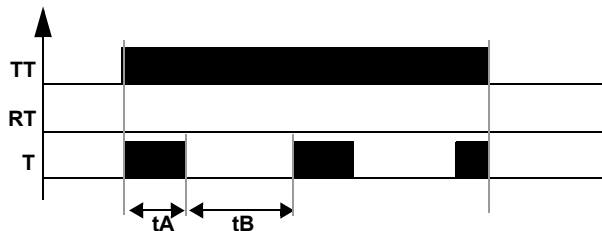

**Flasher unit, Press to start/stop asynchronously (type I):**

The following diagram shows the operation of the type I timer:

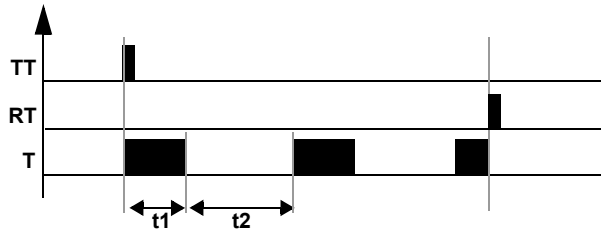

**Note:** each pulse on the TTx input resets the current timer value to 0.

**Time on addition (type T):**

The following diagram shows the operation of the type T timer:

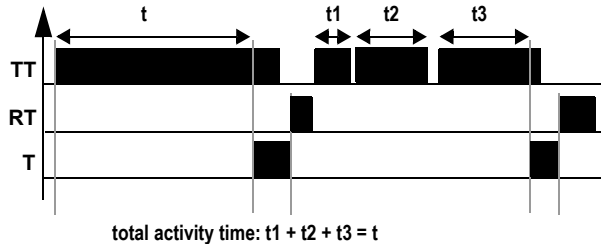

With addition type, the preset value can be reached:

- In one step:  $t$ ,
- In several steps:  $t_1 + t_2 + \dots + t_n$ .

### Modifying the Mode of a Coil or a Contact

To modify the operating mode of a coil or a contact from the front panel of the smart relay (the programming window displayed on screen), simply:

- Position the cursor on the symbol representing the coil mode or on the letter of the contact,
- proceed as described in the paragraph *Modifying an element*, p. 44, to scroll through the possible modes for a coil or contact types possible (**T** for normally open contact, **t** for a normally closed contact).

### Initialization

State of the contacts and current values on initialization of the program:

- The **normally open** mode (direct state) is **inactive**,
- the **normally closed** mode (inverse state) is **active**,
- the **current value(s)** is (are) **zero(s)**.



**Example 1**

Creating a timer device for a stairway.

The stairway light should remain on for two minutes and thirty seconds when one of the push buttons is activated.

On each floor, the buttons are linked to the **I1** input of the smart relay.

The stairway light is linked to the **Q4** output of the smart relay.

You would write the following program:

```

-----I1-----TT1
-----I2-----RT1
-----T1-----[Q4

```

To obtain the desired operation, you should use a type B timer (On pulse one shot), and configure the duration of the timer for 2 minutes 30 seconds. To thus configure the timer duration, choose the time units **M : S** and enter the value **02:30** for the preset value **t**.

**Illustration:** Timer's configuration screen:

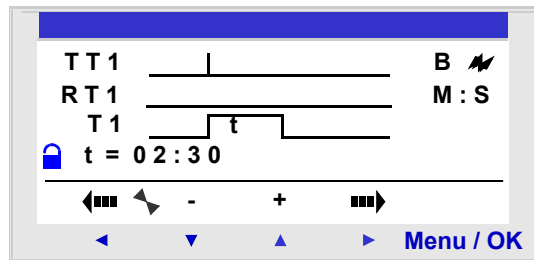

## Counters

---

### Description

The **Counters** function is used to upcount or downcount pulses. The smart relay has 16 timers, numbered from 1 to 9 then from A to G.

The **Counters** function can be reset to zero or to the preset value (depending on the chosen parameter) during use.

It may be used as a contact to find out whether:

- The preset value has been reached (upcounting mode **TO**),
  - The counter has reached 0 (downcounting **FROM**).
- 

### Use of Coils

Each timer has 3 associated coils:

- Coil **CC**: **Counting Pulse Input**,
- Coil **RC**: **Reset Initial Counter State Input**,
- Coil **DC**: **Counting Direction input**.

The use of these coils is described below.

#### Counting pulse input:

Symbol of the Counting Pulse Input coil of a timer:

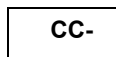

When used as a coil in a control diagram, this element represents a counting input for the function. Every time the coil is energized, the counter is incremented or decremented by 1 according to the counting direction chosen.

Example: Input counting pulses delivered by counter no. 1.

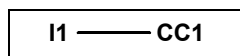

Every time input I1 is energized, the counter no. 1 is incremented by 1.

**Reset Initial Counter State input:**

Symbol of the Reset Initial Counter State Input coil:



When used as a coil in a control diagram, this element represents an input that resets the counting function to its initial state.

Energizing the coil has the following effect:

- Reset the current count value to **zero** if the count type is **TO** (up-counting from the preset value),
- Reset the current value to the **preset value** if the count type is **FROM** (down-counting from the preset value).

Example: Counter no. 1 reset to zero by pressing Z1 key.

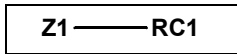

Every time key Z1 is pressed, the counter starts from 0.

**Counting direction input:**

Symbol of the Counting Direction Input coil of a timer:

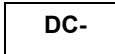

This input determines the counting direction according to its status. It:

- Downcounts if the coil is energized,
- Upcounts if the coil is not energized.

**Note:** By default, if this input is not wired, the automation function counts.

Example: Up/downcounts, depending on the status of smart relay input I2.

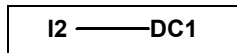

If the **I2** input is active, the automation function downcounts.

---

**Use as a Contact** The contact associated with the counter indicates whether the preset value (**TO** mode) or zero (**FROM** mode) has been reached.

It may be used as many times as necessary as many times as necessary in the program. It may be used according to 2 modes: normally open or normally closed, described below.

**Normally open mode:**

Symbol of the normally open contact associated with a counter:

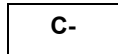

The contact is **conducting when:**

- The current counter value **has reached** the preset value, if the counter is in **TO** mode (upcounting mode),
- The current counter value **is equal to 0**, if the counter is in **FROM** mode (downcounting mode),

**Normally closed mode:**

Symbol of the normally closed contact associated with a counter:

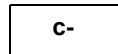

The contact is **conducting as long as :**

- The current counter value **has not reached** the preset value, if the counter is in **TO** mode (upcounting mode).
- The current counter value **is not equal to 0** if the counter is in **FROM** mode (downcount mode).

Example: Lighting a LED connected to counter no. 1 output (**TO** mode).

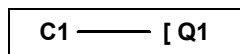

When the preset value has been reached: The LED is lit; otherwise it is off.

**Configuration from Front Panel**

The block's parameter settings can be accessed either when entering the command line or from the **PARAMETERS** menu if the block has not been padlocked.

The parameters to enter are the following:

- Type of counting,
- Preset value,
- Parameter lock,
- Latching.

**Type of counting:**

Symbol of the Type of counting parameter:

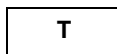

This parameter is used to select the operating mode of the counter:

- **TO**: upcounting towards the preset value.  
When the counter's current value is equal to the preset value, contact C of the counter is conducting.
- **FROM**: downcounting from the preset value.  
When the counter current value equals 0, counter contact C is conducting.

**Preset value:**

Symbol of the Preset Value parameter:

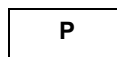

This value is between 0 and 32,767, and represents:

- The value to reach in the counting mode to the preset value (**TO** mode),
- the initial value in the downcounting mode from the preset value (**FROM** mode).

**Parameter lock:**

Symbol of the Parameter lock parameter:



Locking prevents the modification of locked parameters from the front panel of the smart relay via the **PARAMETERS** menu.

**Latching:**

Symbol of the Latching parameter:



This function is used to save the status of the counter's current values in the event of a power failure.

**Illustration:** Configuring a counter from the front panel of the smart relay:

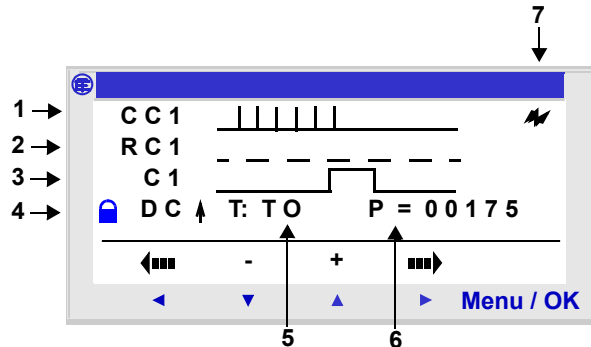

Description:

Number	Parameter	Description
1	<b>Command input</b>	Control input timing diagram (following pulse).
2	<b>Reset input</b>	Counter reset input timing diagram.
3	Counter output	Counter output timing diagram.
4	<b>Parameter lock</b> 	This parameter is used to lock the counter parameters. When the block is locked, the preset value no longer appears in the PARAMETERS menu.
5	<b>Type of counting</b>	Up-counting towards the preset value: <b>TO</b> mode or up-counting from the preset value: <b>FROM</b> mode.
6	<b>Preset value</b>	Counter preset value.
7	<b>Latching</b>	Backup of state of the current counter value in the event of a power failure.

**Current Counter Value**

The current value is the value at any given time resulting from the successive up/down counting actions that have occurred since the last time the counter was reset to its initial state.

This value is between 0 and 32767. Once these values have been reached, a down count will leave the value 0 and an upcount will leave the current value at + 32767.

**Timing Diagrams** In the timing diagrams the blue curves represent the current value of the counter: The following figure shows the operation of the counter in up-counting mode with toward the preset value: **TO** mode:

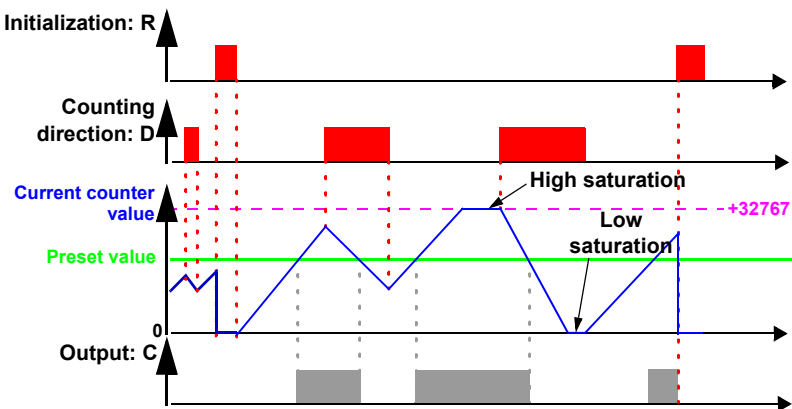

The following figure shows the operation of the counter in upcounting mode from the preset value: **FROM** mode:

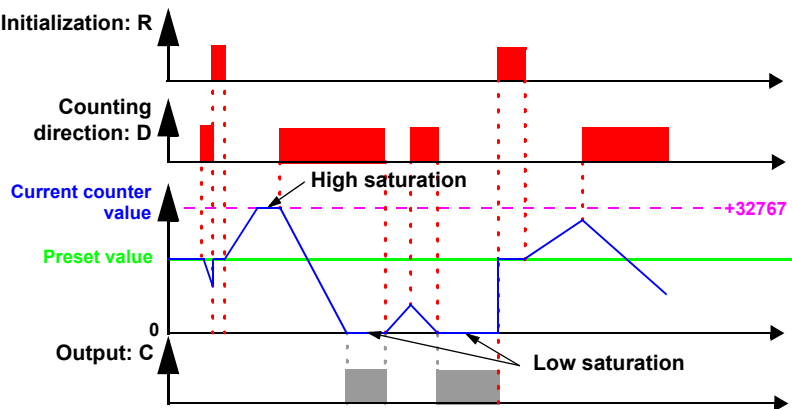

### Modifying the Mode of a Coil or a Contact

To modify the operating mode of a coil or a contact from the front panel of the smart relay (the programming window displayed on screen), simply:

- Position the cursor on the symbol representing the coil mode or on the letter of the contact,
- proceed as indicated in the paragraph *Modifying an element*, p. 44, to scroll through the possible modes for a coil or contact types possible (**C** for normally open contact, **c** for a normally closed contact).

**Initialization**

Status of the contacts and current value on initialization of the program:

- The **normally open** mode (direct state) is **inactive**,
- The **normally closed** mode (inverse state) is **active**,
- The **current value** is **zero**.

**Examples**

Below, three simple examples of the use of a counter (configured in upcounting mode toward the preset value):

Screen	Description
<pre> I1-----CC1 I2-----RC1 </pre>	<p><b>Upcounting and zero resetting:</b>  The counter is incremented each time input <b>I1</b> is activated.  The counter is reset each time input <b>I2</b> is activated.</p>
<pre> I1-----CC1            DC1 I2-----RC1 </pre>	<p><b>Downcounting and Resetting:</b>  The counter is decremented each time input <b>I1</b> is activated.  The counter is reset each time the <b>I2</b> input is activated.</p>
<pre> I1↑-----CC1 I3↓ I3-----DC1 I2-----RC1 </pre>	<p><b>Upcounting, Downcounting and Resetting:</b>  The counter is incremented each time input <b>I1</b> is activated. The counter is decremented each time the <b>I3</b> input is activated.  The counter is reset each time the input <b>I2</b> is activated.</p>



## Fast Counter

---

### Description

The **Fast Counter** function is used to count pulses up to a frequency of 1 kHz.

Use of the **K1** contact indicates:

- The preset value has been reached (upcounting),
- The value 0 has been reached (downcounting).

The **Fast counter** inputs are implicitly connected to the **I1** and **I2** smart relay inputs:

- A pulse (rising edge) on the **I1** input increments the counter,
- A pulse (rising edge) on the **I2** input decrements the counter.

These inputs should not be used on the wiring sheet.

The **Fast Counter** function can be reset to zero during use by the **RK1** coil. It is reset to:

- 0 if it is in up-count mode towards the preset value
- the preset value if it is in down-count mode from the preset value.

The counter only operates if the **TK1** confirmation coil is active.

Repetitive mode can be used with a time-delay value.

**Note:** Limit overrun:

- If the current value of the counter exceeds the upper limit: **+ 32,767**, it is set to **- 32,768**,
- if the current value of the counter exceeds the lower limit: **-32,767**, it is set to **+32,768**.

**Note:** This function block cannot be simulated.

---

**Use of Coils**

Two coils are associated with the fast counter:

- coil **TK1**: **Enable function input**,
- coil **RK1**: **Reset initial counter state input**.

The use of these coils is described below.

**Enable function input:**

Symbol of the Enable Function Input coil of the fast counter:

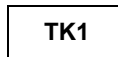

This element is used to confirm the counter. When this coil is active, each pulse on the **I1** input will increment the **Fast counter** and each pulse on the **I2** input will decrement it.

**Reset initial counter state input:**

Symbol of the Reset Initial Counter State Input:



This input resets the counter function to its initial state.

Energizing the coil has the following effect:

- reset the current count value to **zero** if the **count type** is **TO** (up-counting from the preset value).
- reset the current value to the **preset value** if the count type is **FROM** (down-counting from the preset value).

Example: Counter reset by pressing on the Z1 key:

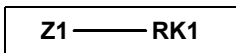

Each time the Z1 key is pressed, the counter is reinitialized.

**Use as a Contact** The contact associated with the fast counter indicates whether the preset value (**TO** mode) or zero (**FROM** mode) has been reached.

It may be used as many times as necessary as many times as necessary in the program. It may be used according to 2 modes: normally open or normally closed, described below.

**Normally open mode:**

Symbol of the normally open contact associated with the fast counter:

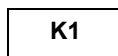

The contact is **conducting when:**

- the current value of the counter has **reached** the **preset value** (**TO** mode),
- the current value of the counter has **reached** the **0 value** (**FROM** mode).

**Normally closed mode:**

Symbol of the normally closed contact associated with the fast counter:

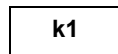

The contact is **conducting as long as :**

- the current counter value **has not reached** the preset value, if the counter is in **TO** mode,
- The counter current value **has not reached 0**, if the counter is in **FROM** mode,

Example: Lighting a LED connected to fast counter no. 1 output (**TO** mode).

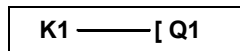

When the preset value has been reached: The LED is lit; otherwise it is off.

## Configuration from Front Panel

The block's parameter settings can be accessed either when entering the command line or from the **PARAMETERS** menu if the block has not been padlocked.

The parameters to enter are the following:

- Cycle type,
- Duration of pulse,
- Preset value,
- Type of counting,
- Parameter lock,
- Latching.

### Cycle type:

This parameter determines the behavior of the fast counter when it reaches the preset value (when it is in **TO** mode), or when it reaches the value zero (when it is in **FROM** mode):

The cycle type may be:

- **Single:** Reaching the preset value (**TO** mode) or the zero value (**FROM** mode) does not affect the current value of the counter.  
The current counter value changes on an on-going basis. The output is activated when the current value is greater than the preset value (**TO** mode) or when the current value is less than the preset value (**FROM** mode).
- **Repetitive:** In the **TO** mode, the current value is reinitialized when it reaches the preset value and in **FROM** mode, it is reset to the preset value when it reaches zero. The output is enabled following this reinitialization and remains active for a time that may be configured with the parameter: **Duration of pulse** (from 1 to 32,767 times 100 ms).

### Duration of pulse:

Symbol of the **Duration of pulse** parameter:

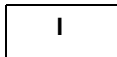

This parameter is only displayed if the cycle is repetitive. It determines the duration during which the fast counter remains active when the current value reaches the preset value (when it is in **TO** mode), or when it reaches the value zero (when it is in **FROM** mode).

This value must be between 1 and 32,767 (x 100 ms).

### Preset value:

Symbol of the **Preset value** parameter:

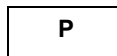

This value is between 0 and 32,767, and represents:

- The value to reach in the counting mode to the preset value (**TO** mode),
- the initial value in the down-count mode from the preset value (**FROM** mode).

**Type of counting:**

Symbol of the **Type of counting** parameter:

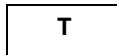

This parameter is used to select the operating mode of the counter:

- **TO:** up-counting towards the preset value.  
When the counter's current value is greater than or equal to the preset value, contact K1 of the fast counter is conducting.
- **FROM:** down-counting from the preset value.  
When the counter's current value is less than or equal to 0, contact C of the counter is conducting.

**Parameter lock:**

Symbol of the **Parameter Lock** parameter:



Verrouillé



Non verrouillé

Locking prevents the modification of locked parameters from the front panel of the smart relay via the PARAMETERS menu.

**Latching:**

Symbol of the **Latching** parameter:

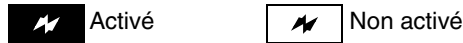

This function is used to save the status of the fast counter's current values in the event of a power failure.

**Illustration:** configuring a counter from the front panel of the smart relay:

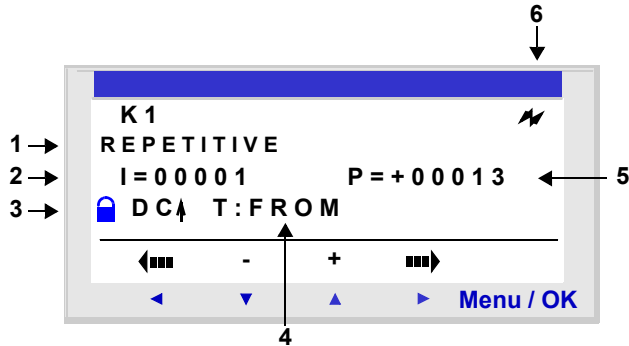

Description:

Number	Parameter	Description
1	<b>Cycle type</b>	Single/Repetitive
2	<b>Duration of pulse</b>	Only if the cycle is repetitive
3	<b>Parameter lock</b> 	This parameter is used to lock the counter parameters. When the block is locked, the preset value no longer appears in the PARAMETERS menu.
4	<b>Type of counting</b>	Counter configuration: Counting to the preset value ( <b>TO</b> ) or from the preset value ( <b>FROM</b> ).
5	<b>Preset value</b>	Counter preset value.
6	<b>Latching</b>	Backup of state of the current counter value in the event of a power cut.

**Current Counter Value**

Value at any given instant resulting from successive up/down counts since the last counter reset to its initial state.

If the current value of the counter exceeds the upper limit: +32,767, it is set to -32,768.

If the current value of the counter exceeds the lower limit: -32,767, it is set to +32,768.

**Timing Diagrams**

Timing diagrams are provided here to illustrate the various behaviors of the fast counter according to its parameters:

- up-counting function **TO**, in single cycle mode,
- down-counting function **FROM**, in single cycle mode,
- up-counting function **TO**, in repetitive cycle mode,
- down-counting function **FROM**, in repetitive cycle mode.

For the following 4 charts, the blue curve represents the current value of the counter. When it increases, it is because of pulses on I1 and when it decreases, it is because of pulses on I2.

**Up-Counting in Single Cycle Mode:**

The figure below illustrates the counter function in up-counting and single cycle mode:

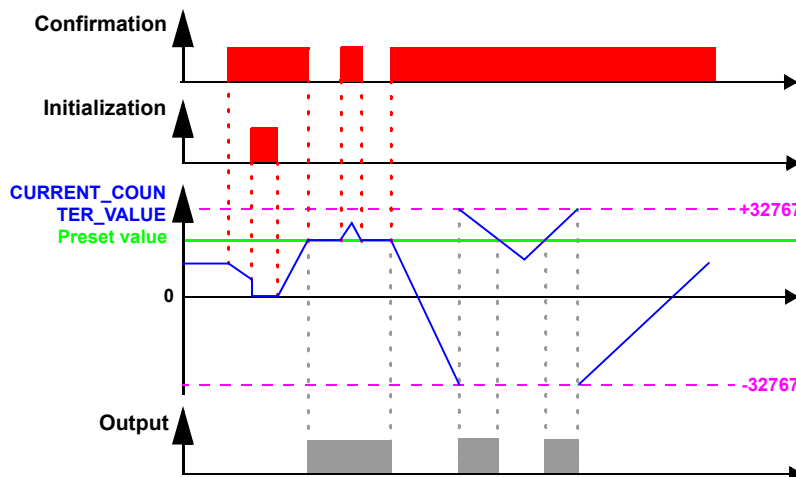

### Down-Counting in Single Cycle Mode:

The figure below illustrates the counter function in down-counting and single cycle mode:

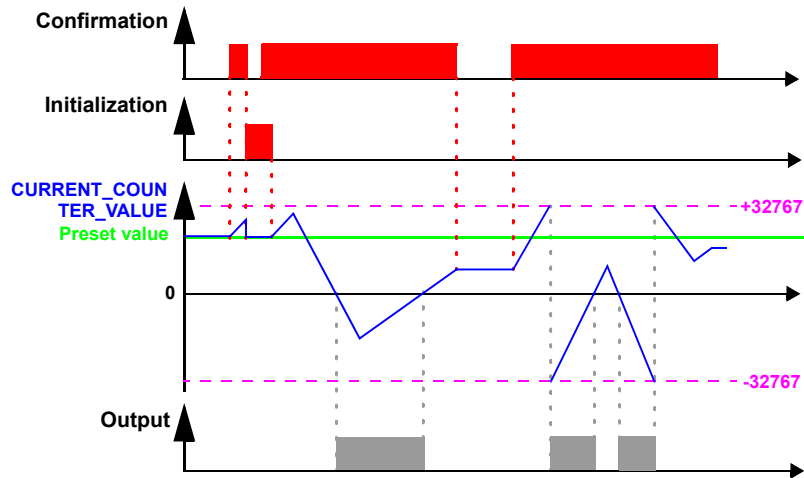

### Up-counting in Repetitive Cycle Mode:

The figure below illustrates the counter function in up-counting and repetitive cycle mode:

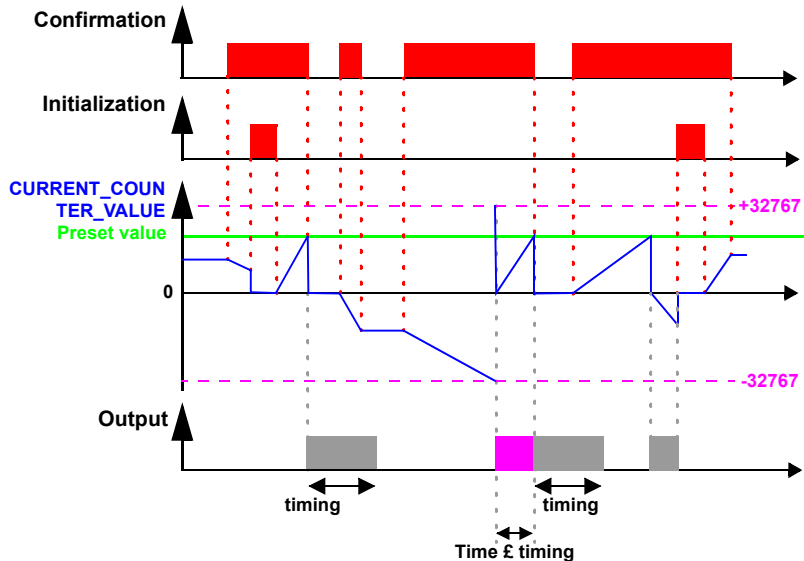

The output switches to the **Inactive** state when the predefined pulse duration value has run out. If the switch condition is Active before the switch to the Inactive state, the output pulse is extended by the **Duration of pulse** (Timing).



**Down-Counting in Repetitive Cycle Mode:**

The figure below illustrates the counter function in down-counting and repetitive cycle mode:

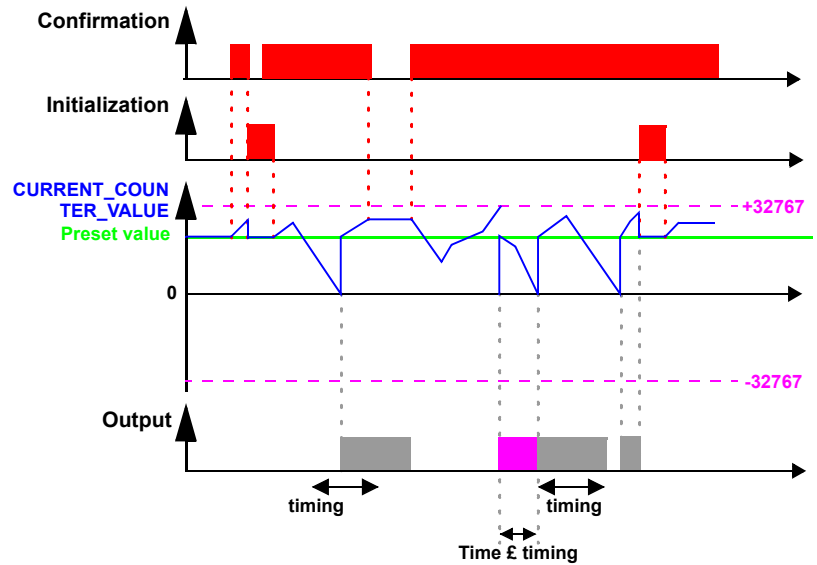

The output switches to the **Inactive** state when the predefined pulse duration value has run out. If the switch condition is Active before the switch to the Inactive state, the output pulse is extended by the **Duration of pulse** (Timing).

---

**Modifying the Mode of a Coil or a Contact**

To modify the operating mode of a coil or a contact from the front panel of the smart relay (the programming window displayed on screen), simply:

- Position the cursor on the symbol representing the coil mode or on the letter of the contact,
- Proceed as indicated in the paragraph *Modifying an element,, p. 44*, to scroll through the possible modes for a coil or contact types (**K** for normally open contact, **k** for a normally closed contact).

---

**Initialization**

Status of the contacts and current value on initialization of the program:

- The **normally open** mode (direct state) is **inactive**,
- the **normally closed** mode (inverse state) is **active**,
- The **current value** is **zero**.

---

**Example**

Below, an example of using a fast counter: output Q1 is set to 1 when the fast counter is set to 1; the counter is activated by input I3 and reset to 0 by input I4.

K1-----[Q1
I3-----TK1
I4-----RK1

## Counter Comparators

---

### Description

This function is used to compare the current counting values of two counters or of a counter and a constant value.

**Note:** The **Counter Comparators** function block can only be configured from the programming software in **Ladder Entry** mode.  
See on-line help of the programming software for more information.

### Use as a Contact

The counter comparator indicates whether the chosen condition is verified. It is used as a contact, in normally open mode or in normally closed mode.

#### Normally open mode:

Symbol of the counter comparator, in normally open mode:

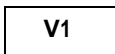

The contact is **conducting** when the condition is **verified**.

#### Normally closed mode:

Symbol of the counter comparator, in normally closed mode:

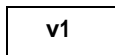

The contact is **conducting** when the condition **is not verified**.

### Configuration from the Front Panel

The **Counter Comparators** function block cannot be configured from the front panel of the smart relay. This function must be configured from the programming software. See on-line help of the programming software for more information on configuration.

### Modifying the Mode of a Coil or a Contact

To modify the operating mode of a coil or a contact from the front panel of the smart relay (the programming window displayed on screen), simply:

- Position the cursor on the symbol representing the coil mode or on the letter of the contact,
- Proceed as described in the paragraph *Modifying an element*, p. 44, to scroll through the possible modes for a coil or possible contact types (**V** for normally open contact, **v** for a normally closed contact).

### Initialization

Status of contacts on program initialization:

- Normally open mode (direct state) is inactive,
  - Normally closed mode (reverse state) is active.
-

## Analog Comparators

---

### Description

The **Analog Comparators** function block is used to:

- Compare a measured analog value with an internal reference value.
- Compare two measured analog values.
- Compare two measured analog values with hysteresis parameter.

The result of this comparison is used in the form of a contact.

Analog automation functions can be used for smart relays with a real time clock and DC power supply, and with mixed DISCR/Analog inputs.

The following indicate the existence of mixed Discrete/Analog inputs:

- The existence of inputs numbered from **IB** to **IG** (maximum configuration). These inputs are used to receive analog signals from 0.0 V to 9.9 V inclusively.
- The presence of the **Analog Comparators** function in the toolbar of the programming software.

These smart relays have 16 **Analog Comparators** function blocks, numbered from 1 to 9 then from A to G.

---

### Use as a Contact

The contact shows the position of a measured analog value in relation to a reference value or to another measured value.

It may be used as many times as necessary in the program. It may be used according to 2 modes: normally open or normally closed, described below.

#### Normally open mode:

Symbol of the normally open contact associated with a, Analog Comparator:

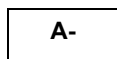

The contact is **conducting** when the comparison condition is **verified**.

#### Normally closed mode:

Symbol of the normally closed contact associated with an analog comparator:

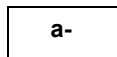

The contact is **conducting** when the condition is **not verified**.

---

**Configuration  
from Front Panel**

The simple comparison formula is as follows:

$$x1 <\text{Comparison Operator}> x2$$

The comparison formula, for a comparison with hysteresis:

$$x1 - H \leq x2 \leq x1 + H$$

The parameters to enter are the following:

- Values to compare,
- Comparison operator,
- Reference value,
- Hysteresis parameter,
- Parameter lock.

**Values to compare:**

Symbol of values to compare:

x1

x2

These variables are chosen from among the following:

- Numbered analog inputs from IB to IG (maximum configuration),
- Reference value R

**Comparison operator:**

The comparison operator is chosen using the number in the upper right-hand side of the screen.

The table below provides the correspondence between this number and the comparison formula that will be used:

Number	Comparison formula
1	$x1 > x2$
2	$x1 \geq x2$
3	$x1 = x2$
4	$x1 \neq x2$
5	$x1 \leq x2$
6	$x1 < x2$
7	comparison with hysteresis: $x1 - H \leq x2 \leq x1 - H$

**Reference value:**

Symbol of the reference value:



The reference value is a constant to which a measured value may be compared. It must be between 0 and 9.9.

**Hysteresis parameter:**

Symbol of the hysteresis parameter:

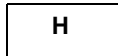

The hysteresis parameter is a constant used to define an interval in which the 2x variable should be found for the comparator to be active. Its value must be between 0 and 9.9.

**Parameter locking:**

Symbol of the Parameter lock parameter:



Verrouillé



Non verrouillé

Locking prevents the modification of locked parameters from the front panel of the smart relay via the PARAMETERS menu.

**Illustration:**

Configuration from the front panel of the smart relay, of the hysteresis-type comparator with constant reference value:

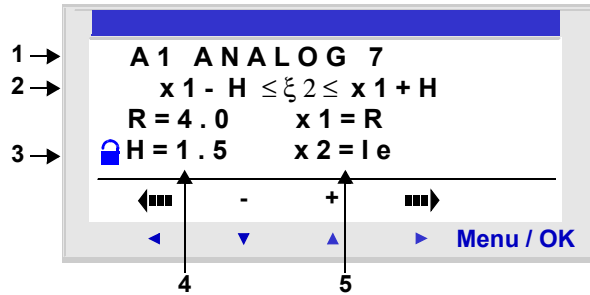

In this case: The comparison condition is verified when the power to the input terminal Ie is between 2.5 V and 5.5 V.

Configuration of a single comparator from the front panel:

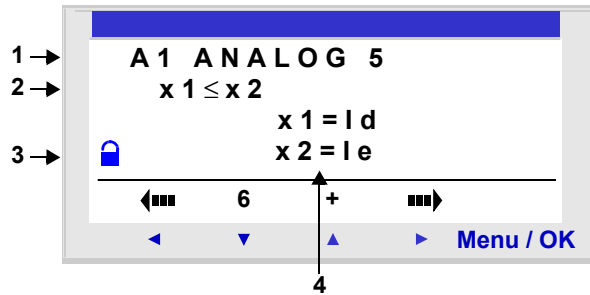

(If neither x1 nor x2 are not set to R, parameter R does not appear.)

Description:

Number	Parameter	Description
1	Type of comparison	The number that follows ANALOG corresponds to the selected comparison operator.
2	Comparison formula	Formula used for comparison.
3	Parameter lock 	Locking prevents locked parameters from being modified from the front panel of the smart relay using the PARAMETERS menu.
4	Parameters of the comparison formula	Parameters of the comparison formula.

### Modifying the Mode of a Coil or a Contact

To modify a contact from the front panel of the smart relay (the programming window is displayed on the screen), simply:

- Place the cursor over the letter of the contact,
- Proceed as indicated in the paragraph *Modifying an element,, p. 44*, to scroll through the possible contact types (**A** for a normally open contact, **a** for a normally closed contact).

### Initialization

Status of the contacts and current value on initialization of the program:

- The **normally open** mode (direct state) is **inactive**,
- The **normally closed** mode (inverse state) is **active**.

### Example

A heating resistance is to be triggered by the smart relay **Q1** output when the temperature is below 20° C.

A temperature probe is used, providing a 0 to 10 volt signal for a -10° to +40° C temperature range. A temperature of 20° C corresponds to a voltage level of 6 volts on the probe.

You would write the following Ladder program:

```
A1-----[Q1]
```

Using the following parameters for the A1 comparator:

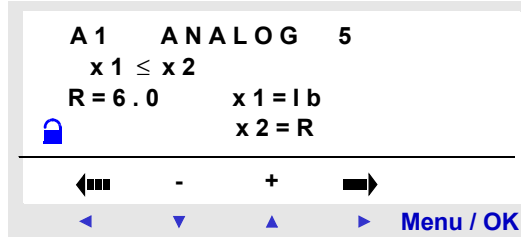

The comparison operator no. 5 is chosen, that is ≤.

The values to compare are chosen: The analog input IB (to which the temperature probe is connected) for the first, the reference value R for the second.

The reference value is set to 6.

The analog comparator is thus active when the power measured on the analog input IB is less than or equal to 6 V. This is when the probe measures a temperature less than or equal to 20 °C.



## Clocks

---

### Description

Use the **Clocks** function to validate the time ranges during which actions can be executed. The smart relay has 8 **Clocks** function blocks numbered from 1 to 8. Each of these has four programming ranges and behaves like a weekly programmer. The **Clocks** function blocks are used like contacts.

---

### Use as a Contact

This contact may use the direct state of the Clock function block (normally open mode) or its inverse state (mode normally closed), see below.

#### Normally open mode:

Symbol of the normally open contact, representing a clock:

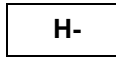
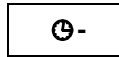

The contact is **conducting** when the clock **is in a validity period**.

#### Normally closed mode:

Symbol of the normally closed contact, representing a clock:

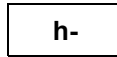



The contact is **conducting** when the clock **is not in a validity period**.

---

**Configuration from Front Panel**

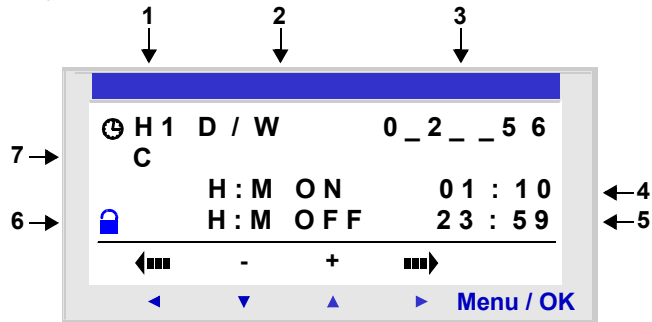
Configuration screen of a Clock function block from the front panel of the smart relay:



Number	Parameter	Description
1	<b>Clock module number</b>	8 clocks available, numbered 1 to 8.
2	<b>Type of date configuration</b>	<b>D/W</b> : Days of the Week,
3	<b>Validity day (D/W type)</b>	Validity day: <ul style="list-style-type: none"> <li>● 0: Monday,</li> <li>● 1: Tuesday,</li> <li>● ...</li> <li>● 6: Sunday.</li> </ul> <b>Unselected</b> days are indicated by a <b>_</b> .
4	<b>Start time (D/W type)</b>	This is the operation start time, in <b>Hour: Minute</b> format (00.00 to 23:59).
5	<b>Stop time (D/W type)</b>	This is the operation end time, in <b>Hour: Minute</b> format (00.00 to 23:59).
6	<b>Parameter lock</b> 	Locking prevents locked parameters from being modified from the front panel of the smart relay using the PARAMETERS menu.
7	<b>Operating ranges</b>	4 operating ranges are available: A, B, C, D. In operation, these ranges are cumulative: The block is valid over all selected ranges.

If the clock is set to ON on Monday at 23:00 and set to OFF on Monday at 1:00, then it does not change to OFF on Tuesday at 1:00 but effectively on the following Monday at 1:00. Moreover, if no other command has been made, the clock remains positioned at ON all other days of the week.

**Combining Modes**

Programming modes can be mixed for the same clock.

Example: Using the four clock ranges with different modes.

Range	Program
<b>A: time range</b>	Every day from Monday to Friday, start at 8.00 and end at 18.00.
<b>B: Day/Night</b>	Every day from Tuesday to Thursday: start at 22.00 and end the following day at 6.00.
<b>C: interval</b>	Start on Friday at 20.00.
<b>D: Interval</b>	End on Monday at 03.00.

---

**Modifying the Mode of a Coil or a Contact**

To modify the operating mode of a coil or a contact from the front panel of the smart relay (the programming window displayed on screen), simply:

- Place the cursor over the letter of the contact,
  - Proceed as indicated in the paragraph *Modifying an element*, p. 44, to scroll through the possible contact types (**H** for a normally open contact, **h** for a normally closed contact).
-

**Example**

You wish to control a device connected to the Q2 output of the smart relay. You want it to be active on the following two clock ranges:

- from Monday to Saturday, from 09:00 to 13:00.
- from Monday to Friday, from 15:00 to 19:00,

For this, the **H1** Clock block is used and the following wiring diagram is created:

H1-----[Q2

When entering the H1, Clock block, configure the operational ranges **A** and **B** as described in the table below:

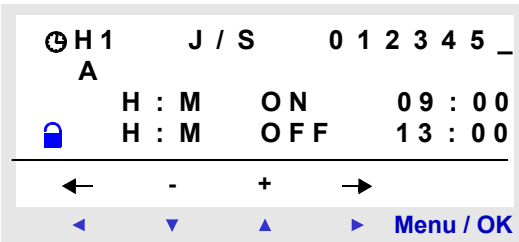
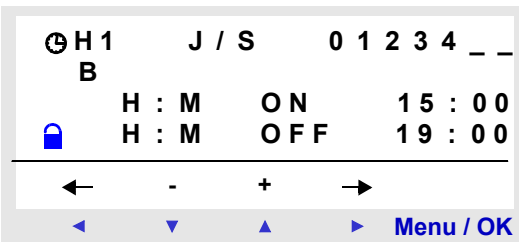
Screen	Comment
	<p><b>First Slot A:</b> From Monday to Saturday, from 09:00 to 13:00.</p>
	<p><b>Second Slot B:</b> From Monday to Friday, from 15:00 to 19:00,</p>

## Texts

---

### Description

The **Text** automation function is used to display texts and/or digital values (current value, preset value, etc.) on the LCD instead of the inputs-outputs screen.

The smart relays have 16 **Text** blocks, numbered from 1 to 9 then from A to G. These function blocks are used as coils.

The maximum number of variables that can be displayed per **Text** block is 4.

Up to 16 **Text** blocks may be used (TX1 to TXG) simultaneously in one program, but only the block with the highest number is displayed.

Pressing the **Shift** and **Menu/OK** keys in order and simultaneously, switches the display from the **Text** screen to the inputs-outputs screen.

Pressing the two keys again simultaneously returns the display to the **Text** screen.

<p><b>Note:</b> The <b>Text</b> blocks are only programmable from the programming software (see the on-line help for the programming software for more information).</p>
--

**Used as a Coil**

Two coils are associated with each **Text** block:

- **Display Activation** coil,
- **Display Deactivation** coil.

The use of these coils is described below.

**Display Activation**

Symbol of the Display Activation coil of a **Text** function block:

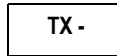

This coil displays on the screen the text and/or the values of the associated **Text** block when the contacts that are connected are conducting.

**Display deactivation**

Symbol of the Display Deactivation coil of a **Text** function block:

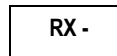

This coil deactivates the display of the text and/or the values of the associated **Text** block when the contacts that are connected are conducting. The display returns to the inputs-outputs screen.

Example:

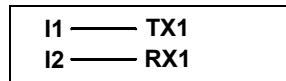

Activation of input **I1** displays the text on the LCD. Activating input **I2** makes the text disappear.

**Parametering**

The **Text** function blocks are only programmable from the programming software, see the on-line help for the programming software for more information.

## LCD Screen Backlighting

---

### Description

The **LCD screen backlighting** output is used to control the backlighting of the LCD by a program.

In STOP and RUN modes, the LCD screen is lit for 30 seconds when the user presses any of the buttons on the front panel.

---

### Used as a Coil

Used as a coil, it lights up the LCD when the contacts to which it is connected are conducting.

Symbol of the coil of the LCD screen Backlighting function:

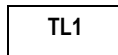

The screen is lit if this coil is active.

---

## Change to Summer / Winter Time

### Description

The output of this function is in an OFF state over the entire duration of winter time, and switches to ON for the entire duration of summer time.

By default, there is no change in winter / summer time. This function must be activated, either from the programming software, or from the front panel of the smart relay.

To activate this function, from the programming software, proceed as follows:

- display the **Program configuration** window: **:Edit** → **Program Configuration** menu,
- Select the **Date format** tab,
- Check the **Activate Summer/Winter Time Change** box,
- Define the time change dates:
  - Either using one of the predefined geographic zones,
  - Or by manually configuring the date (month/Sunday).

To activate this function from the front panel of the smart relay, proceed as described in chapter *CHANGE SUMMER/WINTER Menu, p. 99*.

**Note:** This function is only available for smart modules that contain a real-time clock.

### Access

This  function is accessible from the **LD** function bar.

### Use as a Contact

When used as a contact, this element indicates the current season.

It may be used as many times as necessary in the program. It may be used according to 2 modes: normally open or normally closed, described below.

#### Normally open mode:

Symbol of the normally open contact associated with a Change summer / winter time function block:

**W 1**

The contact is active for the entire duration of summer time.

#### Normally closed mode:

Symbol of the normally closed contact associated with a Change summer/winter time function block

**w 1**

The contact is active for the entire duration of winter time.



### Parameters

The following operating modes are possible:

- **No**: no change,
  - **Automatic change**: Dates are preset according to geographic zone:
    - **EUROPE**: Europe,
    - **USA**.
  - **OTHER ZONE**: The change is automatic, but you must specify the month: **M** and the Sunday: **S** (1, 2, 3, 4 or 5 ) on which the summer/winter change takes place.
- 

### Modifying the Mode of a Coil or a Contact

In the programming software, to modify the state of a contact, simply position the cursor on it, then:

- With the mouse: right-click to display a list of possible states (left-click to validate),
- With the space bar: Scroll through all possible states.

To modify a contact from the front panel of the smart relay (the programming window displayed on screen), simply:

- Place the cursor over the letter of the contact,
  - Proceed as indicated in the paragraph *Modifying an element*, p. 51, to scroll through the possible contact types (**W** for a normally open contact, **w** for a normally closed contact).
- 

### Initialization

State of the contacts and current value on initialization of the program:

- The **normally open** mode (direct state) is **inactive**,
  - The **normally closed** mode (inverse state) is **active**.
-

## Modbus Inputs/Outputs

**Description** A Modbus **SR3 MBU01BD** extension module may be added onto an extensible smart relay.

In **LD** mode, the application cannot access the four 16-bit data exchange words. Data transfer between master and slave is implicit and completely transparent.

**Note:** The Modbus module only operates in Modbus slave mode.

**Parameters** The Modbus module can be configured only from the programming software (see the on-line help of the programming software for more information).

**Words to be sent to master** Writing these words to the master is automatically performed by duplication of the status of the discrete I/Os as follows:

																Modbus Address(Hexa) ↓			
IG	IF	IE	ID	IC	IB	IA	I9	I8	I7	I6	I5	I4	I3	I2	I1	0x0014			
0	0	0	0	0	0	0	0	0	0	IR	IQ	IP	IN	IL	IK	IJ	IH	0x0015	
0	0	0	0	0	0	0	0	0	0	0	0	0	0	0	0	0	0	0	0x0016
0	0	0	0	0	0	0	0	0	0	0	0	0	0	0	0	0	0	0	0x0017
<b>Most significant byte</b>										<b>Least significant byte</b>									

**I1 to IG:** discrete input states for the SR3 B261BD base.

**IH to IR:** discrete input states for the SR3 XT141BD extension.

**Q1 to QA:** Discrete output states for the SR3 B261BD base.

**QB to QG:** Discrete output states for the SR3 XT141BD extension.

**Words sent by the master.** The words sent by the master are not processed by the smart relay.

These 4 16-bit words have the following addresses (Hexa): 0x0010 / 0x0011 / 0x0012 / 0x0013.

## Message

---

### Description

When activated, the **Message** function block can be used to:

- Send alarm messages to mobile phones, the Zelio Logic Alarm alarm operations tool or Email addresses via the SR2COM01 communication interface
- Provide remote access to a DISCR and/or a digital variable for reading or modifying them.

There are 28 **Message** function blocks numbered from S1 to S9, then from SA to SV.

**Note:** The **Message** function is only available on smart relays with clocks and when a SR2COM01 communication interface is added.  
For further information on the configuration of the SR2COM01 communication interface, see the programming software on-line help.

### Use of the Coil

#### Command input

Symbol of the Command Input coil of a **Message** function block:

TS-

This coil sends the configured alarm message in the associated **Message** function block, when it is activated.

Depending on the configuration of the **Message** function block, the coil may be activated during detection on its input, by a transition:

- From Inactive to Active State (by default),
- From Active to Inactive State.

See on-line help for the programming software for more information on configuring the **Message** function block.

---

**Use as a Contact** The contact associated with the **Message** function block indicates whether the function block is activated.

It may be used as many times as necessary as many times as necessary in the program. It may be used according to 2 modes: normally open or normally closed, described below.

**Normally open mode:**

Symbol of the normally open contact associated with a **Message** function block:

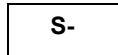

The contact is **conducting when** the function block is **activated**.

**Normally closed mode:**

Symbol of the normally closed contact associated with a **Message** function block:

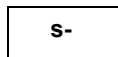

The contact is **conducting as long as** the function block is **not activated**.

Example: Lighting-up of a LED connected to the **Message** No.1 function block output

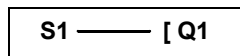

When function block no. 1 is activated, the associated alarm message is sent and the LED lights up, otherwise it is off.

**Modifying the Mode of a Coil or a Contact**

To modify the operating mode of a coil or a contact from the front panel of the smart relay (the programming window displayed on screen), simply:

- Position the cursor on the symbol representing the coil mode or on the letter of the contact,
- Proceed as described in the paragraph *Modifying an element,, p. 44*, to scroll through the possible modes for a coil or contact types possible (**S** for normally open contact, **s** for a normally closed contact).

**Configuration from the Front Panel**

The **Message** function block cannot be configured from the front panel of the smart relay. This function must be configured from the programming software.

See on-line help of the programming software for more information on configuration.

**Initialization**

Status of contacts on program initialization:

- The **normally open** mode (direct state) is **inactive**,
- The **normally closed** mode (inverse state) is **active**.

---

# Creating and Debugging an Application



---

## Presentation

### Subject of this Section

This section describes, using detailed examples, how to create, debug and save an application.

### What's in this Part?

This part contains the following chapters:

Chapter	Chapter Name	Page
17	Implementing a Basic Application	149
18	Debugging an Application	165
19	Backup and Transfer of Ladder Diagrams"	175
20	Sample Application	177

---

---

# Implementing a Basic Application

17

---

## Presentation

### Subject of this Chapter

This chapter describes in detail the implementation of a basic application from the front panel of the smart relay.

### What's in this Chapter?

This chapter contains the following topics:

Topic	Page
Presentation of Ladder Diagrams	150
Using the Reverse Function	152
Notation Used by the Smart Relay	155
Application: Implementing a Two-way Switch	157

---

## Presentation of Ladder Diagrams

### Description

In this section, we will use a simple example to understand how a ladder diagram works: A two-way switch.

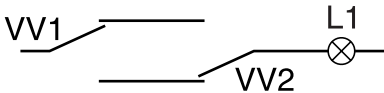
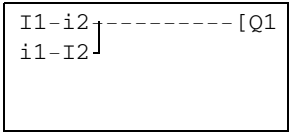
Normal electrical diagram	Ladder diagram
	
<p>The two position switches <b>VV1</b> and <b>VV2</b> control turning lamp <b>L1</b> on and off.</p>	<p><b>I1</b> and <b>I2</b> are two contacts representing inputs 1 and 2 on the smart relay.  <b>Q1</b> is a coil that corresponds to output 1 from the smart relay.</p>

**Module Wiring**

Below, an illustration of smart relay wiring:

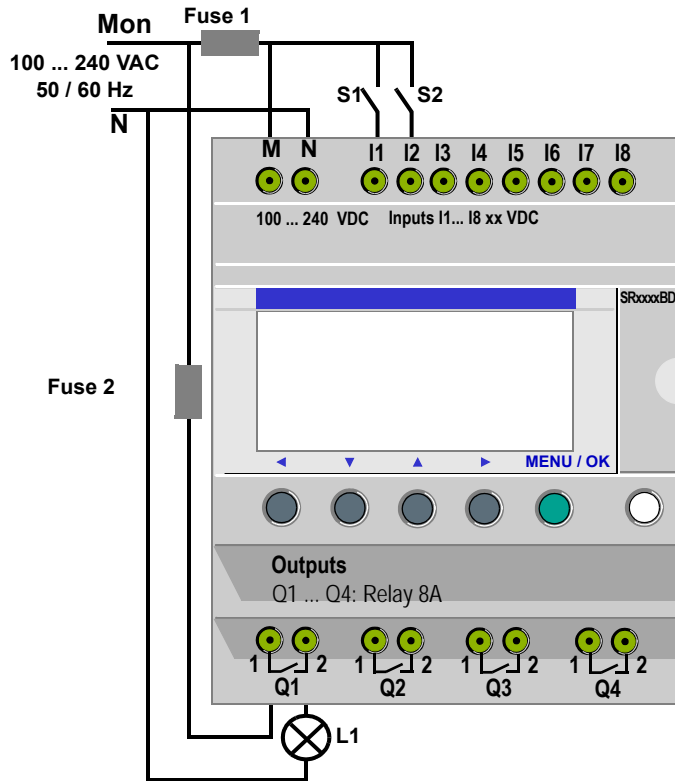
**Application Operation**

Using a smart relay means that ordinary switches (with open or closed positions) can be used in place of two position switches.

The switches are identified as **S1** and **S2** in the wiring diagram above.

**S1** and **S2** are connected to inputs **I1** and **I2** on the smart relay.

The operating principle is as follows: Each time the status of inputs **I1** and **I2** changes, the status of output **Q1** also changes which controls the lamp **L1**.

The ladder diagram uses basic functions, for example placing contacts in parallel and in series, as well as the reverse function identified as **i1** and **i2** (see *Using the Reverse Function*, p. 152).

**Note:** The implementation of a two-way switch is optimum when impulse relay coils are used (see *Discrete (DISCR) Outputs*, p. 98).



## Using the Reverse Function

---

### **Description**

The reverse function, noted **i** in the smart relay is used to obtain the reverse state of input **I** wired on the smart relay.

To illustrate how this function works, we shall use a simple example:

---

**Practical Example**

Below is the electrical diagram of the example and an illustration of the smart relay wiring:

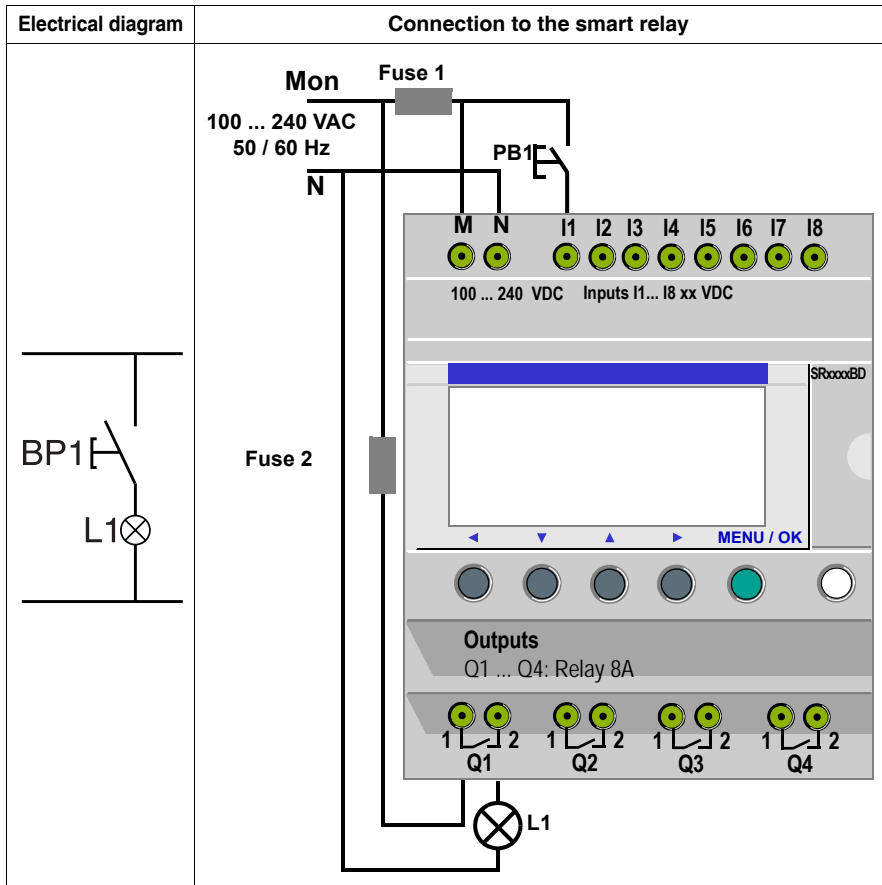

Depending on the ladder diagram, two solutions are possible:

Ladder diagram 1: Light off when idle	Ladder diagram 2: Light on when idle
<p style="text-align: center;">I1-----[Q1</p>	<p style="text-align: center;">i1-----[Q1</p>
<p><b>I1</b> corresponds to the true image of <b>BP1</b>, pressing <b>BP1</b> activates input <b>I1</b>, so that the <b>Q1</b> output is activated and the lamp <b>L1</b> turns on.</p>	<p><b>i1</b> corresponds to the reverse image of <b>BP1</b>, pressing <b>BP1</b> activates input <b>i1</b> and therefore contact <b>i1</b> is disabled, output <b>Q1</b> is disabled and the lamp <b>L1</b> turns off.</p>

**General Case**

The table below illustrates the operation of a pushbutton connected to the smart relay. Pushbutton **BP1** is connected to input **I1** and lamp **L1** is connected to output **Q1** on the smart relay.

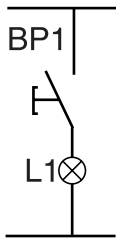
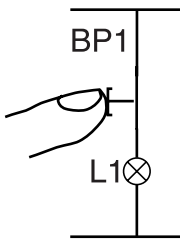
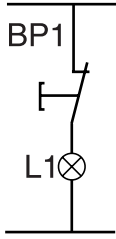
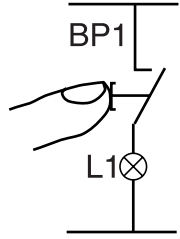
	Off delay		Operating	
	Electrical diagram	Smart relay symbols	Electrical diagram	Smart relay symbols
Pushbutton normally open		$I1 = 0$ $i1 = 1$		$I1 = 1$ $i1 = 0$
Pushbutton normally closed		$I1 = 1$ $i1 = 0$		$I1 = 0$ $i1 = 1$

**Note:** The reverse function may be applied to all of the contacts in a ladder diagram, whether they represent outputs, auxiliary relays or function blocks.

## Notation Used by the Smart Relay

### Description







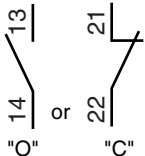
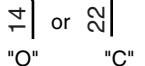

The smart relay has a four line display used to show ladder diagrams.

**Note:** The programming software allows you represent ladder diagrams in three different formats:

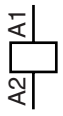
- Electrical symbols,
- Ladder symbols,
- Smart relay symbols,

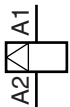
### Equivalencies Between Notations

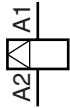
In the table below are the equivalencies between representations of the most common elements of the ladder language, in the 3 formats:

Electrical symbol	Ladder symbol	Smart relay symbols
 <p>or</p> 	 <p>or</p> 	<p>I1 or i1</p> <p>I1 or i1</p>
		<p>[Q1</p>
 <p>Set coil (SET)</p>		<p>SQ1</p>
 <p>Reset coil (RESET)</p>		<p>RQ1</p>

## Other Elements

Other elements are also available using a smart relay, such as:

- **Timer function block:** Used to delay, prolong and control and action for a set length of time,
- **Counter function block:** Used to count the pulses received on an input,
- **Clock function block:** Used to trigger or release actions on precise days or at precise times,
- **Analog comparator function block:** Used to compare an analog value with a reference value or with another analog value after allowing for a hysteresis factor,
- **Auxiliary relays:** These are used to save or relay the status of the smart relay,
- **Zx keys:** After confirming this function, Z keys may be used as pushbuttons,
- **Fast counter function block:** The fast counter function is used to count pulses up to a frequency of 1 kHz.
- **LCD screen back-light function block:** This is used to control the backlighting of the LCD by a program,
- **Summer/winter time change function block:** The output of this function is in an OFF state over the entire duration of winter time, and switches to ON for the entire duration of summer time,
- **Counter Comparator block:** This function is used to compare the current counting values of two counters,
- **Text block:** This is used to display text or numerical values (current value or preset value).

**Note:** Blocks **Counter Comparator** and **Text** are not programmable from the front panel.

**Note:** For the list of all ladder diagram elements available when using smart relays, as well as details on their functions and parameters, see the chapter entitled *LD Language Elements*, p. 87.

## Application: Implementing a Two-way Switch

### Description

In the text that follows you will find detailed information on the procedure for entering a ladder diagram for a two-way switch.

You should proceed as follows:

- Go to the programming screen,
- Enter the contacts in the first line,
- Enter the coil in the first line and join it to the contacts,
- Enter the contacts in the second line,
- Join the second line to the first,
- Launch the program.





From the main screen (the one shown on power-up), follow the instructions in the **Action** column and press the specified button.

The **Screen** column shows what the user will see on the smart relay display screen.

The **Comments** column provides some additional information on entry and display actions.

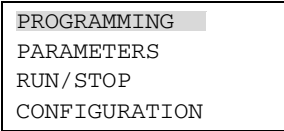

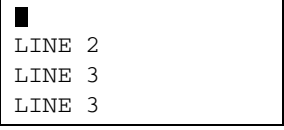



### Go to the Programming Screen

To access the screen from which we will program the two-way switch, proceed as follows:

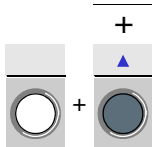
Step	Action	Screen	Comment
1			Position the cursor on <b>PROGRAMMING</b> ; it will flash when selected.
2			After briefly displaying: <b>LINE 1</b> (for approx. two seconds), a ■ flashing cursor is displayed.
3			Pressing and holding down the <b>Shift</b> key (white) will make a contextual menu appear that is used for programming the contacts and the coils.

### Entering the Contacts in the First Line

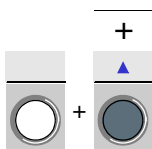
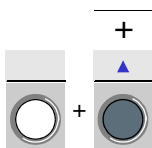
To enter the contacts in the first line, proceed as follows:

Step	Action	Screen	Comment
1		I1	The <b>I</b> flashing cursor is positioned on the I. The smart relay prompts you to select the type of contact.
2		I1	The <b>1</b> flashes. The user has implicitly selected a contact assigned to an input (I), the smart relay now prompts the user to select the input number.
3		I1●	The <b>●</b> flashes, indicating a link point for linking connections.
4		I1 ■	The <b>■</b> flashes. You just confirmed entry of the contact associated with the input <b>I1</b> . The <b>■</b> is positioned for entering the second contact.
5		I1 - I1	The right side I will begin flashing. The smart relay prompts you to select the type of contact.
6		I1 - i1	The <b>i</b> flashes. You have just selected the reverse contact assigned to an input.
7		I1 - i1	The <b>1</b> on the right flashes. Now enter the input number.

---

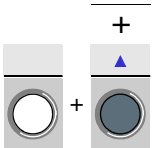



Step	Action	Screen	Comment
8		I1-i2	The 2 flashes.

---



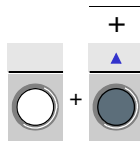

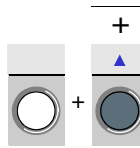
**Entering the Coil and Joining it to the Contacts**

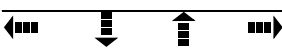
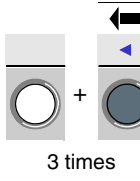
To enter the coil in the first line and connect it to the coils, proceed as follows:

Step	Action	Screen	Comment
1		I1-i2 ● I1-i2 ■ ... then I1-i2 ■	The cursor flashes in succession: ● At a link point: ●, ■ At a contact point: ■. Until positioned at the end of the line ready to enter the coil.
2		I1-i2 [M1	The [ flashes.
3		I1-i2 [M1	The M flashes.
4		I1-i2 [Q1	The Q flashes.
5		I1-i2 ●[Q1	The cursor ● is displayed.
6			Pressing and holding down the <b>Shift</b> key (white) will make a contextual menu appear that is used for programming the connections.
7		I1-i2●-----[Q1	The link is created.

**Entering the Contacts in the Second Line**

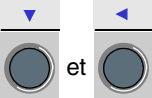
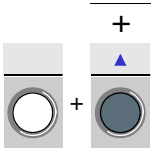
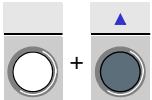
To enter the contacts in the second line, proceed as follows:

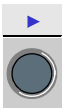
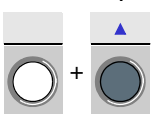
Step	Action	Screen	Comment
1	 <p>et</p> <p>as many times as necessary until positioned at the start of the line.</p>	<p>I1-i2-----[Q1</p> <p>█</p>	The █ is at the start of the following line.
2	 <p>+</p>	<p>I1-i2-----[Q1</p> <p>I1</p>	The I located on the second line flashes.
3	 <p>+</p>	<p>I1-i2-----[Q1</p> <p>i1</p>	The i located on the second line flashes.
4		<p>I1-i2-----[Q1</p> <p>i1</p>	The 1 located on the second line flashes.
5	 <p>2 fois</p>	<p>I1-i2-----[Q1</p> <p>i1 █</p>	The █ flashes.
6	 <p>+</p>	<p>I1-i2-----[Q1</p> <p>i1-I1</p>	The I located on the second line flashes.

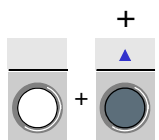
Step	Action	Screen	Comment
7		I1-i2-----[Q1 i1-I1	The second <b>1</b> in the second line flashes.
8		I1-i2-----[Q1 i1-I2	The <b>2</b> located on the second line flashes.



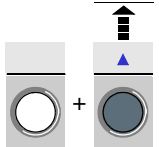

### Joining the Second Line to the First

To join the second line to the first, proceed as follows:

Step	Action	Screen	Comment
1		I1-i2-----[Q1 i1-I2●	The ● flashes. This shows that it is possible to connect a link at this point.
2		I1-i2]-----[Q1 i1-I2]	The ● has changed into a   which creates the link between the two lines.

## Launching the Program



To launch the program, proceed as follows:

Step	Action	Screen	Comment
1		VALIDER MODIFS. ? OUI NON	Now confirm the changes. <b>YES</b> flashes.
2		PROGRAMMATION PARAMETRES RUN/STOP CONFIGURATION	The main menu re-appears. <b>PROGRAMMING</b> is selected (flashes).
3	 2 fois	PROGRAMMATION PARAMETRES RUN/STOP CONFIGURATION	<b>RUN/STOP</b> is selected (flashes).
4		RUN PROG ? OUI NON	Now start the program.
5		1234            BCDE RUN LD JEU 25 SEP 16:40 1234	The main menu re-appears.

## The Basic Points

This simple application example teaches the user how to enter a ladder diagram.

The following points should be remembered:

- When a  or a  is flashing, use the **Shift** button to add an element (contact, coil or graphic link element),
- When an element is flashing (**I**, **Q**, **No.**,  etc.), it is possible to use the **Shift + Z2** and **Z3** arrows on the arrow keypad to select the required element,
- It is also possible to use the **Z1** to **Z4** arrows on the arrow keypad to move around the ladder diagram.

---

# Debugging an Application

# 18

---

## Presentation

### Subject of this Chapter

This chapter presents the tools available for debugging an application loaded in the memory of the smart relay.

### What's in this Chapter?

This chapter contains the following topics:

Topic	Page
Introduction	166
Dynamic Mode Ladder Diagrams	168
Dynamic Mode Function Block Parameters	170
Dynamic Mode Menus	171
Smart Relay Reaction to a Power Failure	172

## Introduction

### Module in RUN Mode

Once an application has been entered in ladder diagram form, debugging tests still must be run.

The first step is to set the smart relay to RUN. To do this, in the RUN/STOP option in main menu and select RUN.

From this moment on, the smart relay handles the physical inputs and outputs according to the instructions entered in the ladder diagram.

### Viewing Status:

In RUN mode, the states of inputs and outputs are displayed on the main screen:

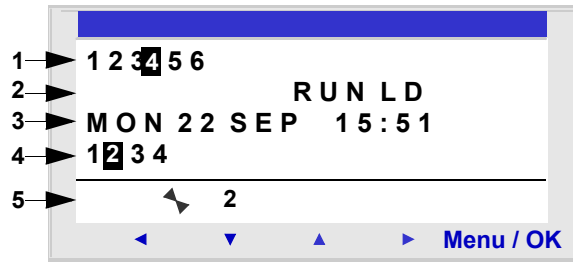

Prompt	Element
1	Display input status
2	Display run mode (RUN/STOP) and mode in use.
3	Displays date and time for products with clocks.
4	Output status display.
5	Contextual menus / pushbuttons / icons indicating operating modes.

When inputs or outputs are activated, they appear in reverse video (using white on a black background).

This concept is referred to as the dynamic operation of smart relay functions. The terms **RUN** and **dynamic** have a similar meaning in the remainder of this document.

## Contextual Menus

Below is an illustration of the icons in the contextual menu when the smart relay is in RUN mode:

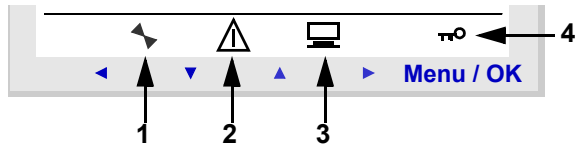

Prompt	Element
1	Status of the smart relay: In RUN it is in motion, in STOP it is immobile.
2	Indicates that faults have appeared (see <i>FAULT Menu</i> , p. 77).
3	Indicates that the smart relay is connected to the programming software.
4	The key indicates that the program is password-protected.

## Dynamic Mode Ladder Diagrams

---

### Viewing Ladder Diagrams

**Note:** This function can be accessed only in LD/ RUN mode.

The smart relay can dynamically display the performance of a ladder diagram. To do this, simply call up the **MONITORING** menu and position the cursor over the lines to display using the navigation keys.

Each conducting contact or energized coil is displayed in reverse video mode (white on black):

```

I1-i2-I4----- [M1
IB-----I5-i3- [M2
M1-M2----- [Q1
H2----- [Q2
    
```

To change smart relay performance, the user may change or view some of the function block parameters.

---

### Changing Ladder Diagrams

It is **ABSOLUTELY IMPOSSIBLE** to change ladder diagram lines in RUN mode.

It is however possible to change function block parameters in **MONITORING** mode.

---



**Using Z Keys as Pushbuttons**

On the INPUTS-OUTPUTS screen in RUN mode, the numbers of the Z keys used in the program are displayed in the contextual menu. Press and hold down the **Shift** key to display this menu.

To enable a Z key, press on the button located under the number.

Illustration:

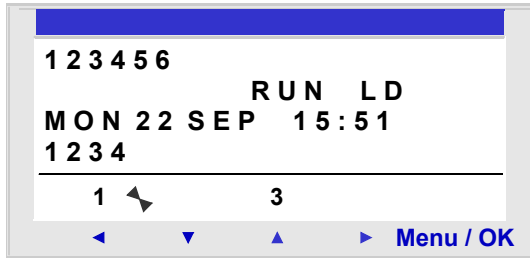

**Note:** The **Zx keys** function is disabled in **PARAMETERS** and **MONITORING** modes and in all of the function block parameter screens and configuration screens.

## Dynamic Mode Function Block Parameters

---

### Presentation

In RUN mode a function block preset value may be changed dynamically if it is not locked.

Functions with parameters in LD mode:

- Auxiliary relays (latching),
- Discrete Outputs (latching),
- Clocks
- Analog comparators,
- Timers
- Counters
- Fast counters.

Functions with parameters in FBD mode:

- Numerical constant-type inputs,
  - Clock,
  - Gain,
  - Timers: TIMER A/C, TIMER B/H, TIMER Li,
  - Counter: PRESET COUNT / UP DOWN COUNT,
  - H-SPEED COUNT fast counter,
  - PRESET H-METER hour counter,
  - CAM block.
- 

### Accessing / Modifying parameters

Parameters may be accessed from the following screens:

- **PARAMETERS:** See *PARAMETERS Menu, p. 51*,
- **MONITORING:** on the ladder diagram.

To modify the parameters of an element from the MONITORING screen, proceed as follows:

Step	Action
1	Position the cursor on the element you would like to modify using the navigation keys.
2	At the same time, hold down <b>Shift</b> and the <b>Param</b> key to open the parameter window.
3	Position the cursor on the modifiable parameter fields using the navigation keys: ◀ ▶.
4	Modify the value of the parameter using the ▲ and ▼ (+ and -) keys, holding down <b>Shift</b> .
5	Confirm the modifications by pressing <b>Menu/OK</b> , which will open the confirmation window. Confirm a second time by pressing <b>Menu/OK</b> to save.

**Note:** Only the parameters of unlocked blocks may be modified.

---

## Dynamic Mode Menus

### Dynamic Mode Menus

Some menus are accessible when the smart relay is in RUN mode, while others are not. Here is a summary table.

Menu	LD	FBD
PROGRAMMING		
MONITORING	✓	
PARAMETERS	✓	✓
RUN / STOP	✓	✓
CHANGE D/H	✓	✓
CHANGE SUMM/WINT	✓	✓
CONFIGURATION		
PASSWORD		
FILTER		
Zx KEYS		
WATCHDOG CYCLE		
CLEAR PROG.		
TRANSFER		
VERSION	✓	✓
LANGUAGE	✓	✓
FAULT	✓	✓

## Smart Relay Reaction to a Power Failure

---

### Description

A power failure may cause the smart relay to restart and lose any data not saved.

Smart relays have the ability to save the current time for at least 10 years.

In addition, it is also possible to back up the variables configured with the **Latching** option defined in the parameters window.

---

### Latching

The **Latching** function is used to save the state of the counter's current values in the event of a power failure.

The blocks that have this function are the following:

- In LD mode:
    - Auxiliary relays,
    - Discrete outputs,
    - Timers
    - Counters
    - Fast counter,
  - In FBD mode:
    - AC, BH, Li timer,
    - Cam programmer function CAM BLOCK,
    - PRESET COUNT, UP DOWN COUNT counter,
    - PRESET H-METER hour counter,
    - Data archiving function ARCHIVE,
    - Fast counters.
-

**Safety Mode**

If the result of losing the time setting is to lock coil control, then simply use a clock contact without a stop order in series with the action coils.

Example of a **non**-locked coil:

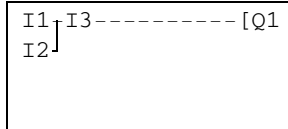

The contact line for coil Q1 will be active even if the time and date setting is lost.

Example of a locked coil:

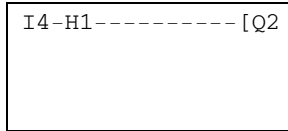

With the clock function block 1 configured as follows:

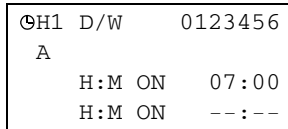

The contact line for coil Q2 will only be active after setting the clock.

---

# Backup and Transfer of Ladder Diagrams"

# 19

---

## Saving and Transferring Ladder Diagrams

### Description

It is possible to transfer a ladder diagram from the smart relay toward a backup memory (optional) and vice-versa.

This allows:

- To backup an application, then restore it later on if necessary,
- To make a copy of an application for loading it in several smart relays.

### Transferring an Application

Transferring an application from a smart relay to the backup memory, or from the backup memory to the smart relay, is performed using the menu: **TRANSFER**.

The procedure is described in detail in the chapter **TRANSFER Menu**, see *TRANSFER Menu, p. 67*.

---

---

# Sample Application

20

---

## Presentation

### Subject of this Chapter

In this chapter we'll use the example of an underground car park control. From given specifications, we will develop the application to program in the smart relay.

### What's in this Chapter?

This chapter contains the following topics:

Topic	Page
Specifications	178
Specification Analysis	179
Implementing the Solution	181

## Specifications

---

<b>Objective</b>	We wish to complete and centralize the control of the underground car park of an administrative building.
<b>Automatic Gate</b>	<p>The entrance and the exit of the car park are controlled by an ordinary automatic gate.</p> <p>The gate has the usual basic features such as:</p> <ul style="list-style-type: none"><li>● Gate timing (opening and closing) by passing vehicles,</li><li>● Ticket payment management,</li><li>● Safety telephones,</li><li>● External control for locking in closed position, etc.</li></ul>
<b>Counting Vehicles</b>	<p>In addition, we would like to keep track of vehicles parked in the facility.</p> <p>We would thus be able to control a lighted panel that informs drivers when all parking spaces are occupied and prevents access by locking the gate in the closed position. Drivers would then know to look for a parking space elsewhere.</p> <p>It must also be possible to override this function when necessary to allow access for emergency services (fire department, emergency medical service, etc.).</p>
<b>Open Time</b>	<p>We would also like to prevent access to the facility when the building is closed.</p> <p>Security personnel should be allowed to prevent the gate from locking in non-ordinary circumstances. The hours of opening are the following: Monday to Friday from 8:30 am to 5:30 pm, Saturday from 9:30 am to 12:00 noon and closed all day Sunday.</p>
<b>Removal of Toxic Gasses</b>	<p>For safety reasons, it is also necessary to remove toxic emissions such as carbon dioxide by using a fan when the measured concentration levels exceed permissible levels.</p> <p>A specialized sensor will be used that provides an output value between 0 and 10V.</p>
<b>Lighting</b>	<p>There is also a requirement to control lighting, triggered by a vehicle arriving and via pushbutton switches placed near all of the pedestrian access points.</p> <p>To save energy, lights will turn off after 10 minutes. This is the length of time generally observed for someone to park and exit their vehicle and take the elevator, or return to their vehicle and exit the park facility.</p>
<b>Manual Counting</b>	In addition, a manual action should be able to provide current information on the number of vehicles parked in the facility. Someone should be able to manually increase or decrease the number of vehicles known by the smart relay.



## Specification Analysis

**Description** Analysis of the specifications includes listing inputs, buttons, outputs and function blocks necessary to complete the application.

**Inputs** Below is the list of inputs that the application will use:

Smart relay label	Name
Input I1	Vehicle entry detection.
Input I2	Vehicle exit detection.
Inputs I3 and I4	Pushbuttons at pedestrian access points. They are used to light the facility. One for the elevator and one for the stairway (no pedestrian access is allowed via the vehicle entrance).
Analog input IB	CO <sub>2</sub> level sensor.

**Button** Below is the list of buttons that the application will use:

Smart relay label	Name
Function key Z1	Manually increments the number of vehicles in the car park.
Function key Z2	Resumes automatic entry control.
Function key Z3	Manually decrements the number of vehicles in the car park.
Function key Z4	Manually releases the entrance barrier.

**Outputs** Below is the list of outputs that the application will use:

Smart relay label	Name
Output Q1	Indicates when the car park facility is full.
Output Q2	Locks the entry barrier (inhibits entry barrier opening) when the car park is full or outside of opening hours.
Output Q3	Manually releases the entrance barrier.
Output Q4	Controls the polluted air extraction fan control.

**Special function blocks**

Below is the list of special function blocks that the application will use:

Smart relay label	Name
Counter <b>C1</b>	Counts the number of vehicles in the car park (93 maximum).
Clock function block <b>H1</b>	Manages car park access hours.
Timer function block <b>T1</b>	Lighting timer (10 minutes).
Analog function block <b>A1</b> , the authorized threshold value corresponds to 8.5 Volts.	Compares the CO2 level measured with the allowable threshold.
Timer function block <b>T2</b>	Fan timer (15 minutes).

**Note:** To implement this solution, a smart relay with analog inputs, clock function blocks and at least 4 discrete inputs and outputs.

## Implementing the Solution

### Description

Presented here are the control diagrams to program, as well as the parameters to use for the function blocks.

### Implementing the Ladder Diagram

Below is the control diagram to program:

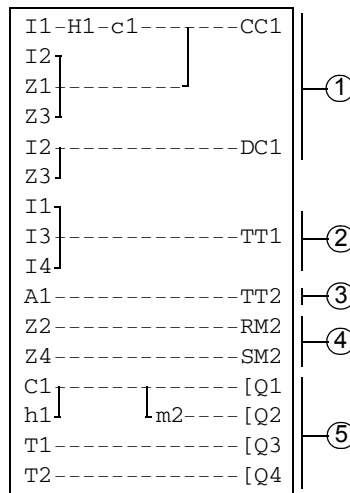

Prompt	Element
1	Counting vehicles in, subtracting vehicles out and manually updating the number of vehicles actually in the car park.
2	Starting the lighting timer.
3	Starting the fan timer.
4	Handling the manual release function.
5	Outputs command: Car park full indicator, blocking the input, lighting the car park and running the extraction fan.

When upcounting and downcounting, the counter locks up when the car park becomes full (no spurious detection or counting actions take place if vehicles are allowed to enter by manual release).

**Note:** For a given counter, the coils **CC** and **DC** should only appear once in a ladder diagram.

In addition, output **Q2** is activated when entry into the car park is not allowed. This leads to the use of an auxiliary relay to manually lock or unlock the access gate using the navigation keys.

**Configuring the Function Blocks**

The table below provides details on the parameters to use for each of the function blocks:

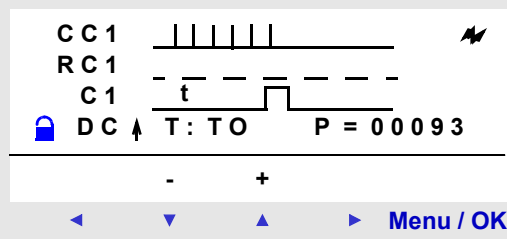
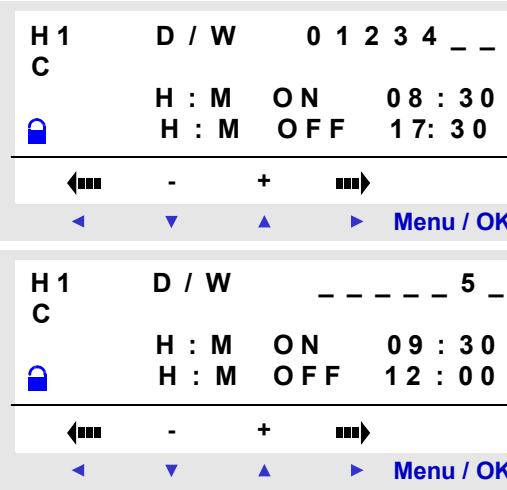
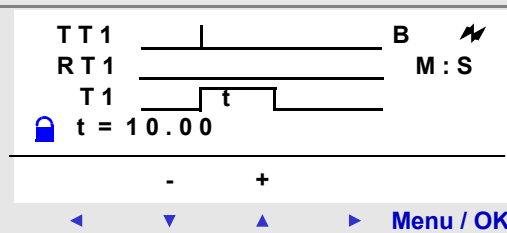
Function block	Comment
<p>Counter function block C1</p> 	<p>The preset value is 93 (the maximum number of vehicles allowed in this car park). Where necessary, this value may be changed during operation.</p>
<p>Clock function block H1</p> 	<p>Open hours:</p> <ul style="list-style-type: none"> <li>Monday to Friday from 8:30 am to 5:30 pm.</li> <li>Saturdays from 9:30 am to 12:00 noon.</li> <li>Closed all day Sundays.</li> </ul> <p>Two ranges are used.</p>
<p>Timer function block T1</p> 	<p>Car park lighting timer: 10 minutes.</p>

Function block	Comment
<p>Analog function block <b>A1</b></p> <div style="border: 1px solid black; padding: 5px;"> <p style="text-align: center;"><b>A1 sANALOG 2</b></p> <p style="text-align: center;"><b>I b ≥ R</b></p> <p style="text-align: center;"><b>R = 8.5      x 1 = I b = 0.0</b></p> <p style="text-align: center;"><b>x 2 = R = 8.5</b></p> <hr/> <p style="text-align: center;">-      +</p> <p style="text-align: center;">◀    ▼    ▲    ▶    <b>Menu / OK</b></p> </div>	<p>Compares the measured CO<sub>2</sub> level with the threshold value: 8.5 V.</p>
<p>Timer function block <b>T2</b></p> <div style="border: 1px solid black; padding: 5px;"> <p style="text-align: center;"><b>TT2</b> _____ <b>B</b> ⚡</p> <p style="text-align: center;"><b>RT1</b> _____ <b>M : S</b></p> <p style="text-align: center;"><b>T1</b> _____ <b>t</b></p> <p style="text-align: center;"><b>t = 15.00</b></p> <hr/> <p style="text-align: center;">-      +</p> <p style="text-align: center;">◀    ▼    ▲    ▶    <b>Menu / OK</b></p> </div>	<p>Fan operating duration if the CO<sub>2</sub> threshold is exceeded. 15 minutes.</p>

---

# Diagnostics

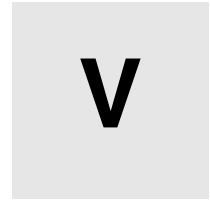

---

## Presentation

### Subject of this Section

This chapter will help you find solutions to operating problems.

### What's in this Part?

This part contains the following chapters:

Chapter	Chapter Name	Page
21	Diagnostics	187

---

# Diagnostics

21

---

## Presentation

### Subject of this Chapter

This chapter will help you find solutions to operating problems.

### What's in this Chapter?

This chapter contains the following topics:

Topic	Page
Smart Relay Messages	188
Frequently Asked Questions	189

## Smart Relay Messages

**Description** Here is detailed information on the error messages that are returned by the smart relay, their possible causes and how to remedy the problem.

**Error Messages** The table below lists the error messages that a smart relay could return. These messages generally indicate incompatible actions requested by the user.

Message	Cause	Corrective action
NO PARAMETER	The user has requested to access the <b>PARAMETERS</b> option when no parameter is available (the diagram does not include any elements with parameters).	
TRANSF.ERR.	A transfer was in progress and the link with the PC was unexpectedly interrupted.	See the documentation for the programming software.
TRANSFER ERROR: NO MEMORY	A transfer to the EEPROM was requested and the EEPROM is not present or incorrectly located.	Check the presence and correct location of the EEPROM.
TRANSFER ERROR: CONFIG INCOMPAT	The user has requested to transfer a program that does not match the characteristics of the target smart relay, for example: Clock, analog input, software version.	Check the origin of the program to transfer and choose a program that is compatible with the appropriate smart relay.
TRANSFER ERROR: VERSION. INCOMPAT	This error appears if one of the versions of the smart relay does not correspond to: Firmware, LD or FBD functions	Check the firmware version used.
Outputs are displayed flashing on the main screen	One or more static outputs have shorted or overloaded.	Troubleshoot, then stop the smart relay to end the blinking before selecting RUN mode again (automatic reset).



## Frequently Asked Questions

---

**Description**

To assist the user in understanding the smart relay, the most frequently asked questions are listed here.

---

**Frequently Asked Questions** Here below are the most frequently asked questions and their answers:

Question	Answer
I cannot access some parameters.	Some parameters are not accessible. See the documentation to find out whether these elements can be changed. Example of an element that cannot be changed: Counter function block counting direction. This element is only accessible by wiring in a ladder diagram line.
I still cannot access some parameters.	To access the parameters, you must use the navigation keys ◀ and ▶ to position the cursor above them. The ▼ and ▲ are used to change these values. Then press <b>Menu/OK</b> to confirm the changes.
I cannot RUN my smart relay even though I enable the RUN/STOP option in the main menu using the <b>Menu/OK</b> key.	CAUTION, make sure that the error symbol (!) is not displayed in the contextual menu line. Correct the error in order to RUN the smart module.
I would like to change my diagram lines but the <b>Menu/OK</b> key no longer works.	Ensure that the smart relay is indeed stopped. Changes in RUN mode are not allowed.
When I try to change my diagram lines, the smart relay shows me a screen with only line numbers (LINE No.). Have I lost all my work?	Not necessarily, this situation may occur when 4 consecutive blank lines have been inserted at the start of the ladder diagram or between the command lines.
I have a ladder diagram that uses the Z key (◀, ▼, ▲, ▶) for a pushbutton. I would like to test it but when I display the diagram dynamically, my Z key is no longer operational. Can I make it work?	No this is impossible.
I generated a ladder diagram on a smart relay with a clock. Can I use a backup memory to transfer it to a smart relay without clock?	No this is impossible.
When entering a ladder diagram, the clock function blocks do not appear when choosing the contacts. Is this normal?	It is quite possible that the smart relay is one without a clock. Consequently, the clock function blocks are not accessible. Check the product reference numbers.
When entering a ladder diagram, the analog function blocks do not appear when choosing the contacts. Is this normal?	It is quite probable that the smart relay does not have analog inputs. Consequently, the analog function blocks are not accessible. Check the product reference numbers.

---

# Appendices



---

## At a Glance

### Introduction

This section contains product-related appendices.

### What's in this Appendix?

The appendix contains the following chapters:

Chapter	Chapter Name	Page
A	Compatibility	193

---

# Compatibility



---

## At a Glance

### Subject of this Chapter

This appendix provides information on the compatibility between the versions of the firmware, the versions of the programming software and the different memory cartridges.

### What's in this Chapter?

This chapter contains the following topics:

Topic	Page
Compatibility between the version of the programming software and the version of the firmware on the smart relay	194
Compatibility between the memory cartridges and the version of the firmware on the smart relay	195

---

## Compatibility between the version of the programming software and the version of the firmware on the smart relay

---

### Introduction

The section below describes the compatibility between the versions of the programming software and the versions of the firmware on the smart relay.

---

### In the Case of a Transfer of the Program from the PC to the Smart Relay

In the case of a transfer of the PC program to the smart relay, all the versions of the programming software are compatible with all the versions of the firmware on the smart relay.

During transfer of the PC program to the smart relay, the firmware associated with the version of the programming software is transferred to the smart relay.

---

### In the Case of a Transfer of the Program from the Smart Relay to the PC

In the case of a transfer of the program from the smart relay to the PC, compatibility between the version of the programming software and the version of the firmware on the smart relay is as follows:

		Smart relay firmware version		
		V2.xx	V3.xx	V4.xx
Version of the programming software	V2.4	Compatible	Incompatible	Incompatible
	V3.1	Incompatible	Compatible	Incompatible
	V4.1	Incompatible	Incompatible	Compatible

---

## Compatibility between the memory cartridges and the version of the firmware on the smart relay

### Introduction

The section below describes the compatibility between the memory cartridges and the versions of the firmware on the smart relay.

### Compatibility of the Memory Cartridge with the Version of the firmware

The table below describes the compatibility of the memory cartridges with the version of the firmware:

Type of memory cartridge	Version of firmware compatible
SR2 MEM01	LD Language: V2.19 or lower. FBD Language: V2.18 or lower.
SR2 MEM02	V3.0.9 or higher.

### Transferring a Program from the SR2 MEM01 Memory Cartridge to the Smart Relay

In the case of a transfer of the program from the SR2 MEM01 memory cartridge to the smart relay, compatibility is as follows:

		Smart relay firmware language	
		LD	FBD
Memory cartridge program language	LD	Compatible if the versions of the memory cartridge and smart relay match.	The LD firmware version must be transferred to the smart relay.
	FBD	The FBD firmware version must be transferred to the smart relay.	Compatible if the versions of the memory cartridge and smart relay match.

### Transferring a Program from the SR2 MEM02 Memory Cartridge to the Smart Relay

In the case of a transfer of the program from the SR2 MEM02 memory cartridge, compatibility is always true:

---

# Index

---

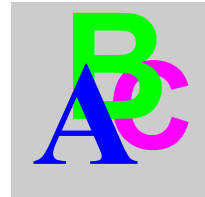

## A

Auxiliary Relays, 93

## C

Clocks, 134

Compatibility

    Firmware, 194, 195

    Memory Cartridges, 195

    Programming Software, 194

## D

Discrete Inputs, 89

Discrete Outputs, 98

## F

Firmware

    Compatibility, 194, 195

## I

inputs-outputs, 34

## L

LD Analog Comparator, 129

LD Change to Summer / Winter Time, 141

LD Counter Comparators, 128

LD Counters, 111

LD Fast Counter, 118

LD Language Elements

    Auxiliary Relays, 93

    Clocks, 134

    Counter Comparators, 128

    Counters, 111

    Discrete Inputs, 89

    Discrete Outputs, 98

    Fast Counter, 118

    LCD Screen Backlighting, 140

    Message, 144

    Modbus I/Os, 143

    Texts, 138

    Timers, 101

    Zx Keys, 91

LD language Elements

    Analog Comparator, 129

    Change to Summer / Winter Time, 141

LD LCD Screen Backlighting, 140

LD Texts, 138

LD Timers, 101

## **M**

### Menu

- CHANGE DATE/TIME, 81
- CHANGE SUMMER/WINTER, 83
- CLEAR PROG., 65
- CONFIGURATION, 57
- FAULT, 77
- LANGUAGE, 75
- MONITORING, 53
- PARAMETERS, 51
- PASSWORD, 58
- PROGRAMMING, 39
- RUN / STOP, 55
- TRANSFER, 67
- VERSION, 73
- WATCHDOG CYCLE, 63
- Zx KEYS, 62

Modbus LD I/Os, 143

## **Z**

Zx Keys, 91





35007143



SR2MAN01EN

Visit <http://www.schneider-electric.com> for your nearest Schneider Electric affiliate.

You can download these technical publications and other technical information from our website at <http://www.telemecanique.com>

## Free Manuals Download Website

<http://myh66.com>

<http://usermanuals.us>

<http://www.somanuals.com>

<http://www.4manuals.cc>

<http://www.manual-lib.com>

<http://www.404manual.com>

<http://www.luxmanual.com>

<http://aubethermostatmanual.com>

Golf course search by state

<http://golfingnear.com>

Email search by domain

<http://emailbydomain.com>

Auto manuals search

<http://auto.somanuals.com>

TV manuals search

<http://tv.somanuals.com>