



General Description

The Shure FP24 is a studio-quality two-channel, portable, stereo microphone mixer. With assignable L-C-R inputs, built-in slate microphone, 1 kHz tone oscillator, and headphone monitor, the FP24 is extremely flexible. Its impressive audio performance and comprehensive features make it suitable for the front end of any studio or field production system. Radio, television, and film production engineers will especially value its compact size, sunlight-readable LEDs, and rugged mechanical and electrical construction that make it able to withstand extremes in the field.

Features

High Performance Microphone Inputs

- Maximum of 66 dB of gain (each input).
- Premium Lundahl input transformers provide superior audio quality and freedom from interference problems.
- Sealed, conductive plastic potentiometers for long life and reliable gain adjustment.
- Phantom power, selectable between 48 volts and 15 volts.
- Switchable low-cut filters with 80 and 160 Hz corner frequencies, 6 dB per octave. Filters are inserted prior to any active circuitry to maximize headroom.
- Inputs assignable to Left, Center (both left and right) or Right

Audio Performance

- Dynamic range exceeding 110 dB.
- 10 Hz to 50 kHz audio bandwidth.
- Exceptionally low distortion characteristics.
- Discrete, 6-transistor, balanced output drivers provide signal integrity over long cable runs.

Headphone Monitoring

- Switchable between program audio or external (stereo) tape returns.
- High current headphone output has level control and peak indicator.

Level Metering

- Dual-color LEDs indicate clipping and limiter activity for each channel.
- Sunlight-readable, seven segment GaN LED output meters.
- 3-position LED brightness switch (intensity selector).

Audio Limiters

- “Unclippable” input peak limiters with adjustable limiter threshold (each input).
- Dual mono or linked stereo limiter operation.

Flexible Powering

- Internal power from two AA batteries with easy access battery compartment.
- Chassis-isolated 5 to 14 VDC input for easy external DC powering.
- Power LED indicates low battery power.

Trouble-Free Design

- High-strength, extruded aluminum chassis with protective metal end panels withstands punishing field conditions.
- All-metal connectors mount directly to the chassis for durability and RF immunity.
- Free from “Pin 1” grounding problems.
- RF filtering on all inputs and outputs.

Specifications

Gain:

Mic Input to Output, per channel, continuously variable

Output	Gain Range
LINE	$-\infty$ – 66 dB
TAPE	$-\infty$ – 56 dB

Frequency Response:

20 Hz – 30 kHz, +0.2, –0.5 dB; –1 dB at 5 Hz, 50 kHz

(relative to 1 kHz level with 150 ohm source, gain controls set at 50%)

Equivalent Input Noise:

–126 dBu (–128 dBV) minimum

(150 ohm source, flat weighting, 22 Hz – 22 kHz bandwidth, gain control set at 50% or higher, phantom power off)

Input Clipping Level:

–10 dBu minimum

Output Clipping Level:

Line: +22 dBu minimum with 100k ohm load
+20 dBu minimum with 600 ohm load

Tape: +11 dBu (2.75 V RMS) minimum with 100k ohm load

Dynamic Range:

110 dB minimum

THD + Noise:

0.05% maximum

(from 50 Hz to 22 kHz @ +4 dBu output level, 22 Hz – 22 kHz filter bandwidth, gain control at 50%, phantom off)

Common Mode Rejection Ratio:

100 dB minimum at 80 Hz

60 dB minimum at 10 kHz

Channel Separation:

Greater than 80 dB at 1 kHz (gain controls set to 50%)

Inputs:

Transformer-balanced, 2k ohm input impedance

Outputs:

XLR: Active, impedance-balanced, 120 ohm output impedance

Tape (3.5 mm (1/8 in.)): Unbalanced, tip–left, ring–right, sleeve–ground, 2.4k ohm output impedance

High Pass Filters:

80 Hz or 160 Hz (switch selectable), 6 dB per octave

Phantom Power:

15 V through 680 ohm resistors or 48 V through 6.8k resistors (switch selectable)

Limiter:

Thresholds independently adjustable from +6 dBu to +18 dBu

10:1 limiting ratio

5 ms attack time, 100 ms release time

Amber/Red LED indicates limiting/clipping

Dual mono or stereo linked

Internal Voltage Rails:

+15 V and –15 V, regulated

Metering:

7 segment GaN (Gallium Nitride) meter with 3 intensities

Peak responding

Power:

Internal: 2 AA batteries

External: 5 – 14 VDC via threaded coaxial connector* (5.5 mm outer diameter, 2.1 mm inner diameter); Pin positive, sleeve negative; Voltages above 14 VDC cause no damage to unit, but will open an internal poly fuse that will reset when voltage is removed.

*Threaded coaxial connector provided for use with power supplies not equipped. For instructions on how to solder this connector to a Shure PS20, see Figure 5.

Power LED:

Dual-color LED indicates following:

Green—external DC power or good battery.

Red—less than 1 hour of battery life remaining (with phantom power off).

Polarity:

All inputs to all outputs, non-inverting.

Pin 2 of XLRs “hot” (to unbalanced inputs and outputs).

Operating Temperature Range:

0 to 70 degrees C (32 to 160 degrees F)

Dimensions:

43 mm x 94 mm x 140 mm (H x W x D) (1.7" x 3.7" x 5.5")

Weight (FP24 only):

0.8 kg (1.8 lbs.)

Weight (packaged):

1.2 kg (2.6 lbs.)

EMC Certifications:

Meets FCC Part 15 Class B Emissions; Eligible to bear CE mark (see conformance statement)

Optional Accessories

Balanced line-level-to-microphone-level

in-line adapter A15LA

FP33/FP24 Interconnection Kit A33LK

Inline Polarity Inverter A15PRS

Front Panel Controls, Connectors, and Indicators

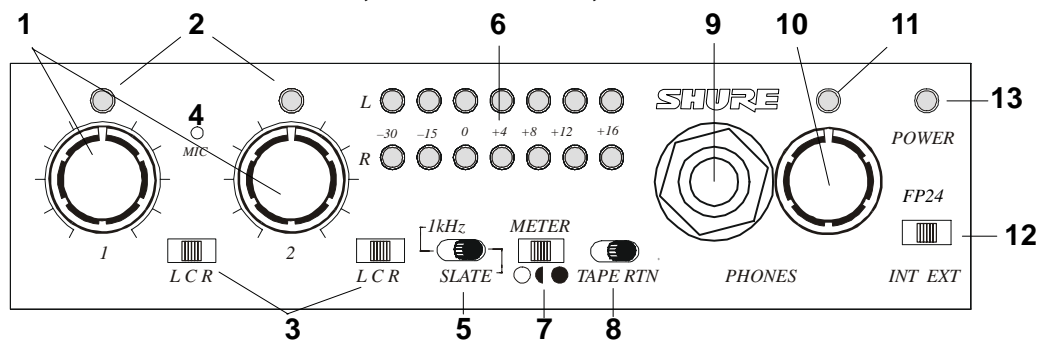

Figure 1. Front Panel

1. Input Gain Controls

Sealed, conductive plastic rotary potentiometers.

2. Input Peak/Limiter LEDs

Dual-color LED illuminates red at 3 dB below clipping; illuminates amber to indicate limiter activity.

3. L-C-R Switches (Input Assignment)

Three-position switch assigns inputs to Left, Center (both left and right) or Right outputs.

4. Slate Microphone

Condenser microphone with AGC activated by momentary Slate Microphone Switches. Slate Microphone output appears at all outputs.

5. Tone Oscillator/Slate Microphone Switch

Toggle switch activates 1 kHz tone oscillator when switched to the left position and activates the slate microphone when momentarily moved to the right position. Microphone inputs are muted when Tone Oscillator or Slate Microphone are activated.

6. Output Meters

Indicates peak output level in dBu.

7. Meter Brightness Control

Three-position switch adjusts the intensity of illumination of the output meter; low illumination, normal illumination, or super-bright illumination.

8. Tape Return Switch

Toggle switch allows external audio to be monitored in the headphones. The center position is FP24 program audio. The left and right positions monitor tape return audio; the left position is locking, and the right position is momentary.

9. Headphone Connector

For stereo and mono headphones with 1/4" connectors.

10. Headphone Volume Control

11. Headphone Peak LED

Illuminates 3 dB before clipping of either channel of the headphone circuit and either channel of Tape Return audio.

12. Power Switch

Three-position switch selects the power source. The unit is powered from internal batteries when in the left position; powered from external DC source when in the right position. Center position is off.

13. Power LED

Two-color LED illuminates green when the unit is powered and changes to red when batteries require changing. For external DC, the power LED is always green.

Input Panel Connectors and Controls

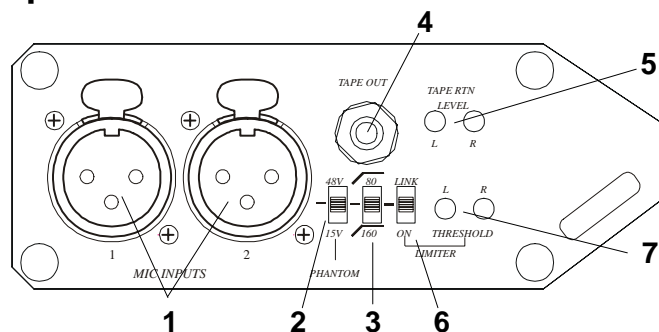

Figure 2. Side Input Panel

1. Mic Inputs

Transformer-balanced XLR inputs accept microphone level signals. Pin 2 = hot, Pin 3 = cold, Pin 1 = ground.

NOTE: You can use Shure A15LA line adapters to connect balanced, line-level sources to these inputs.

2. Phantom Power

Three-position switch selects either 48-Volt or 15-Volt phantom power for both inputs. Center position turns phantom power off.

3. High Pass Filter Switch

Three-position switch selects 80 Hz or 160 Hz corner frequency filters, 6 dB per octave. Filters affect both inputs. Center position of switch removes filters from the signal path.

4. Tape Output

3.5 mm (1/8 in.) TRS stereo output (unbalanced) can be used to feed consumer level DAT, MiniDisc, and CD recorders. Tip = Left, Ring = Right, Sleeve = Ground.

5. Tape Return Level Control

Recessed potentiometers adjust Tape Return level feeding the Headphone Monitor.

6. Limiter Switch

Activates input peak limiter. ON position functions as a dual mono limiter, with each input signal controlling its own limiter. LINK functions as a stereo limiter, with both left and right inputs controlled simultaneously. Center position of switch turns limiters off.

7. Limiter Threshold Level Control

Recessed potentiometers adjust peak level of limiter activation. Can be independently controlled for each input.

Output Panel Connectors

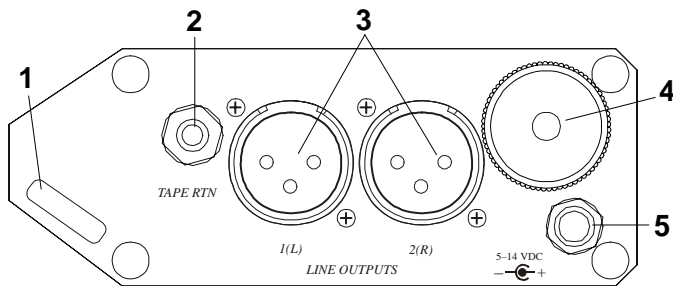

Figure 3. Side Output Panel

- 1. Strap Slot**
Attachment point for camera straps.
- 2. Tape Return Input Connector**
3.5 mm ($\frac{1}{8}$ in.) TRS stereo (unbalanced) input for headphone monitoring of external audio sources. Tip = left, ring = right, sleeve = ground.
- 3. Left and Right Line Level Outputs**
Active-balanced XLR line-level outputs. +22 dBu peak output level. Pin 2 = hot, pin 3 = cold, pin 1 = ground. Pin 3 can be grounded or ungrounded to drive unbalanced inputs.
- 4. Battery Compartment**
Houses two AA batteries. Insert positive (+) end of batteries first.
- 5. External DC Power Input**
Accepts 5–14 VDC from an AC to DC transformer or a battery supply. Locking, threaded coaxial connector. Center pin = positive, sleeve = negative. Use the supplied threaded connector for power supplies with plug-type connectors (such as the Shure PS20). See Figure 5 for wiring diagram.

Operational Notes

Input Transformers

The FP24 uses premium Lundahl input transformers with premium magnetic core material to achieve high signal-handling capability, flat frequency response and minimum distortion. Because these transformers provide galvanic isolation from the driving source, they offer superior isolation from the adverse and uncontrolled environments of field-production. Their high common-mode impedance also provides exceptional common-mode rejection.

Output Circuitry and Tape Output

Each line level XLR output of the FP24 uses a discrete, six-transistor, “impedance balanced” output stage. The circuit uses oversized, high speed transistors to achieve low distortion, robust line driving capability. Pin 2 is driven with signal, and pin 3 is not. (A common misunderstanding is that a “balanced” output refers to equal and opposite signals on pins 2 and 3. Correctly, “impedance balanced” refers to equal *impedances* from pins 2 and 3 to ground, not equal signal voltages.) To drive unbalanced inputs, pin 3 can be grounded or left unconnected. There is no change in signal level driving balanced or unbalanced inputs.

The FP24’s tape output feeds consumer-level devices, such as computer sound cards, DAT or MiniDisc recorders, and cassette recorders. A cable wired with 3.5 mm ($\frac{1}{8}$ in.) TRS to 3.5 mm ($\frac{1}{8}$ in.) TRS or 3.5 mm ($\frac{1}{8}$ in.) TRS to Left/Right phono (RCA) connectors will connect the FP24 to such devices.

Using the FP24 as a Mixer

The FP24 can be used as a simple two-channel mixer. Possible applications include:

- Quickly reversing the stereo image of a recording without reconnecting inputs or outputs.
- During set up, checking for mono compatibility by assigning both inputs to the same output.
- Recording dialog in mono.
- Performing “mix minus” by routing Input 1 to Center and Input 2 to Right. A summed mono signal of both inputs appears at the Right output while only Input 1 appears at the Left output. This is useful for post production processing of Input 1 audio.

Phantom Power

Use one of the two phantom power settings on the FP24 for microphones that require it. Some microphones need the 48-Volt setting to avoid a loss of headroom and increased distortion. The 15-Volt setting, however, lengthens battery life, and electret-condenser microphones rated for operation at 15 V or less generally receive no performance benefit from the 48-Volt setting. Consult your microphone documentation for phantom power requirements.

Dynamic microphones do not require phantom power. A properly connected balanced, dynamic microphone is not affected by the presence of phantom power and does not draw any current. However, poorly or incorrectly wired microphone cable can cause audible artifacts in the microphone signal (phantom power can be an excellent cable tester). It is good practice to turn phantom power off when not needed.

High Pass Filter

To remove excess low-frequency energy in the audio signal, use either of the two high pass (low cut) filter settings on the FP24. Use the 80 Hz position for most applications, such as recording speech, music, and ambient sound. The 160 Hz position is useful for enhancing speech clarity and reducing wind-noise. The high pass filter is a single pole design, 6 dB per octave.

When possible, equalize at the sound source by microphone selection, placement, use of a windscreen, and onboard microphone filtering. Using both the high pass filter on the FP24 and the one on a microphone has an additive effect, increasing the overall slope of the roll-off.

Headphone Monitoring and Tape Return

The three position Tape Return switch on the front panel selects the audio source being monitored:

Center Position—Program audio (normal operation). Monitors the Left and Right outputs of the FP24.

Left and Right Positions—Secondary audio source. Monitors audio from the Tape Return input of the FP24. Can be used to verify that signal is reaching cameras and tape machines. Left is locking; right is momentary.

Important: The FP24 can drive headphones to very high levels. Exercise care when monitoring. Reduce the level when the Headphone Peak LED illuminates.

Limiters

The FP24 has two built-in peak-responding limiters, one for each input channel. Each limiter has a two-stage circuit: the first stage keeps the input gain stage from clipping; the second stage limits the variable gain stage according to the Limiter Threshold control setting. This unique, two-stage topology limits the gain stage directly after the mic input transformer without changing the input impedance as other “at the mic” limiters do. The circuit enables the FP24 to limit in excess of 50 dB, making it very difficult to clip the unit regardless of the gain setting.

The FP24's limiters can operate in either either dual-mono or stereo. Use the three-position switch on the input panel to set the limiting mode:

- In the middle position, the limiters are turned off.
- In dual mono operation (**ON** switch position), the limiters work independently, responding only to their input signals.
- In stereo-linked operation (**LINK** switch position), the limiters control both channels identically. This maintains a stable stereo image.

When the limiters activate, the Peak/Limiter LED on the front panel illuminates amber in proportion to the amount of limiting for each channel.

Tone Oscillator and Slate Microphone

The switch labeled 1 kHz/SLATE on the front panel controls two functions. The **1 kHz** position (**left**) mutes all inputs and sends a 1 kHz sine wave calibration tone at +4 dBu to all outputs. The tone oscillator can be used to verify connections and set nominal levels on recording and transmission equipment.

The **SLATE** position (**right**) is a momentary switch position that activates the built-in slate microphone located behind the front panel. When the switch is held to the right, all inputs are muted and slate mic signal is sent to all outputs. The slate mic circuit contains an AGC (automatic gain control) to keep the slate level relatively constant regardless of the acoustic level. Use the slate microphone to document takes right at the mixer location when microphones are on talent or away from the production mixer.

Metering and Clip-Indicators

Three two-color clip-indicators monitor signal levels throughout the FP24:

1. Above each input gain control, a two-color LED glows red 3 dB below clipping. This clip circuit monitors both the front end gain stage and the variable gain stage.
2. A headphone-clip LED, located above the headphone level control, indicates when either channel of the headphone circuit approaches clipping.
3. The headphone-clip LED also indicates when either channel of the tape return audio is near clipping.

When the limiter is activated, these input LEDs glow amber in proportion to the amount of limiting.

The FP24 has a seven segment LED output meter that shows peak output level in dBu. From left to right, the first three LEDs are separated by 15 dB and the remaining LEDs are separated by 4 dB. This calibration provides a 46 dB-dynamic range with good resolution in the critical signal level range.

The meter uses premium Gallium Nitride (GaN) LEDs which are visible even in direct sunlight. A three-position switch on the front panel controls the brightness of the output meter. Choose low, normal, or super-bright.

CAUTION – When set to super-bright intensity, the LEDs in the output meter can irritate or damage eyes with prolonged direct exposure.

Power Sources and Battery-Life

The FP24 operates from either two internal AA alkaline cells or an external 5–14 VDC battery supply or AC to DC transformer (such as the Shure PS20). The power connector is a locking, threaded coaxial connector. Center pin = positive, sleeve = negative. Use the supplied threaded power connector if necessary (see Figure 5).

The external DC input supply is galvanically isolated (floating) from the chassis and the rest of the circuitry. The isolation provides trouble-free interconnection to other pieces of equipment sharing the same DC power source. The center pin of the locking DC connector is positive, and the sleeve is negative. Since the external DC supply is floating, the positive or the negative can be connected to the chassis with no adverse effects.

Two AA, 1.5 Volt lithium cells can power the FP24 for up to approximately 11 hours. However, several factors affect how long a given pair of batteries will last. These factors include battery chemistry, ambient temperature, use of phantom power, output meter brightness, and the output drive level of the FP24. The chart below provides estimates of battery life in different kinds of circumstances. Experimentation can determine expected battery life for specific setups and environments.

NOTE: AA carbon cells and AA nickel-cadmium cells are not recommended for use in the FP24 since they have lower power capacity than other types and will result in very short service life.

Battery Type	Microphone Type and FP24 Settings	Battery Life
Eveready AA No. L91 (lithium)	2 dynamic handheld microphones, low meter brightness, no headphones	11 hrs.
Duracell AA MN 1500 (alkaline)	2 dynamic handheld microphones, low meter, low headphone level	6 hrs.
	2 condenser, 15-Volt phantom powered microphones, normal meter intensity, normal headphone level	4 hrs.
	2 studio condenser, 48-Volt phantom powered microphones, super bright meter intensity, high headphone level	2 hrs.
Test conditions: 70 degrees F, 42 dB of gain with an acoustic music source, 600 ohm load, +4 dBu output		

Interconnecting the FP24 and FP33

You can connect the balanced, line level XLR outputs of the FP24 to the mix bus of the FP33 using the Shure A33LK accessory kit (or construct a cable assembly as shown in Figure 4 on the following page).

Combining an FP24 and a Shure FP33 (or FP32A) mixer yields a flexible, cost-effective, 5 X 2 field mixing setup with the following features:

- Simultaneously accepts a stereo microphone, hard-wired shotgun, and two RF lavalier microphones.
- 48-volt phantom power for all five microphone inputs
- Limiters on the FP24 inputs
- Input assignment switches on the FP24 and pan pots on the FP33 inputs
- Two output buses—assignable to mic or line level output.
- Master volume and headphone monitoring for all five inputs controlled from the FP33.
- Compact—FP24 adds little bulk to an existing FP33 package.
- The FP24's isolated external DC input jack eliminates ground related interference problems.

NOTE: When interconnecting the FP24 and FP33, inputs from the FP24 appear at the FP33 mixbus with their polarity reversed. (This is unavoidable due to the nature of the interconnection.) To avoid cancellation or interference effects (e.g., comb filtering) between the signals from the FP24 and FP33 inputs, use Shure A15PRS polarity inverters on the FP24 inputs, or do one of the following:

- Keep microphones connected to the FP24 as far away as possible from those connected to the FP33.
- For microphones that must be close together (such as those in a stereo pair), connect them to the same mixer.

NOTE: If constructing your own FP24/FP33 interconnect cable:

- Keep cable length to a minimum, since the interconnection is unbalanced.
- Be sure to drive the FP33 mix bus off of pin 2 of the FP24 since the FP24 inputs are reverse polarity with respect to FP33 inputs.

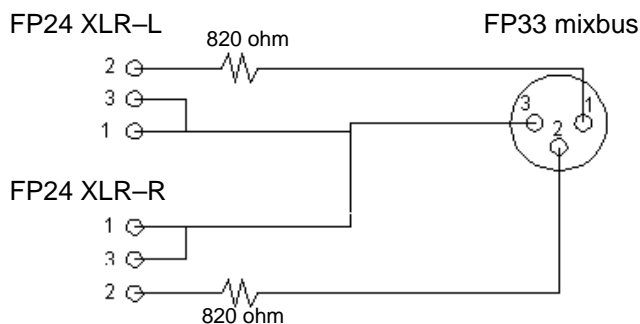
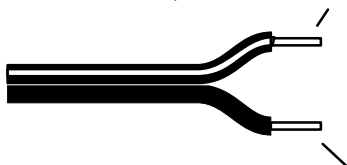

Figure 4. FP24/FP33 Mix Bus Interconnect Cable

Positive: Solder to center pin
(marked with a white stripe on PS20 cable)



Negative: Solder to sleeve

Figure 5. Attaching the Supplied Threaded Power Connector.

Certification

Authorized under the DECLARATION OF CONFORMITY provision of FCC part 15 as a Class B digital device. Tested to comply with FCC standards. FOR HOME OR OFFICE USE. This product complies with part 15 of the FCC rules. Operation is subject to the following two conditions: (1) this device may not cause harmful interference, and (2) this device must accept any interference received, including interference that may cause undesired operation. Changes or modifications not expressly approved by Shure Incorporated could void your authority to operate this equipment.

This equipment has been tested and found to comply with the limits for a class B digital device, pursuant to Part 15 of the FCC rules. These limits are designed to provide reasonable protection against harmful interference in a residential installation.

This equipment generates, uses and can radiate radio frequency energy and, if not installed and used in accordance with the instructions, may cause harmful interference to radio communications. However, there is no guarantee that interference will not occur in a particular installation. If this equipment does cause harmful interference to radio or television reception, which can be determined by turning the equipment off and on, the user is encouraged to try to correct the interference by one or more of the following measures:

- Reorient or relocate the receiving antenna
- Increase the separation between the equipment and the receiver
- Connect the equipment into an outlet on a circuit different from that to which the receiver is connected
- Consult the dealer or an experienced radio/TV technician for help

This class B digital apparatus complies with Canadian ICES-003.

Eligible to bear CE marking.

Conforms to European EMC directive 89/336/EEC: Professional Audio Products Standard EN 55103 (1996); Part 1 (emissions) and Part 2 (immunity). The FP24 is intended for use in environments E1 (residential) and E2 (light industrial) as defined in European EMC standard EN 55103. It meets the applicable tests and performance criteria found in the standard for these environments. EMC conformance is based on the use of shielded interconnecting cables.

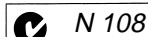
 N 108

Limited Two-year Warranty

Shure Incorporated ("Shure") hereby warrants that this product will be free from defects in materials and workmanship for a period of two years from date of purchase. At its option Shure will repair or replace the defective product and promptly return it to you, or refund the purchase price. You should retain proof of purchase to validate the purchase date and return it with any warranty claim.

If you believe this product is defective within the warranty period, carefully repack the unit, insure it, and return it postage prepaid to:

Shure Incorporated
Attention: Service Department
5800 W. Touhy Avenue
Evanston, Illinois 60714-4608 U.S.A.

Outside the United States, return the product to your dealer or Authorized Service Center.

This warranty does not apply in cases of abuse or misuse of the product, use contrary to Shure's instruction, or unauthorized repair. All implied WARRANTIES OF MERCHANTABILITY or FITNESS FOR A PARTICULAR PURPOSE are hereby disclaimed and Shure hereby disclaims liability for incidental, special, or consequential damages resulting from the use or unavailability of this product.

Some states do not allow limitations on how long an implied warranty lasts, or the exclusion or limitation of incidental or consequential damages, so the above limitation may not apply to you. This warranty gives you specific legal rights, and you may have other rights which vary from state to state.

FCC Declaration of Conformity

We of

Shure Incorporated
5800 W. Touhy Avenue
Evanston IL 60714-4608 U.S.A.
847-600-2000

declare under our sole responsibility that the following product,

Model: FP24 Name: FP24 Microphone mixer/preamplifier

was tested and found to comply with Part 15 of the FCC rules.

Operation is subject to the following two conditions: (1) this device may not cause harmful interference, and (2) this device must accept any interference received, including interference that may cause undesired operation.

Testing was completed by the following NVLAP or A2LA accredited laboratory:

L.S. Compliance, Inc.
W66 N220 Commerce Court
Cedarburg, Wisconsin 53012
Telephone 262-375-4400
Fax 262-375-4248

Shure Incorporated, Manufacturer.

Signed:

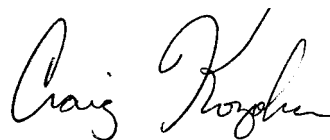

Date: Sept. 15, 2000

Name, Title: Craig Kozokar, Project Engineer, EMC

SHURE®

SHURE Incorporated Web Address: <http://www.shure.com>
5800 W. Touhy Avenue, Niles, IL 60714-4608, U.S.A.
In U.S.A., Phone: 1-847-600-2000 Fax: 1-847-600-1212
In Europe, Phone: 49-7131-72140 Fax: 49-7131-721414
In Asia, Phone: 1-852-2893-4290 Fax: 1-852-2893-4055
International Fax: 1-847-600-6446

Free Manuals Download Website

<http://myh66.com>

<http://usermanuals.us>

<http://www.somanuals.com>

<http://www.4manuals.cc>

<http://www.manual-lib.com>

<http://www.404manual.com>

<http://www.luxmanual.com>

<http://aubethermostatmanual.com>

Golf course search by state

<http://golfingnear.com>

Email search by domain

<http://emailbydomain.com>

Auto manuals search

<http://auto.somanuals.com>

TV manuals search

<http://tv.somanuals.com>