



AT&T Mobile Hotspot Elevate 4G

User Guide



SIERRA
WIRELESS™

2400154
Rev 2

Important Notice

Due to the nature of wireless communications, transmission and reception of data can never be guaranteed. Data may be delayed, corrupted (i.e., have errors) or be totally lost. Although significant delays or losses of data are rare when wireless devices such as the AT&T Mobile Hotspot Elevate 4G are used in a normal manner with a well-constructed network, the AT&T Mobile Hotspot Elevate 4G should not be used in situations where failure to transmit or receive data could result in damage of any kind to the user or any other party, including but not limited to personal injury, death, or loss of property. Sierra Wireless accepts no responsibility for damages of any kind resulting from delays or errors in data transmitted or received using the AT&T Mobile Hotspot Elevate 4G, or for failure of the AT&T Mobile Hotspot Elevate 4G to transmit or receive such data.

Safety and Hazards

Do not operate the AT&T Mobile Hotspot Elevate 4G in areas where blasting is in progress, where explosive atmospheres may be present, near medical equipment, near life support equipment, or any equipment which may be susceptible to any form of radio interference. In such areas, the AT&T Mobile Hotspot Elevate 4G **MUST BE POWERED OFF**. The AT&T Mobile Hotspot Elevate 4G can transmit signals that could interfere with this equipment.

Do not operate the AT&T Mobile Hotspot Elevate 4G in any aircraft, whether the aircraft is on the ground or in flight. In aircraft, the AT&T Mobile Hotspot Elevate 4G **MUST BE POWERED OFF**. When operating, the AT&T Mobile Hotspot Elevate 4G can transmit signals that could interfere with various onboard systems.

The driver or operator of any vehicle should not operate the AT&T Mobile Hotspot Elevate 4G while in control of a vehicle. Doing so will detract from the driver or operator's control and operation of that vehicle. In some states and provinces, operating such communications devices while in control of a vehicle is an offence.

Limitation of Liability

The information in this manual is subject to change without notice and does not represent a commitment on the part of Sierra Wireless. SIERRA WIRELESS AND ITS AFFILIATES SPECIFICALLY DISCLAIM LIABILITY FOR ANY AND ALL DIRECT, INDIRECT, SPECIAL, GENERAL, INCIDENTAL, CONSEQUENTIAL, PUNITIVE OR EXEMPLARY DAMAGES INCLUDING, BUT NOT LIMITED TO, LOSS OF PROFITS OR REVENUE OR ANTICIPATED PROFITS OR REVENUE ARISING OUT OF THE USE OR INABILITY TO USE ANY SIERRA WIRELESS PRODUCT, EVEN IF SIERRA WIRELESS AND/OR ITS AFFILIATES HAS BEEN ADVISED OF THE POSSIBILITY OF SUCH DAMAGES OR THEY ARE FORESEEABLE OR FOR CLAIMS BY ANY THIRD PARTY.

Notwithstanding the foregoing, in no event shall Sierra Wireless and/or its affiliates aggregate liability arising under or in connection with the Sierra Wireless product, regardless of the number of events, occurrences, or claims giving rise to liability, be in excess of the price paid by the purchaser for the Sierra Wireless product.

Patents

This product may contain technology developed by or for Sierra Wireless Inc. This product includes technology licensed from QUALCOMM®. This product is manufactured or sold by Sierra Wireless Inc. or its affiliates under one or more patents licensed from InterDigital Group.

Copyright

© 2012 Sierra Wireless. All rights reserved.

Trademarks

Sierra Wireless™, and the Sierra Wireless logo are trademarks of Sierra Wireless. LTE™ is a trademark of ETSI, AT&T, the AT&T logo and all other AT&T marks contained herein are trademarks of AT&T Intellectual Property and/or AT&T affiliated companies. All other marks contained herein are the property of their respective owners.

MiniUPnPd

Copyright (c) 2006-2011, Thomas BERNARD. All rights reserved.

Redistribution and use in source and binary forms, with or without modification, are permitted provided that the following conditions are met:

- Redistributions of source code must retain the above copyright notice, this list of conditions and the following disclaimer.
- Redistributions in binary form must reproduce the above copyright notice, this list of conditions and the following disclaimer in the documentation and/or other materials provided with the distribution.
- The name of the author may not be used to endorse or promote products derived from this software without specific prior written permission.

THIS SOFTWARE IS PROVIDED BY THE COPYRIGHT HOLDERS AND CONTRIBUTORS "AS IS" AND ANY EXPRESS OR IMPLIED WARRANTIES, INCLUDING, BUT NOT LIMITED TO, THE IMPLIED WARRANTIES OF MERCHANTABILITY AND FITNESS FOR A PARTICULAR PURPOSE ARE DISCLAIMED. IN NO EVENT SHALL THE COPYRIGHT OWNER OR CONTRIBUTORS BE LIABLE FOR ANY DIRECT, INDIRECT, INCIDENTAL, SPECIAL, EXEMPLARY, OR CONSEQUENTIAL DAMAGES (INCLUDING, BUT NOT LIMITED TO, PROCUREMENT OF SUBSTITUTE GOODS OR SERVICES; LOSS OF USE, DATA, OR PROFITS; OR BUSINESS INTERRUPTION) HOWEVER CAUSED AND ON ANY THEORY OF LIABILITY, WHETHER IN CONTRACT, STRICT LIABILITY, OR TORT (INCLUDING NEGLIGENCE OR OTHERWISE) ARISING IN ANY WAY OUT OF THE USE OF THIS SOFTWARE, EVEN IF ADVISED OF THE POSSIBILITY OF SUCH DAMAGE.

>> Contents

Get Started	8
Know Your Device	8
Manage your device and settings	8
Power Button	9
Mute Switch	9
LCD	9
Power LED	12
Included Accessories	12
Optional Accessories	12
Power Sources	12
Additional LCD screens	13
Set Up and Connect to the Internet	13
Connect to the Internet	14
AirCard Watcher App for Smartphones and Tablets	15
Homepage	15
Security Credentials	17
Use Your Mobile Hotspot	18
Set Auto Connect Options	18
View Data Usage	19
Enable / Disable Wi-Fi	20
View / Block Connected Users	20
Add a Wireless Device to your Wi-Fi Network	21
View SMS Messages and Alerts	23
Use the GPS Feature	24
Battery Settings	25
Extend Battery Life	25
Set Audio Alerts	27
Change Device Security Settings	28
View Details About Your Mobile Hotspot	29

Use the microSD Card to Share Files over Wi-Fi	29
Before you Begin	30
Share or Access Files over Wi-Fi	31
Recharge the Battery	33
Update the Firmware	34
Replace the SIM Card	36
Advanced Settings	38
Do not Automatically Install Driver for USB Tethering	38
Export / Import Router Options.	39
Set Display Options	39
Set Audio Alerts	40
View and Save Device Information	41
View WAN Information	42
Set Connection Preferences	43
Enable SIM Security.	44
View Wi-Fi Status and List of Connected Devices	45
Set Wi-Fi Network Options.	45
Set Wi-Fi Security Options	46
Set MAC Filter Mode	47
Enable Port Forwarding	48
Enable Port Filtering.	48
Enable VPN Passthrough.	49
Enable DMZ	50
Enable Universal Plug and Play.	51
Set Router LAN Options.	51
Frequently Asked Questions	53
Troubleshooting	56
Reset the Mobile Hotspot.	58

Alerts	60
Specifications	63
Mechanical Specifications	63
Environmental Specifications	63
Regulatory and Safety Information	64
Notice	64
Safety and Hazards	64
Regulatory Information for North America	65
Index	67

>> 1: Get Started

1

This chapter provides an overview of the AT&T Mobile Hotspot Elevate 4G* features, and instructions on how to set up your mobile hotspot and connect to the Internet.

Know Your Device

Your mobile hotspot enables you to create a Wi-Fi access point anywhere in the AT&T coverage area. You can use that Wi-Fi access point to connect your laptop and other Wi-Fi capable devices to AT&T's mobile broadband network and connect to the Internet.

You can also use your mobile hotspot in tethered mode by connecting it to your laptop with the USB cable to access the Internet.

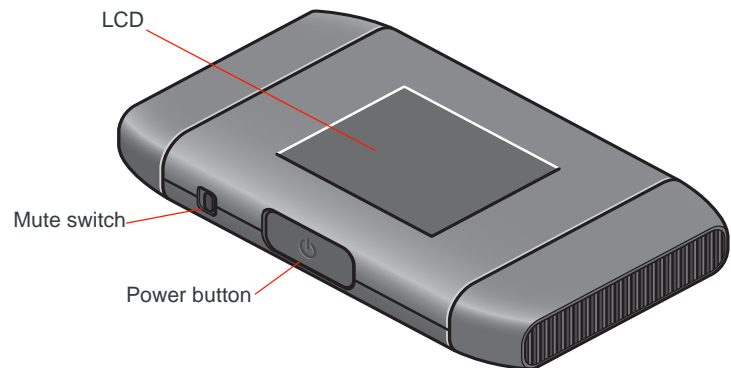

Manage your device and settings

You can manage your device and change settings using:

- The device [LCD](#) (see page 9)
- The [Homepage](#) (see page 15)
- [AirCard Watcher App for Smartphones and Tablets](#) (see page 15)

* Limited 4G LTE availability in select markets. 4G speeds delivered by HSPA+ (with enhanced backhaul) and LTE, where available. Compatible 4G device and data plan required. LTE is a trademark of ETSI. Learn more at att.com/network.

Power Button

Desired result	Action
Turn mobile hotspot on	Press and hold the power button for a few seconds.
Turn mobile hotspot off	Press and hold the power button for a few seconds.
Wake up LCD screen	Press and quickly release the power button.
View additional LCD screens	Press the power button.
Respond to prompts on the LCD screen	Double-press the power button when prompted to do so by the LCD screen. (This is used to confirm an action.)

Mute Switch

The mobile hotspot automatically beeps when the battery is low, when you receive a message, etc. To turn these beeps off, move the mute switch so the red rectangle is visible. On the homepage, <http://att.elevate>, you can customize your hotspot to beep when specific changes in status occur. For more information, see [Set Audio Alerts](#) on page 27.

LCD

As well as providing setup information (Wi-Fi SSID (Network Name) and Wi-Fi Key) the mobile hotspot Main LCD screen displays:

- Instructions during setup
- Status messages such as “Searching for network”, “Connected”, etc.
- Status icons (See [Icons on the LCD Screen](#) on page 10 for details.)
- Data usage meter
- Network name
- Error messages (See [Alerts](#) on page 60 for troubleshooting suggestions.)

Press the power button to cycle through the following additional screens:

- Wi-Fi Protected Setup (WPS) instructions—a fast, easy way to connect WPS-enabled devices to your Wi-Fi network
- Web Interface
- Messages / Alerts
- About Elevate

To personalize the mobile hotspot and change the settings, connect to AT&T’s mobile broadband network and go to the homepage (<http://att.elevate>).

Icons on the LCD Screen



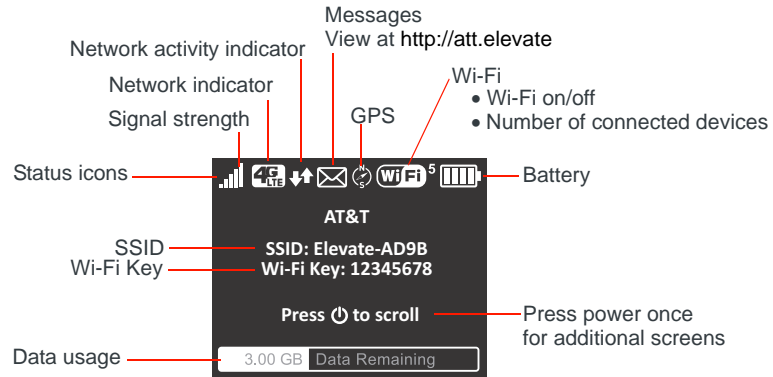

The icons on the LCD screen indicate the status of the mobile hotspot.

Home Screen

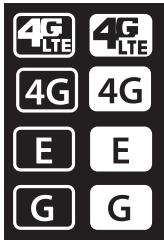

To access the Wi-Fi Protected Setup (WPS) screen, press the power button.

Icon	Indicates
	Signal strength The more bars, the stronger the RF signal.
	No signal.

Icon	Indicates
	<p>The type of network available.* 4GLTE —LTE 4G—HSPA, HSPA+ E—EDGE G—GPRS</p> <p>If the Network icon has a white background, the hotspot is connected to the network.</p> <p>If the Network icon has a black background, service is available, but the hotspot is not connected to the network.</p> <p>For network connection instructions, see Set Up and Connect to the Internet on page 13.</p> <p>Your 4G LTE wireless device will indicate which of AT&T's wireless networks you are connected to. A network indicator does not necessarily mean that you will experience any particular upload or download data speeds.</p> <p>4G LTE: Connected to AT&T's 4G LTE network.</p> <p>4G*: Connected to AT&T's HSPA+ network. AT&T's HSPA+ network is capable of delivering 4G speeds when combined with enhanced backhaul. 4G availability is increasing with ongoing backhaul deployment.</p> <p>E: Connected to AT&T's EDGE/2G network</p> <p>Actual data upload and download speeds depend on various factors, including the device, network utilization, file characteristics, terrain, etc. Learn more at wireless.att.com/learn/articles-resources/wireless-terms.jsp, your AT&T Wireless Customer Agreement, Section 3.2 Where and How Does AT&T Service Work?</p> <p>*AT&T's HSPA+ network can deliver 4G speeds when combined with enhanced backhaul. Your wireless device can't distinguish between HSPA+ cell sites with enhanced backhaul and those without. Enhanced backhaul not available everywhere. Learn more at att.com/network.</p>
	<p>Network activity</p> <p>A solid white icon indicates network activity:</p> <ul style="list-style-type: none"> Up-arrow indicates data being uploaded to the network Down-arrow indicates data being downloaded from the network <p>A white outlined arrow indicates no network activity</p>
	<p>Messages</p> <p>You have messages from AT&T or alerts (generated by the device) that indicate a change in the device's status. To view your messages and/or alerts, go to the homepage (http://att.elevate) and click the Messages icon.</p>
	<p>GPS</p> <p>When the needle on the GPS icon flashes, the mobile hotspot is trying to obtain a satellite fix or is tracking a location.</p>

Icon	Indicates
	<p>Wi-Fi</p> <p>The number beside the Wi-Fi icon shows the number of users (devices) connected to your Wi-Fi network.</p> <p>Wi-Fi radio is disabled or in standby mode. To adjust the standby mode timer, see Extend Battery Life on page 25. For information on enabling Wi-Fi, see page 56 — The Wi-Fi radio is disabled icon appears on the LCD screen.</p>
	<p>Battery status</p> <p>Indicates the charge status of the battery</p> <p>4 bars — 80–100%</p> <p>1 bar — 10–29%</p>
	<p>Battery outline (no bars) — 0–9%</p> <p>Recharge immediately.</p>
	<p>Battery charging.</p>
	<p>No battery.</p> <p>The mobile hotspot is powered on and connected to the AC charger.</p>
	<p>The battery is charging through a USB connection.</p>

Power LED

The blue LED on the top of the mobile hotspot flashes:

- Slowly to indicate that it is powered on
- Quickly when the firmware is being updated

Included Accessories

- Micro USB cable—Used mainly for recharging the battery, although you can also use it to tether the mobile hotspot to your computer
- AC adapter—Used with the USB cable to recharge the battery or to power the mobile hotspot from a wall socket

For more information, see [Recharge the Battery](#) on page 33.

Optional Accessories

Additional accessories are available from www.sierrawireless.com/wheretobuy/onlinestore/default.aspx.

Power Sources

You can power your mobile hotspot from:

- Rechargeable battery included with the mobile hotspot

- USB port on your computer
- Wall socket using the AC adapter and USB cable

Additional LCD screens

New

Press the power button (⏻) to scroll through additional LCD screens:

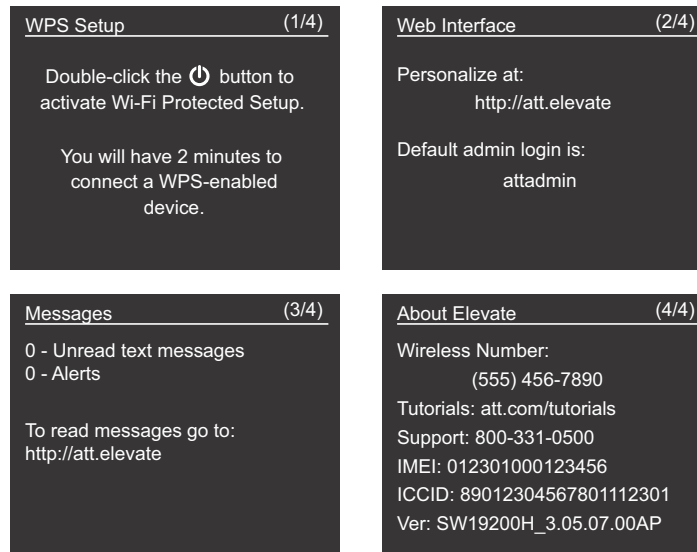

Set Up and Connect to the Internet

Install the Battery

1. Insert the battery as shown in the illustration. Ensure that the gold contacts on the battery are lined up with the gold contacts on the device.

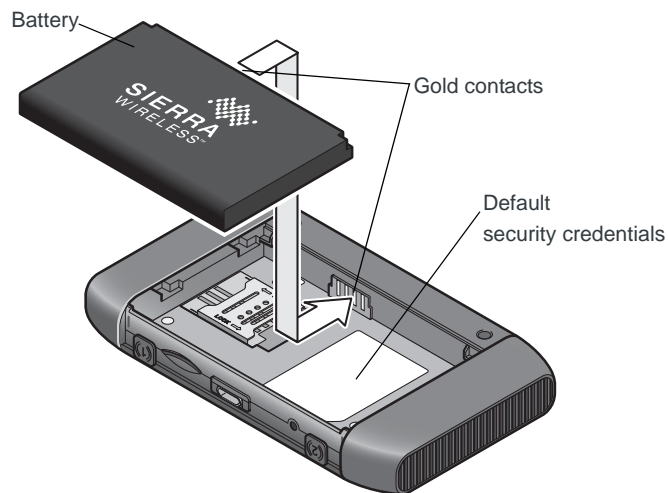

2. Replace the back cover.

Note: The battery comes partially-charged and ready to go. You do not need to charge it fully unless you wish to. When the battery needs recharge, follow the instructions in [Recharge the Battery](#) on page 33.

Connect to the Internet

Note: Your mobile hotspot does not need to be connected to the computer with the USB cable to connect to the Internet. The USB cable is used mainly for recharging the battery. (If you want to connect to the Internet with the mobile hotspot tethered to the laptop using the USB cable, see [Tethered mode](#) on page 14 before connecting for the first time.)

To connect to the Internet:

1. Turn on the mobile hotspot.
Press and hold the power button for a few seconds.
The first time you connect a computer to the mobile hotspot network, the LCD screen displays the message "Connect your computer to Wi-Fi network". The Wi-Fi SSID (Network Name) and the Wi-Fi Key are shown on the LCD screen.

Note: The LCD screen may go into sleep mode to save power. To wake up the LCD screen, press and quickly release the power button.

2. Connect your computer or other device to your Wi-Fi network.
 - a. On your computer, view the list of available Wi-Fi networks.
 - b. Select the Wi-Fi SSID (Network Name) displayed on the mobile hotspot LCD screen, and connect to it.
 - c. When prompted, enter your Wi-Fi Key as it appears on the mobile hotspot LCD screen.
3. Launch your browser to surf the Internet.
Optional: To personalize your mobile hotspot go to <http://att.elevate>.

*Note: To make changes to the mobile hotspot settings on the homepage, you must first log in as Administrator. Type **attadmin** in the Admin Login box.*

Tethered mode^{*}

The first time you use your mobile hotspot in tethered mode (connected to a computer using the USB cable):

1. Ensure that the mobile hotspot is powered off.
2. Use the USB cable to connect the mobile hotspot to your computer.

^{*} Enterprise variant available with microSD and WPS functionality disabled and drivers supporting tethering removed.

The mobile hotspot automatically powers on and installs the necessary driver.

3. Once the driver is installed, you can surf the net or go to the homepage <http://att.elevate> to customize your mobile hotspot.

AirCard Watcher App for Smartphones and Tablets



Download the complimentary AirCard Watcher app from www.sierrawireless.com/AirCardApps. Use this app to view your connection, settings, and data usage from your smartphone or tablet. To manage all hotspot settings, go to the homepage <http://att.elevate>.

Homepage

Your mobile hotspot comes configured, perfectly secure and ready to use, but if you want to change the security settings, the Wi-Fi SSID (Network Name) and other settings, go to your mobile hotspot's homepage.

The homepage URL (<http://att.elevate>) is shown on the LCD during setup. You can also find it in the Quick Start Guide that came with your mobile hotspot.

To make changes to the settings on the homepage, you must be logged in as Administrator (default Admin Login is **attadmin**).

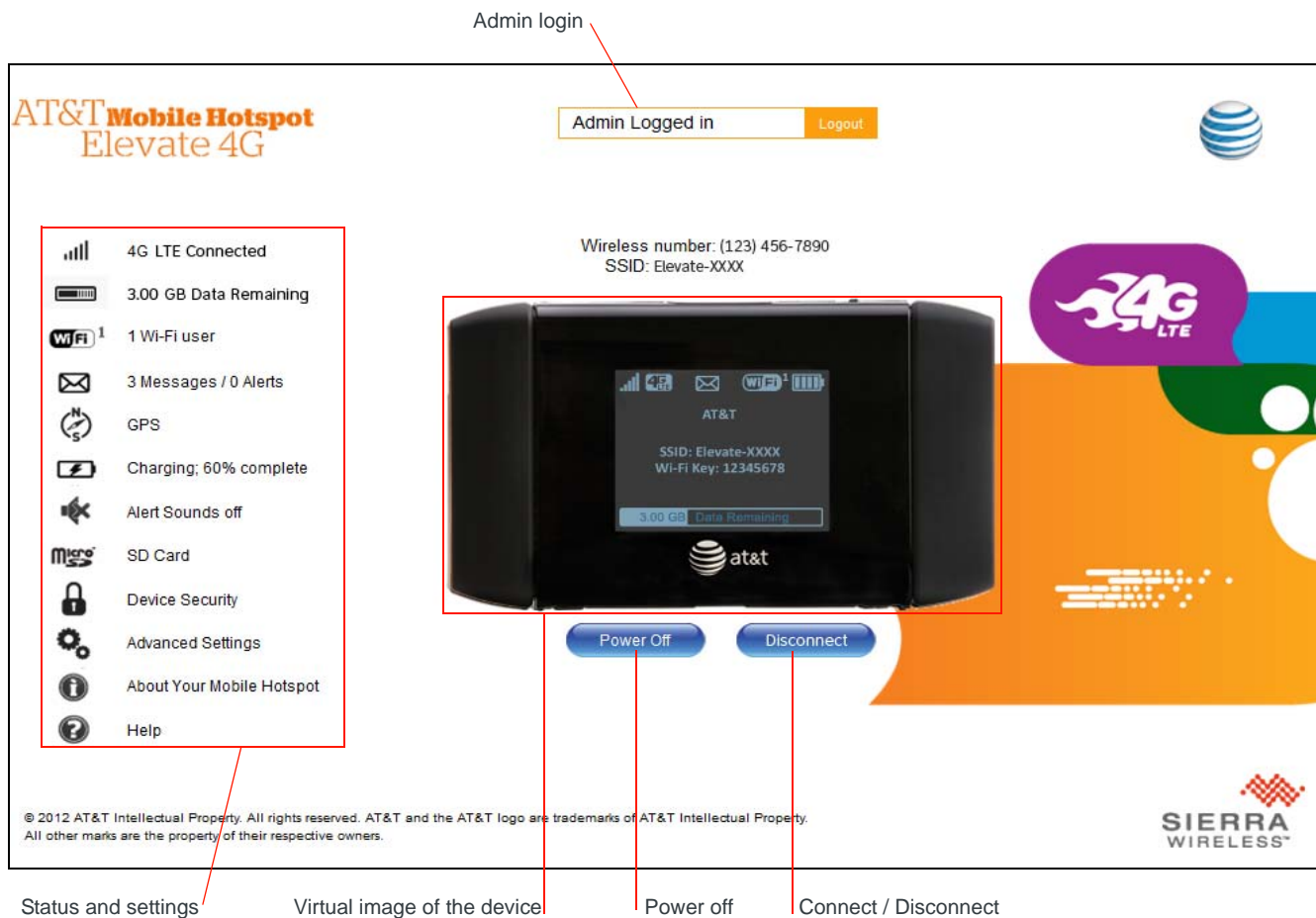

You can view some information about the device without being logged in as Administrator, but to view detailed information and to change any settings and use some features, you must be logged in as Administrator.

To log in as Administrator:

1. Place your cursor in the Admin Login box and type **attadmin** (the default Admin Login).
2. Click OK.

Once you are logged in as Administrator, you can view detailed information and change mobile hotspot settings, such as:

- Change the SSID, Wi-Fi Key, Admin Login, and Wi-Fi encryption
- Set autoconnect options
- Set GPS options
- Use GPS to track or map your location and find nearby amenities
- Set battery options
- View data usage
- Set audio alerts
- Change advanced settings such as security settings and router options

Security Credentials

Two passwords are associated with the mobile hotspot:

- **Wi-Fi Key**— Used to connect your computer or other Wi-Fi device to your mobile hotspot network. This Key is unique to your device. It is displayed on the main mobile hotspot LCD screen. If the screen is blank (a power-saving feature), press and quickly release the power button to view the information on the screen. The default Wi-Fi Key is also printed on a label under the battery.
- **Admin Login**— Used to log into the homepage as Administrator. You must be logged in as Administrator to use certain features and to make changes to your mobile hotspot settings. The default Admin Login, **attadmin**, is printed on a label under the battery. The Admin Login can be 5–31 characters.

2: Use Your Mobile Hotspot

This chapter provides information on how to use your mobile hotspot.

Note: To change settings you need to be logged in as Administrator. See [Set Up and Connect to the Internet](#) on page 13.

Set Auto Connect Options

By default, the mobile hotspot automatically connects to AT&T's mobile broadband network. You can change this feature so that the mobile hotspot automatically connects to another network when you are roaming, or to never auto connect.

To select the auto connect options:

1. On the Mobile Hotspot Homepage, log in as Administrator.
2. Click the Signal Strength icon ().

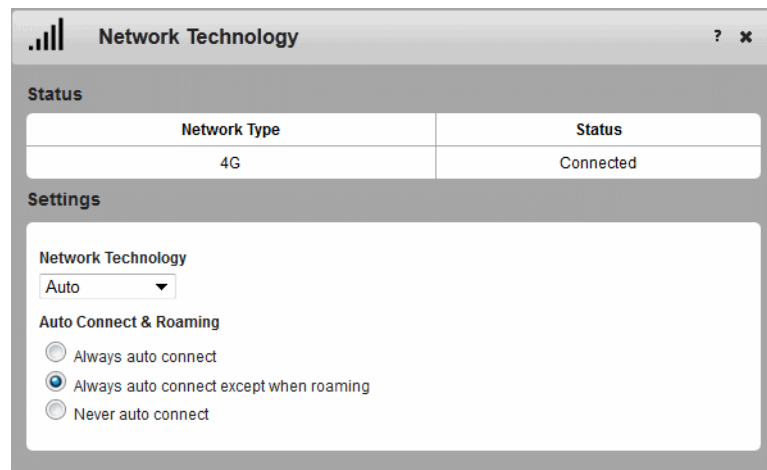

3. If desired, under Network Technology, select the desired option from the drop-down menu.

Note: For most users, it's best to leave the default setting (Auto). When this option is selected, your mobile hotspot connects to the fastest service available. If you change this setting, the mobile hotspot will not be able to connect if the option you choose is not available. For example, if you select 4G LTE from the drop-down menu and you are in an area where there is no 4G LTE network available, the mobile hotspot will not be able to connect to a mobile broadband network until you change this setting.

4. Under Auto Connect & Roaming, select the desired option:
 - Always auto connect—The mobile hotspot automatically attempts to connect to the mobile broadband network when powered on. You may incur additional roaming charges if you are outside of the AT&T coverage area.

- Always auto connect except when roaming—The mobile hotspot automatically attempts to connect only to AT&T's mobile broadband network when powered on (default).
- Never auto connect—The mobile hotspot will not attempt to automatically connect to the mobile broadband network when powered on.

If you choose this option, press the power button and follow the instructions on the LCD screen to connect, or go to the homepage (<http://att.elevate>) and click Connect. See [page 13](#) for more information.

5. Click Save. (Save button appears once you make a selection.)

View Data Usage

You can view an estimate of your data usage (not accurate for billing purposes) on the homepage and on the LCD screen.

On the LCD screen:

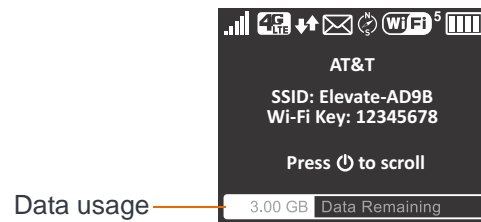

On the homepage:

1. Go to the homepage and log in as Administrator.
2. Click the Data Usage icon () on the left side of the screen.
3. The bar graph shows your data usage.

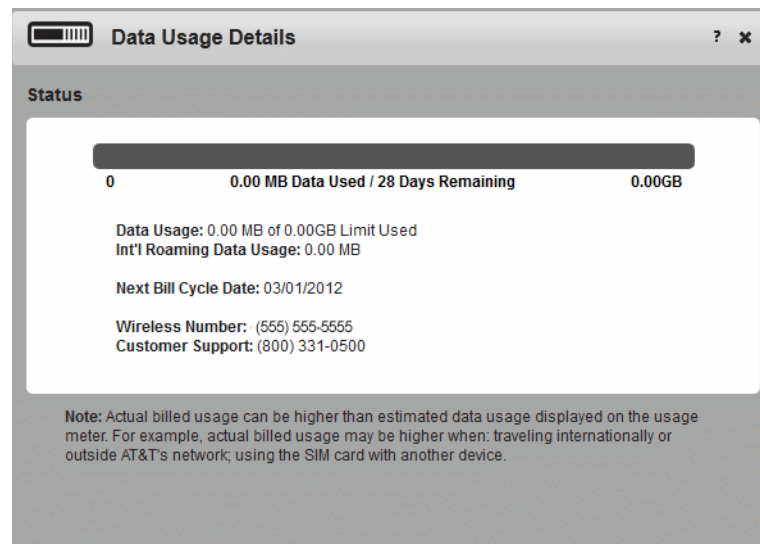

The billing cycle (typically a month) is available on your bill.

Enable / Disable Wi-Fi

By default, Wi-Fi is enabled, but if your place of business does not allow Wi-Fi or for any reason you want to disable Wi-Fi and use the mobile hotspot only in tethered mode, the mobile hotspot gives you that option.

To enable / disable your Wi-Fi network:

1. On the Mobile Hotspot Homepage, log in as Administrator.
2. Click the Wi-Fi icon (¹).

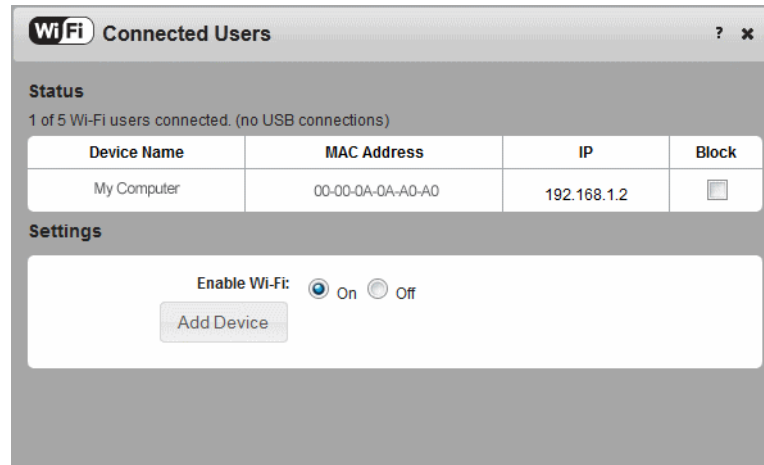

3. Under Settings, select the desired option.
4. Click Save. (Save button appears once you make a selection.)

View / Block Connected Users

To view a list of devices connected to your mobile hotspot and block undesired users:

1. On the Mobile Hotspot Homepage, log in as Administrator.
2. Click the Wi-Fi icon (¹).

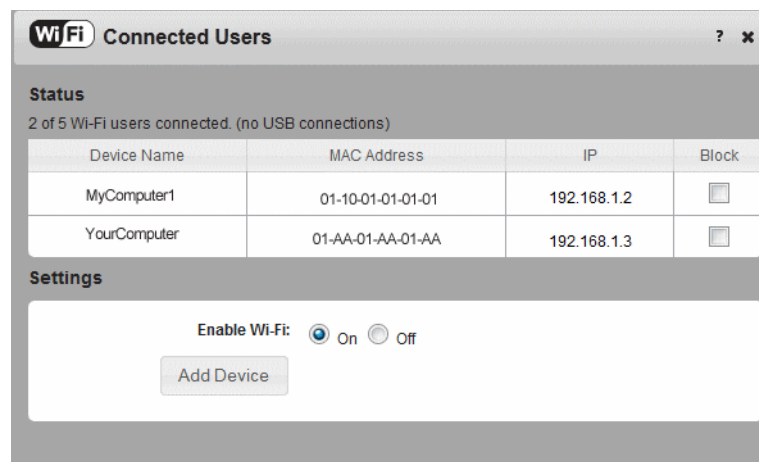

If you notice a user or Wi-Fi device that you do not recognize, you can block that device from connecting to your Wi-Fi network.

To block a user (or device):

1. Select the box beside the device in the Block column.
2. Click Save. (Save button appears once you make a selection.)

To unblock a user and allow that device access to your network, see [Set MAC Filter Mode](#) on page 47.

Add a Wireless Device to your Wi-Fi Network

You can connect up to five wireless devices such as smartphones, laptops, tablets, digital cameras, printers, gaming consoles, and digital picture frames to your mobile hotspot network.

You can use the Mobile Hotspot Homepage or the device LCD screen (press the power button to view WPS* instructions) to add additional wireless devices to your Wi-Fi network.

From the Mobile Hotspot Homepage

To add devices using the Mobile Hotspot Homepage:

1. On the Mobile Hotspot Homepage, log in as Administrator.
2. Click the Wi-Fi icon (¹).

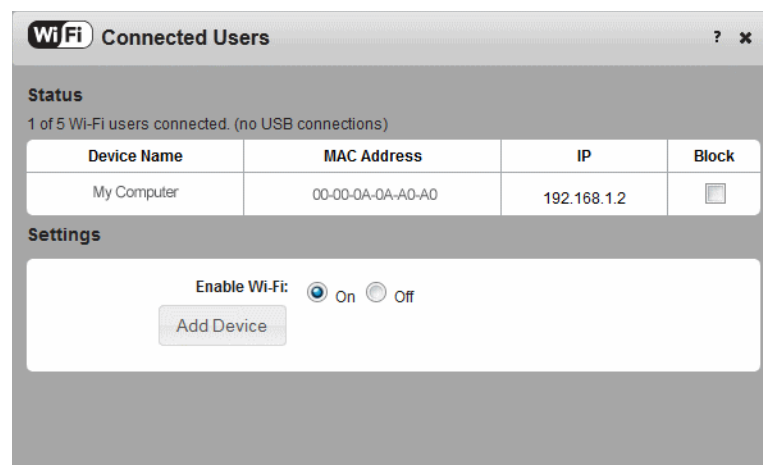

3. Click the Add Device button.

* Enterprise variant available with microSD and WPS functionality disabled and drivers supporting tethering removed.

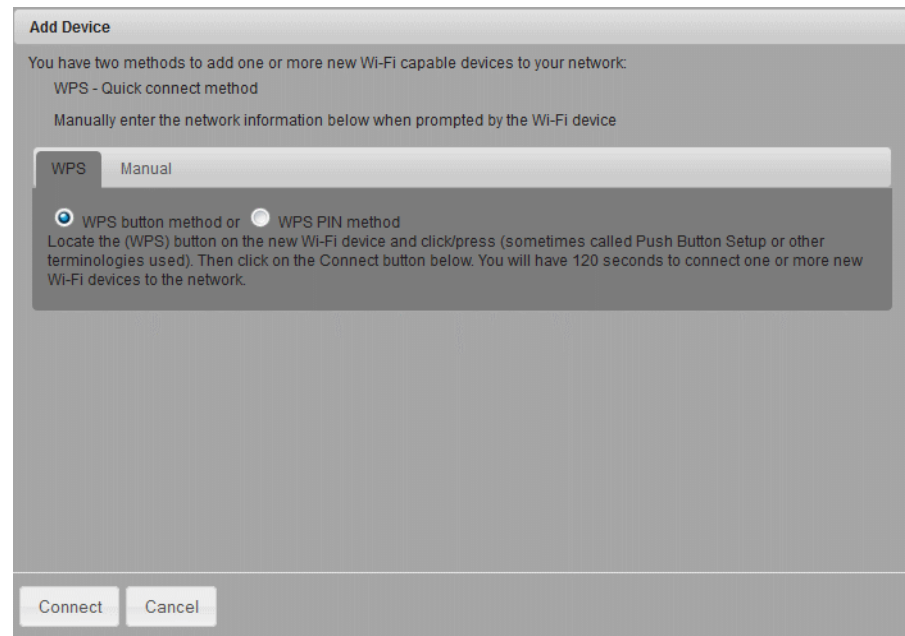

4. Select WPS— For WPS-enabled Wi-Fi devices or Manual—For any Wi-Fi device
 - If you choose the WPS button method:
 - a. Click the Connect button.
 - b. Within 2 minutes, press the WPS button on the wireless device you want to connect.

Your mobile hotspot and the wireless device will communicate and establish the connection.

If you choose WPS PIN method, you'll be asked to enter a PIN to connect to your Wi-Fi network.

If you choose the Manual option:

 - a. Open the Wi-Fi menu on the device you want to connect and view the list of available networks.
 - b. Select the mobile hotspot SSID (Wi-Fi network name) displayed on the LCD screen (e.g. Elevate-xxx).
 - c. Select Connect and enter the Wi-Fi Key displayed on the LCD screen.

From the Mobile Hotspot LCD

You can also connect using the LCD screen without going to the homepage.

To connect a wireless device using the device LCD:

WPS Method

1. On your mobile hotspot, press the power button to view the WPS Setup screen.
2. Press the power button again to enable WPS.
3. Within 2 minutes, press the WPS button on the wireless device you want to connect.

Your mobile hotspot and the wireless device will communicate and establish the connection.

Manually

1. On your wireless device, view the list of available Wi-Fi networks.
2. Connect to the network that corresponds to your mobile hotspot network, as displayed on the LCD.
3. When prompted, enter the Wi-Fi Key for your mobile hotspot network. The Wi-Fi Key is displayed on the mobile hotspot LCD screen. If the screen has turned off to save power, press and quickly release the power button to wake up the screen.

View SMS Messages and Alerts

Your mobile hotspot can receive SMS messages from AT&T and displays alerts to advise you of the device status. The message icon (✉) on the device LCD indicates that you have a message or alert.

To view the message / alert:

1. On the Mobile Hotspot Homepage, log in as Administrator.
2. Click the Messages / Alerts icon (✉).

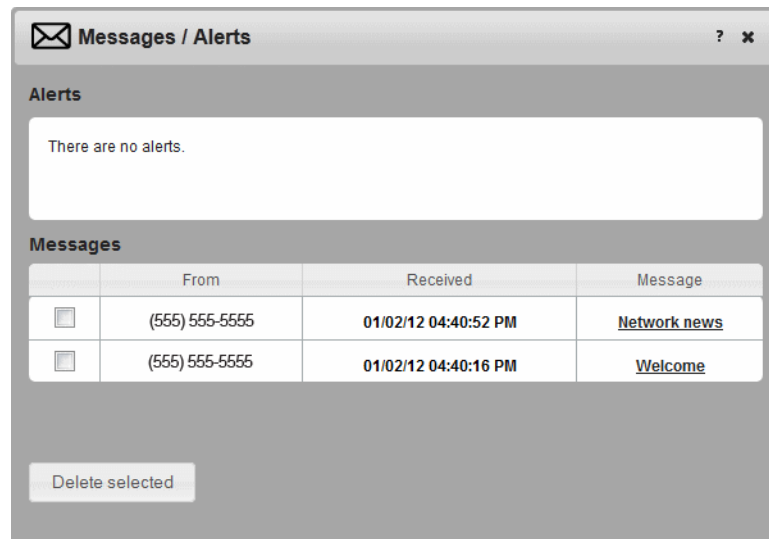

3. Double-click the message or alert subject line to view the entire message / alert.

To delete a message, select the desired message and then click Delete selected.

Note: By default, you receive an audio alert when the mobile hotspot receives an SMS message / alert. For more information on Audio alerts, see [Set Audio Alerts](#) on page 27.) You cannot delete alerts. They are deleted automatically when the device status changes.

Use the GPS Feature

1. On the Mobile Hotspot Homepage, log in as Administrator.
2. Click the GPS icon (📍).

GPS Information and Settings

Status

GPS

Latitude: Longitude:
 Altitude: Speed:
 Heading: Satellites:
 HEPE: Timestamp:

Get GPS Location Start GPS Tracking Map Me

Settings

Mapping service: Google Maps
 Type: Standalone
 Use Metric Units:

3. If desired, select the GPS type:
 - Standalone— Uses only radio signals from satellites (default)
 - A-GPS-MS Based — Assisted GPS — Uses network resources to help locate and use satellite signals faster. A-GPS is also better at acquiring a GPS fix in poor signal conditions.
4. Optional: For metric units, select the box beside Use Metric Units.
5. Click Save.
6. Select the desired option:
 - Get GPS Location (One-time satellite fix)
 - Start GPS Tracking (Continuous tracking)

The needle on the GPS icon (📍) flashes while the mobile hotspot is attempting to get a GPS fix.

If you have trouble obtaining a fix, ensure that the device has an unobstructed view of the sky and you are not near tall buildings or other barriers that could be blocking the GPS satellite signal.

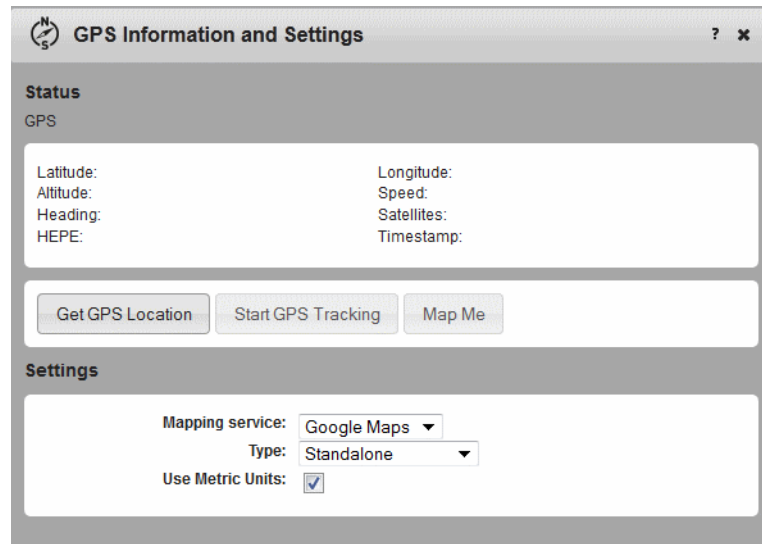

7. If desired, select a mapping service.
8. Optional: Click the Map Me button to view your location on a map and search for nearby amenities.

Battery Settings

The mobile hotspot, by default, is configured to optimize battery life. Battery life is affected by:

- Standby time
- Data throughput
- GPS option (GPS tracking uses more power than getting a single GPS location fix.)
- Mobile Broadband signal strength (the better the signal, the longer the battery life)
- Wi-Fi range:
 - Short Wi-Fi range—Extend battery life
 - Medium Wi-Fi range—Intermediate battery life and Wi-Fi range
 - Long Wi-Fi range—Enables you to have your laptop (or other Wi-Fi device) further from your mobile hotspot and still connect to your Wi-Fi network, but battery life is shorter.

Extend Battery Life

There are several methods you can use to extend the battery life.

If the computer and other devices you are connecting to your Wi-Fi network are always close to the mobile hotspot device, you can increase the battery life by shortening the Wi-Fi range.

1. Go to the Mobile Hotspot Homepage and log in as Administrator. (See [Homepage](#) on page 15.)

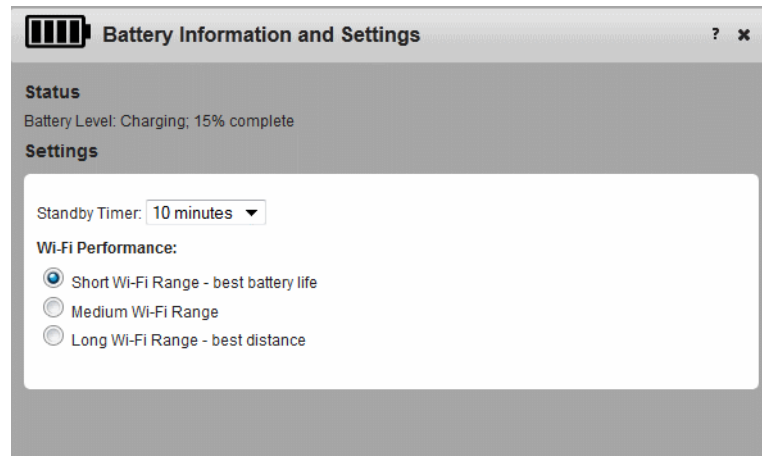

2. Click the Battery icon () and select Short Wi-Fi range.
3. Click Save. (Save button appears once you make a selection.)

You can also extend the battery life by adjusting the Power LED and LCD backlight settings.

1. Go to the homepage and log in as Administrator.
2. Click the Advanced Settings icon ().
3. Select the Device tab and then select Display.

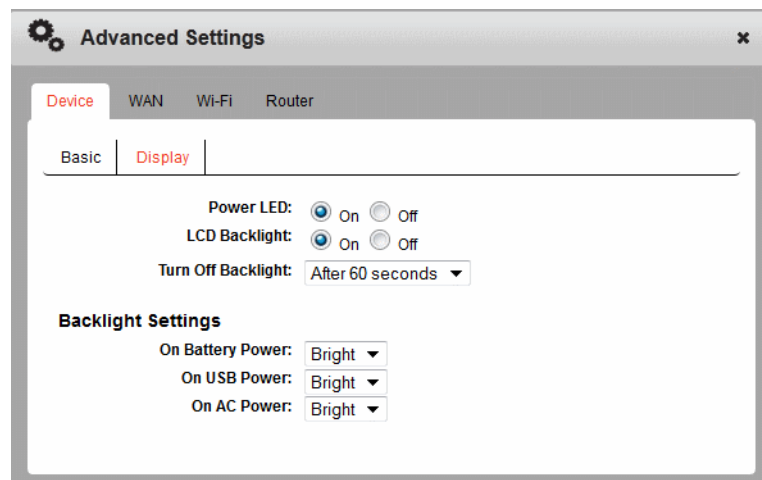

4. Set the desired options. For example, you can:
 - Turn the Power LED and LCD backlight off.
 - Set the time after which the LCD backlight turns off. (The shorter the time, the longer the battery life.)
 - Set the LCD backlight to DIM.
5. Click Save. (Save button appears once you make a selection.)

Another way to extend the battery life is to adjust the Standby Timer. The Standby Timer sets the length of time the mobile hotspot remains active when no devices are connected to the Wi-Fi network.

To set the Standby Timer:

1. On the homepage, log in as Administrator.
2. Click the Battery icon ().
3. In the drop-down list beside Standby Timer on Battery, select the desired time. (The shorter the time, the longer the battery life.)
4. Click Save. (Save button appears once you make a selection.)

Set Audio Alerts

You can configure your mobile hotspot to sound an alert when the status changes. For example:

- When the connection status changes
- When you receive an SMS message
- When the battery is low
- When the mobile hotspot enters standby mode

To turn off all audio alerts, set the mute switch on the mobile hotspot so that the red rectangle is visible.

To choose which changes in status are accompanied by an audio alert:

1. Set the mute switch so that the red rectangle is not visible.
2. On the Mobile Hotspot Homepage, click the Alert Sounds icon ().

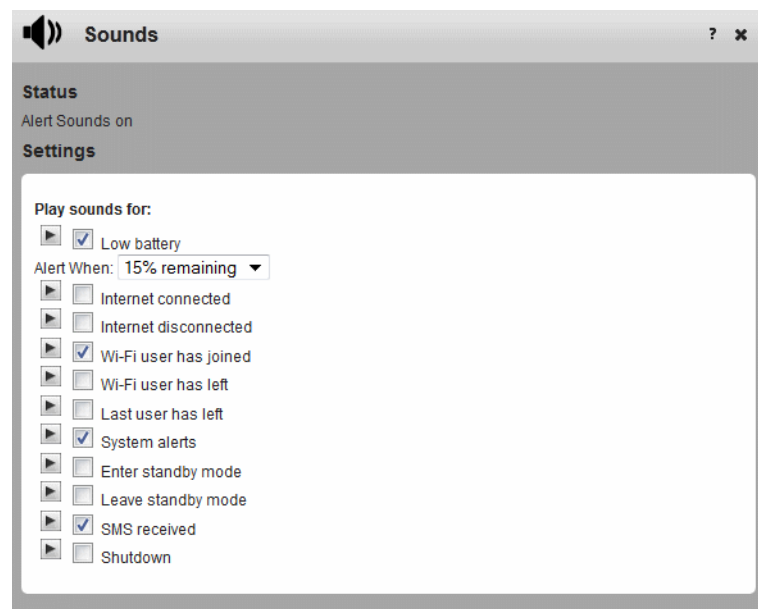

3. Select the desired options.
4. Click Save. (Save button appears once you make a selection.)

Change Device Security Settings

To change security settings such as Admin Login, SSID, Wi-Fi encryption, and Wi-Fi Key:

1. On the Mobile Hotspot Homepage, click the Device Security icon (🔒).

The screenshot shows a web interface for 'Device Security'. It contains the following fields and controls:

- Administrator Login:** attadmin
- SSID:** Elevate-1234
- Show SSID on device:**
- Wi-Fi encryption:** WPA2 Personal AES (dropdown menu)
- Wi-Fi Key:** 12345678
- Wi-Fi Key visible on device:**

2. Change the desired options.

By default, the Wi-Fi Key is shown on the LCD screen. If you do not want it to appear on your LCD screen, deselect the box beside Show Wi-Fi Key on device.

The Wi-Fi encryption options are:

- WPA2 Personal/AES — Strong security supported by newer Wi-Fi devices (default)
- WPA/WPA2 Personal — Strong security supported by most Wi-Fi devices (Use this if you want to connect Wi-Fi devices that do not support WPA2 Personal AES.)
- None — Not recommended. Anyone can access your Wi-Fi network without a password and you are responsible for charges incurred.

The encryption options available depend on the Basic rate. To change the Basic rate and select another encryption option, go to Advanced Settings > Wi-Fi > Security. For details, see [Set Wi-Fi Security Options](#) on page 46.

3. Click Save. (Save button appears once you make a selection.)
4. You may need to reconnect your Wi-Fi devices using the new Wi-Fi credentials. See [Set Up and Connect to the Internet](#) on page 13.

View Details About Your Mobile Hotspot

To view details about your device such as the model number, software version, IMEI, etc., go to the Mobile Hotspot Homepage, and click the About Your Mobile Hotspot icon ().

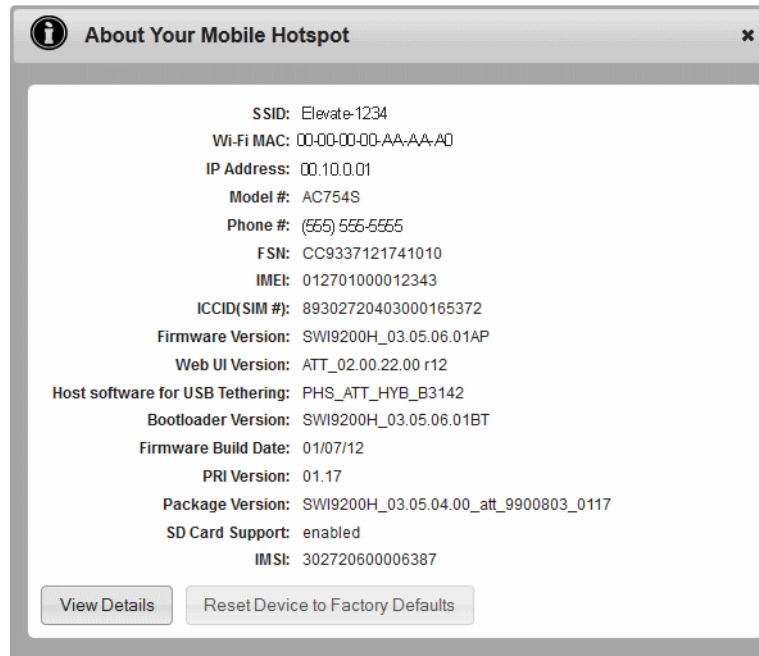

For additional information and to save a file that you can forward to AT&T Customer Care, click View Details.

Use the microSD Card to Share Files over Wi-Fi*

Your mobile hotspot is equipped with a microSD™ reader. You can use this feature to share music, photos, data files, etc. over your mobile Wi-Fi network, or in tethered mode. The mobile hotspot supports microSD cards with up to 32 GB capacity.

* Enterprise variant available with microSD and WPS functionality disabled and drivers supporting tethering removed.

Before you Begin

1. Remove the back cover.

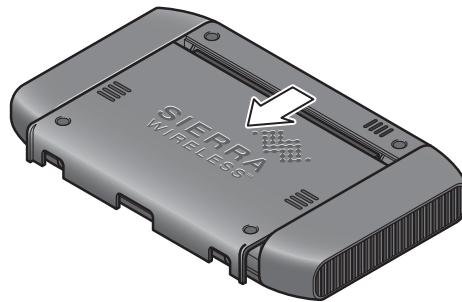

2. Insert the microSD card as shown in the illustration.

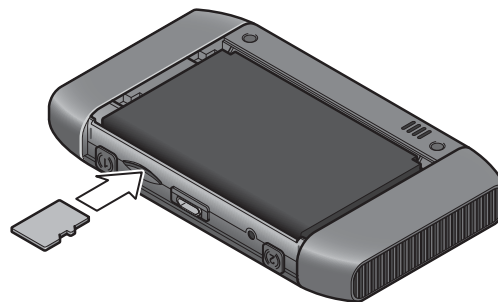

3. Replace the back cover.
4. On the homepage, click the microSD icon ().

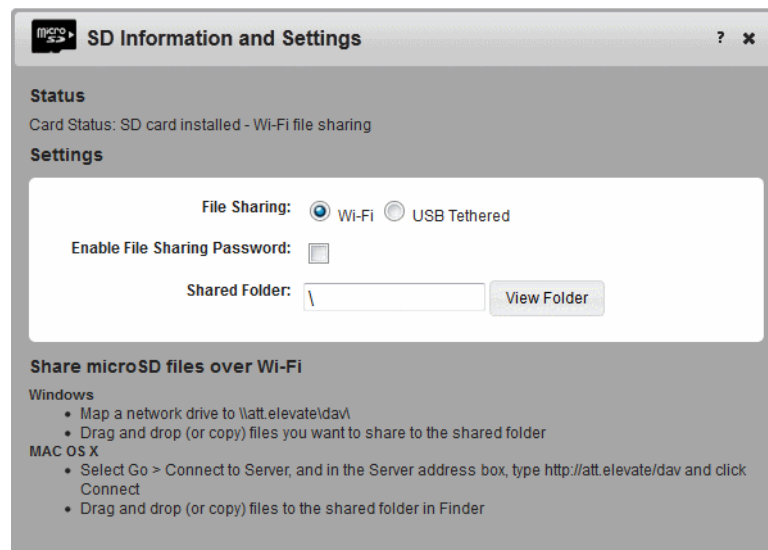

5. Choose the File Sharing option:
 - Wi-Fi — For sharing files over your Wi-Fi network
 - USB Tethered — For sharing files using the USB cable to connect the mobile hotspot to the computer

6. Optional — If you select Wi-Fi, you have the option of adding a password that users must enter before viewing your files.*
To enable the password option:
 - a. Select the box beside Enable File Sharing Password.
 - b. Type the password in the Password field and click Save.
Users will be asked to enter this password before they can access the shared folder.

Share or Access Files over Wi-Fi

If you want to upload, as well as view and download shared files, see [View, upload and download files](#) on page 31.

If you only want to view and download files, see [View and download only](#) on page 32.

View, upload and download files

To upload files over Wi-Fi, you need to map a network drive. The method used to map a network drive depends on your computer's operating system.

Windows 7

1. Go to Computer.
2. Click Map network drive on the toolbar.
3. Select an available drive letter.
4. In the Folder field, type `http:\\att.elevate\dav\`.
5. Click Finish.
The network drive created appears as a shared drive under Computer.
6. Drag and drop (or copy and paste) files to the shared drive.
7. If you are asked for a user name and password, leave the user name blank and enter the password (if password-protection was set up). Otherwise, leave the password field blank.

Windows XP

1. Go to Start > My Network Places.
2. Click Add Network Place.
The Add Network Place Wizard opens.
3. Click Next.
4. Highlight Choose another network location..., and click Next.
5. In the Internet or network address field, type `http://att.elevate/dav/` and click Next.

* There is a Windows-related bug associated with using a password to access shared files. If the computer being used to access the shared files has this bug, the Windows credentials dialog reappears after the password is entered, and the user must reboot the computer and reconnect to the Wi-Fi network before accessing the files. For more information, view our knowledge base articles at www.sierrawireless.com/SupportCenter.aspx.

6. Leave the default network place name or enter a new one of your choice.
7. Click Next.
8. Click Finish.
The network drive appears as a folder in Explorer under My Network Places.
9. Drag and drop (or copy and paste) files to the shared folder.
10. If you are asked for a user name and password, leave the user name blank and enter the password (if password-protection was set up). Otherwise, leave the password field blank.

Mac OS X

1. Open Finder.
2. Select Go > Connect to Server....
3. Type `http://att.elevate/dav/`.
4. Click Connect.
You'll be asked to enter a user name and password. Leave the user name field blank.
If you set up a password, enter that, and click OK.
Otherwise, leave the password field blank and click Cancel.
5. Drag and drop (or copy and paste) files to the shared drive that appears in Finder.

View and download only

Anyone connected to your Wi-Fi network can view or download files.

To view or download files:

1. Connect to the Wi-Fi network.
2. Launch your browser and enter `http://att.elevate/dav/`.
If you are asked for a user name and password, leave the user name blank and enter the password (if password-protection has been set up). Otherwise, leave the password field blank.

Note: You can also access the shared folder from the Web UI. From the homepage, log in as Administrator, click the microSD icon, and then click View Folder.

Using the microSD card in Tethered Mode*

You can also upload, download, and view shared files in tethered mode.

To share files in Tethered mode:

1. Use the USB cable to connect the mobile hotspot to a USB port on your computer.
2. On the homepage, log in as Administrator, and then click the microSD icon.
3. Select USB Tethered as the File Sharing option.

* Enterprise variant available with microSD and WPS functionality disabled and drivers supporting tethering removed.

4. The shared folder appears in Windows Explorer (Windows) and in Finder (Mac).

Recharge the Battery

The battery comes partially charged. You can recharge the battery from a wall socket or from the USB port on your computer.

To recharge the battery from a wall socket (Fastest option):

1. Attach one end of the micro USB cable to the mobile hotspot and attach the other end to the AC adapter (included).

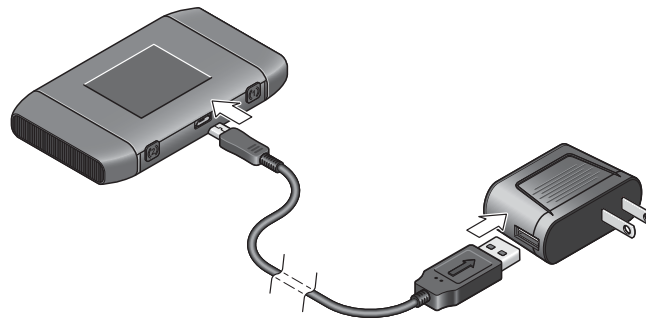

2. Plug the AC adapter into a wall socket. An animated battery icon on the LCD screen indicates that the battery is charging.

The battery icon on the LCD screen indicates when the battery is fully charged. 

Note: The LCD goes into sleep mode after a set time to extend battery life. To wake up the LCD screen, press and quickly release the power button.

To recharge the battery from the USB port on your computer:

1. Attach one end of the micro USB cable to the mobile hotspot and plug the other end into the USB port on your computer. An animated battery icon indicates that the battery is charging.

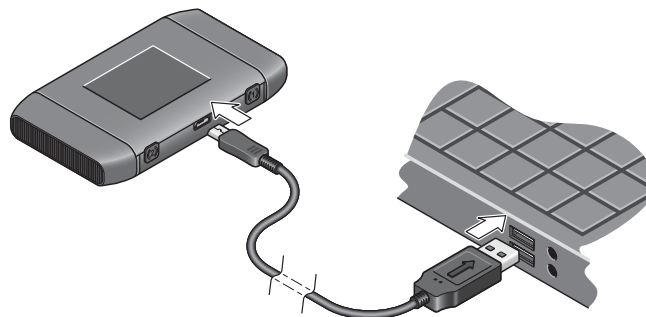

The battery icon on the LCD screen indicates when the battery is fully charged. 

Update the Firmware

When new firmware is available, you will receive a message on the LCD screen.

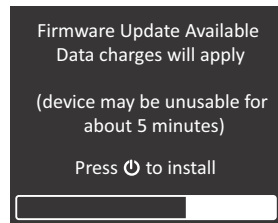

The message remains on the LCD for 1 minute. Press the Power button to install the firmware or you can install it later from the homepage. You'll receive this message 3 times, 8 hours apart. If you do not update the firmware, either from the LCD or the homepage, it will automatically update 8 hours after you receive the message for the third time.

Note: Updating the firmware may take up to 5 minutes and you cannot use the hotspot while the firmware is being updated.

To update the firmware from the LCD screen:

1. Press the power button when you see the message that a firmware update is available.
If the battery is low, you will be instructed to use the AC adapter to plug the mobile hotspot into a wall socket before continuing.
2. When the firmware installation is complete, reconnect your laptop or other Wi-Fi devices to your mobile hotspot Wi-Fi network.

Note: Updating the firmware will not change any of your personalized settings.

To update the firmware from the homepage:

1. Go to the homepage, log in as Administrator, and click the Messages icon (✉).

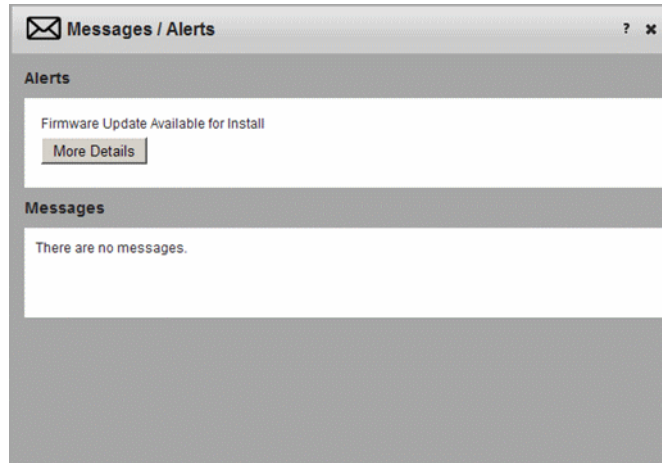

2. Click More Details.

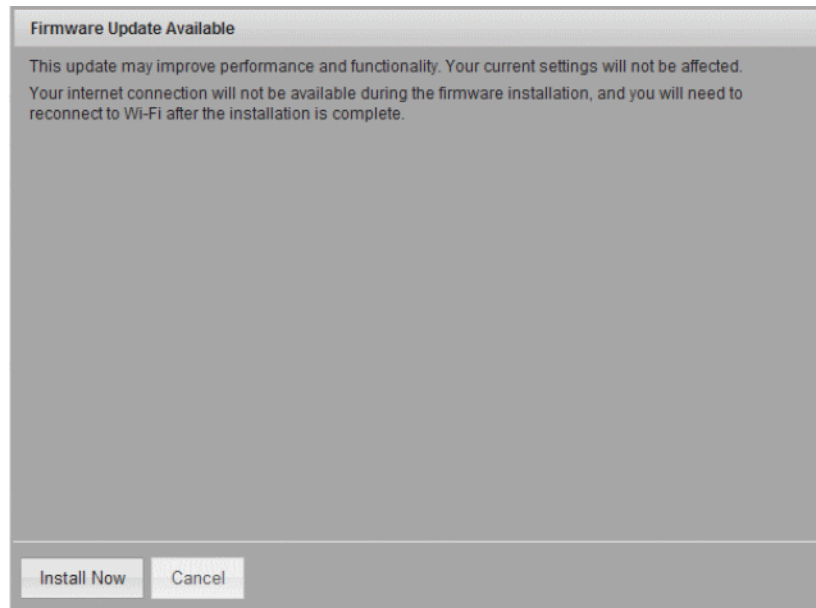

3. Click Install Now.
4. When the firmware installation is complete, reconnect your laptop or other Wi-Fi devices to your mobile hotspot Wi-Fi network.

Replace the SIM Card

Your mobile hotspot comes with the SIM card inserted. If you need to replace the SIM card:

1. Remove the back cover.

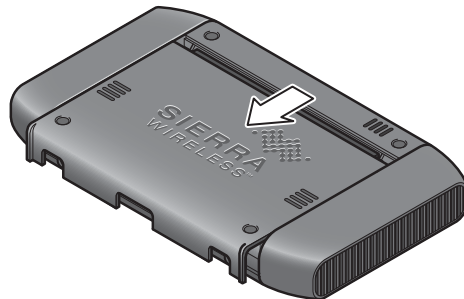

2. Slide the SIM card cover to the Open position.

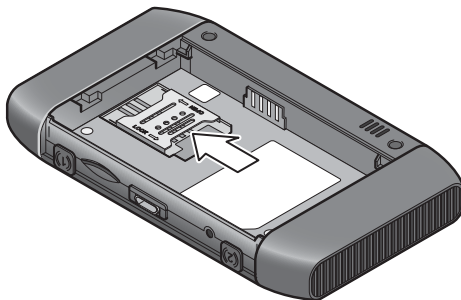

3. Lift the SIM card cover, remove the existing SIM card and replace it with the new one.

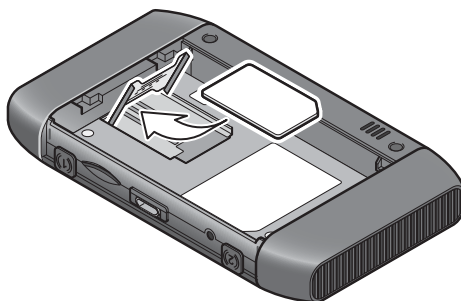

4. Lower the SIM card cover.

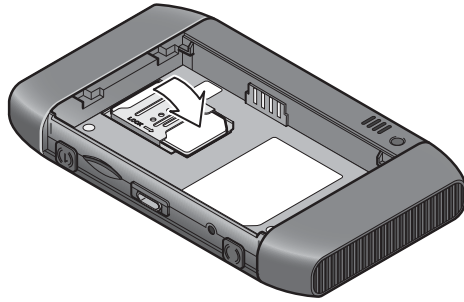

5. Slide the SIM card cover to the Lock position.

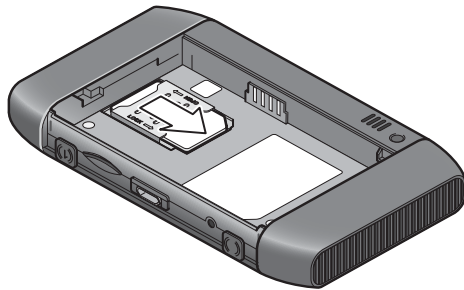

3: Advanced Settings

This chapter provides information on how to change advanced settings. The advanced settings enable you to configure various aspects of the device such as Wi-Fi settings, WAN settings, router settings, etc.

Do not Automatically Install Driver for USB Tethering*

By default, a host driver is installed the first time you connect your mobile hotspot to the computer via the USB cable. This driver enables the mobile hotspot to connect to the Internet when it is tethered to a USB port on the computer via the USB cable instead of using the Wi-Fi network.

If you do not want to use this feature and want to use only the USB cable to charge the mobile hotspot battery, you can set the host driver not to install.

To set the host driver not to install:

1. On the Mobile Hotspot Homepage, click the Advanced Settings icon (⚙️).

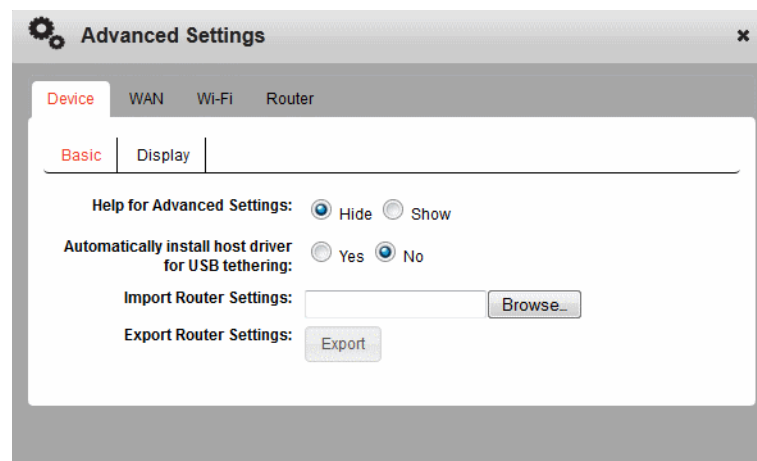

2. On the Device > Basic tab, beside Automatically install host driver for USB tethering, select No.
3. Click Save.

* Enterprise variant available with microSD and WPS functionality disabled and drivers supporting tethering removed.

Export / Import Router Options

You can export and import hotspot (router) settings. This is useful if you have more than one device and you want the same settings on both, or to save your settings before doing a factory reset or changing the settings.

To export router settings:

1. On the Device > Basic tab, beside Export Router Settings, click Export.
2. Click Save. (Save button appears once you make a selection.)

To import router settings:

1. On the Mobile Hotspot Homepage, click the Advanced Settings icon (⚙️).

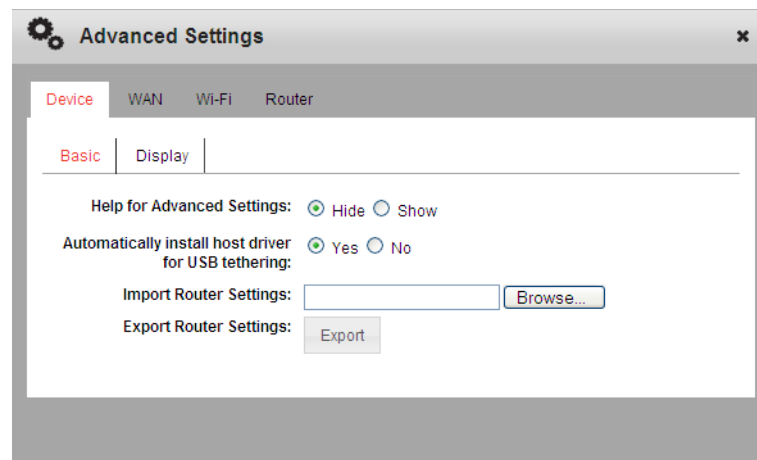

2. On the Device > Basic tab, beside Import Router Settings, type the path or use the Browse button to navigate to the file you want to import.
3. Click Open, and then click OK to confirm restart.

Set Display Options

You can use the display options to customize the mobile hotspot display and to conserve battery power.

To set the display options:

1. On the Mobile Hotspot Homepage, click the Advanced Settings icon (⚙️).
2. On the Device > Display tab, select the desired options:
 - Power LED
The Power LED blinks to confirm that the mobile hotspot is powered on. Turning it off can extend battery life.
 - LCD Backlight
You can control how long the LCD backlight is on before going into sleep mode. You can set the LCD backlight to turn off after 10, 30 or 60 seconds, or to never turn off. (Default is 60 seconds.) To wake up the LCD, press and release the power button.

- Backlight settings
You can control the brightness of the backlight settings when the mobile hotspot is powered by battery, USB port, or AC power. The options are off, dim, or bright.

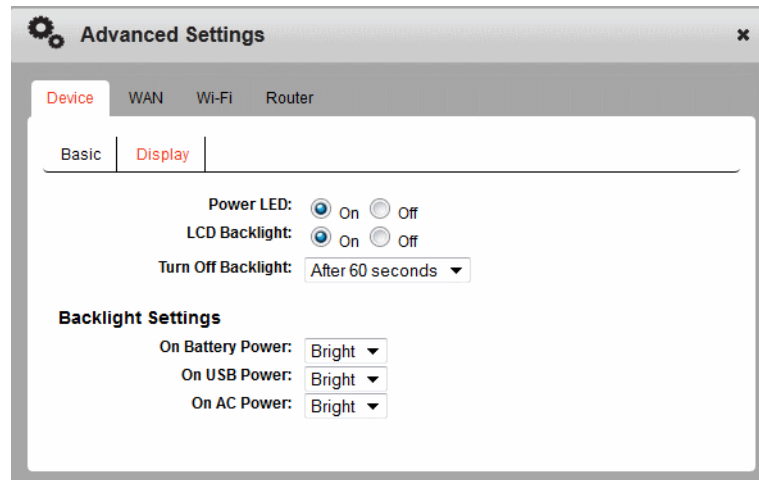

3. Click Save. (Save button appears once you make a selection.)

Set Audio Alerts

You can configure the mobile hotspot to beep when specific changes occur to its status.

To set the audio alerts:

1. On the device, set the mute switch so that the red rectangle is not visible.
2. On the Mobile Hotspot Homepage, click the Alert Sounds icon (⚙️).
3. Select the status changes for which you want to hear a beep.

If you want to hear a beep when the battery is low, choose the battery level at which you would like to be warned.

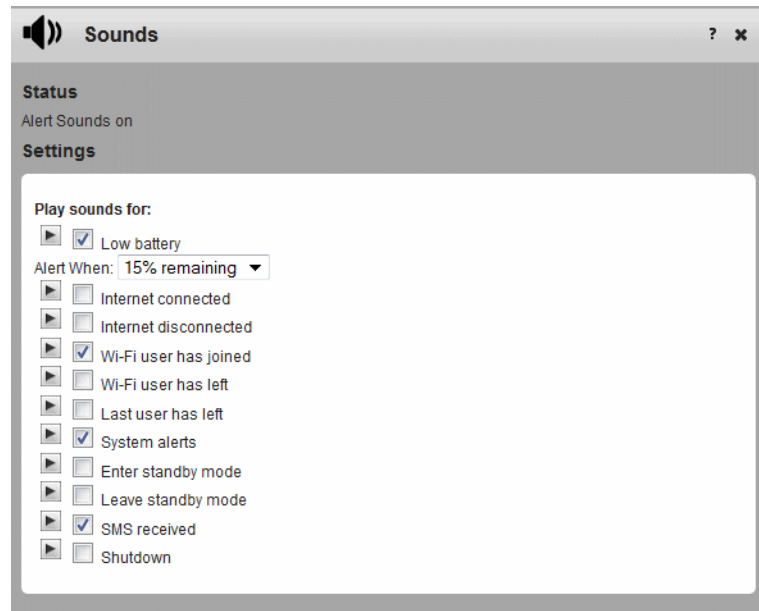

4. Click Save. (Save button appears once you make a selection.)

View and Save Device Information

You can view and save a file with detailed information about your mobile hotspot. If AT&T Customer Care is troubleshooting an issue, they may ask you to save this information and send it to them.

To view and save detailed information about your mobile hotspot:

1. On the Mobile Hotspot Homepage, click the About Your Mobile Hotspot icon (i).

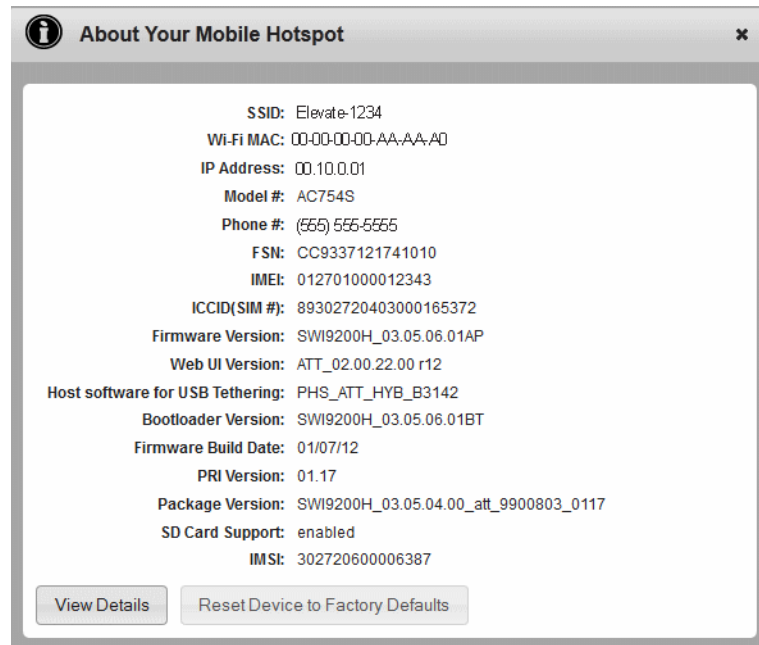

2. Click View Details.

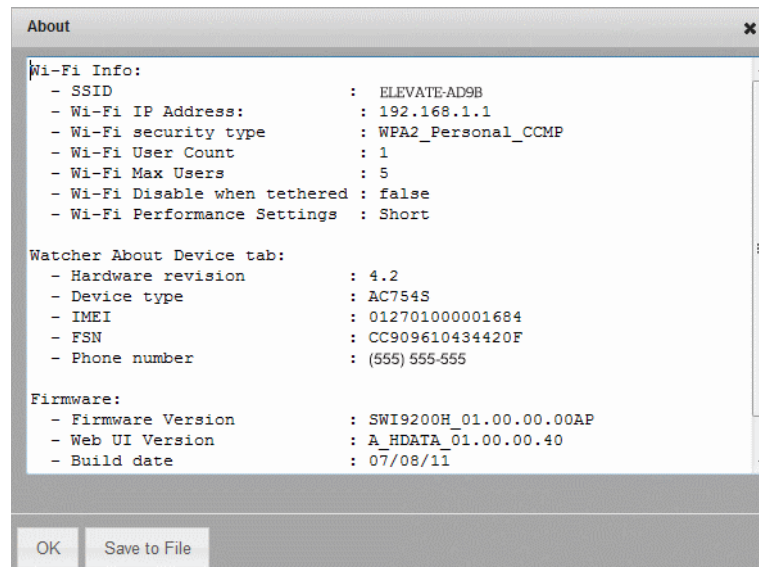

3. Click Save to File and follow the on-screen instructions to save the file.
 To close the window, click OK.

View WAN Information

To view network information, such as the active network, connection status, signal strength, etc.:

1. On the Mobile Hotspot Homepage, click the Advanced Settings icon (⚙️).

2. Click the WAN tab.

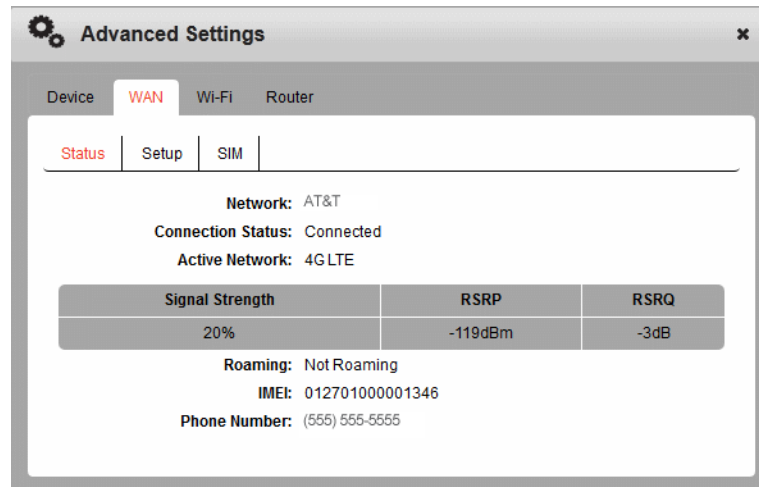

Set Connection Preferences

To set the connection preferences:

1. On the Mobile Hotspot Homepage, click the Advanced Settings icon (⚙️).
2. Go to WAN > Setup.

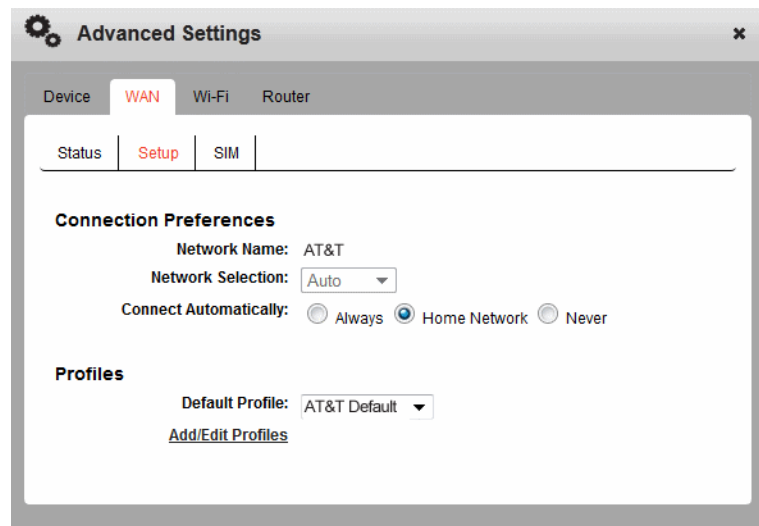

3. Select the desired options.

You can use the manual network selection mode to select a mobile network when roaming internationally. When a network is manually selected, the device does not automatically connect to AT&T's mobile network when you re-enter AT&T's coverage area. In this case, go to the Mobile Hotspot Homepage and reset this option to use AT&T's mobile network.

We recommend that you leave it set to "Auto".

4. Click Save. (Save button appears once you make a selection.)

Enable SIM Security

If desired, you can create another level of security by setting up a PIN number that must be entered before you can view the information available to an administrator or change the mobile hotspot settings on the homepage.

If you set up a PIN number, when you go to the homepage and log in as administrator, you will be asked to enter the PIN number before you can access the homepage as an administrator.

To enable SIM security:

1. On the Mobile Hotspot Homepage, click the Advanced Settings icon (⚙️).
2. Go to WAN > SIM.

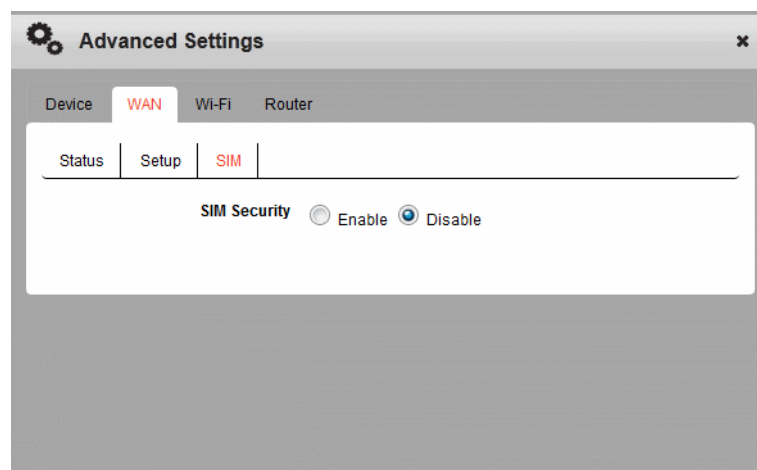

3. Select Enable and click Save. (Save button appears once you make a selection.)

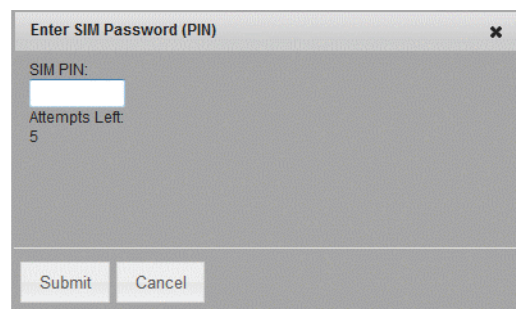

4. Enter your PIN and click Submit.
You are allowed 5 attempts to enter the correct PIN. If you run out of available attempts the PIN will be locked. If this happens, contact AT&T Customer Care to receive a PUK number to unlock the PIN.

View Wi-Fi Status and List of Connected Devices

To view Wi-Fi status and a list of connected devices:

1. On the Mobile Hotspot Homepage, click the Advanced Settings icon (⚙️).
2. Go to Wi-Fi > Status.

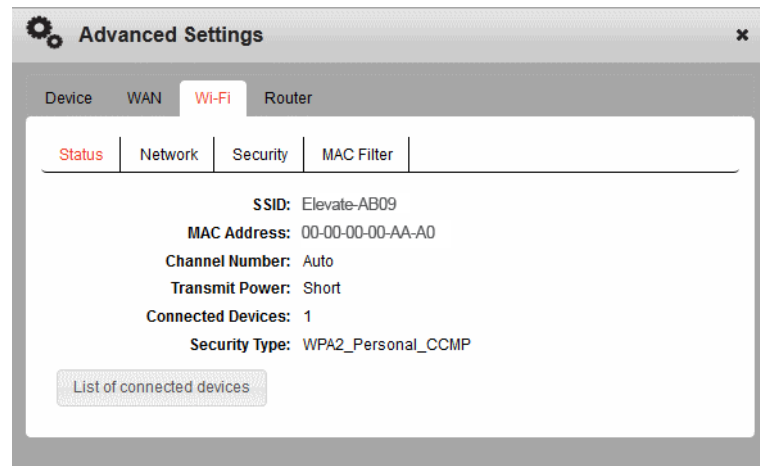

3. If desired, click the link to view a list of connected devices.

Set Wi-Fi Network Options

To set the Wi-Fi network options:

1. On the Mobile Hotspot Homepage, click the Advanced Settings icon (⚙️).
2. Go to Wi-Fi > Network.

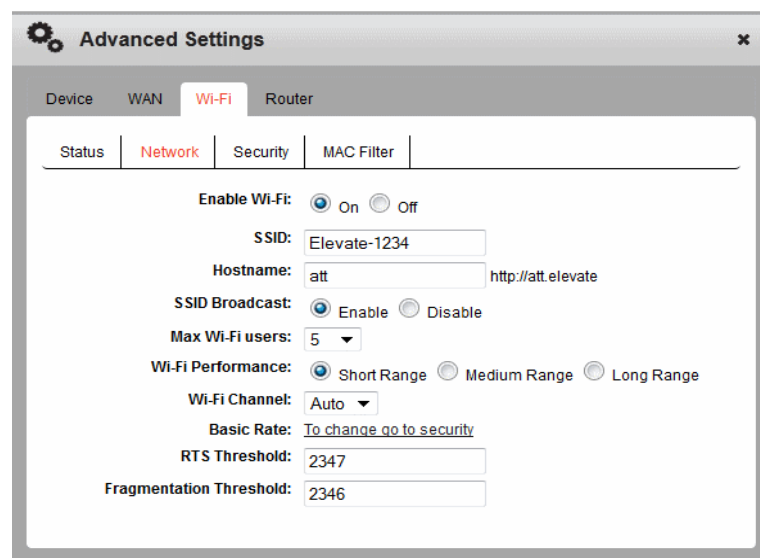

3. Select the desired options.

SSID Broadcast — If you select Enable, your SSID (network name) will be broadcast to everyone nearby. (Select Disable if you do not want it broadcast.)

RTS Threshold — The smallest packet size (in bytes) used by the Request to Send/Clear to Send handshaking protocol. The recommended value is 2347. If you are experiencing inconsistent data flow, you can make minor changes to this value to try to alleviate the problem.

Fragmentation Threshold — The largest allowable size (in bytes) for a packet. If the packet is larger than this, it is sent in multiple packets, which can affect network performance. It is recommended to keep this value as large as possible (up to 2346).
4. Click Save. (Save button appears once you make a selection.)

Set Wi-Fi Security Options

To set the Wi-Fi security options:

1. On the Mobile Hotspot Homepage, click the Advanced Settings icon (⚙️).
2. Go to Wi-Fi > Security.

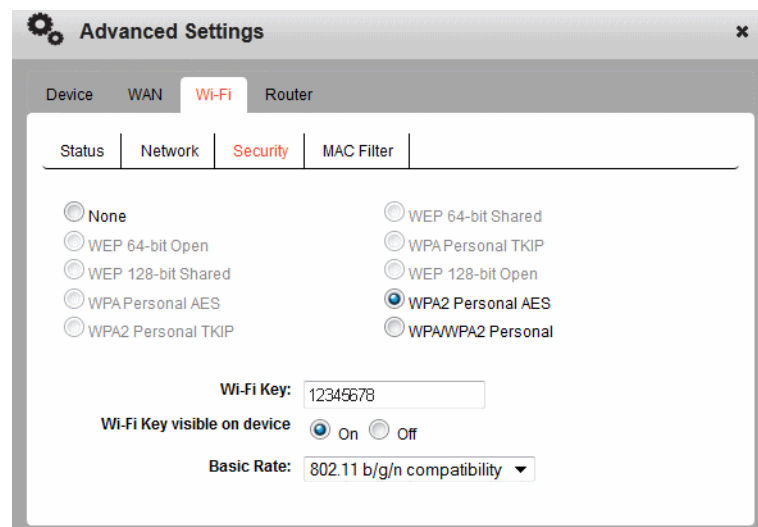

3. Select the desired options and click Save.

The options available depend on the Wi-Fi rate. If you want to choose a Wi-Fi encryption other than WPA2 Personal AES or WPA / WPA2 Personal:

1. Change the basic rate to 802.11b/g compatibility.
2. Select the desired encryption options.

It is recommended that you use WPA2 Personal AES whenever possible.

Note: The length of the Wi-Fi Key depends on the Wi-Fi encryption selected. Mouse-over the field for details.

Set MAC Filter Mode

MAC (Media Access Control) filtering enables you to block unauthorized Wi-Fi devices from accessing your Wi-Fi network (black list) or create a list of only those devices that are allowed to connect to your Wi-Fi network (white list), based on each device's MAC address.

Only one list at a time can be active, either a [Black List](#) or a [White List](#).

Black List

To block devices from connecting to your Wi-Fi network (black list):

1. On to the homepage, click the Advanced Settings icon (⚙️).
2. Go to Wi-Fi > MAC Filter.

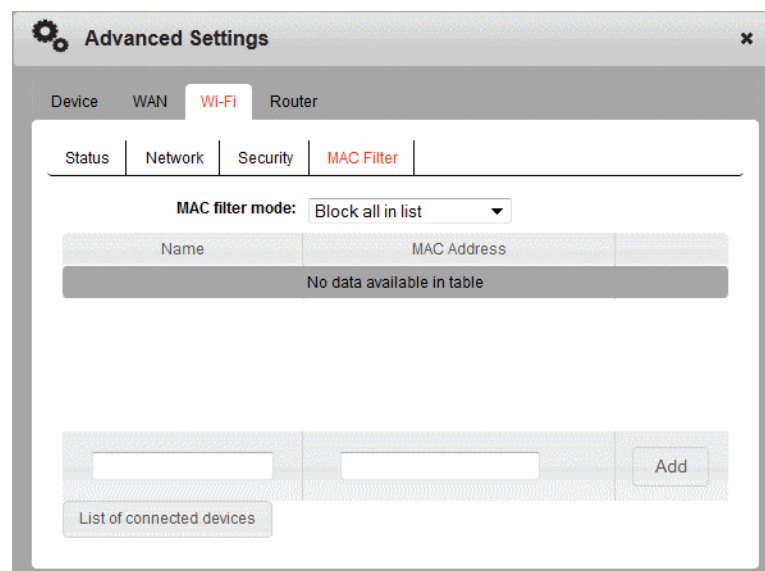

3. In the drop-down menu, select Block all in list.
4. Either:
 - Enter the MAC address of the device and click Add, or
 - Click List of connected devices and select the box beside the device in the Block column.
5. Click Save.

To unblock a device so it can connect to your Wi-Fi network:

1. Click List of connected devices.
2. Clear the box beside the device in the Block column.
3. Click Save.

White List

To create a list of devices that are allowed to connect to your Wi-Fi network (white list):

1. In the drop-down menu, select Allow only those in list.
2. Enter the MAC address for each device and click Add.
3. Click Save.

Enable Port Forwarding

If your computer is hosting a server, you can enable port forwarding so that other users can access the server.

To enable port forwarding:

1. On the Mobile Hotspot Homepage, click the Advanced Settings icon (⚙️).
2. Go to Router > Port Forward.

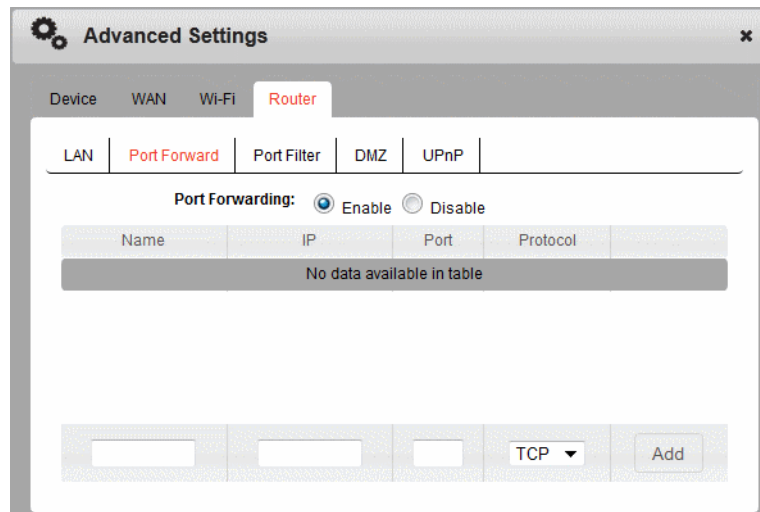

3. Select Enable beside Port Forwarding.
Incoming traffic is forwarded to specific ports and devices on your network (using their local IP addresses).
Note: Port forwarding creates a security risk. When not required, port forwarding should be disabled.
4. Enter the Port Forwarding information and click Save. (Save button appears once you make a selection.)

Enable Port Filtering

Port filtering enables you to select which applications (for example, http, ftp, email servers) can access the Internet. Used in conjunction with other security measures such as firewall, port filtering can enhance network security.

To enable port filtering:

1. On the Mobile Hotspot Homepage, click the Advanced Settings icon (⚙️).
2. Go to Router > Port Filter.

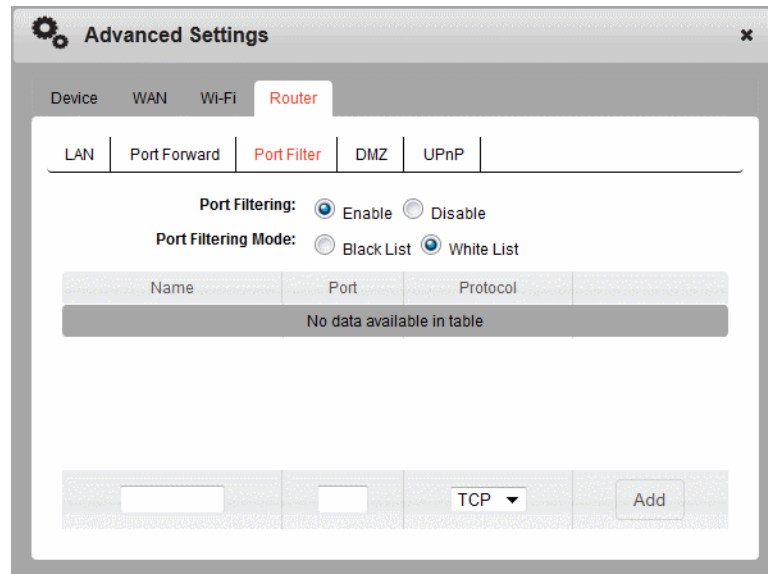

3. Select the Port Filtering Mode:
 - Black List—to select applications not allowed to access the Internet
 - White List—to select applications allowed to access the Internet

Note: Only one list at a time can be active, either a Black List or a White List.

4. Once you have selected the desired applications, click Save. (Save button appears once you make a selection.)

Enable VPN Passthrough

If you want to connect to a corporate network using a VPN, you first need to enable VPN connections (passthrough).

To enable VPN passthrough:

1. On the Mobile Hotspot Homepage, click the Advanced Settings icon (⚙️).
2. Go to Router > LAN.

Advanced Settings

Device WAN Wi-Fi **Router**

LAN Port Forward Port Filter DMZ UPnP

Router IP Address: 192.168.1.1

Subnet Mask: 255.255.255.0

Hostname: att <http://att.elevate>

USB IP Address: 192.168.2.2

VPN Passthrough: Enable Disable

DHCP Server: Enable Disable

DHCP IP Range: 192.168.1.2 - 192.168.1.99

DNS Mode: Manual Auto

3. Select Enable beside VPN Passthrough, and click Save.

Enable DMZ

In a DMZ (demilitarized zone) network configuration, a computer runs outside the firewall in the DMZ. This computer intercepts incoming Internet traffic, providing an extra layer of protection for the rest of the network.

To enable DMZ and designate a computer to screen incoming traffic:

1. On the Mobile Hotspot Homepage, click the Advanced Settings icon (⚙️).
2. Go to Router > DMZ.

Advanced Settings

Device WAN Wi-Fi **Router**

LAN Port Forward Port Filter **DMZ** UPnP

DMZ: Enable Disable

Destination IP Address: 0.0.0.0

3. Select Enable beside DMZ.
4. In the Designated IP Address field, enter the IP address of the computer you want to have in the DMZ.
5. Click Save.

Enable Universal Plug and Play

Universal Plug and Play (UPnP) is a set of protocols that enables seamless communication between UPnP devices on the network. It enables automatic device configuration and peer-to-peer data transfer over an IP network.

Note: If UPnP is enabled, there are potential security risks.

To enable UPnP:

1. On the Mobile Hotspot Homepage, click the Advanced Settings icon (⚙️).
2. Go to Router > UPnP.

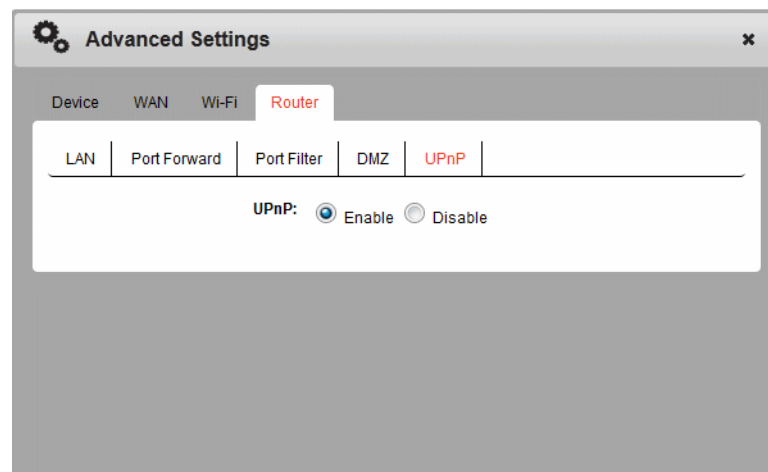

3. Select Enable beside UPnP.
4. Click Save.

Set Router LAN Options

To set the router LAN options:

1. On the Mobile Hotspot Homepage, click the Advanced Settings icon (⚙️).
2. Go to Router > LAN.

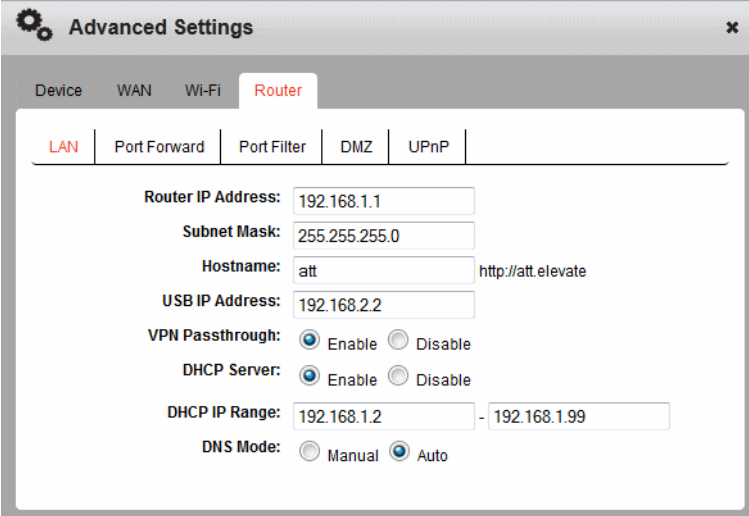

The screenshot shows the 'Advanced Settings' window with the 'Router' tab selected. Under the 'LAN' sub-tab, the following settings are visible:

- Router IP Address: 192.168.1.1
- Subnet Mask: 255.255.255.0
- Hostname: att (with a link to http://att.elevate)
- USB IP Address: 192.168.2.2
- VPN Passthrough: Enable Disable
- DHCP Server: Enable Disable
- DHCP IP Range: 192.168.1.2 - 192.168.1.99
- DNS Mode: Manual Auto

3. Enter the desired information.

If the DHCP Server is enabled, it automatically assigns an IP address to each device on the network and manages their configuration information.

The DNS mode setting specifies how the DNS servers are obtained. If you select Auto, the servers use the DNS relay specified by the Internet provider.

4. Click Save. (Save button appears once you make a selection.)

4: Frequently Asked Questions

This chapter provides answers to questions you may have about your mobile hotspot. (Also see [Troubleshooting](#) on page 56.)

What do I do if I forget my Wi-Fi Key or Admin Login?

The Wi-Fi Key appears on the LCD, unless you have configured it not to show.

The default Admin Login (**attadmin**) is printed on a label under the battery, and appears on the Web Interface LCD screen.

If you have changed either of these and then forgotten them:

1. Reset the device to the factory settings. (See [Reset the Mobile Hotspot](#) on page 58.)
2. Use the default Wi-Fi Key and Admin Login (**attadmin**) to connect to the Wi-Fi network and log in as Administrator. See [Set Up and Connect to the Internet](#) on page 13.

How do I disconnect from the mobile broadband network?

Do one of the following:

- On the Mobile Hotspot Homepage, click Disconnect (below the virtual mobile hotspot).
- Press and hold the power button for a few seconds to turn off the mobile hotspot.

I can't see the Connect / Disconnect button on the homepage.

The Connect / Disconnect button is only visible when you are logged in as Administrator.

To log in as Administrator:

1. Place your cursor in the Admin Login box on the homepage and type the Admin Login (**attadmin**).
2. Click Login.



How can I extend the life of the battery?

For information on extending the life of the battery, see [Extend Battery Life](#) on page 25.

How do I turn the mobile hotspot off?

Press and hold the power button for a few seconds, or click the Power off button on the homepage.

How do I find out how many users are connected to my mobile hotspot network?

The number beside the Wi-Fi icon () on the mobile hotspot LCD shows the number of users (or devices) connected to your Wi-Fi network. For more details about the devices or users connected to your network, go to the Mobile Hotspot Homepage, log in as Administrator, and click the Wi-Fi icon ().

Note: You can also use the options on the homepage to block particular users from connecting to your network. See [View / Block Connected Users](#) on page 20.

The LCD screen is not lit. How do I know if the mobile hotspot is still powered on?

The LCD screen dims to save energy. The blue LED continues to flash (provided you have not turned this feature off) to indicate that the mobile hotspot is still powered on. To wake up the LCD, press and quickly release the power button.

How do I access information on the microSD card?

See [Use the microSD Card to Share Files over Wi-Fi](#) on page 29.

How do I find my computer's IP address?

The steps for finding your computer's IP address depend on the operating system.

Windows

1. Open the command prompt window.
 - a. Click Start > Run.
 - b. Type cmd or command and click OK.
2. At the command prompt, type ipconfig and press Enter.
3. Write down the IP address for the entry that relates to the wireless network connection. (The IP address may be listed under "IPv4 Address" or something similar.)

Mac OS X

1. From the Apple menu, select System Preferences > Network.
2. Select the wireless adapter. The IP address is displayed in the right pane.

Other operating systems

Refer to the user documentation for your operating system or computer.

How do I find a device's MAC address?

You'll need to know the MAC address for a device when:

- Assigning an IP address based on a MAC address (when using DHCP)
- Allowing or denying devices access to your Wi-Fi network (MAC filtering)

Tip: To display a list of connected devices, including the MAC address of each device, go to the Mobile Hotspot Homepage, log in as Administrator, and click the Wi-Fi icon ().

The steps for finding a device's MAC address depend on the operating system.

Windows

1. Open the command prompt window.
 - a. Click Start > Run.
 - b. Type cmd or command and click OK.
2. At the command prompt, type ipconfig/all and press Enter.
3. Write down the Physical address for the entry that relates to the wireless network connection. (It appears as a series of numbers and letters. This is the MAC address of your wireless adapter.)

Mac OS X

1. From the Apple menu, select System Preferences > Network.
2. Select the wireless adapter that is connecting to the routing hardware.
3. Select Advanced.
4. Select Ethernet. The Ethernet ID is displayed. This is the same as the MAC address.

Other operating systems

Refer to the user documentation for your operating system or computer.

Where can I find more information?

- View the Online Help:
 1. Go to the Mobile Hotspot Homepage. (See [Homepage](#) on page 15.)
 2. Click the Help icon (.
- For more information about using your new device, visit the interactive web tutorial available at att.com/Tutorials.
- Additional support is available online including device specifications, troubleshooting and user forums at att.com/DeviceSupport.
- Go to www.sierrawireless.com/support and select AT&T and Mobile Hotspot Elevate 4G.

From the Sierra Wireless Web site, you can:

 - Update the firmware on your device
 - View tutorials
- Refer to the Quick Start Guide that came with your mobile hotspot.

5: Troubleshooting

This chapter provides suggestions for troubleshooting problems that may arise when using your mobile hotspot.

The mobile hotspot network name does not appear in the list of networks.

1. Refresh the list of networks.
2. Ensure that the Wi-Fi setting on your laptop (or other device) is turned on.
3. Ensure that Wi-Fi is enabled on the mobile hotspot. The Wi-Fi icon on the LCD should have a "0" beside it (Wi-Fi⁰) (not an "x" (Wi-Fi^x)).

If you need to enable Wi-Fi on the mobile hotspot:

1. Use the USB cable to tether the mobile hotspot to your laptop. (The first time you do this, it will take a few moments for the drivers to install.)
2. Launch your browser and go to the Mobile Hotspot Homepage.
3. Click the Wi-Fi users icon (Wi-Fi⁰).
4. Under Enable Wi-Fi, select On.
5. Click Save.

The No Signal icon appears on the LCD screen.

If the No Signal icon (No Signal^x) appears on the LCD screen, make sure you are in the AT&T coverage area.

The Wi-Fi radio is disabled icon appears on the LCD screen.

If the Wi-Fi radio is disabled icon (Wi-Fi^x) appears on the LCD screen, it could be because:

- The mobile hotspot is in standby mode. Double-press the Power key. If the "x" is still there, ensure that Wi-Fi is enabled.
- The Wi-Fi radio is disabled. To enable Wi-Fi:
 - a. Use the USB cable to tether the mobile hotspot to your laptop.
 - b. Launch your browser and go to the homepage.
 - c. Click the Wi-Fi users icon
 - d. Under Enable Wi-Fi, select On.
 - e. Click Save.

Unable to access the homepage when connected to a VPN

If you are using your mobile hotspot while connected to a VPN, you may not be able to access the mobile hotspot using <http://att.elevate>.

To access the homepage, enter the address <http://192.168.1.1> in your browser. This directly accesses the homepage hosted on the device.

Unable to connect a computer running Windows[®] Vista[®] to the mobile hotspot

Microsoft has a known issue whereby computers running Windows Vista cannot obtain an IP address from certain routers. More information and a fix are available at <http://support.microsoft.com/kb/928233> or go to the Microsoft support web site and search for knowledge base article 928233.

My computer (or other Wi-Fi device) loses its Wi-Fi connection to the mobile hotspot.

If a Wi-Fi device connects to your mobile hotspot Wi-Fi network, but periodically loses the connection, try changing the default basic rate.

1. On the main Web UI window, click the Advanced Settings icon (⚙️).
2. Go to Wi-Fi > Security.
3. In the Basic Rate field, select 802.11b/g compatibility from the drop-down menu.

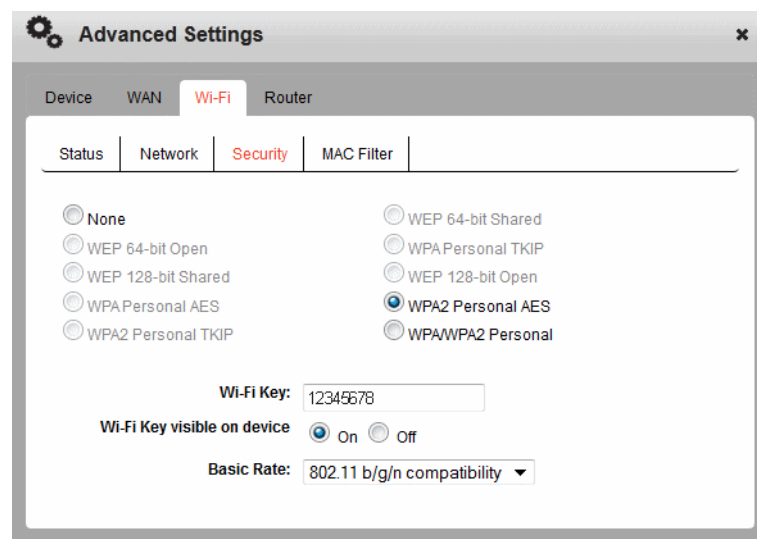

4. Click Save.

Reset the Mobile Hotspot

You can reset the mobile hotspot to the factory setting on the device or on the Mobile Hotspot Homepage. This is useful if you have lost your Wi-Fi Key.

To reset the mobile hotspot on the device:

1. Remove the back cover.

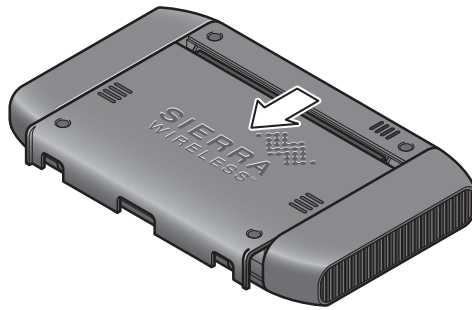

2. Use a small object such as the end of a paper clip to press and hold the reset button for 5 to 10 seconds.

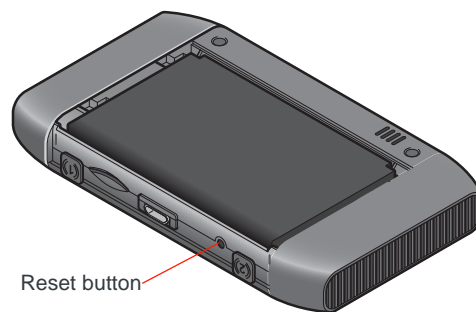

3. Replace the back cover.

To reset the mobile hotspot on the Mobile Hotspot Homepage:

1. On the Mobile Hotspot Homepage, click the About Your Mobile Hotspot icon (i).
2. Click Reset Device to Factory Defaults.

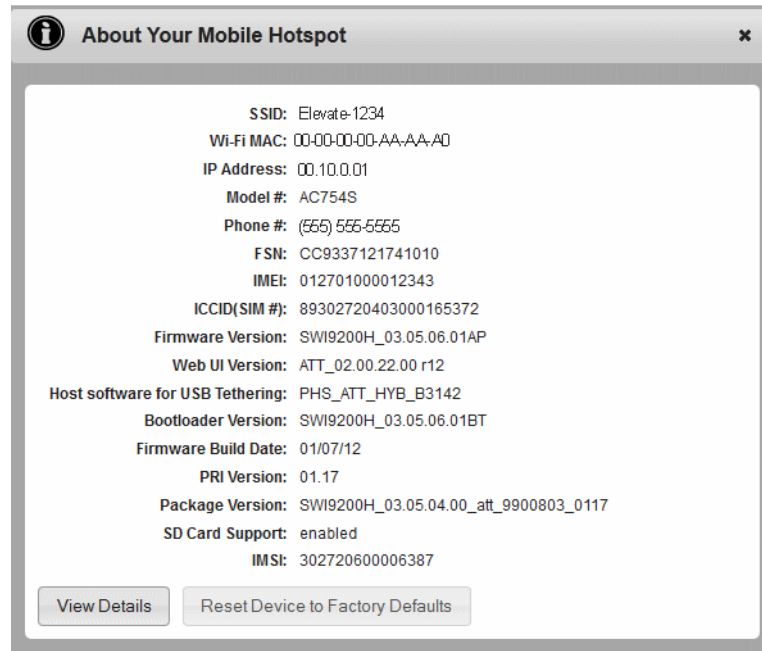

3. Click Save.

Unable to connect to the Internet in Tethered mode

If you are unable to connect to the Internet when the mobile hotspot is connected to the computer using the USB cable, it may be because the device driver is not installed. (You may also see a message that says the operating system could not find the driver for this device, and if you look in Device Manager, the mobile hotspot will be listed under Other devices with an exclamation mark beside it.)

For the driver to install properly, the mobile hotspot should be powered off the first time you plug it into a computer using the USB cable.

To correct this problem, follow the steps in [Tethered mode](#) on page 14.

Alerts

SIM not installed

Ensure that the SIM card is installed correctly. See [Replace the SIM Card](#) on page 36.

SIM Error — Check SIM

Ensure that you have an AT&T SIM card inserted in the mobile hotspot. If there is still a problem, contact AT&T Customer Care. (The SIM may be damaged and need replacing.)

SIM Locked

1. Contact AT&T Customer Care for the PIN to unlock the SIM.
2. Go to the Mobile Hotspot Homepage. (See [Homepage](#) on page 15.)
3. Log in as Administrator. (See [Security Credentials](#) on page 17.)
4. Enter the SIM PIN when prompted.
5. Click Save.

SIM MEP Locked

1. Contact AT&T Customer Care for the MEP unlock codes and tool to unlock your Mobile Wi-Fi.

Temperature-related alerts

The mobile hotspot is designed to work over a wide temperature range. (See [Environmental Specifications](#) on page 63 for details.) If you are outside that temperature range, the mobile hotspot issues an alert.

Move the device to an area where the temperature is more suitable and, if the mobile hotspot is too warm, make sure the area is well-ventilated and air can circulate around the device.

Note: The battery may not recharge if the mobile hotspot is outside the operating temperature range.

WPS Setup Failed; Device not connected!

The device you are trying to connect may not be WPS-enabled. Use the manual method to connect the Wi-Fi device to your Wi-Fi network.

1. Open the Wi-Fi menu on the device you are trying to connect to the Wi-Fi network.
2. Select your Network Name from the list of available Wi-Fi networks.
3. Select Connect and when prompted, enter your Wi-Fi Key.

Connection Alerts

If you receive any of the following connection alerts, contact AT&T Customer Care and provide them with the name and number of the alert.

Table 5-1: Connection alerts

Alert	Description
8	Operator Determined Barring
25	LLC or SNDCP failure
26	Insufficient resources
27	Missing or unknown APN
28	Unknown PDP address or type
29	User authentication failed
30	Activation rejected by GGSN
32	Service Option not supported
33	Service Option not subscribed
34	Service Option temporarily out of order
36	Regular deactivation
37	QOS not accepted
38	Network failure
39	Reactivation required
40	Feature not supported
41	Semantic error in the TFT operation
42	Syntactical error in the TFT operation
43	Unknown PDP context
44	PDP context without TFT already activated
45	Semantic errors in packet filter(s)
46	Syntactical errors in packet filter(s)
67	Connection error
81	Invalid transaction identifier value
95	Semantically incorrect message
96	Invalid mandatory information
97	Message type non-existent or not implemented
98	Message type not compatible with the protocol state
99	Information element non-existent or not implemented

Table 5-1: Connection alerts

Alert	Description
100	Conditional IE error
101	Message not compatible with the protocol state
111	Protocol error, unspecified
256	Invalid Connection ID
257	Invalid NSAPI
258	Invalid PRI NSAPI
259	Invalid Field
260	SNDCCP Failure
261	RAB Setup Failure
262	No GPRS Context
263	PDP Establish Max Timeout
264	PDP Activate Max Timeout
265	PDP Modify Max Timeout
266	PDP Inactivate Max Timeout
267	PDP Lower layer Error
268	PDP Duplicate
269	UE RAT Change

6: Specifications

Mechanical Specifications

Weight	100 g (3.53 oz.)
Length	96 mm (3.78 in.)
Width	57 mm (2.24 in.)
Thickness	16.5 mm (0.65 in.)

Environmental Specifications

Operating temperature	0° C to 35° C (32° F to 95° F)
Storage temperature	-10° C to +65° C, 96 hours (14° F to 149° F)

7: Regulatory and Safety Information

Notice

Because of the nature of wireless communications, transmission and reception of data can never be guaranteed. Data may be delayed, corrupted (that is, have errors), or be totally lost. Although significant delays or losses of data are rare when wireless devices such as the AT&T Mobile Hotspot Elevate 4G are used in a normal manner with a well-constructed network, the AT&T Mobile Hotspot Elevate 4G should not be used in situations where failure to transmit or receive data could result in damage of any kind to the user or any other party, including but not limited to personal injury, death, or loss of property. Sierra Wireless and its affiliates accept no responsibility for damages of any kind resulting from delays or errors in data transmitted or received using the AT&T Mobile Hotspot Elevate 4G, or for failure of the AT&T Mobile Hotspot Elevate 4G to transmit or receive such data.

Safety and Hazards

The mobile hotspot **MUST BE POWERED OFF** in all areas that may be susceptible to radio interference, in particular:

- Prohibited areas
Obey all signs and notices and follow all rules and regulations. Power off the mobile hotspot when instructed to do so or when you suspect that it may cause interference or danger.
- In areas where blasting is in progress
- Where explosive atmospheres may be present
Areas with a potentially explosive atmosphere are not always clearly marked. Such areas include gas stations, fuel depots, chemical transfer or storage facilities, areas where blasting is in progress, areas where the air contains chemicals or particles such as grain, dust, or metal powders, and any other area where you would normally be advised to turn off your cellular phone or vehicle engine.
- Near medical or life-support equipment
Medical equipment may be susceptible to any form of radio interference. In such areas the mobile hotspot can transmit signals that could interfere with this equipment.
- On board aircraft
In addition to Federal Aviation Authority (FAA) requirements, many airline regulations state that you must suspend wireless operations before boarding an aircraft. The mobile hotspot is capable of transmitting signals that could interfere with various onboard systems and controls.
Failure to observe this instruction may lead to suspension or denial of cellular telephone services to the offender, legal action, or both.
Some airlines may permit the use of cellular phones while the aircraft is on the ground and the door is open. The mobile hotspot may be used normally at this time.

- While operating a vehicle
The driver or operator of any vehicle should not use a wireless data device while in control of a vehicle. Doing so detracts from the driver or operator's ability to control and operate the vehicle. In some countries, using such communications devices while in control of a vehicle is an offence.

Proper Battery Use and Disposal

Note: Improper battery use may result in a fire, explosion, or other hazard.

To ensure safe and responsible battery use:

- Do not open, disassemble, puncture, crush, bend, or shred.
- Do not expose to water or other liquids, fire, explosion, or other hazards.
- Use the battery only in the mobile hotspot.
- If using with a charger, use only the charger supplied with the mobile hotspot.
- Do not short circuit the battery.
- When replacing a battery, use the same model of battery that was supplied with the mobile hotspot.
- Follow local regulations when disposing of a used battery.
- Avoid dropping the mobile hotspot or the battery. If dropped and you suspect damage, take it to a service center for inspection.

Regulatory Information for North America

CAUTION: Unauthorized modifications or changes not expressly approved by Sierra Wireless, Inc. could void compliance with regulatory rules, and thereby your authority to use this equipment.

Caution: *The AT&T Mobile Hotspot Elevate 4G must be 1 cm or more from users during operation, to satisfy FCC / IC RF exposure requirements.*

This device complies with Part 15 of the FCC Rules. Operation is subject to the condition that these devices do not cause harmful interference.

Where appropriate, the use of the equipment is subject to the following conditions:

Warning: (EMI) – *United States FCC Information – This equipment has been tested and found to comply with the limits pursuant to Part 15 of the FCC Rules. These limits are designed to provide reasonable protection against harmful interference in an appropriate installation. This equipment generates, uses, and can radiate radio frequency energy and, if not installed and used in accordance with the instructions, may cause harmful interference to radio communication. However, there is no guarantee that interference will not occur in a particular installation.*

If this equipment does cause harmful interference to radio or television reception, which can be determined by turning the equipment off and on, the user is encouraged to try to correct the interference by one or more of the following measures:

- Increase the separation between the equipment and receiver
- Connect the equipment into an outlet on a circuit different from that to which the receiver is connected
- Consult the dealer or an experienced radio/TV technician for help

If you have purchased this product under a United States Government contract, it shall be subject to restrictions as set forth in subparagraph (c)(1)(ii) of Defense Federal Acquisitions Regulations (DFARs) Section 252.227-7013 for Department of Defense contracts, and as set forth in Federal Acquisitions Regulations (FARs) Section 52.227-19 for civilian agency contracts or any successor regulations. If further government regulations apply, it is your responsibility to ensure compliance with such regulations.

»» Index

A

accessories
 included, [12](#)
 purchasing optional accessories, [12](#)
add a wireless device, [21](#)
Admin Login, [17](#)
Admin Login, forgot, [53](#)
AirCard Watcher App, [15](#)
audio alerts, [27](#)
auto connect options, [18](#)

B

battery, [25](#)
 inserting, [13](#)
 recharging, [33](#)
battery life, [53](#)
black list, [47](#)
block users, [20](#)

C

connect / disconnect button, [53](#)
connect to Internet, unable to, [59](#)
connect to the Internet, [13](#)
connection preferences, [43](#)

D

device information, view and save, [41](#)
display options, [39](#)
DMZ, [50](#)

F

firmware, update, [34](#)

G

GPS, [24](#)

H

homepage, accessing, [15](#)
homepage, cannot access, [57](#)

I

icons on the LCD screen, [10](#)
IP address, finding, [54](#)

L

LAN options, [51](#)
LCD, [9](#)
LCD screen not lit, [54](#)
list of connected devices, view, [45](#)

M

MAC address, finding, [55](#)
MAC filter, [47](#)
microSD
 accessing information on, [29](#), [54](#)
 inserting, [29](#)
mobile hotspot, turn off, [54](#)
mute switch, [9](#)

N

network name does not appear in the list of networks, [56](#)
no signal icon, [56](#)

P

port filtering, [48](#)
port forwarding, [48](#)
power button, [9](#)
power source, [12](#)

R

regulatory information, [64](#)
router options, import, export, [39](#)

S

safety information, [64](#)
security credentials, [17](#)
security credentials, forgot, [53](#)
security, change settings, [28](#)
SIM card, inserting, [36](#)
SIM security, enable, [44](#)
SMS messages, [23](#)
specifications, [63](#)

T

tethered mode
 first time you use it, [14](#)
 unable to connect to the Internet, [59](#)
text messages. *See* SMS messages.
troubleshooting, [56](#)

U

Unable to connect to hotspot, [57](#)
Universal Plug and Play (UPnP), [51](#)
USB tethering, [38](#)

V

view connected users, [20](#)
Vista, [57](#)
VPN passthrough, [48](#), [49](#)

W

WAN information, view, [42](#)

white list, [48](#)
Wi-Fi Key, [17](#)
Wi-Fi Key, forgot, [53](#)
Wi-Fi network
 disconnect, [53](#)
 options, [45](#)
Wi-Fi radio is disabled, [56](#)
Wi-Fi range, [25](#)
Wi-Fi security options, [46](#)
Wi-Fi status, view, [45](#)
Wi-Fi, enable/disable, [20](#)
wireless devices, connecting to your Wi-Fi network, [22](#)
WPS, [22](#)



Free Manuals Download Website

<http://myh66.com>

<http://usermanuals.us>

<http://www.somanuals.com>

<http://www.4manuals.cc>

<http://www.manual-lib.com>

<http://www.404manual.com>

<http://www.luxmanual.com>

<http://aubethermostatmanual.com>

Golf course search by state

<http://golfingnear.com>

Email search by domain

<http://emailbydomain.com>

Auto manuals search

<http://auto.somanuals.com>

TV manuals search

<http://tv.somanuals.com>