

## How to Use

---

### **Before Use**

#### **Names of parts**

- [Checking the camera and the supplied items \[1\]](#)
- [Identifying parts \(Front side\) \[2\]](#)
- [Identifying parts \(Rear side\) \[3\]](#)
- [Identifying parts \(Top side\) \[4\]](#)
- [Identifying parts \(Sides/Bottom\) \[5\]](#)
- [Identifying parts Lens DT 16-50mm F2.8 SSM \(Supplied with the ILCA-77M2Q\) \[6\]](#)
- [Identifying parts Lens DT 18-135mm F3.5-5.6 SAM \(Supplied with the ILCA-77M2M\) \[7\]](#)

#### **Icons and indicators**

- [List of icons on the screen \[8\]](#)
- [Display panel \[9\]](#)

#### **Using the strap**

- [Using the shoulder strap \[10\]](#)

#### **Attaching the eyepiece cup**

- [Attaching the eyepiece cup \[11\]](#)

#### **Adjusting the viewfinder**

- [Adjusting the viewfinder \(diopter-adjustment\) \[12\]](#)

## **In-Camera guide**

- [About the \[In-Camera Guide\] \[13\]](#)

## **Preparing the camera**

### **Charging the battery pack**

- [Charging the battery pack using a charger \[14\]](#)
- [Inserting the battery pack into the camera \[15\]](#)
- [Battery life and the number of images that can be recorded/played back using a battery pack \[16\]](#)
- [Supplying power using a wall outlet \(wall socket\) \[17\]](#)
- [Removing the battery pack \[18\]](#)

### **Inserting a memory card (sold separately)**

- [Inserting a memory card \[19\]](#)
- [Removing the memory card \[20\]](#)

### **Attaching a lens**

- [Attaching a lens \[21\]](#)
- [Removing the lens \[22\]](#)
- [Attaching the lens hood \[23\]](#)
- [Notes on changing the lens \[24\]](#)

### **Setting the date and time**

- [Setting the date and time \[25\]](#)

## **Confirming the operation method**

### **Confirming the operation method**

[Using the multi-selector \[26\]](#)

- [Using MENU items \[27\]](#)
- [Using the Fn \(Function\) button \[28\]](#)
- [Using the "Quick Navi" \[29\]](#)

## **Shooting**

### **Shooting still images/movies**

- [Shooting still images \[30\]](#)
- [Shooting movies \[31\]](#)

### **Selecting a shooting mode**

- [List of mode dial functions \[32\]](#)
- [Intelligent Auto \[33\]](#)
- [Superior Auto \[34\]](#)
- [About Scene Recognition \[35\]](#)
- [The advantages of automatic shooting \[36\]](#)
- [Program Auto \[37\]](#)
- [Sweep Panorama \[38\]](#)
- [Scene Selection \[39\]](#)
- [Cont. Priority AE \[40\]](#)
- [Shutter Priority \[41\]](#)
- [Aperture Priority \[42\]](#)
- [Manual Exposure \[43\]](#)
- [BULB \[44\]](#)
- [Memory recall \[45\]](#)
- [Movie \[46\]](#)

## **Using shooting functions**

### **Using the zoom**

- [Zoom \[47\]](#)

- [The zoom features available with this product \[48\]](#)
- [Zoom Setting \[49\]](#)
- [About zoom scale \[50\]](#)
- [Smart Telecon. \[51\]](#)

## **Using the flash**

- [Using flash \[52\]](#)
- [Flash Mode \[53\]](#)
- [Flash Comp. \[54\]](#)
- [FEL Lock \[55\]](#)
- [Flash control \[56\]](#)
- [Power ratio \[57\]](#)

## **Selecting a screen display mode**

- [Switching the screen display \(Shooting\) \[58\]](#)
- [DISP Button \(Finder\) \[59\]](#)
- [DISP Button \(Monitor\) \[60\]](#)

## **Selecting still image size/image quality**

- [Image Size \(still image\) \[61\]](#)
- [Aspect Ratio \(still image\) \[62\]](#)
- [Quality \(still image\) \[63\]](#)
- [Panorama: Size \[64\]](#)
- [Panorama: Direction \[65\]](#)

## **Adjusting the focus**

- [Changing the focus method using the focus mode dial \[66\]](#)
- [Focus Area \[67\]](#)
- [Center Lock-on AF \[68\]](#)
- [AF Area Auto Clear \[69\]](#)
- [AF Area Points \[70\]](#)
- [Flexible Spot Points \[71\]](#)

- [Wide AF Area Disp. \[72\]](#)
- [Focus-lock \[73\]](#)
- [Manual Focus \[74\]](#)
- [Direct manual focus \(DMF\) \[75\]](#)
- [Focus Magnifier \[76\]](#)
- [Focus Magnif. Time \[77\]](#)
- [Peaking Level \[78\]](#)
- [Peaking Color \[79\]](#)
- [Eye-Start AF \(still image\) \[80\]](#)
- [AF/MF control \[81\]](#)
- [AF Illuminator \(still image\) \[82\]](#)
- [AF Micro Adj. \[83\]](#)
- [AF w/ shutter \(still image\) \[84\]](#)
- [AF On \[85\]](#)
- [Eye AF \[86\]](#)
- [AF drive speed \(still image\) \[87\]](#)
- [AF Track Duration \(still image\) \[88\]](#)
- [AF Track Duration \(movie\) \[89\]](#)
- [Measuring the exact distance to the subject \[90\]](#)
- [AF Range Control \[91\]](#)
- [AF-A setup \[92\]](#)
- [Priority setup \[93\]](#)

## **Adjusting the exposure**

- [Exposure Comp. \[94\]](#)
- [Exposure compensation button \[95\]](#)
- [Metering Mode \[96\]](#)
- [AE lock \[97\]](#)
- [AEL w/ shutter \(still image\) \[98\]](#)
- [Exp.comp.set \[99\]](#)
- [Zebra \[100\]](#)
- [Exposure Set. Guide \[101\]](#)

[Exposure step \[102\]](#)

- [Dial Ev Comp \[103\]](#)

## **Selecting a drive mode (Continuous shooting/Self-timer)**

- [Drive Mode \[104\]](#)
- [Cont. Shooting \[105\]](#)
- [Self-timer \[106\]](#)
- [Self-timer\(Cont\) \[107\]](#)
- [Cont. Bracket \[108\]](#)
- [Single Bracket \[109\]](#)
- [WB bracket \[110\]](#)
- [DRO Bracket \[111\]](#)
- [Bracket order \[112\]](#)

## **Selecting the ISO sensitivity**

- [ISO \[113\]](#)
- [Multi Frame NR \[114\]](#)
- [NR Effect \[115\]](#)

## **Correcting the brightness or contrast**

- [D-Range Opt. \(DRO\) \[116\]](#)
- [Auto HDR \[117\]](#)

## **Adjusting color tones**

- [White Balance \[118\]](#)
- [Capturing a basic white color in \[Custom Setup\] mode \[119\]](#)

## **Selecting an effect mode**

- [Picture Effect \[120\]](#)
- [Creative Style \[121\]](#)

## **Recording movies**

- [Movie recording formats \[122\]](#)
- [File Format \(movie\) \[123\]](#)
- [Record Setting \(movie\) \[124\]](#)
- [SteadyShot \(movie\) \[125\]](#)
- [Audio Recording \[126\]](#)
- [Audio Level Display \[127\]](#)
- [Audio Rec Level \[128\]](#)
- [Audio Out Timing \[129\]](#)
- [Wind Noise Reduct. \[130\]](#)
- [Auto Slow Shut. \(movie\) \[131\]](#)
- [MOVIE Button \[132\]](#)

## **Customizing the shooting functions for convenient use**

- [Memory \[133\]](#)
- [Function Menu Set. \[134\]](#)
- [Custom Key Settings \[135\]](#)
- [Function of the focus hold button \[136\]](#)
- [Function of the AEL button \[137\]](#)
- [Function of the AF/MF button \[138\]](#)
- [Function of the ISO button \[139\]](#)
- [Function of the Exposure Compensation button \[140\]](#)
- [Function of the WB button \[141\]](#)
- [Function of the Drive Mode button \[142\]](#)
- [Function of the Smart Teleconverter button \[143\]](#)
- [Function of the Preview Button \[144\]](#)
- [Function of the C button \[145\]](#)
- [Function of the center button \[146\]](#)
- [Dial Setup \[147\]](#)

## **Setting the other functions of this product**

- [Smile/Face Detect. \[148\]](#)
- [Soft Skin Effect \(still image\) \[149\]](#)

- [Face Registration \(New Registration\) \[150\]](#)
- [Face Registration \(Order Exchanging\) \[151\]](#)
- [Face Registration \(Delete\) \[152\]](#)
- [Red Eye Reduction \[153\]](#)
- [Auto Obj. Framing \(still image\) \[154\]](#)
- [SteadyShot \(still image\) \[155\]](#)
- [Long Exposure NR \(still image\) \[156\]](#)
- [High ISO NR \(still image\) \[157\]](#)
- [Color Space \(still image\) \[158\]](#)
- [Grid Line \[159\]](#)
- [Auto Review \[160\]](#)
- [Live View Display \[161\]](#)
- [FINDER/MONITOR \[162\]](#)
- [Release w/o Lens \[163\]](#)
- [SteadyS. w/ shut. \[164\]](#)
- [e-Front Curtain Shut. \[165\]](#)
- [Superior Auto \(Image Extraction\) \[166\]](#)
- [Superior Auto \(Cont. Shooting\) \[167\]](#)
- [Shading Comp. \[168\]](#)
- [Chro. Aber. Comp. \[169\]](#)
- [Distortion Comp. \[170\]](#)
- [Dial Lock \[171\]](#)
- [Deactivate Monitor \[172\]](#)
- [Aperture Preview \[173\]](#)
- [Shot. Result Preview \[174\]](#)

## **Viewing**

### **Viewing still images**

- [Playing back images \[175\]](#)
- [Playback zoom \[176\]](#)
- [Image Index \[177\]](#)



[Switching the screen display \(during playback\) \[178\]](#)

## **Deleting images**

- [Deleting a displayed image \[179\]](#)
- [Deleting multiple selected images \[180\]](#)

## **Playing back movies**

- [Playing back movies \[181\]](#)

## **Viewing panoramic images**

- [Playing back panoramic images \[182\]](#)

## **Printing**

- [Specify Printing \[183\]](#)

## **Using viewing functions**

- [View Mode \[184\]](#)
- [Display Rotation \[185\]](#)
- [Slide Show \[186\]](#)
- [Rotate \[187\]](#)
- [Protect \[188\]](#)
- [4K Still Image PB \[189\]](#)

## **Viewing images on a TV**

- [Viewing images on an HD TV \[190\]](#)
- [Viewing images on a “BRAVIA” Sync-compatible TV \[191\]](#)

## **Changing settings**

### **Setup menu**

- [Monitor Brightness \[192\]](#)

- [Viewfinder Bright. \[193\]](#)
- [Finder Color Temp. \[194\]](#)
- [Volume Settings \[195\]](#)
- [Audio signals \[196\]](#)
- [Upload Settings\(Eye-Fi\) \[197\]](#)
- [Tile Menu \[198\]](#)
- [Mode Dial Guide \[199\]](#)
- [Delete confirm. \[200\]](#)
- [Pwr Save Start Time \[201\]](#)
- [PAL/NTSC Selector \[202\]](#)
- [Cleaning Mode \[203\]](#)
- [Demo Mode \[204\]](#)
- [Remote Ctrl \[205\]](#)
- [HDMI Resolution \[206\]](#)
- [CTRL FOR HDMI \[207\]](#)
- [HDMI Info. Display \[208\]](#)
- [USB Connection \[209\]](#)
- [USB LUN Setting \[210\]](#)
- [Language \[211\]](#)
- [Date/Time Setup \[212\]](#)
- [Area Setting \[213\]](#)
- [Format \[214\]](#)
- [File Number \[215\]](#)
- [Select REC Folder \[216\]](#)
- [New Folder \[217\]](#)
- [Folder Name \[218\]](#)
- [Recover Image DB \[219\]](#)
- [Display Media Info. \[220\]](#)
- [Version \[221\]](#)
- [Certification Logo \(Overseas model only\) \[222\]](#)
- [Setting Reset \[223\]](#)

## Using Wi-Fi functions

### Connecting this product and a Smartphone

- [PlayMemories Mobile \[224\]](#)
- [Connecting an Android smartphone to this product \[225\]](#)
- [Connecting the product to an iPhone or iPad \[226\]](#)

### Controlling this product using a Smartphone

- [Ctrl w/ Smartphone \[227\]](#)
- [One-touch connection with an NFC-enabled Android smartphone \(NFC One-touch remote\) \[228\]](#)

### Transferring images to a Smartphone

- [Send to Smartphone \[229\]](#)
- [Sending images to an Android smartphone \(NFC One-touch Sharing\) \[230\]](#)

### Transferring images to a computer

- [Send to Computer \[231\]](#)

### Transferring images to a TV

- [View on TV \[232\]](#)

### Changing the settings of Wi-Fi functions

- [Airplane Mode \[233\]](#)
- [WPS Push \[234\]](#)
- [Access Point Set. \[235\]](#)
- [Edit Device Name \[236\]](#)
- [Disp MAC Address \[237\]](#)
- [SSID/PW Reset \[238\]](#)
- [Reset Network Set. \[239\]](#)

## Viewing on computers

## **Recommended computer environment**

- [Recommended computer environment \[240\]](#)

## **Using the software**

- [PlayMemories Home \[241\]](#)
- [Installing PlayMemories Home \[242\]](#)
- [Software for Mac computers \[243\]](#)
- [Image Data Converter \[244\]](#)
- [Installing Image Data Converter \[245\]](#)
- [Accessing Image Data Converter Guide \[246\]](#)
- [Remote Camera Control \[247\]](#)
- [Installing Remote Camera Control \[248\]](#)
- [Accessing the Help of Remote Camera Control \[249\]](#)

## **Connecting this product and a computer**

- [Connecting the product to a computer \[250\]](#)
- [Importing images to the computer \[251\]](#)
- [Disconnecting the product from the computer \[252\]](#)

## **Creating a movie disc**

- [Disc type \[253\]](#)
- [Selecting the disc creation method \[254\]](#)
- [Creating a disc with a device other than a computer \[255\]](#)
- [Creating Blu-ray Discs \[256\]](#)

## **Precautions/This product**

### **Precautions**

- [Precautions \[257\]](#)
- [On the internal rechargeable battery \[258\]](#)
- [Battery pack and battery charger \[259\]](#)

- [Memory card \[260\]](#)

## **Cleaning this product**

- [On cleaning \[261\]](#)

## **Number of recordable still images and recordable time of movies**

- [Number of still images \[262\]](#)
- [Recordable time of movies \[263\]](#)

## **Using this product abroad**

- [Plug adaptor \[264\]](#)
- [On TV color systems \[265\]](#)

## **Other information**

- [Vertical grip \[266\]](#)
- [License \[267\]](#)

## **Trademarks**

- [Trademarks \[268\]](#)

---

## Troubleshooting

---

### **If you have problems**

### **If you have problems**

- [Troubleshooting \[269\]](#)

## **Troubleshooting**

## **Battery pack and power**

- [You cannot insert the battery pack into the product. \[270\]](#)
- [You cannot turn on the product. \[271\]](#)
- [The power turns off suddenly. \[272\]](#)
- [The remaining battery level indicator shows an incorrect level. \[273\]](#)
- [The CHARGE lamp of the battery charger flashes when charging the battery pack. \[274\]](#)

## **Shooting still images/movies**

- [You cannot record images. \[275\]](#)
- [Recording takes a long time. \[276\]](#)
- [The image is out of focus. \[277\]](#)
- [The flash does not work. \[278\]](#)
- [Fuzzy white circular spots appear on images shot using the flash. \[279\]](#)
- [The recording date and time are not displayed on the screen. \[280\]](#)
- [The date and time are recorded incorrectly. \[281\]](#)
- [The aperture value and/or shutter speed and/or metering indicator flashes. \[282\]](#)
- [The image colors are not correct. \[283\]](#)
- [Noise appears in the image when you view the screen in a dark place. \[284\]](#)
- [The eyes of the subject come out red. \[285\]](#)
- [Dots appear and remain on the screen. \[286\]](#)
- [You cannot shoot images continuously. \[287\]](#)
- [The image is not clear in the viewfinder. \[288\]](#)
- [The image is whitish \(Flare\)/Blurring of light appears on the image \(Ghosting\). \[289\]](#)
- [The corners of the picture are too dark. \[290\]](#)
- [The image is blurred. \[291\]](#)
- [The LCD screen darkens after a short period of time passed. \[292\]](#)
- [The flash takes too long to recharge. \[293\]](#)
- [The control dial does not work. \[294\]](#)

## **Viewing images**

- [Images cannot be played back. \[295\]](#)

- [The date and time are not displayed. \[296\]](#)
- [The image cannot be deleted. \[297\]](#)
- [The image was deleted by mistake. \[298\]](#)
- [A DPOF mark cannot be put. \[299\]](#)

## **Wi-Fi**

- [You cannot find the wireless access point to be connected. \[300\]](#)
- [\[WPS Push\] does not work. \[301\]](#)
- [\[Send to Computer\] is canceled halfway. \[302\]](#)
- [You cannot send movies to a smartphone. \[303\]](#)
- [\[Ctrl w/ Smartphone\] or \[Send to Smartphone\] is canceled halfway. \[304\]](#)
- [The shooting screen for \[Ctrl w/ Smartphone\] is not displayed smoothly./The connection between this product and the smartphone is disconnected. \[305\]](#)
- [You cannot use One-Touch connection \(NFC\). \[306\]](#)

## **Computers**

- [The computer does not recognize this product. \[307\]](#)
- [You cannot import images. \[308\]](#)
- [The image and sound are interrupted by noise when viewing a movie on a computer. \[309\]](#)
- [Images exported from a computer cannot be viewed on this product. \[310\]](#)

## **Memory cards**

- [Formatted the memory card by mistake. \[311\]](#)

## **Printing**

- [You cannot print images. \[312\]](#)
- [The color of the image is strange. \[313\]](#)
- [Images are printed with both edges cut off. \[314\]](#)
- [You cannot print images with the date. \[315\]](#)

## **Others**

- [The lens gets fogged. \[316\]](#)
- [The product becomes warm when you use it for a long time. \[317\]](#)
- [The Clock Set screen appears when you turn on the product. \[318\]](#)
- [The number of recordable images does not decrease, or decreases two images at a time. \[319\]](#)
- [The product does not work properly. \[320\]](#)
- [“--E-” appears on the screen. \[321\]](#)

## Messages

### Messages

- [Warning messages \[322\]](#)

## Situations this product has difficulty handling

### Situations this product has difficulty handling

- [Situations this product has difficulty handling \[323\]](#)

---

[1] How to Use | Before Use | Names of parts

## Checking the camera and the supplied items

---

First check the model name of your camera.

The accessories supplied differ depending on the model.

The number in parentheses indicates the number of pieces.

### Supplied with all models:

- Camera (1)
- BC-VM10A Battery charger (1)

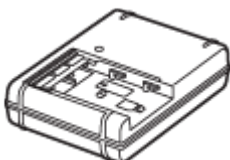



- Power cord (mains lead) (1)\* (not supplied in the U.S.A. and Canada)

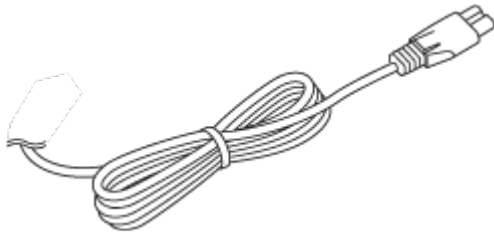

\*Multiple power cords may be supplied with your camera. Use the appropriate one that matches your country/region.

- NP-FM500H Rechargeable battery pack (1)



- Micro USB cable (1)

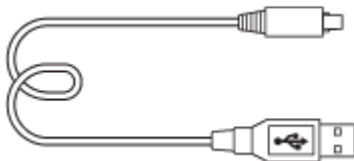

- Shoulder strap (1)

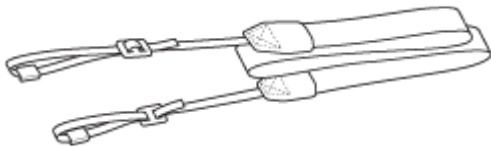

- Body cap (1) (Attached on the camera)



- Shoe cap (1) (Attached on the camera)
- Eyepiece cup (1) (Attached on the camera)
- Instruction Manual (1)
- Wi-Fi Connection/One-touch (NFC) Guide (1)

## **ILCA-77M2Q**

- DT 16-50 mm zoom lens (1)/Front lens cap (1)/Rear lens cap (1)/Lens hood (1)



## **ILCA-77M2M**

- DT 18-135 mm zoom lens (1)/Front lens cap (1)/Rear lens cap (1)/Lens hood (1)

## Identifying parts (Front side)

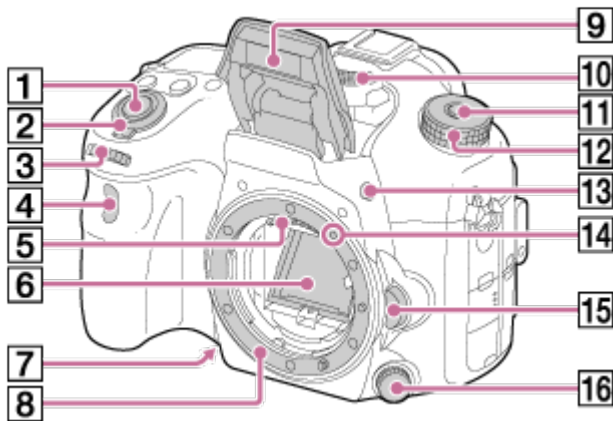
---



1. Shutter button
2. Power switch
3. Front control dial
4. Remote sensor
5. Lens contacts\*
6. Mirror\*
7. Preview button
8. Mount
9. Built-in flash\*
  - Press the  (Flash pop-up) button to use the flash. In [Intelligent Auto] and [Scene Selection] mode, the flash pops up automatically when you press the shutter button if the camera determines that the light is insufficient or that the subject is backlit.
  - When not using the flash, press it back into the camera body.
10. Microphone\*\*
11. Mode dial lock release button
12. Mode dial
13.  (Flash pop-up) button
14. Mounting index
15. Lens release button
16. Focus mode dial

\* Do not directly touch these parts.

\*\* Do not cover this part during movie recording. Doing so may cause noise or lower the volume.

---

[3] How to Use | Before Use | Names of parts



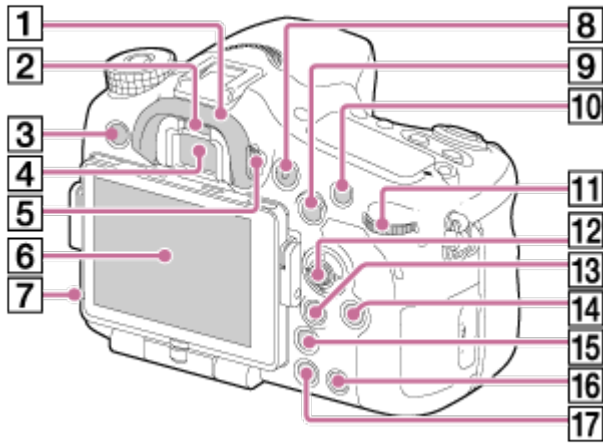

## Identifying parts (Rear side)

---

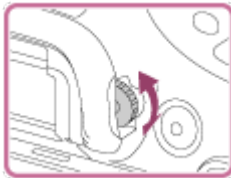

1. Eyecup
2. Eye sensor
3. MENU button
4. Viewfinder\*
  - When you look into the viewfinder, the viewfinder mode is activated, and when you take your face away from the viewfinder, the screen mode returns to the monitor mode.
5. Diopter-adjustment dial
  - Adjust the diopter-adjustment dial according to your eyesight until the display appears clearly in the viewfinder.



6. Monitor
7. Light sensor
8. MOVIE button
9. For shooting: AEL (AE lock) button/SLOW SYNC button  
For viewing:  (Image index) button
10. For shooting: AF/MF (Auto focus/manual focus) button  
For viewing:  (Enlarge) button
11. Rear control dial
12. Multi-selector
13. For shooting: Fn (Function) button  
For viewing:  (Send to Smartphone) button
  - You can display the screen for [Send to Smartphone] by pressing this button.
  - When you attach a vertical grip (sold separately), pressing the  (Image rotation) button on the vertical grip displays the [Send to Smartphone] screen.
14. DISP (Display) button
15.  (Smart Telecon.) button

16. C (Custom) button

For viewing:  (Delete) button

17.  (Playback) button

\*Do not directly touch this part.





---

[4] How to Use | Before Use | Names of parts

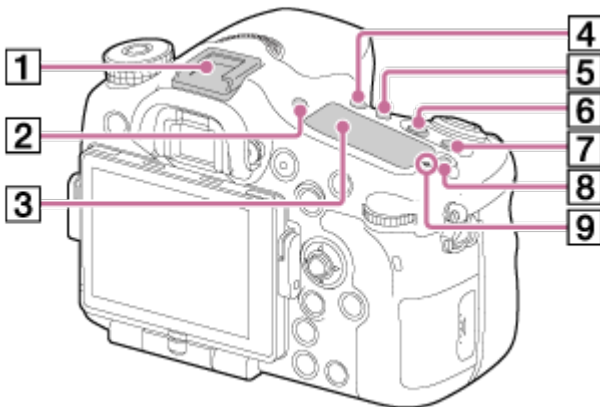
## Identifying parts (Top side)

---



1. Multi interface shoe\*
2. FINDER/MONITOR button
3. Display panel
4.  /  (Drive Mode) button
5. WB (White balance) button
6.  (Exposure Comp.) button
7. ISO button
8. Display panel illumination button
9.  Image sensor position mark

\*For details on compatible accessories of the Multi interface shoe, visit the Sony website in your area, or consult your Sony dealer or local authorized Sony service facility.

Accessories for the Accessory Shoe can also be used.

Operations with other manufactures' accessories are not guaranteed.

**ni** Multi  
Interface Shoe

Accessory Shoe

## Identifying parts (Sides/Bottom)

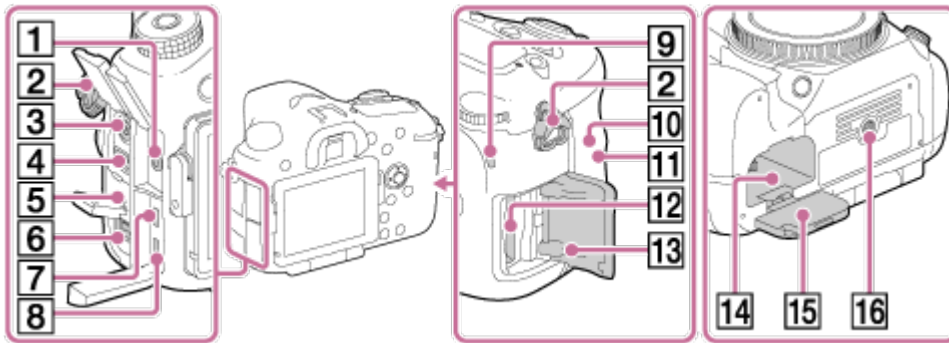

### 1. Microphone jack

- When an external microphone is connected, the internal microphone is turned off automatically.

When the external microphone is a plugin-power type, the power of the microphone is supplied by the camera.

### 2. Hooks for shoulder strap

- Attach both ends of the strap onto the camera.

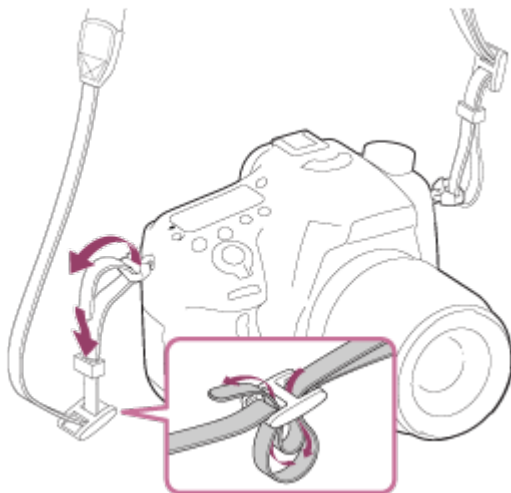

### 3. ⚡ (Flash sync) terminal

### 4. REMOTE terminal



- When connecting the RM-L1AM Remote Commander (sold separately) to the camera, insert the plug of the Remote Commander into the REMOTE terminal, aligning the guide of the plug with the guide of the REMOTE terminal. Make sure that the cord of the Remote Commander faces forward.

### 5. Speaker

### 6. DC IN terminal

- When connecting the AC-PW10AM AC Adaptor (sold separately) to the camera, turn the camera off, then plug the connector of the AC Adaptor to the DC IN terminal on

the camera.

7. HDMI micro jack
8. Multi/Micro USB Terminal\*
  - Supports Micro USB compatible device.
9. Access lamp
10.  (N mark)
  - This mark indicates the touch point for connecting the camera and an NFC-enabled Smartphone.  
For details on the location of the  (N mark) on your Smartphone, refer to the operating instructions of the Smartphone.
  - NFC (Near Field Communication) is an international standard of short-range wireless communication technology.
11. Wi-Fi sensor (built-in)
12. Memory card insertion slot
13. Memory card cover
14. Battery insertion slot
15. Battery cover
16. Tripod socket hole
  - Use a tripod with a screw less than 5.5 mm (7/32 inches) long.  
Otherwise, you cannot firmly secure the camera, and damage to the camera may occur.

\* For details on compatible accessories for the Multi/Micro USB Terminal, visit the Sony website, or consult your Sony dealer or local authorized Sony service facility.

---

[6] How to Use | Before Use | Names of parts

## Identifying parts Lens DT 16-50mm F2.8 SSM (Supplied with the ILCA-77M2Q)

---

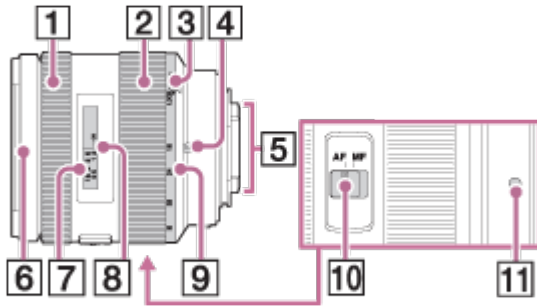

1. Focusing ring
2. Zoom ring
3. Zoom lock switch
4. Focal-length index
5. Lens contacts\*
6. Lens hood index
7. Distance scale
8. Distance index
9. Focal-length scale
10. Focusing mode switch
11. Mounting index

\*Do not directly touch this part.

- The DT 16-50mm F2.8 SSM is designed for Sony A-mount cameras (models equipped with an APS-C sized image sensor).  
You cannot use this lens on 35mm-format cameras.
- For the lenses other than DT 16-50mm F2.8 SSM, refer to the operating instructions supplied with the lens.

---

[7] How to Use | Before Use | Names of parts

## Identifying parts Lens DT 18-135mm F3.5-5.6 SAM (Supplied with the ILCA-77M2M)

---

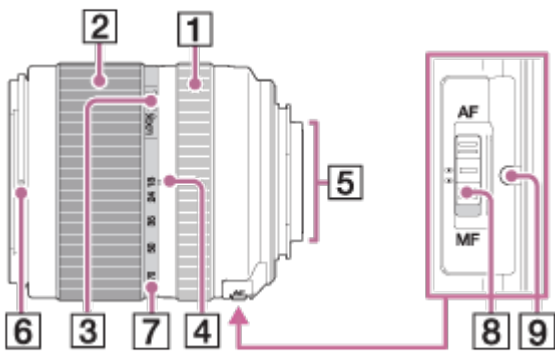

1. Focusing ring
2. Zoom ring
3. Zoom lock switch
4. Focal-length index
5. Lens contacts\*
6. Lens hood index
7. Focal-length scale
8. Focusing mode switch
9. Mounting index

\*Do not directly touch this part.

- The DT 18-135mm F3.5-5.6 SAM is designed for Sony A-mount cameras (models equipped with an APS-C sized image sensor).  
You cannot use this lens on 35mm-format cameras.
- For the lenses other than DT 18-135mm F3.5-5.6 SAM, refer to the operating instructions supplied with the lens.

---

[8] How to Use | Before Use | Icons and indicators

## List of icons on the screen

---

The displayed contents and their positions shown below are just a guideline, and may differ from the actual display.

### **Monitor mode**



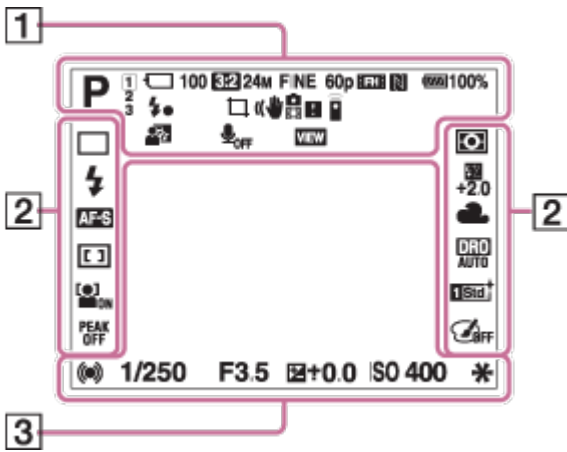

## For playback (Basic information display)

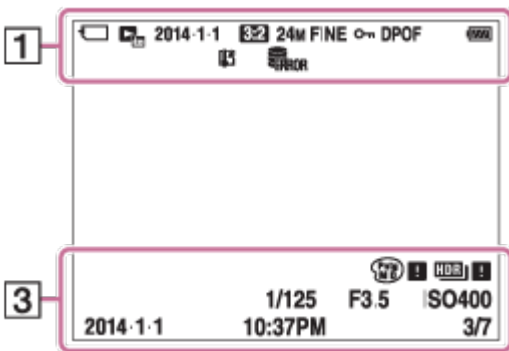

## Viewfinder mode

In Auto Mode or Scene Selection mode

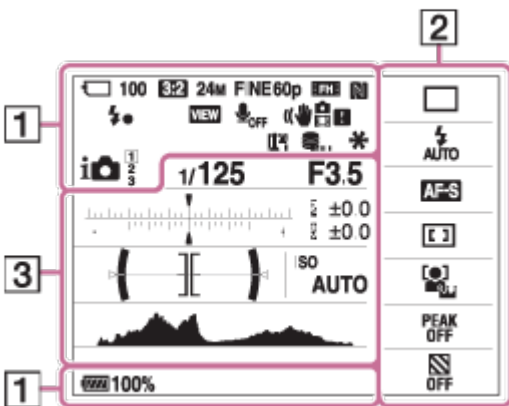

## P/A/S/M/Sweep Panorama mode

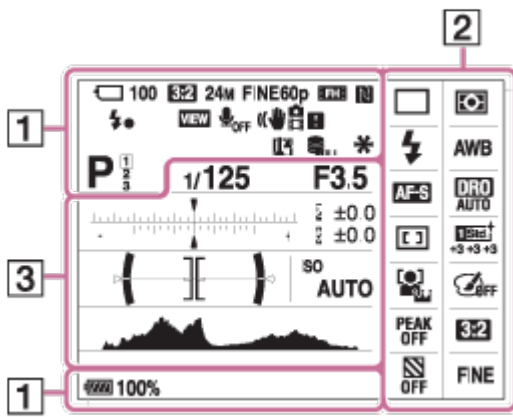

Shooting mode



Register number



Scene Recognition icons



Memory card/Upload

**100**

Remaining number of recordable images



Aspect ratio of still images

**24M / 12M / 6.0M / 20M / 10M / 5.1M**



Image size of still images

**RAW RAW+J X.FINE FINE STD**

Image quality of still images



Frame rate of movies



Image size of movies



Remaining battery



Remaining battery warning



Flash charge in progress



Setting Effect OFF



NFC is activated



Airplane Mode



No audio recording of movies



Wind Noise Reduction



SteadyShot/Camera shake warning



SteadyShot/Camera shake warning



Overheating warning



Database file full/Database file error



Smart Zoom/ Clear Image Zoom/Digital Zoom



Spot metering area

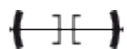

Digital level gauge



Audio level



View Mode

**100-0003**

Folder - file number



Protect

**XAVC S AVCHD MP4**

Recording mode of movies

## DPOF

DPOF set



Auto Obj. Framing



Smart Telecon.



PC Remote



Remote controller

- 2.

Drive mode



Flash mode/Red-eye reduction

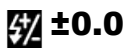

Flash compensation



Focus mode



Focus area



Smile/Face Detect.



Metering mode

**AWB** -1 0 +1 +2 **7500K A5 G5**

White balance (Auto, Preset, Custom, Color temperature, Color filter)



D-Range Optimizer/Auto HDR



Creative Style/Contrast, Saturation, Sharpness



Picture Effect



Smile detection sensitivity indicator



Zebra

3. -5 4 3 2 1 0 1 2 3 4 5+

EV scale



AF Range Control



Exposure compensation/Flash compensation gauge



Exposure compensation/Metered Manual

**REC 0:12**

Recording time of the movie (m:s)



Focus

**1/250**

Shutter speed

**F3.5**

Aperture Value

**ISO400**

**ISO AUTO**

ISO sensitivity



AE lock/FEL lock



Shutter speed indicator



Aperture indicator



Histogram



Auto HDR image warning



Picture Effect error

**2014-1-1**

**10:37PM**

Date of recording

**3/7**

File number/Number of images in the view mode

[9] How to Use | Before Use | Icons and indicators

## Display panel

You can set the shutter speed and aperture, exposure compensation, flash compensation, ISO, white balance, drive mode, and image quality, etc., using the display panel on top of the camera.



### Shutter speed/Aperture

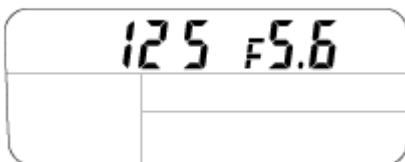

### Exposure compensation/Flash compensation

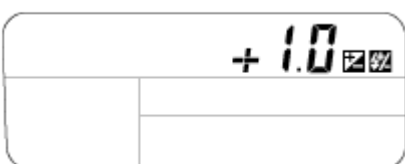

### ISO

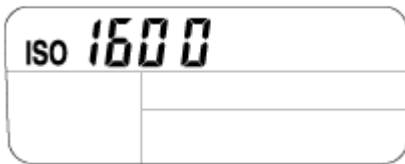

## White Balance

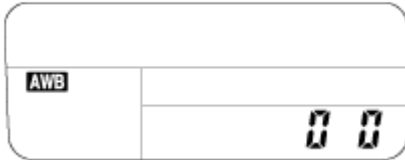

## Drive Mode/Remote controller



## Image quality

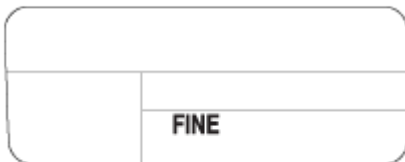

## Remaining battery

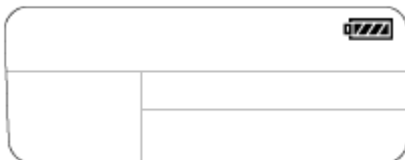

## Number of recordable images\*

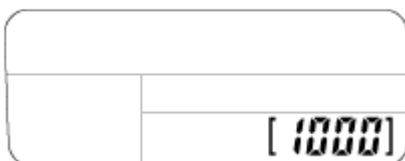

\* Even if the number of recordable images is higher than 9,999 images, "9999" will appear on the display panel.

## To turn on the display panel backlight

Press the illumination button (A) on top of the camera. If you press the button again, the display panel backlight will turn off.

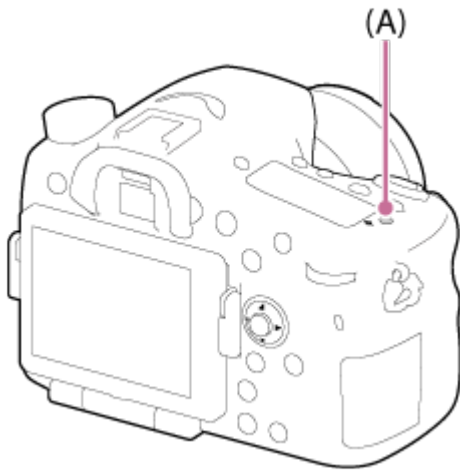

---

[10] How to Use | Before Use | Using the strap

## Using the shoulder strap

---

Attach the shoulder strap to prevent damage caused by dropping the product.

1. Attach both ends of the strap.

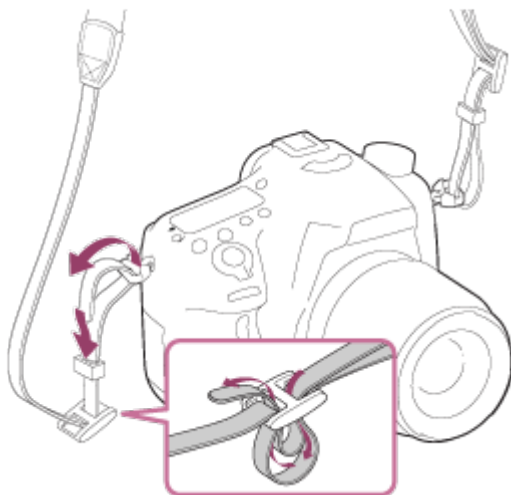

---

[11] How to Use | Before Use | Attaching the eyepiece cup

## Attaching the eyepiece cup

---

It is recommended that you attach the eyepiece cup when you intend to use the viewfinder.

1. Match the eyepiece cup to the groove on the viewfinder and slide it into place.



- To remove the eyepiece cup, grasp it on the left and right sides and lift it up.

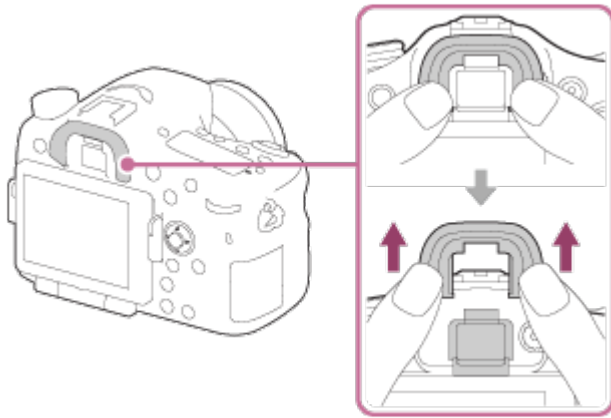

---

[12] How to Use | Before Use | Adjusting the viewfinder

## Adjusting the viewfinder (diopter-adjustment)

---

Adjust the diopter scale to your eyesight until the display appears clearly in the viewfinder. If it is difficult to turn the diopter-adjustment dial, remove the eyepiece cup and then adjust the dial.

1. Turn the diopter-adjustment dial.

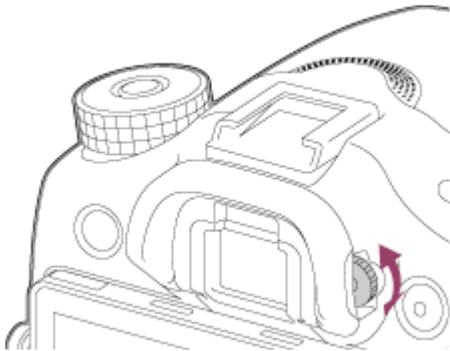



---

[13] How to Use | Before Use | In-Camera guide

## About the [In-Camera Guide]

---

The [In-Camera Guide] displays descriptions of MENU items, Fn (Function) button, and settings, and if a function cannot be set, the reason why.

1. MENU →  (Custom Settings) → [Custom Key Settings] → desired functions assigned to the button → [In-Camera Guide]
2. Press the MENU or Fn button.
3. Select the desired MENU item using up/down/left/right side on the multi-selector.
4. Press the button to which the [In-Camera Guide] function is assigned.  
The operation guide for the MENU item you have selected in step 3 is displayed.
  - If you press the  on the center of the multi-selector after selecting an item shown in gray, the reason the item cannot be set is displayed.

---

[14] How to Use | Preparing the camera | Charging the battery pack

## Charging the battery pack using a charger

---

When using the camera for the first time, be sure to charge the InfoLITHIUM NP-FM500H (supplied). The InfoLITHIUM battery pack can be charged even when it is not fully depleted. It can also be used when it is not fully charged. The charged battery pack discharges little by little even when it is not being used. To avoid missing a shooting opportunity, charge the battery pack again before shooting.

1. Insert the battery pack into the battery charger.  
Push the battery pack lightly until it clicks.

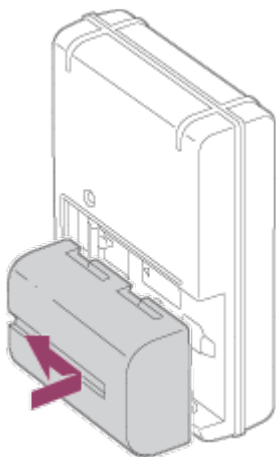

2. Connect the battery charger to the wall outlet (wall socket).

**For the U.S.A. and Canada**

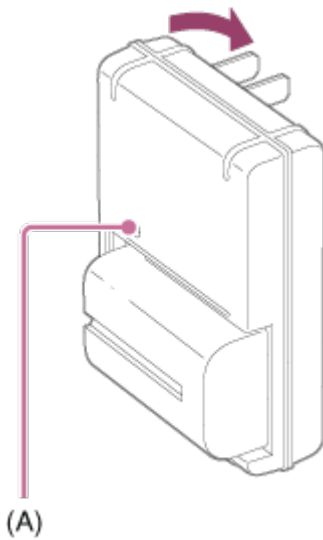

### For countries/regions other than the U.S.A. and Canada

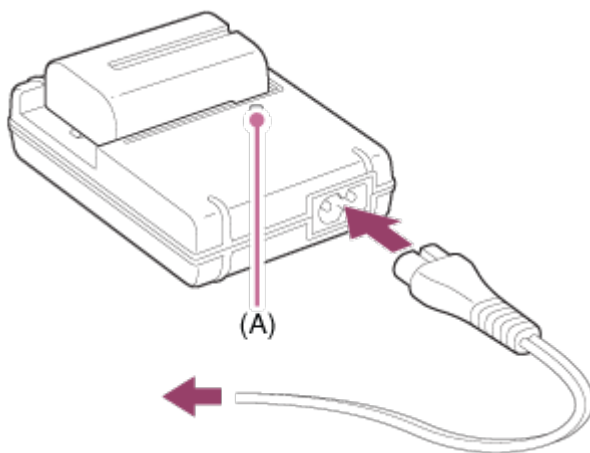

Light on: Charging

Light off: Charge completed

Charging time (Full charge): Approx. 175 minutes

- When charging a fully depleted battery pack at a temperature of 25°C (77°F).
- The CHARGE lamp **(A)** turns off when charging is completed.

#### Note

- The charging time differs depending on the remaining charge of the battery pack and on the charging conditions.
- Be sure to use only genuine Sony brand battery packs.
- We recommend charging the battery pack at an ambient temperature of between 10°C to 30°C (50°F to 86°F). You may not be able to efficiently charge the battery pack outside this temperature range.
- Connect the battery charger to the nearest wall outlet (wall socket). If malfunctions occur while using the charger, disconnect the plug from the wall outlet (wall socket) immediately to disconnect from the power source.
- Even when the CHARGE lamp of this battery charger is off, the power is not disconnected. If any trouble occurs while this unit is in use, unplug it from the wall outlet

(wall socket) to disconnect the power.

- When the camera is being used for the first time or when you use a battery pack that has not been used for a long time, the CHARGE lamp may flash quickly when the battery is charged for the first time. If this happens, remove the battery pack from the charger and then re-insert it to recharge.
- Do not continuously or repeatedly charge the battery pack without using it if it is already fully charged or close to fully charged. Doing so may cause a deterioration in battery performance.

---

[15] How to Use | Preparing the camera | Charging the battery pack

## Inserting the battery pack into the camera

---

How to insert the battery pack into the camera

1. Slide the open lever to open the battery cover.

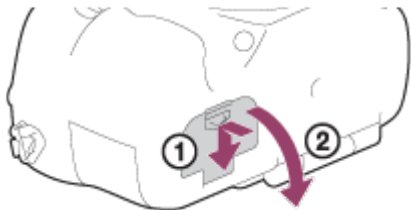

2. Insert the battery pack while pressing the lock lever **(A)** with the tip of the battery until the battery locks into place.

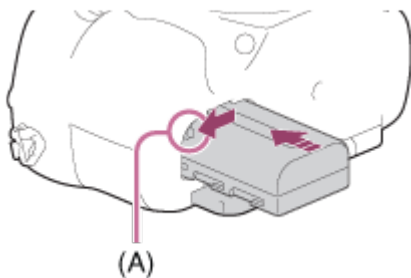

3. Close the cover.

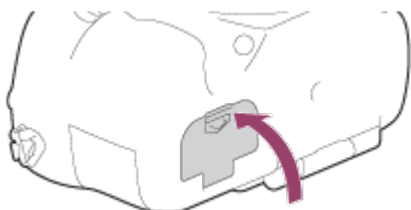

# Battery life and the number of images that can be recorded/played back using a battery pack

---

## Screen mode

Shooting (still images):

Battery life: approx. 240 min., Number of images: approx. 480

Actual shooting (movies):

Battery life: approx. 120 min.

Continuous shooting (movies):

Battery life: approx. 175 min.

Viewing (still images):

Battery life: approx. 270 min., Number of images: approx. 5400

## Viewfinder mode

Shooting (still images):

Battery life: approx. 205 min., Number of images: approx. 410

Actual shooting (movies):

Battery life: approx. 110 min.

Continuous shooting (movies):

Battery life: approx. 175 min.

Viewing (still images):

Battery life: approx. 320 min., Number of images: approx. 6400

### Note

- The above battery life and number of images applies when the battery pack has been fully charged. The battery life and number of images may decrease depending on the conditions of use.
- The battery life and number of images that can be recorded is for shooting under the following conditions:
  - The battery pack is used at an ambient temperature of 25°C (77°F).
  - Using the lens DT 16-50mm F2.8 SSM
  - Using Sony Memory Stick PRO Duo media (sold separately)
  - [Viewfinder Bright.]: [Manual][±0]
  - [Monitor Brightness]: [Manual][±0]
- The number for "Shooting (still images)" is based on the CIPA standard, and is for shooting under the following conditions (CIPA: Camera & Imaging Products Association):
  - Focus Mode: [Single-shot AF]
  - One picture is taken every 30 seconds.
  - The power is turned on and off once every ten times.
- The number for "Actual shooting (movies)" is based on the CIPA standard, and is for

shooting under the following conditions:

- The image quality is set to 60i 17M (FH) .
  - Actual shooting (movies): Battery life based on repeated shooting, zooming, shooting stand-by, turning on/off, etc.
  - Continuous movie shooting: Battery life based on non-stop shooting until the limit (29 minutes) has been reached, and then continued by pressing the MOVIE button again. Other functions, such as zooming, are not used.
- If the remaining battery is not displayed, press the DISP (Display Setting).

---

[17] How to Use | Preparing the camera | Charging the battery pack

## Supplying power using a wall outlet (wall socket)

---

Power can be supplied to the camera during shooting/playback using an AC adaptor AC-PW10AM (sold separately).

1. To supply power to the camera during shooting/playback, connect the camera and the AC adaptor AC-PW10AM (sold separately) and plug the AC adaptor to a wall outlet (wall socket).

---

[18] How to Use | Preparing the camera | Charging the battery pack

## Removing the battery pack

---

How to remove the battery pack

1. Make sure that the access lamp is not lit, and turn off the camera.
2. Slide lock lever **(A)** and remove the battery pack.

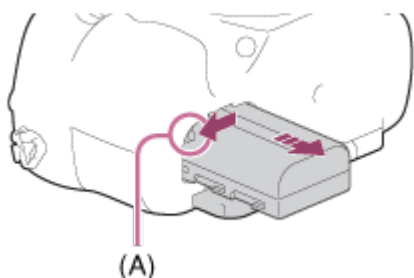

- Be careful not to drop the battery pack.

## Inserting a memory card

---

How to insert a memory card

1. Slide the memory card cover to open it.

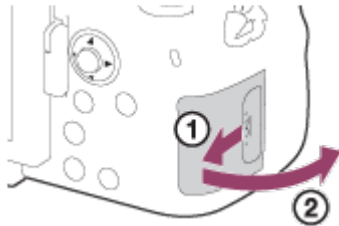

2. Insert the memory card.

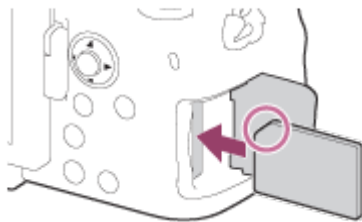

- Ensure that the notched corner is facing in the correct direction.
- With the notched corner facing in the direction illustrated, insert the memory card until it clicks into place.

3. Close the memory card cover.

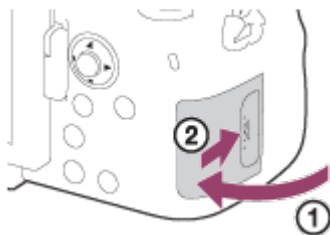

## Removing the memory card

---

How to remove the memory card

1. Open the memory card cover.
2. Make sure that the access lamp **(A)** is not lit.

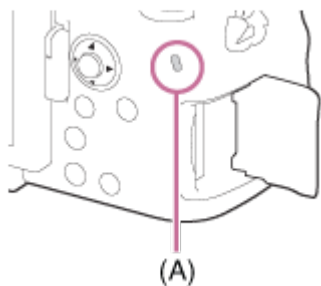

3. Push in on the memory card once to remove it.

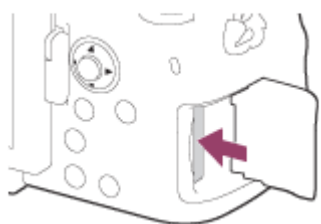

4. Close the memory card cover.

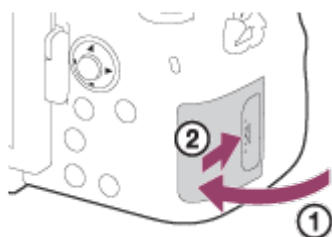

---

[21] How to Use | Preparing the camera | Attaching a lens

## Attaching a lens

---

Set the power switch of the camera to OFF before attaching the lens.

1. Remove the body cap **(A)** from the camera and the rear lens cap **(B)** from the rear of the lens.



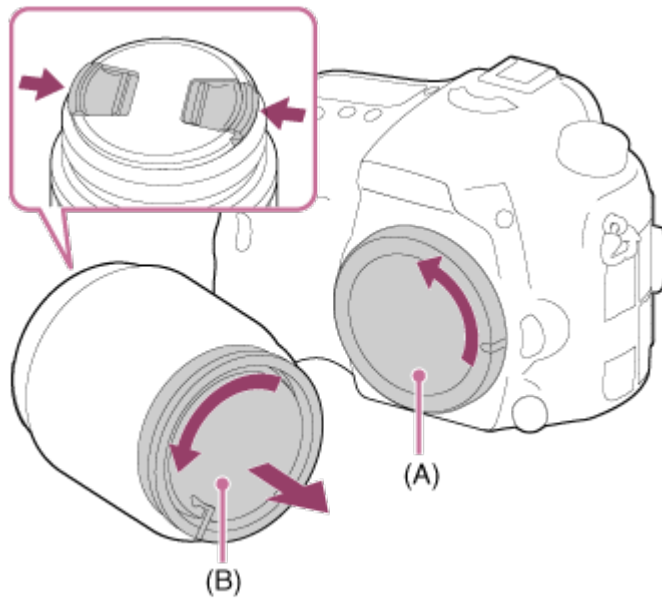

- When changing the lens, work quickly in a dust-free location to keep dust or debris from getting inside the camera.
- When shooting, remove the front lens cap from the front of the lens.

2. Mount the lens by aligning the two orange index marks (mounting indexes) on the lens and camera.

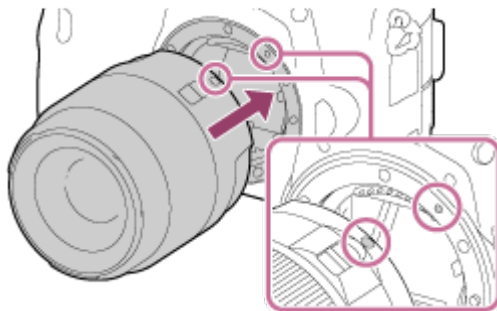

- Hold the camera with the lens facing down to prevent dust and debris from entering the camera.

3. While pushing the lens lightly toward the camera, turn the lens slowly in the direction of the arrow until it clicks into the locked position.

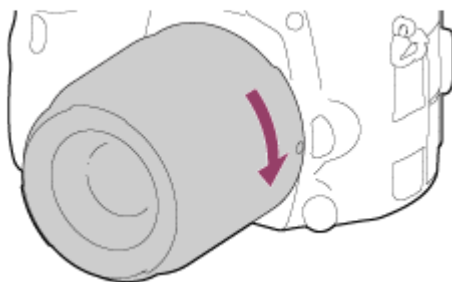

- Be sure to hold the lens straight when attaching it.

### Note

Do not press the lens release button when attaching a lens.

- Do not use force when attaching a lens.
- E-mount lenses are not compatible with this camera.
- When you use a lens with a tripod socket, attach a tripod to the tripod socket of the lens to help balance the weight of the lens.
- When carrying the camera with a lens attached, hold both the camera and the lens firmly.
- Do not hold the part of the lens that is extended for zoom or focus adjustment.

---

[22] How to Use | Preparing the camera | Attaching a lens

## Removing the lens

---

Set the power switch of the camera to OFF before you remove the lens.

1. Keep pressing the lens release button **(A)** and turn the lens in the direction of the arrow until it stops.

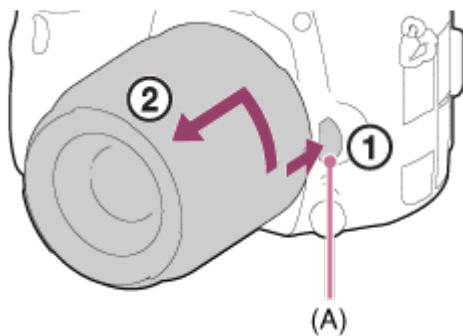

2. Attach the lens caps to the front and rear of the lens and the body cap to the camera.

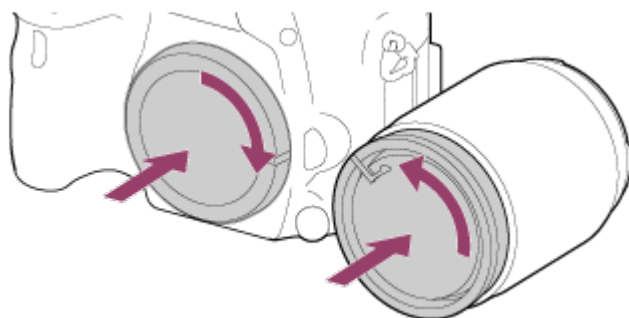

- Remove any dust from the caps before attaching them.

---

[23] How to Use | Preparing the camera | Attaching a lens

## Attaching the lens hood

---

We recommend that you use the lens hood to prevent light outside the shooting frame from affecting the image.

1. Match the shape of the lens hood mounting part and lens head, and turn the lens hood clockwise until it clicks.

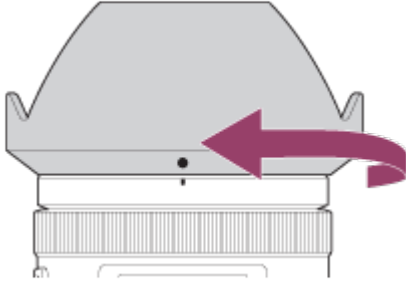

#### Note

- Attach the lens hood properly. Otherwise, the lens hood may not have any effect or may be partially reflected in the image.
- When the lens hood is attached properly, the lens hood index (red line) matches the red index mark on the hood. (There may be no lens hood index on some lenses.)
- Remove the lens hood when using the flash. Otherwise, the lens hood blocks the flash light and may appear as a shadow on the image.
- To store the lens hood after shooting, attach the lens hood to the lens backward.

---

[24] How to Use | Preparing the camera | Attaching a lens

## Notes on changing the lens

When changing the lens, if dust or debris gets inside the camera and adheres to the surface of the image sensor (the part that converts the light to an electric signal), it may appear as dark spots on the image, depending on the shooting environment.

This camera is equipped with an anti-dust function that causes the image sensor to vibrate a little when the power is turned off to prevent dust from attaching to the image sensor.

However, always make sure to attach/remove the lens quickly away from dusty locations.

---

[25] How to Use | Preparing the camera | Setting the date and time

## Setting the date and time

When you turn on the camera for the first time or after you have initialized the functions, the setting screen for the date and time appears.

1. Set the power switch to ON to turn on the camera.  
The setting screen for the date and time appears.
2. Check that [Enter] is selected on the screen, then press ● on the multi-selector.
3. Select your desired geographic location, and then press ●.
4. Select a setting item using the up/down side of the multi-selector, then press ● in the center.
5. Set [Daylight Savings], [Date/Time], and [Date Format] using the up/down/left/right sides, then press ● in the center.
  - Midnight is indicated as 12:00 AM, and noon as 12:00 PM.
6. Repeat steps 4 and 5 to set other items, then select [Enter] and press ● in the center.
  - To cancel the date and time setting procedure, press the MENU button.

#### Note

- This camera does not have a function for inserting the date on images. You can insert the date on images and then save and print them using PlayMemories Home.
- If the date and time setting is cancelled halfway, the setting screen for the date and time appears every time you turn on the camera.

---

[26] How to Use | Confirming the operation method | Confirming the operation method

## Using the multi-selector

---

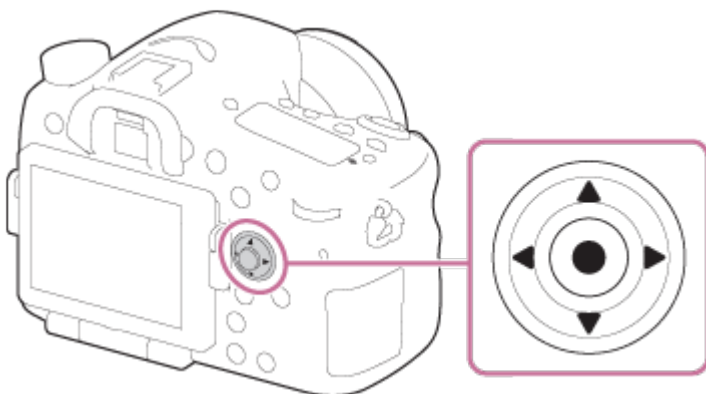

- You can move the selection frame by pressing up/down/left/right side of the multi-

selector. The item selected with the multi-selector can be entered by pressing ● in the center.

- Press the left/right side of the multi-selector while playing back images to display the previous or next image.
- The [Standard] function is assigned to ● in the center with the default setting. When you press ● in the center, the product automatically focuses on the center of the screen.

---

[27] How to Use | Confirming the operation method | Confirming the operation method

## Using MENU items

---

In this section, you learn how to change settings related to all camera operations and execute camera functions including shooting, playback, and operation methods.

1. Press MENU button to display the Menu screen.

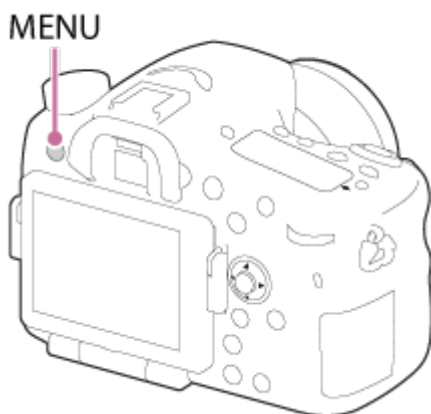

2. Select the desired MENU item using the up/down/left/right side of the multi-selector, and then press ● in the center of the multi-selector.
  - The display may move directly from step 1 to step 3 depending on the [Tile Menu] setting.

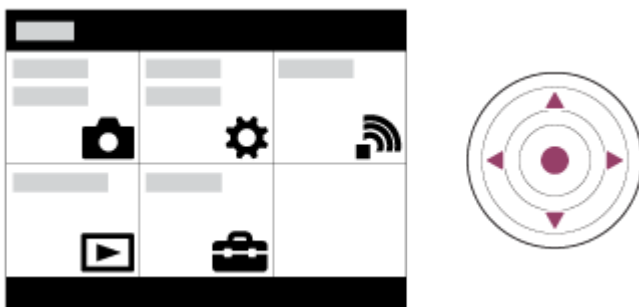

3. Select the item you want to set by pressing the up/down/left/right side of the multi-selector, and then press ● in the center of the multi-selector.

- Select an icon at the top of the screen and press the left/right side of the multi-selector to move to another MENU item.



4. Select the desired setting value, and press ● to confirm.

---

## [28] How to Use | Confirming the operation method | Confirming the operation method Using the Fn (Function) button

---

You can register frequently used functions to the Fn (function) button and recall them while shooting. Up to 12 frequently used functions can be registered to the Fn (Function) button.

1. Press the DISP button, and then press the Fn (Function) button in a screen mode other than [For viewfinder].

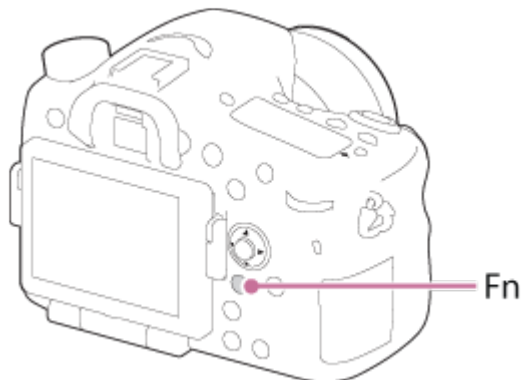

2. Select a function to be registered by pressing the up/down/left/right side of the multi-selector.

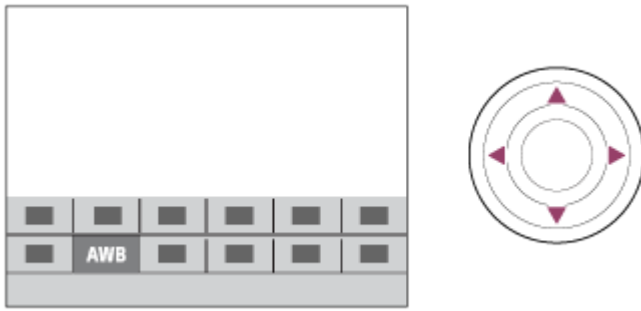

3. Select the desired setting by turning the front dial, and press ● in the center of the multi-selector.
  - Some functions can be fine-tuned using the rear dial.

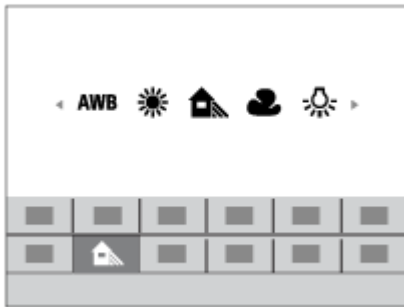

## Performing settings on the dedicated screen

- Select the desired function in step 2, then press ● in the center of the multi-selector. The dedicated setting screen for the function appears. Follow the operating guide (A) to perform the settings.

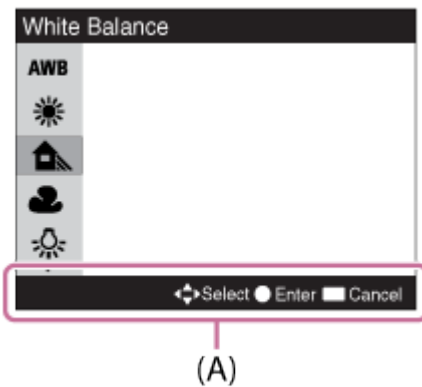

---

## [29] How to Use | Confirming the operation method | Confirming the operation method Using the "Quick Navi"

---

You can change the settings directly using the Quick Navi screen when using the viewfinder. The displayed contents and their position shown below are just a guideline, and may differ

from the actual display.

1. Press the DISP (Display Setting) button repeatedly until the screen is set to [For viewfinder].
2. Press Fn (Function) button to switch the screen to Quick Navi screen.

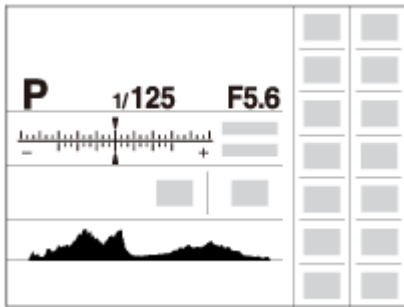

3. Select the desired function by pressing the up/down/left/right side of the multi-selector.
4. Turn the front dial to select the desired setting.
  - Some setting values can be finely adjusted by turning the rear dial.

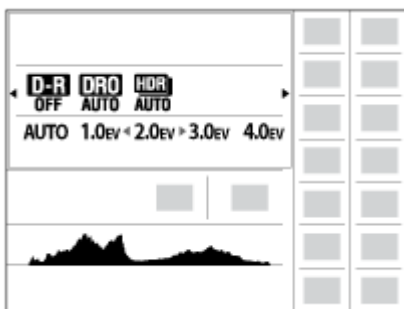

## Performing settings on the dedicated screen

- Select the desired function in step 3, then press ● in the center of the multi-selector. The dedicated setting screen for the function appears. Follow the operating guide (A) to perform the settings.

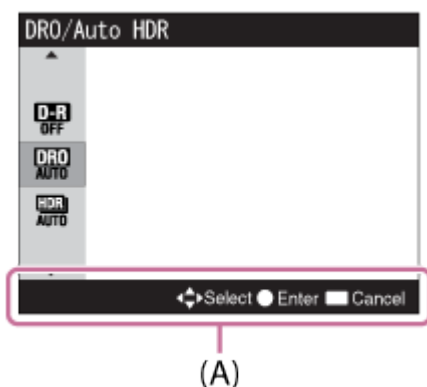



# Shooting still images

---

Shoots still images.

1. Set the shooting mode to **AUTO** (Auto Mode).

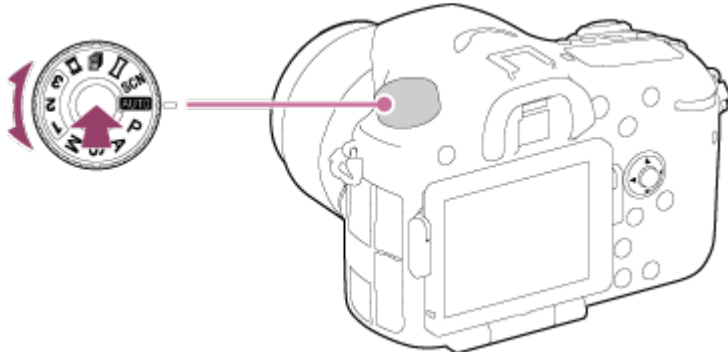

- Turn the mode dial while pressing the mode dial lock release button in the center of the mode dial.
2. Adjust the monitor angle, and hold the camera. Or look through the viewfinder and hold the camera.
  3. Press the shutter button halfway down to focus.  
When the image is in focus, the indicator ( ● or (●●) ) lights up.

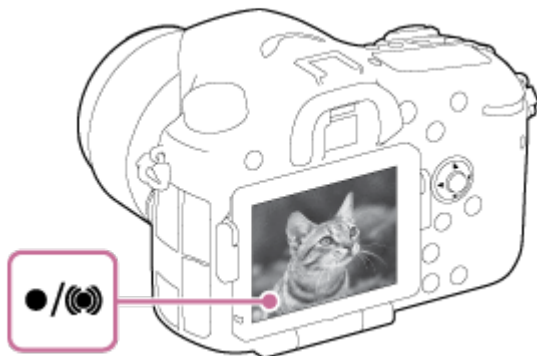

4. Press the shutter button fully down.

## Focus indicator

● lights:

Image is in the focus.

● flashes:

The focusing has failed.

(●●) lights:

Image is in the focus. The focused position will change to suit the motion of the subject.

(●) lights:

The focusing is in progress.

### Hint

- When the product cannot focus automatically, the focus indicator flashes and the beep does not sound. Either recompose the shot or change the focus setting. When [Continuous AF] is set, the beep does not sound when focus is achieved.
- Focusing may be difficult in the following situations:
  - It is dark and the subject is distant.
  - The contrast between the subject and the background is poor.
  - The subject is seen through glass.
  - The subject is moving quickly.
  - There is reflective light or shiny surfaces.
  - There is a flashing light.
  - The subject is backlit.

---

[31] How to Use | Shooting | Shooting still images/movies

## Shooting movies

---

You can record movies by pressing the MOVIE button.

1. Set the mode dial to  (Movie).
2. Press the MOVIE button to start recording.

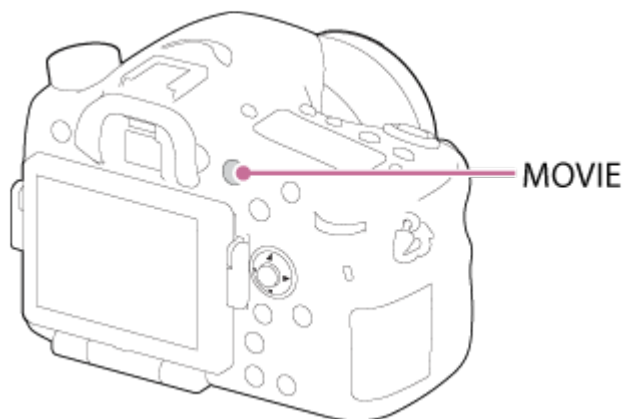

3. Press the MOVIE button again to stop recording.

### Note

- To adjust the shutter speed and aperture value to the desired settings, set the shooting mode to  (Movie).
- If you use a function such as zoom while shooting a movie, the noise of the product operating will be recorded. The sound of the MOVIE button operating may also be recorded when you press the MOVIE button to stop recording.

- For the continuous shooting time of a movie recording, refer to "Recordable time of movies." When movie recording is finished, you can restart recording by pressing the MOVIE button again. Recording may stop to protect the product, depending on the temperature of the product or the battery.
- When shooting, the sound of the shoulder strap hooks (triangular hook) could be recorded, depending on the situation used.

---

[32] How to Use | Shooting | Selecting a shooting mode

## List of mode dial functions

---

You can select the desired shooting mode by turning the mode dial.

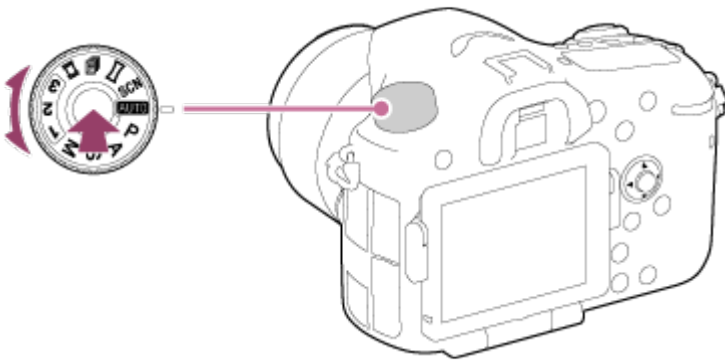

- Turn the mode dial while pressing the mode dial lock release button in the center of the mode dial.

### Available functions

#### **AUTO (Auto Mode):**

Allows you to shoot still images of any subject under any condition with good results by setting the values determined appropriate by the product.

#### **P (Program Auto):**

Allows you to shoot with the exposure adjusted automatically (both the shutter speed and the aperture value (F value)). Also you can select various settings using the menu.

#### **A (Aperture Priority):**

Allows you to adjust the aperture and shoot when you want to blur the background, etc.

#### **S (Shutter Priority):**

Allows you to shoot fast-moving subjects etc., by manually adjusting the shutter speed.

#### **M (Manual Exposure):**

Allows you to shoot still images with the desired exposure by adjusting the shutter speed and the aperture value.

#### **1/2/3 (Memory recall):**

Allows you to shoot an image after recalling often-used modes or numeric settings

registered in advance.

### **(Movie):**

Allows you to change the setting for movie recording.

### **(Cont. Priority AE):**

Allows continuous shooting while the shutter button is fully depressed. The camera records images continuously at a maximum of about 12 images per second.

### **(Sweep Panorama):**

Allows you to shoot a panoramic image by compositing the images.

### **SCN (Scene Selection):**

Allows you to shoot with preset settings according to the scene.

---

[33] How to Use | Shooting | Selecting a shooting mode

## Intelligent Auto

---

The product analyzes the subject, and allows you to shoot with appropriate settings.

1. Set the mode dial to **AUTO** (Auto Mode).
2. MENU →  (Camera Settings) → [Auto Mode] → [Intelligent Auto].
  - When [Mode Dial Guide] is set to [On], you can select the desired settings after you have changed the position of the mode dial.
3. Point the camera to the subject.

When the camera recognized the scene, the icon for the recognized scene appears on the screen.



4. Adjust the focus and shoot the image.

### **Note**

- The product will not recognize the scene when you shoot images with zoom functions other than optical zoom.
- The product may not properly recognize these scenes under some shooting conditions.

## Superior Auto

The product automatically recognizes and evaluates the shooting conditions, and the appropriate settings are set automatically.

The product may shoot multiple images and create a composite image, etc., using more shooting settings than in Intelligent Auto mode to record higher quality images.

1. Set the mode dial to **AUTO** (Auto Mode).
2. MENU →  (Camera Settings) → [Auto Mode] → [Superior Auto].
  - When [Mode Dial Guide] is set to [On], you can select the desired settings after you have changed the position of the mode dial.
3. Point the camera to the subject.

When the camera recognizes a scene, scene recognition icon appears on the screen. If necessary, appropriate shooting function for the recognized scene and the number of times the shutter is released also appear.

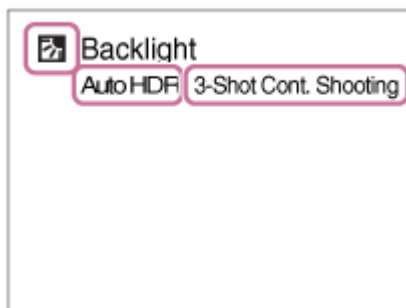

4. Adjust the focus and shoot the image.

### Hint

#### How to shoot continuous images in [Superior Auto] mode

MENU →  (**Custom Settings**) → [Superior Auto] → [Cont. Shooting] → desired settings.

#### How to change the save method for continuous images recorded in [Superior Auto] mode

You can select whether to save all continuous images or just a single image that is automatically selected as the best shot.

MENU →  (**Custom Settings**) → [Superior Auto] → [Image Extraction] → desired settings.

## Note

- When the product is used to create composite images, the recording process takes longer than usual.
- The product will not recognize the scene when you use zoom functions other than optical zoom.
- The product may not properly recognize a scene under some shooting conditions.
- When [  Quality] is set to [RAW] or [RAW & JPEG], the product cannot create a composite image.

---













[35] How to Use | Shooting | Selecting a shooting mode

## About Scene Recognition

---

Scene Recognition operates in [Intelligent Auto] mode and [Superior Auto] mode. This function allows the product to automatically recognize the shooting conditions and shoot the image.

### Scene Recognition:

Icons and guides such as  (Portrait),  (Infant),  (Night Portrait),  (Night Scene),  (Backlight Portrait),  (Backlight),  (Landscape),  (Macro),  (Spotlight),  (Low Light),  (Night Scene using a tripod) or  (Hand-held Twilight) are displayed.

### Image processing:

Cont. Shooting, Slow Sync., Auto HDR, Daylight Sync., Slow Shutter, Hand-held Twilight

## Note

- When [Smile/Face Detect.] is set to [Off], the [Portrait], [Backlight Portrait], [Night Portrait] and [Infant] scenes are not recognized.

---

[36] How to Use | Shooting | Selecting a shooting mode

## The advantages of automatic shooting

---

In [Superior Auto] mode, the product shoots with higher quality than [Intelligent Auto] mode and performs composite shooting as necessary.

In [Program Auto] mode, you can shoot after adjusting various functions, such as white

balance, ISO, etc.

### **i** **(Intelligent Auto):**

Select this mode when you want the camera automatically recognize the scene.

### **i** **+** **(Superior Auto):**

Select this mode to shoot scenes under difficult circumstances, such as when it is dark or the subjects are back-lit. Select this mode to shoot a higher quality image than that provided by

**i**  (Intelligent Auto).

### **P (Program Auto):**

Select this mode to shoot with various functions other than the exposure (shutter speed and aperture) adjusted.

#### **Note**

- In [Intelligent Auto] mode, you may not be able to shoot dark scenes or back-lit subjects clearly.
- In [Superior Auto] mode, the recording process takes longer, since the product creates a composite image.

---

[37] How to Use | Shooting | Selecting a shooting mode

## Program Auto

---

Allows you to shoot with the exposure adjusted automatically (both the shutter speed and the aperture value).

You can set shooting functions such as [ISO].

1. Set the mode dial to P (Program Auto).
2. Set the shooting functions to your desired settings.
3. Adjust the focus and shoot the subject.

### **Program Shift**

You can change the shutter speed and aperture (F-value) combination by rotating the front/rear dial, without changing the appropriate exposure that is set by this product. This function is available when you do not use the flash.

- “P” on the screen changes to “P\*” when you turn the front/rear dial.
- To cancel program shift, set the shooting mode to other than [Program Auto], or turn off the camera.

#### **Note**

- According to the brightness of the environment, the program shift may not be used.
- Set the shooting mode to another one than “P” or turn off the power to cancel the setting you made.
- When the brightness changes, the aperture (F value) and shutter speed also change while maintaining the shift amount.

---

[38] How to Use | Shooting | Selecting a shooting mode

## Sweep Panorama

---

Allows you to create a single panoramic image from multiple images shot while panning the camera.



1. Set the mode dial to  (Sweep Panorama).
2. Point the camera at the subject.
3. While pressing the shutter button halfway down, aim the camera at one end of the desired panoramic composition.

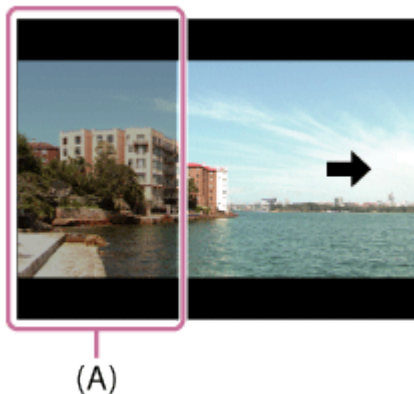

(A) This part will not be shot.

4. Press the shutter button fully down.
5. Pan the camera to the end of the guide in the direction of the arrow on the monitor.



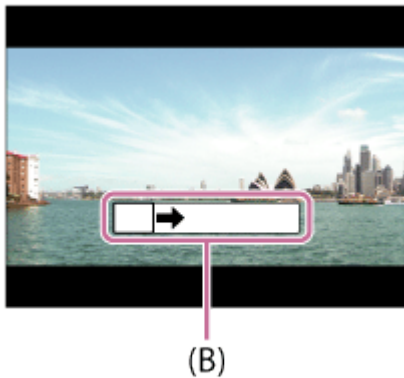

(B) Guidance bar

#### Note

- If the entire angle of the panoramic shot is not achieved within the set time, a gray area occurs in the composite image. If this happens, move the product faster to record the full panoramic image.
- When [Wide] is selected for [Panorama: Size], the entire angle of the panoramic shot may not be achieved within the given time. If this happens, try shooting after changing [Panorama: Size] to [Standard].
- Since several images are stitched together, the stitched part may not be recorded smoothly in some cases.
- The images may be blurred in dark scenes.
- When a light source such as a fluorescent light flickers, the brightness and color of a stitched image may not be consistent.
- When the whole angle of panoramic shooting and the AE/AF locked angle are very different in brightness and focus, the shooting may not be successful. If this happens, change AE/AF locked angle and shoot again.
- The following situations are not suited for shooting Sweep Panorama:
  - Moving subjects.
  - Subjects that are too close to the product.
  - Subjects with continuously similar patterns, such as the sky, beach, or a lawn.
  - Subjects with constant change such as waves or water falls.
  - Subjects with brightness widely different from its surroundings such as the sun or a light bulb.
- The Sweep Panorama shooting may be interrupted in the following situations.
  - When the camera is panned too fast or too slow.
  - The subject is too blurry.

#### Hint

- You can turn the front dial on the shooting screen to select the shooting direction.

# Scene Selection

---

Allows you to shoot with preset settings according to the scene.

1. Set the mode dial to SCN (Scene Selection).
2. MENU →  (Camera Settings) → [Scene Selection] → desired mode.
  - When [Mode Dial Guide] is set to [On], you can select the desired settings after you have changed the position of the mode dial.

## Menu item details

### **Portrait:**

Blurs background and sharpens the subject. Accentuates the skin tones softly.



### **Sports Action:**

Shoots a moving subject at a fast shutter speed so that the subject looks as if it is standing still. The product shoots images continuously while the shutter button is pressed.



### **Macro:**

Shoots close-ups of the subjects, such as flowers, insects, food, or small items.



### **Landscape:**

Shoots the entire range of a scenery in sharp focus with vivid colors.



## **Sunset:**

Shoots the red of the sunset beautifully.



## **Night Scene:**

Shoots night scenes without losing the dark atmosphere.



## **Hand-held Twilight:**

Shoots night scenes with less noise and blur without using a tripod. A burst of shots are taken, and image processing is applied to reduce subject blur, camera-shake, and noise.



## **Night Portrait:**

Shoots night scene portraits using the flash.



### **Note**

- In the [Night Scene] and [Night Portrait] modes, the shutter speed is slower, so use of a tripod is recommended to prevent the image from blurring.
- In the [Hand-held Twilight] mode, the shutter clicks 4 times and an image is recorded.
- If you select [Hand-held Twilight] with [RAW] or [RAW & JPEG], the image quality becomes [Fine] temporarily.
- Reducing blur is less effective even in [Hand-held Twilight] when shooting the following subjects:
  - Subjects with erratic movement.
  - Subjects that are too close to the product.

- Subjects with continuously similar patterns, such as the sky, a beach, or a lawn.
- Subjects with constant change such as waves or water falls.
- In the case of [Hand-held Twilight], block noise may occur when using a light source that flickers, such as fluorescent lighting.
- The minimum distance that you can come close to a subject does not change even if you select [Macro]. For the minimum in-focus range, refer to the minimum distance of the lens attached to the product.

#### Hint

- To change the scene, rotate the front dial on the shooting screen and select a new scene.

---

[40] How to Use | Shooting | Selecting a shooting mode

## Cont. Priority AE

---

By fixing the aperture value when shooting the first image, you can shoot images continuously at high speed.

1. Set the mode dial to  (Cont. Priority AE).
2. Adjust the focus and shoot the image.
  - The camera continues to record images as long as you hold the shutter button fully pressed.
  - The camera records images continuously at a maximum of about 12 images per second.

#### Hint

- If the focus mode dial is set to "C" (Continuous AF), the camera locks the focus and exposure while shooting. ISO can be set to a desired setting.
- If the focus mode dial is set to "MF" (Manual Focus), or "S" (Single-shot AF), the focus is locked to the first image.

#### Note

- When set to [Auto HDR], the process will temporarily be based on the DRO settings.
- The speed of continuous shooting is estimated using Sony's criteria. The speed of continuous shooting may be slower, depending on the shooting conditions.

---

[41] How to Use | Shooting | Selecting a shooting mode

# Shutter Priority

---

You can express the movement of a moving subject in various ways by adjusting the shutter speed, for example, at the instant of the movement with high speed shutter, or as a trailing image with low speed shutter. The shutter speed can be changed while recording movies.

1. Set the mode dial to S (Shutter Priority).
2. Select the desired value by turning the front dial.
3. Adjust the focus and shoot the subject.  
The aperture is automatically adjusted to obtain proper exposure.

## Note

- If proper exposure cannot be obtained after setup, the aperture value on the shooting screen blinks. Although you can shoot as it is, resetting is recommended.
- Use a tripod to prevent blurring when you use a slow shutter speed.
- The  (SteadyShot warning) indicator does not appear in shutter speed priority mode.
- When the shutter speed is 1 second(s) or longer, noise reduction will be done after shooting for the same amount of time that the shutter was open. However, you cannot shoot any more while noise reduction is in progress.
- The brightness of the image on the monitor may differ from the actual image being shot.

## Hint

- When a faster shutter speed is used, moving subjects, such as a running person, cars, or sea spray come out as if they are frozen in their movements. When a slower shutter speed is used, a trailing image of the movement of the subject is captured to create a more natural and dynamic image.

---

[42] How to Use | Shooting | Selecting a shooting mode

# Aperture Priority

---

You can shoot by adjusting the aperture and changing the range in focus, or by defocusing the background. The aperture value can be changed while recording movies.

1. Set the mode dial to A (Aperture Priority).
2. Select the desired value by turning the front dial.

- Smaller F-value: The subject is in focus, but objects in front of and beyond the subject are blurred.  
Larger F-value: The subject and its foreground and background are all in focus.

### 3. Adjust the focus and shoot the subject.

The shutter speed is automatically adjusted to obtain proper exposure.

#### Note

- If proper exposure cannot be obtained after setup, the shutter speed on the shooting screen blinks. Although you can shoot as it is, resetting is recommended.
- The brightness of the image on the screen may differ from the actual image being shot.

#### Hint

- Smaller F-value (opening the aperture) narrows the range that is in focus. This allows you to put the subject in sharp focus and blur objects in front of and beyond the subject (depth of field becomes shallower). Larger F-value (narrowing down the aperture) widens the range that is in focus. This allows you to shoot the depth of the scenery (depth of field becomes deeper).

---

[43] How to Use | Shooting | Selecting a shooting mode

## Manual Exposure

---

You can shoot with the desired exposure setting by adjusting both the shutter speed and aperture. The shutter speed and the aperture value can be changed while recording movies.

1. Set the mode dial to M (Manual Exposure).
2. Select the desired aperture value by turning the front dial.  
Select the desired shutter speed by turning the rear dial.  
When [ISO] is set to other than [ISO AUTO], use MM (Metered Manual) to check the exposure value.  
**Toward +:** Images become brighter.  
**Toward - :** Images become darker.  
**0:** Appropriate exposure analyzed by the product
3. Adjust the focus and shoot the subject.

#### Note

- When [ISO] is set to [ISO AUTO], the ISO value automatically changes to achieve the

appropriate exposure using the aperture value and shutter speed you have set. If the aperture value and shutter speed you have set are not suitable for appropriate exposure, the ISO value indicator will blink.

- The Metered Manual indicator does not appear when [ISO] is set to [ISO AUTO].
- When the amount of ambient light exceeds the metering range of the Metered Manual, the Metered Manual indicator flashes.
- The  (SteadyShot warning) indicator does not appear in manual exposure mode.
- The brightness of the image on the monitor may differ from the actual image being shot.

#### Hint

- You can change the shutter speed and aperture (F-value) combination without changing the set exposure value by rotating the front/rear dial while pressing the AEL button.  
(Manual shift)

---

[44] How to Use | Shooting | Selecting a shooting mode

## BULB

---

You can shoot a trailing image of the movement of a subject with long exposure.

BULB is suitable for shooting trails of light, such as fireworks.

1. Set the mode dial to M (Manual Exposure).
2. Turn the rear dial clockwise until [BULB] is indicated.
3. Select the aperture value (F value) using the front dial.
4. Press the shutter button halfway down to adjust the focus.
5. Press and hold the shutter button for the duration of the shooting.  
As long as the shutter button is pressed, the shutter remains open.

#### Note

- Since the shutter speed becomes slow and the camera-shake tends to occur more easily, it is recommended that you use a tripod.
- The longer the exposure time, the more noise will be visible on the image.
- After shooting, noise reduction will be done for the same amount of time that the shutter was open. However, you cannot shoot any more while noise reduction is in progress.
- You cannot set the shutter speed to [BULB] in the following situations:
  - [Cont. Priority AE]
  - When the [Smile Shutter] function is activated.
  - When the [Auto HDR] function is activated.

- When [Picture Effect] is set to [HDR Painting] or [Rich-tone Mono.].
- When the [Multi Frame NR] function is activated.
- When the [Drive Mode] function is set to [Cont. Shooting], [Cont. Bracket], [Self-timer(Cont)].

If you use the above functions when the shutter speed is set to [BULB], the shutter speed is temporarily set to 30 seconds.

#### Hint

- Images shot in [BULB] mode tend to be blurry. We recommend that you use a tripod or a remote commander (sold separately) that has a shutter button lock function.

---

[45] How to Use | Shooting | Selecting a shooting mode

## Memory recall

---

Allows you to shoot an image after recalling often-used modes or camera settings registered in advance.

1. Set the mode dial to 1, 2 or 3 (Memory recall).
2. Press  on the center of the multi-selector.

#### Note

- Register shooting settings in advance by [Memory].
- If you set [Memory recall] after completing the shooting settings, the registered settings are given priority and the original settings may become invalid. Check the indicators on the screen before shooting.



---

[46] How to Use | Shooting | Selecting a shooting mode

## Movie

---

You can adjust the shutter speed or aperture value to your desired settings for recording movies. You can also check the image angle before shooting.

1. Set the mode dial to  (Movie).
2. MENU →  (Camera Settings) → [Movie] → desired setting.
  - When [Mode Dial Guide] is set to [On], you can select the desired settings after you



have changed the position of the mode dial.

3. Press the MOVIE button to start recording.
  - Press the MOVIE button again to stop recording.

## Menu item details

### **Program Auto:**

Allows you to shoot with the exposure (both the shutter speed and the aperture value) adjusted automatically. Other settings can be adjusted manually and the settings are retained.

### **Aperture Priority:**



Allows you to shoot after adjusting the aperture value manually.

### **Shutter Priority:**

Allows you to shoot after adjusting the shutter speed manually.

### **Manual Exposure:**

Allows you to shoot after adjusting the exposure (both the shutter speed and the aperture value) manually.

-  (Aperture Priority),  (Shutter Priority) and  (Manual Exposure) are available only when the focus mode is set to "MF" (Manual Focus).

---

[47] How to Use | Using shooting functions | Using the zoom

## Zoom

---

When a zoom lens is mounted, you can enlarge images by turning the zoom ring of the lens.

1. Turn the zoom ring of the zoom lens to enlarge subjects.

## About other [Zoom] functions than the optical zoom

When you set [Zoom Setting] to something other than [Optical zoom only], you can use other zoom functions than the optical zoom.

MENU →  (Camera Settings) → [Zoom] → desired value.

---

[48] How to Use | Using shooting functions | Using the zoom

## The zoom features available with this product

---

The zoom feature of the product provides a higher magnification zoom by combining various zoom features. The icon displayed on the screen changes, according to the selected zoom feature.

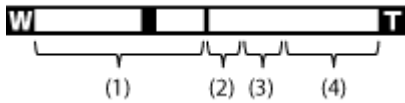

### (1) Optical zoom range

Zoom images in the zoom range of a lens.

### (2) Smart Zoom range ( )

Zoom images without causing the original quality to deteriorate by partially cropping an image (only when the image size is [M] or [S]).





### (3) Clear Image Zoom range ( )

Zoom images using an image process with less deterioration. Set [Zoom Setting] to [On:ClearImage Zoom] or [On:Digital Zoom] first.

### (4) Digital Zoom range ( )

You can magnify images using an image process. When you select [On:Digital Zoom] for [Zoom Setting], you can use this zoom function.

#### Note

- The default setting for the [Zoom Setting] is [Optical zoom only].
- The default setting for [  Image Size] is [L]. To use the smart zoom change [  Image Size] to [M] or [S].
- Zoom functions other than the optical zoom are not available when shooting in the following situations:
  - [Sweep Panorama]
  - [  Quality] is set to [RAW] or [RAW & JPEG]
- You cannot use the Smart Zoom function with movies.
- When you use a zoom function other than the optical zoom, [Metering Mode] is fixed to [Multi].
- When you use another zoom function than the optical zoom, [  Auto Obj. Framing] is not available.
- To use another zoom function than the optical zoom for movies, assign [Zoom] to the desired button using [Custom Key Settings].

---

[49] How to Use | Using shooting functions | Using the zoom

## Zoom Setting

---

You can select the zoom setting of the product.

1. MENU →  (Custom Settings) → [Zoom Setting] → desired setting.

## Menu item details

### Optical zoom only (default setting):

Optical zoom is activated. You can use the Smart Zoom function if you set [ Image Size] to [M] or [S].

### On:ClearImage Zoom:

Even if the zoom range of the optical zoom is exceeded, the product magnifies images within the range in which image quality does not deteriorate significantly.

### On:Digital Zoom:

When the zoom range of the [ Clear Image Zoom] is exceeded, the product magnifies images to the largest scale. However, the image quality will deteriorate.

### Note

- Set [Optical zoom only] if you want to magnify images within the range in which image quality does not deteriorate.

---

[50] How to Use | Using shooting functions | Using the zoom

## About zoom scale

---

The zoom scale that is used in combination with the zoom of the lens changes according to the selected image size.

### When [ Aspect Ratio] is [3:2]

#### [Zoom Setting] : [Optical zoom only (including smart zoom) ]

[ Image Size] : L -x, M 1.4x, S 2x

#### [Zoom Setting] : [On:ClearImage Zoom]

[ Image Size] : L 2x, M 2.8x, S 4x

#### [Zoom Setting] : [On:Digital Zoom]

[ Image Size] : L 4x, M 5.7x, S 8x

---

[51] How to Use | Using shooting functions | Using the zoom

## Smart Telecon.

---

Smart Teleconverter magnifies and trims the center of the image, then records it.

1. Press the  (Smart Telecon.) button.

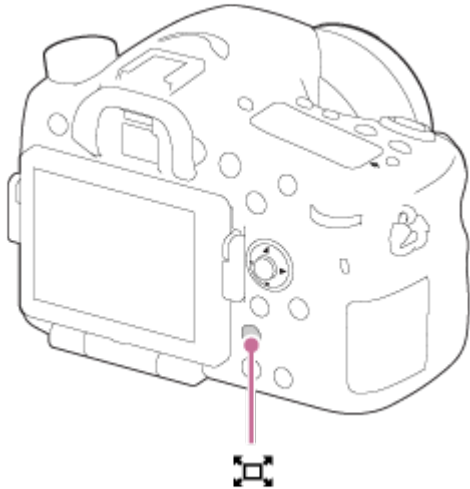

The settings change each time you press the key.

---

[52] How to Use | Using shooting functions | Using the flash

## Using flash

---

In dark environments, use the flash to light up the subject while shooting and to prevent camera-shake. When shooting against the sun, use the flash to lighten the image of the backlit subject.

1. Press the  (Flash pop-up) button to pop up the flash.
  - The flash automatically pops up when [Flash Mode] is set to [Autoflash].

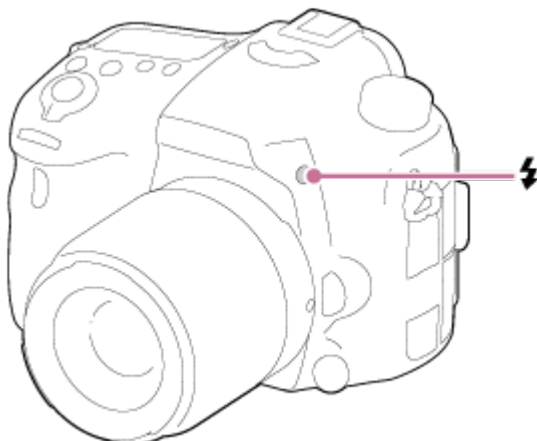

2. Press the shutter button fully down.

## When you do not use the flash

When not using the flash, press it back into the camera body.

### Note

- If you fire the flash before the flash unit pops up entirely, it may cause malfunction.
- You cannot use the flash when recording movies.
- While charging the flash,  flashes. After charging is completed, the flashing icon will light up.
- When an external flash (sold separately) is attached to the Multi Interface Shoe, the state of the external flash has priority over the setting of the product. You cannot use the product's internal flash.
- Before attaching/removing an accessory such as a flash to/from the Multi Interface Shoe, turn off the product first.  
When attaching an accessory, insert it fully to the Multi Interface Shoe and screw tightly. Also, make sure that the accessory is fixed securely to the product.
- Do not use a commercially available flash with high-voltage synchro terminals or with reverse polarity.
- The light of the flash may be blocked by the lens attached.
- The corners of a recorded image may be shaded, depending on the lens.

---

[53] How to Use | Using shooting functions | Using the flash

## Flash Mode

---

You can set the flash mode.

1. MENU →  (Camera Settings) → [Flash Mode] → desired setting.

### Menu item details

#### **Flash Off:**

The flash does not operate.

#### **Autoflash:**

The flash works in dark environments or when shooting towards bright light.

#### **Fill-flash:**

The flash works every time you trigger the shutter.

#### **Slow Sync.:**

The flash works every time you trigger the shutter. Slow sync shooting allows you to shoot a clear image of both the subject and the background by slowing the shutter speed.

## **Rear Sync.:**

The flash works right before the exposure is completed every time you trigger the shutter. Rear sync shooting allows you to shoot a natural image of the trail of a moving subject such as a moving car or a walking person.

## **Wireless:**

Allows you to shoot by removing the remote control-compatible external flash (sold separately) and using it at a distance from the camera. The shading effect gives the subject a more three-dimensional feel.

## **High speed synchronization:**

High speed synchronization function (HSS) can be used only when an HSS-capable external flash (sold separately) is attached to the product. An HSS flash operates by sending multiple small bursts of light at high speed to simulate the effect of one long burst of flash so that you can shoot images with flash at all shutter speeds.

\* High speed synchronization function (HSS) is also available during wireless flash shooting.

### **Note**

- The default setting depends on the shooting mode.
- Available flash mode depends on the shooting mode.

---

[54] How to Use | Using shooting functions | Using the flash

## Flash Comp.

---

Adjusts the amount of flash light in a range of  $-3.0$  EV to  $+3.0$  EV.

Flash compensation changes the amount of flash light only. Exposure compensation changes the amount of flash light along with the change of the shutter speed and aperture.

1. MENU →  (Camera Settings) → [Flash Comp.] → desired setting.  
Selecting higher values (+ side) makes the flash level higher, and lower values (– side) makes the flash level lower.

### **Note**



- The higher flash effect may not be visible due to the limited amount of flash light available, if the subject is outside the maximum range of the flash. If the subject is very close, the lower flash effect may not be visible.

## FEL Lock

---

The flash level is automatically adjusted so that the subject gets the optimum exposure during normal flash shooting. You can also set the flash exposure in advance.

FEL: Flash Exposure Level

1. Center the subject on which FEL is to be locked, and adjust the focus.
2. Press the button to which [FEL Lock toggle] is registered, and set the flash amount.
  - A pre-flash flashes.
  -  (FEL lock) flashes.
  - Select MENU →  (Custom Settings) → [Custom Key Settings] → desired button → [FEL Lock toggle] to register the function in advance.
3. Adjust the composition and shoot the image.
  - When you want to release the FEL lock, press the button to which [FEL Lock toggle] is registered again.

### Flashes that support FEL lock

- HVL-F60M and HVL-F43M can be used as clip-ons, off-camera connected by a cable, and for wireless flash shooting (controller/remote).
- HVL-F20M can be used as a clip-on, off-camera connected with a cable, and for wireless flash shooting (controller).

#### Note

- The FEL lock cannot be set when a flash is not attached.
- If a flash that does not support the FEL lock is attached, an error message is displayed.
- When both AE and FEL lock are fixed,  flashes.

#### Hint

- By setting [FEL Lock hold], you can hold the setting while the button is pressed down. Also, by setting [FEL Lock/AEL hold] and [FEL Lock/AEL toggle], you can shoot images with the AE locked in the following situations.
  - When [Flash Mode] is set to [Flash Off] or [Autoflash].
  - When the flash cannot go off.
  - When using an external flash that is set to manual flash mode.

# Flash control

---

Sets the method for determining the intensity of flash output.

1. MENU →  (Camera Settings) → [Flash control] → desired setting.

## Menu item details

### ADI flash (default setting):

The camera's flash control uses the focus distance information and brightness value of the subject when the pre-flash is reflected. This gives precise flash control without hardly being affected by the reflective level of the subject.

### Pre-flash TTL:

The camera's flash control uses the brightness value of the subject when the pre-flash is reflected. If this setting is used, the camera's ability to precisely measure the flash light may be affected by reflections from the subject.

### Manual flash:

Allows you to set the flash amount using [Power ratio], and the built-in flash fires with set amount of flash light regardless of the brightness of a subject.

ADI: Advanced Distance Integration

TTL: Through the Lens

### Hint

- If you use the lens that is equipped with a distance encoder in [ADI flash] mode, the product achieves accurate flash control based on the more precise distance information.

### Note

- When the distance between the subject and flash is not fixed (such as when shooting with wireless flash using an external flash (sold separately) or in off-camera shooting using a cable, or when using a macro twin flash), or when an external flash (sold separately) is set to bounce, [Flash control] is automatically set to [Pre-flash TTL]. It may be automatically set to [Pre-flash TTL] depending on other shooting conditions as well.
- Set [Flash control] to [Pre-flash TTL] in the following situations because the product cannot get proper flash information using [ADI flash].
  - When a wide panel is attached to the flash HVL-F36AM
  - When shooting using a flash diffuser
  - When using filters that affect the exposure factor (such as ND filters)
  - When using close-up lenses
- ADI flash can be used in combination with a lens distance encoder. To confirm if your lens is equipped with a distance encoder, check the main specifications of the operation manual for your lens.
- [Flash control] cannot be set in [Sweep Panorama] mode, or when [Night Scene] or



[Hand-held Twilight] is selected in [Scene Selection].

---

[57] How to Use | Using shooting functions | Using the flash

## Power ratio

---

If you set [Flash control] to [Manual flash], you can adjust the amount of flash manually.

1. MENU →  (Camera Settings) → [Power ratio] → desired setting.

### **MENU item details**

**1/1 (default value) / 1/2 / 1/4 / 1/8 / 1/16**

---

[58] How to Use | Using shooting functions | Selecting a screen display mode

## Switching the screen display (Shooting)

---

You can change the display contents on the screen.

1. Press the DISP (Display Setting) button.

Each time you press the DISP button, the recording information display changes as follows:

Graphic Display → Display All Info. → No Disp. Info. → Histogram → Level → For viewfinder\* → Graphic Display

Graphic Display

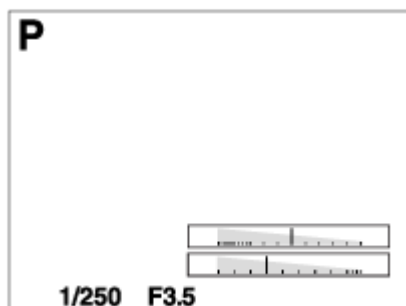

Display All Info.

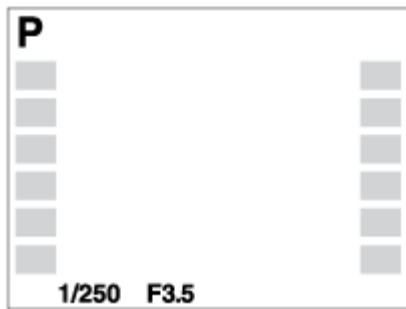

No Disp. Info.



Histogram

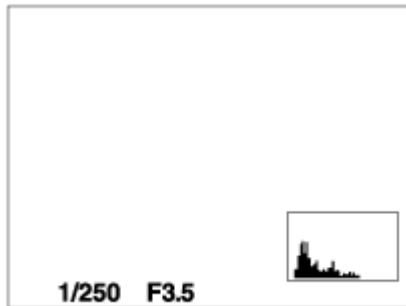

Level

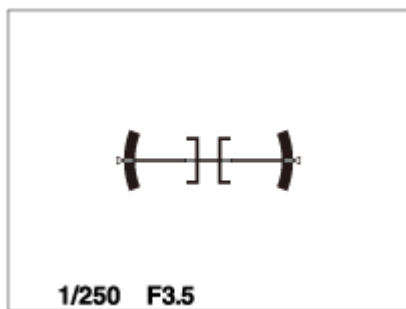

For viewfinder\*

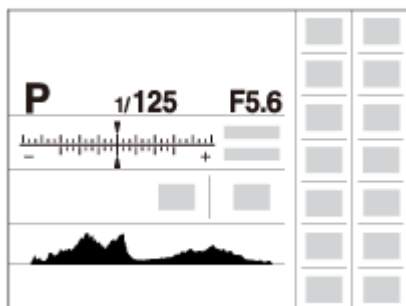

\* [For viewfinder] is displayed only on the screen.

Some display modes are not available in the default settings.

To change the display modes, press MENU →  (Custom Settings) → [DISP Button] and change the setting.

#### Note

- Histogram is not displayed during panorama shooting.
- In movie mode, [For viewfinder] cannot be displayed.

#### Hint

- You can select different settings for both the viewfinder and the monitor. Look through the viewfinder to set the display settings for the viewfinder.

---

[59] How to Use | Using shooting functions | Selecting a screen display mode

## DISP Button (Finder)

---

Allows you to set the screen display modes that can be selected for the viewfinder using **DISP** (Display Setting) in shooting mode.

1. MENU →  (Custom Settings) → [DISP Button] → [Finder] → desired setting → [Enter].

The items marked with  are available.

### Menu item details

#### Graphic Display:

Shows basic shooting information. Graphically shows the shutter speed and aperture value.

#### Display All Info.:

Shows recording information.

#### No Disp. Info.:

Does not show recording information.

#### Histogram:

Displays the luminance distribution graphically.

#### Level:

Indicates whether the product is level in both the horizontal and front-back directions. When the product is level in both directions, the indicator turns to green.

---

[60] How to Use | Using shooting functions | Selecting a screen display mode

# DISP Button (Monitor)

---

Allows you to set the screen display modes that can be selected for the monitor using **DISP** (Display Setting) in shooting mode.

1. MENU →  (Custom Settings) → [DISP Button] → [Monitor] → desired setting → [Enter].

The items marked with  are available.

## Menu item details

### Graphic Display:

Shows basic shooting information. Graphically shows the shutter speed and aperture value.

### Display All Info.:

Shows recording information.

### No Disp. Info.:

Does not show recording information.

### Histogram:

Displays the luminance distribution graphically.

### Level:

Indicates whether the product is level in both the horizontal and front-back directions. When the product is level in both directions, the indicator turns to green.

### For viewfinder:

Displays information suited for shooting with the viewfinder.



---

[61] How to Use | Using shooting functions | Selecting still image size/image quality

## Image Size (still image)

---

The larger the image size, the more detail will be reproduced when the image is printed on large-format paper. The smaller the image size, the more images can be recorded.

1. MENU →  (Camera Settings) → [ Image Size] → desired setting.

## Menu item details

### Image size when [ Aspect Ratio] is 3:2

L: 24M 6000×4000 pixels

M: 12M 4240×2832 pixels

S: 6.0M 3008×2000 pixels

### Image size when [ Aspect Ratio] is 16:9

L: 20M 6000×3376 pixels

M: 10M 4240×2400 pixels

S: 5.1M 3008×1688 pixels

#### Note

- When [ Quality] is set to [RAW] or [RAW & JPEG], the image size for RAW images corresponds to [L].



---

[62] How to Use | Using shooting functions | Selecting still image size/image quality

## Aspect Ratio (still image)

---

Sets the aspect ratio of still images.

1. MENU →  (Camera Settings) → [ Aspect Ratio] → desired setting.

### Menu item details

#### 3:2 (default setting):

Suitable for standard prints.

#### 16:9:

For viewing on a high-definition TV.



---

[63] How to Use | Using shooting functions | Selecting still image size/image quality

## Quality (still image)

---

Selects the compression format of still images.

1. MENU →  (Camera Settings) → [ Quality] → desired setting.

### Menu item details

#### RAW:

File format: RAW (Records using the RAW compression format.)

Digital processing is not performed on this file format. Select this format to process images on a computer for professional purposes.

- The image size is fixed to the maximum size. The image size is not displayed on the screen.

### **RAW & JPEG:**

File format: RAW (Records using the RAW compression format.) + JPEG

A RAW image and a JPEG image are created at the same time. This is suitable when you need 2 image files, a JPEG for viewing, and a RAW for editing.

The JPEG image quality is set to [Fine].

### **Extra fine:**

File format: JPEG

The image is compressed in the JPEG format and recorded using a higher quality than with [Fine].

### **Fine (default setting):**

File format: JPEG

The image is compressed in the JPEG format when recorded.

### **Standard:**

File format: JPEG

The image is compressed in the JPEG format when recorded. Since the compression rate of [Standard] is higher than that of [Fine], the file size of [Standard] is smaller than that of [Fine]. This will allow more files to be recorded on 1 memory card, but the image quality will be lower.

### **Note**

- If images are not to be modified using your computer, we recommend that you record images in JPEG format.
- You cannot add DPOF (print order) registration to RAW format images.

---

[64] How to Use | Using shooting functions | Selecting still image size/image quality

## Panorama: Size

---

Sets the image size when shooting panoramic images. The image size varies depending on the [Panorama: Direction] setting.

1. MENU →  (Camera Settings) → [Panorama: Size] → desired setting.

### **Menu item details**

When [Panorama: Direction] is [Up] or [Down]

**Standard:** 3872x2160

**Wide:** 5536x2160

When [Panorama: Direction] is [Left] or [Right]

**Standard:** 8192x1856

**Wide:** 12416x1856

---

[65] How to Use | Using shooting functions | Selecting still image size/image quality

## Panorama: Direction

---

Sets the direction to pan the camera when shooting panoramic images.

1. MENU →  (Camera Settings) → [Panorama: Direction] → desired setting.

### Menu item details

#### **Right (default setting):**

Pan the camera from the left to the right.

#### **Left:**

Pan the camera from the right to the left.

#### **Up:**

Pan the camera from the bottom to the top.

#### **Down:**

Pan the camera from the top to the bottom.

---

[66] How to Use | Using shooting functions | Adjusting the focus

## Changing the focus method using the focus mode dial

---

You can select the focusing method to suit the movement of the subject.

1. Turn the focus mode dial **(A)** to select the desired focus method.

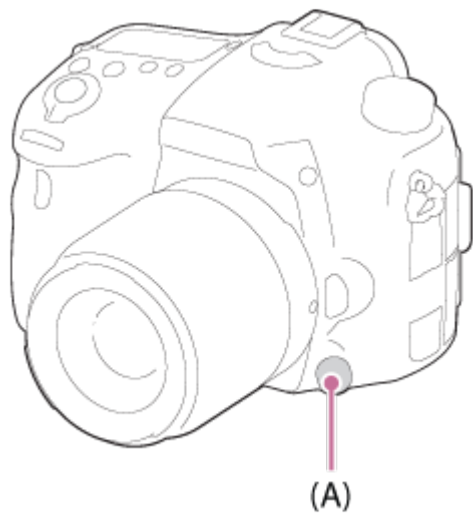

## Focus mode details

### **S (Single-shot AF):**

The camera focuses and the focus is locked when you press the shutter button halfway down. Use this mode when the subject is motionless.

### **A (Automatic AF) (default setting):**

The camera switches between [Single-shot AF] and [Continuous AF] depending on the movement of the subject.

### **C (Continuous AF):**

The camera continues to focus while the shutter button is pressed and held halfway down. Use this mode when the subject is in motion.

### **MF (Manual Focus):**

Adjusts the focus manually.

#### **Note**

- If the subject is too close, the image may show any dust or fingerprints on the lens. Wipe the lens with a soft cloth, etc.
- Once you change the focus method, the set focus distance is erased.
- When [Focus Mode] is set to [Continuous AF], the beep does not sound when focus is achieved.

#### **Hint**

- If you cannot achieve focus for the intended subject using auto focus, select MF or DMF, then shoot again.

You can select DMF using MENU →  (Camera Settings) → [AF-A setup] → [DMF].



Selects the focusing area. Use this function when it is difficult to get the proper focus in auto focus mode.

1. MENU →  (Camera Settings) → [Focus Area] → desired setting.

## Menu item details

### **Wide:**

Focuses automatically on a subject in all ranges of the image.

When you press the shutter button halfway down in still image shooting mode, a green frame is displayed around the area that is in focus.

### **Zone:**

Select a zone on the monitor on which to focus. A zone consists of nine focus areas, and the product automatically selects a focus area on which to focus.

### **Center:**

Focuses automatically on a subject in the center of the image. When used together with the AF lock function, you can compose the image you want.

### **Flexible Spot:**

Allows you to move the AF range frame to the desired point on the screen and focus on an extremely small subject in a narrow area.

### **Expand Flexible Spot:**

If the product fails to focus on the single selected point, it uses the eight focus points around the flexible spot as the second priority area to achieve focus.

### **Lock-on AF:**

When the shutter button is pressed and held halfway down, the product tracks the subject within the selected autofocus area. Point the cursor to [Lock-on AF] on the [Focus Area] setting screen, then select the desired tracking start area using the left/right sides of the multi-selector. You can move the tracking start area to the desired point by designating the area to be the flexible spot.



---

[68] How to Use | Using shooting functions | Adjusting the focus

## Center Lock-on AF

---

When you press the center button, the camera detects the subject positioned in the center of the screen and continues to track the subject.

1. MENU →  (Camera Settings) → [Center Lock-on AF] → [On]
2. Align the target frame (A) over the subject and press  in the center of the multi-selector.  
Press  again to stop tracking.

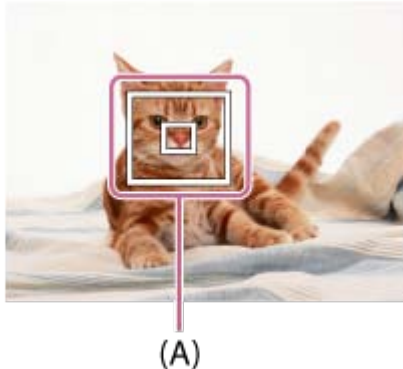

3. Press the shutter button fully down to shoot the image.

#### Note

- [Center Lock-on AF] may not function very well in the following situations:
  - The subject is moving too quickly.
  - The subject is too small, or too large.
  - The contrast between the subject and the background is poor.
  - It is dark.
  - The ambient light changes.
- Lock-on AF does not work in the following situations:
  - In [Sweep Panorama] mode
  - When [Scene Selection] is set to [Hand-held Twilight]
  - When using [Smart Telecon.]
  - When shooting in Manual Focus mode
- When the subject to be tracked disappears from the screen, Lock-on AF is released.
- When [Center Lock-on AF] is set to [On], the camera may not be able to resume tracking for a while after it loses the track of the subject.

---

[69] How to Use | Using shooting functions | Adjusting the focus

## AF Area Auto Clear

---

Sets whether the focus area should be displayed all the time or should disappear automatically shortly after focus is achieved.

1. MENU →  (Custom Settings) → [AF Area Auto Clear] → desired setting.

## Menu item details

### On:

The focus area is displayed all the time.

### Off (default setting):

The focus area disappears automatically shortly after focus is achieved.

---

[70] How to Use | Using shooting functions | Adjusting the focus

## AF Area Points

---

Allows you to limit the focus area points used. You can lock the [AF Area Points] manually to prevent the points from being shifted automatically depending on the attached lens or when it is difficult to focus with the surrounding focus area.

1. MENU →  (Custom Settings) → [AF Area Points] → desired setting.

## Menu item details

### Auto (default setting):

The focus area points are set automatically by the camera.

### 61 Points:

The focus area points are set manually to 61 points.

---

[71] How to Use | Using shooting functions | Adjusting the focus

## Flexible Spot Points

---

Sets whether to use all of the AF Area Points or only the limited 15 points.

1. MENU →  (Custom Settings) → [Flexible Spot Points] → desired setting.

## Menu item details

### All (default setting):

All the AF Area Points are used.

## 15 Points:

Only the limited 15 points are used.

---

[72] How to Use | Using shooting functions | Adjusting the focus

## Wide AF Area Disp.

---

Sets whether to display the focus area or not when [Focus Area] is set to [Wide].

1. MENU →  (Custom Settings) → [Wide AF Area Disp.] → desired setting.

### Menu item details

#### On (default setting):

The focus area is displayed.

#### Off:

The focus area is not displayed.

---

[73] How to Use | Using shooting functions | Adjusting the focus

## Focus-lock

---

Shoots images with the focus locked on the desired subject in auto focus mode.

1. Set the focus mode dial to S (Single-shot AF).
  2. Place the subject within the AF area and press the shutter button halfway down.  
The focus is locked.
  3. Keep pressing the shutter button halfway down, and place the subject back in the original position to re-compose the shot.
  4. Press the shutter button down fully to take the picture.
- 

[74] How to Use | Using shooting functions | Adjusting the focus

# Manual Focus

---

When it is difficult to get the proper focus in autofocus mode, you can adjust the focus manually.

1. Set the focus mode switch of the lens to MF. If the lens does not have a focus mode switch, set the focus mode dial of the camera to MF.
2. Rotate the focus ring to achieve sharp focus.

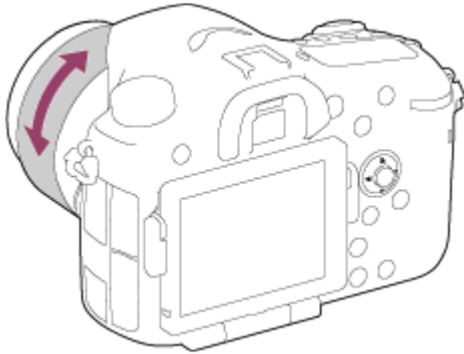

3. Press the shutter button fully down to take the picture.

---

[75] How to Use | Using shooting functions | Adjusting the focus

## Direct manual focus (DMF)

---

You can make fine adjustments manually after the focus is locked.

You can quickly focus on a subject rather than using the manual focus from the beginning. This is convenient in cases such as macro shooting.

1. MENU →  (Camera Settings) → [AF-A setup] → [DMF].
2. Set the focus mode dial to A. Press the shutter button halfway down to focus automatically.
3. Keep the shutter button halfway down, rotate the focusing ring to achieve a sharper focus.

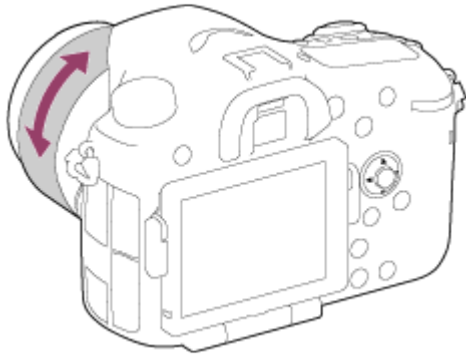

4. Press the shutter button fully down to shoot an image.



---

[76] How to Use | Using shooting functions | Adjusting the focus



## Focus Magnifier

---

You can check the focus by enlarging the image before shooting.

1. MENU →  (Camera Settings) → [Focus Magnifier].
2. Press  on the center of the multi-selector to enlarge the image and select the position you want to enlarge using up/down/left/right side of the multi-selector.
3. Confirm the focus.
4. Press the shutter button fully down to shoot the image.

### Hint

- Each time you press  in the center, the magnifier scaling changes.
- When focusing manually, you can adjust the focus while an image is magnified.
- The [Focus Magnifier] function will be released when the shutter button is pressed halfway.
- You can record images while an image is enlarged, but the product records a full-display image.
- The [Focus Magnifier] function will be released after shooting.
- You can set how long the image is to be shown magnified by selecting MENU →  (Custom Settings) → [Focus Magnif. Time].

---

[77] How to Use | Using shooting functions | Adjusting the focus

# Focus Magnif. Time

---

Set the duration for which an image is to be magnified using the [Focus Magnifier] function.

1. MENU →  (Custom Settings) → [Focus Magnif. Time] → desired setting.

## Menu item details

### **2 Sec:**

Magnifies the images for 2 seconds.

### **5 Sec:**

Magnifies the images for 5 seconds.

### **No Limit (default setting):**

Magnifies the images until you press the shutter button.

---

[78] How to Use | Using shooting functions | Adjusting the focus

# Peaking Level

---

Enhances the outline of in-focus ranges using a specific color in Manual Focus or Direct Manual Focus shooting. This function allows you to confirm the focus easily.

1. MENU →  (Custom Settings) → [Peaking Level] → desired setting.

## Menu item details

### **High:**

Sets the peaking level to high.

### **Mid:**

Sets the peaking level to middle.

### **Low:**

Sets the peaking level to low.

### **Off (default setting):**

Does not use the peaking function.

### **Note**

- Since the product determines that sharp areas are in focus, the effect of peaking differs,

depending on the subject and shooting conditions.

- The outline of in-focus ranges is not enhanced when the product is connected using an HDMI cable.

---

[79] How to Use | Using shooting functions | Adjusting the focus

## Peaking Color

---

Sets the color used for the peaking function in Manual Focus or Direct Manual Focus shooting.

1. MENU →  (Custom Settings) → [Peaking Color] → desired setting.

### Menu item details

**Red:**

Enhances outlines in red.

**Yellow:**

Enhances outlines in yellow.

**White (default setting):**

Enhances outlines in white.



---

[80] How to Use | Using shooting functions | Adjusting the focus

## Eye-Start AF (still image)

---

Sets whether or not to use autofocus when you look through an Electronic Viewfinder.

1. MENU →  (Custom Settings) → [ Eye-Start AF] → desired setting.

### Menu item details

**On:**

Auto focusing starts when you look through the Electronic Viewfinder.

**Off (default setting):**

Auto focusing does not start when you look through the Electronic Viewfinder.



## AF/MF control

---

You can easily switch the focusing mode from auto to manual and vice versa while shooting without changing your holding position.

1. Press the AF/MF button.



### **During auto focus:**

Temporarily switches the focusing mode to manual. Adjust the focus while the AF/MF button is being held down.

### **During manual focus:**

Temporarily switches the focusing mode to auto while the AF/MF button is held down, and locks the focus.



### **Hint**

- If you select [AF/MF Ctrl Toggle] in [AF/MF Button] under [Custom Key Settings], the focusing mode remains switched even if you remove your finger from the button.

## AF Illuminator (still image)

---

The AF illuminator supplies fill light to focus more easily on a subject in dark surroundings. In the time between pressing the shutter button halfway down and locking the focus, the flash is raised and released to allow the camera to focus more easily.

1. MENU →  (Camera Settings) → [ AF Illuminator] → desired setting.

### **Menu item details**

#### **Auto (default setting):**

Uses the AF illuminator.

**Off:**

Does not use the AF illuminator.

**Note**

- You cannot use [ AF Illuminator] in the following situations:
  - In movie mode
  - In [Sweep Panorama] mode
  - When [Focus Mode] is set to [Continuous AF].
  - When [Scene Selection] is set to [Landscape], [Sports Action] or [Night Scene].
- When [Focus Area] is set to [Wide] or [Zone], the AF range finder frame is indicated by a dotted line.
- The AF illuminator emits a very bright light. Although there is no health hazard, do not look directly into the AF illuminator at close range.

---

[83] How to Use | Using shooting functions | Adjusting the focus

## AF Micro Adj.

---

Allows you to adjust and register an autofocused position for each lens.

1. Select MENU →  (Custom Settings) → [AF Micro Adj.].
2. Select [AF Adjustment Set.] → [On].
3. [amount] → desired value.
  - You can select a value between -20 and +20. Selecting a positive value shifts the autofocused position away from the product. Selecting a negative value shifts the autofocused position closer to the product.

**Note**

- It is recommended that you adjust the position under actual shooting conditions.
- When you attach a lens for which you have already registered a value, the registered value appears on the screen. [±0] appears for lenses for which a value has not yet been registered.
- If [-] is displayed as the value, then a total of 30 lenses have been registered and no new lens can be registered. To register a new lens, attach a lens for which the registration can be erased, and set its value to [±0], or reset the values of all the lenses using [Clear].
- If you perform [AF Micro Adj.] with lenses other than Sony, Minolta, or Konica-Minolta lenses, the registered settings for Sony, Minolta, or Konica-Minolta lenses may be affected. Do not perform [AF Micro Adj.] with an unsupported lens.

- You cannot set [AF Micro Adj.] individually for a Sony, Minolta, and Konica-Minolta lens of the same specification.



---

[84] How to Use | Using shooting functions | Adjusting the focus

## AF w/ shutter (still image)

---

Selects whether to focus automatically when you press the shutter button halfway down. Select [Off] to adjust the focus and the exposure separately.

1. MENU →  (Custom Settings) → [ AF w/ shutter] → desired setting.

### Menu item details

#### On (default setting):

The auto focus operates when you press the shutter button halfway down.

#### Off:

The auto focus does not operate even if you press the shutter button halfway down.

#### Hint

- When [ AF w/ shutter] is set to [Off], you can still use the [AF On] function.

---

[85] How to Use | Using shooting functions | Adjusting the focus

## AF On

---

You can focus using any button instead of pressing the shutter button halfway down. The settings for the focus mode dial will be applied.

1. Select the desired key and assign the [AF On] function to it using MENU →  (Custom Settings) → [Custom Key Settings].
2. Press the key to which you have assigned the [AF On] function while auto-focus shooting.

## Eye AF

---

The camera focuses on the subject's eyes while you keep the button pressed.

1. MENU →  (Custom Settings) → [Custom Key Settings] → assign the [Eye AF] function to the desired button.
2. Point the camera at a person's face, and press the button to which you have assigned the [Eye AF] function.
3. Press the shutter button while pressing the button.

### Note

- The camera may not be able to focus on the eyes depending on the circumstances, such as when no eyes can be detected within the auto focus area. In such cases, the camera detects a face and focuses on the face.
- If the camera cannot detect a person's face, you cannot use [Eye AF].
- Depending on the circumstances, you cannot use [Eye AF], such as when the focus mode is set to C (Continuous AF) or MF (Manual Focus), etc.
- [Eye AF] may not function in the following situations:
  - When the person is wearing sunglasses.
  - When the front hair covers the person's eyes.
  - In low-light or back-lit conditions.
  - When the eyes are closed.
  - When the person is in the shade.
  - When the person is out of focus.



### Hint

- When the camera focuses on the eyes and [Smile/Face Detect.] is set to [On], a detection frame is displayed on the face after it is displayed on the eyes. When [Smile/Face Detect.] is set to [Off], a detection frame is displayed on the eyes for a certain time.

## AF drive speed (still image)

---

You can select the autofocus speed for shooting still images.

1. MENU →  (Camera Settings) → [ AF drive speed] → desired setting.

## Menu item details

### **Fast (default setting):**

Sets the AF drive speed to fast.

### **Slow:**

Sets the AF drive speed to slow.

---

[88] How to Use | Using shooting functions | Adjusting the focus

## AF Track Duration (still image)

---

You can select the duration for AF tracking when shooting still images.

1. MENU →  (Camera Settings) → [ AF Track Duration] → desired setting.

## Menu item details

### **5 (High) / 4 / 3 (Mid) (default setting) / 2 / 1 (Low):**

Select [5 (High)] to shoot fast-moving subjects.



---

[89] How to Use | Using shooting functions | Adjusting the focus

## AF Track Duration (movie)

---

You can set the duration for AF tracking in movie mode.

1. MENU →  (Camera Settings) → [ AF Track Duration] → desired setting.

## Menu item details

### **High:**

Sets the AF Track Duration to high. This mode is useful when recording movies when the subject is moving quickly.

### **Mid (default setting):**

Sets the AF Track Duration to normal.

### **Low:**

Sets the AF Track Duration to low.

## Measuring the exact distance to the subject

---

The  mark shows the location of the image sensor\*. When you measure the exact distance between the product and the subject, refer to the position of the horizontal line.

\*The image sensor is the part that converts the light source to a digital signal.

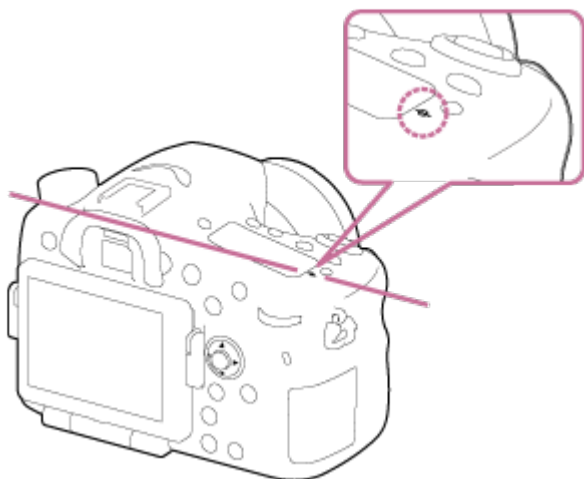

### Note

- If the subject is closer than the minimum shooting distance of the lens, the focus cannot be confirmed. Make sure you put enough distance between the subject and the product.

## AF Range Control

---

You can restrict the autofocus range to focus on a subject without interference from objects in the background and foreground. The [AF Range Control] function is assigned to the C (Custom) button with the default settings.

1. Press the C (Custom) button **(A)**.

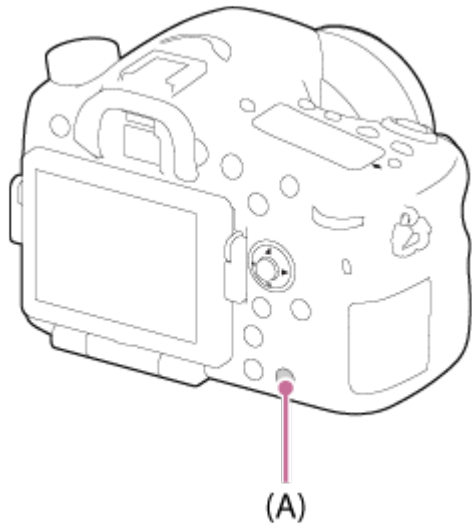

2. Set the maximum shooting distance using the front dial and set the minimum shooting distance using the rear dial.
  - Focus areas of the subject that are within the set AF range area will be displayed in yellow.
3. Press the C (Custom) button again and decide the shooting distance.
  - The restricted area will remain displayed.
  - Focus areas of the subject that are within the set distance will be displayed in yellow.

## To end the AF range control function

Press the C (Custom) button again.

### Hint

- After adjusting the focus to the desired subject, restrict the AF range so that the lens focus indicator ▼ falls within the set range.
- Set the AF range to within or outside the restricted value while watching the yellow focus area.

### Note

- [AF Range Control] cannot be used in Manual focus mode or when shooting movies.
- If you change the lens, the set AF range will be reset.
- When you are using a lens equipped with a focus range limit function, do not use the camera's [AF Range Control] function at the same time. Use the function on either the lens or the camera.
- If you use a lens that is not equipped with a distance encoder, the shooting distance is not displayed.
- The shooting distance value is an estimate.
- The set value of the AF range, the shooting distance value, and the actual focus point may differ slightly.
- The actual set AF range and the yellow guide of the focus area may not correspond.

- The focus area may not be displayed in yellow when the lens does not attain proper focus.
- When the light is not strong enough or there is not much contrast in the subject, such as with monotone and flat surfaces, the focus area may not be displayed in yellow. In that case, use the outline of the subject as a guide.
- Only lenses with in-lens motors (SSM and SAM lenses\*) can be used with Direct Manual Focus.

\*Some SAM lenses do not support Direct Manual Focus. Refer to the operating instructions for your lens.

- When using lenses without in-lens motors (other than SSM and SAM lenses\*), the product may start the initial operation for infinity when used with the AF/MF control function.

\*Some SAM lenses do not support the AF/MF control function. Refer to the operating instructions for your lens.

---

[92] How to Use | Using shooting functions | Adjusting the focus

## AF-A setup

---

Sets whether to allow manual fine-adjustment of the focus when the focus mode is set to [AF-A].

1. MENU →  (Camera Settings) → [AF-A setup] → desired setting.

### Menu item details

#### **AF-A (default setting):**

Switches between [Single-shot AF] and [Continuous AF] according to the movement of the subject.

#### **DMF:**

The focus can be fine-adjusted manually after the focus is set by auto focus function (Direct Manual Focus).

---

[93] How to Use | Using shooting functions | Adjusting the focus

## Priority setup

---

Sets whether or not to release the shutter even when focus is not achieved in auto focus



mode.

1. MENU →  (Custom Settings) → [Priority setup] → desired setting.

## Menu item details

### **AF:**

Images are shot prioritizing focus.

### **Release:**

The shutter is released even when focus has not been achieved.

### **Balanced Emphasis (default setting):**

Images are shot balancing both focus and photo opportunity.

---

[94] How to Use | Using shooting functions | Adjusting the exposure

## Exposure Comp.

---

Based on the exposure value set by auto exposure, you can make the entire image brighter or darker if you adjust [Exposure Comp.] to the plus side or minus side, respectively (exposure compensation). Normally, exposure is set automatically (auto exposure).

1. MENU →  (Camera Settings) → [Exposure Comp.] → desired setting.  
You can adjust the exposure in a range of  $-5.0$  EV to  $+5.0$  EV.

### **Note**

- You can adjust the exposure in a range of  $-2.0$  EV to  $+2.0$  EV for movies.
- If you shoot a subject in extremely bright or dark conditions, or when you use the flash, you may not be able to get a satisfactory effect.
- Only a value between  $-3.0$  EV and  $+3.0$  EV with the equivalent image brightness appears on the screen when shooting. If you set an exposure beyond this range, the image brightness on the screen does not show the effect, but it will be reflected in the recorded image.
- When you use [Manual Exposure], you can compensate for the exposure only when [ISO] is set to [ISO AUTO].

---

[95] How to Use | Using shooting functions | Adjusting the exposure

## Exposure compensation button

---

Based on the exposure value set by auto exposure, you can make the entire image brighter or darker if you adjust [Exposure Comp.] to the plus side or minus side, respectively (exposure compensation). Normally, exposure is set automatically (auto exposure).

1. Press the exposure compensation button.

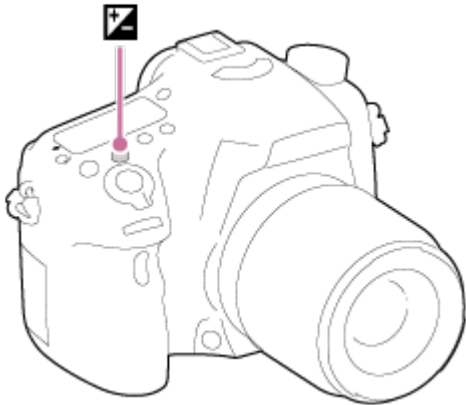

2. Select the desired setting using the right/left side of the multi-selector.

#### Note

- You can adjust the exposure in a range of  $-2.0$  EV to  $+2.0$  EV for movies.
- If you shoot a subject in extremely bright or dark conditions, or when you use the flash, you may not be able to get a satisfactory effect.
- When you use [Manual Exposure], you can compensate for the exposure only when [ISO] is set to [ISO AUTO].

---

[96] How to Use | Using shooting functions | Adjusting the exposure

## Metering Mode

---

Selects the metering mode that sets which part of the screen to measure for determining the exposure.

1. MENU →  (Camera Settings) → [Metering Mode] → desired setting.

### Menu item details

#### Multi (default setting):

Measures light on each area after dividing the total area into multiple areas and determines the proper exposure of the entire screen (Multi-pattern metering).

#### Center:



Measures the average brightness of the entire screen, while emphasizing the central area of the screen (Center-weighted metering).

### **Spot:**

Measures only the central area (Spot metering). This function is useful when the subject is backlit or when there is strong contrast between the subject and the background.

### **Note**

- [Multi] is selected when using the following functions:
  - [Intelligent Auto] or [Superior Auto]
  - [Scene Selection]
  - Zoom functions other than optical zoom

---

[97] How to Use | Using shooting functions | Adjusting the exposure

## AE lock

---

When the contrast between the subject and background is high, such as when shooting a backlit subject or a subject near a window, meter the light at a spot where the subject appears to have the appropriate brightness and lock the exposure before shooting. To reduce the brightness of the subject, meter the light at a spot brighter than the subject and lock the exposure of the entire screen. To make the subject brighter, meter the light at a spot darker than the subject and lock the exposure of the entire screen.

1. Adjust the focus on the spot at which the exposure is adjusted.
2. Press the AEL button.

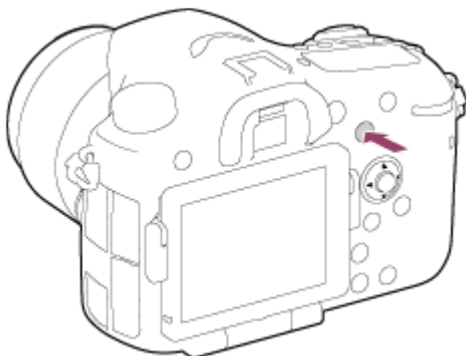

The exposure is locked, and  (AE lock) lights up.

3. Keep pressing the AEL button and focus on the subject again, then shoot the picture.
  - Keep holding the AEL button down while taking a shot if you want to continue shooting with the fixed exposure. Release the button to reset the exposure.

## Hint

- If you select the [AEL toggle] function in [Custom Key Settings], you can lock the exposure without holding down the AEL button.



---

[98] How to Use | Using shooting functions | Adjusting the exposure

## AEL w/ shutter (still image)

---

Sets whether to fix the exposure when you press the shutter button halfway down.

1. MENU →  (Custom Settings) → [ AEL w/ shutter] → desired setting.

### Menu item details

#### Auto (default setting):

Fixes the exposure after adjusting the focus automatically when you press the shutter button halfway down when focus mode is set to S (Single-shot AF).

When focus mode is set to A (Automatic AF), and the product determines that the subject is moving, or you shoot burst images, the fixed exposure is cancelled.

#### On:

Fixes the exposure when you press the shutter button halfway down.

#### Off:

Does not fix the exposure when you press the shutter button halfway down. Use this mode when you want to adjust focus and exposure separately.

The product keeps adjusting the exposure while shooting in [Cont. Shooting] mode.

## Note

- Operation using the AEL button is prioritized over the [ AEL w/ shutter] settings.

---

[99] How to Use | Using shooting functions | Adjusting the exposure

## Exp.comp.set

---

Sets whether to apply the exposure compensation value to control both flash light and ambient light, or just ambient light.

1. MENU →  (Custom Settings) → [Exp.comp.set] → desired setting.

## Menu item details

### **Ambient&flash (default setting):**

Applies the exposure compensation value to control both flash light and ambient light.

### **Ambient only:**

Applies the exposure compensation value to control ambient light only.

---

[100] How to Use | Using shooting functions | Adjusting the exposure

## Zebra

---

The zebra pattern will appear over the part of an image if the brightness level exceeds the IRE that you set. Use this zebra pattern as a guide to adjust the brightness.

1. MENU →  (Custom Settings) → [Zebra] → desired setting.

## Menu item details

### **Off (default setting):**

Does not display the zebra pattern.

### **70/75/80/85/90/95/100/100+:**

Adjusts the brightness level.

#### **Note**

- The zebra pattern is not displayed during HDMI connection.

---

[101] How to Use | Using shooting functions | Adjusting the exposure

## Exposure Set. Guide

---

You can set whether to display a guide when you change the exposure.

1. MENU →  (Custom Settings) → [Exposure Set. Guide] → desired setting.

## Menu item details

### **Off (default setting):**

Does not display the guide.

**On:**

Displays the guide.

---

[102] How to Use | Using shooting functions | Adjusting the exposure

## Exposure step

---

You can set the setting range for the shutter speed, aperture, and exposure compensation values.

1. MENU →  (Camera Settings) → [Exposure step] → desired setting.

### Menu item details

**0.3EV (default setting)/0.5EV**

---

[103] How to Use | Using shooting functions | Adjusting the exposure

## Dial Ev Comp

---

You can compensate the exposure using the front or rear dial.

1. MENU →  (Custom Settings) → [Dial Ev Comp] → desired setting.

### Menu item details

**Off (default setting):**

Does not enable exposure compensation with the front or rear dial.

 **Front dial/**  **Rear dial:**

Enables exposure compensation with the front or rear dial.

**Note**

- When the exposure compensation function is assigned to the front or rear dial, any function that had been assigned to that dial previously is re-assigned to another dial.
- 

[104] How to Use | Using shooting functions | Selecting a drive mode (Continuous

## Drive Mode

---

You can set the drive mode, such as continuous or self-timer shooting.

1. MENU →  (Camera Settings) → [Drive Mode] → desired setting.

### Menu item details

#### **Single Shooting (default setting):**

Shoots one still image. Normal shooting mode.

#### **Cont. Shooting:**

Shoots images continuously while you press and hold down the shutter button.

#### **Self-timer:**

Shoots an image after 10 or 2 seconds.

#### **Self-timer(Cont):**

Shoots a specified number of images continuously after 10 seconds.

#### **Cont. Bracket:**

Shoots images while holding the shutter button down, each with different degrees of brightness.

#### **Single Bracket:**

Shoots a specified number of images, one by one, each with a different degree of brightness.

#### **WB bracket:**

Shoots a total of three images, each with a different color tones according to the selected settings for white balance, color temperature and color filter.

#### **DRO Bracket:**

Shoots a total of three images, each at a different degree of D-Range Optimizer.

## Cont. Shooting

---

Shoots images continuously while you press and hold down the shutter button.

1. MENU →  (Camera Settings) → [Drive Mode] → [Cont. Shooting].
2. Select the desired mode using the right/left side of the multi-selector.

## Menu Item Details

### **Continuous Shooting: Hi (default setting):**

Continuous shooting speed is set at a maximum of about 8 images per second.

### **Continuous Shooting: Lo:**

Continuous shooting speed is set at a maximum of about 3 images per second.

#### **Hint**

- To hold the focus and exposure during burst, change the following settings.  
The exposure of the first shot is determined when you press the shutter button halfway down. The exposure setting for the first shot is used for the subsequent shots.
  - Set [Focus Mode] to [Continuous AF] or [Automatic AF].
  - Set [ AEL w/ shutter] to [Off] or [Auto].

---

[106] How to Use | Using shooting functions | Selecting a drive mode (Continuous shooting/Self-timer)

## Self-timer

---

The product shoots an image using the self-timer with a 10-second or 2-second delay.

1. MENU →  (Camera Settings) → [Drive Mode] → [Self-timer].
2. Select the desired mode using the right/left side of the multi-selector.

## Menu item details

### **Self-timer: 10 Sec (default setting):**





Sets the 10-second delay self-timer.

When you press the shutter button, the self-timer lamp flashes, a beep sounds, and the shutter operates after 10 seconds. To cancel the self-timer, press the shutter button again.

### **Self-timer: 2 Sec:**

Sets the 2-second delay self-timer. This reduces the camera-shake caused by pressing the shutter button.

#### **Hint**

- Press the  /  button to stop the self-timer.
- Press the  /  button and select  (Single Shooting) to release the self-timer.

---

[107] How to Use | Using shooting functions | Selecting a drive mode (Continuous



## Self-timer(Cont)

---

Continuously shoots the number of images you have set after 10 seconds. You can choose the best shot from several shots taken.

1. MENU →  (Camera Settings) → [Drive Mode] → [Self-timer(Cont)].
2. Select the desired mode using the right/left side of the multi-selector.

### Menu item details

#### **Self-timer(Cont.): 10 Sec. 3 Img. (default setting):**

Shoots three frames in succession 10 seconds after you press the shutter button.

When you press the shutter button, the self-timer lamp flashes, a beep sounds, and the shutter operates after 10 seconds.

#### **Self-timer(Cont.): 10 Sec. 5 Img.:**

Shoots five frames in succession 10 seconds after you press the shutter button.

When you press the shutter button, the self-timer lamp flashes, a beep sounds, and the shutter operates after 10 seconds.

## Cont. Bracket

---

Shoots multiple images while automatically shifting the exposure from base to darker and then to lighter. Press and hold down the shutter button until the bracket recording is completed.

You can select an image that suits your intention, after recording.

1. MENU →  (Camera Settings) → [Drive Mode] → [Cont. Bracket].
2. Select the desired mode using the right/left side of the multi-selector.

### Menu item details

#### **Cont. Bracket: 0.3EV 3 Image (default setting):**

This setting shoots three images continuously with an exposure value shifted by plus or minus 0.3 EV.

#### **Cont. Bracket: 0.3EV 5 Image:**



This setting shoots five images continuously with an exposure value shifted by plus or minus 0.3 EV.



**Cont. Bracket: 0.5EV 3 Image:**

This setting shoots three images continuously with an exposure value shifted by plus or minus 0.5 EV.



**Cont. Bracket: 0.5EV 5 Image:**

This setting shoots five images continuously with an exposure value shifted by plus or minus 0.5 EV.



**Cont. Bracket: 0.7EV 3 Image:**

This setting shoots three images continuously with an exposure value shifted by plus or minus 0.7 EV.



**Cont. Bracket: 0.7EV 5 Image:**

This setting shoots five images continuously with an exposure value shifted by plus or minus 0.7 EV.



**Cont. Bracket: 1.0EV 3 Image:**

This setting shoots three images continuously with an exposure value shifted by plus or minus 1.0 EV.



**Cont. Bracket: 1.0EV 5 Images:**

This setting shoots five images continuously with an exposure value shifted by plus or minus 1.0 EV.



**Cont. Bracket: 2.0EV 3 Image:**

This setting shoots three images continuously with an exposure value shifted by plus or minus 2.0 EV.



**Cont. Bracket: 2.0EV 5 Images:**

This setting shoots five images continuously with an exposure value shifted by plus or minus 2.0 EV.



**Cont. Bracket: 3.0EV 3 Image:**

This setting shoots three images continuously with an exposure value shifted by plus or minus 3.0 EV.



**Cont. Bracket: 3.0EV 5 Images:**

This setting shoots five images continuously with an exposure value shifted by plus or minus 3.0 EV.

**Note**

- The last shot is shown on the Auto Review.
- When [ISO AUTO] is selected in [Manual Exposure] mode, the exposure is changed by adjusting the ISO value. If a setting other than [ISO AUTO] is selected, the exposure is

changed by adjusting the shutter speed.

- When you adjust the exposure, the exposure is shifted based on the compensated value.
- When the flash is used, the product performs flash bracket shooting, which shifts the amount of flash light even if [Cont. Bracket] is selected. Press the shutter button for each image.

---

[109] How to Use | Using shooting functions | Selecting a drive mode (Continuous shooting/Self-timer)

## Single Bracket

---

Shoots multiple images while automatically shifting the exposure from base to darker and then to lighter.

Press the shutter button for each image. You can select an image that suits your purpose after recording.

1. MENU →  (Camera Settings) → [Drive Mode] → [Single Bracket].
2. Select the desired mode using the right/left side of the multi-selector.

### Menu item details

#### **Single Bracket: 0.3EV 3 Image (default setting):**

This setting shoots a total of three images in a row with an exposure value shifted by plus or minus 0.3 EV.

#### **Single Bracket: 0.3EV 5 Image:**

This setting shoots a total of five images in a row with an exposure value shifted by plus or minus 0.3 EV.

#### **Single Bracket: 0.5EV 3 Image:**

This setting shoots a total of three images in a row with an exposure value shifted by plus or minus 0.5 EV.

#### **Single Bracket: 0.5EV 5 Image:**

This setting shoots a total of five images in a row with an exposure value shifted by plus or minus 0.5 EV.

#### **Single Bracket: 0.7EV 3 Image:**

This setting shoots a total of three images in a row with an exposure value shifted by plus or minus 0.7 EV.

#### **Single Bracket: 0.7EV 5 Image:**

This setting shoots a total of five images in a row with an exposure value shifted by plus or

minus 0.7 EV.

 **Single Bracket: 1.0EV 3 Image:**

This setting shoots a total of three images in a row with an exposure value shifted by plus or minus 1.0 EV.

 **Single Bracket: 1.0EV 5 Images:**

This setting shoots a total of five images in a row with an exposure value shifted by plus or minus 1.0 EV.

 **Single Bracket: 2.0EV 3 Image:**

This setting shoots a total of three images in a row with an exposure value shifted by plus or minus 2.0 EV.

 **Single Bracket: 2.0EV 5 Images:**

This setting shoots a total of five images in a row with an exposure value shifted by plus or minus 2.0 EV.

 **Single Bracket: 3.0EV 3 Image:**

This setting shoots a total of three images in a row with an exposure value shifted by plus or minus 3.0 EV.

 **Single Bracket: 3.0EV 5 Images:**

This setting shoots a total of five images in a row with an exposure value shifted by plus or minus 3.0 EV.

**Note**

- When [ISO AUTO] is selected in [Manual Exposure] mode, the exposure is changed by adjusting the ISO value. If a setting other than [ISO AUTO] is selected, the exposure is changed by adjusting the shutter speed.
- When you adjust the exposure, the exposure is shifted based on the compensated value.

---

[110] How to Use | Using shooting functions | Selecting a drive mode (Continuous shooting/Self-timer)

## WB bracket

---

Shoots three images, each with different color tones according to the selected settings of white balance, color temperature and color filter.

1. MENU →  (Camera Settings) → [Drive Mode] → [WB bracket].
2. Select the desired mode using the right/left side of the multi-selector.

## Menu item details

### **White Balance Bracket: Lo (default setting):**

Records a series of three images with small changes in the white balance.

### **White Balance Bracket: Hi:**

Records a series of three images with large changes in the white balance.

#### Note

- The last shot is shown on the Auto Review.

---

[111] How to Use | Using shooting functions | Selecting a drive mode (Continuous shooting/Self-timer)

## DRO Bracket

You can record a total of three images, each at a different degree of D-Range Optimizer value.

1. MENU →  (Camera Settings) → [Drive Mode] → [DRO Bracket].
2. Select the desired mode using the right/left side of the multi-selector.

## Menu item details

### **DRO Bracket: Lo (default setting):**

Records a series of three images with small changes in the D-Range Optimizer value.

### **DRO Bracket: Hi:**

Records a series of three images with large changes in the D-Range Optimizer value.

#### Note

- The last shot is shown on the Auto Review.

---

[112] How to Use | Using shooting functions | Selecting a drive mode (Continuous shooting/Self-timer)

## Bracket order

You can set the shooting order for exposure bracketing and white balance bracketing.

1. MENU →  (Custom Settings) → [Bracket order] → desired setting

## Menu item details

### **0 → - → + (default setting):**

Records in the following order: 0 → - → +.

### **- → 0 → +:**

Records in the following order: - → 0 → +.

---

[113] How to Use | Using shooting functions | Selecting the ISO sensitivity

## ISO

---

Sensitivity to light is expressed by the ISO number (recommended exposure index). The larger the number, the higher the sensitivity.

1. MENU →  (Camera Settings) → [ISO] → desired setting.

## Menu item details

### **Multi Frame NR:**

Combines continuous shots to create an image with less noise.

### **ISO AUTO (default setting):**

Sets the ISO sensitivity automatically.

**50 / 64 / 80 / 100 / 125 / 160 / 200 / 250 / 320 / 400 / 500 / 640 / 800 / 1000 / 1250 / 1600 / 2000 / 2500 / 3200 / 4000 / 5000 / 6400 / 8000 / 10000 / 12800 / 16000 / 20000 / 25600:**

You can reduce image blurring in dark locations or with moving subjects by increasing the ISO sensitivity (select a larger number).

### **Note**

- [ISO AUTO] is selected when using the following functions:
  - [Intelligent Auto]
  - [Superior Auto]
  - [Scene Selection]
  - [Sweep Panorama]
- When [ISO] is set to a value lower than ISO 100, the range for recordable subject brightness (dynamic range) may decrease.
- The higher the ISO value, the more noise will appear on the images.
- When shooting movies, ISO values between ISO 100 and ISO 12800 are available. If the ISO value is set to a value smaller than ISO 100, the setting is automatically switched to

ISO 100. When you finish recording the movie, the ISO value returns to the original setting.

- When you use [Multi Frame NR], it takes some time for the product to perform the overlay processing of images.

#### Hint

- You can change the automatically set ISO sensitivity range for the [ISO AUTO] mode. Select [ISO AUTO], press the right side of the multi-selector, and set the desired values for [ISO AUTO Maximum] and [ISO AUTO Minimum]. The values for [ISO AUTO Maximum] and [ISO AUTO Minimum] are also applied when shooting in [ISO AUTO] mode under [Multi Frame NR].

---

[114] How to Use | Using shooting functions | Selecting the ISO sensitivity

## Multi Frame NR

---

The product automatically shoots multiple images continuously, combines them, reduces the noise, and records them as one image. With multi frame noise reduction, you can select larger ISO numbers than the maximum ISO sensitivity. The image recorded is one combined image.

1. MENU →  (Camera Settings) → [ISO] → [Multi Frame NR].
2. Press the right side of the multi-selector to display the setting screen, then select a desired value using the top/bottom side of the multi-selector.

#### Note

- When [ Quality] is set to [RAW] or [RAW & JPEG], this function cannot be used.
- The flash, [D-Range Opt.], and [Auto HDR] cannot be used.
- You cannot set [Multi Frame NR] when [Picture Effect] is set.

#### Hint

- You can change the automatically set range of ISO sensitivity in the [ISO AUTO] mode under [Multi Frame NR]. Select [ISO AUTO] under [ISO] and press the right side of the multi-selector, and set the desired values for [ISO AUTO Maximum] and [ISO AUTO Minimum]. The values for [ISO AUTO Maximum] and [ISO AUTO Minimum] are also applied when shooting in [ISO AUTO] mode under [Multi Frame NR].

---

[115] How to Use | Using shooting functions | Selecting the ISO sensitivity

# NR Effect

---

Sets the effect level for multi frame NR.

1. MENU →  (Camera Settings) → [ISO] → [Multi Frame NR] → [NR Effect]

## Menu item details

### Normal:

4 images are added for the multi frame NR effect.

### High:

12 images are added for the multi frame NR effect to produce images with even less noise.

### Note

- When [High] is selected, it takes longer to shoot and combine images.

---

[116] How to Use | Using shooting functions | Correcting the brightness or contrast

## D-Range Opt. (DRO)

---

By dividing the image into small areas, the product analyzes the contrast of light and shadow between the subject and the background, and creates an image with the optimal brightness and gradation.

1. MENU →  (Camera Settings) → [DRO/Auto HDR] → [D-Range Opt.].
2. Select the desired setting using the left/right side of the multi-selector.

## Menu item details



### **D-Range Optimizer: Auto (default setting):**

Corrects the brightness automatically.



### **D-Range Optimizer: Lv1 – D-Range Optimizer: Lv5:**

Optimizes the gradation of a recorded image for each divided area. Select the optimization level from Lv1 (weak) to Lv5 (strong).

### Note

- [DRO/Auto HDR] is fixed to [Off] when the shooting mode is set to [Sweep Panorama], or when [Multi Frame NR] or [Picture Effect] is used.



- [DRO/Auto HDR] is fixed to [Off] when [Sunset], [Night Scene], [Night Portrait] or [Hand-held Twilight] is selected in [Scene Selection]. The setting is fixed to [D-Range Optimizer: Auto] when other modes are selected in [Scene Selection].
- When shooting with [D-Range Opt.], the image may be noisy. Select the proper level by checking the recorded image, especially when you enhance the effect.

---

[117] How to Use | Using shooting functions | Correcting the brightness or contrast

## Auto HDR

---

Widens the range (gradation) so that you can record from bright parts to dark parts with correct brightness (HDR: High Dynamic Range). One image with proper exposure and one overlaid image are recorded.

1. MENU →  (Camera Settings) → [DRO/Auto HDR] → [Auto HDR].
2. Select the desired setting using the left/right side of the multi-selector.

### Menu item details

 **Auto HDR: Exposure Diff. Auto (default setting):**

Corrects the exposure difference automatically.

 **Auto HDR: Exposure Diff. 1.0EV – Auto HDR: Exposure Diff. 6.0EV:**

Sets the exposure difference, based on the contrast of the subject. Select the optimal level between 1.0 EV (weak) and 6.0 EV (strong).

For example, if you set the exposure value to 2.0 EV, three images will be composed with the following exposure levels; -1.0 EV, optimal exposure and +1.0 EV.

### Note

- [Auto HDR] is not available for RAW images.
- When the shooting mode is set to [Intelligent Auto], [Superior Auto], [Sweep Panorama], [Cont. Priority AE] or [Scene Selection], you cannot select [Auto HDR].
- When [Multi Frame NR] is selected, you cannot select [Auto HDR].
- When using [Picture Effect], you cannot select [Auto HDR].
- You cannot start the next shot until the capture process is completed after you shoot.
- You may not obtain the desired effect depending on the luminance difference of a subject and the shooting conditions.
- When the flash is used, this function has little effect.
- When the contrast of the scene is low or when product shake or subject blur occurs, you may not obtain good HDR images. If the product has detected a problem,  is displayed on the recorded image to inform you of this situation. Shoot again as

necessary, paying attention to the contrast or blur.

---

[118] How to Use | Using shooting functions | Adjusting color tones

## White Balance

---

Adjusts the color tones according to the ambient light conditions. Use this feature when the color tones of the image did not come out as you expected, or when you want to change the color tones on purpose for photographic expression.

1. MENU →  (Camera Settings) → [White Balance] → desired setting.
  - You can also set the white balance by pressing the WB (White Balance) button.

### Menu item details

#### **AWB Auto (default setting):**

The product automatically detects the light source and adjusts the color tones.

#### **Daylight:**

The color tones are adjusted for the daylight.

#### **Shade:**

The color tones are adjusted for shadiness.

#### **Cloudy:**

The color temperature is adjusted for a cloudy sky.

#### **Incandescent:**

The color temperature is adjusted for places under an incandescent lamp, or under bright lighting, such as in a photo studio.

#### **-1 Fluor.: Warm White:**

The color temperature is adjusted for warm white fluorescent lighting.

#### **0 Fluor.: Cool White:**

The color temperature is adjusted for white fluorescent lighting.

#### **+1 Fluor.: Day White:**

The color temperature is adjusted for neutral white fluorescent lighting.

#### **+2 Fluor.: Daylight:**

The color temperature is adjusted for daylight fluorescent lighting.

#### **Flash:**

The color temperature is adjusted for flash light.

### **C.Temp./Filter:**

Adjusts the color tones depending on the light source. Achieves the effect of CC (Color Compensation) filters for photography.

### **Custom 1/Custom 2/Custom 3:**

Uses the white balance setting saved in [Custom Setup].

### **Custom Setup:**

Memorizes the basic white color under the light conditions for the shooting environment. Select a memorized custom white balance number.

#### **Hint**

- You can use the right side of the multi-selector to display the fine adjustment screen and perform fine adjustments of the color temperature as required.
- In [C.Temp./Filter], you can use the right button to display the color temperature setting screen and perform a setting. When you press the right button again, the fine adjustment screen appears to allow you perform fine adjustments as required.

#### **Note**

- [White Balance] is fixed to [Auto] in the following situations:
  - [Intelligent Auto]
  - [Superior Auto]
  - [Scene Selection]



---

[119] How to Use | Using shooting functions | Adjusting color tones

## Capturing a basic white color in [Custom Setup] mode

---

In a scene where the ambient light consists of multiple types of light sources, it is recommended to use the custom white balance in order to accurately reproduce the whiteness.

1. MENU →  (Camera Settings) → [White Balance] → [Custom Setup].
  - You can also set the white balance by pressing the WB (White Balance) button.
2. Hold the product so that the white area fully covers the AF area located in the center, and then press  on the center of the multi-selector.  
The calibrated values (Color Temperature and Color Filter) are displayed.
3. Select a registration number using the right/left button.  
The monitor returns to the recording information display while retaining the memorized custom white balance setting.

## Note

- The message [Custom WB Error] indicates that the value is higher than the expected range, when the flash is used on a subject with too bright colors in the frame. If you register this value, the  indicator turns orange on the recording information display. You can shoot at this point, but it is recommended that you set the white balance again to get a more accurate white balance value.

---

[120] How to Use | Using shooting functions | Selecting an effect mode

## Picture Effect

---

Select the desired effect filter to achieve more impressive and artistic images.

1. MENU →  (Camera Settings) → [Picture Effect] → desired setting.

### Menu item details

#### **Off (default setting):**

Disables the [Picture Effect] function.

#### **Toy Camera:**

Creates a soft image with shaded corners and reduced sharpness.

#### **Pop Color:**

Creates a vivid look by emphasizing color tones.

#### **Posterization:**

Creates a high contrast, abstract look by heavily emphasizing primary colors, or in black and white.

#### **Retro Photo:**

Creates the look of an aged photo with sepia color tones and faded contrast.

#### **Soft High-key:**

Creates an image with the indicated atmosphere: bright, transparent, ethereal, tender, soft.

#### **Partial Color:**

Creates an image which retains a specific color, but converts others to black and white.

#### **High Contrast Mono.:**

Creates a high-contrast image in black and white.

#### **Soft Focus:**

Creates an image filled with a soft lighting effect.

#### **HDR Painting:**

Creates the look of a painting, enhancing the colors and details.

 **Rich-tone Mono.:**

Creates an image in black and white with rich gradation and reproduction of details.

 **Miniature:**

Creates an image which enhances the subject vividly, with the background defocused considerably. This effect may often be found in pictures of miniature models.

 **Watercolor:**

Creates an image with ink bleed and blurring effects as if painted using watercolors.

 **Illustration:**



Creates an illustration-like image by emphasizing the outlines.

**Hint**

- You can perform detailed settings for the following [Picture Effect] modes using the left/right side of the multi-selector.
  - [Toy Camera]
  - [Posterization]
  - [Partial Color]
  - [Soft Focus]
  - [HDR Painting]
  - [Miniature]
  - [Illustration]

**Note**

- When [Partial Color] is selected, images may not retain the selected color, depending on the subject or shooting conditions.
- You cannot check the following effects on the shooting screen, because the product processes the image after the shot. Also, you cannot shoot another image until image processing is finished. You cannot use these effects with movies.
  - [Soft Focus]
  - [HDR Painting]
  - [Rich-tone Mono.]
  - [Miniature]
  - [Watercolor]
  - [Illustration]
- In the case of [HDR Painting] and [Rich-tone Mono.], the shutter is released three times for one shot. Be careful about the following:
  - Use this function when the subject is motionless or does not flash light.
  - Do not change the composition before shooting.

When the contrast of the scene is low or when significant camera-shake or subject blur has occurred, you may not be able to obtain good HDR images. If the product detects such a situation,   appear on the recorded image to inform you of this

situation. If necessary, change the composition or otherwise adjust the settings, be careful of blurring, and shoot again.

---

[121] How to Use | Using shooting functions | Selecting an effect mode

## Creative Style

---

Allows you to select the desired image processing. You can adjust exposure (shutter speed and aperture) as you like with [Creative Style], unlike with [Scene Selection] where the product adjusts the exposure.

1. MENU →  (Camera Settings) → [Creative Style] → desired setting.

### Menu item details

#### **Standard (default setting):**

For shooting various scenes with rich gradation and beautiful colors.

#### **Vivid:**

The saturation and contrast are heightened for shooting striking images of colorful scenes and subjects such as flowers, spring greenery, blue sky, or ocean views.

#### **Neutral:**

The saturation and sharpness are lowered for shooting images in subdued tones. This is also suitable for capturing image material to be modified with a computer.

#### **Clear:**

For shooting images in clear tones with limpid colors in highlight, suitable for capturing radiant light.

#### **Deep:**

For shooting images with deep and dense colors, suitable for capturing the solid presence of the subject.

#### **Light:**

For shooting images with bright and simple colors, suitable for capturing a refreshingly light ambience.

#### **Portrait:**

For shooting the skin color in a soft tone, ideally suited for shooting portraits.

#### **Landscape:**

The saturation, contrast, and sharpness are heightened for shooting vivid and crisp scenery. Distant landscapes also stand out more.

#### **Sunset:**



For shooting the beautiful red of the setting sun.



### **Night Scene:**

The contrast is lowered for reproducing night scenes.



### **Autumn leaves:**

For shooting autumn scenes, vividly highlighting the reds and yellows of changing leaves.



### **Black & White:**

For shooting images in black and white monotone.



### **Sepia:**

For shooting images in sepia monotone.

## **To set [Contrast], [Saturation] and [Sharpness]**

[Contrast], [Saturation] and [Sharpness] can be adjusted for each [Creative Style] item.

Select an item to be set by pressing the right/left side of the multi-selector, then set the value using the top/bottom side of the multi-selector.



### **Contrast:**

The higher the value selected, the more the difference of light and shadow is accentuated, and the bigger the effect on the image.



### **Saturation:**

The higher the value selected, the more vivid the color. When a lower value is selected, the color of the image is restrained and subdued.



### **Sharpness:**

Adjusts the sharpness. The higher the value selected, the more the contours are accentuated, and the lower the value selected, the more the contours are softened.

## **Registering preferred settings (Style Box)**

Select the six style box (the boxes with numbers on the left side (  )) to register preferred settings. Then select the desired settings using the right side of the multi-selector.

You can call up the same style with slightly different settings.

### **Note**

- [Standard] is selected when using the following functions:
  - [Intelligent Auto]
  - [Superior Auto]
  - [Scene Selection]
  - [Picture Effect]
- When [Creative Style] is set to [Black & White] or [Sepia], [Saturation] cannot be adjusted.

# Movie recording formats

---

You can use the movie recording format "XAVC S" with this camera. For details on the "XAVC S" format, see the following description.

## What is XAVC S?

Records high-definition movies by converting them to MP4 movies using the MPEG-4 AVC/H.264 codec. MPEG-4 AVC/H.264 is capable of compressing images at higher efficiency. You can record high-quality images while reducing the amount of data.

## XAVC S/AVCHD recording format

### XAVC S:

Bit-rate: Approx. 50 Mbps

Records a more vivid movie compared to AVCHD with increased amounts of information.

### AVCHD:

Bit-rate: Approx. 28Mbps\*

The AVCHD format has a high degree of compatibility with storage devices other than computers.

- Bit rate is the amount of the data processed within a given length of time.

\*Maximum



---

[123] How to Use | Using shooting functions | Recording movies

## File Format (movie)

---

Selects the movie file format.



1. MENU →  (Camera Settings) → [ File Format] → desired setting.

## Menu item details

### XAVC S:

Records HD movies in XAVC S format. This file format is suitable for high bit rates.

Audio: LPCM

- You cannot create discs using the software PlayMemories Home with movies that are recorded with [ File Format] set to [XAVC S].
- In order to record movies with [ File Format] set to [XAVC S], you need an SDXC memory card with a capacity of at least 64 GB (Class 10 or faster), a UHS-I compatible SDXC memory card with at least 64 GB (U1 or faster), or a Memory Stick XC-HG Duo



media.

### **AVCHD (default setting):**

Records HD movies in AVCHD format. This file format is suitable for high-definition TV. You can create a Blu-ray Disc, an AVCHD recording disc, or a DVD-Video disc using the software PlayMemories Home.

Audio: Dolby Digital

### **MP4:**

Records mp4 (AVC) movies. This format is suitable for WEB uploads, e-mail attachments, etc.

Audio: AAC

- You cannot create a disc using the software PlayMemories Home with a movie that was recorded when [  File Format] was set to [MP4].



---

[124] How to Use | Using shooting functions | Recording movies

## Record Setting (movie)

---

Selects the image size, frame rate, and image quality for movie recording. The higher the bit-rate, the higher the image quality.

1. MENU →  (Camera Settings) → [  Record Setting] → desired setting.

### **When [ File Format] is set to [XAVC S]**

Records high-definition movies by converting them to MP4 file format using the MPEG-4 AVC/H.264 codec.

### **When [ File Format] is set to [AVCHD]**

60i/50i: Movies are recorded at approximately 60 fields/sec (for 1080 60i-compatible devices) or 50 fields/sec (for 1080 50i-compatible devices), in interlaced mode, with Dolby Digital audio, in AVCHD format.

24p/25p: Movies are recorded at approximately 24 frames/sec (for 1080 60i-compatible devices) or 25 frames/sec (for 1080 50i-compatible devices), in progressive mode, with Dolby Digital audio, in AVCHD format.

60p/50p: Movies are recorded at approximately 60 frames/sec (for 1080 60i-compatible devices) or 50 frames/sec (for 1080 50i-compatible devices), in progressive mode, with Dolby Digital audio, in AVCHD format.

### **When [ File Format] is set to [MP4]**

Movies shot are recorded in MPEG-4 format, at approximately 30 frames/sec (for 1080 60i-

compatible devices) or approximately 25 frames/sec (for 1080 50i-compatible devices), in progressive mode, with AAC audio, mp4 format.

## Menu items details

### When [ File Format] is set to [XAVC S]

#### **60p 50M\*/50p 50M\*\*:**

Records high image quality movies at 1920 × 1080 (60p/50p).

Bit-rate: Approx. 50 Mbps

#### **30p 50M\*/25p 50M\*\*:**

Records high image quality movies at 1920 × 1080 (30p/25p).

Bit-rate: Approx. 50 Mbps

#### **24p 50M (Only for 1080 60i compatible models):**

Records high image quality movies at 1920 × 1080 (24p). This produces a cinema-like atmosphere.

Bit-rate: Approx. 50 Mbps

### When [ File Format] is set to [AVCHD]

#### **60i 24M(FX)\*:**

#### **50i 24M(FX)\*\*:**

Records high image quality movies of 1920 × 1080 (60i/50i).

Bit-rate: Approx. 24 Mbps (Max.)

#### **60i 17M(FH) (default setting)\*:**

#### **50i 17M(FH) (default setting)\*\*:**

Records standard image quality movies of 1920 × 1080 (60i/50i).

Bit-rate: Approx. 17 Mbps (Avg.)

#### **60p 28M(PS)\*:**

#### **50p 28M(PS)\*\*:**

Records the highest image quality movies of 1920 × 1080 (60p/50p).

Bit-rate: Approx. 28 Mbps (Max.)

#### **24p 24M(FX)\*:**

#### **25p 24M(FX)\*\*:**

Records high image quality movies of 1920 × 1080 (24p/25p). This produces a cinema-like atmosphere.

Bit-rate: Approx. 24 Mbps (Max.)

#### **24p 17M(FH)\*:**

#### **25p 17M(FH)\*\*:**

Records standard image quality movies of 1920 × 1080 (24p/25p). This produces a cinema-like atmosphere.

Bit-rate: Approx. 17 Mbps (Avg.)

### When [ File Format] is set to [MP4]



### **1440×1080 12M (default setting):**

Records movies of 1440 × 1080.

Bit-rate: Approx. 12 Mbps (Avg.)

### **VGA 3M:**

Records movies of VGA size.

Bit-rate: Approx. 3 Mbps (Avg.)

\* 1080 60i (NTSC) compatible device

\*\* 1080 50i (PAL) compatible device

#### **Note**

- 60p/50p movies can be played back only on compatible devices.
- Movies recorded with the [60p 28M(PS)]/[50p 28M(PS)]/[60i 24M(FX)]/[50i 24M(FX)]/[24p 24M(FX)]/[25p 24M(FX)] setting in [ Record Setting] are converted by PlayMemories Home in order to create an AVCHD recording disc. This conversion can take a long time. Also, you cannot create a disc in the original image quality. If you want to keep the original image quality, store your movies on a Blu-ray Disc.
- To play back 60p/50p/24p/25p movies on a TV, the TV must be compatible with the 60p/50p/24p/25p formats. If the TV is not compatible with the 60p/50p/24p/25p format, 60p/50p/24p/25p movies will be output as 60i/50i movies.
- You cannot create discs with movies recorded with [XAVC S] or [MP4] recording settings using PlayMemories Home.

---

[125] How to Use | Using shooting functions | Recording movies

## SteadyShot (movie)

---

Sets [ SteadyShot] effect when shooting movies. If you set the [ SteadyShot] effect to [Off] when using a tripod (sold separately), a natural image is produced.

1. MENU → (Camera Settings) → [ SteadyShot] → desired setting.

### **Menu item details**

#### **On:**

Uses [ SteadyShot].

#### **Off (default setting):**

Does not use [ SteadyShot].

#### **Note**

- 
- If you change the setting for [ SteadyShot], the angle of view will change.

---

[126] How to Use | Using shooting functions | Recording movies

## Audio Recording

---

Sets whether to record sounds when shooting movies.

1. MENU →  (Camera Settings) → [Audio Recording] → desired setting.

### Menu item details

#### **On (default setting):**

Records sound (stereo).

#### **Off:**

Does not record sound.

#### **Note**

- The noise of the lens and the product in operation will also be recorded, when [On] is selected.

---

[127] How to Use | Using shooting functions | Recording movies

## Audio Level Display

---

Sets whether to display the audio level on the screen.

1. MENU →  (Custom Settings) → [Audio Level Display] → desired setting.

### Menu item details

#### **On (default setting):**

Displays the audio level.

#### **Off:**

Does not display the audio level.

#### **Note**

- The audio level is not displayed in the following situations:

- When [Audio Recording] is set to [Off].
- When DISP (Display Setting) is set to [No Disp. Info.].
- Set the shooting mode to [Movie]. You can see the audio level before recording only in movie recording mode.

---

[128] How to Use | Using shooting functions | Recording movies

## Audio Rec Level

---

You can adjust the audio recording level while checking the level meter.

1. MENU →  (Camera Settings) → [Audio Rec Level] → desired setting.

### Menu item details

**+**:

Turns up the audio recording level.

**-**:

Turns down the audio recording level.

### Reset:

Resets the audio recording level to the default setting.

### Note

- Regardless of the [Audio Rec Level] settings, the limiter always operates.
- [Audio Rec Level] is available only when the shooting mode is set to Movie.
- The [Audio Rec Level] settings are applied for both the internal microphone and the  (Microphone) terminal input.

### Hint

- When you record audio movies with loud volumes, set [Audio Rec Level] to a lower sound level. Doing so enables you to record more realistic audio. When you record audio movies with lower volumes, set [Audio Rec Level] to a greater sound level to make the sound easier to hear.

---

[129] How to Use | Using shooting functions | Recording movies

## Audio Out Timing

---

You can set echo cancellation for shooting when confirming audio via HDMI output.

1. MENU →  (Camera Settings) → [Audio Out Timing] → desired setting.

## Menu item details

### Live (default setting):

Outputs audio without delay when recording movies. Select this setting when audio deviation is a problem during audio monitoring.

### Lip Sync:

Outputs video and audio in sync when recording movies. Select this setting to prevent undesirable deviations between video and audio.

---

[130] How to Use | Using shooting functions | Recording movies

## Wind Noise Reduct.

---

Sets whether or not to reduce wind noise during movie recording.

1. MENU →  (Camera Settings) → [Wind Noise Reduct.] → desired setting.

## Menu item details

### On:

Reduces wind noise.

### Off (default setting):

Does not reduce wind noise.

### Note

- Setting this item to [On] where wind is not blowing sufficiently hard may cause normal sound to be recorded with too low volume.
- When an external microphone (sold separately) is used, [Wind Noise Reduct.] does not function.

---



[131] How to Use | Using shooting functions | Recording movies

## Auto Slow Shut. (movie)

---

Sets whether or not to adjust the shutter speed automatically when recording movies if the

subject is dark.

1. MENU →  (Camera Settings) → [ Auto Slow Shut.] → desired setting.

## Menu item details

### On (default setting):

Uses [ Auto Slow Shut.]. The shutter speed automatically slows when recording in dark locations. You can reduce noise in the movie by using a slow shutter speed when recording in dark locations.

### Off:

Does not use [ Auto Slow Shut.]. The recorded movie will be darker than when [On] is selected, but you can record movies with smoother motion and less object blur.

### Note

- [ Auto Slow Shut.] does not function in the following situations:
  - When [Movie] in shooting mode is set to [Shutter Priority] or [Manual Exposure].
  - When [ISO] is set to other than [ISO AUTO].

---

[132] How to Use | Using shooting functions | Recording movies

## MOVIE Button

---

Sets whether or not to activate the MOVIE button.

1. MENU →  (Custom Settings) → [MOVIE Button] → desired setting.

## Menu item details

### Always (default setting):

Starts movie recording when you press the MOVIE button in any mode.

### Movie Mode Only:

Starts movie recording when you press the MOVIE button only if the shooting mode is set to [Movie] mode.

---

[133] How to Use | Using shooting functions | Customizing the shooting functions for convenient use

## Memory

---

Allows you to register up to 3 often-used modes or product settings in the product. You can recall the settings using just the mode dial.

1. Set the product to the setting you want to register.
2. MENU →  (Camera Settings) → [Memory] → desired number.

## Items that can be registered

- Shooting mode
- Aperture (F number)
- Shutter speed
-  Camera Settings

## To recall registered settings

Select the memory number from “1,” “2” or “3” on the mode dial.

## To change registered settings

Change the setting to the desired one and re-register the setting to the same mode number.

### Note

- Program Shift cannot be registered.
- For some functions, the position of the dial and the setting actually used for shooting may not match. If this happens, shoot images by referring to the information displayed on the monitor.

---

[134] How to Use | Using shooting functions | Customizing the shooting functions for convenient use

## Function Menu Set.

---

You can assign the functions to be called up when you press the Fn (Function) button.

1. MENU →  (Custom Settings) → [Function Menu Set.] → set a function to the desired location.

The functions that can be assigned are displayed on the setup item selection screen.

---

[135] How to Use | Using shooting functions | Customizing the shooting functions for convenient use



# Custom Key Settings

---

Assigning functions to the various keys allows you to speed up operations by pressing the appropriate key when the shooting information screen is displayed.

1. MENU →  (Custom Settings) → [Custom Key Settings] → set a function to the desired key.

## Note

- Some functions cannot be assigned to certain keys.

---

[136] How to Use | Using shooting functions | Customizing the shooting functions for convenient use

## Function of the focus hold button

---

Allows you to assign a function to the focus hold button on the lens.

1. MENU →  (Custom Settings) → [Custom Key Settings] → [Focus Hold Button] → desired setting.

The functions that can be assigned are displayed on the setup item selection screen.

---

[137] How to Use | Using shooting functions | Customizing the shooting functions for convenient use

## Function of the AEL button

---

Once you assign a function to the AEL button, you can perform that function by simply pressing the AEL button when the shooting information screen is displayed.

1. MENU →  (Custom Settings) → [Custom Key Settings] → [AEL Button] → desired setting.

The functions that can be assigned are displayed on the setup item selection screen.

## Function of the AF/MF button

---

Once you assign a function to the AF/MF button, you can perform that function by simply pressing the AF/MF button when the shooting information screen is displayed.

1. MENU →  (Custom Settings) → [Custom Key Settings] → [AF/MF Button] → desired setting.

The functions that can be assigned are displayed on the setup item selection screen.

---

## Function of the ISO button

---

Once you assign a function to the ISO button, you can perform that function by simply pressing the ISO button when the shooting information screen is displayed.

1. MENU →  (Custom Settings) → [Custom Key Settings] → [ISO Button] → desired setting.

The functions that can be assigned are displayed on the setup item selection screen.

---

## Function of the Exposure Compensation button

---

Once you assign a function to the Exposure Compensation button, you can perform that function by simply pressing the Exposure Compensation button when the shooting information screen is displayed.

1. MENU →  (Custom Settings) → [Custom Key Settings] → [Exp. Comp. Button] → desired setting.

The functions that can be assigned are displayed on the setup item selection screen.

---

[141] How to Use | Using shooting functions | Customizing the shooting functions for convenient use

## Function of the WB button

---

Once you assign a function to the WB button, you can perform that function by simply pressing the WB button when the shooting information screen is displayed.

1. MENU →  (Custom Settings) → [Custom Key Settings] → [WB Button] → desired setting.

The functions that can be assigned are displayed on the setup item selection screen.

---

[142] How to Use | Using shooting functions | Customizing the shooting functions for convenient use

## Function of the Drive Mode button

---

Once you assign a function to the Drive Mode button, you can perform that function by simply pressing the Drive Mode button when the shooting information screen is displayed.

1. MENU →  (Custom Settings) → [Custom Key Settings] → [Drive Mode Button] → desired setting.

The functions that can be assigned are displayed on the setup item selection screen.



---

[143] How to Use | Using shooting functions | Customizing the shooting functions for convenient use

## Function of the Smart Teleconverter button

---

Once you assign a function to the Smart Teleconverter button, you can perform that function by simply pressing the Smart Teleconverter button when the shooting information screen is displayed.

1. MENU →  (Custom Settings) → [Custom Key Settings] →  (Smart Telecon.) button → desired setting.

The functions that can be assigned are displayed on the setup item selection screen.

---

[144] How to Use | Using shooting functions | Customizing the shooting functions for convenient use

## Function of the Preview Button

---

Once you assign a function to the preview button, you can perform that function by simply pressing the preview button when the shooting information screen is displayed.

1. MENU →  (Custom Settings) → [Custom Key Settings] → [Preview Button] → desired setting.

The functions that can be assigned are displayed on the setup item selection screen.

---

[145] How to Use | Using shooting functions | Customizing the shooting functions for convenient use

## Function of the C button

---

Once you assign a function to the C button, you can perform that function by simply pressing the C button when the shooting information screen is displayed.

1. MENU →  (Custom Settings) → [Custom Key Settings] → [C Button] → desired setting.

The functions that can be assigned are displayed on the setup item selection screen.

---

[146] How to Use | Using shooting functions | Customizing the shooting functions for convenient use

## Function of the center button

---

Once you assign a function to the center button, you can perform that function by simply pressing the center button when the shooting information screen is displayed.

1. MENU →  (Custom Settings) → [Custom Key Settings] → [Center Button] → desired setting.

The functions that can be assigned are displayed on the setup item selection screen.

---

[147] How to Use | Using shooting functions | Customizing the shooting functions for convenient use

## Dial Setup

---

You can switch the functions of the front/rear dial.

1. MENU →  (Custom Settings) → [Dial Setup] → desired setting.

### Menu item details

#### **SS** **F/no.:**

The front dial is used to change the shutter speed and the rear dial to change the aperture value.

#### **F/no.** **SS (default setting):**

The front dial is used to change the aperture value and the rear dial to change the shutter speed.

#### Note

- The [Dial Setup] function is enabled when the shooting mode is set to “M.”

---

[148] How to Use | Using shooting functions | Setting the other functions of this product

## Smile/Face Detect.

---

Detects the faces of your subjects and adjusts the focus, exposure, flash settings and performs image processing automatically.

1. MENU →  (Camera Settings) → [Smile/Face Detect.] → desired setting.

### Menu item details

 **Off:**

Does not use the Face Detection function.

 **On (Regist. Faces) (default setting):**

Detects the registered face with higher priority using [Face Registration].

 **On:**

Detects a face without giving higher priority to the registered face.

 **Smile Shutter:**

Automatically detects and shoots a smile.

## Face Detection frame

- When the product detects a face, the gray face detection frame appears. When the product determines that autofocus is enabled, the face detection frame turns white. When you press the shutter button halfway down, the frame turns green.
- In case you have registered the priority order for each face using [Face Registration], the product automatically selects the first prioritized face and the face detection frame over that face turns white. The face detection frames of other registered faces turn reddish-purple.



## Tips for capturing smiles more effectively

- Do not cover the eyes with front hair and keep the eyes narrowed.
- Do not obscure the face by a hat, masks, sunglasses, etc.
- Try to orient the face in front of the product and be as level as possible.
- Give a clear smile with an open mouth. The smile is easier to be detected when the teeth are shown.
- If you press the shutter button during Smile Shutter, the product shoots the image. After shooting, the product returns to Smile Shutter mode.

**Hint**

- When the [Smile/Face Detect.] is set to [Smile Shutter], you can select the Smile Detection Sensitivity from [On: Slight Smile], [On: Normal Smile] and [On: Big Smile].

**Note**

- You cannot use the Face Detection function with the following functions:
  - [Sweep Panorama]
  - [Picture Effect] is set to [Posterization].
  - When using the [Focus Magnifier] function.

- [Cont. Priority AE]
- [Scene Selection] is set to [Landscape], [Night Scene] or [Sunset].
- Up to eight faces of your subjects can be detected.
- The product may not detect faces at all or may accidentally detect other objects as faces in some conditions.
- If the product cannot detect a face, set the Smile Detection Sensitivity.
- If you track a face using [Lock-on AF] while executing [Smile Shutter], Smile Detection is performed only for that face.



---

[149] How to Use | Using shooting functions | Setting the other functions of this product

## Soft Skin Effect (still image)

---

Sets the effect used for shooting the skin smoothly in the Face Detection function.

1. MENU →  (Camera Settings) → [ Soft Skin Effect] → desired setting.

### Menu item details

#### **Off (default setting):**

Does not use the [ Soft Skin Effect] function.

#### **On:**

Uses the [ Soft Skin Effect].

#### **Hint**

- When [ Soft Skin Effect] is set to [On], you can select the effect level.

#### **Note**

- [ Soft Skin Effect] is not available for RAW images.

---

[150] How to Use | Using shooting functions | Setting the other functions of this product

## Face Registration (New Registration)

---

If you register faces in advance, the product can detect the registered face as a priority when [Smile/Face Detect.] is set to [On (Regist. Faces)].

1. MENU →  (Custom Settings) → [Face Registration] → [New Registration].
2. Align the guide frame with the face to be registered, and press the shutter button.

3. When a confirmation message appears, select [Enter].

#### Note

- Up to eight faces can be registered.
- Shoot the face from the front in a brightly lit place. The face may not be registered correctly if it is obscured by a hat, a mask, sunglasses, etc.

---

[151] How to Use | Using shooting functions | Setting the other functions of this product

## Face Registration (Order Exchanging)

---

When multiple faces are registered to be given priority, the face registered first will be given priority. You can change the priority order.

1. MENU →  (Custom Settings) → [Face Registration] → [Order Exchanging].
2. Select a face to change the order of priority.
3. Select the destination.

---

[152] How to Use | Using shooting functions | Setting the other functions of this product

## Face Registration (Delete)

---

Deletes a registered face.

1. MENU →  (Custom Settings) → [Face Registration] → [Delete].  
If you select [Delete All], you can delete all registered faces.

#### Note

- Even if you execute [Delete], the data for registered face will remain in the product. To delete the data for registered faces from the product, select [Delete All].

---

[153] How to Use | Using shooting functions | Setting the other functions of this product



# Red Eye Reduction

---

When using the flash, it is fired two or more times before shooting to reduce the red-eye phenomenon.

1. MENU →  (Camera Settings) → [Red Eye Reduction] → desired setting.

## Menu item details

### On:

The flash is always fired to reduce the red-eye phenomenon.

### Off (default setting):

Does not use Red Eye Reduction.

### Note

- Red Eye Reduction may not produce the desired effects. It depends on individual differences and conditions, such as distance to the subject, or whether the subject looks at the pre-strobe or not.



---

## [154] How to Use | Using shooting functions | Setting the other functions of this product Auto Obj. Framing (still image)

---

When this product detects and shoots faces, macro shooting subjects or subjects that are tracked by [Lock-on AF], the product automatically trims the image into an appropriate composition, and then saves it. Both the original and the trimmed images are saved. The trimmed image is recorded in the same size as the original image size.



1. MENU →  (Camera Settings) → [ Auto Obj. Framing] → desired setting.

## Menu item details



### Off (default setting):

Does not trim images.

## Auto:

Automatically trims images into an appropriate composition.

### Note

- The trimmed image may not be the best possible composition, depending on the shooting conditions.
- [ Auto Obj. Framing] cannot be set when [ Quality] is set to [RAW] or [RAW & JPEG].



---

[155] How to Use | Using shooting functions | Setting the other functions of this product

## SteadyShot (still image)

---

Sets whether or not to use the SteadyShot function.

1. MENU →  (Camera Settings) → [ SteadyShot] → desired setting.

### Menu item details

#### On (default setting):

Uses [ SteadyShot].

#### Off:

Does not use [ SteadyShot].

We recommend that you set the camera to [Off] when using a tripod.

---

[156] How to Use | Using shooting functions | Setting the other functions of this product

## Long Exposure NR (still image)

---

When you set the shutter speed to one second or longer (long exposure shooting), noise reduction is turned on for the duration that the shutter is open. With the function turned on, the grainy noise typical of long exposures is reduced.

1. MENU →  (Camera Settings) → [ Long Exposure NR] → desired setting.

### Menu item details

#### On (default setting):

Activates noise reduction for the same duration that the shutter is open. When noise

reduction is in progress, a message appears and you cannot take another picture. Select this to prioritize the image quality.

**Off:**



Does not activate noise reduction. Select this to prioritize the timing of shooting.

---

[157] How to Use | Using shooting functions | Setting the other functions of this product  
**High ISO NR (still image)**

---

When shooting with high ISO sensitivity, the product reduces noise that becomes more noticeable when the product sensitivity is high. A message may be displayed during noise reduction processing; you cannot shoot another image until the message disappears.

1. MENU →  (Camera Settings) → [ High ISO NR] → desired setting.

**Menu item details**

**Normal (default setting):**

Activates high ISO noise reduction normally.



**Low:**

Activates high ISO noise reduction moderately. Select this to prioritize the timing of shooting.

**Off:**

Does not activate high ISO noise reduction.

**Note**

- [ High ISO NR] is not available in the following situations:
  - When the shooting mode is set to [Intelligent Auto], [Superior Auto], [Scene Selection] or [Sweep Panorama].
- [ High ISO NR] is not available for RAW images.



---

[158] How to Use | Using shooting functions | Setting the other functions of this product  
**Color Space (still image)**

---

The way colors are represented using combinations of numbers or the range of color reproduction is called “color space.” You can change the color space depending on the

purpose of the image.

1. MENU →  (Camera Settings) → [ Color Space] → desired setting.

## Menu item details

### sRGB (default setting):

This is the standard color space of the digital camera. Use [sRGB] in normal shooting, such as when you intend to print out the images without any modification.

### AdobeRGB:

This color space has a wide range of color reproduction. When a large part of the subject is vivid green or red, Adobe RGB is effective. The file name of the image starts with “\_DSC.”

### Note

- [AdobeRGB] is for applications or printers that support color management and DCF2.0 option color space. Images may not be printed or viewed in the correct colors if you use applications or printers that do not support Adobe RGB.
- When displaying images that were recorded with [AdobeRGB] on this product or non-Adobe RGB-compliant devices, the images are displayed with low saturation.

---

[159] How to Use | Using shooting functions | Setting the other functions of this product

## Grid Line

---

Sets whether the grid line is displayed or not. The grid line will help you to adjust the composition of images.

1. MENU →  (Custom Settings) → [Grid Line] → desired setting.

## Menu item details

### Rule of 3rds Grid:

Place main subjects close to one of the grid lines that divide the image into thirds for a well-balanced composition.

### Square Grid:

Square grids make it easier to confirm the horizontal level of your composition. This is suitable to determine the quality of the composition when shooting landscape, close-up, or duplicated images.

### Diag. + Square Grid:

Place a subject on the diagonal line to express an uplifting and powerful feeling.

### Off (default setting):

Does not display the grid line.

---

[160] How to Use | Using shooting functions | Setting the other functions of this product

## Auto Review

---

You can check the recorded image on the screen right after the shooting. You can also set the display time for Auto Review.

1. MENU →  (Custom Settings) → [Auto Review] → desired setting.

### Menu item details

#### **10 Sec/5 Sec/2 Sec (default setting):**

Displays the recorded image on the screen right after shooting for the selected duration of time. If you perform a magnifying operation during Auto Review, you can check that image using the magnified scale.

#### **Off:**

Does not display the Auto Review.

#### **Note**

- When the product is enlarging an image using image processing, it may temporarily display the original image prior to enlarging and then display the enlarged image.
  - The DISP (Display Setting) settings are applied for the Auto Review display.
- 

[161] How to Use | Using shooting functions | Setting the other functions of this product

## Live View Display

---

Sets whether or not to show images altered with effects of the exposure compensation, white balance, [Creative Style], or [Picture Effect] on the screen.

1. MENU →  (Custom Settings) → [Live View Display] → desired setting.

### Menu item details

#### **Setting Effect ON (default setting):**

Displays Live View in conditions close to what your picture will look like as a result of applying all your settings. This setting is useful when you want to shoot pictures while

checking the results of the shot on the Live View screen.

### **Setting Effect OFF:**

Shows Live View without the effects of exposure compensation, white balance, [Creative Style], or [Picture Effect]. When this setting is used, you can easily check the image composition.

Live View is always displayed with the appropriate brightness even in [Manual Exposure] mode.

When [Setting Effect OFF] is selected, the **VIEW** icon is displayed on the Live View screen.

### **Note**

- When the shooting mode is set to [Intelligent Auto], [Superior Auto], [Sweep Panorama], [Movie] or [Scene Selection], [Live View Display] cannot be set to [Setting Effect OFF].
- When [Live View Display] is set to [Setting Effect ON], you may have difficulty checking the composition, as the Live View Display may seem too dark or too bright. If such a phenomenon occurs, set [Live View Display] to [Setting Effect OFF]. When [Live View Display] is set to [Setting Effect OFF], the brightness of the shot image will not be the same as that of the displayed Live View.

### **Hint**

- When you use a third-party flash, such as a studio flash, Live View Display may be dark for some shutter speed settings. When [Live View Display] is set to [Setting Effect OFF], Live View Display will be displayed brightly, so that you can easily check the composition.

---

[162] How to Use | Using shooting functions | Setting the other functions of this product

## FINDER/MONITOR

---

Sets the method for switching the display between Electronic Viewfinder and the screen.

1. MENU →  (Custom Settings) → [FINDER/MONITOR] → desired setting.

### **Menu item details**

#### **Auto (default setting):**

When you look into the Electronic Viewfinder, the display is switched to the Electronic Viewfinder automatically.

#### **Manual:**

The product does not switch between the monitor display and the Electronic Viewfinder display automatically.

You can switch the display by pressing the FINDER/MONITOR button.



### **Hint**

- If you want to switch the display mode temporarily when [FINDER/MONITOR] is set to [Auto], press the FINDER/MONITOR button.

---

## [163] How to Use | Using shooting functions | Setting the other functions of this product Release w/o Lens

---

Sets whether or not the shutter can be released when no lens is attached.

1. MENU →  (Custom Settings) → [Release w/o Lens] → desired setting.

### **Menu item details**

#### **Enable:**

Releases the shutter when no lens is attached. Select [Enable] when attaching the product to an astronomical telescope, etc.

#### **Disable (default setting):**

Does not release the shutter when a lens is not attached.

### **Note**



- Correct metering cannot be achieved when you use lenses that do not provide a lens contact, such as the lens of an astronomical telescope. In such cases, adjust the exposure manually by checking it on the recorded image.

---

## [164] How to Use | Using shooting functions | Setting the other functions of this product SteadyS. w/ shut.

---

Reduces the image blur not only at the moment of releasing the shutter but also while pressing the shutter button halfway down.

1. MENU →  (Custom Settings) → [ SteadyS. w/ shut.] → desired setting.

### **Menu item details**



#### **On (default setting) :**

Image blur is reduced while pressing the shutter button halfway down.

**Off:**

Image blur is not reduced while pressing the shutter button halfway down. If you want to save battery power, select [Off].

**Note**

- When [ SteadyShot] is set to [Off], [ SteadyS. w/ shut.] is not activated.

---

[165] How to Use | Using shooting functions | Setting the other functions of this product  
**e-Front Curtain Shut.**

---

The electronic front curtain shutter function shortens the time lag between shutter releases.

1. MENU →  (Custom Settings) → [e-Front Curtain Shut.] → desired setting.

**Menu item details****On (default setting):**

Uses the electronic front curtain shutter function.

**Off:**

Does not use the electronic front curtain shutter function.

**Note**

- When you shoot at high shutter speeds with a large diameter lens attached, the ghosting of a blurred area may occur, depending on the subject or shooting conditions. In such cases, set this function to [Off].
- When a lens made by another manufacturer (including a Minolta/Konica-Minolta lens) is used, set this function to [Off]. If you set this function to [On], the correct exposure will not be set or the image brightness will be uneven.

---

[166] How to Use | Using shooting functions | Setting the other functions of this product  
**Superior Auto (Image Extraction)**

---

Sets whether or not to save all the images that were shot continuously in [Superior Auto].

1. MENU →  (Custom Settings) → [Superior Auto] → [Image Extraction] → desired setting.



## Menu item details

### Auto (default setting):

Saves one appropriate image selected by the product.

### Off:

Saves all of the images.

### Note

- Even if you set [Image Extraction] to [Off] with [Hand-held Twilight] selected as the scene recognition mode, one combined image is saved.
- When the [ Auto Obj. Framing] function is activated, two images are saved even if you set [Image Extraction] to [Auto].

---

[167] How to Use | Using shooting functions | Setting the other functions of this product

## Superior Auto (Cont. Shooting)

---

Sets whether or not to perform continuous shooting in [Superior Auto] mode.

1. MENU →  (Custom Settings) → [Superior Auto] → [Cont. Shooting] → desired setting.

## Menu item details

### Auto (default setting):

Continuous shooting is performed.

### Off:

Continuous shooting is not performed.

---

[168] How to Use | Using shooting functions | Setting the other functions of this product

## Shading Comp.

---

Compensates for the shaded corners of the screen, caused by certain lens characteristics.

1. MENU →  (Custom Settings) → [Lens Comp.] → [Shading Comp.] → desired setting.

## Menu item details

### Auto (default setting):

Compensates for darker corners of the screen automatically.

### Off:

Does not compensate for darker corners of the screen.

### Note

- The [Shading Comp.] function is only available when an A-mount lens is mounted.
- The amount of light around the edges may not be corrected, depending on the lens type.

---

[169] How to Use | Using shooting functions | Setting the other functions of this product

## Chro. Aber. Comp.

---

Reduces the color deviation at the corners of the screen, caused by certain lens characteristics.

1. MENU →  (Custom Settings) → [Lens Comp.] → [Chro. Aber. Comp.] → desired setting.

## Menu item details

### Auto (default setting):

Reduces the color deviation automatically.

### Off:

Does not compensate for the color deviation.

### Note

- The [Chro. Aber. Comp.] function is only available when an A-mount lens is mounted.

---

[170] How to Use | Using shooting functions | Setting the other functions of this product

## Distortion Comp.

---

Compensates for the distortion of the screen, caused by certain lens characteristics.

1. MENU →  (Custom Settings) → [Lens Comp.] → [Distortion Comp.] → desired setting.

## Menu item details

### Auto:

Compensates for distortion of the screen automatically.

### Off (default setting):

Does not compensate for distortion of the screen.

### Note

- The [Distortion Comp.] function is only available when an A-mount lens is mounted.
- Depending on the attached lens, [Distortion Comp.] is fixed to [Auto], and you cannot select [Off].

---

[171] How to Use | Using shooting functions | Setting the other functions of this product

## Dial Lock

---

You can set whether the dial will be locked by pressing and holding the Fn (Function) button.

1. MENU →  (Custom Settings) → [Dial Lock] → desired setting.

## Menu item details

### Lock:

Locks the front and rear dials.

### Unlock (default setting):

The front or rear dials are not locked even if you press and hold the Fn (Function) button.

### Hint

- You can release the locked dial by holding the Fn (Function) button down.

---

[172] How to Use | Using shooting functions | Setting the other functions of this product

## Deactivate Monitor

---

When you press the key to which the [Deactivate Monitor] function is assigned, [Live View Display] is switched to [Setting Effect OFF], and the screen display is switched to [No Disp. Info.].

1. MENU → (Custom Settings) → [Custom Key Settings] → set the [Deactivate



Monitor] function to the desired key.

2. Press the key to which [Deactivate Monitor] was assigned.

#### Note

- Even if you perform [Deactivate Monitor], the backlight of monitor remains on. To turn off the backlight of monitor, press the FINDER/MONITOR button.

---

[173] How to Use | Using shooting functions | Setting the other functions of this product

## Aperture Preview

---

With the monitor or viewfinder, you may see an image with an aperture that differs from the shooting result. Since the blurring of a subject changes if the aperture is changed, the blurriness of the actual picture will differ from the image you were viewing prior to shooting. While you press and hold the key to which you assigned the [Aperture Preview] function, the aperture is stepped down to the set aperture value and you can check the blurriness prior to shooting.

1. MENU →  (Custom Settings) → [Custom Key Settings] → set the [Aperture Preview] function to the desired key.
2. Confirm the image by pressing the key to which [Aperture Preview] was assigned.

---

[174] How to Use | Using shooting functions | Setting the other functions of this product

## Shot. Result Preview

---

With the monitor or viewfinder, you may see an image with an aperture that differs from the shooting result. Since the blurring of a subject changes if the aperture is changed, the blurriness of the actual picture will differ from the image you were viewing prior to shooting. While pressing down the key to which [Shot. Result Preview] is assigned, you can check the image preview with the DRO, shutter speed, aperture and ISO sensitivity settings applied. Check the shooting result preview before shooting.

1. MENU →  (Custom Settings) → [Custom Key Settings] → set the [Shot. Result

Preview] function to the desired key.

2. Confirm the image by pressing the key to which [Shot. Result Preview] was assigned.

#### Hint

- The DRO settings, shutter speed, aperture and ISO sensitivity settings you have set are reflected on the image for [Shot. Result Preview], but some effects cannot be previewed depending on the shooting settings. Even in that case, the settings you have selected will be applied to the images you shoot.

---

[175] How to Use | Viewing | Viewing still images

## Playing back images

---

Plays back the recorded images.

1. Press the  (Playback) button to switch to the playback mode.
2. Select the image with the multi-selector.

#### Hint

- The product creates an image database file on a memory card to record and play back images. An image that is not registered in the image database file may not be played back correctly. To play back images shot using other devices, register those images to the image database file using MENU → [Setup] → [Recover Image DB].



---

[176] How to Use | Viewing | Viewing still images

## Playback zoom

---

Enlarges the image being played back.

1. Display the image you want to enlarge, and then press the  button.
  - If the image is too large, press the  button to adjust the zoom scale.
2. Select the portion you want to enlarge by pressing the top/bottom/right/left side of the multi-selector.

3. Press ● in the center of the multi-selector to exit the playback zoom.

#### Hint

- You can also enlarge an image being played back using MENU.

#### Note

- You cannot enlarge movies.

---

[177] How to Use | Viewing | Viewing still images

## Image Index

---

You can display multiple images at the same time in playback mode.

1. Press the  (Image Index) button while the image is being played back.

### To change the number of images to be displayed

MENU →  (Playback) → [Image Index] → desired setting.

## Menu item details

### 9 Images (default setting)/25 Images

### To return to single-image playback

Select the desired image and press ● on the center of the multi-selector.

### To display a desired image quickly

Select the bar on the left of the image index screen using the multi-selector, then press the top/bottom side of the multi-selector. While the bar is being selected, you can display the calendar screen or folder selection screen by pressing ● in the center. In addition, you can switch View Mode by selecting an icon.

---

[178] How to Use | Viewing | Viewing still images

## Switching the screen display (during playback)

---

Switches the screen display.

1. Press the DISP (Display Setting) button.

- The screen display switches in the order “Display Info. → Histogram → No Disp. Info. → Display Info.” each time you press the DISP button.
- The DISP (Display Setting) settings are applied for the Auto Review display.

### Note

- The histogram is not displayed in the following situations:
  - During movie playback
  - During scrolling playback of panoramic images
  - During slideshows
  - During Folder View (MP4)
  - During AVCHD View
  - During XAVC S View



---

[179] How to Use | Viewing | Deleting images

## Deleting a displayed image

---

You can delete an image displayed.

1. Display the image you want to delete.
2. Press the  (Delete) button.
3. Select [Delete] using the multi-selector, then press  on the center of the multi-selector.

---

[180] How to Use | Viewing | Deleting images

## Deleting multiple selected images

---





You can delete multiple selected images.

1. MENU →  (Playback) → [Delete] → desired setting.

### Menu item details

### Multiple Img.:

Deletes the selected images.

(1) Select the images to be deleted, then press  on the center of the multi-selector. The  mark is displayed in the check box. To cancel the selection, press  again to remove the  mark.

(2) To delete other images, repeat step (1).

(3) MENU → [OK] → Press  on the center.

### All in this Folder:

Deletes all images in the selected folder.

### All with this date:

Deletes all images in the selected date range.

#### Hint

- Perform [Format] to delete all images, including protected images.

#### Note

- The menu items that can be selected differ depending on the [View Mode] setting.



---

[181] How to Use | Viewing | Playing back movies

## Playing back movies







---

Plays back the recorded movies.





1. Press the  (playback) button to switch to playback mode.
2. Select the movie to be played back using the multi-selector.
3. To play back movies, press  on the center.

### Available operations during movie playback

You can perform slow playback and sound volume adjustment, etc. by pressing the bottom side of the multi-selector.

-  : Playback
-  : Pause
-  : Fast-forward
-  : Fast-rewind
-  : Forward slow playback
-  : Reverse slow playback
-  : Next movie file



-  : Previous movie file
-  : Displays the next frame
-  : Displays the previous frame
-  : Sound volume adjustment
-  : Closes the operation panel



#### Hint

- “Forward slow playback,” “Reverse slow playback,” “Displays the next frame” and “Displays the previous frame” are available during pause.

[182] How to Use | Viewing | Viewing panoramic images

## Playing back panoramic images

The product automatically scrolls a panoramic image from end to end.

1. Press the  (playback) button to switch to playback mode.
2. Select the panoramic image to be played back using the multi-selector.
3. Press  on the center to play back the image.

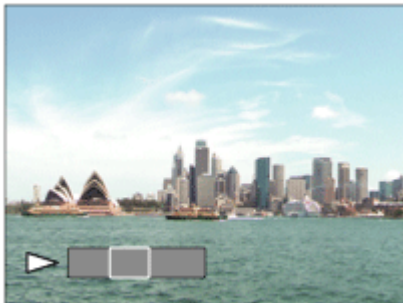

- To pause playback, press  on the center again.
- To return to the display of the entire image, press the MENU button.

#### Note

- Panoramic images shot using other products may be displayed in a different size from the actual size, or may not scroll correctly.

[183] How to Use | Viewing | Printing

## Specify Printing

---

You can specify in advance on the memory card which still images you want to print out later.





The **DPOF** (print order) icon will appear on the specified images. DPOF refers to “Digital Print Order Format.”

1. MENU →  (Playback) → [Specify Printing] → desired setting.

## Menu item details

### Multiple Img.:

Selects images to order printing.

(1) Select an image and press  on the center of the multi-selector. A  mark is displayed in the check box. To cancel the selection, press  and delete the  mark.

(2) Repeat step (1) to print other images.

(3) MENU → [OK] →  on the center.

### Cancel All:

Clears all DPOF marks.

### Print Setting:

You can set whether to print the date on images registered with DPOF marks.

Select [On] or [Off] → [Enter] in [Date Imprint].

### Note

- You cannot add the DPOF mark to the following files:
  - Movies
  - RAW images

---

[184] How to Use | Viewing | Using viewing functions

## View Mode

---

Sets the View Mode (image display method).

1. MENU →  (Playback) → [View Mode] → desired setting.

## Menu item details

### **Date View:**

Displays the images by date.

### **Folder View(Still):**

Displays only still images.

### **Folder View(MP4):**

Displays only MP4-format movies.

### **AVCHD View:**

Displays only AVCHD-format movies.

### **XAVC S View:**

Displays only XAVC S-format movies.

---

[185] How to Use | Viewing | Using viewing functions

## Display Rotation

---

Selects the orientation when playing back recorded still images.

1. MENU →  (Playback) → [Display Rotation] → desired setting.

### Menu items details

#### **Auto:**

The image is displayed according to the orientation information of the image. You can rotate the image using the rotation function. Even if the product is tilted, the display orientation is maintained.

#### **Manual:**

The image is displayed according to the orientation information of the image. You can rotate the image using the rotation function.

#### **Off:**

Always displays in landscape orientation.

---

[186] How to Use | Viewing | Using viewing functions

## Slide Show

---

Automatically plays back images continuously.

1. MENU →  (Playback) → [Slide Show] → desired setting.
2. Select [Enter].

### Menu item details

**Repeat:**

Select [On], in which images are played back in a continuous loop, or [Off] (default setting), in which the product exits the slideshow when all the images are played back once.

**Interval:**

Select the display interval for images from among [1 Sec], [3 Sec] (default setting), [5 Sec], [10 Sec] or [30 Sec].

**To quit the slideshow in the middle of playback**

Press the MENU button to quit the slideshow. You cannot pause the slideshow.

**Hint**

- You can activate a slideshow only when [View Mode] is set to [Date View] or [Folder View(Still)].

---

[187] How to Use | Viewing | Using viewing functions

## Rotate

---

Rotates a recorded still image counter-clockwise.

1. MENU →  (Playback) → [Rotate].

2. Press  on the center of the multi-selector.

The image is rotated counter-clockwise. The image rotates as you press  on the center. If you rotate the image once, the image remains rotated even after the product is turned off.

**Note**

- You cannot rotate the movies.
- You may not be able to rotate images shot using other products.
- When viewing rotated images on a computer, the images may be displayed in their original orientation depending on the software.

---

[188] How to Use | Viewing | Using viewing functions

## Protect

---

Protects recorded images against accidental erasure. The  mark is displayed on





protected images.

1. MENU →  (Playback) → [Protect] → desired setting.

## Menu item details

### Multiple Img.:

Applies or cancels the protection of the selected multiple images.

- (1) Select the image to be protected, then press  on the center of the multi-selector. The  mark is displayed in the check box. To cancel the selection, press  again to remove the  mark.
- (2) To protect other images, repeat step (1).
- (3) MENU → [OK] → Press  on the center.

### All in this Folder:

Protects all images in the selected folder.

### All with this date:

Protects all images in the selected date range.

### Cancel All in this Folder:

Cancels the protection of all images in the selected folder.

### Cancel All with this date:

Cancels the protection of all images in the selected date range.

### Note

- The menu items that can be selected differ depending on the [View Mode] setting.

---

[189] How to Use | Viewing | Using viewing functions

## 4K Still Image PB

---

Outputs still images in 4K resolution to an HDMI-connected TV that supports 4K.

1. Turn off this product and the TV.
2. Connect the HDMI micro terminal of this product to the HDMI jack of the TV using an HDMI cable (sold separately).

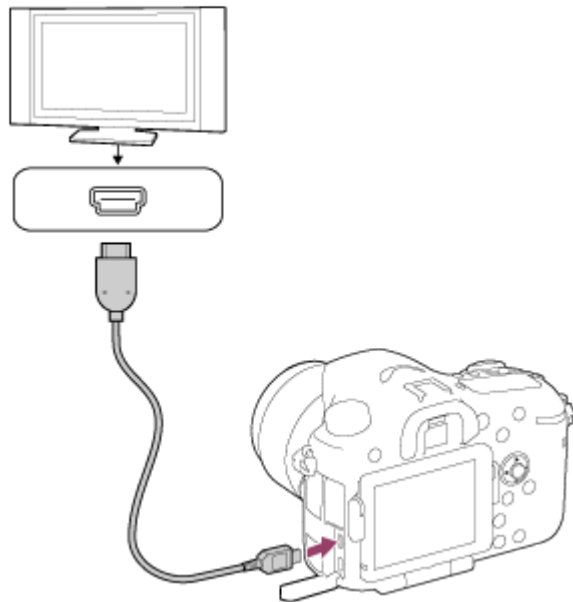

3. Turn on the TV and switch the input.
4. Turn on this product.
5. MENU →  (Playback) → [4K Still Image PB] → [OK].

#### Note

- This menu is only available with 4K-compatible TVs. For details, refer to the operating instructions of the TV.

---

[190] How to Use | Viewing | Viewing images on a TV

## Viewing images on an HD TV

---

To view images stored on this product using a TV, an HDMI cable (sold separately) and an HD TV equipped with an HDMI jack are required.

1. Turn off both this product and the TV.
2. Connect the HDMI micro terminal of this product to the HDMI jack of the TV using an HDMI cable (sold separately).

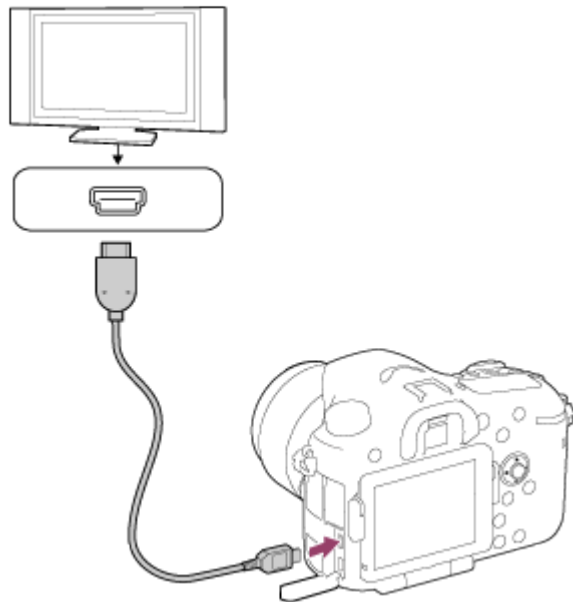

3. Turn on the TV and switch the input.
4. Turn on this product.  
Images shot with the product appear on the TV screen.

#### **Hint**

- This product is compatible with the PhotoTV HD standard. If you connect Sony PhotoTV HD-compatible devices using an HDMI cable (sold separately), the TV is set to the image quality suitable for viewing still images, and a whole new world of photos can be enjoyed in breathtaking high quality.
- The PhotoTV HD allows for a highly-detailed, photo-like expression of subtle textures and colors.
- For details, refer to the operating instructions supplied with the compatible TV.

#### **Note**

- Do not connect this product and another device using the output terminals of both. Doing so may cause a malfunction.
- Some devices may not work properly when connected to this product. For example, they may not output video or audio.
- Use an HDMI cable with the HDMI logo or a genuine Sony cable.
- Use an HDMI cable that is compatible with the HDMI micro terminal of the product and the HDMI jack of the TV.

---

[191] How to Use | Viewing | Viewing images on a TV

## Viewing images on a “BRAVIA” Sync-compatible TV

---

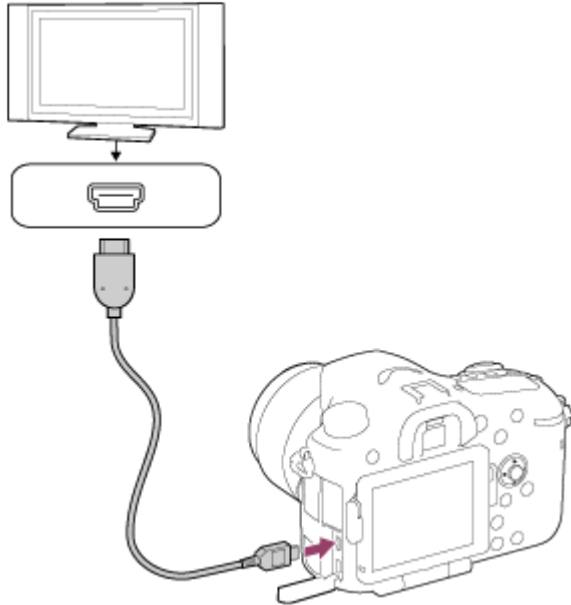

By connecting this product to a TV that supports “BRAVIA” Sync using an HDMI cable (sold separately), you can operate this product with the TV Remote Control.

1. Turn off both this product and the TV.
2. Connect the HDMI micro terminal of the product to the HDMI jack of the TV using an HDMI cable (sold separately).



3. Turn on the TV and switch the input.
4. Turn on this product.
5. MENU →  (Setup) → [HDMI Settings] → [CTRL FOR HDMI] → [On].
6. Press the SYNC MENU button on the TV Remote Control, and select the desired mode.

#### Note

- If the product is not in playback mode, press the  (Playback) button.
- Only TVs that support “BRAVIA” Sync can provide SYNC MENU operations. For details, refer to the operating instructions supplied with the TV.
- If the product performs unwanted operations in response to the TV Remote Control when the product is connected to another manufacturer’s TV using an HDMI connection, select MENU →  (Setup) → [HDMI Settings] → [CTRL FOR HDMI] → [Off].



You can adjust the brightness of the screen.

1. MENU →  (Setup) → [Monitor Brightness] → desired setting.

## Menu item details

### **Auto (default setting):**

Adjusts the brightness automatically.

### **Manual:**

Adjusts the brightness within the range of -2 to +2.

### **Sunny Weather:**

Sets the brightness appropriately for shooting outdoors.

### **Note**

- If you use the AC adaptor AC-PW10AM (sold separately) when [Monitor Brightness] is set to [Auto], the screen is always set to the brightest setting.
- The [Sunny Weather] setting is too bright for shooting indoors. Set [Monitor Brightness] to [Auto] or [Manual] for indoor shooting.
- Do not cover the light sensor with your hand, etc., when [Monitor Brightness] is set to [Auto] .

---

[193] How to Use | Changing settings | Setup menu

## Viewfinder Bright.

---

When using an electronic viewfinder, this product adjusts the brightness of the electronic viewfinder according to the surrounding environment.

1. MENU →  (Setup) → [Viewfinder Bright.] → desired setting.

## Menu item details

### **Auto (default setting):**

Adjusts the brightness of the electronic viewfinder automatically.

### **Manual:**

Selects the brightness of the electronic viewfinder from the range -2 to +2.

### **Note**

- When you use the AC adaptor AC-PW10AM (sold separately) when the setting is [Auto], the viewfinder is always set to the brightest setting.

---

[194] How to Use | Changing settings | Setup menu

## Finder Color Temp.

---

Adjusts the color temperature of the electronic viewfinder.

1. MENU →  (Setup) → [Finder Color Temp.] → desired setting.

### Menu item details

#### **-2 to +2:**

When you select “-,” the viewfinder screen changes to a warmer color, and when you select “+,” it changes to a colder color.

---

[195] How to Use | Changing settings | Setup menu

## Volume Settings

---

Adjusts the sound volume.

1. MENU →  (Setup) → [Volume Settings] → desired setting.

### Adjusting the volume during playback

Press the bottom of the multi-selector while playing back movies to display the operation panel, then adjust the volume. You can adjust the volume while listening to the actual sound.

---

[196] How to Use | Changing settings | Setup menu

## Audio signals

---

Selects whether the product produces a sound or not.

1. MENU →  (Setup) → [Audio signals] → desired setting.

### Menu item details

**On (default setting):**

Sounds are produced for example when the focus is achieved by pressing the shutter button halfway down.

**Off:**

Sounds are not produced.

---

[197] How to Use | Changing settings | Setup menu

## Upload Settings(Eye-Fi)

---

Sets whether to use the upload function when using an Eye-Fi card (commercially available). This item appears when an Eye-Fi card is inserted into the product's memory card slot.

1. MENU →  (Setup) → [Upload Settings] → desired setting.
2. Set your Wi-Fi network or destination on the Eye-Fi card.  
For details, refer to the manual supplied with the Eye-Fi card.
3. Insert the Eye-Fi card you have set up into the product, and shoot still images.  
Images are transferred to your computer, etc., automatically via the Wi-Fi network.

### Menu item details

**On (default setting):**

Enables the upload function.

**Off:**

Disables the upload function

**Communication status screen display**

: Standby. No images are to be sent.

: Upload standby.

: Connecting.

: Uploading.

: Error

**Note**

- Eye-Fi cards are only sold in certain countries/regions.
- For more information on Eye-Fi cards, please contact the manufacturer or vendor directly.
- Eye-Fi cards can be used only in the countries/regions where they were purchased. Use Eye-Fi cards in accordance with the law of the countries/regions where you purchased the card.
- Eye-Fi cards are equipped with a wireless LAN function. Do not insert an Eye-Fi card into

the product in locations in which their use is prohibited, such as on an airplane. When an Eye-Fi card is inserted into the product, set [Upload Settings] to [Off]. When the upload function is set to [Off], the  indicator will be displayed on the product.

- Power save mode will not function during uploading.
- If  (error) is displayed, remove the memory card and reinsert it, or turn the product off and then on again. If the indicator appears again, the Eye-Fi card may be damaged.
- Wireless LAN communication may be influenced by other communication devices. If the communication status is poor, move closer to the access point to be connected.
- This product does not support Eye-Fi “Endless Memory Mode.” Before using an Eye-Fi card, be sure that “Endless Memory Mode” is turned off.

---

[198] How to Use | Changing settings | Setup menu

## Tile Menu

---

Selects whether to always display the first screen of the menu when you press the MENU button.

1. MENU →  (Setup) → [Tile Menu] → desired setting.

### Menu item details

#### **On:**

Always displays the first screen of the menu (Tile Menu).

#### **Off (default setting):**

Deactivates the Tile Menu display.

---

[199] How to Use | Changing settings | Setup menu

## Mode Dial Guide

---

You can display the description of a shooting mode when you turn the mode dial and change the settings available for that shooting mode.

1. MENU →  (Setup) → [Mode Dial Guide] → desired setting.

### Menu item details

#### **On:**

Displays the Mode Dial Guide.

**Off (default setting):**

Does not display the Mode Dial Guide.

---

[200] How to Use | Changing settings | Setup menu

## Delete confirm.

---

You can set whether [Delete] or [Cancel] is selected as the default setting on the delete confirmation screen.

1. MENU →  (Setup) → [Delete confirm.] → desired setting.

### Menu item details

**"Delete" first:**

[Delete] is selected as the default setting.

**"Cancel" first (default setting):**

[Cancel] is selected as the default setting.

---

[201] How to Use | Changing settings | Setup menu

## Pwr Save Start Time

---

You can set time intervals to automatically switch to power save mode. To return to shooting mode, perform an operation such as pressing the shutter button halfway down.

1. MENU →  (Setup) → [Pwr Save Start Time] → desired setting.

### Menu item details

**30 Min/5 Min/2 Min/1 Min (default setting)/10 Sec**

**Note**

- Turn off the product when you do not use it for a long time.
  - The power save function is not activated during playing back slideshow or recording movies, or when connected to a computer.
-

## PAL/NTSC Selector

---

Plays back movies recorded with the product on a PAL/NTSC system TV.

1. MENU →  (Setup) → [PAL/NTSC Selector] → [Enter]

### Note

- This function is provided with 1080 50i-compatible devices only. It is not provided with 1080 60i-compatible devices. The 1080 50i-compatible devices have a “50i” mark on the bottom of the product.
- If you insert a memory card that has previously been formatted with the PAL system, a message telling you that you must re-format the card appears. When you record using the NTSC system, re-format the memory card or use another memory card.
- When the NTSC mode is selected, the “Running on NTSC.” message always appears on the start-up screen each time you turn the product on.

## Cleaning Mode

---

Allows you to clean the image sensor.

1. Confirm that the battery has been charged sufficiently.
2. MENU →  (Setup) → [Cleaning Mode] → [Enter]
3. Turn off the product following the instructions on the screen.
4. Detach the lens.
5. Push the mirror lock lever **(A)** and open the mirror.

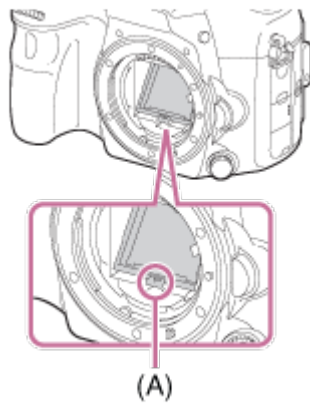

6. Use the blower to clean the image sensor surface and the surrounding area.
7. After you finish cleaning the image sensor, push down the mirror until it clicks.
  - Push down either side **(B)** of the mirror.

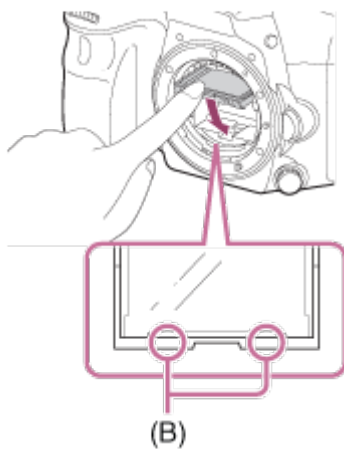

8. Attach the lens.
  - When you attach the lens, confirm that the mirror is completely pushed down.

### Note

- A blower is not supplied with this product. Use a commercially available blower.
- Cleaning can be performed only when the battery level is  (3 remaining battery icons) or more.
- Do not use a spray type blower as it may scatter water droplets inside the camera body.
- Do not put the tip of a blower into the cavity beyond the lens mount area, so that the tip of the blower does not touch the image sensor.
- Hold the camera slightly face downward so that the dust falls out.
- Do not subject the product to any shock during cleaning.
- When cleaning the image sensor with a blower, do not blow too hard. If you blow the sensor too hard, the inside of the product may be damaged.
- When you attach the lens after you finish cleaning the image sensor, confirm that the mirror has been completely pushed down. Otherwise, it may damage the lens or lead to a malfunction. Also, if the mirror has not been pushed down completely, the autofocus system will not be able to achieve proper focus.

- You cannot shoot with the mirror open.
- If the dust remains even after you cleaned the product as described, consult the service facility.

---

[204] How to Use | Changing settings | Setup menu

## Demo Mode

---

The [Demo Mode] function displays the movies recorded on the memory card automatically (demonstration), when the camera has not been operated for a certain time. Normally select [Off].

1. MENU →  (Setup) → [Demo Mode] → desired setting.

### Menu item details

#### **On:**

The movie playback demonstration starts automatically if the product is not operated for about one minute. Only protected AVCHD movies are played back.

Set the view mode to [AVCHD View], and protect the movie file with the oldest recorded date and time.

#### **Off (default setting):**

Does not show the demonstration.

#### **Note**

- You can set this item only when the product is powered by the AC-PW10AM AC Adaptor (sold separately).
- Even if [On] is selected, the product does not start a demonstration if there is no movie file on the memory card.
- When [On] is selected, the product does not switch to power save mode.

---

[205] How to Use | Changing settings | Setup menu

## Remote Ctrl

---

You can operate this product and shoot images using the SHUTTER button, 2SEC button (2 second delay shutter), and START/STOP button (or Movie button (RMT-DSLR2 only)) on the RMT-DSLR1 Wireless Remote Commander (sold separately) and RMT-DSLR2 (sold separately). Refer also to the operating instructions for the Wireless Remote Commander.



1. MENU →  (Setup) → [Remote Ctrl] → desired setting.

## Menu item details

### On:

Allows Wireless Remote Commander operation.

### Off (default setting):

Does not allow Wireless Remote Commander operation.

### Note

- The RMT-DSLR1 Wireless Remote Commander cannot be used for movie recording.
- The lens or lens hood may block the remote sensor that receive the signals. Use the Wireless Remote Commander in the position from which the signal can reach the product.
- When [Remote Ctrl] is set to [On], the product does not switch to power save mode. Set [Remote Ctrl] to [Off] after using a Wireless Remote Commander.

---

[206] How to Use | Changing settings | Setup menu

## HDMI Resolution

---

When you connect the product to a High Definition (HD) TV with HDMI terminals using an HDMI cable (sold separately), you can select HDMI Resolution to output images to the TV.

1. MENU →  (Setup) → [HDMI Settings] → [HDMI Resolution] → desired setting.

## Menu item details

### Auto (default setting):

The product automatically recognizes an HD TV and sets the output resolution.

### 1080p:

Outputs signals in HD picture quality (1080p).

### 1080i:

Outputs signals in HD picture quality (1080i).

### Note

- If the images are not displayed properly using the [Auto] setting, select either [1080i] or [1080p], based on which TV is to be connected.

---

[207] How to Use | Changing settings | Setup menu

# CTRL FOR HDMI

---

When connecting this product to a “BRAVIA” Sync-compatible TV using an HDMI cable (sold separately), you can operate this product by aiming the TV remote control at the TV.

1. MENU →  (Setup) → [HDMI Settings] → [CTRL FOR HDMI] → desired setting.

## Menu item details

### On (default setting):

You can operate this product with a TV’s remote control.

### Off:

You cannot operate this product with a TV’s remote control.

### Note

- [CTRL FOR HDMI] is available only with a “BRAVIA” Sync-compatible TV.

---

[208] How to Use | Changing settings | Setup menu

## HDMI Info. Display

---

Selects whether to display the shooting information when this product and the TV are connected using an HDMI cable (sold separately).

1. MENU →  (Setup) → [HDMI Settings] → [HDMI Info. Display] → desired setting.

## Menu item details

### On (default setting):

Displays the shooting information of the played back image.

### Off:

Does not display the shooting information of the played back image.

---

[209] How to Use | Changing settings | Setup menu

## USB Connection

---

Selects the appropriate USB connection method for each computer or USB device

connected to this product.

1. MENU →  (Setup) → [USB Connection] → desired setting.

## Menu item details

### **Auto (default setting):**

Establishes a Mass Storage or MTP connection automatically, depending on the computer or other USB devices to be connected. Windows 7 or Windows 8 computers are connected in MTP, and their unique functions are enabled for use.

### **Mass Storage:**

Establishes a Mass Storage connection between this product, a computer, and other USB devices.

### **MTP:**

Establishes an MTP connection between this product, a computer, and other USB devices. Windows 7 or Windows 8 computers are connected in MTP, and their unique functions are enabled for use.

### **PC Remote:**

Uses “Remote Camera Control” to control this product from the computer, including such functions as shooting and storing images on the computer.

### **Note**

- If Device Stage\* is not displayed with Windows 7 or Windows 8, set [USB Connection] to [Auto].
- \* Device Stage is a menu screen used to manage connected devices, such as a camera (Function of Windows 7 or Windows 8).

---

[210] How to Use | Changing settings | Setup menu

## USB LUN Setting

---

Enhances compatibility by limiting of USB connection functions.

1. MENU →  (Setup) → [USB LUN Setting] → desired setting.

## Menu item details

### **Multi (default setting):**

Normally, use [Multi].

### **Single:**

Set [USB LUN Setting] to [Single] only if you cannot make a connection.

## Language

---

Selects the language to be used in the menu items, warnings and messages.

1. MENU →  (Setup) → [ Language] → desired language.

## Date/Time Setup

---

Sets the date and time again.

1. MENU →  (Setup) → [Date/Time Setup] → desired setting.

### Menu item details

#### **Daylight Savings:**

Selects Daylight Savings [On]/[Off].

#### **Date/Time:**

Sets the date and time.

#### **Date Format:**

Selects the date and time display format.

## Area Setting

---

Sets the area where you are using the product.

1. MENU →  (Setup) → [Area Setting] → desired area.

## Format

---

Formats (initializes) the memory card. When you use a memory card with this product for the first time, it is recommended that you format the card using the product for stable performance of the memory card. Note that formatting permanently erases all data on the memory card, and is unrecoverable. Save valuable data on a computer, etc.

1. MENU →  (Setup) → [Format].

### Note

- Formatting permanently erases all data including even protected images.

## File Number

---

Selects how to assign file numbers to recorded still images and MP4 movies.

1. MENU →  (Setup) → [File Number] → desired setting.

### Menu item details

#### Series (default setting):

Even if you change the recording destination folder or change the memory card, the product continues to assign numbers to files in sequence.

(If there is a larger file number on the new memory card than the latest image file, a number one higher than the largest number is assigned.)

#### Reset:

The product resets numbers when a file is recorded in a new folder and assigns numbers to files starting with "0001."

(When the recording folder contains a file, a number one higher than the largest number is assigned.)

## Select REC Folder

---

You can change the folder on the memory card where still images and MP4 movies are to be recorded.

1. MENU →  (Setup) → [Select REC Folder] → desired folder.

#### Note

- You cannot select the folder when you select the [Date Form] setting.

---

[217] How to Use | Changing settings | Setup menu

## New Folder

---

Creates a new folder on the memory card for recording still images and MP4 movies. A new folder is created with a folder number one greater than the largest folder number currently used. Images are recorded in the newly created folder. A folder for still images and a folder for MP4 movies that have the same number are created at the same time.

1. MENU →  (Setup) → [New Folder].

#### Note

- When you insert a memory card that was used with other equipment into this product and shoot images, a new folder may be automatically created.
- Up to 4,000 images in total can be stored in one folder. When the folder capacity is exceeded, a new folder may be automatically created.

---

[218] How to Use | Changing settings | Setup menu

## Folder Name

---

Still images you shoot are recorded in a folder that is automatically created under the DCIM folder on the memory card. You can change the way folder names are assigned.

1. MENU →  (Setup) → [Folder Name] → desired setting.

## Menu item details

### **Standard Form (default setting):**

The folder name form is as follows: folder number + MSDCF.

Example: 100MSDCF

### **Date Form:**

The folder name form is as follows: folder number + Y (the last digit)/MM/DD.

Example: 10040405 (Folder number: 100, date: 04/05/2014)

### **Note**

- The MP4 movie folder form is fixed as “folder number + ANV01”.

---

[219] How to Use | Changing settings | Setup menu

## Recover Image DB

---

If image files were processed on a computer, problems may occur in the image database file. In such cases, the images on the memory card will not be played back on this product. If these problems happen, repair the file using [Recover Image DB].

1. MENU →  (Setup) → [Recover Image DB] → [Enter].

### **Note**

- Use a sufficiently charged battery pack. Low battery power during repairing can cause damage to data.

---

[220] How to Use | Changing settings | Setup menu

## Display Media Info.

---

Displays the recordable time of movies and the number of recordable still images for the inserted memory card.

1. MENU →  (Setup) → [Display Media Info.].

---

[221] How to Use | Changing settings | Setup menu

# Version

---

Displays the software version of this product and the lens.

1. MENU →  (Setup) → [Version].

---

[222] How to Use | Changing settings | Setup menu

## Certification Logo (Overseas model only)

---

Displays some of the certification logos for this product.

1. MENU →  (Setup) → [Certification Logo].

---

[223] How to Use | Changing settings | Setup menu

## Setting Reset

---

Resets the product to the default settings. Even if you perform [Setting Reset], the recorded images are retained.

1. MENU →  (Setup) → [Setting Reset] → desired setting.

### Menu item details

#### Camera Settings Reset:

Initializes the main shooting settings to the default settings.

#### Initialize:

Initializes all the settings to the default settings.

#### Note

- Be sure not to eject the battery pack while resetting.
- The value set with [AF Micro Adj.] will not be reset even when [Camera Settings Reset] or [Initialize] is performed.



## PlayMemories Mobile

---

To use [Ctrl w/ Smartphone] or [Send to Smartphone], etc., the application PlayMemories Mobile should be installed on your smartphone.

Download and install the application PlayMemories Mobile from your smartphone's application store. If PlayMemories Mobile is already installed on your smartphone, be sure to update it to the latest version.

For details on PlayMemories Mobile, refer to the support page (<http://www.sony.net/pmm/>).

---

## Connecting an Android smartphone to this product

---

1. Launch PlayMemories Mobile on your smartphone.
2. Select the model name of this product (DIRECT-xxxx: xxxx).



3. Input the password that is displayed on this product.



The smartphone is connected to the product.

---

[226] How to Use | Using Wi-Fi functions | Connecting this product and a Smartphone

## Connecting the product to an iPhone or iPad

---

1. Select the model name of this product (DIRECT-xxxx: xxxx) on the Wi-Fi setting screen of your iPhone or iPad.



2. Input the password displayed on this product.



The iPhone or iPad is connected to the product.

3. Confirm that your iPhone or iPad was connected to the “SSID” shown on this product.



4. Return to the “Home” screen and launch PlayMemories Mobile.

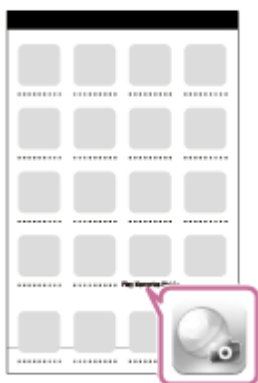

---

## [227] How to Use | Using Wi-Fi functions | Controlling this product using a Smartphone Ctrl w/ Smartphone

---

You can use a smartphone as the remote controller for this product, and shoot still images/movies. Still images/movies shot via remote control are sent to the smartphone from the product.

The application PlayMemories Mobile must be installed on your smartphone.

1. MENU →  (Wireless) → [Ctrl w/ Smartphone].
2. When the product is ready for the connection, an information screen appears on the product. Connect the smartphone and the product using that information.  
The setting procedure varies depending on your smartphone.

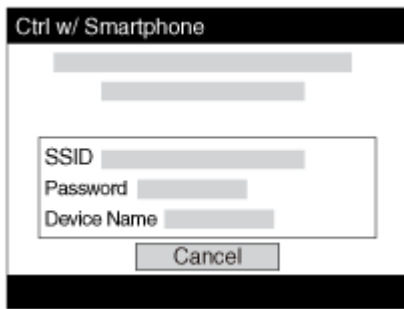

3. Check the composition of the image on the smartphone screen, and then press the shutter button **(A)** on the smartphone to shoot an image.
  - Use button **(B)** to change the [Flash] and [Self-Timer] settings. You can also change the image saving settings.

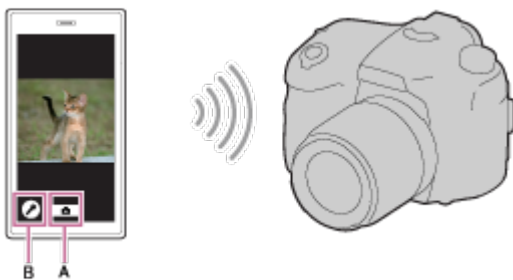

#### Note

- This product shares the connection information for [Ctrl w/ Smartphone] with a device that has permission to connect. If you want to change the device that is permitted to connect to the product, reset the connection information by following these steps. MENU →  (Wireless) → [SSID/PW Reset]. After resetting the connection information, you must register the smartphone again.
- Depending on future version upgrades, the operational procedures or screen displays are subject to change without notice.

---

## [228] How to Use | Using Wi-Fi functions | Controlling this product using a Smartphone One-touch connection with an NFC-enabled Android smartphone (NFC One-touch remote)

---

You can connect this product and an NFC-enabled Android smartphone with one touch, without performing a complex setup operation.

1. Activate the NFC function of the smartphone.
2. Switch this product to shooting mode.

- The NFC function is available only when the  (N mark) is displayed on the screen.

3. Touch the product to the smartphone.

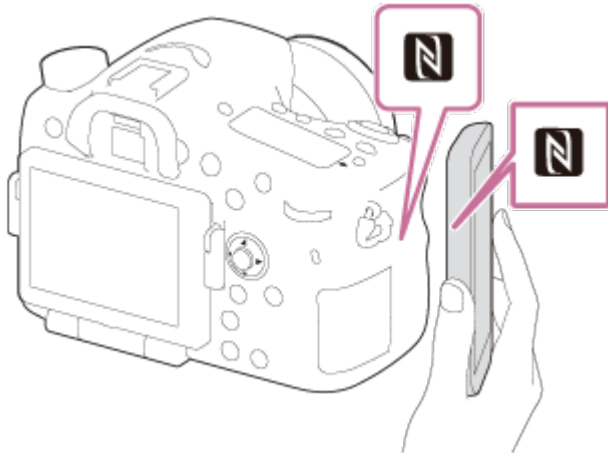

The smartphone and the product are connected, and PlayMemories Mobile launches on the smartphone.

- Touch the smartphone to the product for 1-2 seconds until PlayMemories Mobile launches.

### About “NFC”

NFC is a technology that enables short-range wireless communication between various devices, such as mobile phones or IC tags, etc. NFC makes data communication simpler with just a touch on the designated touch-point.



- NFC (Near Field Communication) is an international standard of short-range wireless communication technology.

#### Note

- If you cannot make a connection, do as the following:
  - Launch PlayMemories Mobile on your smartphone, and then move the smartphone slowly toward the  (N mark) of this product.
  - If the smartphone is in a case, remove it.
  - If the product is in a case, remove it.
  - Check whether the NFC function is activated on your smartphone.
- When [Airplane Mode] is set to [On], you cannot connect this product and the smartphone. Set [Airplane Mode] to [Off].
- If this product and the smartphone are connected when the product is in playback mode, the displayed image is sent to the smartphone.

---

You can transfer still images/movies to a smartphone and view them. The application PlayMemories Mobile must be installed on your smartphone.

1. MENU →  (Wireless) → [Send to Smartphone] → desired setting.
  - If you press the  (Send to Smartphone) button in playback mode, the setting screen for [Send to Smartphone] will appear.
2. If the product is ready for the transfer, the information screen appears on the product. Connect the smartphone and the product using that information.
  - The setting method for connecting the smartphone and the product varies depending on the smartphone.

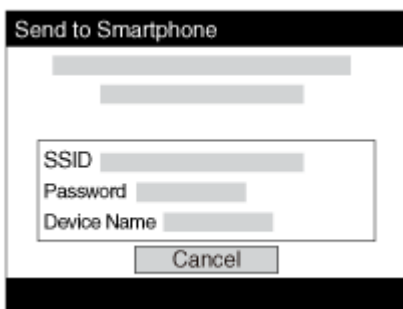

## Menu item details

### Select on This Device:

Selects an image on the product to be transferred to the smartphone.

(1) Select from among [This Image], [All Images on This Date] or [Multiple Images].

- The options displayed may differ depending on the View Mode selected on the camera.
- (2) If you select [Multiple Images], select the desired images using  on the multi-selector, then press MENU → [Enter].

### Select on Smartphone:

Displays all images recorded on the product's memory card on the smartphone.

### Note

- You can select an image size to be sent to the smartphone from [Original], [2M] or [VGA]. To change the image size, refer to the following steps.
  - For Android smartphone  
Start PlayMemories Mobile, and change the image size by [Settings] → [Copy Image Size].
  - For iPhone/iPad  
Select PlayMemories Mobile in the setting menu, and change the image size by [Copy Image Size].
- Some images may not be displayed on the smartphone depending on the recording format.
- RAW images are converted to JPEG format when they are sent.

- You cannot send XAVC S or AVCHD format movies.
- This product shares the connection information for [Send to Smartphone] with a device that has permission to connect. If you want to change the device that is permitted to connect to the product, reset the connection information by following these steps. MENU → [Wireless] → [SSID/PW Reset]. After resetting the connection information, you must register the smartphone again.
- When [Airplane Mode] is set to [On], you cannot connect this product and the smartphone. Set [Airplane Mode] to [Off].

---

[230] How to Use | Using Wi-Fi functions | Transferring images to a Smartphone

## Sending images to an Android smartphone (NFC One-touch Sharing)

---

With just one touch, you can connect this product and an NFC-enabled Android smartphone, and send an image displayed on the product screen directly to the smartphone. For movies, you can only transfer MP4 movies recorded with [  File Format] set to [MP4].

1. Activate the NFC function of the smartphone.
2. Display a single image on the product.
3. Touch the smartphone to the product.

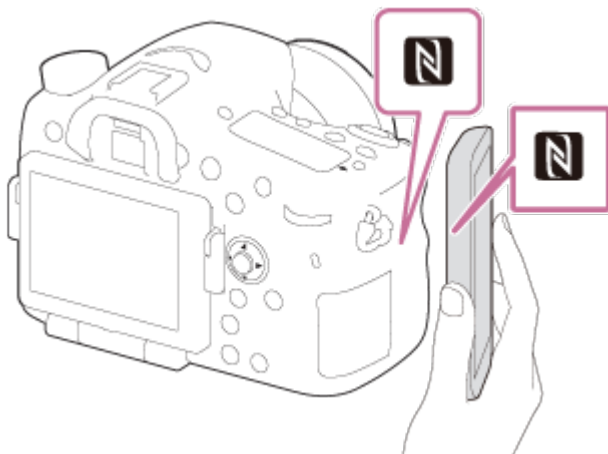

The product and the smartphone are connected, and PlayMemories Mobile automatically launches on the smartphone, and then the displayed image is sent to the smartphone.

- Before you touch the smartphone, cancel the sleep and lock-screen functions of the smartphone.
- The NFC function is available only when the  (N mark) is displayed on the product.
- Touch the smartphone to the product for 1-2 seconds until PlayMemories Mobile

launches.

- To transfer two or more images, select MENU →  (Wireless) → [Send to Smartphone] to select images. After the connection enabled screen appears, use NFC to connect the product and the smartphone.

## About “NFC”

NFC is a technology that enables short-range wireless communication between various devices, such as mobile phones or IC tags, etc. NFC makes data communication simpler with just a touch on the designated touch-point.

- NFC (Near Field Communication) is an international standard of short-range wireless communication technology.

### Note

- You can select an image size to be sent to the smartphone from [Original], [2M], or [VGA].  
To change the image size, refer to the following steps.
  - For Android smartphone  
Start PlayMemories Mobile, and change the image size by [Settings] → [Copy Image Size].
- RAW images are converted to JPEG format when they are sent.
- If the Image Index is displayed on the product, you cannot transfer images using the NFC function.
- If you cannot make a connection, perform the following:
  - Launch PlayMemories Mobile on your smartphone, and then move the smartphone slowly toward the  (N mark) of this product.
  - If the smartphone is in a case, remove it.
  - If the product is in a case, remove it.
  - Confirm that the NFC function is activated on the smartphone.
- When [Airplane Mode] is set to [On], you cannot connect the product and the smartphone. Set [Airplane Mode] to [Off].
- You cannot send AVCHD format movies.
- You cannot send XAVC S format movies.

---

[231] How to Use | Using Wi-Fi functions | Transferring images to a computer

## Send to Computer

---

You can transfer images stored in the product to a computer connected to a wireless access point or wireless broadband router and easily make backup copies using this operation. Before starting this operation, install PlayMemories Home on your computer and register the



access point on the product.

1. Start your computer.
2. MENU →  (Wireless) → [Send to Computer].

#### Note

- Depending on the application settings of your computer, the product will turn off after saving the images to your computer.
- You can transfer images from the product to only one computer at a time.
- If you want to transfer images to another computer, connect the product and the computer via a USB connection and follow the instructions in PlayMemories Home.



---

[232] How to Use | Using Wi-Fi functions | Transferring images to a TV

## View on TV

---

You can view images on a network-enabled TV by transferring them from the product without connecting the product and TV with a cable. For some TVs, you may need to perform operations on the TV. For details, refer to the operating instructions supplied with the TV.

1. MENU →  (Wireless) → [View on TV] → desired device to be connected.
2. When you want to play back images using slideshow, press  on the center of the multi-selector.

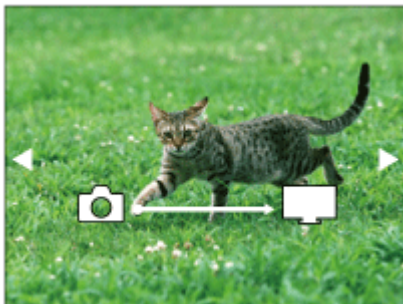

- To display the next/previous image manually, press the right/left side of the multi-selector.
- To change the device to be connected, press the bottom side of the multi-selector, then select [Device list].

## Slideshow settings

You can change the slideshow settings by pressing the bottom side of the multi-selector.

**Playback Selection:**

Selects the group of images to be shown.

**Folder View(Still):**

Selects from [All] and [All in Folder].

**Date View:**

Selects from [All] and [All in Date Rng.].

**Interval:**

Selects from [Short] and [Long].

**Effects\*:**

Select from [On] and [Off].

**Playback Image Size:**

Select from [HD] and [4K].

\*The settings are effective only for BRAVIA TV which is compatible with the functions.

**Note**

- You can use this function on a TV that supports DLNA renderer.
- You can view images on a Wi-Fi Direct-enabled TV or network-enabled TV (including cable TV).
- If you connect TV and this product and do not use Wi-Fi Direct, you need to register your access point first.
- Displaying the images on the TV may take time.
- Movies cannot be shown on a TV via Wi-Fi. Use an HDMI cable (sold separately).

---

[233] How to Use | Using Wi-Fi functions | Changing the settings of Wi-Fi functions

## Airplane Mode

---

When you board an airplane, etc., you can turn off all Wi-Fi functions temporarily.

1. MENU →  (Wireless) → [Airplane Mode] → desired setting.

If you set [Airplane Mode] to [On], an airplane mark will be displayed on the screen.

---

[234] How to Use | Using Wi-Fi functions | Changing the settings of Wi-Fi functions

## WPS Push

---

If your access point has the WPS button, you can register the access point to this product

easily by pushing the WPS button.

1. MENU →  (Wireless) → [WPS Push].
2. Press the WPS button on the access point you want to register.

#### Note

- [WPS Push] works only if the security setting of your access point is set to WPA or WPA2 and your access point supports the WPS button method. If the security setting is set to WEP or your access point does not support the WPS button method, perform [Access Point Set.].
- For details about the available functions and settings of your access point, see the access point operating instructions or contact the administrator of the access point.
- A connection may not be enabled depending on the surrounding conditions, such as the type of wall material or if there is an obstruction or poor wireless signal between the product and access point. If that happens, change the location of the product or move the product closer to the access point.

---

## [235] How to Use | Using Wi-Fi functions | Changing the settings of Wi-Fi functions

### Access Point Set.

---

You can register your access point manually. Before starting the procedure, check the SSID name of the access point, security system, and password. The password may be preset in some devices. For details, see the access point operating instructions, or consult the access point administrator.

1. MENU →  (Wireless) → [Access Point Set.].
2. Select the access point you want to register.

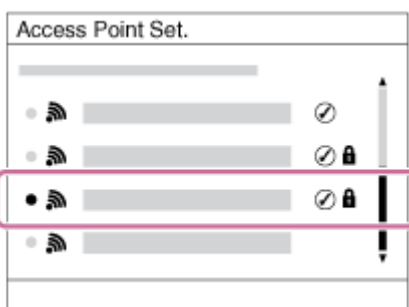

**When the desired access point is displayed on the screen:** Select the desired access point.

**When the desired access point is not displayed on the screen:** Select

[Manual Setting] and set the access point.

\*For the input method, refer to “How to use the keyboard.”

- If you select [Manual Setting], input the SSID name of the access point, then select the security system.

3. Input the password, and select [OK].

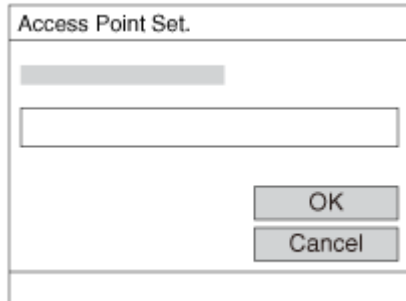

- Access points without the  mark do not require a password.

4. Select [OK].

## How to use the keyboard

When manual character entry is required, a keyboard is displayed on the screen.



1. **Input box** The characters you entered are displayed.
2. **Switch character types** Each time you press ● on the center of the multi-selector, the character type switches among alphabet letters, numerals and symbols.
3. **Keyboard** Each time you press ● on the center, the character that you enter will be displayed.

### For example: If you want to enter “abd”

Select the key for “abc” and press ● once to display “a” → select “➡” ((5) Move cursor) and press ● → select the key for “abc” and press ● twice to display “b” → select the key for “def” and press ● once to display “d”.

4. **Finalize** Finalizes the entered characters.
5. **Move cursor** Moves the cursor in the input box to the right or left.
6. **Delete** Deletes the character preceding the cursor.
7. **↑** Switches the next character to a capital or small letter.
8. **␣** Enters a space.

- To cancel the input, select [Cancel].

## Other setting items

Depending on the status or the setting method of your access point, you may want to set more items.

### **WPS PIN:**

Displays the PIN code you enter into the connected device.

### **Priority Connection:**

Select [On] or [Off].

### **IP Address Setting:**

Select [Auto] or [Manual].

### **IP Address:**

If you are entering the IP address manually, enter the set address.

### **Subnet Mask/Default Gateway:**

When you set [IP Address Setting] to [Manual], enter the IP address to match your network environment.

### **Note**

- To give the registered access point priority, set [Priority Connection] to [On].

---

[236] How to Use | Using Wi-Fi functions | Changing the settings of Wi-Fi functions

## Edit Device Name

---

You can change the device name under Wi-Fi Direct.

1. MENU →  (Wireless) → [Edit Device Name].
2. Select the input box, then input the device name → [OK].
  - For input method, refer to "[How to use the keyboard.](#)"

---

[237] How to Use | Using Wi-Fi functions | Changing the settings of Wi-Fi functions

## Disp MAC Address

---

Displays the MAC address of this product.

1. MENU → (Wireless) → [Disp MAC Address].



---

[238] How to Use | Using Wi-Fi functions | Changing the settings of Wi-Fi functions

## SSID/PW Reset

---

This product shares the connection information for [Send to Smartphone] and [Ctrl w/ Smartphone] with a device that has permission to connect. If you want to change the device that is permitted to connect, reset the connection information.

1. MENU →  (Wireless) → [SSID/PW Reset] → [OK].

### Note

- If you connect this product to the smartphone after resetting the connection information, you must register the smartphone again.

---

[239] How to Use | Using Wi-Fi functions | Changing the settings of Wi-Fi functions

## Reset Network Set.

---

Resets all the network settings to default settings.

1. MENU →  (Wireless) → [Reset Network Set.] → [OK].

---

[240] How to Use | Viewing on computers | Recommended computer environment

## Recommended computer environment

---

You can confirm the operating computer environment of the software from the following URL:

<http://www.sony.net/pcenv/>

---

## PlayMemories Home

---

With PlayMemories Home, you can do the following:

- You can import images shot with this product to your computer.
- You can play back the images imported to your computer.
- You can share your images using PlayMemories Online.

Also for Windows, you can do the following:

- You can organize images on the computer on a calendar by shooting date to view them.
- You can edit and correct images, such as by trimming and resizing.
- You can create a Blu-ray Disc, AVCHD disc or DVD-Video disc from AVCHD movies imported to a computer.

You cannot create discs from XAVC S format movies, although they can be imported to computers.

- You can upload images to a network service. (An internet connection is required.)
- For other details, please refer to the Help of PlayMemories Home.
- An Internet connection is required to use PlayMemories Online or other network services. PlayMemories Online or other network services may not be available in some countries or regions.

## Installing PlayMemories Home

---

1. Using the Internet browser on your computer, go to the following URL and install PlayMemories Home.

<http://www.sony.net/pm/>

- Proceed the installation by following the instructions on the screen.
- When installation is completed, PlayMemories Home starts up.
- If PMB (Picture Motion Browser) supplied with a product that was purchased before 2011 has already been installed on the computer, PMB will be overwritten by PlayMemories Home. Please use PlayMemories Home.

2. Connect the product and your computer using the supplied micro USB cable.

- New functions may be added to PlayMemories Home. Even if PlayMemories Home

has already been installed on your computer, connect this product and your computer again.

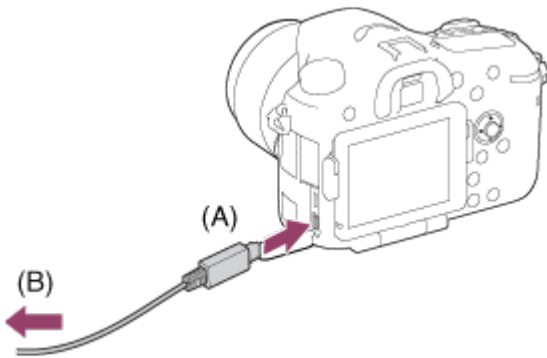

**A:** To the Multi/Micro USB Terminal

**B:** To the USB jack of the computer

#### Note

- Log on as Administrator.
- It may be necessary to restart your computer. When the restart confirmation message appears, restart the computer following the instructions on the screen.
- DirectX may be installed depending on your computer's system environment.

#### Hint

- For details on PlayMemories Home, refer to the Help of PlayMemories Home or the PlayMemories Home support page (<http://www.sony.co.jp/pmh-se/>) (English only).

---

[243] How to Use | Viewing on computers | Using the software

## Software for Mac computers

---

For details on software for Mac computers, access the following URL:

<http://www.sony.co.jp/imsoft/Mac/>

### Wireless Auto Import

“Wireless Auto Import” is required if you are using a Mac computer and want to import images to the computer using Wi-Fi function. Download “Wireless Auto Import” from the URL above, and install it on your Mac computer. For details, see Help for “Wireless Auto Import.”

#### Note

- The software that can be used varies depending on the region.



## Image Data Converter

---

With Image Data Converter, you can do the following:

- You can edit images recorded in RAW format with various corrections, such as tone curve and sharpness.
- You can adjust images with white balance, exposure, and [Creative Style], etc.
- You can save the still images displayed and edited on a computer.  
You can either save the still image as RAW format or save it in the general file format.
- You can display and compare the RAW images and JPEG images recorded by this product.
- You can rank images in five grades.
- You can apply color labels.

## Installing Image Data Converter

---

1. Download and install the software by accessing the following URL (English only).  
<http://www.sony.co.jp/ids-se/>

### Note

- Log on as Administrator.

## Accessing Image Data Converter Guide

---

### Windows:

[Start] → [All Programs] → [Image Data Converter] → [Help] → [Image Data Converter Ver.4].

- For Windows 8, start [Image Data Converter Ver.4], and select [Help] from the menu bar → [Image Data Converter Guide].

### Mac:

Finder → [Applications] → [Image Data Converter] → [Image Data Converter Ver.4], and

select [Help] from the menu bar → [Image Data Converter Guide].

- For details on operation, you can also refer to the “Image Data Converter” support page (English only).

<http://www.sony.co.jp/ids-se/>

---

[247] How to Use | Viewing on computers | Using the software

## Remote Camera Control

---

When using Remote Camera Control, the following operations are available on your computer.

- Changing this product’s settings and shooting.
- Recording images directly to the computer.
- Performing interval timer shooting.

Use these functions after selecting MENU →  (Setup) → [USB Connection] → [PC Remote]. For details on how to use Remote Camera Control, refer to the Help.

---

[248] How to Use | Viewing on computers | Using the software

## Installing Remote Camera Control

---

Download and install the software by accessing the following URL:

**Windows:**

<http://www.sony.co.jp/imsoft/Win/>

**Mac:**

<http://www.sony.co.jp/imsoft/Mac/>

---

[249] How to Use | Viewing on computers | Using the software

## Accessing the Help of Remote Camera Control

---

**Windows:**

[Start] → [All Programs] → [Remote Camera Control] → [Remote Camera Control Help].

- For Windows 8, start [Remote Camera Control], and right-click the title bar to select [Remote Camera Control Help].

**Mac:**

Finder → [Applications] → [Remote Camera Control], and select [Help] from the menu bar → [Remote Camera Control Help].

---

[250] How to Use | Viewing on computers | Connecting this product and a computer

## Connecting the product to a computer

---

1. Insert a sufficiently charged battery pack into the product, or connect it to a wall outlet (wall socket) using an AC Adaptor AC-PW10AM (sold separately).
2. Turn on the product and the computer.
3. Connect the product and your computer using the micro USB cable (supplied) **(A)** .

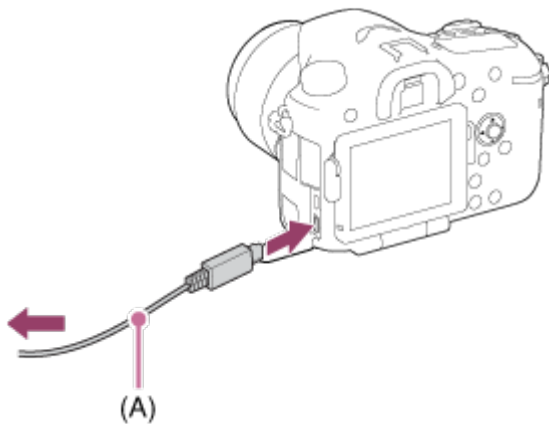

---

[251] How to Use | Viewing on computers | Connecting this product and a computer

## Importing images to the computer

---

PlayMemories Home allows you to easily import images. For details on PlayMemories Home functions, see the Help of PlayMemories Home.

### Importing images to the computer without using PlayMemories Home (For Windows)

When the AutoPlay Wizard appears after making a USB connection between this product and a computer, click [Open folder to view files] → [OK] → [DCIM] or [MP\_ROOT]. Then copy the desired images to the computer.

- If Device Stage appears on a Windows 7 or Windows 8 computer, double-click [Browse

Files] → media icon → folder in which the images you want to import are stored.

## Importing images to the computer without using PlayMemories Home (For Mac)

Connect the product to your Mac computer. Double-click the newly recognized icon on the desktop → the folder in which the image you want to import is stored. Then drag and drop the image file on to the hard disk icon.

### Note

- For operations such as importing AVCHD movies to the computer, use PlayMemories Home.
- Do not edit or otherwise process AVCHD movie files/folders from the connected computer. Movie files may be damaged or become unplayable. Do not delete or copy AVCHD movies on the memory card from the computer. Sony is not held liable for consequences resulting from such operations via the computer.

---

[252] How to Use | Viewing on computers | Connecting this product and a computer

## Disconnecting the product from the computer

Disconnects the USB connection between this product and the computer.

Perform the procedures from step 1 to 2 below before performing the following operations:

- Disconnecting the cable.
- Removing a memory card.
- Turning off the product.

1. Click  (Safely remove USB Mass Storage Device) on the taskbar.
2. Click the displayed message.

### Note

- For Mac computers, drag and drop the icon of the memory card or the drive icon in the “Trash” icon. The product is disconnected from the computer.
- For Windows 7/Windows 8 computers, the disconnect icon may not appear. In that case, you can skip steps 1 and 2 above.

---

[253] How to Use | Viewing on computers | Creating a movie disc

## Disc type



### **High-definition image quality (HD)**

A Blu-ray Disc enables you to record longer duration of high definition image quality (HD) movies than DVD discs.



### **High-definition image quality (HD) (AVCHD recording disc)**

High definition image quality (HD) movie can be recorded on DVD media, such as DVD-R discs, and a high definition image quality (HD) disc is created.

- You can play a high definition image quality (HD) disc on AVCHD format playback devices, such as a Sony Blu-ray Disc player and a PlayStation®3. You cannot play the disc on ordinary DVD players.



### **Standard definition image quality (STD)**

Standard definition image quality (STD) movie converted from high definition image quality (HD) movie can be recorded on DVD media, such as DVD-R discs, and a standard image quality (STD) disc is created.

#### **Hint**

You can use the following types of 12 cm discs with PlayMemories Home. For Blu-ray discs, see “Creating Blu-ray Discs”.

**DVD-R/DVD+R/DVD+R DL:** Non-rewritable

**DVD-RW/DVD+RW:** Rewritable

- Always maintain your “PlayStation 3” to use the latest version of the “PlayStation 3” system software.
- “PlayStation 3” may not be available in some countries/regions.

---

[254] How to Use | Viewing on computers | Creating a movie disc

## Selecting the disc creation method

---

You can create a disc from an AVCHD format movie recorded using this product. Depending on the disc type, playable devices may vary. Select a method suitable for your disc player. For details on creating a disc using PlayMemories Home, see the Help of PlayMemories

Home. (Only for Windows)



**Creates a disc with high-definition image quality (HD)**

Writable movie format: PS, FX, FH

Player: Blu-ray Disc playback devices (Sony Blu-ray Disc player, PlayStation®3, etc.)



**Creates a disc with high-definition image quality (HD) (AVCHD recording disc)**

Writable movie format: PS\*, FX\*, FH

Player: AVCHD format playback devices (Sony Blu-ray Disc player, PlayStation®3, etc.)



**Creates a disc with standard definition image quality (STD)**

Writable movie format: PS\*, FX\*, FH\*

Player: Ordinary DVD playback devices (DVD player, computer that can play back DVD discs, etc.)

\*You can create a disc with movies recorded in these formats using PlayMemories Home by down-converting the image quality.

---

[255] How to Use | Viewing on computers | Creating a movie disc

## Creating a disc with a device other than a computer

---

You can also create discs using a Blu-ray recorder, etc. Depending on which device you use, the types of disc that can be created vary.

**Blu-ray recorder:**



High-definition image quality (HD)





Standard definition image quality (STD)

**HDD recorder, etc.:**



Standard definition image quality (STD)

#### Note

- When creating AVCHD discs using PlayMemories Home from movies recorded with the [  Record Setting] of [60p 28M(PS)]/[50p 28M(PS)], [60i 24M(FX)]/[50i 24M(FX)] or [24p 24M(FX)]/[25p 24M(FX)], the image quality is converted and it is not possible to create discs that have the original image quality. Converting the image quality takes time. To record movies with the original image quality, use Blu-ray Discs.
- To create a Blu-ray Disc from movies recorded in [60p 28M(PS)]/[50p 28M(PS)], you need to use a device that is compliant with AVCHD format Ver. 2.0. The created Blu-ray Disc can be played back only on a device that is compliant with AVCHD format Ver. 2.0.
- For details on how to create a disc, refer to the operating instructions of the device you use.
- Movies recorded with [  File Format] set to [XAVC S] cannot be copied to discs.

---

[256] How to Use | Viewing on computers | Creating a movie disc

## Creating Blu-ray Discs

---

You can create Blu-ray Discs from AVCHD movies imported to a computer. The computer must be capable of creating Blu-ray Discs. BD-R (not re-writable) or BD-RE (rewritable) discs can be used. Multi-session recordings cannot be made. To create Blu-ray Discs using PlayMemories Home, be sure to install the dedicated add-on software. For details, see the following URL:

<http://support.d-imaging.sony.co.jp/BDUW/>

To install, your computer must be connected to the Internet. For detailed operations, see the Help of PlayMemories Home.

#### Note

- To play back a Blu-ray Disc that was created using movies recorded in [60p 28M(PS)]/[50p 28M(PS)], you must use a device that is compliant with AVCHD format Ver. 2.0.

---

[257] How to Use | Precautions/This product | Precautions

## Precautions

---

## **Backing up memory cards**

Data may be corrupted in the following cases. Be sure to back up the data for protection.

- When the memory card is removed or the product is turned off during a read or write operation.
- When the memory card is used in locations subject to static electricity or electrical noise.

## **Creating an image database file**

If you insert a memory card that does not contain an image database file into the product and turn on the power, the product automatically creates an image database file using some of the memory card's capacity. The process may take a long time and you cannot operate the product until the process is completed.

If a database file error occurs, export all images to your computer using PlayMemories Home, and then format the memory card using this product.

## **Do not use/store the product in the following places**

- In an extremely hot, cold or humid place  
In places such as in a car parked in the sun, the camera body may become deformed and this may cause a malfunction.
- Storing under direct sunlight or near a heater  
The camera body may become discolored or deformed, and this may cause a malfunction.
- In a location subject to rocking vibration
- Near strong magnetic place
- In sandy or dusty places  
Be careful not to let sand or dust get into the product. This may cause the product to malfunction, and in some cases this malfunction cannot be repaired.

## **On operating temperatures**

Your product is designed for use under the temperatures between 0°C and 40 °C (32 °F and 104 °F). Shooting in extremely cold or hot places that exceed this range is not recommended.

## **On moisture condensation**

- If the product is brought directly from a cold to a warm location, moisture may condense inside or outside the product. This moisture condensation may cause a malfunction of the product.
- To prevent moisture condensation when you bring the product directly from a cold to a warm location, first put it in a plastic bag and seal it to prevent air from entering. Wait for about an hour until the temperature of the product has reached the ambient temperature.
- If moisture condensation occurs, turn off the product and wait about an hour for the



moisture to evaporate. Note that if you attempt to shoot with moisture remaining inside the lens, you will be unable to record clear images.

## **On the functions available with the product**

This manual describes the functions of 1080 60i-compatible devices and 1080 50i-compatible devices. To check whether this product is a 1080 60i-compatible device or 1080 50i-compatible device, look for the following marks on the bottom of the product.

- 1080 60i-compatible device: 60i
- 1080 50i-compatible device: 50i

## **Notes for when on board an airplane**

- In an airplane, set [Airplane Mode] to [On].

## **On image data compatibility**

This product conforms with DCF (Design rule for Camera File system) universal standard established by JEITA (Japan Electronics and Information Technology Industries Association).

- Playback of images recorded with your product on other equipment and playback of images recorded or edited with other equipment on your product are not guaranteed.

## **Notes on playing movies on other devices**

- This product uses MPEG-4 AVC/H.264 High Profile for AVCHD format recording. For this reason, movies recorded in AVCHD format with this product cannot be played by the following devices.
  - Other devices compatible with AVCHD format that does not support High Profile
  - Devices incompatible with the AVCHD format

This product also uses MPEG-4 AVC/H.264 Main Profile for MP4 format recording. For this reason, play back movies recorded in MP4 format with this product on MPEG-4 AVC/H.264 supported devices.

- Discs recorded with HD (high definition) image quality can be played back only on AVCHD format-compatible devices.

DVD-based players or recorders cannot play back HD image quality discs, as they are incompatible with the AVCHD format. Also, DVD-based players or recorders may fail to eject HD image quality discs that are recorded using the AVCHD format.

## **On the monitor and lens**

- The monitor is manufactured using extremely high-precision technology so over 99.99 % of the pixels are operational for effective use. However, there may be some tiny black points and/or bright points (white, red, blue or green in color) that constantly appear on the monitor. These points are normal in the manufacturing process and do not affect the

images in any way.

- Exposing the monitor or lens to direct sunlight for long periods may cause a malfunction. Exercise caution when placing the product near a window or outdoors.
- Do not press against the monitor. The monitor may be discolored and that may cause a malfunction.
- Images may trail across on the monitor in a cold location. This is not a malfunction.
- If the monitor has drops of water or other liquids on it, wipe it with a soft cloth. If the monitor stays wet, the surface of the monitor may change or deteriorate. This may cause a malfunction.
- Make sure not to bump the lens or subject it to force.

## **Notes on the flash**

- Do not cover the flash with your fingers.
- Do not carry the product by the flash unit, or use excessive strength on it.
- If water, dust or sand get into the open flash unit, it may cause a malfunction.

## **Notes on discarding or transferring this product to others**

When discarding or transferring this product to others, make sure to perform the following operation to protect private information.

- Perform [Setting Reset] to reset all the settings.

---

[258] How to Use | Precautions/This product | Precautions

## **On the internal rechargeable battery**

---

This camera has an internal rechargeable battery for maintaining the date and time and other settings regardless of whether the power is on or off, or whether the battery pack is charged or discharged. This rechargeable battery is continually charged as long as you are using the product. However, if you use the product for only short periods, it gradually discharges. If you do not use the product at all for about 2 month(s) it becomes completely discharged. In this case, be sure to charge this rechargeable battery before using the product. However, even if this rechargeable battery is not charged, you can still use the product as long as you do not record the date and time.

## **Charging method of the internal rechargeable battery**

Insert a charged battery pack into the product, or connect the product to a wall outlet (wall socket) using the AC Adaptor (sold separately), and leave the product for 24 hours or more with the power off.

## Battery pack and battery charger

---

### Charging the battery pack

- The charging time differs depending on the remaining battery charge and the charging conditions.
- We recommend charging the battery pack at an ambient temperature of between 10°C to 30°C (50°F to 86°F). The battery pack may not charge efficiently outside this temperature range.
- Connect the battery charger to the nearest wall outlet (wall socket).
- Do not recharge a battery pack that has just been charged or is nearly fully-charged before using it. Doing so affects the battery performance.
- Do not use the battery charger (supplied) to charge other battery packs other than those in the InfoLITHIUM "M" series. Charging other battery packs than the specified type may cause battery leakage, excessive heat, explosion, or electric shocks and may lead to burns or injuries.
- If the CHARGE lamp flashes, the battery may be malfunctioning, or a battery pack of another type than the specified one may have been inserted. Make sure the battery pack is correct. If the battery pack is of the specified type, remove the battery pack and insert a different battery pack, and check whether the battery charger operates correctly. If the battery charger operates correctly, the first battery pack may be malfunctioning.
- If the battery pack is dirty, the battery pack may not charge correctly. Wipe off the dirt with a dry cloth.

### Notes on using the battery pack

- Use the battery pack NP-FM500H. You cannot use NP-FM55H, NP-FM50, or NP-FM30 with this camera.
- The remaining battery indicator may not provide an accurate reading depending on the battery usage or environment.
- The battery pack is not waterproof. Be careful not to get the battery pack wet.
- Do not leave the battery pack in locations with high temperatures, such as in a car or under a blazing sun.

### Using the battery pack efficiently

- When the ambient temperature is low, the battery performance is degraded and the operating length of the battery decreases. In addition, the speed of continuous shooting decreases. We recommend that you warm the battery pack, for example in your pocket, and insert it into the camera right before you start shooting.

- If you use the flash often, shoot images continuously, turn the camera on and off frequently, or use a brighter setting for the screen, the battery life will decrease.

## Battery life

- The battery life is limited. If you use the same battery pack repeatedly, or use the same battery pack for a long period, the battery capacity decreases gradually. If the available time of the battery pack shortens significantly, it is probably time to replace the battery pack with a new one.
- The battery life varies between different battery packs, and according to how the battery pack is stored and the operating conditions and environment in which it is used.

## Storing the battery pack

- To maintain the battery pack's function, charge the battery pack and then fully discharge it in the camera at least once a year before storing it. Then remove the battery pack and store in a cool, dry place.

---

[260] How to Use | Precautions/This product | Precautions

## Memory card

---

### Memory card

Card Type Indications in Help Guide

#### Memory Stick PRO Duo media

(Memory Stick XC-HG Duo media/Memory Stick PRO Duo media/Memory Stick PRO-HG Duo media)

#### SD card

(SD memory card/SDHC memory card/SDXC memory card)

- Memory Stick PRO Duo media and SD cards up to 64 GB have been tested and proven to operate with this product.
- When recording movies, the following memory cards are recommended:
  - **MEMORY STICK PRO DUO** (Mark2) (Memory Stick PRO Duo media (Mark2))
  - **MEMORY STICK XC-HG DUO** (Memory Stick XC-HG Duo media)
  - **MEMORY STICK PRO-HG DUO** (Memory Stick PRO-HG Duo media)
  - Class 4 SD card or faster
- When recording XAVC S format movies, use the following memory cards:
  - SDXC memory card with a capacity of at least 64 GB (Class 10 or faster)
  - UHS-I compatible SDXC memory card with a capacity of at least 64 GB
  - Memory Stick XC-HG Duo media

- This product supports UHS-I-compatible SD cards.

### Note

- When you use a memory card with this product for the first time, it is recommended that you format the card using the product for stable performance of the memory card before shooting.  
Note that formatting permanently erases all data on the memory card, and is unrecoverable. Save precious data on a computer, etc.
- If you repeatedly shoot and delete images for a long time, fragmentation of data in a file in the memory card may occur, and movie recording may be interrupted in the middle of shooting. If this happens, save your images to a computer or other storage location, then execute [Format].
- Memory card formatted with a computer is not guaranteed to operate with the product.
- Data read/write speeds differ depending on the combination of the memory card and the equipment used.
- We recommend backing up important data, such as to a hard disk of a computer.
- Do not attach a label on the memory card itself nor on a memory card adaptor.
- Do not touch the terminal section of the memory card with your hand or a metal object.
- Do not strike, bend or drop the memory card.
- Do not disassemble or modify the memory card.
- Do not expose the memory card to water.
- Do not leave the memory card within the reach of small children. They might accidentally swallow it.
- The memory card may be hot just after it has been used for a long time. Be careful when you handle it.
- Do not insert a memory card that does not fit the memory card slot. Doing so will cause a malfunction.
- Do not use or store the memory card under the following conditions:
  - High temperature locations such as in a car parked under the sun
  - Locations exposed to direct sunlight
  - Humid locations or locations with corrosive substances present
- Images recorded on a Memory Stick XC-HG Duo media and SDXC memory card cannot be imported to or played on computers or AV devices that are not compatible with exFAT when connected using a micro USB cable. Make sure that the device is compatible with exFAT before connecting it to the product. If you connect your product to an incompatible device, you may be prompted to format the card. Never format the card in response to this prompt, as doing so will erase all data on the card. (exFAT is the file system used on Memory Stick XC-HG Duo media and SDXC memory cards.)

## Memory Stick media

The types of Memory Stick media that can be used with the product are as follows. However, proper operation cannot be guaranteed for all Memory Stick media functions.

- **Memory Stick PRO Duo media:** \*1\*2\*3

**Memory Stick PRO-HG Duo media: \*1\*2**

- **Memory Stick XC-HG Duo media: \*1\*2**

\*1 This Memory Stick is equipped with MagicGate function. MagicGate is copyright protection technology that uses encryption technology. Data recording/playback that requires MagicGate functions cannot be performed with this product.

\*2 High-speed data transfer using a parallel interface is supported.

\*3 When recording movies, only media marked with Mark2 can be used.

## **Notes on using Memory Stick Micro media (sold separately)**

- This product is compatible with Memory Stick Micro media (M2). M2 is an abbreviation for Memory Stick Micro media.
- To use a Memory Stick Micro media with this product, be sure to insert the Memory Stick Micro media into an M2 Adaptor as large as Duo size. If you insert a Memory Stick Micro media into the product without an M2 Adaptor as large as Duo size, you might not be able to remove it from the product.
- Do not leave the Memory Stick Micro media within the reach of small children. They might accidentally swallow it.

---

[261] How to Use | Precautions/This product | Cleaning this product

## **On cleaning**

---

### **Cleaning the lens and flash**

Wipe the lens and flash with a soft cloth to remove fingerprints, dust, etc.

#### **Cleaning the lens**

- Do not use a cleaning solution containing organic solvents, such as thinner, or benzene.
- When cleaning the lens surface, remove dust with a commercially available blower. In case of dust that sticks to the surface, wipe it off with a soft cloth or tissue paper slightly moistened with lens cleaning solution. Wipe in a spiral pattern from the center to the outside. Do not spray lens cleaning solution directly onto the lens surface.

#### **Cleaning the flash**

Clean the flash surface before use. The heat of the flash emission may cause dirt on the flash surface to start smoking or burning. Wipe the flash surface with a soft cloth to remove dirt or dust, etc.

#### **Cleaning the camera body**

Do not touch the parts of the product inside the lens mount, such as a lens signal contact. To clean inside the lens mount, use a commercially available blower\* to blow any dust off.

\*Do not use a spray-type blower as doing so may cause a malfunction.

## Cleaning the product surface

Clean the product surface with a soft cloth slightly moistened with water, then wipe the surface with a dry cloth. To prevent damage to the finish or casing:

- Do not expose the product to chemical products such as thinner, benzene, alcohol, disposable cloths, insect repellent, sunscreen or insecticide.
- Do not touch the product with any of the above on your hand.
- Do not leave the product in contact with rubber or vinyl for a long time.

## Cleaning the monitor

- If oil from your hand or hand cream, etc., remain on the monitor, the original coating may become easily removable. Wipe oil or hand cream off as soon as possible.
- If you wipe the monitor firmly using tissue paper, etc., the coating may be scratched.
- If the monitor becomes dirty with fingerprints or dust, gently remove the dust from the surface, and then clean the monitor using soft cloth, etc.

---

[262] How to Use | Precautions/This product | Number of recordable still images and recordable time of movies

## Number of still images

---

The number of still images may vary depending on the shooting conditions and the memory card.

[ Image Size]: [L: 24M]

When [ Aspect Ratio] is set to [3:2]\*

### **Standard**

2GB: 330 images

4GB: 660 images

8GB: 1350 images

16GB: 2700 images

32GB: 5400 images

64GB: 10500 images

### **Fine**

2GB: 200 images

4GB: 410 images

8GB: 820 images

16GB: 1650 images

32GB: 3300 images

64GB: 6600 images

### **Extra fine**

2GB: 100 images

4GB: 200 images

8GB: 400 images

16GB: 820 images

32GB: 1600 images

64GB: 3250 images

### **RAW & JPEG**

2GB: 54 images

4GB: 105 images

8GB: 220 images

16GB: 440 images

32GB: 880 images

64GB: 1750 images

### **RAW**

2GB: 74 images



4GB: 145 images

8GB: 300 images

16GB: 600 images

32GB: 1200 images

64GB: 2400 images

\*When the [ Aspect Ratio] is set to other than [3:2], you can record more pictures than shown above. (Except when [ Quality] is set to [RAW].)

### **Note**

- Even if the number of remaining shootable images is greater than 9,999, the “9999” indicator appears.
- When an image shot with other products is played back on this product, the image may not appear in the actual image size.

---

[263] How to Use | Precautions/This product | Number of recordable still images and recordable time of movies

## Recordable time of movies

---

The table below shows the approximate maximum recording times which can be recorded on the memory card that is formatted with this product. These numbers are the total times of all



movie files on the memory card. The recordable time may vary depending on the shooting conditions and the memory card.

(h (hour), m (minute))

## **[ File Format]:[XAVC S]**

### **60p 50M**

### **50p 50M**

2GB: -

4GB: -

8GB: -

16GB: -

32GB: -

64GB: 2 h 35 m

### **30p 50M**

### **25p 50M**

2GB: -

4GB: -

8GB: -

16GB: -

32GB: -

64GB: 2 h 35 m

### **24p 50M (Only for 1080 60i compatible models.)**

2GB: -

4GB: -

8GB: -

16GB: -

32GB: -

64GB: 2 h 35 m

## **[ File Format]:[AVCHD]**

### **60i 24M(FX)**

### **50i 24M(FX)**

2GB: 10 m

4GB: 20 m

8GB: 40 m

16GB: 1 h 30 m

32GB: 3 h

64GB: 6 h

### **60i 17M(FH)**

### **50i 17M(FH)**

2GB: 10 m

4GB: 30 m

8GB: 1 h

16GB: 2 h

32GB: 4 h 5 m

64GB: 8 h 15 m

**60p 28M(PS)**

**50p 28M(PS)**

2GB: 9 m

4GB: 15 m

8GB: 35 m

16GB: 1 h 15 m

32GB: 2 h 30 m

64GB: 5 h 5 m

**24p 24M(FX)**

**25p 24M(FX)**

2GB: 10 m

4GB: 20 m

8GB: 40 m

16GB: 1 h 30 m

32GB: 3 h

64GB: 6 h

**24p 17M(FH)**

**25p 17M(FH)**

2GB: 10 m

4GB: 30 m

8GB: 1 h

16GB: 2 h

32GB: 4 h

64GB: 8 h

**[  File Format]:[MP4]**

**1440×1080 12M**

2GB: 20 m

4GB: 40 m

8GB: 1 h 20 m

16GB: 2 h 45 m

32GB: 5 h 30 m

64GB: 11 h

**VGA 3M**

2GB: 1 h 10 m

4GB: 2 h 25 m

8GB: 4 h 55 m

16GB: 10 h

32GB: 20 h

64GB: 40 h

Continuous shooting is possible for approximately 29 minutes for each shooting (limited by product specifications). For [MP4 12M] size movies, continuous shooting is possible for

approximately 20 minutes (limited by 2 GB file size).

#### Note

- The recordable time of movies varies because the product is equipped with VBR (Variable Bit Rate), which automatically adjusts image quality depending on the shooting scene. When you record a fast-moving subject, the image is clearer but the recordable time is shorter because more memory is required for recording. The recordable time also varies depending on the shooting conditions, the subject or the image quality/size settings.

---

[264] How to Use | Precautions/This product | Using this product abroad

## Plug adaptor

---

You can use the battery charger and the AC Adaptor AC-PW10AM in any country or region where the power supply is within 100 V to 240 V AC and 50 Hz/60 Hz.

#### Note

- Do not use an electronic voltage transformer as doing so may cause a malfunction.

---

[265] How to Use | Precautions/This product | Using this product abroad

## On TV color systems

---

To view movies shot using this product on a television, the product and television must use the same color television system. Check the TV color system for the country or region where you are using the product.

- **NTSC system:**

Bahama Islands, Bolivia, Canada, Central America, Chile, Colombia, Ecuador, Jamaica, Japan, Korea, Mexico, Peru, Surinam, Taiwan, the Philippines, the U.S.A., Venezuela, etc.

- **PAL system:**

Australia, Austria, Belgium, China, Croatia, Czech Republic, Denmark, Finland, Germany, Holland, Hong Kong, Hungary, Indonesia, Italy, Kuwait, Malaysia, New Zealand, Norway, Poland, Portugal, Rumania, Singapore, Slovak Republic, Spain, Sweden, Switzerland, Thailand, Turkey, United Kingdom, Viet Nam, etc.

- **PAL-M system:**

Brazil

- **PAL-N system:**

Argentina, Paraguay, Uruguay

- **SECAM system:**

Bulgaria, France, Greece, Guiana, Iran, Iraq, Monaco, Russia, Ukraine, etc.

---



[266] How to Use | Precautions/This product | Other information

## Vertical grip

---

You can attach a vertical grip (sold separately) to this product and record vertically oriented images. For details, refer to the operating instructions for the vertical grip.

### Note

- When a vertical grip is attached to this product, the battery remaining is displayed as **1**  **2**  .
  - When the vertical grip is attached, you cannot perform the following operations:
    - Using the AC Adaptor AC-PW10AM (sold separately)
- 

[267] How to Use | Precautions/This product | Other information

## License

---

### Notes on the License

This product comes with software that are used based on licensing agreements with the owners of that software. Based on requests by the owners of copyright of these software applications, we have an obligation to inform you of the following. Please read the following sections. Licenses (in English) are recorded in the internal memory of your product. Establish a Mass Storage connection between the product and a computer to read licenses in the “PMHOME” - “LICENSE” folder.

THIS PRODUCT IS LICENSED UNDER THE AVC PATENT PORTFOLIO LICENSE FOR THE PERSONAL USE OF A CONSUMER OR OTHER USES IN WHICH IT DOES NOT RECEIVE REMUNERATION TO

(i) ENCODE VIDEO IN COMPLIANCE WITH THE AVC STANDARD (“AVC VIDEO”) AND/OR

(ii) DECODE AVC VIDEO THAT WAS ENCODED BY A CONSUMER ENGAGED IN A PERSONAL ACTIVITY AND/OR WAS OBTAINED FROM A VIDEO PROVIDER LICENSED

TO PROVIDE AVC VIDEO.

NO LICENSE IS GRANTED OR SHALL BE IMPLIED FOR ANY OTHER USE. ADDITIONAL INFORMATION MAY BE OBTAINED FROM MPEG LA, L.L.C. SEE [HTTP://WWW.MPEGLA.COM](http://www.mpegla.com)

## On GNU GPL/LGPL applied software

The software that is eligible for the following GNU General Public License (hereinafter referred to as “GPL”) or GNU Lesser General Public License (hereinafter referred to as “LGPL”) are included in the product.

This informs you that you have a right to have access to, modify, and redistribute source code for these software programs under the conditions of the supplied GPL/LGPL.

Source code is provided on the web.

Use the following URL to download it.

<http://www.sony.net/Products/Linux/>

We would prefer you do not contact us about the contents of source code.

Licenses (in English) are recorded in the internal memory of your product. Establish a Mass Storage connection between the product and a computer to read licenses in the “PMHOME” - “LICENSE” folder.

---

[268] How to Use | Precautions/This product | Trademarks

## Trademarks

---

- The following marks are registered trademarks or trademarks of Sony Corporation.



**α**, **MEMORY STICK**, Memory Stick, **MEMORY STICK PRO**, Memory Stick PRO, **MEMORY STICK DUO**, Memory Stick Duo, **MEMORY STICK PRO DUO**, Memory Stick PRO Duo, **MEMORY STICK PRO-HG DUO**, Memory Stick PRO-HG Duo, **MEMORY STICK XC-HG DUO**, Memory Stick XC-HG Duo, **MEMORY STICK MICRO**, Memory Stick Micro, **MAGIC GATE**, MagicGate, PhotoTV HD, InfoLITHIUM, PlayMemories Online, PlayMemories Online logo, PlayMemories Home, PlayMemories Home logo, PlayMemories Mobile, PlayMemories Mobile logo

Multi Interface Shoe, Multi Interface Shoe logo

- XAVC S and **XAVC S** are registered trademarks of Sony Corporation.
- Blu-ray Disc™ and Blu-ray™ are trademarks of the Blu-ray Disc Association.
- AVCHD Progressive and AVCHD Progressive logotype are trademarks of Panasonic Corporation and Sony Corporation.
- Dolby and the double-D symbol are trademarks of Dolby Laboratories.
- HDMI, the HDMI logo and High-Definition Multimedia Interface are trademarks or registered trademarks of HDMI Licensing LLC.

- Microsoft, Windows, DirectX and Windows Vista are either registered trademarks or trademarks of Microsoft Corporation in the United States and/or other countries.
- Mac and Mac OS are trademarks of Apple Inc.
- iOS is a registered trademark or trademark of Cisco Systems Inc.
- iPhone and iPad are trademarks of Apple Inc., registered in the U.S. and other countries.
- SDXC logo is a trademark of SD-3C, LLC.
- Android and Google Play are trademarks or registered trademarks of Google Inc.
- Wi-Fi, the Wi-Fi logo, Wi-Fi PROTECTED SET-UP are registered trademarks or trademarks of the Wi-Fi Alliance.
- The N Mark is a trademark or registered trademark of NFC Forum, Inc. in the United States and in other countries.
- DLNA and DLNA CERTIFIED are trademarks of Digital Living Network Alliance.
- "  " and "PlayStation" are registered trademarks of Sony Computer Entertainment Inc.



- Add further enjoyment with your PlayStation 3 by downloading the application for PlayStation 3 from PlayStation Store (where available.)
- The application for PlayStation 3 requires PlayStation Network account and application download. Accessible in areas where the PlayStation Store is available.
- Eye-Fi is a trademark of Eye-Fi Inc.
- In addition, system and product names used in this manual are, in general, trademarks or registered trademarks of their respective developers or manufacturers. However, the <sup>TM</sup> or ® marks may not be specified in all cases in this manual.

---

[269] Troubleshooting | If you have problems | If you have problems

## Troubleshooting

---

If you experience trouble with the product, try the following solutions.

1. Check the items under "Troubleshooting", then check the product.
2. Remove the battery pack, wait for about one minute, re-insert the battery pack, then turn on the power.

3. Initialize the settings.
4. Consult your dealer or local authorized service facility. Additional information on this product and answers to frequently asked questions can be found at our Customer Support Website.  
<http://www.sony.net/>

---

[270] Troubleshooting | Troubleshooting | Battery pack and power

## You cannot insert the battery pack into the product.

---

- Make sure the direction of the battery pack is correct, and insert it until the battery lock lever is locked.

---

[271] Troubleshooting | Troubleshooting | Battery pack and power

## You cannot turn on the product.

---

- After inserting the battery pack into the product, it may take a few moments for the product to power up.
- Make sure that the battery pack is inserted correctly.
- The battery pack will discharge by itself even if you do not use it. Charge the battery pack before use.
- Make sure that the battery is NP-FM500H .

---

[272] Troubleshooting | Troubleshooting | Battery pack and power

## The power turns off suddenly.

---

- Depending on the product and battery pack temperature, the product may turn off automatically to protect itself. In this case, a message is displayed on the product screen before the product turns off.

## The remaining battery level indicator shows an incorrect level.

---

- This phenomenon occurs when you use the product in an extremely hot or cold location.
  - Battery capacity decreases over time and through repeated use. If decreased usage time between charges becomes significant, it is probably time to replace it with a new one.
- 

## The CHARGE lamp of the battery charger flashes when charging the battery pack.

---

- Make sure that the battery is NP-FM500H .
  - Batteries which have not been used for more than a year may have deteriorated.
  - This phenomenon occurs when you charge the battery pack in an extremely hot or cold location. The optimum temperature for charging the battery pack is between 10 °C and 30 °C (50 °F and 86 °F).
- 

## You cannot record images.

---

- You are using a memory card with a write-protect switch, and the switch is set to the LOCK position. Set the switch to the record position.
  - Check the free capacity of the memory card.
  - You cannot record images while charging the flash.
  - The lens is not attached properly. Attach the lens properly.
  - The [Self-timer] is activated.
- 

## Recording takes a long time.

---



- 
- The noise reduction function is processing an image. This is not a malfunction.
  - You are shooting in RAW mode. Since RAW data files are large, RAW mode shooting may take time.
  - The [Auto HDR] function is processing an image.
  - The product is compiling images.
- 

[277] Troubleshooting | Troubleshooting | Shooting still images/movies

## The image is out of focus.

---

- The subject is too close. Check the minimum focal distance of the lens.
  - Ambient light is insufficient.
  - The subject you are shooting is not suitable for auto-focusing. Shoot in [Flexible Spot] mode or manual focus mode.
- 

[278] Troubleshooting | Troubleshooting | Shooting still images/movies

## The flash does not work.

---

- Raise the flash.
  - You cannot use a flash in the following situations:
    - [Night Scene] or [Hand-held Twilight] in Scene Selection is selected.
    - During Sweep Panorama shooting.
    - During movie recording.
- 

[279] Troubleshooting | Troubleshooting | Shooting still images/movies

## Fuzzy white circular spots appear on images shot using the flash.

---

- Particles (dust, pollen, etc.) in the air reflected the flash light and appeared on the image. This is not a malfunction.

---

[280] Troubleshooting | Troubleshooting | Shooting still images/movies

The recording date and time are not displayed on the screen.

- 
- While shooting, the date and time are not displayed. They are displayed only during playback.

---

[281] Troubleshooting | Troubleshooting | Shooting still images/movies

The date and time are recorded incorrectly.

- 
- Set the correct date and time.
  - The area selected using [Area Setting] differs from the actual area. Select the actual area.

---

[282] Troubleshooting | Troubleshooting | Shooting still images/movies

The aperture value and/or shutter speed and/or metering indicator flashes.

- 
- The subject is too bright or too dark to shoot using the current aperture value and/or shutter speed settings. Readjust the settings.

---

[283] Troubleshooting | Troubleshooting | Shooting still images/movies

The image colors are not correct.

- 
- Adjust [White Balance].
  - [Picture Effect] is set. Set [Picture Effect] to [Off].
  - To reset settings to default, perform [Setting Reset].
-

## Noise appears in the image when you view the screen in a dark place.

---

- The product is attempting to increase the visibility of the screen by temporarily brightening the monitor under conditions of low illumination. There is no effect on the recorded image.
- 

## The eyes of the subject come out red.

---

- Set [Red Eye Reduction] to [On].
  - Shoot the subject at a distance closer than the flash range using the flash.
  - Light the room and shoot the subject.
- 

## Dots appear and remain on the screen.

---

- This is not a malfunction. These dots are not recorded.
- 

## You cannot shoot images continuously.

---

- The memory card is full. Delete unnecessary images.
  - The battery level is low. Insert a charged battery pack.
- 

## The image is not clear in the viewfinder.

---

- 
- Adjust the diopter scale properly using the diopter-adjustment dial.
- 

[289] Troubleshooting | Troubleshooting | Shooting still images/movies

## The image is whitish (Flare)./Blurring of light appears on the image (Ghosting).

---

- When pointing the lens toward the strong light source, excessive light enters the lens and the image may come out white (flare) or extraneous light (ghost images) may appear on the image, but this is not a malfunction.

When using the zoom lens, attach the lens hood.

Also, set up the composition so that you shoot images while avoiding backlit condition.

---

[290] Troubleshooting | Troubleshooting | Shooting still images/movies

## The corners of the picture are too dark.

---

- If any filter or hood is used, take it off and try shooting again. Depending on the thickness of the filter and improper attachment of the hood, the filter or the hood may partially appear in the image. The optical properties of some lenses may cause the periphery of the image to appear too dark (insufficient light). You may compensate for this phenomenon with [Shading Comp.].
- 

[291] Troubleshooting | Troubleshooting | Shooting still images/movies

## The image is blurred.

---

- Make sure that [SteadyShot] is set to [On].
  - The picture was taken in a dark location without the flash, resulting in camera-shake. The use of a tripod or the flash is recommended. [Hand-held Twilight] in [Scene Selection] is also effective in reducing blur.
-

## The LCD screen darkens after a short period of time passed.

---

- If you do not operate the product for a certain period of time, the product switches to the power-save mode. The product exits power-save mode when you perform operations such as pressing the shutter button halfway.

## The flash takes too long to recharge.

---

- The flash has been fired in succession in a short period. When the flash has been fired in succession, the recharging process may take longer than usual to avoid overheating of the camera.

## The control dial does not work.

---

- [Dial Lock] is on. Hold down the Fn button until the lock is released, or set the [Dial Lock] to [Unlock].

## Images cannot be played back.

---

- Make sure that the memory card is fully inserted into the product.
- The folder/file name has been changed on your computer.
- When an image file has been processed by a computer or when the image file was recorded using a model other than this product, playback on this product is not guaranteed.
- The product is in USB mode. Disconnect the product from the computer.

- Use PlayMemories Home to play back on this product images that are stored on your computer.
- 

[296] Troubleshooting | Troubleshooting | Viewing images

## The date and time are not displayed.

---

- The screen display is set to display images only. Press DISP (Display Setting) button to display the information.
- 

[297] Troubleshooting | Troubleshooting | Viewing images

## The image cannot be deleted.

---

- Cancel the protection.
- 

[298] Troubleshooting | Troubleshooting | Viewing images

## The image was deleted by mistake.

---

- Once you have deleted an image, you cannot restore it. We recommend that you protect images that you do not want to delete.
- 

[299] Troubleshooting | Troubleshooting | Viewing images

## A DPOF mark cannot be put.

---

- You cannot place DPOF marks on RAW images.
- 

[300] Troubleshooting | Troubleshooting | Wi-Fi

## You cannot find the wireless access point to be connected.

---

- Wireless access points may not be displayed on the product due to signal conditions. Place the product closer to the wireless access point.
  - Wireless access points may not be displayed on the product depending on the access point settings. Refer to the instruction manual of the wireless access point.
- 

[301] Troubleshooting | Troubleshooting | Wi-Fi

### [WPS Push] does not work.

---

- [WPS Push] may not work depending on the access point settings. Check the SSID and password of the wireless access point, and perform [Access Point Set.].
- 

[302] Troubleshooting | Troubleshooting | Wi-Fi

### [Send to Computer] is canceled halfway.

---

- When the battery remaining level is low, [Send to Computer] may be canceled halfway. Charge the battery pack and try again.
- 

[303] Troubleshooting | Troubleshooting | Wi-Fi

### You cannot send movies to a smartphone.

---

- You cannot send XAVC S movies to a smartphone.
  - You cannot send AVCHD movies to a smartphone. Set [ File Format] to [MP4] to record movies.
- 

[304] Troubleshooting | Troubleshooting | Wi-Fi

[Ctrl w/ Smartphone] or [Send to Smartphone] is canceled halfway.

---

- When the remaining battery level is low, [Ctrl w/ Smartphone] or [Send to Smartphone] may be canceled halfway. Charge the battery pack and try again.
- 

[305] Troubleshooting | Troubleshooting | Wi-Fi

The shooting screen for [Ctrl w/ Smartphone] is not displayed smoothly./The connection between this product and the smartphone is disconnected.



---

- Data communication between this product and the smartphone may fail due to signal conditions. Place this product closer to the smartphone.
- 

[306] Troubleshooting | Troubleshooting | Wi-Fi

You cannot use One-Touch connection (NFC).

---

- Place the  (N mark) on the smartphone and the  (N mark) on the product as close together as possible. If there is no response, move the smartphone a few millimeters or move the smartphone away from this product, wait more than 10 seconds, and then touch them together again.
  - [Airplane Mode] is set to [On]. Set [Airplane Mode] to [Off].
  - Check whether the NFC function is activated on your smartphone. For details, refer to the instruction manual of the smartphone.
  - Do not place any metal objects other than a smartphone near the  (N mark).
  - Do not contact two or more smartphones to this product at the same time.
  - If another NFC-based application is running on your smartphone, terminate that application.
- 

[307] Troubleshooting | Troubleshooting | Computers



## The computer does not recognize this product.

---

- Set [USB Connection] to [Mass Storage].
  - Use the micro USB cable (supplied) to connect the devices.
  - Disconnect the USB cable, and connect it again firmly.
  - Disconnect all equipment other than this product, the keyboard and the mouse from the USB terminals of your computer.
  - Connect this product directly to your computer without passing through a USB hub or other device.
- 

[308] Troubleshooting | Troubleshooting | Computers

## You cannot import images.

---

- Connect this product and your computer correctly making a USB connection.
  - When you shoot images with a memory card formatted by a computer, you may not be able to import the images to a computer. Shoot using a memory card formatted by this product.
- 

[309] Troubleshooting | Troubleshooting | Computers

## The image and sound are interrupted by noise when viewing a movie on a computer.

---

- You are playing back the movie directly from the memory card. Import the movie to your computer using PlayMemories Home and play it back.
- 

[310] Troubleshooting | Troubleshooting | Computers

## Images exported from a computer cannot be viewed on this product.

---

- Use PlayMemories Home to copy images that are stored on a computer onto a memory

card inserted into this product and view them on this product.

---

[311] Troubleshooting | Troubleshooting | Memory cards

## Formatted the memory card by mistake.

---

- All the data on the memory card is deleted by formatting. You cannot restore the data.
- 

[312] Troubleshooting | Troubleshooting | Printing

## You cannot print images.

---

- RAW images cannot be printed. To print RAW images, first convert them to JPEG images using “Image Data Converter.”
- 

[313] Troubleshooting | Troubleshooting | Printing

## The color of the image is strange.

---

- When you print the images recorded in Adobe RGB mode using sRGB printers that are not compatible with Adobe RGB (DCF2.0/Exif2.21), the images are printed at a lower saturation.
- 

[314] Troubleshooting | Troubleshooting | Printing

## Images are printed with both edges cut off.

---

- Depending on your printer, the left, right, top, and bottom edges of the image may be cut off. Especially when you print an image shot with [  Aspect Ratio] set to [16:9], the lateral end of the image may be cut off.
- When printing images using your printer, cancel the trimming or borderless settings of the printer. Consult the printer manufacturer as to whether the printer provides these functions or not.

- When you print images at a shop, ask the shop whether they can print the images without cutting off both edges.

---

[315] Troubleshooting | Troubleshooting | Printing

## You cannot print images with the date.

---

- If you want to print images with the date, use [Print Setting] under [Specify Printing].
- You can print images with the date superimposed if the printer or the software can recognize Exif information. For compatibility with Exif information, consult the manufacturer of the printer or the software.
- Using PlayMemories Home, you can print images with the date without recording the date.
- When you print images at a shop, images can be printed with the date if you ask them to do so.

---

[316] Troubleshooting | Troubleshooting | Others

## The lens gets fogged.

---

- Moisture condensation has occurred. Turn off the product and leave it for about an hour before using it.

---

[317] Troubleshooting | Troubleshooting | Others

## The product becomes warm when you use it for a long time.

---

- This is not a malfunction. Turn off the product and do not use it for a while.

---

[318] Troubleshooting | Troubleshooting | Others

## The Clock Set screen appears when you turn on the

product.

---

- Set the date and time again.
  - The internal rechargeable backup battery has discharged. Insert a charged battery, and set aside for 24 hours or more with the power left off.
- 

[319] Troubleshooting | Troubleshooting | Others

The number of recordable images does not decrease, or decreases two images at a time.

---

- This is because the compression rate and the image size after compression change depending on the image when you shoot a JPEG image.
- 

[320] Troubleshooting | Troubleshooting | Others

The product does not work properly.

---

- Turn off the product. Remove the battery pack and insert it again. If the product is hot, remove the battery pack, and allow it to cool down before trying this corrective procedure.
  - If an AC-PW10AM AC Adaptor (sold separately) is used, disconnect the power cord. Connect the power cord and turn on the product again. If the product repeats the same error often or still does not work after trying these solutions, consult your Sony dealer or local authorized Sony service facility.
- 

[321] Troubleshooting | Troubleshooting | Others

“--E-” appears on the screen.

---

- Remove the memory card, and insert it again. If the problem persists even after performing this procedure, format the memory card.
-

## Warning messages

---

### **Set Area/Date/Time.**

- Set the area, date and time. If you have not used the product for a long time, charge the internal rechargeable backup battery.

### **Power insufficient.**

- The cleaning mode will not operate when the remaining battery charge is less than  (3). We recommend using the AC Adaptor AC-PW20 when using cleaning mode.

### **Unable to use memory card. Format?**

- The memory card was formatted on a computer and the file format was modified. Select [Enter], and then format the memory card. You can use the memory card again, however, all previous data in the memory card is erased. It may take some time to complete the format. If the message still appears, change the memory card.

### **Memory Card Error**

- An incompatible memory card is inserted.
- Formatting has failed. Format the memory card again.

### **Unable to read memory card. Reinsert memory card.**

- An incompatible memory card is inserted.
- The memory card is damaged.
- The terminal section of the memory card is dirty.

### **This memory card may not be capable of recording and playing normally.**

- An incompatible memory card is inserted.

### **Processing...**

- When performing noise reduction, the reduction process takes place. You cannot do any further shooting during this reduction process.

### **Unable to display.**

- Images recorded with other products or images modified with a computer may not be displayed.

### **Cannot recognize lens. Attach it properly.**

- The lens is not attached properly, or the lens is not attached. If the message appears when a lens is attached, reattach the lens. If the message appears frequently, check whether the contacts of the lens and product are clean or not.

- When attaching the product to an astronomical telescope or something similar, set [Release w/o Lens] to [Enable].

### **Unable to print.**

- You tried to mark RAW images with a DPOF mark.

### **Internal temp. high. Allow it to cool.**

- The product has become hot because you have been shooting continuously. Turn the power off. Cool the product and wait until the product is ready to shoot again.



- You have been recording images for a long time, the product temperature has risen. Stop recording images until the product cools.

### **Recording is unavailable in this movie format.**

- Set [  File Format] to [MP4].



- The number of images exceeds that for which date management in a database file by the product is possible.



- Unable to register to the database file. Import all the images to a computer and recover the memory card.

### **Image DataBase File error**

- There is something wrong in the Image Database File. Select [Setup] → [Recover Image DB].

### **System Error**

#### **Camera Error. Turn power off then on.**

- Remove the battery pack, and then re-insert it. If the message appears frequently, consult your Sony dealer or local authorized Sony service facility.

### **Unable to magnify.**

### **Unable to rotate image.**

- Images recorded with other products may not be enlarged or rotated.

---

[323] Troubleshooting | Situations this product has difficulty handling | Situations this product has difficulty handling

## Situations this product has difficulty handling

---

The product cannot take full advantage of some features under certain circumstances. When shooting under the following conditions, either recompose the shot or change the shooting mode, then shoot the images again.

Low light conditions

- Sweep Panorama
- Lock-on AF

Overly bright conditions

- Lock-on AF

Varying levels of brightness

- Lock-on AF

Flickering lights

- Sweep Panorama

Subjects too close to the product

- Sweep Panorama

Subjects with large movements or subjects that move too quickly

- Superior Auto
- Sweep Panorama
- Auto HDR
- Lock-on AF

Subjects too small or too large

- Sweep Panorama
- Lock-on AF

Scenes with little contrast, such as the sky or a sandy beach

- Sweep Panorama
- Superior Auto
-  AF Track Duration

Scenes changing constantly, such as a waterfall

- Sweep Panorama
- Superior Auto
-  AF Track Duration

## Free Manuals Download Website

<http://myh66.com>

<http://usermanuals.us>

<http://www.somanuals.com>

<http://www.4manuals.cc>

<http://www.manual-lib.com>

<http://www.404manual.com>

<http://www.luxmanual.com>

<http://aubethermostatmanual.com>

Golf course search by state

<http://golfingnear.com>

Email search by domain

<http://emailbydomain.com>

Auto manuals search

<http://auto.somanuals.com>

TV manuals search

<http://tv.somanuals.com>