

SHARP®

ELECTRONIC CASH REGISTER

MODEL

ER-A410
ER-A420

INSTRUCTION MANUAL



The above illustration shows the model ER-A410.
Download from www.somanuals.com. All Manuals Search And Download.



WARNING

FCC Regulations state that any unauthorized changes or modifications to this equipment not expressly approved by the manufacturer could void the user's authority to operate this equipment.

Note: This equipment has been tested and found to comply with the limits for a Class A digital device, pursuant to Part 15 of the FCC Rules. These limits are designed to provide reasonable protection against harmful interference when the equipment is operated in a commercial environment.

This equipment generates, uses, and can radiate radio frequency energy and, if not installed and used in accordance with the instruction manual, may cause harmful interference to radio communications. Operation of this equipment in a residential area is likely to cause harmful interference in which case the user will be required to correct the interference at his own expense.

CAUTION

The AC outlet shall be installed near the equipment and shall be easily accessible.

FOR YOUR RECORDS

Please record below the model number and serial number, for easy reference, in case of loss or theft. These numbers are located on the right side of the unit. Space is provided for further pertinent data.

Model Number _____

Serial Number _____

Date of Purchase _____

Place of Purchase _____

INTRODUCTION

Thank you very much for your purchase of the SHARP Electronic Cash Register, Model ER-A410/A420. Please read this manual carefully before operating your machine to gain a thorough understanding of the functions and features offered by this model ECR.

Please keep this manual for future reference, it may help you if you encounter operational problems.

IMPORTANT

- **Install your register in a location that is not subject to direct radiation, unusual temperature changes, high humidity or exposed to water sources.**
Installation in such locations could cause damage to the cabinet and the electrical components.
- **The register should not be operated by an individual with wet hands.**
The water could seep into the interior of the register and cause component failure.
- **When cleaning your register, use a dry, soft cloth. Never use solvents, such as benzine and/or thinner.**
The use of such chemicals will lead to discoloration or deterioration of the cabinet.
- **The register plugs into any standard wall outlet (120V \pm 10% AC) which utilizes a dedicated ground circuit.**
Please note that other electrical devices on the same electrical circuit could cause the register to malfunction.
- **If the register malfunctions, call your local dealer for service - do not try to repair the register yourself.**
- **For a complete electrical disconnection, the AC power cord must be removed from the wall outlet.**
- **Never disconnect the peripheral while the register remains plugged into the AC outlet.**

PRECAUTION

This Electronic Cash Register has a built-in memory protection circuit which is supported by rechargeable batteries.

It is important to know that all batteries will, in time, dissipate their charge even if not used. Therefore to insure an adequate charge in the protection circuit, and to prevent any possible loss of memory during or after installation, it is recommended that each unit be allowed to recharge for a period of 24 to 48 hours prior to and during use by the customer.

In order to charge the batteries, the machine must be plugged in. This recharging precaution can prevent unnecessary equipment malfunctions or service calls.

CONTENTS

INTRODUCTION	1
IMPORTANT	1
PRECAUTION	1
CONTENTS	2
EXTERNAL VIEW OF THE ER-A410	7
Front view	7
Rear view	7
EXTERNAL VIEW OF THE ER-A420	8
Front view	8
Rear view	8
PRINTER	9
KEYBOARD	10
1 ER-A410 standard keyboard layout	10
2 ER-A420 standard keyboard layout	12
3 Standard key number layout	13
4 Installing the keyboard sheet (ER-A420)	14
KEYS AND SWITCHES	15
1 Mode switch and mode keys	15
2 Drawer lock key	15
3 Cashier code entry key	16
4 Receipt ON/OFF function	16
DISPLAYS	17
1 Operator display	17
2 Customer display (Pop-up type)	17

FOR THE OPERATOR

PRIOR TO ENTRIES	18
1 Preparations for entries	18
2 Power saving mode	19
3 Error warning	19
ENTRIES	20
1 Item entries	20
Single item entries	20
Repeat entries	21
Multiplication entries	22
Successive multiplication entries	23
Split-pricing entries	24
Single item cash sale (SICS)/single item finalize (SIF) entries	25
Scale entries	26
PLU level shift (for direct PLU)	28
PLU/UPC price level shift	30
Set PLU entries	31
Link PLU/UPC entries	32
Age verification (Birthday entry)	32
Mix-and-match entries	33
Price inquiry (view) function (for PLU/UPC)	33
UPC learning function	34
Price change function (for UPCs)	35
2 Displaying and printing subtotals	37
Merchandise subtotal	37
Taxable subtotal	37
Including-tax subtotal (full subtotal)	37

Food stamp-eligible subtotal	37
Tray subtotal	37
3 Finalization of transaction	38
Cash or Check tendering	38
Mixed tendering (check + cash)	38
Cash or Check sale that does not need any tender entry	39
Charge (credit) sale	39
Mixed-tender sale (cash or check tendering + charge tendering)	39
4 Food stamp calculations	40
Food stamp tendering	40
Food stamp status shift	41
5 Tax calculations	42
Automatic tax	42
Manual tax	42
Automatic-tax delete	43
Tax status shift	44
6 Guest check (PBLU)	45
New charge accounts	45
Additional item entries	46
Settlement	46
Deposit entries	47
7 Auxiliary entries	48
Percent calculations (premium or discount)	48
Discount entries	49
Refund entries	50
Refund sales mode	50
Printing of non-add code numbers	50
8 Payment treatment	51
Currency conversion	51
Received on account entries	52
Paid out entries	52
No sale (exchange)	52
Cashing a Check	53
Bottle return	53
9 Automatic sequencing key (AUTO key) entries	53
CORRECTION	54
1 Correction of the last entry (direct void)	54
2 Correction of the next-to-last or earlier entries (indirect void)	54
3 Subtotal void	55
4 Correction of incorrect entries not handled by the direct or indirect void function	55
CORRECTION AFTER FINALIZING A TRANSACTION (AFTER GENERATING A RECEIPT)	56
OVERRIDE ENTRIES	57
OVERLAPPED CASHIER ENTRY	58
SPECIAL PRINTING FUNCTIONS	59
1 Copy receipt printing	59
2 Validation printing function (Slip printer)	60
3 Printing of the employee's arrival and departure times (Slip printer)	60
4 Printing of header and footer graphic logos	60
5 Remote printer send function	61
TIME DISPLAY AND AUTOMATIC UPDATING OF THE DATE	62
1 Time display	62
2 Automatic updating of the date	62

FOR THE MANAGER

PRIOR TO PROGRAMMING	63
1 Programming keyboard layout	63

2	How to program alphanumeric characters	64
	Using character keys on the keyboard	64
	Entering character codes	64
PROGRAMMING		66
	Basic instructions	66
	Preparations for programming	66
Direct Programming		66
1	Setting the date and time	66
	Date	66
	Time	67
2	Programming for departments	67
	Unit price	67
	Functional selection	68
3	PLU/UPC programming	70
	Unit price	70
	Functional selection	70
	PLU/UPC assignment to departments	72
4	Programming for discount keys (⊖)	72
	Discount amount	72
	High amount lockout (HALO), sign (+/-), vendor/store coupon selection, food stamp status, and tax status	73
5	Programming for percent keys (%)	74
	Percent rate	74
	Sign (+/-), %item/%subtotal selection, food stamp status, and tax status	74
6	Programming for conversion keys (CONV)	75
	Currency conversion rate	75
7	Programming for the RA, PO, and TAX keys	76
	High amount lockout (HALO)	76
8	Programming for the CA1, CA2, CH, and CHK keys	76
	High amount lockout (HALO) and function selection	76
9	Programming for the automatic tax calculation function	78
	The tax table (applicable to the add-on tax)	78
Job-Code-Based Programming		81
1	Setting the date and time	81
	Setting the date (#2610)	81
	Setting the time (#2611)	81
2	Setting the register and consecutive numbers	82
	Setting the register number (#2612)	82
	Setting the consecutive number (#2613)	82
3	Programming for the automatic tax calculation function	83
	The tax table (#2710)	83
	The tax rate (#2711)	85
	Doughnut tax exempt (for the Canadian tax system) (#2715)	86
4	Programming for departments	87
	Functional programming 1 (#2110)	87
	Functional programming 2 (#2111)	89
	A limit amount (HALO) of entry (#2112)	90
	Alphanumeric characters (#2114)	90
	Unit price (#1110)	91
	Commission group assignment (#2115)	91
	Group number (#2116)	92
	Age limitation (#2180)	92
	Print station assignment (#2118)	93
	Department key positioning (#2119)	93
5	PLU/UPC programming	94
	Department assignment (#1200, 2230)	95
	Unit prices (#1210)	96

Base quantity (#1211)	96
Type of unit price entry, delete method, tare table no. and scale entry (#2210, 2231)	97
Sign (+/-), food stamp status, and tax status (#2211, 2232)	98
Alphanumeric characters (#2214)	99
Assigning of PLUs/UPCs to commission groups (#2215, 2235)	100
Age limitation (#2280, 2236)	101
Stock quantity (#1222, 1220, 1221)	102
Set PLU (#2221)	103
Mix-and-match table (#2217, 2225)	104
Print station to PLU/UPC assignment (#2218)	105
Delete period for non-accessed UPC code (#2029)	105
Programming Non-PLU code format (#2025)	106
Link PLU/UPC link (#2220)	107
Programming of PLU levels and direct PLU keys (#2219)	107
6 Programming for miscellaneous keys	108
Programming the rate (%, CONV, commission) and the discount (⊖) (#1310)	108
Currency description text programming (CONV) (#2334)	109
A limit amount (HALO) of entry (⊖, TAX, RA, PO) (#2312)	110
+/- sign, food stamp status and tax status (%, ⊖) (#2311)	110
Percent entry type (%) (#2310)	112
Item % or subtotal % selection (%) (#2315)	112
Percent rate limitation (%) (#2313)	113
Vendor or store coupon selection (⊖) (#2316)	113
7 Programming for the CAAT, CA2, CHK, CHK2, and CH through CH5 keys	114
Functional programming (#2320)	114
Tax delete (#2326)	116
High amount lockout (HALO) for check cashing, check change, and cash in drawer (#2321)	117
High amount lockout (HALO) of entry for media keys (#2322)	117
Print station assignment (#2328)	118
8 Programming of function text	119
Programming (#2314)	119
List of function texts	120
9 Cashier programming	122
Cashier code (#1500)	122
Cashier name (#1514)	122
Assigning cashiers to drawers (#2510)	123
10 Programming various functions	123
Programming for optional feature selection (#2616)	123
Programming the parameter of the slip printer (#2615)	128
Setting the time limit for THE TILL TIMER™ (#2617)	128
Scale tare table (#2618)	129
Programming of logo messages (#2614)	130
Selection of X1/Z1 and X2/Z2 reports to be printed in the stacked report sequence (#2620)	131
Setting the time range for hourly reports (#2619)	132
Programming of power saving mode (#2689)	132
PBLU code programming (#2810)	133
Functional programming for the printer (#2990)	133
Programming of error messages (#2641)	134
Check validation message (#2642)	135
Slip printer's logo message (#2643)	135
RS-232C channel assignment (#2690)	136
Barcode reader programming (#2691)	137
Remote printer programming (#2692)	138
Second remote printer programming (#3653)	138
Remote printer name programming (#3654)	139
Print format for remote printer (#3655)	139
Chit receipt format (#3656)	140

Programming of RS-232C interface (#6110, 6111, 6112, 6113, 6115, 6220)	141
Programming the CAT interface (#7110, 7111, 7112, 7113, 7114, 7115)	142
Secret codes to control access to the PGM1 mode, X1/Z1 mode and X2/Z2 mode (#2630, 2631, 2632)	143
Setting the AUTO key (#2900)	144
11 TRAINING mode	145
12 Reading stored programs	146
Program details and procedures for their reading	146
Sample printouts	148
13 Universal Product Code (UPC) or European Article Number (EAN)	155
UPC or EAN code	155
Add-on code	156
READING (X) AND RESETTING (Z) OF SALES TOTALS	157
1 Summary of reading (X) and resetting (Z) reports and the key operations to obtain the reports	157
2 Daily sales totals	160
General report	160
Cashier report	163
Hourly report	165
Full department report	166
Individual group total report on department	166
Full group total report on department	166
PLU/UPC report (by designated range or pick up list)	167
PLU/UPC report by associated department	168
PLU/UPC zero sales report	168
PLU/UPC price category report	168
PLU/UPC stock report (by designated range or pick up list)	169
Commission sales report	169
PBLU report	169
PBLU report by cashier	170
Transaction report	170
Cash in drawer report	170
X1/Z1 stacked report	170
Deleting of non-accessed UPCs	171
3 Periodic consolidation	172
General Overview	172
Daily net report	173
X2/Z2 stacked report	173
COMPULSORY CASH/CHECK DECLARATION	174
OPERATOR MAINTENANCE	176
1 In case of power failure	176
2 In case of printer error	176
3 Thermal printing	176
Cautions in handling the printer	176
Cautions in handling the recording paper (thermal paper)	177
4 Installing and removing the paper roll	178
Recording paper specifications	178
Installing the paper roll	178
Removing the paper roll	180
Removing a paper jam	181
5 Cleaning the print head	182
6 Removing the till and the drawer	183
7 Opening the drawer by hand	183
8 Before calling for service	184
Error message table	184
LIST OF OPTIONS	185
SPECIFICATIONS	186

EXTERNAL VIEW OF THE ER-A410

■ Front view

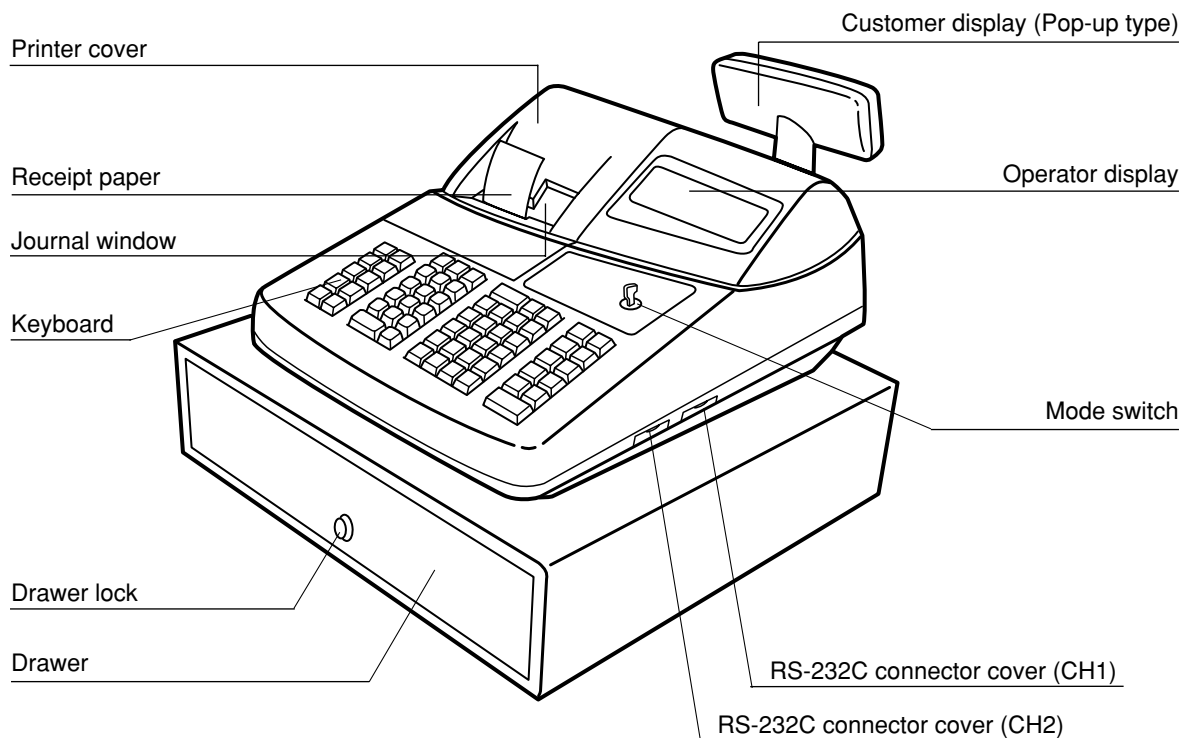

■ Rear view

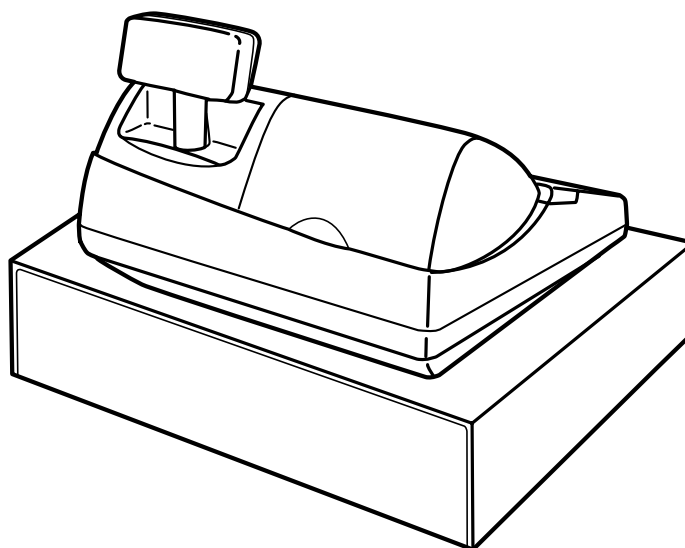

EXTERNAL VIEW OF THE ER-A420

■ Front view

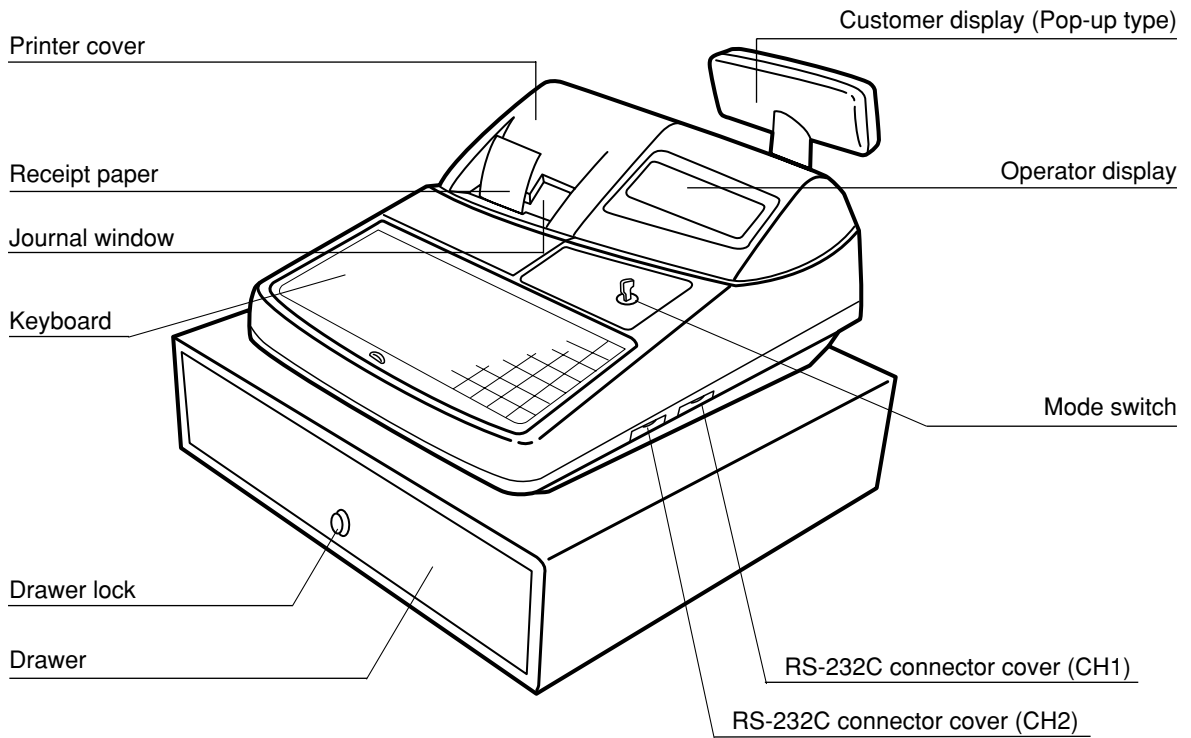

■ Rear view

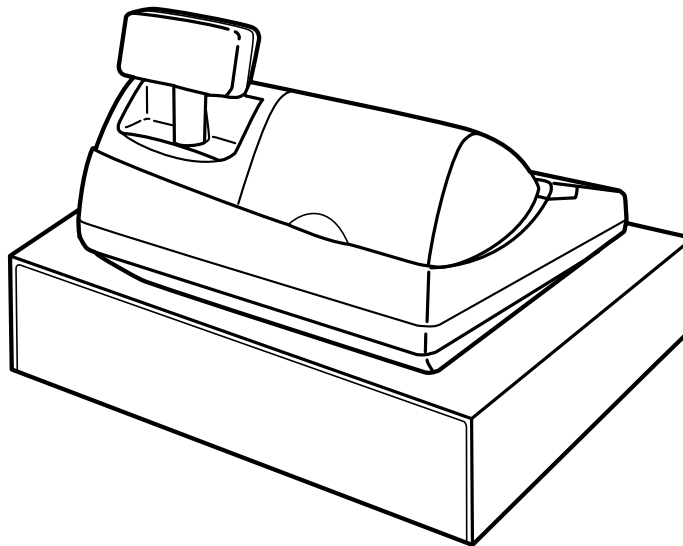

PRINTER

The printer is a receipt/journal dual station type thermal printer, that does not require an ink ribbon or cartridge. The average life of the printer is approximately 5 million lines.

When removing the printer cover, lift it from the rear as shown.

When installing the printer cover, hook it on the pawls on the cabinet and shut it.

Caution: *The paper cutter is mounted on the printer (receipt side). Be careful not to cut yourself.*

Your register is shipped with the print head release lever held in the lifted up position by a white retainer. Be sure to remove this retainer (see the figure at the right) and push down the print head release lever before you use the register.

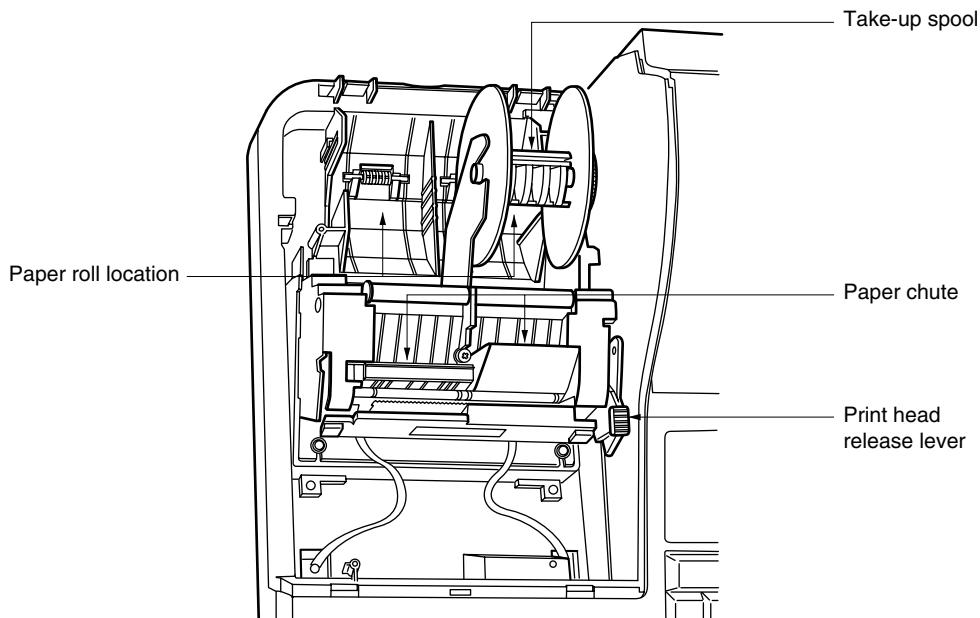
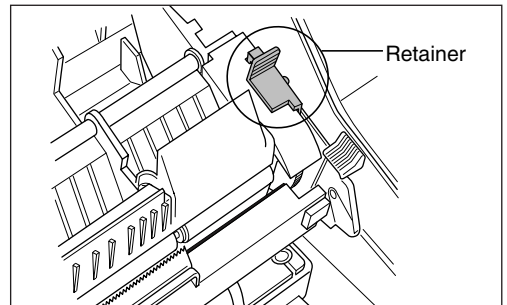
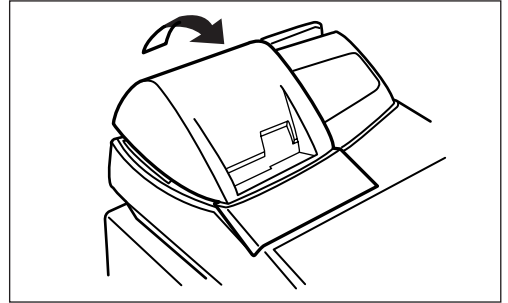

Print head release lever

The print head can be lifted by the green lever on the right side of the printer. Pulling the lever forward, lifts the print head up. If the paper becomes jammed and you need to move the print head farther forward, you can pull the lever even further toward you and proceed with the removal of the jammed paper.

Note

Do not attempt to remove the paper roll with the head in the down position. This may result in damage to the printer and print head.

KEYBOARD

1 ER-A410 standard keyboard layout

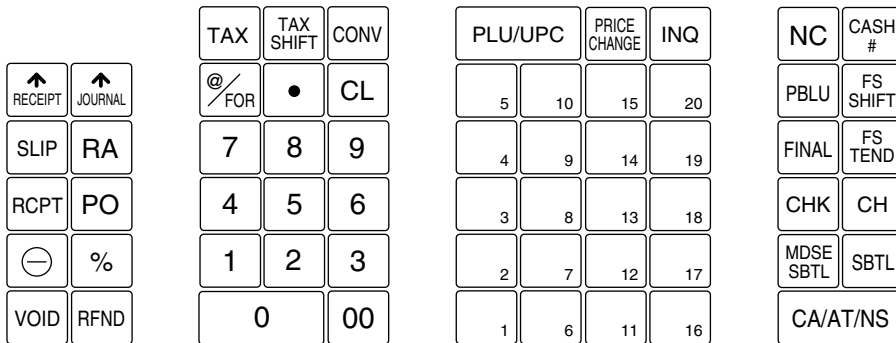

Note

All the keys but the receipt paper feed and journal paper feed keys can be re-positioned. If you want to change the layout, please consult your dealer.

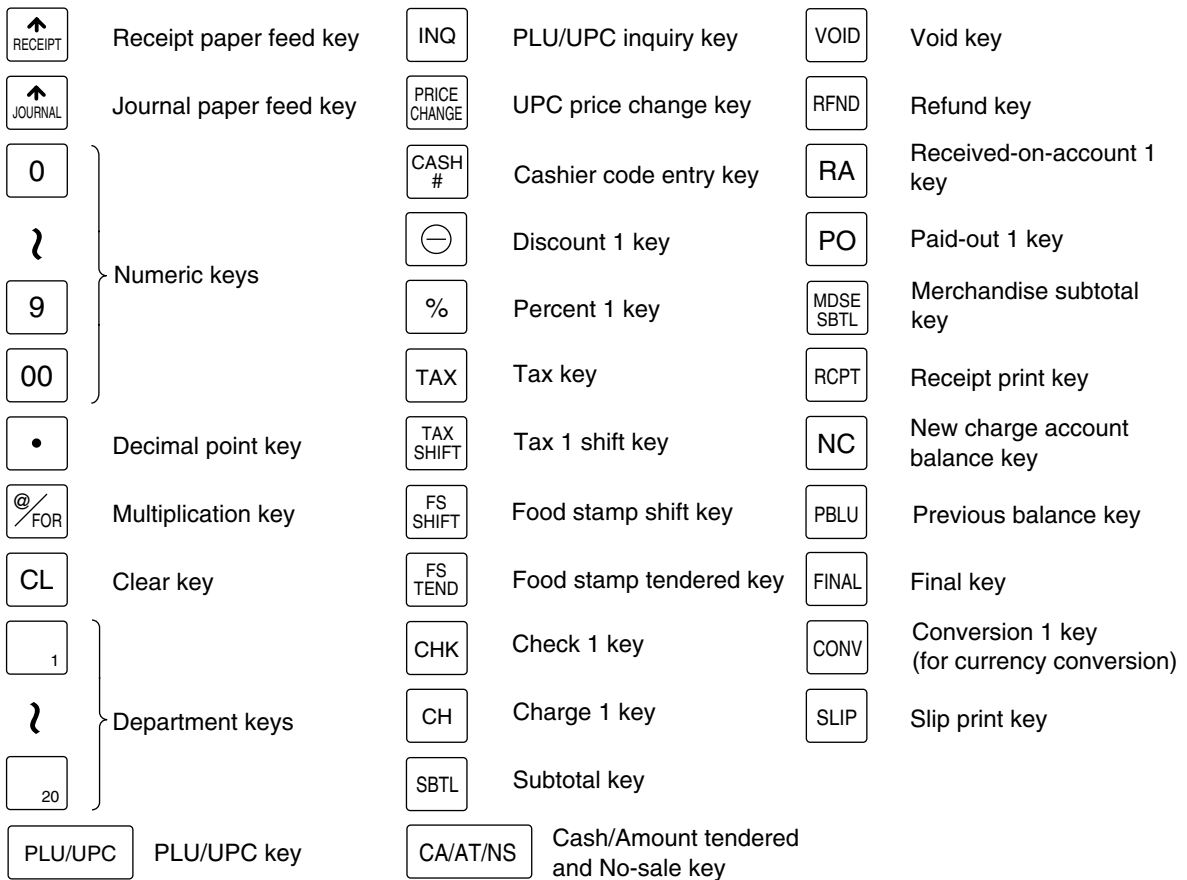

Optional keys

	Service key		} Conversion 2 thru 4 keys		} PLU level shift 1 thru 3 keys
	} Percent 2 thru 4 keys				
		} Automatic sequencing 1 thru 5 keys			} Discount 2 thru 4 keys
			Check 2 key		
	Cash total 2 key		Deposit entry key		Triple zero entry key
	Birthday date entry key		Deposit refund key		} Tax 2 thru 4 shift keys
	Department code entry key		Tray subtotal key		
	Received-on-account 2 key		Refund sale key		
	Paid-out 2 key		Validation print key		No sale key
# key"/>	Non-add code key		Repeat entry key		Non delete key
	Scale key		Amount entry key		Remote printer send key
	Open tare key				

Attention • The is a double-function key ([Cash/Amount tendered function] and [No Sale function]). Press the key replaces the and key in the following descriptions for operations.

Note The department and direct PLU keys can be expanded, if you require expansion of the department or direct PLU keys, please contact your dealer.

2 ER-A420 standard keyboard layout

↑ RECEIPT	↑ JOURNAL	73	74	75	76	77	78	79	80	81	82	L1	L2	L3	AUTO	CASH #
61	62	63	64	65	66	67	68	69	70	71	72	PRICE SHIFT	RCPT	RP SEND	PO	RA
49	50	51	52	53	54	55	56	57	58	59	60	@/FOR	•	CL	%	⊖
37	38	39	40	41	42	43	44	45	46	47	48	7	8	9	RFND	VOID
25	26	27	28	29	30	31	32	33	34	35	36	4	5	6	CH2	TAX SHIFT
13	14	15	16	17	18	19	20	21	22	23	24	1	2	3	CH1	CHK
1	2	3	4	5	6	7	8	9	10	11	12	0	00	MDSE SBTL	SBTL	CA/AT

Note All the keys but the receipt paper feed and journal paper feed keys can be re-positioned. If you want to change the keyboard layout, please consult your dealer.

	Receipt paper feed key		Subtotal key		Void key
	Journal paper feed key		Merchandise subtotal key		Refund key
	} Numeric keys		Cashier code entry key		Received-on-account 1 key
			Discount 1 key		Paid-out 1 key
			Receipt print key		Price level shift key
			Percent 1 key		Automatic sequencing 1 key
		Decimal point key		} PLU level shift 1 thru 3 keys	
	Multiplication key				
	Clear key				
	Remote printer send key		} Charge 1 and 2 keys		
	Tax 1 shift key				
	Cash/Amount tendered key		Check 1 key		

Optional keys

	Non-add code key		Amount entry key		Repeat entry key
	Scale key		PLU/UPC inquiry key		UPC price change key
	Non delete key				

SRVC	Service key	CONV	Conversion 1 thru 4 keys	SLIP	Slip print key
%2	Percent 2 thru 4 keys	⌋		TAX	Tax key
⌋		CONV 4		FS SHIFT	Food stamp shift key
%4		CH3		FS TEND	Food stamp tendered key
AUTO 2	Automatic sequencing 2 thru 5 keys	⌋	Charge 3 thru 5 keys	⊖2	Discount 2 thru 4 keys
⌋		CH5		⌋	
AUTO 5		CHK2	⊖4		
CA2	Cash total 2 key	DEPO	Deposit entry key	000	Triple zero entry key
BIRTH	Birthday date entry key	DEPO RFND	Deposit refund key	TAX2 SHIFT	Tax 2 thru 4 shift keys
DEPT #	Department code entry key	TRAY SBTL	Tray subtotal key	⌋	
RA2	Received-on-account 2 key	RFND SALE	Refund sale key	TAX4 SHIFT	
PO2	Paid-out 2 key	PRINT	Validation print key	PBLU	Previous balance key
NS	No sale key	PLU/UPC	PLU/UPC key	NC	New charge account balance key
OPEN TARE	Open tare key	FINAL	Final key		

Note The department and direct PLU keys can be expanded, if you require expansion of the department or direct PLU keys, please contact your dealer.

3 Standard key number layout

These key numbers are used for positioning of department keys and direct PLU keys. Refer to pages 93 and 107. This layout can be changed by your dealer.

For ER-A410

005	010	015	020		
004	009	014	019		
003	008	013	018		
002	007	012	017		
001	006	011	016		

For ER-A420

		093	094	095	096	097	098	099	100	101	102					
081	082	083	084	085	086	087	088	089	090	091	092					
069	070	071	072	073	074	075	076	077	078	079	080					
057	058	059	060	061	062	063	064	065	066	067	068					
045	046	047	048	049	050	051	052	053	054	055	056					
033	034	035	036	037	038	039	040	041	042	043	044					
021	022	023	024	025	026	027	028	029	030	031	032					

4 Installing the keyboard sheet (ER-A420)

Insert the keyboard sheet between the keyboard cover and the cabinet as illustrated below.

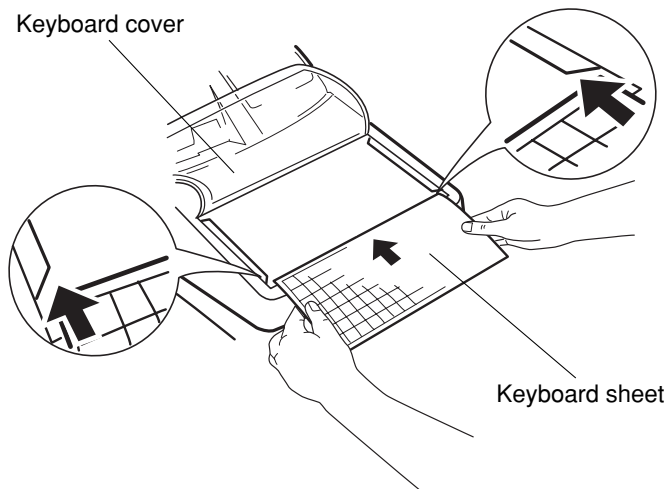

- ① Turn over the keyboard cover.
- ② Insert the keyboard sheet into a slit.



- ③ Close the keyboard cover.

Note

- Do not spread the keyboard cover too far as it might tear the tabs.
- Replace the keyboard sheet with a new one if by chance it gets wet. Use of a wet keyboard sheet may cause problems.
- Be sure to use only SHARP-supplied keyboard sheets. Thick or hard sheets can make key operations difficult.
- Place the keyboard sheet evenly under the keyboard cover.
- If you require a new keyboard sheet, please contact your dealer.
- The keyboard cover will eventually wear out. If your keyboard cover is dirty or broken, replace the cover with a new one. For details, contact your authorized SHARP dealer.

KEYS AND SWITCHES

1 Mode switch and mode keys

The mode switch can be operated by inserting one of the three supplied mode keys – manager (MA), submanager (SM), and operator (OP) keys. These keys can be inserted or removed only when the switch is in the “REG” or “OFF” position.

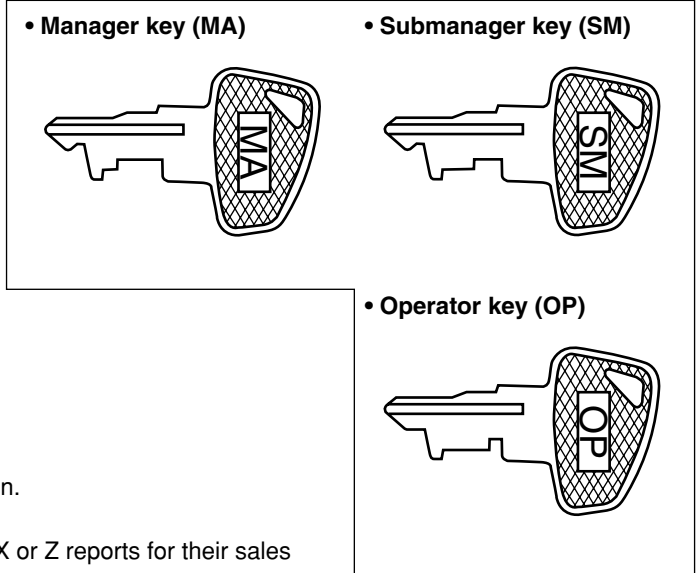
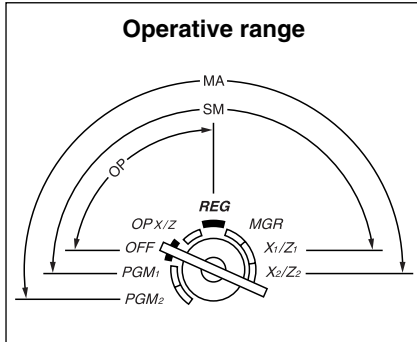

The mode switch has these settings:

- OFF:** This mode locks all register operation. No change occurs to register data.
- OP X/Z:** This setting allows cashiers to take X or Z reports for their sales information. It can also be used for displaying the date/time and printing the employee’s arrival/departure times. And it can be used to toggle receipt state “ON” and “OFF” by pressing the **RCPT** key. (This setting may be used only when your register has been programmed for “OP X/Z mode available” in the PGM2 mode.)
- REG:** For entering sales
- PGM1:** To program those items that need to be changed often: e.g., unit prices of departments, PLUs or UPCs, and percentages.
- PGM2:** To program all PGM1 programs and those items that do not require frequent changes: e.g., date, time, or a variety of register functions.
- MGR:** For manager’s and submanager’s entries
The manager can use this mode to make entries that are not permitted to be made by cashiers – for example, after-transaction voiding and override entries.
- X1/Z1:** To take the X/Z report for various daily totals.
- X2/Z2:** To take the X/Z report for various periodic (weekly or monthly) consolidation of totals.

2 Drawer lock key

This key locks and unlocks the drawer. To lock it, turn 90 degrees counterclockwise. To unlock it, turn 90 degrees clockwise.

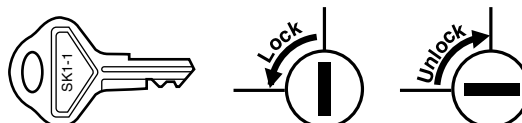

3 Cashier code entry key

Cashier codes are available in two variants: Variant 1, in which they are displayed (“0000” to “9999”), and Variant 2, in which they are not displayed (always “****”).

When the cashier code is assigned by the following procedure, the register prints the four-digit cashier code (variant 2: “****”) and the cashier name both on the receipt and journal for every transaction.

Procedure

■ Sign-on

Variant 1 :
(Code is displayed.)

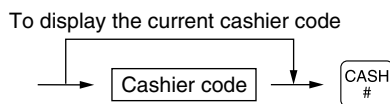

Variant 2 :
(Code is not displayed.)

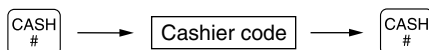

■ Sign-off

Variant 1 / Variant 2 :

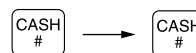

Note

All of these settings depend on how the register has been programmed. For the selection of these settings, consult your local dealer.

4 Receipt ON/OFF function

You can disable receipt printing in the REG mode to save paper using the receipt function. To disable receipt printing, press the **RCPT** key in the OP X/Z position. This key toggles the receipt printing status ON and OFF. To check the receipt printing status, turn the mode switch to the OP X/Z position or press the **CL** key in the REG mode. When the function is in the OFF status, the receipt off indicator “_” illuminates.

Note

Your register will print reports regardless of the receipt status. This means that the receipt roll must be installed even when the receipt state is “OFF” when taking reports.

DISPLAYS

1 Operator display

The operator display consists of a two-line dot-matrix display (16 characters/line).

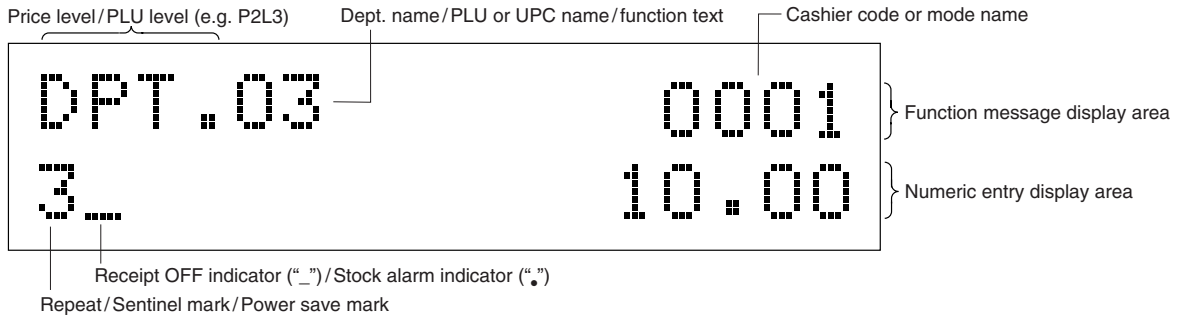

- **Cashier code or mode name**

The mode you are in is displayed. When a cashier is assigned, the cashier code is displayed in the REG or OP X/Z mode. For example, “0001” is displayed when cashier 0001 is assigned.

- **Repeat**

The number of repeats is displayed, starting at “2” and incremental with each repeat. When you have registered ten times, the display will show “0”. (2 → 39 → 0 → 1 → 2...)

- **Sentinel mark**

When amounts in the drawer reaches the amount you preprogrammed, the sentinel mark “X” is displayed to advice you to remove the money to a safe place.

- **Power save mark**

When the cash register goes into the power save mode, the power save mark (decimal point) is displayed.

- **Stock alarm indicator**

When the stock of the PLU or UPC which you entered is zero or negative, the alarm indicator (decimal point) is displayed.

- **Function message display area**

Item labels of departments and PLU/subdepartments/UPC and function text you use, such as %1, (–) and CASH are displayed here. For the details of function texts, please refer to pages 120 and 121. When an amount is to be entered or entered, “AMOUNT” is displayed: When an amount is to be entered, ----- is displayed in the numeric entry display area with “AMOUNT”. When a preset price has been set, the price is displayed in the numeric entry display area with “AMOUNT”.

- **Numeric entry display area**

Numbers entered using numeric keys are displayed here.

Date and time display

Date and time appear on the display in the OP X/Z, REG, or MGR mode. In the REG or MGR mode, press the key to display the date and time.

Error messages

When an error occurs, the corresponding error message is displayed in the function message display area. For the details of error messages, please refer to the “Error message table” on page 184.

2 Customer display (Pop-up type)

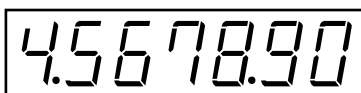

\$ _____ (• : Appears right below the seventh place when the item amount is displayed at scale entry.)

PRIOR TO ENTRIES

1 Preparations for entries

Before registrations, insert the operator key into the mode switch and turn it to the REG position and check the following items:

■ Receipt and journal paper rolls

If the receipt and journal paper rolls are not set in the machine or there are low rolls, install new ones according to section "4. Installing and removing the paper rolls" under "OPERATOR MAINTENANCE."

■ Receipt ON/OFF function

You can disable receipt printing in the REG mode to save paper using the receipt function. To disable receipt printing, press the **RCPT** key in the OP X/Z position. This key toggles the receipt printing status ON and OFF. To check the receipt printing status, turn the mode switch to the OP X/Z position or press the **CL** key in the REG mode. When the function is in the OFF status, the receipt off indicator " _ " illuminates.

Note Your register will print reports regardless of the receipt state. This means that the receipt roll must be installed even when the receipt state is "OFF" when taking reports.

■ Cashier assignment

Prior to any item entries, cashiers must enter their cashier code into the register. The code entry may not be necessary when the same cashier code is used in the next transaction.

Cashier codes are available in two variants: Variant 1, in which they are displayed ("0000" to "9999"), and Variant 2, in which they are not displayed (always "****").

When the cashier code is assigned by the following procedure, the register prints the four-digit cashier code (variant 2: "****") and the cashier name both on the receipt and journal for every transaction.

Note The operation entries depend on how the register has been programmed. To determine which selections should be considered, please consult your local dealer.

YOUR RECEIPT	
THANK YOU	
08/27/2004 10:34AM	1111
123456#1505	DICK
DPT. 01	\$15.00
***TOTAL	\$15.00
CASH	\$20.00
CHANGE	\$5.00

— Cashier code
 ("****" is printed in Variant 2.)
 — Cashier name

Procedure

■ Sign-on

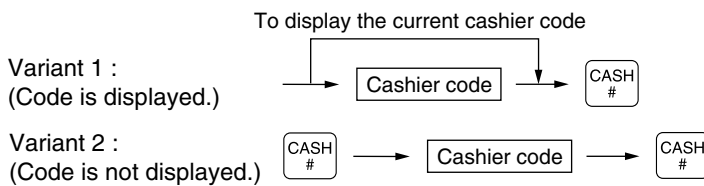

■ Sign-off

Variant 1 / Variant 2 :

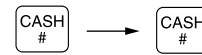

Note

- If you want to enter a cashier code before every transaction, please consult your dealer.
- For the display type selection of the cashier code, "Variant 1" has been preset. For the selection of the "Variant 2", consult your dealer.
- The cashier can be changed during a transaction. Please consult our dealer.

2 Power saving mode

The register will enter into the power saving mode when no entries are performed based on the pre-programmed time limit (by default, 30 minutes).

When the register goes to the power save mode, all display lights will turn off. This will be indicated by a decimal point at the left most position of the lower line. The register will return to normal operation mode when any key is pressed or a mode is changed with the mode key. Please note when the register is recovered by any key entry and the initial key entry is ignored. After the recovery, you may start the key entries from the beginning.

3 Error warning

In the following examples, your register will go into an error state accompanied with a warning beep and a corresponding error message. Clear the error state by pressing the **CL** key and take proper action. Please refer to the error message table on page 184.

- When you enter an over 32-digit number (entry limit overflow): Cancel the entry and re-enter a valid number.
- When you make an error in key operation: Clear the error and continue entries.
- When you make an entry beyond a programmed amount entry limit: Check to see if the entered amount is correct. If it is correct, it be possible to make the entry in the MGR mode. Contact your manager.
- When an including-tax subtotal exceeds eight digits: Clear the subtotal by pressing the **CL** key and press the **CAVAT**, **CA2**, **CHK**, **CHK2**, or **CH** thru **CH5** key to finalize the transaction.

ENTRIES

1 Item entries

■ Single item entries

Procedure

Department entries (direct department entries)

Enter a unit price and press a department key. If you use a programmed unit price, press a department key only.

When using a programmed unit price

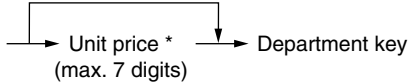

*Less than the programmed upper limit amounts

Note

When those departments for which the unit price has been programmed as zero (0) are entered, only the sales quantity is added.

Department entries (indirect department entries)

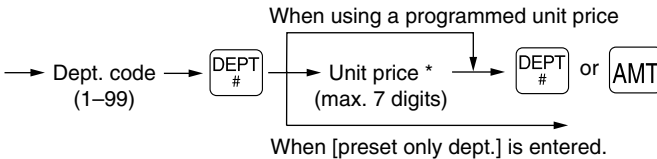

*Less than the programmed upper limit amounts

PLU entries (indirect PLU entries)

Enter a PLU code and press the  key.

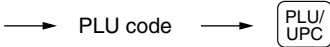

Note

When those PLU's for which the unit price has been programmed as zero (0) are entered, only the sales quantity is added.

Subdepartment (open PLU, open and preset PLU) entries

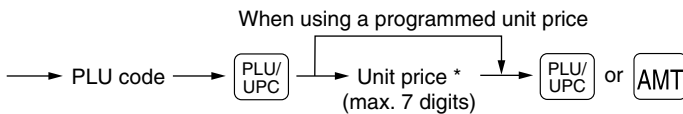

*Less than the programmed upper limit amounts

PLU entries (direct PLU entries)

When using a programmed unit price

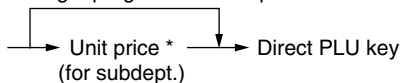

UPC entries

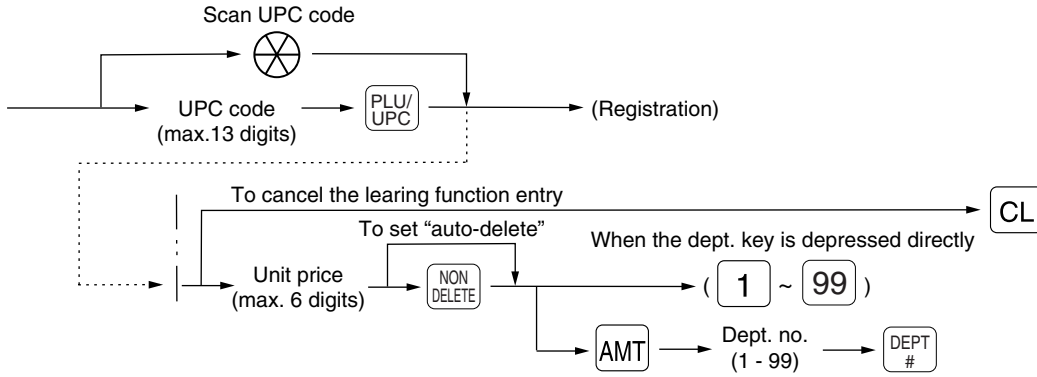

Example

Key operation

1200

 8
 5 680
 2
 11 1200

 5012345678900

Print

DPT.03	\$12.00
DPT.05	\$5.00
DPT.08	\$2.00
DPT.05	\$6.80
PLU00002	\$1.50
PLU00011	\$12.00
PLU00008	\$3.50
5012345678900#	
APPLE	\$2.50
CASH	\$45.30

Repeat entries

You can use this function for entering a sale of two or more same items.

You can use the key to repeat entry instead of department, , direct PLU or key.

Example

Key operation

Repeated department entry (direct) { 200

Repeated department entry (indirect) { 5 680

Repeated PLU entry (indirect) { 10

Repeated PLU entry (direct) {

Repeated subdepartment entry { 60
 500

Repeated UPC entry { 5012345678900

Repeated department entry (direct) using the repeat key { 600

Print

DPT.08	\$2.00
DPT.08	\$2.00
DPT.08	\$2.00
DPT.05	\$6.80
DPT.05	\$6.80
PLU00010	\$7.15
PLU00010	\$7.15
PLU00010	\$7.15
PLU00051	\$2.85
PLU00051	\$2.85
PLU00060	\$5.00
PLU00060	\$5.00
5012345678900#	
APPLE	\$2.50
5012345678900#	
APPLE	\$2.50
DPT.02	\$6.00
DPT.02	\$6.00
DPT.02	\$6.00
CASH	\$79.75

■ Multiplication entries

Use this feature when you need to enter two or more same items.

This feature helps when you sell a large quantity of items or need to enter quantities that contain decimals.

Procedure

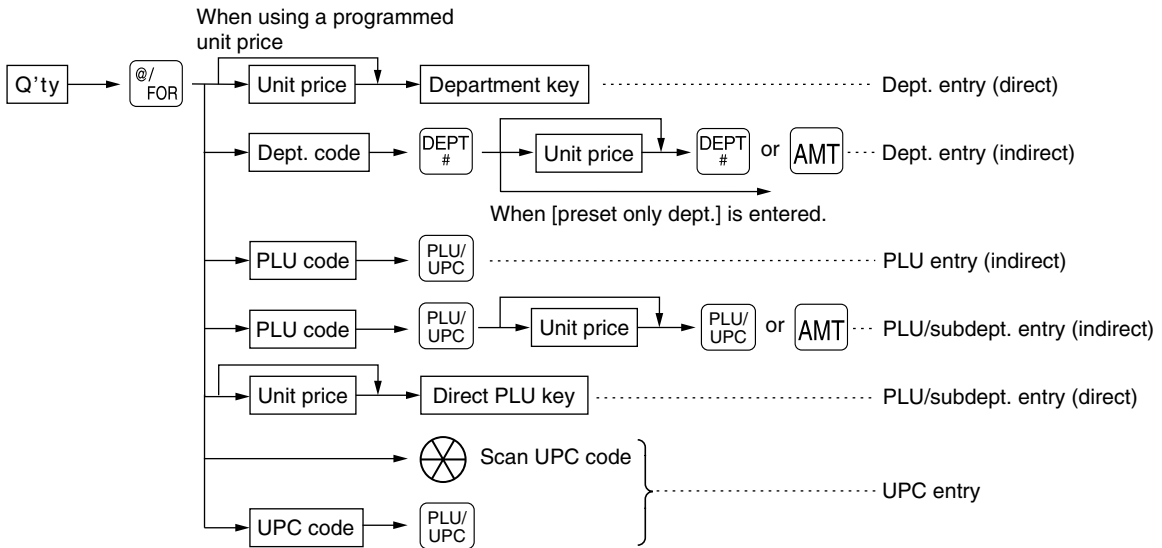

- After scanning a UPC code or pressing the **PLU/UPC** key, when the item does not exist in the file, the display will show "NO RECORD". Enter the unit price using the **AMT** key and department no. with the **DEPT #** key.
- Q'ty: Up to four digits integer + three digits decimal
- Unit price: Less than a programmed upper limit
- Q'ty × unit price: Up to seven digits

Example

Key operation

Department entry (direct)	{	7	•	500	@/FOR
				165	8
Department entry (indirect)	{	2	@/FOR	5	DEPT #
		250	DEPT #		
PLU entry (indirect)	{	15	@/FOR		
		13	PLU/UPC		
PLU entry (direct)	{	8	•	250	@/FOR
					58
Subdepartment entry	{	3	@/FOR		
		60	PLU/UPC		
		100	PLU/UPC		
UPC entry	{	5	@/FOR		
		5012345678900	PLU/UPC		
			CA/AT		

Print

	7.500 @ \$1.65
DPT. 08	\$12.38
	2 @ \$2.50
DPT. 05	\$5.00
	15 @ \$2.10
PLU00013	\$31.50
	8.250 @ \$3.00
PLU00058	\$24.75
	3 @ \$1.00
PLU00060	\$3.00
	5 @ \$2.50
5012345678900#	
APPLE	\$12.50
CASH	\$89.13

Note

You must use a decimal point (•) key when entering quantities that are fractional.

■ Successive multiplication entries

This function may be desired when you enter a sale of items sold by area (square feet).

Procedure

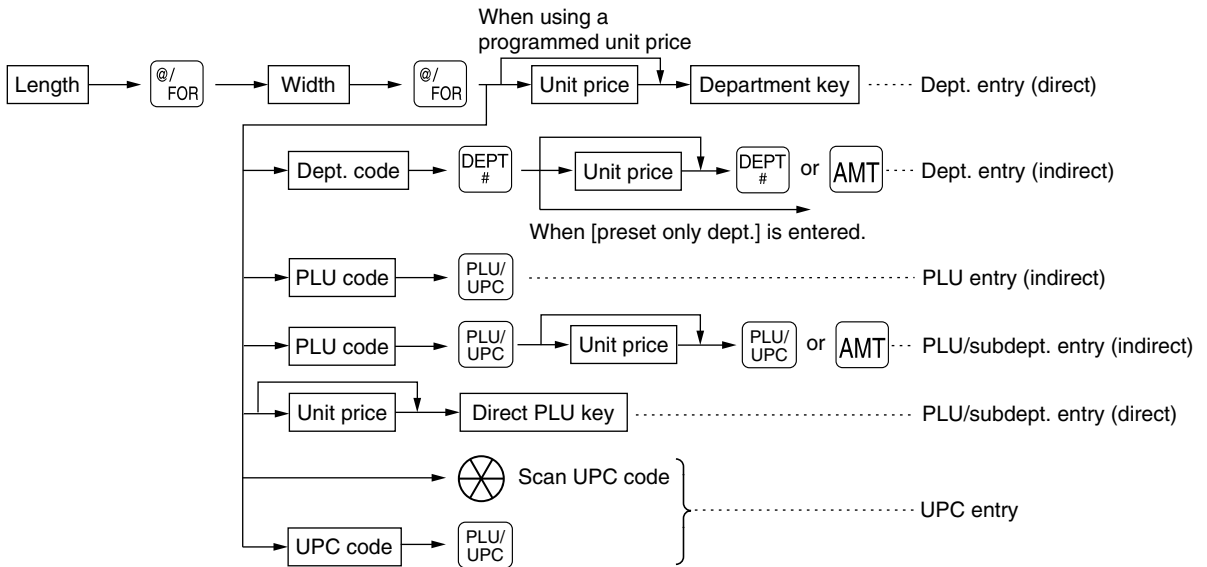

- After scanning a UPC code or pressing the $\left[\frac{\text{PLU}}{\text{UPC}} \right]$ key, when the item does not exist in the file, the display will show "NO RECORD". Enter the unit price using the $\left[\text{AMT} \right]$ key and department no. with the $\left[\text{DEPT} \right]$ key.
- Length or width: Up to seven digits (4-digit integer + 3-digit decimal)
- Unit price: Less than a programmed upper limit
- Length \times Width \times Unit price: Up to seven digits

Note

- For actual use of this function, please consult your dealer.
- You must use a decimal point ($\left[\cdot \right]$) key when entering quantities that are fractional.

Example

	Key operation	Print
Department entry	3 $\left[\frac{\text{@}}{\text{FOR}} \right]$	<pre> DPT. 05 3 @ 4 @ \$4.00 1.500 @ 2.500 @ \$3.00 PLU00008 1.750 @ 1.750 @ \$6.00 PLU00006 4 @ 5 @ \$5.00 5099887654302# CLOTH \$100.00 CASH \$177.63 </pre>
	4 $\left[\frac{\text{@}}{\text{FOR}} \right]$	
PLU entry	400 $\left[5 \right]$	
	1 $\left[\cdot \right]$ 500 $\left[\frac{\text{@}}{\text{FOR}} \right]$	
Subdepartment entry	2 $\left[\cdot \right]$ 500 $\left[\frac{\text{@}}{\text{FOR}} \right]$	
	8 $\left[\frac{\text{PLU}}{\text{UPC}} \right]$	
	1 $\left[\cdot \right]$ 750 $\left[\frac{\text{@}}{\text{FOR}} \right]$	
	1 $\left[\cdot \right]$ 750 $\left[\frac{\text{@}}{\text{FOR}} \right]$	
UPC entry	6 $\left[\frac{\text{PLU}}{\text{UPC}} \right]$	
	600 $\left[\frac{\text{PLU}}{\text{UPC}} \right]$	
	4 $\left[\frac{\text{@}}{\text{FOR}} \right]$	
	5 $\left[\frac{\text{@}}{\text{FOR}} \right]$	
	5099887654302 $\left[\frac{\text{PLU}}{\text{UPC}} \right]$	
	$\left[\text{CA/AT} \right]$	

Split-pricing entries

You may use this function when your customer wants to purchase items normally sold in bulk.

Procedure

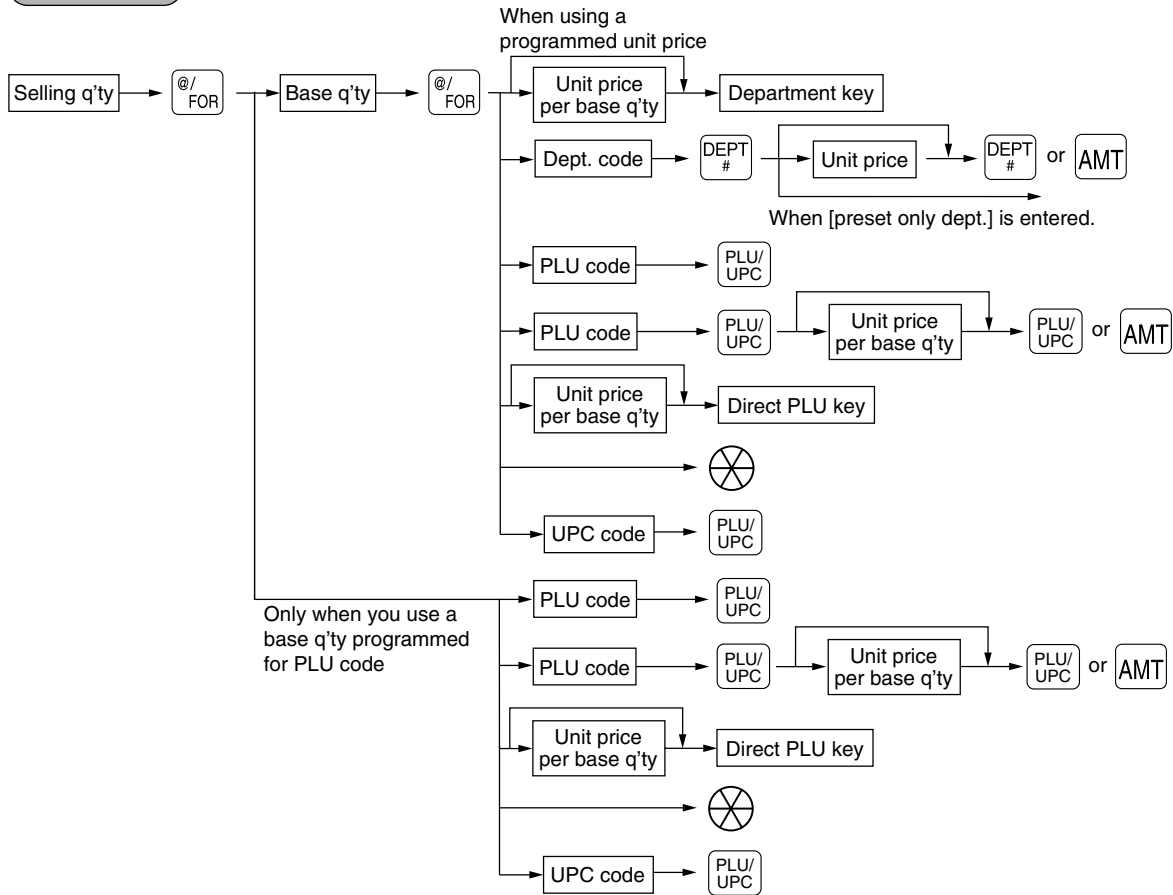

- After scanning a UPC code or pressing the $\left[\frac{\text{PLU}}{\text{UPC}} \right]$ key, when the item does not exist in the file, the display will show "NO RECORD". Enter the unit price using the $\left[\text{AMT} \right]$ key and department no. with the $\left[\frac{\text{DEPT}}{\#} \right]$ key.
- Selling quantity: Up to four digits integer + three digits decimal
- Base quantity: Up to two digits (integer)

Example

	Key operation	Print
Department entry	7 $\left[\frac{\text{@}}{\text{FOR}} \right]$	DPT. 07 7 @ 10/ \$6.00 \$4.20
	10 $\left[\frac{\text{@}}{\text{FOR}} \right]$	
	600 $\left[7 \right]$	
PLU entry	8 $\left[\frac{\text{@}}{\text{FOR}} \right]$	PLU00035 8 @ 5/ \$3.00 \$4.80 5 @ 6/ \$2.50
	5 $\left[\frac{\text{@}}{\text{FOR}} \right]$	
	35 $\left[\frac{\text{PLU}}{\text{UPC}} \right]$	
UPC entry	5 $\left[\frac{\text{@}}{\text{FOR}} \right]$	5045678912304# CUP-A \$2.09 CASH \$11.09
	6 $\left[\frac{\text{@}}{\text{FOR}} \right]$	
	5045678912304 $\left[\frac{\text{PLU}}{\text{UPC}} \right]$	

Note

You must use the decimal point ($\left[\cdot \right]$) key when entering selling quantities that are fractional.

■ Single item cash sale (SICS)/single item finalize (SIF) entries

SICS entries

- This function is useful when a sale is for only one item and is for cash; such as a pack of cigarettes. This function is applicable only to those departments that have been set for SICS or to their associated PLUs, subdepartments or UPCs.
- The transaction is finalized and the drawer opens as soon as you press the department key, **AMT** key, **PLU/UPC** key, the direct PLU key or scanning a UPC code.

Example

Key operation

250
 For finishing → **9**
 the transaction

Print

DPT. 09	\$2. 50
CASH	\$2. 50

Note

If an entry to a department, PLU/subdepartment or UPC set for SICS follows entries to departments, PLUs/subdepartments or UPC not set for SICS, it does not finalize and results in a normal sale.

SIF entries

- If an entry to a department, PLU/subdepartment or UPC set for SIF follows entries to departments, PLUs/subdepartments or UPC not set for SIF, the transaction is finalized immediately as a cash sale.
- Like the SICS function, this function is available for single-item cash settlement.

Example

Key operation

1745 **8**
 1500
 For finishing → **9**
 the transaction

Print

DPT. 08	\$17. 45
DPT. 09	\$15. 00
CASH	\$32. 45

Scale entries

For making entries for weighed items, a scale must be connected where by the weight is automatically read from the scale. To make refund entries, the weight is entered manually while the scale platter is empty and reads zero.

i) Auto scale entries

Procedure

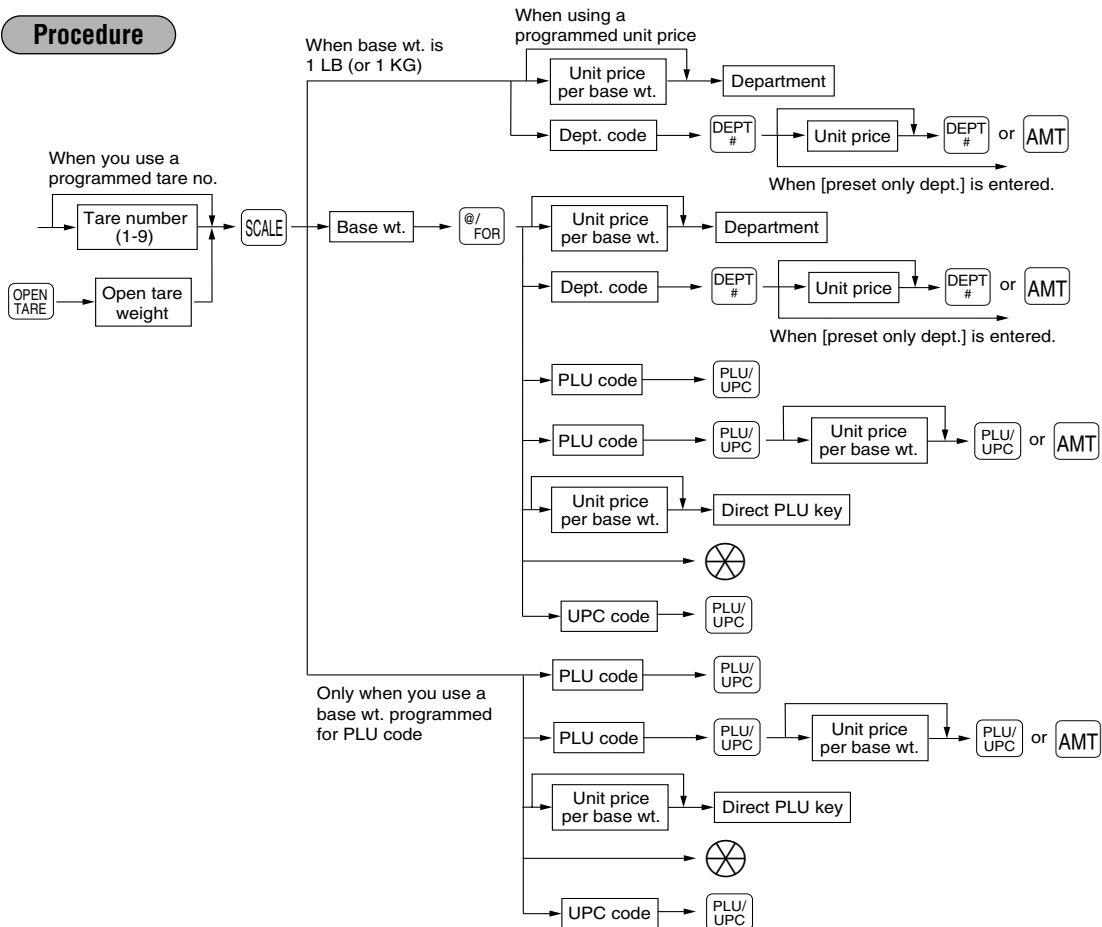

- Open tare weight: Up to 5 digits (integer + decimal)
- Net weight: Up to 5 digits (integer + decimal)
- Base weight: Up to 2 digits (integer)

Note

- The register can be programmed with up to nine tare tables and allows different tares to be assigned to them.
- When the **SCALE** key is pressed, the weight is automatically read from the connected scale (option) and the net weight appears in the register display.
- When the item is programmed for "Scale compulsory", it is not necessary to press the **SCALE** key.

Example

Key operation

SCALE 200 **1**
SCALE 1 **PLU/UPC**
CAIAT

Print

```

32.45 lb
    @ $2.00/lb
DPT. 01          $64.90
32.45 lb
    @ 15/ $7.15/lb
PLU00001          $15.47

CASH          $80.37
    
```

ii) Manual scale entries of refunded items

Procedure

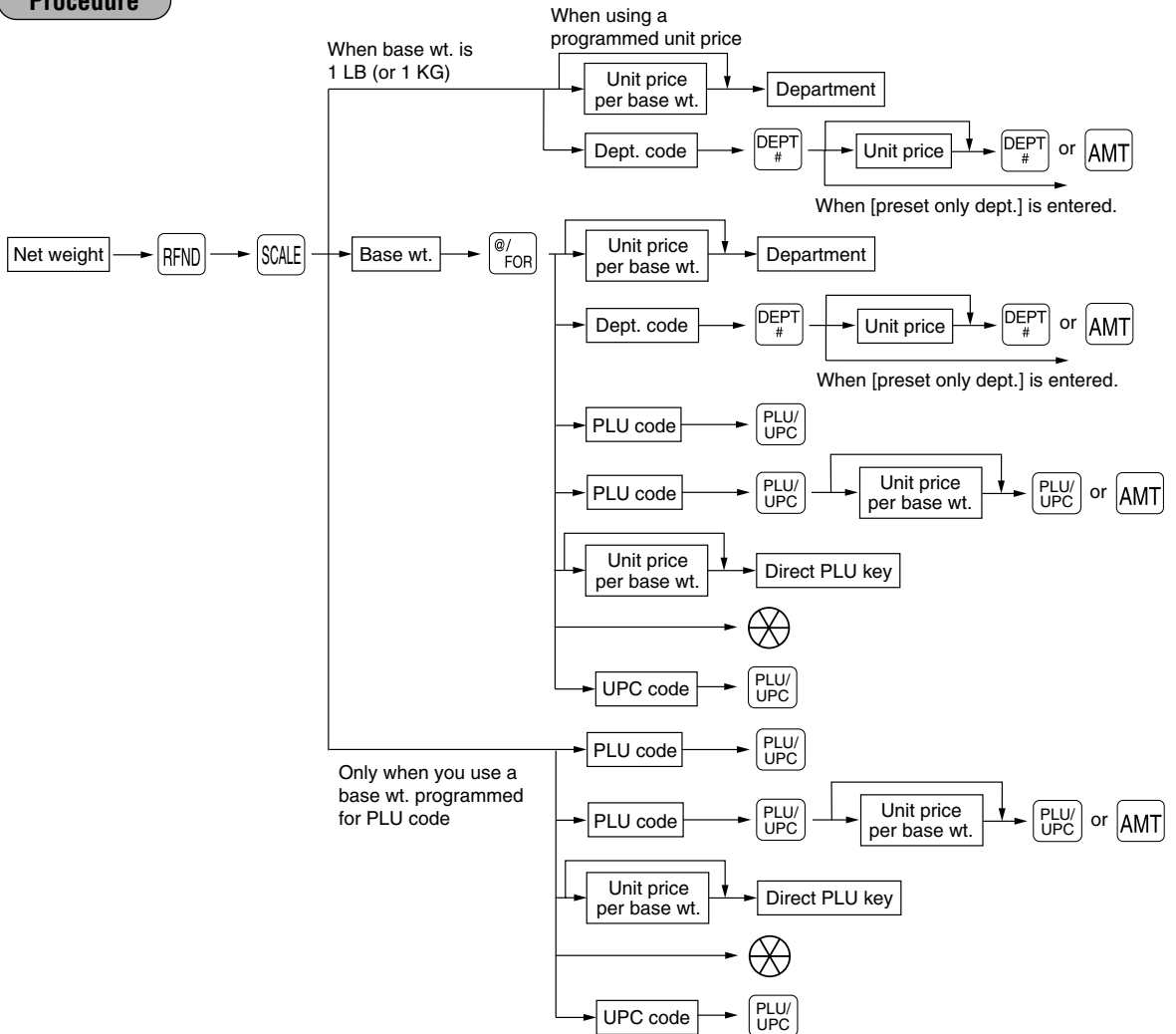

- Net weight: Up to 5 digits (integer + decimal) which is from the customer's receipt.
- Base weight: Up to 2 digits (integer)

Example

Key operation	Print
32 <input type="button" value="."/> 45 <input type="button" value="RFND"/> <input type="button" value="SCALE"/> 200 <input type="button" value="1"/>	<pre> MAN WT 32.45 1b @ \$2.00/1b DPT. 01 R-64.90 "RETURNED FOR CREDIT" MAN WT 32.45 1b @ 15/ \$7.15/1b PLU00001 R-15.47 "RETURNED FOR CREDIT" CHANGE \$80.37 </pre>
32 <input type="button" value="."/> 45 <input type="button" value="RFND"/> <input type="button" value="SCALE"/> 1 <input type="button" value="PLU/UPC"/>	
<input type="button" value="CA/AT"/>	

■ PLU level shift (for direct PLU)

This shift can double or triple the number of PLUs on your register without adding additional direct PLU keys. You can use direct PLUs in three levels by utilizing shift keys **L1**, **L2**, and **L3**. These keys have the following functions.

- L1**: Shifts the PLU level from level 2 or 3 to level 1 (ordinary level).
- L2**: Shifts the PLU level from level 1 or 3 to level 2.
- L3**: Shifts the PLU level from level 1 or 2 to level 3.

You must program your machine in the PGM2 mode to select one of the two PLU level shift modes — automatic return mode* and lock shift mode** — and decide whether to allow PLU level shift in both the REG and MGR modes or in the MGR mode alone.

* The automatic return mode automatically shifts the PLU level back to level 1 after a direct PLU key is pressed.

You can select whether the PLU level should return each time you enter one item or each time you finalize one transaction.

** The lock shift mode holds the current PLU level until a PLU level shift key is pressed.

Automatic return mode

If you shift the PLU level while in the automatic return mode, press the desired PLU level shift key before numeric entries.

Procedure

- each item

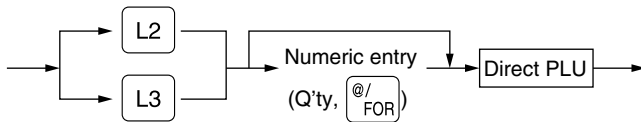

- each transaction

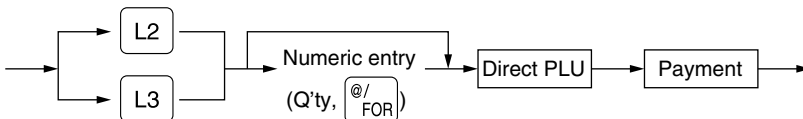

Lock shift mode

If you shift the PLU level while in the lock shift mode, press the desired PLU level shift key before numeric entries.

Procedure

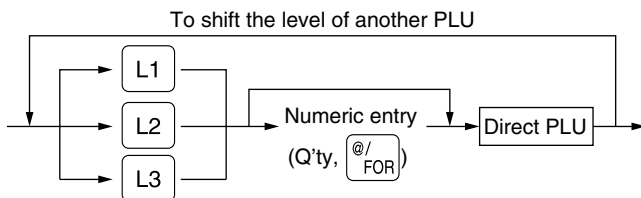

Note If you select the automatic return mode, it is not necessary to use the **L1** key on the keyboard, but if you select the lock shift mode, it is necessary to use the key.

Example

Direct PLU1: PLU code 1 (PLU level 1), PLU code 65 (PLU level 2)

Direct PLU2: PLU code 2 (PLU level 1), PLU code 66 (PLU level 2)

- When your machine has been programmed for the automatic return mode:

Key operation	Print										
	<table border="1"><tr><td>PLU00001</td><td>\$1.25</td></tr><tr><td>PLU00065</td><td>\$12.00</td></tr><tr><td>PLU00002</td><td>\$1.50</td></tr><tr><td>PLU00001</td><td>\$1.25</td></tr><tr><td>CASH</td><td>\$16.00</td></tr></table>	PLU00001	\$1.25	PLU00065	\$12.00	PLU00002	\$1.50	PLU00001	\$1.25	CASH	\$16.00
PLU00001	\$1.25										
PLU00065	\$12.00										
PLU00002	\$1.50										
PLU00001	\$1.25										
CASH	\$16.00										

- When your machine has been programmed for the lock shift mode:

Key operation	Print										
	<table border="1"><tr><td>PLU00001</td><td>\$1.25</td></tr><tr><td>PLU00065</td><td>\$12.00</td></tr><tr><td>PLU00066</td><td>\$30.00</td></tr><tr><td>PLU00065</td><td>\$12.00</td></tr><tr><td>CASH</td><td>\$55.25</td></tr></table>	PLU00001	\$1.25	PLU00065	\$12.00	PLU00066	\$30.00	PLU00065	\$12.00	CASH	\$55.25
PLU00001	\$1.25										
PLU00065	\$12.00										
PLU00066	\$30.00										
PLU00065	\$12.00										
CASH	\$55.25										

■ PLU/UPC price level shift

Two different price levels can be programmed for each PLU or UPC.

The price levels can be changed for PLU or UPC registrations.

You can shift the PLU/UPC price level (level 1 or 2) by utilizing the price level shift key (PRICE SHIFT).

You must program a price level shift mode (i.e. automatic return mode* or lock shift mode**) and the operating mode to be used for the price level shift (i.e. both REG/MGR modes or MGR mode alone).

* The automatic return mode automatically shifts the PLU/UPC price level back to level 1 after a PLU/UPC shift entry. You can select whether the price level should return each time you enter one item or each time you finalize one transaction.

** The lock shift mode holds the current PLU/UPC price level until pressing the price level shift key.

Automatic return mode (for price level)

If your register has been programmed for the price level shift in the automatic return key, press the price level shift key before a numeric entry.

Procedure

(each item)

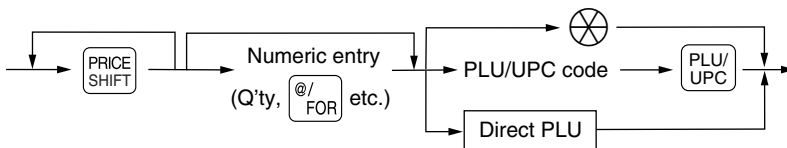

(each transaction)

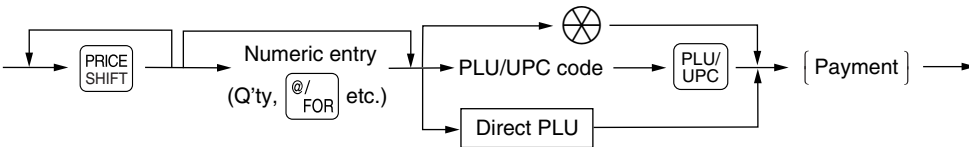

Lock shift mode (for price level)

If your register has been programmed for the price level shift in the lock shift mode, press the price level shift key before a numeric entry.

Procedure

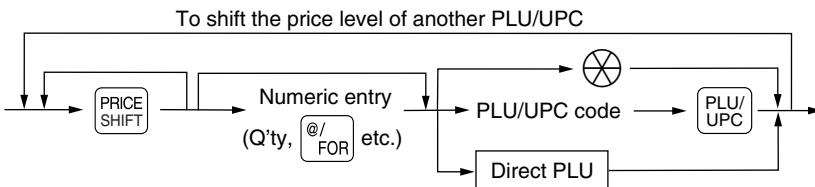

Note





You can program "printing of the price level text (LEVEL 1/LEVEL 2)". Please refer to "Programming for optional feature selection" described in the "PROGRAMMING" section of this manual.

Example





PLU price level 1: PLU 1 (\$1.91), PLU 2 (\$0.79)

PLU price level 2: PLU 1 (\$2.00), PLU 2 (\$0.99)

- When your register has been programmed for the automatic return mode (by one item):

Key operation	Print														
1   1  2  	<table border="1"> <tr><td>LEVEL 1</td><td></td></tr> <tr><td>PLU00001</td><td style="text-align: right;">\$1.91</td></tr> <tr><td>LEVEL 2</td><td></td></tr> <tr><td>PLU00001</td><td style="text-align: right;">\$2.00</td></tr> <tr><td>LEVEL 1</td><td></td></tr> <tr><td>PLU00002</td><td style="text-align: right;">\$0.79</td></tr> <tr><td>CASH</td><td style="text-align: right;">\$4.70</td></tr> </table>	LEVEL 1		PLU00001	\$1.91	LEVEL 2		PLU00001	\$2.00	LEVEL 1		PLU00002	\$0.79	CASH	\$4.70
LEVEL 1															
PLU00001	\$1.91														
LEVEL 2															
PLU00001	\$2.00														
LEVEL 1															
PLU00002	\$0.79														
CASH	\$4.70														

- When your register has been programmed for the lock shift mode:



Key operation	Print														
1   1  2  	<table border="1"> <tr><td>LEVEL 1</td><td></td></tr> <tr><td>PLU00001</td><td style="text-align: right;">\$1.91</td></tr> <tr><td>LEVEL 2</td><td></td></tr> <tr><td>PLU00001</td><td style="text-align: right;">\$2.00</td></tr> <tr><td>LEVEL 2</td><td></td></tr> <tr><td>PLU00002</td><td style="text-align: right;">\$0.99</td></tr> <tr><td>CASH</td><td style="text-align: right;">\$4.90</td></tr> </table>	LEVEL 1		PLU00001	\$1.91	LEVEL 2		PLU00001	\$2.00	LEVEL 2		PLU00002	\$0.99	CASH	\$4.90
LEVEL 1															
PLU00001	\$1.91														
LEVEL 2															
PLU00001	\$2.00														
LEVEL 2															
PLU00002	\$0.99														
CASH	\$4.90														

■ Set PLU entries

Operations are the same as normal PLU's.

When a set PLU is entered, an entered or preset amount is printed as the unit price and then those PLUs linked to the set PLU are printed automatically.

Example

Key operation	Print								
 	<table border="1"> <tr><td>PLU00020</td><td style="text-align: right;">\$2.50</td></tr> <tr><td>PLU00201</td><td></td></tr> <tr><td>PLU00202</td><td></td></tr> <tr><td>CASH</td><td style="text-align: right;">\$2.50</td></tr> </table>	PLU00020	\$2.50	PLU00201		PLU00202		CASH	\$2.50
PLU00020	\$2.50								
PLU00201									
PLU00202									
CASH	\$2.50								

Note

The unit price of the set PLU (ex. PLU 20) is the registered amount of the set PLU. The tied PLU's memory is updated only by the entered quantity.

■ Link PLU/UPC entries

The operation is the same as normal PLU's/UPC's. When this PLU/UPC is entered, the linked PLU's amount is included and the linked PLU's label is printed automatically. Only the 1st PLU is affected by the status shift keys (TAX SHIFT, TAX2 SHIFT, TAX3 SHIFT, TAX4 SHIFT or FS SHIFT key). The percent calculation is in effect for the amount of the 1st ranking PLU.

Example

When PLU 21 is linking PLU 25,26,27 as follows

Key operation	Print										
21 PLU/UPC CAVAT	<table border="1"> <tr> <td>PLU00021</td> <td style="text-align: right;">\$3.50</td> </tr> <tr> <td>PLU00025</td> <td style="text-align: right;">\$3.00</td> </tr> <tr> <td>PLU00026</td> <td style="text-align: right;">\$2.00</td> </tr> <tr> <td>PLU00027</td> <td style="text-align: right;">\$8.00</td> </tr> <tr> <td>CASH</td> <td style="text-align: right;">\$16.50</td> </tr> </table>	PLU00021	\$3.50	PLU00025	\$3.00	PLU00026	\$2.00	PLU00027	\$8.00	CASH	\$16.50
PLU00021	\$3.50										
PLU00025	\$3.00										
PLU00026	\$2.00										
PLU00027	\$8.00										
CASH	\$16.50										

■ Age verification (Birthday entry)

The age verification function is used for prohibiting the sale of goods (departments, PLUs or UPCs) for certain aged persons based on a registered birthday.

When a department/PLU/UPC for which a figure other than zero (01 to 99) has been programmed as the age limitation is entered, a birthday entry must be completed.

Procedure

→ XXXXXX → BIRTH

Birthday (five or six digits)

Note

- A birthday entry can be performed two or more times at any point during a transaction, however the last entered birthday remains in effect.
- You can enter the date as far back as 98 years.
[Ex.] When the current year is 2005 : you can enter the year 1907-2005.

Example

Oct. 2, 1985 (When dept. 17 is programmed as the age limitation "17".)

Key operation	Print				
100285 BIRTH 300 17 CAVAT	<table border="1"> <tr> <td>#10/02/85 DPT. 17</td> <td style="text-align: right;">\$3.00</td> </tr> <tr> <td>CASH</td> <td style="text-align: right;">\$3.00</td> </tr> </table>	#10/02/85 DPT. 17	\$3.00	CASH	\$3.00
#10/02/85 DPT. 17	\$3.00				
CASH	\$3.00				

When the preset option for "Birthday print availability (#2616)" is programmed as "Allow", the birthday date is printed.

■ Mix-and-match entries

This function is convenient for matching several PLU/UPC items and selling them in a lump (e.g. bundle sale, multi-packed sale, etc.). The matching q'ty and adjusted amount are assigned to a mix-and-match table. All items that are programmed into the same table are treated as if they belong to one group.

Example

Selling on a mix-and-match basis the following items in table no. 1 to which the matching q'ty "3" and the adjusted amount "\$10.00" are assigned:

- PLU 40 (Unit price: \$5.00)
- PLU 41 (Unit price: \$3.00)
- PLU 42 (Unit price: \$2.50)

Key operation	Print								
Treated as \$5.00 item → <input type="text" value="40"/>	<table border="1"> <tr> <td>PLU00040</td> <td>\$5.00</td> </tr> <tr> <td>PLU00041</td> <td>\$3.00</td> </tr> <tr> <td>PLU00042</td> <td>\$2.00</td> </tr> <tr> <td>CASH</td> <td>\$10.00</td> </tr> </table>	PLU00040	\$5.00	PLU00041	\$3.00	PLU00042	\$2.00	CASH	\$10.00
PLU00040		\$5.00							
PLU00041		\$3.00							
PLU00042		\$2.00							
CASH	\$10.00								
Treated as \$3.00 item → <input type="text" value="41"/>									
Treated as \$2.00 item → <input type="text" value="42"/>									
<input type="text" value="CAAT"/>									

■ Price inquiry (view) function (for PLU/UPCs)

You can use this function when you want to know the unit price of the PLU/UPC item during transaction in the REG/MGR mode.

Procedure

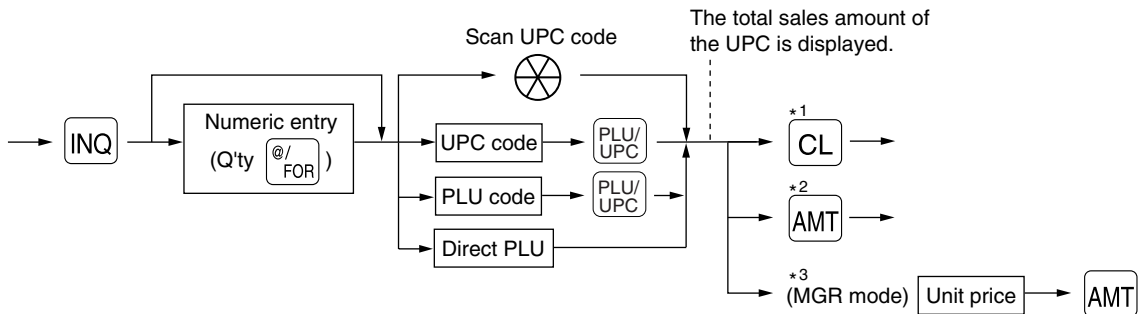

*1: Press the key to cancel the inquiring (view) mode.

*2: Press the key when you want to register the unit price of the PLU/UPC displayed.

*3: You can change the unit price temporarily in the MGR mode. The unit price which is programmed in PGM mode is not changed (Price override entry).

Note For the repeat entry, use the key.

Example

Key operation	Print								
Price is displayed. → 5089123456708	<table border="1"> <tr> <td>PLU00005</td> <td>\$2.00</td> </tr> <tr> <td>5089123456708#</td> <td>\$5.20</td> </tr> <tr> <td>GRAPE</td> <td>\$5.20</td> </tr> <tr> <td>CASH</td> <td>\$7.20</td> </tr> </table>	PLU00005	\$2.00	5089123456708#	\$5.20	GRAPE	\$5.20	CASH	\$7.20
PLU00005		\$2.00							
5089123456708#		\$5.20							
GRAPE		\$5.20							
CASH	\$7.20								
<input type="text" value="5"/> <input type="text" value="PLU/UPC"/>									
<input type="text" value="INQ"/>									
<input type="text" value="PLU/UPC"/>									
<input type="text" value="AMT"/>									
<input type="text" value="CAAT"/>									

■ UPC learning function

When you enter or scan an undefined code, you are required to enter the unit price "amount" and the associated department. The UPC code, unit price and the department entered are stored in the UPC file and is used for future sales entries.

Note

- When there is no capacity remaining in the file, the data is not stored in the file.
- The text of the entered department is applied to the entered UPC code.
- You can use the UPC learning function in the training mode. This may be convenient to practice when installing the scanning system.

Procedure

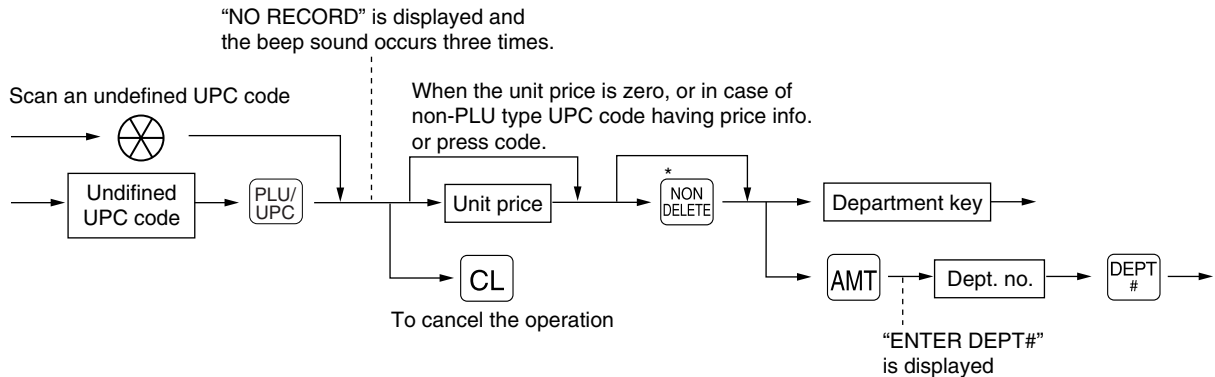

* Press the **NON-DELETE** key when you want to exempt the UPC code entered from the non-accessed UPC delete function (deletion occurs by executing #105 in Z1 mode).

Note

For the repeat entry, use the **REPEAT** key.

Example

Key operation

Print

"NO RECORD" is displayed. →

5056789123404 **PLU/UPC**
 750
5
CAVAT

5056789123404#	
DPT. 05	\$7.50
CASH	\$7.50

■ Price change function (for UPCs)

You can use this function when you need to change the unit price or associated department of a UPC item in REG/MGR mode.

There are two methods for price changes:

1. Price change mode

You can change the preset price and/or the associated department of a UPC item without entering PGM mode.

2. Changing a price during a transaction

When a wrong UPC price and/or associated department is found during transaction, you can correct them at the time of the transaction. With the entry of a new price and/or associated department, the preset price and/or associated department is automatically changed to the new price and/or associated department.

Note For the Non-PLU type price embedded UPC-A codes and press codes, the prices in the codes have the priority over the preset prices. So, for these codes, a changed price is valid only when the price change is executed.

Procedure

Price change mode

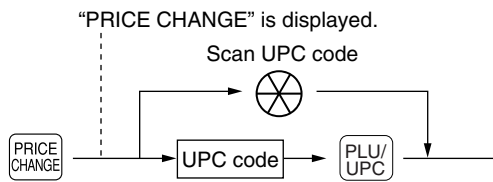

Changing a price during a transaction

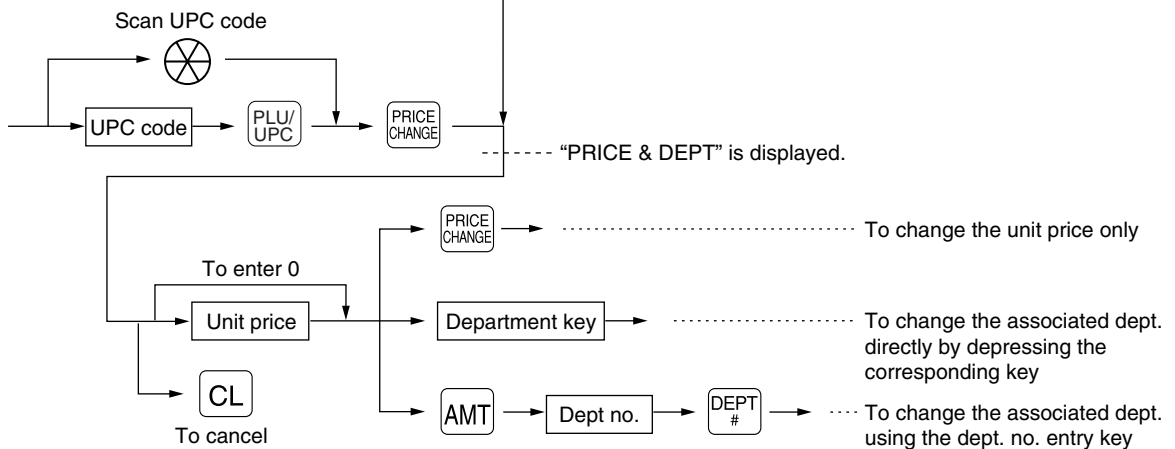

Example

• Price change mode

Key operation	Print
5087654321106 PRICE CHANGE 600 PLU/UPC PRICE CHANGE	<pre> *PR. CHNG * DEPT05 5087654321106# ORANGE \$6.00 </pre>

• Changing a price during a transaction

Key operation	Print
5087654321106 PLU/UPC 600 PRICE CHANGE PRICE CHANGE CA/AT	<pre> 5087654321106# ORANGE \$5.30 5087654321106# ORANGE V-5.30 5087654321106# ORANGE \$6.00 CASH \$6.00 </pre>

The journal printer prints the following format in this position.

```

*PR. CHNG *
DEPT05
          
```

Associated dept. no.

Note

- When an undefined code is entered in the price change mode, the register results in an error.
- When you press the PRICE CHANGE key during a transaction, the UPC entry is voided upon the 1st depression of the PRICE CHANGE key, then you are allowed to enter a correct price and/or associated department.
- When an associated department is changed, the item label for the department will be also changed automatically to the item label of new associated department entered.
- For the repeat entry, use the REPEAT key.

2 Displaying and printing subtotals



Your register provides these five types of subtotals:

■ Merchandise subtotal



Press the  key at any point during a transaction. The net sale subtotal - not including tax - will appear in the display.

■ Taxable subtotal



Taxable 1 subtotal

Press the  and  keys in this order at any point during a transaction. The sale subtotal of taxable 1 items will appear in the display.



Taxable 2 subtotal

Press the  and  keys in this order at any point during a transaction. The sale subtotal of taxable 2 items will appear in the display.

Taxable 3 subtotal

Press the  and  keys in this order at any point during a transaction. The sale subtotal of taxable 3 items will appear in the display.

Taxable 4 subtotal

Press the  and  keys in this order at any point during a transaction. The sale subtotal of taxable 4 items will appear in the display.

■ Including-tax subtotal (full subtotal)

Press the  key at any point during a transaction. The sale subtotal including tax will appear in the display.

■ Food stamp-eligible subtotal

Press the  key at any point during a transaction. The sale subtotal of items eligible for food stamp payment will appear in the display.

■ Tray subtotal

Press the  key during a transaction in the REG or MGR mode.

The contents of the tray total itemizer which include tax are printed and displayed.

3 Finalization of transaction

■ Cash or Check tendering

Press the **SBTL** key to get an including-tax subtotal, enter the amount tendered by your customer, then press the **CA1AT** or **CA2** key if it is a cash tender or press the **CHK** or **CHK2** key if it is a check tender. When the amount tendered is greater than the amount of the sale, your register will show the change due amount and the text "CHANGE". Otherwise your register will show the text "DUE" and a deficit. Make a correct tender entry.

Example

Your customer pays \$10.00 for an including-tax subtotal of \$7.35.

Cash tendering

Key operation	Print
<pre> } SBT 1000 CA1</pre>	<pre>***TOTAL \$7.35 CASH \$10.00 CHANGE \$2.65</pre>

Check tendering

Key operation	Print
<pre> } SBT 1000 CHK</pre>	<pre>***TOTAL \$7.35 CHECK1 \$10.00 CHANGE \$2.65</pre>

■ Mixed tendering (check + cash)

Example

Your customer pays \$10.00 by check and \$5.00 in cash for an including-tax subtotal of \$14.56.

Key operation	Print
<pre> } SBT 1000 CHK 500 CA1</pre>	<pre>***TOTAL \$14.56 CHECK1 \$10.00 CASH \$5.00 CHANGE \$0.44</pre>

■ Cash or Check sale that does not need any tender entry

Enter items and press the **CAIAT** or **CA2** key if it is a cash sale or press the **CHK** or **CHK2** key if it is a check sale. Your register will display the total sale amount.

Example

Selling a \$3.00 item (dept. 6) and another \$7.15 item (PLU 10) for cash

Key operation	Print								
300 6 10 PLU/UPC CAIAT	<table border="1"> <tr> <td>DPT. 06</td> <td style="text-align: right;">\$3.00</td> </tr> <tr> <td>PLU00010</td> <td style="text-align: right;">\$7.15</td> </tr> <tr> <td>CASH</td> <td style="text-align: right;">\$10.15</td> </tr> </table> <p style="text-align: center;">In the case of check sale</p> <table border="1"> <tr> <td>CHECK1</td> <td style="text-align: right;">\$10.15</td> </tr> </table>	DPT. 06	\$3.00	PLU00010	\$7.15	CASH	\$10.15	CHECK1	\$10.15
DPT. 06	\$3.00								
PLU00010	\$7.15								
CASH	\$10.15								
CHECK1	\$10.15								

■ Charge (credit) sale

Enter items and press the corresponding charge keys (**CH** thru **CH5**).

Example

Selling a \$25.00 item (dept. 6) and a \$32.50 item (dept. 7) and accepting the payment by charge account

Key operation	Print						
2500 6 3250 7 CH	<table border="1"> <tr> <td>DPT. 06</td> <td style="text-align: right;">\$25.00</td> </tr> <tr> <td>DPT. 07</td> <td style="text-align: right;">\$32.50</td> </tr> <tr> <td>CHARGE1</td> <td style="text-align: right;">\$57.50</td> </tr> </table>	DPT. 06	\$25.00	DPT. 07	\$32.50	CHARGE1	\$57.50
DPT. 06	\$25.00						
DPT. 07	\$32.50						
CHARGE1	\$57.50						

Amount tendering operations (i.e., change calculations) can be achieved by the **CH** thru **CH5** key when it has been preset in PGM2 job #2320.

■ Mixed-tender sale (cash or check tendering + charge tendering)

Example

Your customer pays \$9.50 in cash and \$40.00 by charge for an including-tax subtotal of \$49.50.

Key operation	Print						
} 950 SBTL CAIAT CH	<table border="1"> <tr> <td>***TOTAL</td> <td style="text-align: right;">\$49.50</td> </tr> <tr> <td>CASH</td> <td style="text-align: right;">\$9.50</td> </tr> <tr> <td>CHARGE1</td> <td style="text-align: right;">\$40.00</td> </tr> </table>	***TOTAL	\$49.50	CASH	\$9.50	CHARGE1	\$40.00
***TOTAL	\$49.50						
CASH	\$9.50						
CHARGE1	\$40.00						

Note

Press the **CHK** or **CHK2** key or the **CH** thru **CH5** keys in place of the **CAIAT** key when your customer makes payment by checks or by charge cards.

4 Food stamp calculations

Food stamp tendering

If your customer makes payment (or tendering) in food stamps, obtain the food stamp-eligible subtotal* by pressing the  key and make a food stamp tender entry before entering a cash or check tender.

Note *The food stamp-eligible subtotal* depends upon how your register is programmed based on the food stamp-eligibility of the automatic tax on a sale of items eligible for food stamp payment, or whether your register is programmed to allow the automatic tax to be paid with food stamps or not or to exempt taxation. The example below presupposes that your register has been programmed to exempt taxation.*

When the amount tendered in food stamps is greater than the food stamp-eligible subtotal:

Your register shows two change due amounts in its display.





The food stamp change due appears at the left of the display in dollars and the cash change at the right in cents.

- When you sell only items eligible for food stamp payment.

Example

Your customer purchases a \$4.25 item (dept.4, taxable 1, eligible for food stamp payment) and another \$4.00 item (PLU 34, taxable 2, eligible for food stamp payment) and tenders \$10.00 food stamps for them.

Key operation

425 
 34 
 To display the food stamp-eligible subtotal → 
 1000 

Display shows:

FS	CG	1111
1.00	0.75	

Food stamp change

Cash change

Print

DPT. 04	F _{T1} \$4.25
PLU00034	F _{T2} \$4.00
***TOTAL	\$8.25
FS ST	\$8.25
FS TEND	\$10.00
FS CG	\$1.00
CHANGE	\$0.75





Food stamp change due
Cash change due

- Mixed sale of an item eligible for food stamps and another item not eligible for food stamps

Example

Your customer purchases a \$2.48 item (dept. 5, taxable 1, eligible for food stamps) and another \$5.42 item (dept. 8, nontaxable, ineligible for food stamps) and pays \$5.00 in food stamps and \$5.00 in cash.

Key operation

248 
 542 

 500 
 500 

Display shows:

FS	CG	1111
2.00	0.10	

Food stamp change

Cash change

Print

DPT. 05	F _{T1} \$2.48
DPT. 08	\$5.42
***TOTAL	\$7.90
FS ST	\$2.48
FS TEND	\$5.00
FS CG	\$2.00
CASH	\$5.00
CHANGE	\$0.10

Food stamp change due
Cash change due

When the food stamp tender is smaller than the food stamp-eligible subtotal:

- Accept the remainder in food stamps or in cash or check. If your register is programmed to exempt taxation, additional food stamp tender is not allowed.

Example

Your customer buys a \$3.18 item (dept. 5, taxable 1, eligible for food stamps) and another \$1.24 item (dept.7, taxable 2, eligible for food stamps) and pays \$4.00 in food stamps and the remainder - \$1.00 in cash.

Key operation	Print																		
318 <input type="button" value="5"/> 124 <input type="button" value="7"/> <input type="button" value="FS TEND"/> 400 <input type="button" value="FS TEND"/> To enter the → 100 <input type="button" value="CA/AT"/> cash tendering of the remainder	<table border="0" style="width: 100%;"> <tr> <td>DPT. 05</td> <td style="text-align: right;">r₁ \$3.18</td> </tr> <tr> <td>DPT. 07</td> <td style="text-align: right;">r₂ \$1.24</td> </tr> <tr> <td>MDSE ST</td> <td style="text-align: right;">\$4.42</td> </tr> <tr> <td>TAX2</td> <td style="text-align: right;">\$0.02</td> </tr> <tr> <td>***TOTAL</td> <td style="text-align: right;">\$4.44</td> </tr> <tr> <td>FS ST</td> <td style="text-align: right;">\$4.42</td> </tr> <tr> <td>FS TEND</td> <td style="text-align: right;">\$4.00</td> </tr> <tr> <td>CASH</td> <td style="text-align: right;">\$1.00</td> </tr> <tr> <td>CHANGE</td> <td style="text-align: right;">\$0.56</td> </tr> </table>	DPT. 05	r ₁ \$3.18	DPT. 07	r ₂ \$1.24	MDSE ST	\$4.42	TAX2	\$0.02	***TOTAL	\$4.44	FS ST	\$4.42	FS TEND	\$4.00	CASH	\$1.00	CHANGE	\$0.56
DPT. 05	r ₁ \$3.18																		
DPT. 07	r ₂ \$1.24																		
MDSE ST	\$4.42																		
TAX2	\$0.02																		
***TOTAL	\$4.44																		
FS ST	\$4.42																		
FS TEND	\$4.00																		
CASH	\$1.00																		
CHANGE	\$0.56																		

Food stamp status shift

Your machine allows you to shift the programmed food-stamp status of each department, thru , percent key or the PLU key by pressing the key prior to those keys. After each entry is completed, the programmed food stamp status is resumed.

Example

You sell a \$2.32 item of dept. 2 (food-stamp eligible) as a food-stamp ineligible item and another \$3.18 item of PLU 86 (food-stamp ineligible) as a food-stamp eligible item and accept \$4.00 in food stamps and \$2.00 in cash.

Key operation	Print																
232 <input type="button" value="FS SHIFT"/> <input type="button" value="2"/> 86 <input type="button" value="FS SHIFT"/> <input type="button" value="PLU/UPC"/> <input type="button" value="FS TEND"/> 400 <input type="button" value="FS TEND"/> 200 <input type="button" value="CA/AT"/>	<table border="0" style="width: 100%;"> <tr> <td>DPT. 02</td> <td style="text-align: right;">\$2.32</td> </tr> <tr> <td>PLU00086</td> <td style="text-align: right;">r \$3.18</td> </tr> <tr> <td>***TOTAL</td> <td style="text-align: right;">\$5.50</td> </tr> <tr> <td>FS ST</td> <td style="text-align: right;">\$3.18</td> </tr> <tr> <td>FS TEND</td> <td style="text-align: right;">\$4.00</td> </tr> <tr> <td>FS CG</td> <td style="text-align: right;">\$0.00</td> </tr> <tr> <td>CASH</td> <td style="text-align: right;">\$2.00</td> </tr> <tr> <td>CHANGE</td> <td style="text-align: right;">\$0.50</td> </tr> </table>	DPT. 02	\$2.32	PLU00086	r \$3.18	***TOTAL	\$5.50	FS ST	\$3.18	FS TEND	\$4.00	FS CG	\$0.00	CASH	\$2.00	CHANGE	\$0.50
DPT. 02	\$2.32																
PLU00086	r \$3.18																
***TOTAL	\$5.50																
FS ST	\$3.18																
FS TEND	\$4.00																
FS CG	\$0.00																
CASH	\$2.00																
CHANGE	\$0.50																

5 Tax calculations

Automatic tax

When your register is programmed with a tax table (or tax rate) and the tax status of an individual department and PLU is set for taxable, it computes the automatic tax on any item that is entered directly into the department or indirectly via a related PLU.

Example

Selling five \$6.70 items (dept. 1, taxable 1) and one \$7.15 item (PLU 85, taxable 2) for cash

Key operation

5
670
85

Print

	5 @ \$6.70
DPT. 01	T 1 \$33.50
PLU00085	T 2 \$7.15
MDSE ST	\$40.65
TAX1	\$2.01
TAX2	\$0.29
CASH	\$42.95

Manual tax

Your machine allows you to enter tax manually after item entries.

Example

Selling an \$8.00 item (dept. 7) for cash with 50 cents as tax

Key operation

800
50

Print

DPT. 07	\$8.00
M-TAX	\$0.50
CASH	\$8.50

■ Automatic-tax delete

You can delete the automatic tax on the taxable 1, taxable 2, taxable 3 and taxable 4 subtotal of each transaction by pressing the **TAX** key after the subtotal is displayed.

Example

Selling a \$7.25 item (dept. 1, taxable 1) and another \$5.15 item (dept. 3, taxable 2) for cash and entering the sale as a non-taxable one

Key operation	Print										
725 1	<table style="width: 100%; border-collapse: collapse;"> <tr> <td style="width: 60%;">DPT. 01</td> <td style="text-align: right;">T 1 \$7.25</td> </tr> <tr> <td>DPT. 03</td> <td style="text-align: right;">T 2 \$5.15</td> </tr> <tr> <td>TAX1 ST</td> <td style="text-align: right;">\$0.00</td> </tr> <tr> <td>TAX2 ST</td> <td style="text-align: right;">\$0.00</td> </tr> <tr> <td>CASH</td> <td style="text-align: right;">\$12.40</td> </tr> </table>	DPT. 01	T 1 \$7.25	DPT. 03	T 2 \$5.15	TAX1 ST	\$0.00	TAX2 ST	\$0.00	CASH	\$12.40
DPT. 01		T 1 \$7.25									
DPT. 03		T 2 \$5.15									
TAX1 ST		\$0.00									
TAX2 ST		\$0.00									
CASH		\$12.40									
515 3											
TAX SBTL											
TAX											
TAX2 SBTL											
TAX											
CA/AT											

If any of the media keys (i.e. cash, check or charge 1 thru charge 5) are programmed as tax delete in PGM2 mode, the tax can be deleted without using the procedures above. In this case, depressing a corresponding media key alone will always cause the programmed tax to be deleted.

Example

When the **CA2** key is programmed as tax delete for the same case with the above example

Key operation	Print												
725 1	<table style="width: 100%; border-collapse: collapse;"> <tr> <td style="width: 60%;">DPT. 01</td> <td style="text-align: right;">T 1 \$7.25</td> </tr> <tr> <td>DPT. 03</td> <td style="text-align: right;">T 2 \$5.15</td> </tr> <tr> <td>MDSE ST</td> <td style="text-align: right;">\$12.40</td> </tr> <tr> <td>TAX1</td> <td style="text-align: right;">\$0.00</td> </tr> <tr> <td>TAX2</td> <td style="text-align: right;">\$0.00</td> </tr> <tr> <td>CASH2</td> <td style="text-align: right;">\$12.40</td> </tr> </table>	DPT. 01	T 1 \$7.25	DPT. 03	T 2 \$5.15	MDSE ST	\$12.40	TAX1	\$0.00	TAX2	\$0.00	CASH2	\$12.40
DPT. 01		T 1 \$7.25											
DPT. 03		T 2 \$5.15											
MDSE ST		\$12.40											
TAX1		\$0.00											
TAX2	\$0.00												
CASH2	\$12.40												
515 3													
CA2													

■ Tax status shift

Your machine allows you to shift the programmed tax status of each department, ⊖ thru ⊕4, percent key or the PLU key by pressing the TAX SHIFT, TAX2 SHIFT, TAX3 SHIFT and/or TAX4 SHIFT keys before those keys. After each entry is completed, the programmed tax status of each key is resumed.

Example

Selling the following items for cash with their programmed tax status reversed

- One \$13.45 item of dept. 7 (non-taxable) as a taxable 1 item
- One \$7.00 item of PLU 25 (non-taxable) as a taxable 1 and 2 item
- One \$4.00 item of dept. 3 (taxable 2) as a non-taxable item
- Two \$10.50 items of dept. 1 (taxable 1) as taxable 2 items

Key operation

1345 TAX SHIFT 7
 25 TAX SHIFT TAX2 SHIFT PLU/UPC
 400 TAX2 SHIFT 3
 1050 TAX SHIFT TAX2 SHIFT 1
 1
 CAVAT

Print

DPT. 07	T 1	\$13.45
PLU00025	T 2	\$7.00
DPT. 03		\$4.00
DPT. 01	T 2	\$10.50
DPT. 01	T 2	\$10.50
MDSE ST		\$45.45
TAX1		\$1.23
TAX2		\$1.12
CASH		\$47.80

Note

The entry of a multi-taxable item for PST or GST will be prohibited as follows (for Canada).

In case of; Tax 1: PST, Tax 2: PST,
 Tax 3: PST, Tax 4: GST

Taxable 1 and 2 item	prohibited
Taxable 1 and 3 item	prohibited
Taxable 2 and 3 item	prohibited
Taxable 1 and 4 item	allowed
Taxable 2 and 4 item	allowed
Taxable 3 and 4 item	allowed

In case of; Tax 1: PST, Tax 2: PST,
 Tax 3: GST, Tax 4: GST

Taxable 1 and 2 item	prohibited
Taxable 1 and 3 item	allowed
Taxable 2 and 3 item	allowed
Taxable 1 and 4 item	allowed
Taxable 2 and 4 item	allowed
Taxable 3 and 4 item	prohibited

6 Guest Check (PBLU)

This feature is used to store and recall previous or credit balances of an open charge account when a previous balance lookup (PBLU) code is entered. The PBLU code can be 1 to 9999.

■ New charge accounts

For a new customer, open a new charge account by assigning a PBLU code.

Procedure

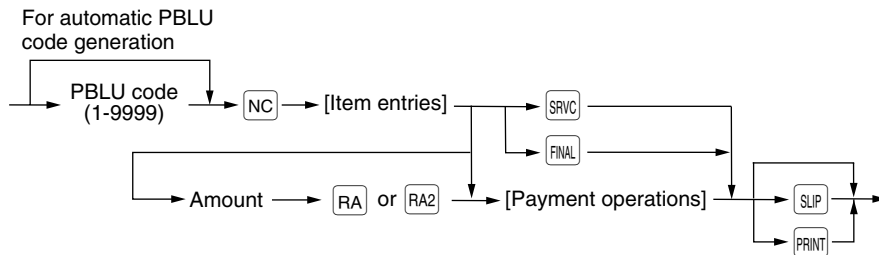

Note

- The PBLU code refers to a code that will be used whenever the guest check must be accessed for re-ordering or final payment.
- Your register can be programmed to generate PBLU codes in a sequential fashion. If your register has not been programmed to do so, each PBLU code can be entered manually.
- When the **SRVC** key is pressed, the tax is not calculated.
- You can temporarily finalize a guest check by pressing the **FINAL** key. This print out of the guest check will show the current balance, including tax. The guest check, however, is still "open". This means you can still make additional orders to it.

Example

Key operation

111 **NC**
 3500 **2**
 2700 **3**
FINAL

Print

```

    ***PBAL          #0111          $0.00
    DPT. 02          T1 $35.00
    DPT. 03          $27.00
    BAL FWD          $62.00
    MDSE ST          $62.00
    TAX1             $2.10

    ***TOTAL        $64.10
  
```

■ Additional item entries

For making additional guest check entries, enter the PBLU code first for automatic PB lookup.

Procedure

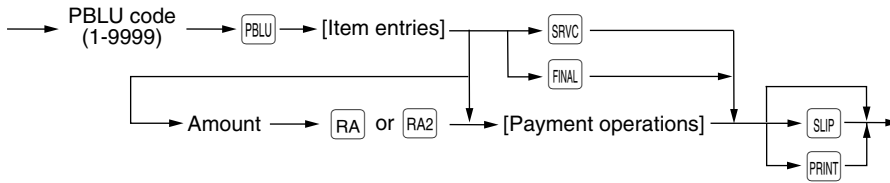

Example

Key operation

111
 1400
 1600

Print

```

    #0111
    ***PBAL      $64.10
    DPT.05      $14.00
    DPT.06      $16.00
    BAL FWD     $30.00

    ***TOTAL    $94.10
  
```

■ Settlement

Use the following procedure:

Procedure

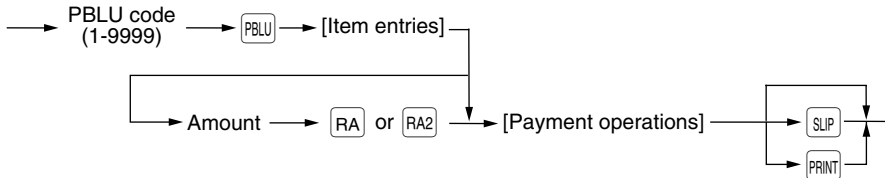

Example

Key operation

111
 9410
 8000
 1410

Print

```

    #0111
    ***PBAL      $94.10
    BAL FWD     $0.00

    ***TOTAL    $94.10
    ***RA       $94.10
    CHECK1      $80.00
    CASH        $14.10
    CHANGE      $0.00
    ***TOTAL    $0.00
  
```

■ Deposit entries

Deposit refers to a payment on a charge account. It can be received in cash, check or by charge. You can make the deposit entry only while in a guest check transaction. It cannot be done during handling of a tendered amount.

A received deposit can be refunded by pressing the **DEPO RFND** key. You cannot attempt to refund an amount larger than the deposit balance.

Procedure

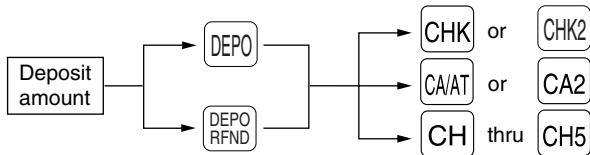

Example

To record a \$50.00 deposit in cash made by a customer with PBLU code 111

Key operation

111 **PBLU**
 5000 **DEPO**
 CA2
 SRVC

Print

	#0111
***PBAL	\$0.00
CASH2	
DEPOSIT	\$50.00
BAL FWD	\$0.00
SERVICE	-50.00

Example

To refund a \$50.00 deposit made by a customer with PBLU code 111

Key operation

111 **PBLU**
 5000 **DEPO RFND**
 CA2
 SRVC

Print

	#0111
***PBAL	-50.00
CASH2	
DPST RF	-50.00
BAL FWD	\$0.00
SERVICE	\$0.00

7 Auxiliary entries

■ Percent calculations (premium or discount)

- Your register provides the percent calculation for the merchandise subtotal and item entries. You need to specify in advance whether the register should perform the percent calculation based on the merchandise subtotal or each item entered.
- Percentage: 0.01 to 99.99%

Percent calculation for the merchandise subtotal

Example

Selling four \$1.40 items of dept. 5 and two \$2.25 items of dept. 7; all these items are sold for cash at a premium of 10%
(This example presumes that a premium of 10% has been programmed for the key.)

Key operation	Print																
4 <input type="button" value="@/ FOR"/>																	
140 <input type="button" value="5"/>																	
225 <input type="button" value="7"/>																	
<input type="button" value="7"/>																	
<input type="button" value="MDSE SBTL"/>																	
<input type="button" value="%"/>																	
<input type="button" value="CA/AT"/>																	
	<table border="1"> <tr> <td></td> <td style="text-align: right;">4 @ \$1.40</td> </tr> <tr> <td>DPT. 05</td> <td style="text-align: right;">\$5.60</td> </tr> <tr> <td>DPT. 07</td> <td style="text-align: right;">\$2.25</td> </tr> <tr> <td>DPT. 07</td> <td style="text-align: right;">\$2.25</td> </tr> <tr> <td>MDSE ST</td> <td style="text-align: right;">\$10.10</td> </tr> <tr> <td></td> <td style="text-align: right;">10.00%</td> </tr> <tr> <td>%1</td> <td style="text-align: right;">\$1.01</td> </tr> <tr> <td>CASH</td> <td style="text-align: right;">\$11.11</td> </tr> </table>		4 @ \$1.40	DPT. 05	\$5.60	DPT. 07	\$2.25	DPT. 07	\$2.25	MDSE ST	\$10.10		10.00%	%1	\$1.01	CASH	\$11.11
	4 @ \$1.40																
DPT. 05	\$5.60																
DPT. 07	\$2.25																
DPT. 07	\$2.25																
MDSE ST	\$10.10																
	10.00%																
%1	\$1.01																
CASH	\$11.11																

Percent calculation for item entries

Example

Selling for cash an \$8.00 item of dept. 6 at a discount of 15% and another \$5.00 item of PLU 90 at a discount of 7.5%
(This example presumes that a discount of 15% has been programmed for the key.)

Key operation	Print														
800 <input type="button" value="6"/>															
<input type="button" value="%2"/>															
90 <input type="button" value="PLU/ UPC"/>															
7 <input type="button" value="."/> 5 <input type="button" value="%2"/>															
<input type="button" value="CA/AT"/>															
	<table border="1"> <tr> <td>DPT. 06</td> <td style="text-align: right;">\$8.00</td> </tr> <tr> <td></td> <td style="text-align: right;">-15.00%</td> </tr> <tr> <td>%2</td> <td style="text-align: right;">-1.20</td> </tr> <tr> <td>PLU00090</td> <td style="text-align: right;">\$5.00</td> </tr> <tr> <td></td> <td style="text-align: right;">-7.5%</td> </tr> <tr> <td>%2</td> <td style="text-align: right;">-0.38</td> </tr> <tr> <td>CASH</td> <td style="text-align: right;">\$11.42</td> </tr> </table>	DPT. 06	\$8.00		-15.00%	%2	-1.20	PLU00090	\$5.00		-7.5%	%2	-0.38	CASH	\$11.42
DPT. 06	\$8.00														
	-15.00%														
%2	-1.20														
PLU00090	\$5.00														
	-7.5%														
%2	-0.38														
CASH	\$11.42														

Discount entries

For discount or coupon tenderings, you may use the \ominus thru $\ominus 4$ key.

If the discount or tendered coupon is the one applicable to sales, use the vendor coupon or if it is applicable to each department key, use the store coupon.

Discount for the merchandise subtotal

Example

Selling a \$5.75 item of dept. 6 and another \$7.50 item of PLU 80 for cash after subtracting the discount amount \$1.00 from the total sale amount

(This example presumes that the vendor coupon has been programmed for the $\ominus 2$ key.)

Key operation	Print
575 $\boxed{6}$	DPT.06 \$5.75
80 $\boxed{\text{PLU/UPC}}$	PLU00080 \$7.50
100 $\boxed{\ominus 2}$	(-) 2 -1.00
$\boxed{\text{CAVAT}}$	CASH \$12.25

Discount for item entries

Procedure

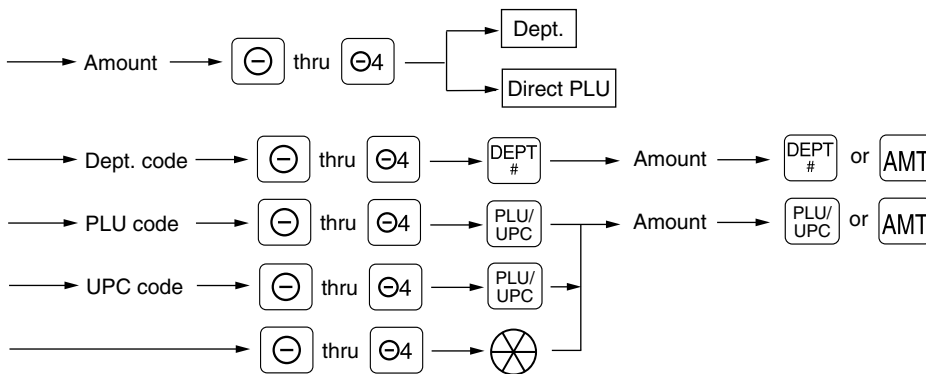

Example

Selling a \$6.75 item of dept. 7 for cash after subtracting the coupon amount 75¢

(This example presumes that the store coupon has been programmed for the \ominus key.)

Key operation	Print
675 $\boxed{7}$	DPT.07 \$6.75
* { 75 $\boxed{\ominus}$	(-) 1
7 $\boxed{7}$	DPT.07 -0.75
$\boxed{\text{CAVAT}}$	CASH \$6.00

Note

* The \ominus is entered as a modifier for the department which will be netted by the coupon amount. Such item netting coupon entries may generally be entered at any point within a transaction. Two lines are printed for each entry: The first is the label programmed for the \ominus function and the second is related department and $\boxed{7}$ amount.

■ Refund entries

If a refund item is the one entered into a department, enter the amount of the refund, then press the **RFND** key and the corresponding department key in this order; and if an item entered into a PLU (or UPC) is returned, enter the corresponding PLU (or UPC) code, then press the **RFND** and **PLU/UPC** keys, or press the **RFND** and direct PLU keys without entry of PLU code, in this order.

Example

Receiving the following items returned:
One \$2.50 item of dept.6 and seven \$2.10 items of PLU 13

Key operation	Print								
250 RFND 6 7 @/FOR 13 RFND PLU/UPC CA/AT	<table border="1"> <tr> <td>DPT. 06</td> <td>R-2.50</td> </tr> <tr> <td></td> <td>-7 @ \$2.10</td> </tr> <tr> <td>PLU00013</td> <td>R-14.70</td> </tr> <tr> <td>CHANGE</td> <td>\$17.20</td> </tr> </table>	DPT. 06	R-2.50		-7 @ \$2.10	PLU00013	R-14.70	CHANGE	\$17.20
DPT. 06	R-2.50								
	-7 @ \$2.10								
PLU00013	R-14.70								
CHANGE	\$17.20								

■ Refund sales mode

This function is used for those item return entries relating to departments, PLUs/subdepartments and UPCs. Pressing the **RFND SALE** key at the beginning of a transaction causes the register to enter the REFUND SALES mode. All of the REFUND SALES mode entries are automatically handled as refund entries. This mode cannot be finalized by check payment entry.

Example

Receiving the following items returned:
One \$2.50 item of dept.6 and seven \$2.10 items of PLU 13

Key operation	Print								
RFND SALE 250 6 7 @/FOR 13 PLU/UPC CA/AT	<table border="1"> <tr> <td>DPT. 06</td> <td>R-2.50</td> </tr> <tr> <td></td> <td>-7 @ \$2.10</td> </tr> <tr> <td>PLU00013</td> <td>R-14.70</td> </tr> <tr> <td>CHANGE</td> <td>\$17.20</td> </tr> </table>	DPT. 06	R-2.50		-7 @ \$2.10	PLU00013	R-14.70	CHANGE	\$17.20
DPT. 06	R-2.50								
	-7 @ \$2.10								
PLU00013	R-14.70								
CHANGE	\$17.20								

■ Printing of non-add code numbers

Enter a non-add code number such as a customer's reference number within a maximum of 16 digits and press the **#** key at any point during the entry of a sale. Your register will print it at the time of entry.

Example

Selling a \$15.00 item of dept. 6 by charge account to a customer whose code number is 1230

Key operation	Print									
1230 # 1500 6 CH	<table border="1"> <tr> <td></td> <td>#1230</td> <td></td> </tr> <tr> <td>DPT. 06</td> <td></td> <td>\$15.00</td> </tr> <tr> <td>CHARGE1</td> <td></td> <td>\$15.00</td> </tr> </table>		#1230		DPT. 06		\$15.00	CHARGE1		\$15.00
	#1230									
DPT. 06		\$15.00								
CHARGE1		\$15.00								

8 Payment treatment

■ Currency conversion

Your register allows payment entries of foreign currency. Pressing the **CONV** thru **CONV4** key creates a subtotal in foreign currency. Cash payment is the only media that can be handled after currency conversion.

Procedure

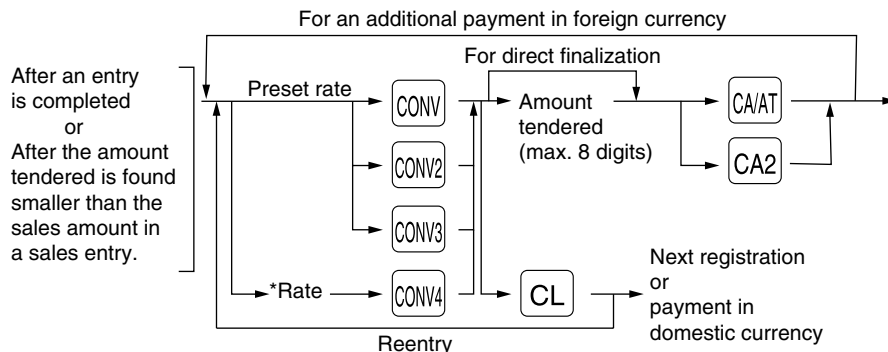

*Rate: 0.000000 to 999.999999

Note When the amount tendered is short, the deficit is shown in domestic currency.

Example To convert the amount owed (\$69.50) into the designated foreign currency

Preset rate (1.325) - CONV 1

Key operation

2300 **6**

Currency conversion → 4650 **7**

Amount tendered in foreign currency → 10000 **CONV**

10000 **CA/AT**

Print

DPT. 06	\$23.00	
DPT. 07	\$46.50	
***TOTAL	\$69.50	Domestic currency
CONV 1	1.3250	Conversion rate
	92.09	Foreign currency
CASH	100.00	
CHANGE	\$5.96	Domestic currency

Manual rate - CONV 4 (The **CONV4** key can be used only for the manual entry.)

Key operation

2300 **6**

4650 **7**

1 **275** **CONV4**

10000 **CA/AT**

Print

DPT. 06	\$23.00	
DPT. 07	\$46.50	
***TOTAL	\$69.50	
CONV 4	1.275	Conversion rate
	88.62	
CASH	100.00	
CHANGE	\$8.92	

■ Received on account entries

Procedure

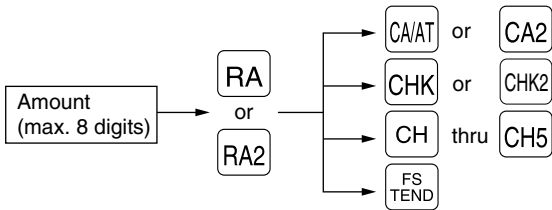

Example

A customer whose reference number is 12345 tenders \$48.00 by check for received on account.

Key operation

12345 [#]
4800 [RA]
[CHK]

Print

```

#12345
CHECK1
***RA           $48.00
  
```

■ Paid out entries

Procedure

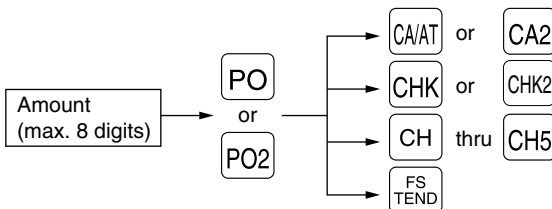

Example

You pay \$30.00 by check to a vendor whose code number is 6789.

Key operation

6789 [#]
3000 [PO]
[CHK]

Print

```

#6789
CHECK1
***PO           $30.00
  
```

■ No sale (exchange)

Simply press the [NS] key without any entry. The drawer will open and the printer will print "NO SALE" on both the journal and the receipt. If your machine is preset to print a non-add code number before pressing the [NS], a no sale entry is achieved with a non-add code number printed.

```

#45678
NO SALE
  
```

■ Cashing a Check

Enter the check amount, then press the **CHK** or **CHK2** key.

Procedure

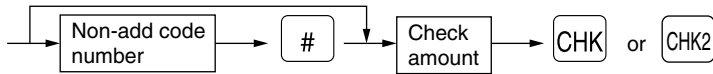

Example

Cashing a check of a \$30.00 amount

Key operation

6789 **#**
3000 **CHK**

Print

CA/CHK	#6789	\$30.00
--------	-------	---------

■ Bottle return

This function is used to handle the payment (paid out) for returned empty bottles or cans.

Example

You pay for ten 15¢ returned empty bottles. (This example presupposes that dept. 11 has been programmed as bottle return department.)

Key operation

10 **@/FOR**
15 **11**
CA/AT

Print

DPT. 11	10 @ -0.15	-1.50
CHANGE		\$1.50

9 Automatic sequencing key (**AUTO** key) entries

You can achieve many different key sequences automatically with a single key depression by using the Auto function key.

Example

Performing the transaction "Selling a \$5.00 item (dept. 7) for cash" programmed for the **AUTO**

AUTO = 500 **7** **CA/AT**

Key operation

AUTO

Print

DPT. 07	\$5.00
CASH	\$5.00

CORRECTION

1 Correction of the last entry (direct void)

If you make an incorrect entry relating to a department, PLU/subdepartment, UPC, percentage (% through %4), deduction (⊖ through ⊖4) or refund, you can correct this entry by pressing the **VOID** key immediately after the incorrect entry.

Example

Key operation

1250 **6**
VOID
 2 **PLU/UPC**
VOID
 5012345678900 **PLU/UPC**
VOID
 600 **8**
%2
VOID
 328 **9**
 28 **⊖** **9**
VOID
 250 **RFND** **8**
VOID
CAIAT

Print

```

DPT. 06      $12.50
DPT. 06      V-12.50
PLU00002     $1.50
PLU00002     V-1.50
5012345678900#
APPLE        $2.50
5012345678900#
APPLE        V-2.50
DPT. 08      $6.00
              -15.00%
%2           -0.90
%2           V$0.90
DPT. 09      $3.28
(-) 1
DPT. 09      -0.28
DPT. 09      V$0.28
DPT. 08      R-2.50
DPT. 08      RV$2.50

CASH        $9.28
  
```

2 Correction of the next-to-last or earlier entries (indirect void)

With the **VOID** key, you can void any incorrect department, PLU/subdepartment, UPC or item refund entry made during a transaction if you find it before finalizing the transaction (e.g. pressing the **CAIAT** key). This function is applicable to department, PLU/subdepartment, UPC and item refund entries only.

For the operation, press the **VOID** key just before you press a department key, **DEPT #** key, direct PLU key, **PLU/UPC** key or just before you scan a UPC code. For the refund indirect void, press the **VOID** key after you press the **RFND** key.

Example

Key operation

1310 **6**
 1755 **7**
 10 **PLU/UPC**
8
 58 **PLU/UPC**
 825 **7**
 5012345678900 **PLU/UPC**
 1310 **VOID** **6**
VOID **8**
 58 **VOID** **PLU/UPC**
 5012345678900 **VOID** **PLU/UPC**
CAIAT

Print

```

DPT. 06      $13.10
DPT. 07      $17.55
PLU00010     $7.15
PLU00008     $3.00
PLU00058     $3.00
DPT. 07      $8.25
5012345678900#
APPLE        $2.50
DPT. 06      V-13.10
PLU00008     V-3.00
PLU00058     V-3.00
5012345678900#
APPLE        V-2.50

CASH        $32.95
  
```

3 Subtotal void

You can void an entire transaction. Once the subtotal void is executed, the transaction is aborted and the register issues a receipt.

Example

Key operation	Print
1310 <input type="button" value="1"/>	DPT. 01 \$13.10
1755 <input type="button" value="6"/>	DPT. 06 \$17.55
10 <input type="button" value="PLU/UPC"/>	PLU00010 \$7.15
35 <input type="button" value="PLU/UPC"/>	PLU00035 \$3.00
Subtotal void {	MDSE ST \$40.80
	SBTL VD -40.80
	***TOTAL \$0.00

4 Correction of incorrect entries not handled by the direct or indirect void function

Any errors found after the entry of a transaction has been completed or during an amount tendered entry, cannot be voided. These errors must be handled by the manager.

The following steps should be observed:

1. If you are in the middle of making an amount tendered entry, you must first finalize the transaction before making corrections.
2. Try to make correct entries from the beginning.
3. Hand the incorrect receipt to your manager for its cancellation.

CORRECTION AFTER FINALIZING A TRANSACTION (AFTER GENERATING A RECEIPT)

When you need to void incorrect entries that are found after finalizing a transaction or cannot be corrected by direct or indirect void, follow this procedure in the MGR mode.

1. Turn the mode switch to the MGR position.
2. Press the **VOID** key to put your register in the VOID mode.
3. Repeat the entries that are recorded on an incorrect receipt. (All data for the incorrect receipt are removed from register memory; the voided amounts are added to the void register totalizer.)

Incorrect receipt

08/27/2004 11:10PM 1111	
123456#1633	DICK
PLU00001	\$1.25
DPT. 02	\$5.00
CASH	\$6. 25



Cancellation receipt

08/27/2004 11:10PM 1111	
123456#1634	DICK
	VOID
PLU00001	\$1.25
DPT. 02	\$5.00
CASH	\$6. 25

Note

Your machine leaves the VOID mode whenever a transaction is canceled (i.e. finalized in the VOID mode.) To void additional transactions repeat steps 2. and 3. above.

OVERRIDE ENTRIES

Programmed limits (such as maximum amounts) for functions can be overridden by making the entry in the MGR mode.

Procedure

1. Turn the mode switch to the MGR position.
2. Make the override entry.

Example

Selling a \$15.00 item (dept. 2) for cash and subtracting the coupon amount \$2.50 from the sale amount (This example presumes that the register has been programmed not to allow coupon entries over \$2.00.)

Key operation

1500
REG-mode 250 ...Error
entries

Turn the mode switch
to the MGR position.

250

Return the mode switch
to the REG position.

Print

DPT. 02	\$15.00
(-) 2	-2.50
CASH	\$12.50

OVERLAPPED CASHIER ENTRY

This function allows you to switch from one cashier to another interrupting the first cashier's entry. The second cashier can make a sales entry, then the first cashier may continue.

Example

Cashier 1: Entry started

Cashier 2: Cashier change (1 to 2), interruption initiated

Cashier 2: Transaction finished (2)

Cashier 1: Cashier change (2 to 1), entry restart

Note

- The overlapped cashier entry is not available while the tendering sale.
- If any cashier is still making an entry (or has not finalized the transaction yet), the machine does not run in any mode other than REG and MGR and X/Z reports can not be performed. The error message "CASHIER ERR." and the corresponding cashier code(s) are displayed at this time.

Key operation	Comments
1. Cashier 1 is assigned.	The entry by cashier 1 is started.
	(1) <input type="text" value="CASH #"/>
	100 <input type="text" value="1"/>
	360 <input type="text" value="3"/>
	<input type="text" value="3"/>
2. Cashier 2 is assigned.	The entry by cashier 2 is started. (The entry by cashier 1 is interrupted.)
	2 <input type="text" value="CASH #"/>
	3 <input type="text" value="CASH #"/>
	150 <input type="text" value="2"/>
	<input type="text" value="CA/AT"/>
3. Cashier 1 is assigned.	The entry by cashier 1 is restarted.
	1 <input type="text" value="CASH #"/>
	100 <input type="text" value="1"/>
	360 <input type="text" value="3"/>
	<input type="text" value="CA/AT"/>
	The transaction by cashier 1 is finalized.

SPECIAL PRINTING FUNCTIONS

1 Copy receipt printing

If your customer wants a receipt after you have finalized a transaction with the receipt ON-OFF function in the "OFF" status (no receipting), press the **RCPT** key. This will make a copy receipt. Your register can also print a copy receipt when the receipt ON-OFF function is in the "ON" status.

Note Pressing the **RCPT** key in the **OP X/Z** mode before registration toggles the status "ON" and "OFF".

Example

Printing a copy receipt after making the entries shown below with the receipt ON-OFF function in the "OFF" status

Key operation	Print
850 2 3 @/FOR 150 1 CA/AT	<div style="border: 1px solid black; padding: 5px; margin-bottom: 10px;"> <p>08/27/2004 11:16PM 1111 123456#1635 DICK DPT. 02 \$8.50 3 @ \$1.50 DPT. 01 \$4.50 CASH \$13.00</p> </div> Print on the journal
For receipting → RCPT	<div style="border: 1px solid black; padding: 5px;"> <p>08/27/2004 11:16PM 1111 123456#1635 DICK DPT. 02 \$8.50 3 @ \$1.50 DPT. 01 \$4.50 CASH \$13.00</p> </div> Print on the receipt

When the receipt ON-OFF function is in the "ON" status and you press the **RCPT** key to make a second copy

08/27/2004 11:16PM 1111
123456#1635 DICK

COPY

DPT. 02 \$8.50
3 @ \$1.50
DPT. 01 \$4.50
CASH \$13.00





When the receipt ON-OFF function is in the "ON" status, the ***COPY*** symbol will be printed on the receipt.

2 Validation printing function (Slip printer)

Your register can perform validation printing when it is connected with the slip printer. For the details about the slip printer, contact your authorized SHARP dealer.

1. Set a validation slip to the slip printer.
2. Press the  key. The validation printing will start.

Note When you make an entry for which compulsory validation printing can be overridden by performing the following operation. If you need this function, Contact your authorized SHARP dealer.

1. Move the mode key to the MGR position.
2.    

3 Printing of the employee's arrival and departure times (Slip printer)

Your register can print the employee's arrival and departure time when it is connected with the slip printer. For the details for connecting a slip printer, please contact your authorized SHARP dealer. For printing of the arrival and departure times, you must be in the OP X/Z mode.

Printing of arrival time



Printing of departure time

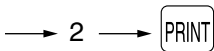

4 Printing of header and footer graphic logos

As an optional setting, your register can print a graphic logo on the top of each receipt (header graphic logo). If preset to do so, a graphic logo can be printed on the bottom of each receipt (footer graphic logo) with the job code #2616. You can also print the graphic logos with the combination of 3-line header logo message or 3-line footer logo message. Printing only logo messages without the graphic logo is possible. Please consult your dealer when you want to change the setting.

• Sample receipt with a header graphic logo and a footer graphic logo

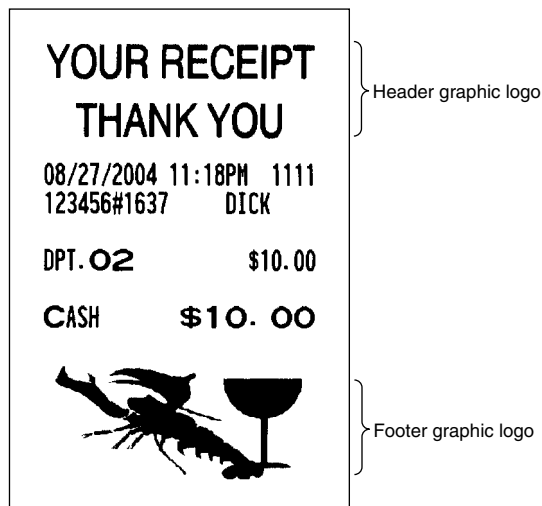

5 Remote printer send function

This function enables a partial order to be sent to the kitchen for preparation while the remaining order is still being placed.

Example

Item entry →  → Data transfer to the remote printer

Remaining items will be sent to the remote printer when the transaction is finalized.

When this function is used, the subtotal void operation is not allowed.

TIME DISPLAY AND AUTOMATIC UPDATING OF THE DATE

1 Time display

When you need the time displayed, turn the mode switch to the OP X/Z position after the preceding transaction or operation is finalized.

You can also display the time by pressing the # key in the REG or MGR mode.

The time display disappears as soon as you press the CL key in the REG or MGR mode or begin the subsequent entry.

Sample display of 10:25 AM

Date	08-26-2004	0001
Time	10:25 AM	

2 Automatic updating of the date

Once the internal clock unit is started at the correct time, it continues to run as long as the built-in battery is charged, and updates the date (month, day, year) automatically.

PRIOR TO PROGRAMMING

1 Programming keyboard layout

When you are in the PGM1 or PGM2 mode, the keyboard layout will be set to one of the programming layouts as shown below.

For ER-A410

		(NUM)	(SPACE)	∅					¢ æ (BACK SPACE)
↑ RECEIPT	↑ JOURNAL	@/FOR	•	CL	(DC)	(SHIFT-2)	(SHIFT)	U & X	
(~)	(~)	7	8	9	"	"	#	\$	
(~)	(~)	4	5	6	'	*	@	/	
(~)	(~)	1	2	3	:	;	,	.	
(°)	(°)	0	00		+ D	- I	= N	¢ S	
					< E	> J	Pt O	£ T	
								CA/AT/NS	

For ER-A420

↑ RECEIPT	↑ JOURNAL	←	→	◀	▶	↑	↓	"	"	Ñ	¿	{	}	[]	(BACK SPACE)
!	@	#	\$	%	^	&	*	()	'	?	<	>			
1	2	3	4	5	6	7	8	9	0	+	-	@/FOR	•	CL		
Q	W	E	R	T	Y	U	I	O	P	_		7	8	9		
A	S	D	F	G	H	J	K	L	/	=		4	5	6		
	Z	X	C	V	B	N	M	;	:			1	2	3		
(SHIFT)	(DC)	(SPACE)	(SPACE)	(SPACE)	(SPACE)	(SPACE)	(SPACE)	(SPACE)	,	.		0	00		SBTL	CA/AT

Note

- The programming keyboard sheet is transparent, allowing placement over the standard keyboard sheet.
- The shaded area contains the character keys which are used for programming characters.

(DC) : Used to enter the double-size character.

(SHIFT) : Used to change a lower-case letter/upper-case letter.

(SHIFT-2) : Used to select a symbol.



- To enter the letter "¢ ¢", press (SHIFT-2) ¢ æ (SHIFT) ¢ æ
- To enter the upper-case letter "Æ Æ", press ¢ æ (SHIFT) ¢ æ
- To enter the lower-case letter "æ æ", press (SHIFT) ¢ æ (SHIFT) ¢ æ

(BACK SPACE) : Used to back up the cursor for deleting.

(SPACE) : Used to enter a space.

(NUM) : Used to enter a numeric character.

2 How to program alphanumeric characters

You can program alphanumeric characters for departments, PLUs, UPCs, functions, etc. while in the character entry mode.

There are two ways for programming characters: using character keys on the keyboard and entering character codes with the numeric keys on the keyboard.

■ Using character keys on the keyboard

Enter a character according to the position in the programming keyboard layout.

Entering alphanumeric characters

To enter a character, simply press a corresponding character key.

To enter a numeric character, press $\boxed{\text{NUM}}$ key and enter a number by ten keys (0 – 9).

[Ex.] Entering the character "135" : $\boxed{\text{NUM}} \rightarrow 135 \rightarrow \boxed{\text{NUM}}$

To enter a space, press the $\boxed{\text{SPACE}}$ key.

Entering double-size characters

$\boxed{\text{DC}}$: This key toggles the double-size character mode and normal-size character mode. The default is the normal-size character mode. The double-size character is displayed with the letter "=" (ex. =S).

[Ex.] To program the name "SHARP" in double size : $\boxed{\text{DC}} \rightarrow \text{SHARP} \rightarrow \boxed{\text{DC}}$

Entering lower-case letters

$\boxed{\text{SHIFT}}$: You can enter a lower-case letter by using this key. Press $\boxed{\text{SHIFT}}$ key just before you enter the lower-case letter. This key also allows you to enter the characters/symbols shown at the upper right of keys.

[Ex.] To program the name "Sharp" : $\rightarrow \text{S} \rightarrow \boxed{\text{SHIFT}} \rightarrow \text{harp} \rightarrow \boxed{\text{SHIFT}}$

Entering symbols shown at the upper left of keys

$\boxed{\text{SHIFT-2}}$: You can enter symbols by using this key. Press $\boxed{\text{SHIFT-2}}$ key just before you enter the symbol.

[Ex.] To program the symbol "¢ ¢" : $\rightarrow \boxed{\text{SHIFT-2}} \rightarrow \text{¢} \rightarrow \boxed{\text{SHIFT-2}} \rightarrow \text{¢}$

"(v)", "(^)", "(..)", "(\)", "(/)", "(/ /)", "(o)", and "(~)" keys are used only in combination with a character key. If the combination is unavailable, only a character key is entered. [Ex.] "Å" : $\rightarrow \boxed{\text{O}}$ $\rightarrow \text{A}$

Editing text

You can edit the text you have entered by deleting characters.

$\boxed{\text{BACK SPACE}}$: Backs up the cursor for deleting the character or figure at the left of the cursor.

■ Entering character codes

Numerals, letters and symbols are programmable by entering the $\boxed{00}$ key and character codes. See the "Alphanumeric character code table" on the next page. In this way, you can program characters other than the characters shown in the programming keyboard layout.

XXX \rightarrow $\boxed{00}$ XXX: Character code (3 digits)

Note

- Double-size characters can be made by entering the character code 253.

[Ex.] To program the name "SHARP" in double size

253 $\boxed{00}$ 083 $\boxed{00}$ 072 $\boxed{00}$ 065 $\boxed{00}$ 082 $\boxed{00}$ 080 $\boxed{00}$
(DC) S H A R P

Alphanumeric character code table

Code	Character	Code	Character	Code	Character	Code	Character	Code	Character
001	á	046	.	091	Å	136	→	193	ı
002	â	047	/	092	Ö	137	↪	194	Ĝ
003	ê	048	0	093	Ü	138	↩	195	Ş
004	î	049	1	094	^	139	◀	196	Ğ
005	ì	050	2	095	_	140	▶	197	ğ
006	í	051	3	096	'	141	F	198	Ƙ
007	ô	052	4	097	a	142	T	199	ƙ
008	ó	053	5	098	b	143	↓	200	ƚ
009	û	054	6	099	c	144	ç	201	ƚ
010	ú	055	7	100	d	145	°	202	Ž
011	œ	056	8	101	e	146	¿	203	Đ
012	ú	057	9	102	f	147	Û	204	đ
013	ú	058	:	103	g	148	à	205	Ć
014	ř	059	;	104	h	149	Æ	206	ć
015	ó	060	<	105	i	150	ø	207	€
016	Λ	061	=	106	j	151	À	208	Ɔ
017	Ψ	062	>	107	k	152	Ǫ	209	˘
018	Γ	063	?	108	l	153	é	210	ě
019	˘	064	@	109	m	154	è	211	š
020	Ω	065	A	110	n	155	Pt	212	č
021	Δ	066	B	111	o	156	i	213	ž
022	Θ	067	C	112	p	157	Ñ	214	ý
023	Ξ	068	D	113	q	158	ò	215	ù
024	Π	069	E	114	r	159	£	216	ň
025	Σ	070	F	115	s	160	¥	217	˘
026	Υ	071	G	116	t	161	◦	218	˘
027	Φ	072	H	117	u	162	Γ	219	ř
028	Ú	073	I	118	v	163	J	224	*
029	Ú	074	J	119	w	164	˘	225	§
030	Ŏ	075	K	120	x	165	˘	226	Ø
031	Ó	076	L	121	y	177	Á	227	˘
032	(space)	077	M	122	z	178	Í	228	↑
033	!	078	N	123	{	180	Ā	229]
034	"	079	O	124		181	ā	230	[
035	#	080	P	125	}	182	Ē	231	"
036	\$	081	Q	126	β	183	ē	232	ä
037	%	082	R	127	¢	184	Ī	233	ö
038	&	083	S	128	!!	185	ī	234	ü
039	'	084	T	129	₁	186	Ū	235	æ
040	(085	U	130	₂	187	ū	236	â
041)	086	V	131	₃	188	Ŭ	237	É
042	*	087	W	132	₄	189	ŭ	238	ñ
043	+	088	X	133	1/2	190	Č	253	*(DC)
044	,	089	Y	134	F/T	191	Š		
045	-	090	Z	135	←	192	Ç		

*(DC) : Double-size character code

 : The shaded character cannot be displayed (will be displayed as space).

Note The character "!!" (code: 128) is displayed as "!".

PROGRAMMING

This chapter illustrates how to program your cash register.

■ Basic instructions

All the programming items can be programmed by the **Job-Code-Based Programming** described later. However, your machine allows you to program some items using the **Direct Programming**, which does not require you to enter the job code.

Job-Code-Based Programming

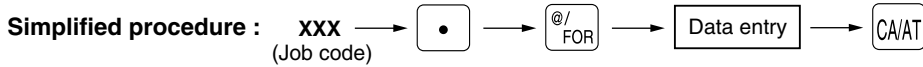

Direct Programming

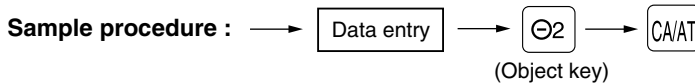

■ Preparations for programming

1. Plug your machine into a standard grounded AC outlet.
2. Turn the mode switch to the PGM1 or PGM2 position.
To set the mode switch to the PGM1 position, use the manager or submanager key; and to set it to the PGM2 position, use the manager key.
3. Check to see whether both journal and receipt rolls are present in the machine. If they are missing, install journal and receipt paper rolls correctly referring to the procedure in "4. Installing and removing the paper roll" under "OPERATOR MAINTENANCE".
4. Program the necessary items into your machine.

Direct Programming

1 Setting the date and time

■ Date PGM 2

Enter the month (one or two digits), day (two digits), and year (four digits : 2000 – 2099) in this sequence.

Procedure

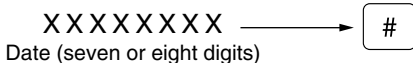

Example

Key operation

08262004 [#]

Print

08/26/2004 12:00AM
000000#0001

PGM2

Date ————— 08/26/2004

Time PGM 2

Set the time using the military time (24-hour) system. For example, when the time is set to 2:30 AM, enter 230; and when it is set to 2:30 PM, enter 1430. The time will be printed and displayed using a real-time system. Once you set the time, the internal clock unit will continue to run as long as the built-in battery is alive and update the date (day, month, year) properly.

Procedure

X X X X → #
Time (max. four digits)

Example

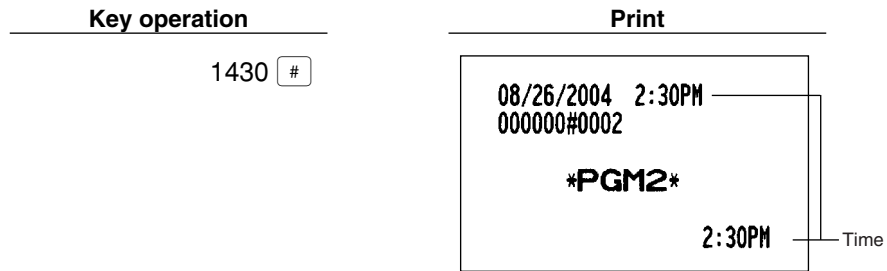

2 Programming for departments

Your machine is equipped with 20 (ER-A410)/10 (ER-A420) standard departments and a maximum of 99 departments. Your machine allows you to perform the following programming for each department.

Unit price PGM 1 PGM 2

Procedure

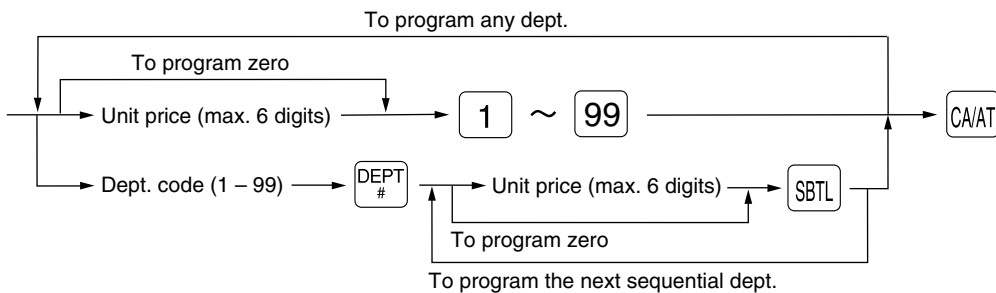

Example

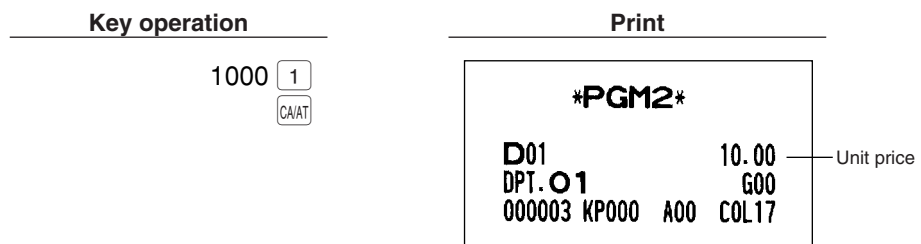

Functional selection PGM 2

Procedure

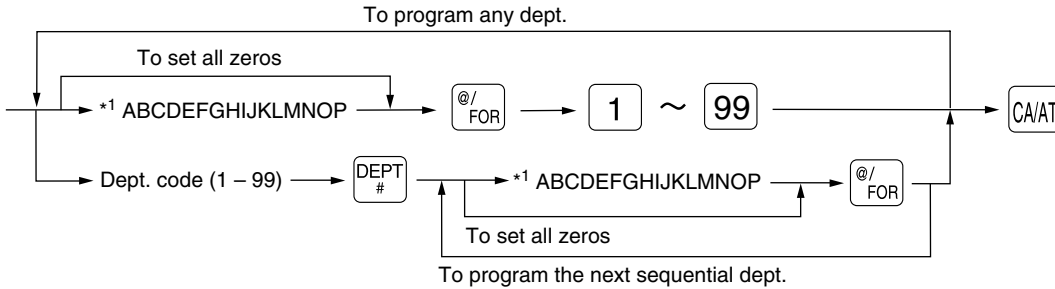

*1 Item:	Selection:	Entry:
A Group number		0 thru 9
B Commission group number		0 thru 9
C Sign (plus/minus)	Plus	0
	Minus	1
D Food stamp status	Ineligible	0
	Eligible	1
E Tax 4 status	Non-taxable	0
	Taxable	1
F Tax 3 status	Non-taxable	0
	Taxable	1
G Tax 2 status	Non-taxable	0
	Taxable	1
H Tax 1 status	Non-taxable	0
	Taxable	1
I Item validation printing	Non-compulsory	0
	Compulsory	1
J Tare table number		1 thru 9
K Scale entry	Inhibit	0
	Enable	1
	Compulsory	2
L Registration type	Normal	0
	SICS (Single Item Cash Sale)	1
	SIF (Single Item Finalization)	2
M Department type	Normal department	0
	Hash department	1
	Bottle return department	2
N Type of unit price entry	Inhibit department key	0
	Open only	1
	Preset only	2
	Open and preset	3
O Significant digit for HALO		1 thru 9
P Number of zeros to follow the significant digit for HALO		0 thru 7

Note

Group number

You can assign a department to a maximum of nine groups. This programming enables you to take group sales reports.

Commission group number

A commission group number (0–9, 0: non commission) can be assigned to each department.

Sign (plus/minus)

- Assign a plus sign to departments for normal sales transactions.
- Assign a minus sign to departments for minus transactions.

Food stamp status

- Assign a food stamp status (food stamp eligible or food stamp ineligible) to each department.

Tax status (taxable 1 thru 4/non-taxable)

- When an entry of a taxable department is made in a transaction, tax is automatically computed according to the associated tax table or rate.
- Tax 4 is prohibited if you use the food stamp function.

Item validation printing

If item entries must be validated, program corresponding departments for compulsory validation printing.

Tare table number

Tare table number associated with scale entry (1 thru 9).

Scale entry

Program a department for scale entry when your store requires items to be sold by weight and are placed on a scale connected to the register.

Registration type

- If an entry of a department programmed for SICS is made first, the sale will be finalized as soon as the department key is pressed. If the entry is made after entering a department not programmed for SICS, the sale will not be finalized until the **CAIAT** key is pressed.
- Whenever a sale is made to a department programmed for SIF, the sale is finalized as soon as the department key is pressed.

Department type

You may program each department as one of the following three types.

- Bottle Return (BR)
- Hash department

A hash department is used to enter the amount of a special "sale", such as a gift certificate sale or for the receipt of payment for utility bills, theatre tickets, etc., i.e. "non-sales" registrations. Any amounts entered in this department are not added to the grand total except tax amounts.

- Normal department.

Type of unit price entry

You may select one of the following four types of unit price entry for each department.

- Open and preset
- Preset only
- Open only
- Inhibit department key

HALO (High Amount Lockout)

You can set an upper limit amount (HALO) for each department. The limit is affective for the REG mode operations and can be overridden in the MGR mode.

- "OP" is the same as $O \times 10^P$

For example, presetting 14 (\$100.00) here means that amount entries of up to \$100.00 are allowed in the REG mode. When you preset 17, the upper limit amount is 99999.99.

Example

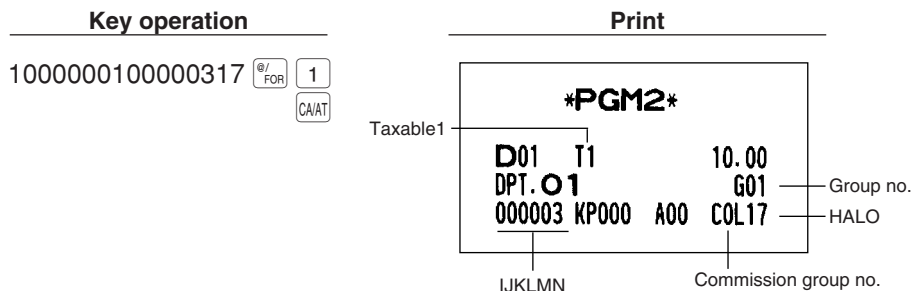

3 PLU/UPC programming

Your machine is equipped with 500 standard PLUs/UPCs. Your machine allows you to perform the following programming for each PLU/UPC.

Note

- In this manual, the word "UPC" represents UPC (Universal Product Code) and the word "EAN" represents EAN (European Article Number).
- To review the UPC codes available to this register, please refer to the chapter 13 in "Job-Code-Based programming".

Unit price PGM 1 PGM 2

Procedure

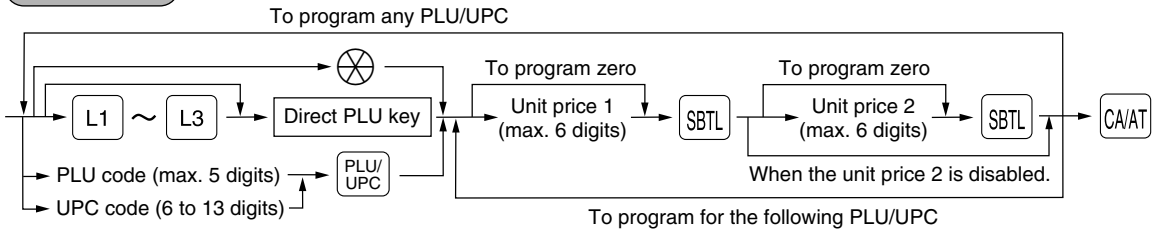

Example

Key operation

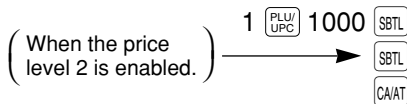

Print

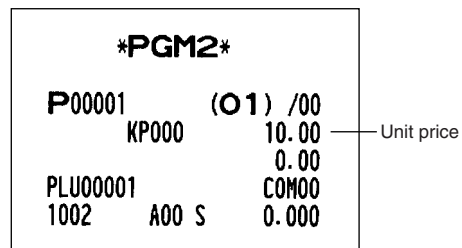

Functional selection PGM 2

Procedure

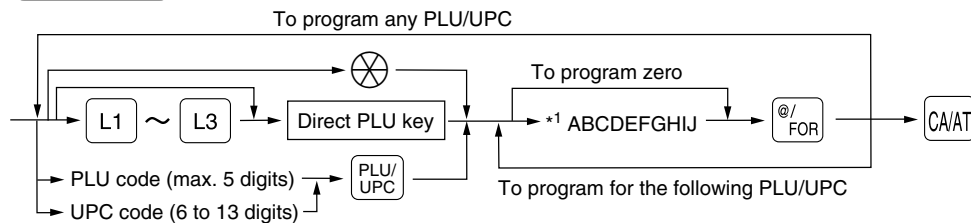

*1 Item:	Selection:	Entry:
A Commission group number		0 thru 9
B Sign (plus/minus)	Plus	0
	Minus	1
C Food stamp status	Ineligible	0
	Eligible	1
D Tax 4 status	Non-taxable	0
	Taxable	1
E Tax 3 status	Non-taxable	0
	Taxable	1
F Tax 2 status	Non-taxable	0
	Taxable	1

*1 Item:	Selection:	Entry:
G Tax 1 status	Non-taxable	0
	Taxable	1
H Tare table number		1 thru 9
I Scale entry	Inhibit	0
	Enable	1
	Compulsory	2
J Type of unit price entry	Prohibit mode	0
	Open price only	1
	Preset price only	2
	Open price and preset price	3
	Delete mode	4

Note

Commission group number

A commission group number (0–9, 0: non commission) can be assigned to each department.

Sign (plus/minus)

The function of every PLU/UPC varies according to the combination of its sign and the sign of its associated department as follows:

Sign		Function of PLU/UPC
Department	PLU/UPC	
+	+	Serves as a normal plus PLU/UPC
-	-	Serves as a normal minus PLU/UPC
+	-	Accepts store coupon entries, but not split-pricing entries
-	+	Not valid; not accepted

Food stamp status

• Assign a food stamp status (food stamp eligible or food stamp ineligible) to each PLU/UPC.

Tax status (taxable 1 thru 4/non-taxable)

- When an entry of a taxable PLU/UPC is made in a transaction, tax is automatically computed according to the associated tax table or rate.
- Tax 4 is prohibited if you use the food stamp function.

Tare table number

Tare table number associated with scale entry (1 thru 9).

Scale entry

Program a PLU/UPC for scale entry when your store requires items to be sold by weight and are placed on a scale connected to the register.

Type of unit price entry

You may select one of the following four types of unit price entry for each PLU/UPC.

- Open price and preset price (for only PLU)
- Preset price only
- Open price only (for only PLU)
- Prohibit mode: Prohibits the entry of any assigned PLU/UPC code.
- Delete mode: Deletes data programmed for each PLU/UPC.

Example

Key operation

1 PLU
UPC 0000001003 @/
FOR
CAIAT

Print

PGM2

P00001 (01) /00
T1 KP000 10.00
0.00

PLU00001 COM00
1003 A00 S 0.000

Taxable1 ———> (points to T1)

(HIJ) ———> (points to 1003)

Commission group no. ———> (points to 000)

PLU/UPC assignment to department PGM 1 PGM 2

Procedure

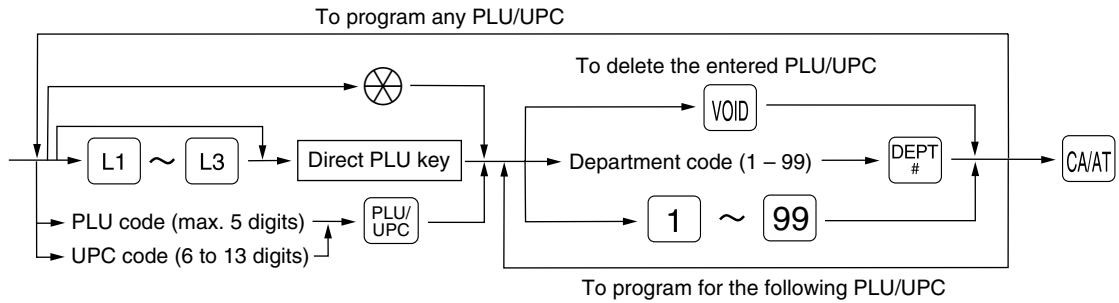

Example

Key operation

1 PLU/UPC 1
CA/AT

Print

```

*PGM2*
P00001 (01) /00
T1 KP000 10.00
          0.00
PLU00001 COM00
1003 A00 S 0.000
    
```

Dept. code

4 Programming for discount keys (⊖)

Discount amount PGM 1 PGM 2

Procedure

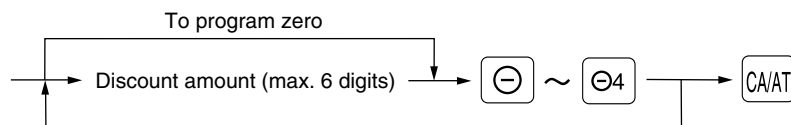

Example

Key operation

1000 ⊖
CA/AT

Print

```

*PGM2*
F001 (-) 1
S          -10.00
L17
    
```

Discount amount

High amount lockout (HALO), sign (+/-), vendor/store coupon selection, food stamp status and tax status PGM 2

Procedure

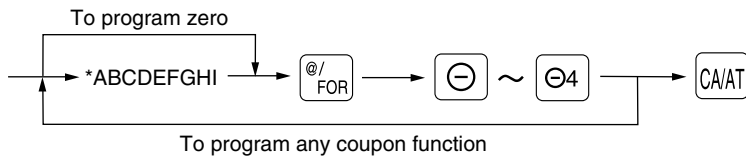

* Item:	Selection:	Entry:
A Food stamp status	Ineligible	0
	Eligible	1
B Tax 4 status	Non-taxable	0
	Taxable	1
C Tax 3 status	Non-taxable	0
	Taxable	1
D Tax 2 status	Non-taxable	0
	Taxable	1
E Tax 1 status	Non-taxable	0
	Taxable	1
F Sign (+/-)	Plus	0
	Minus	1
G Vendor/store coupon selection	Vendor coupon (subtotal ⊖)	0
	Store coupon (item ⊖)	1
H Significant digit for HALO		1 thru 9
I Number of zeros to follow the significant digit for HALO		0 thru 7

Note

Tax status (taxable 1 thru 4/non-taxable)

Tax 4 is prohibited if you use the food stamp function.

HALO (High amount lockout)

"HI" is the same as H x 10^I.

For example, presetting 14 (\$100.00) here means that amount entries of up to \$100.00 are allowed in the REG mode. When you preset 17, however, the upper limit amount is 99999.99.

When you preset 00, the open amount entry is prohibited.

Example

Key operation

000001013 @/FOR ⊖
CA/AT

Print

```

*PGM2*
F001 (-) 1
S          -10.00
           L13 ----- HALO
           |
           |----- Subtotal ⊖
  
```

5 Programming for percent keys (%)

Percent rate PGM 1 PGM 2

Procedure

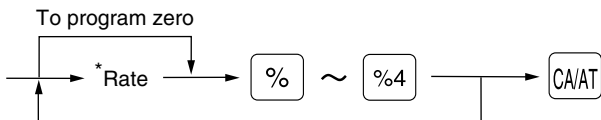

* Rate: Percent rate: 0.00 – 100.00

Note You must use a decimal point key when setting percentage rates that are fractional.

Example

Key operation

10 25

Print

```

*PGM2*
F005 %1
S      3      -10.25%
L100.00%
    
```

Percent rate

Sign (+/-), %item/%subtotal selection, food stamp status and tax status

PGM 2

Procedure

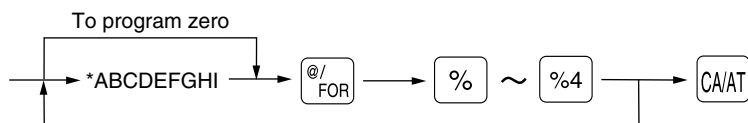

* Item:	Selection:	Entry:
A Food stamp status	Ineligible	0
	Eligible	1
B Tax 4 status	Non-taxable	0
	Taxable	1
C Tax 3 status	Non-taxable	0
	Taxable	1
D Tax 2 status	Non-taxable	0
	Taxable	1
E Tax 1 status	Non-taxable	0
	Taxable	1
F Sign (+/-)	Plus	0
	Minus	1
G %item/%subtotal selection	% for subtotal	0
	% for item	1
H Always enter 0.		0
I Always enter 0.		0

Note**Tax status (taxable 1 thru 4/non-taxable)**

Tax 4 is prohibited if you use the food stamp function.

Example**Key operation**000001000
Print

```

*PGM2*
F005 %1
S      3      -10.25%
L100.00%

```

Subtotal %

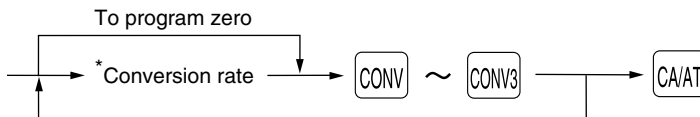
6 Programming for conversion keys (CONV)**■ Currency conversion rate** **Procedure**

* Conversion rate: 0.0000 – 9999.9999

Note

You must use a decimal point key when setting conversion rates that are fractional.

Example**Key operation**1 3250
Print

```

*PGM2*
F071 CONV 1
1.3250

```

7 Programming for the RA, PO, and TAX keys

High amount lockout (HALO) PGM 2

The HALO limit effects REG mode operations but can be overridden in the MGR mode.
The HALO limit is represented by two figures as follows:

Procedure

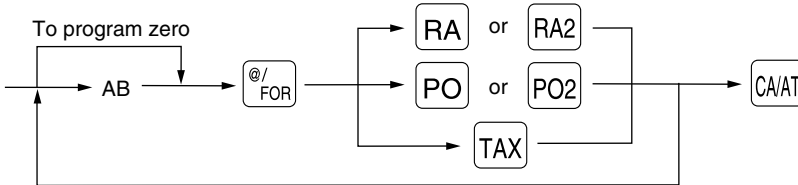

“AB” is the same as $A \times 10^B$.

A: Significant digit (0 through 9)

B: Number of zeros to follow significant digit: (for RA or PO: 0 thru 9), (for manual tax: 0 thru 7)

Example

Key operation

13 RA
 CA/AT

Print

```

*PGM2*
F064 ***RA      L13
  
```

8 Programming for the CA/AT, CA2, CH, and CHK keys

High amount lockout (HALO) and functional selection PGM 2

Procedure

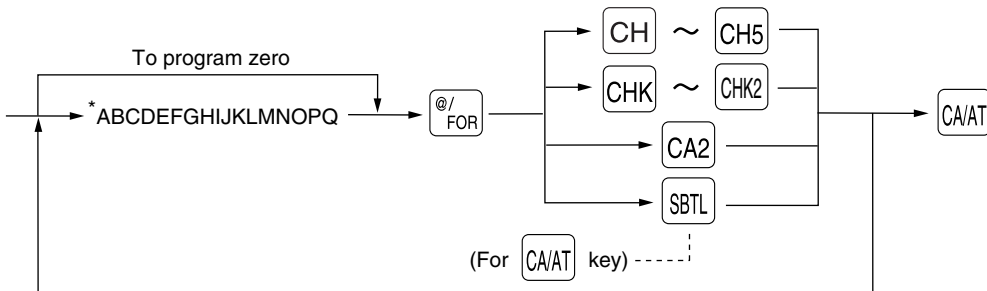

* Item:	Selection:	Entry:	
A	CAT transaction	Non-compulsory	0
		Compulsory	1
B	CAT action	POST-AUTH	0
		DIAL	1
C	CAT type	CREDIT	0
		DEBIT	1
		CHECK	2
D	Card number printing	Yes	0
		No	1
E	Card number print format	Partial (printing only part of the card number)	0
		Full (printing the entire card number)	1
F	CAT signature line print	Yes	0
		No	1
G	CAT expiration printing	Yes	0
		No	1
H	Number of CAT authorization receipt		0 thru 9
I	Bill (slip) printing	Non-compulsory	0
		Compulsory	1
J	Footer printing on receipt	No	0
		Yes	1
K	Non-add code entry	Non-compulsory	0
		Compulsory	1
L	Change enable (over tender enable)	Enable	0
		Disable	1
M	Validation printing	Non-compulsory	0
		Compulsory	1
N	Drawer opening	Yes	0
		No	1
O	Amount tendered operation	Optional amount tendered for cash or check	0
		Inhibit amount tendered for charge	0
		Compulsory amount tendered	1
P	Significant digit for HALO		0 thru 9
Q	Number of zeros to follow the significant digit for HALO		0 thru 8

Note

HALO (High amount lockout)

"PQ" is the same as $P \times 10^Q$.

For example, presetting 13 (\$10.00) here means that amount entries of up to \$10.00 are allowed in the REG mode. When you preset 18, however, the upper limit amount is 999999.99.

Example

Key operation

00000000000000115 FOR CH3
 CAIAT

Print

```

*PGM2*
F080 CHARGE3 KP000 L15
0000 0000000000000001

```

A thru O

9 Programming for the automatic tax calculation function

Your machine has an automatic tax calculation feature which allows you to program four tax tables to avoid calculating incorrect tax amounts.

Automatic tax calculations require you to program, in addition to the tax table, the tax status of each pertinent department, PLU, and function key.

■ The tax table (applicable to the add-on tax) PGM 2

Sample tax table

New Jersey tax table: 6%

Taxes	Range of sales amount	
	Minimum breakpoint	Maximum breakpoint
.00	.01	to .10
.01 - T	.11 - Q	to .22
.02	.23	to .38
.03	.39	to .56
.04	.57	to .72
.05	.73	to .88
.06	.89	to 1.10
.07	1.11 - M1	to 1.22
.08	1.23	to 1.38
.09	1.39	to 1.56
.10	1.57	to 1.72
.11	1.73	to 1.88
.12	1.89	to 2.10
.13	2.11 - M2	to 2.22



A: Difference between the minimum breakpoint and the next one (¢)	
-	
10 (0.11 - 0.01)	B: Non-cyclic
12 (0.23 - 0.11)	
16 (0.39 - 0.23)	
18 (0.57 - 0.39)	
16 (0.73 - 0.57)	C: Cyclic-1
16 (0.89 - 0.73)	
22 (1.11 - 0.89)	
12 (1.23 - 1.11)	
16 (1.39 - 1.23)	
18 (1.57 - 1.39)	
16 (1.73 - 1.57)	D: Cyclic-2
16 (1.89 - 1.73)	
22 (2.11 - 1.89)	

To program a tax table, first make a table like the right table shown above.

From the tax table, calculate the differences between a minimum breakpoint and the next one (A). Then, from the differences, find irregular cycles (B) and regular cycles (C and D). These cycles will show you the following items necessary to program the tax table:

- T:** The tax amount collected on the minimum taxable amount (Q)
- Q:** The minimum taxable amount
- M1:** The maximum value of the minimum breakpoint on a regular cycle (C).
We call this point "MAX point."
- M2:** The maximum value of the minimum breakpoint on a regular cycle (D).
We call this point "MAX point."
- M:** Range of the minimum breakpoint on a regular cycle: difference between Q and M1 or between M1 and M2

Procedure

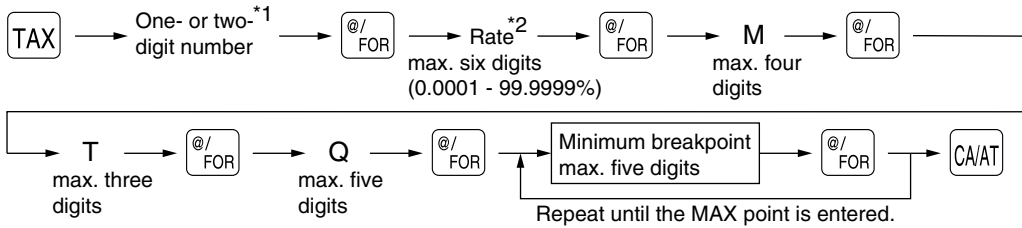

***1 First figure:** The first figure to be entered depends upon whether the difference between a minimum breakpoint to be entered and the preceding minimum breakpoint is not less than \$1.00 or more than 99¢. When the difference is not less than \$1.00, enter “1,” and when it is not more than 99¢, enter “0” or nothing.

Second figure: The second figure depends upon whether your tax table is to be programmed as tax table 1, 2, 3 or 4. When your tax table is to be programmed as tax table 1, enter “1”; when it is to be programmed as tax table 2, enter “2”; when it is to be programmed as tax table 3, enter “3”; and when it is to be programmed as tax table 4, enter “4”.

***2** If the rate is fractional (e.g. 4-3/8%), then the fractional portion (3/8) would be converted to its decimal equivalent (i.e. .375) and the resulting rate of 4.375 would be entered. Note that the nominal rate (R) is generally indicated on the tax table.

Note If you make an incorrect entry before entering the M in programming a tax table, cancel it with the **CL** key; and if you make an error after entering the M, cancel it with the **SBTL** key. Then program again from the beginning correctly.

• Limitations to the entry of minimum breakpoints

Your register can support a tax table consisting of no more than 72 breakpoints. (The number of breakpoints is 36 maximum when the breakpoint difference is \$1.00 or more.) If the number of breakpoints exceeds the register’s table capacity, then the manual entry approach should be used.

Example Programming the sample tax table shown on the previous page as tax table 1

Key operation		Print
	TAX	
	1 @/ FOR	
Tax rate →	6 @/ FOR	
M →	100 @/ FOR	
T →	1 @/ FOR	
Q →	11 @/ FOR	
The first cyclic portion	23 @/ FOR	
	39 @/ FOR	
	57 @/ FOR	
	73 @/ FOR	
M1 (MAX point) →	89 @/ FOR	
	111 @/ FOR	
	CA/AT	

PGM2	
TAX1	6.0000%
	/ 1.00
1	0.11
2	0.23
3	0.39
4	0.57
5	0.73
6	0.89
7	1.11

Note You do not need to enter the trailing zeros of the tax rate (after the decimal point) but you do need to enter the decimal point for fractions.

- If the tax is not provided for every cent, modify the tax table by setting the tax for every cent in the following way.

When setting the tax, consider the minimum breakpoint corresponding to unprovided tax to be the same as the one corresponding to the tax provided on a large amount.

Sample tax table

Example 8%

Tax	Minimum breakpoint
.00	.01
.01	.11
.02	.26
.03	.47
.04	.68
.06	.89
.09	1.11
.10	1.26
.11	1.47
.12	1.68
.14	1.89
.17	2.11

Modification of the left tax table

Tax	Minimum breakpoint
.00	.01
.01 - T	.11 - Q
.02	.26
.03	.47
.04	.68
.05	.89
.06	.89
.07	1.11 - M1
.08	1.11
.09	1.11
.10	1.26
.11	1.47
.12	1.68
.13	1.89
.14	1.89
.15	2.11 - M2
.16	2.11
.17	2.11



Breakpoint difference (¢)	
1	
10 (0.11-0.01)	B: Non-cyclic
15 (0.26-0.11)	
21 (0.47-0.26)	
21 (0.68-0.47)	
21 (0.89-0.68)	
0 (0.89-0.89)	C: Cyclic-1
22 (1.11-0.89)	
0 (1.11-1.11)	
0 (1.11-1.11)	
15 (1.26-1.11)	
21 (1.47-1.26)	
21 (1.68-1.47)	
21 (1.89-1.68)	
0 (1.89-1.89)	D: Cyclic-2
22 (2.11-1.89)	
0 (2.11-2.11)	
0 (2.11-2.11)	

From the modified tax table above;

Rate = 8(%), T = \$0.01 = 1¢, Q = \$0.11 = 11¢, M1 = 1.11, M2 = 2.11, M = 100

Job-Code-Based Programming

This section illustrates how to program items using job codes. Using job codes allows you to program a wide variety of items in comparison with direct programming.

Start this programming by entering a corresponding job code as shown below.



All the items which can be programmed by the job-code-based programming are listed on this page and the following, and those which can also be programmed by the direct programming are marked with the symbol "**Direct**" that follows job codes.

1 Setting the date and time

Setting the date **PGM 2** **2610** **Direct**

Enter the month (one or two digits), day (two digits), and year (four digits: 2000 – 2099) in this sequence.

Procedure

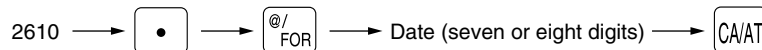

Example

Key operation

2610
08262004

Print

```
08/26/2004 12:00AM  
000000#0001  
  
#2610 *PGM2*  
  
Date 08/26/2004
```

Setting the time **PGM 2** **2611** **Direct**

Set the time using the military time (24-hour) system. For example, when the time is set to 2:30 AM, enter 230; and when it is set to 2:30 PM, enter 1430. The time is printed and displayed on the real time system.

Procedure

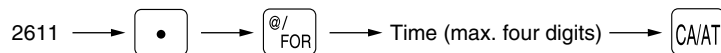

Example

Key operation

2611
1430

Print

```
08/26/2004 2:30PM  
000000#0002  
  
#2611 *PGM2*  
  
2:30PM Time
```

2 Setting the register and consecutive numbers

■ Setting the register number PGM 2 2612

When your store has two or more registers, it is practical to set separate register numbers for their identification. You may set them with a maximum of six digits.

Procedure

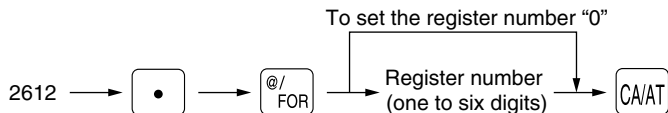

Example

To set the register number as "123456"

Key operation

2612 • @ / FOR
123456 CA / AT

Print

```
08/26/2004 2:30PM
123456#0003
#2612 *PGM2*
123456
```

Register number

■ Setting the consecutive number PGM 2 2613

The consecutive number is increased by one each time a receipt is issued. Enter a number (one to four digits) that is one less than the desired starting number.

Procedure

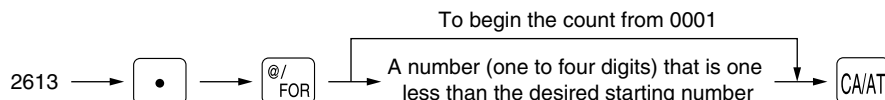

Example

Setting the count start number as "1001"

Key operation

2613 • @ / FOR
1000 CA / AT

Print

```
08/26/2004 2:30PM
123456#1000
#2613 *PGM2*
1000
```

Consecutive number

3 Programming for the automatic tax calculation function

Your machine has an automatic tax calculation feature which allows you to program four tax tables or rates to avoid calculating incorrect tax amounts.

Automatic tax calculations require you to program, in addition to the tax table and rate, the tax status of each pertinent department, PLU, and function key.

■ The tax table (applicable to the add-on tax) PGM 2 2710 Direct

Sample tax table

New Jersey tax table: 6%

Taxes	Range of sales amount	
	Minimum breakpoint	Maximum breakpoint
.00	.01	to .10
.01 — T	.11 — Q	to .22
.02	.23	to .38
.03	.39	to .56
.04	.57	to .72
.05	.73	to .88
.06	.89	to 1.10
.07	1.11 — M1	to 1.22
.08	1.23	to 1.38
.09	1.39	to 1.56
.10	1.57	to 1.72
.11	1.73	to 1.88
.12	1.89	to 2.10
.13	2.11 — M2	to 2.22



A: Difference between the minimum breakpoint and the next one (€)	
—	
10 (0.11 - 0.01)	↓ B: Non-cyclic
12 (0.23 - 0.11)	
16 (0.39 - 0.23)	
18 (0.57 - 0.39)	
16 (0.73 - 0.57)	↓ C: Cyclic-1
16 (0.89 - 0.73)	
22 (1.11 - 0.89)	↑
12 (1.23 - 1.11)	
16 (1.39 - 1.23)	
18 (1.57 - 1.39)	
16 (1.73 - 1.57)	↓ D: Cyclic-2
16 (1.89 - 1.73)	
22 (2.11 - 1.89)	↑

To program a tax table, first make a table like the right table shown above.

From the tax table, calculate the differences between a minimum breakpoint and the next one (A). Then, from the differences, find irregular cycles (B) and regular cycles (C and D). These cycles will show you the following items necessary to program the tax table:

- T:** The tax amount collected on the minimum taxable amount (Q)
- Q:** The minimum taxable amount
- M1:** The maximum value of the minimum breakpoint on a regular cycle (C).
We call this point "MAX point."
- M2:** The maximum value of the minimum breakpoint on a regular cycle (D).
We call this point "MAX point."
- M:** Range of the minimum breakpoint on a regular cycle: difference between Q and M1 or between M1 and M2

Procedure

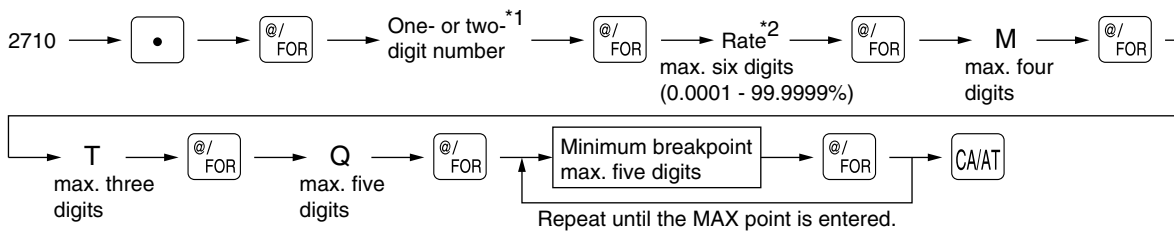

***1 First figure:** The first figure to be entered depends upon whether the difference between a minimum breakpoint to be entered and the preceding minimum breakpoint is not less than \$1.00 or more than 99¢. When the difference is not less than \$1.00, enter "1," and when it is not more than 99¢, enter "0" or nothing.

Second figure: The second figure depends upon whether your tax table is to be programmed as tax table 1, 2, 3 or 4. When your tax table is to be programmed as tax table 1, enter "1"; when it is to be programmed as tax table 2, enter "2"; when it is to be programmed as tax table 3, enter "3"; and when it is to be programmed as tax table 4, enter "4".

***2** If the rate is fractional (e.g. 4-3/8%), then the fractional portion (3/8) would be converted to its decimal equivalent (i.e. .375) and the resulting rate of 4.375 would be entered. Note that the nominal rate (R) is generally indicated on the tax table.

Note If you make an incorrect entry before entering the M in programming a tax table, cancel it with the **CL** key; and if you make an error after entering the M, cancel it with the **SBTL** key. Then program again from the beginning correctly.

• Limitations to the entry of minimum breakpoints

Your register can support a tax table consisting of no more than 72 breakpoints. (The number of breakpoints is 36 maximum when the breakpoint difference is \$1.00 or more.) If the number of breakpoints exceeds the register's table capacity, then the manual entry approach should be used.

Example Programming the sample tax table shown on the previous page as tax table 1

Key operation	Print
2710	#2710 *PGM2*
•	TAX1
1	6.0000%
Tax rate →	/ 1.00
6	1
M →	2 0.11
100	3 0.23
T →	4 0.39
1	5 0.57
Q →	6 0.73
11	7 1.11
The first cyclic portion	23
	39
	57
	73
M1 (MAX point) →	89
	111
	CA/AT

Note You do not need to enter the trailing zeros of the tax rate (after the decimal point) but you do need to enter the decimal point for fractions.

- If the tax is not provided for every cent, modify the tax table by setting the tax for every cent in the following way.

When setting the tax, consider the minimum breakpoint corresponding to unprovided tax to be the same as the one corresponding to the tax provided on a large amount.

Sample tax table

Example 8%

Tax	Minimum breakpoint
.00	.01
.01	.11
.02	.26
.03	.47
.04	.68
.06	.89
.09	1.11
.10	1.26
.11	1.47
.12	1.68
.14	1.89
.17	2.11

Modification of the left tax table

Tax	Minimum breakpoint
.00	.01
.01 — T	.11 — Q
.02	.26
.03	.47
.04	.68
.05	.89
.06	.89
.07	1.11 — M1
.08	1.11
.09	1.11
.10	1.26
.11	1.47
.12	1.68
.13	1.89
.14	1.89
.15	2.11 — M2
.16	2.11
.17	2.11



Breakpoint difference (¢)	
1	
10 (0.11-0.01)	B: Non-cyclic
15 (0.26-0.11)	
21 (0.47-0.26)	
21 (0.68-0.47)	
21 (0.89-0.68)	
0 (0.89-0.89)	C: Cyclic-1
22 (1.11-0.89)	
0 (1.11-1.11)	
0 (1.11-1.11)	
15 (1.26-1.11)	
21 (1.47-1.26)	
21 (1.68-1.47)	
21 (1.89-1.68)	
0 (1.89-1.89)	D: Cyclic-2
22 (2.11-1.89)	
0 (2.11-2.11)	
0 (2.11-2.11)	

From the modified tax table above;

Rate = 8(%), T = \$0.01 = 1¢, Q = \$0.11 = 11¢, M1 = 1.11, M2 = 2.11, M = 100

■ The tax rate PGM 2 2711

Procedure

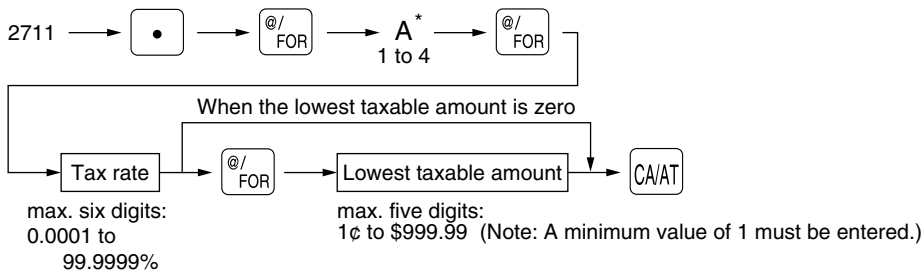

*A: When you program a tax rate as tax rate 1, enter "1"; when you program it as tax rate 2, enter "2"; when you program it as tax rate 3, enter "3"; and when you program it as tax rate 4, enter "4".

Example

Programming the tax rate 4% as tax rate 2 with tax exempt as 12¢

Key operation

2711
 2
 4
 12

Print

```
#2711 *PGM2*
TAX2          4.0000%
              0.12
```

Note

- If you make an incorrect entry before pressing the third key in programming a tax rate, cancel it with the key; and if you make an error after pressing the third key, cancel it with the key. Then program again from the beginning correctly.
- You do not need to enter the trailing zeros of the tax rate (after the decimal point), but you do need to enter the decimal for fractions.

■ Doughnut tax exempt (for the Canadian tax system)

PGM 2

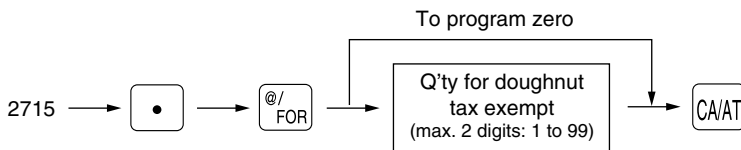
2715**Procedure****Note**

This option is available only when your register has been set up with the Canadian tax system.

Example

To program the q'ty "6"

Key operation

2715
 6

Print

```
#2715 *PGM2*
EXPT COUNT    6
```

4 Programming for departments

Your machine is equipped with 20 (ER-A410)/10 (ER-A420) standard departments and a maximum of 99 departments. Your machine allows you to perform the following programming for each department.

■ Functional programming 1 PGM 2 2110 Direct

You can set each department for:

Item validation printing

If item entries must be validated, program corresponding departments for compulsory validation printing.

Tare table number

Tare table number associated with scale entry (1 thru 9)

Scale entry

Program a department for scale entry allowed when your store needs automatic scale entries.

Registration type

- If an entry of a department programmed for SICS is made first, the scale will be finalized as soon as the department key is pressed. If the entry is made after entering a department not programmed for SICS, the sale will not be finalized until the CAIAT key is pressed.
- Whenever a sale is made to a department programmed for SIF, the sale is finalized as soon as the department key is pressed.

Department type

You may program each department as one of the following three types.

- Bottle Return (BR)
- Hash department
A hash department is used to enter the amount of a special "sale", such as a gift certificate sale or for the receipt of payment for utility bills, theatre tickets, etc., i.e. "non-sales" registrations. Any amounts entered in this department are not added to the grand total except tax amounts.
- Normal department

Note

If your register has been set for "Bottle return and Hash dept." by your dealer, you cannot program the department for those operations. So contact your dealer if you need them.

Type of unit price entry

You may select one of the following four types of unit price entry for each department.

- Open and preset
- Preset only
- Open only
- Inhibit department key

Procedure

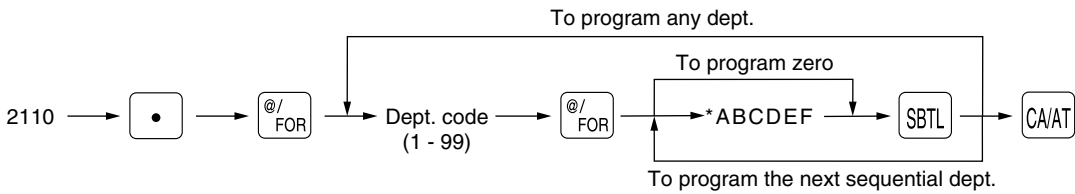

*1 Item:	Selection:	Entry:
A Item validation printing	Non-compulsory	0
	Compulsory	1
B Tare table number		1 thru 9
C Scale entry	Inhibit	0
	Enable	1
	Compulsory	2
D Registration type	Normal	0
	SICS (Single Item Cash Sale)	1
	SIF (Single Item Finalization)	2
E Department type	Normal department	0
	Hash department	1
	Bottle return department	2
F Type of unit price entry	Inhibit department key	0
	Open only	1
	Preset only	2
	Open and preset	3

Example

Programming for department 3
Enter ABCDEF=000003 for department 3.

Key operation

2110 [.] [@/FOR]
3 [@/FOR] 000003 [SBTL]
[CA/AT]

Print

#2110 *PGM2*

D03 0.00
DPT. 03 600
000003 KP000 A00 COL17

A thru F

Functional programming 2 PGM 2 2111 Direct

Sign (plus/minus)

- Assign a plus sign to departments for normal sales transactions.
- Assign a minus sign to departments for minus transactions.

Food stamp status

- Assign a food stamp status (food stamp eligible or food stamp ineligible) to each department.

Tax status (taxable 1 thru 4/non-taxable)

- When an entry of a taxable department is made in a transaction, tax is automatically computed according to the associated tax table or rate.

Note Tax 4 is prohibited if you use the food stamp function.

Procedure

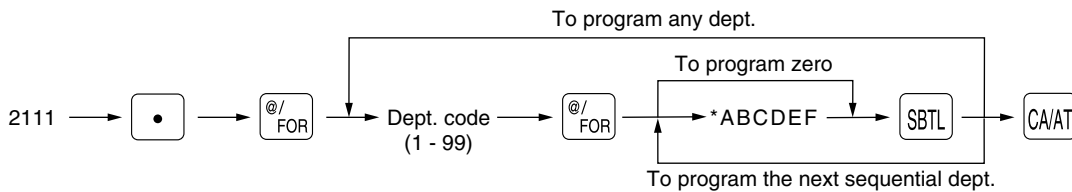

* Item:	Selection:	Entry:
A Sign (+/-)	Plus	0
	Minus	1
B Food stamp status	Ineligible	0
	Eligible	1
C Tax 4 status	Non-taxable	0
	Taxable	1
D Tax 3 status	Non-taxable	0
	Taxable	1
E Tax 2 status	Non-taxable	0
	Taxable	1
F Tax 1 status	Non-taxable	0
	Taxable	1

Example

Programming for department 4 and 10
 Enter ABCDEF=010001 for department 4.
 Enter ABCDEF=100000 for department 10.

Key operation

```

2111 . @/ FOR
4 @/ FOR 010001 SBT L
10 @/ FOR 100000 SBT L
CA/AT
  
```

Print

```

#2111 *PGM2*
D04 FT1      0.00
DPT. 04      G00
000001 KP000 A00 COL17
D10          -0.00
DPT. 10      G00
000001 KP000 A00 COL17
  
```

Food stamp eligible and taxable 1

Minus dept.

■ A limit amount (HALO) of entry PGM 2 2112 Direct

You can set amounts (HALO: High Amount Lockout) for each department. The limit is effective for the REG mode operations and can be overridden in the MGR mode. The HALO limit is represented by two figures as follows:

Procedure

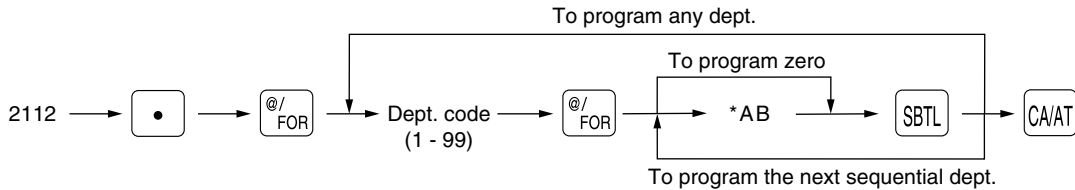

“AB” is the same as $A \times 10^B$.

A: Significant digit (0 through 9)

B: Number of zeros to follow significant digit (0 through 7)

For example, presetting 13 (\$10.00) here means that amount entries of up to \$10.00 are allowed in the REG mode. When you preset 17, however, the upper limit amount is 99999.99.

Example

Programming HALO limit of 9000.00 (95) for dept. 1

Key operation

```

2112 . @/FOR
1 @/FOR 95 SBTL
CAVAT
    
```

Print

```

#2112 *PGM2*
D01          0.00
DPT. 01      600
000001 KP000 A00 COL95 — HALO
    
```

■ Alphanumeric characters PGM 2 2114

You can program a maximum of 16 characters (item label) for each department.

Select the characters you want to program, referring to section “2 How to program alphanumeric characters” in chapter “PRIOR TO PROGRAMMING”.

Procedure

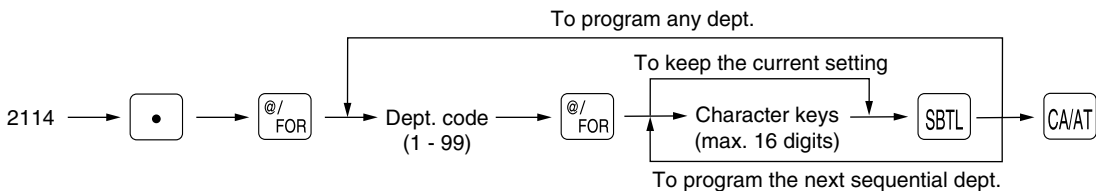

Example

Programming STEAK (steak) for dept. 1

Key operation

```

2114 . @/FOR
1 @/FOR STEAK SBTL
CAVAT
    
```

Print

```

#2114 *PGM2*
D01          0.00
STEAK        600
000001 KP000 A00 COL95
    
```

Unit price PGM 1 PGM 2 1110 Direct

You can program unit prices up to a maximum of six digits (\$9999.99). Even if a department is not programmed to allow the entry of preset unit prices in functional programming 1 (job #2110), the department is automatically changed to allow the entry of preset unit prices by this programming entry.

Procedure

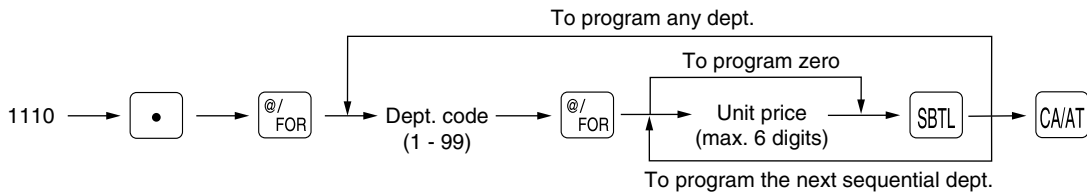

Example

Programming \$10.00 for dept. 1

Key operation

```

1110 [.] [ @/FOR ]
1 [ @/FOR ] 1000 [ SBT ]
[ CA/AT ]
    
```

Print

```

#1110 *PGM2*
D01          10.00
STEAK              G00
000003 KP000 A00 COL95
    
```

Unit price

Commission group assignment PGM 2 2115 Direct

Your machine allows you to assign a commission group (1 – 9) to each department.

Procedure

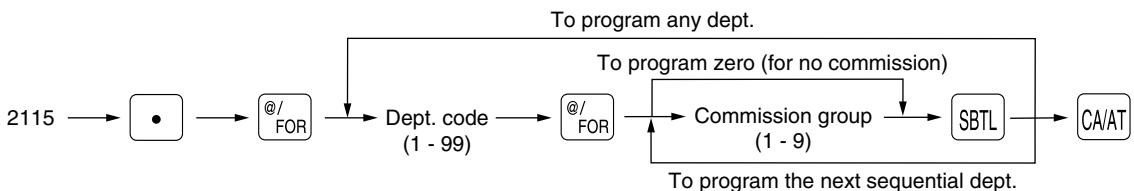

Example

Programming commission group 1 for dept. 1 and commission group 2 for dept. 5

Key operation

```

2115 [.] [ @/FOR ]
1 [ @/FOR ] 1 [ SBT ]
5 [ @/FOR ] 2 [ SBT ]
[ CA/AT ]
    
```

Print

```

#2115 *PGM2*
D01          10.00
STEAK              G00
000003 KP000 A00 C1L95
D05           0.00
DPT. 05              G00
000001 KP000 A00 C2L17
    
```

Commission group no.

■ Group number PGM 2 2116 Direct

You can assign departments to a maximum of 9 groups (1 thru 9).
This programming enables you to take the group department sales reports.

Procedure

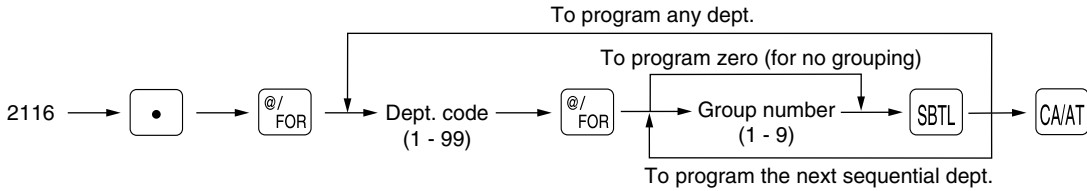

Example

Programming the group number 1 for dept. 1 and the group number 2 for dept. 2

Key operation

```

2116 [.] [ @/FOR ]
1 [ @/FOR ] 1 [ SBTL ]
2 [ @/FOR ] 2 [ SBTL ]
[ CA/AT ]
    
```

Print

```

#2116 *PGM2*

D01          10.00
STEAK                G01
000003 KP000  A00  C1L95
D02                0.00
DPT.02                G02
000001 KP000  A00  COL17
    
```

Group no.

■ Age limitation PGM 2 2180

If an item sold is not allowed to be sold to certain aged persons by law, program the age limitation for the corresponding department.

Procedure

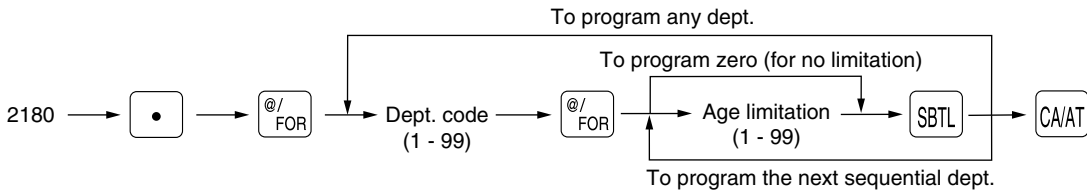

Note

When a department for which a setting other than zero (1 to 99) has been programmed as the age limitation is entered, the birthday entry will be enforced.

Example

Programming the age limitation "18" for dept. 2

Key operation

```

2180 [.] [ @/FOR ]
2 [ @/FOR ] 18 [ SBTL ]
[ CA/AT ]
    
```

Print

```

#2180 *PGM2*

D02          0.00
DPT.02                G02
000001 KP000  A18  COL17
    
```

Age limitation

Print station assignment PGM 2 2118

When you use a remote printer, please consult your dealer.

Procedure

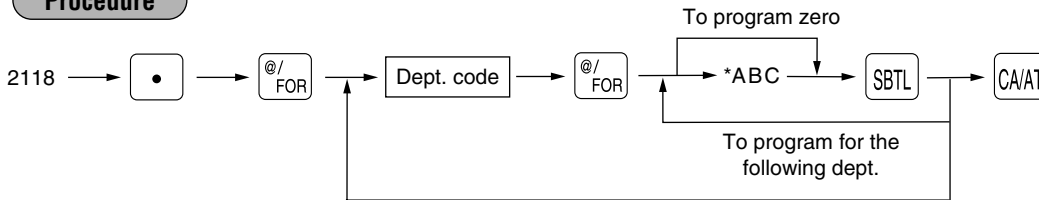

* Item:	Selection:	Entry:
A Remote printer 1 output	Output	1
	Not output	0
B Remote printer 2 output	Output	1
	Not output	0
C Printing on the chit receipt	Yes	1
	No	0

Example

Key operation

2118
 9 101

Print

```
#2118 *PGM2*
D09          0.00
DPT.09      G00
000001 KP101 A00 COL17
```

Print station

Department key positioning PGM 2 2119

You can assign a department code to each key position. Each key position has a corresponding key number. Departments may be freely selected for the number of department keys and their positions.

To assign the department to a key position, select the key number of the position.

For key number positions, refer to section "3 Standard key number layout" in chapter "KEYBOARD".

Procedure

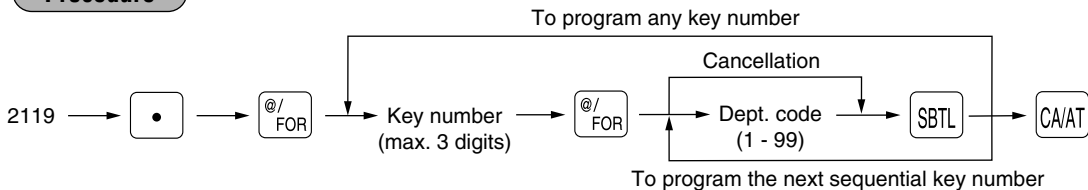

Note

The key number placement is determined by your local authorized SHARP dealer.

Example

Key operation

2119
 1 1
 2

Print

```
#2119 *PGM2*
001 L1      D01
002 L1      D02
```

Key no.

5 PLU/UPC programming

Your machine has two kinds of PLU registration methods.

Direct PLU registration: Accomplished by pressing item key (direct PLU key) directly.

Indirect PLU registration: Accomplished by making an entry of PLU code and pressing the  key.

In this manual, the word “UPC” represents UPC (Universal Product Code) and the word “EAN” represents EAN (European Article Number).

With regard to the UPC codes available to this register, please refer to the chapter 13 in “Job-Code-Based programming”.

Each PLU/UPC requires you to program the following:

PLU/UPC code (PLU: max. 5 digits, UPC: 6 to 13 digits)

Associated department

When a PLU/UPC is associated with a department, the following functions of the PLU/UPC depend on the programming for the corresponding department.

- Type (Bottle return/Hash/Normal)
- Single item cash sale/Single item finalization
- HALO (for “Open” type)
- Item validation print compulsory/non-compulsory

Unit price (max. six digits)



You will usually have unit prices programmed for individual PLUs/UPCs as PLU/UPC unit prices.

If you program unit price “0.00” for a PLU/UPC, you can enter only the selling quantity into the PLU/UPC, i.e. the PLU/UPC can be used only as a counter.

Base quantity for split-pricing entries – two digits

Program a base quantity for each PLU/UPC dedicated to split-pricing entries.

Type of unit price entry

- If “Preset only” is selected, individual PLU/UPC entries can be made by entering the assigned code and pressing the  key (or by pressing a direct PLU key without any PLU code entry, or by scanning the UPC code).
- If “Open only” is selected, the  key must be pressed after the price entry followed by the PLU code and the  entry (, or the unit price must be entered before pressing a direct PLU key).
- If “Open and preset” is selected, the entries in both “Preset” and “Open” types are available.
- If the delete mode is selected, the corresponding program data for each PLU/UPC is deleted.
- If the prohibit mode is selected, the PLU/UPC code cannot be entered. This mode does not clear the PLU/UPC program data.

Sign (+/-)

The function of every PLU/UPC varies according to the combination of its sign and its associate department’s sign as follows:

Sign		Function of PLU/UPC
Dept.	PLU/UPC	
+	+	Serves as a normal plus PLU/UPC
-	-	Serves as a normal minus PLU/UPC
+	-	Accepts store coupon entries, but not split-pricing entries.
-	+	Not valid; not accepted.

Food stamp status and tax status (taxable 1, 2, 3 and/or 4, non-taxable)

Item label (max. 16 characters)

Tare table number and scale entry

Age limitation

Commission group (1 to 9)

Mix-and-match table (max. 10 tables)

Set PLU (for only PLU)

You can link a maximum of 10 PLUs to a particular PLU.

Link PLU/UPC link

A PLU/UPC is able to link to any other PLU (e.g. bottle deposit). However, the number of links is a maximum of 5. Even if more than 5 PLUs are linked, the sixth or higher link is not actualized (ignored).

Print station

Unit prices PGM 1 PGM 2 **1210** Direct

Procedure

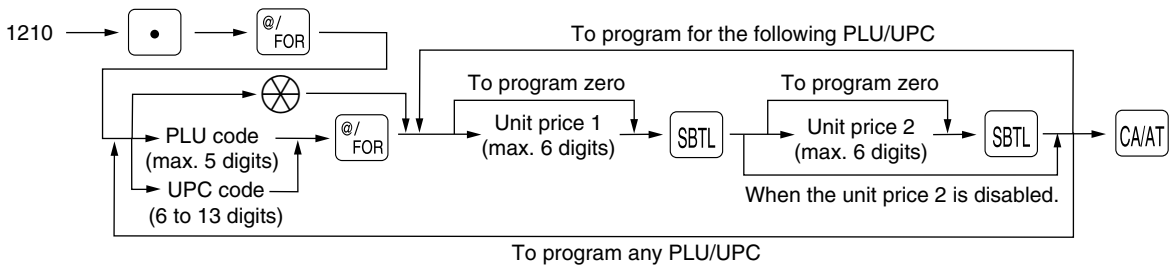

Note The preset amount will work as the unit price for the "Preset" type and as the HALO amount for the "Open" type. In the case of the "Open" type, zero preset prevents amount entry and a 9999.99 preset is the maximum limitation. In the case of the "Preset" type zero and 9999.99 preset have no special meaning. (i.e. 0 amount preset is available.)

Example Programming "\$1.25" for PLU 1

Key operation	Print
<p>(When the price level 2 is enabled.)</p> <p style="text-align: center;">1210 [•] [④/ FOR] 1 [④/ FOR] 125 [SBTL] [SBTL] [CA/AT]</p>	<div style="border: 1px solid black; padding: 5px;"> <pre>#1210 *PGM2* P00001 (02) /00 KP000 1.25 0.00 PLU00001 COM00 1002 A00 S 0.000</pre> <p style="text-align: right; margin-right: 20px;">Unit price</p> </div>

Base quantity PGM 1 PGM 2 **1211** Direct

Procedure

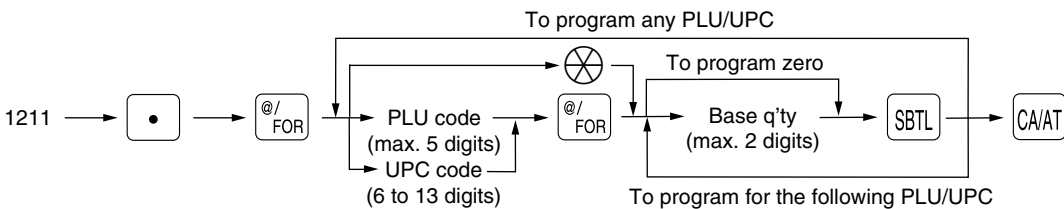

Example Programming "12" for PLU 2

Key operation	Print
<p>1211 [•] [④/ FOR] 2 [④/ FOR] 12 [SBTL] [CA/AT]</p>	<div style="border: 1px solid black; padding: 5px;"> <pre>#1211 *PGM2* P00002 (01) /12 KP000 0.00 0.00 PLU00002 COM00 1002 A00 S 0.000</pre> <p style="text-align: right; margin-right: 20px;">Base q'ty</p> </div>

■ Type of unit price entry, delete method, tare table no. and scale entry PGM 2

2210 **2231** **Direct**

Procedure

For each PLU/UPC

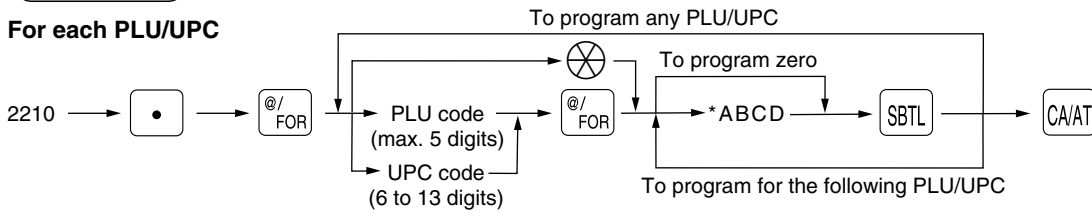

For a range of PLUs

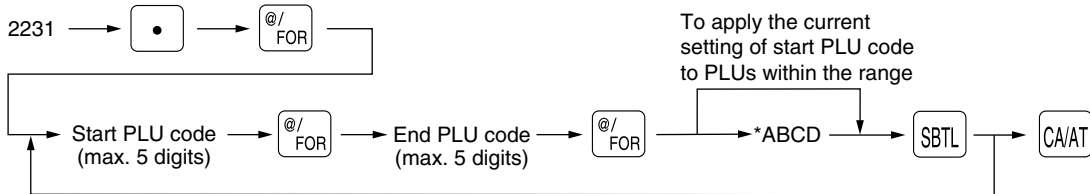

* Item:	Selection:	Entry:
A Delete method (for only UPC) (for PLU: fixed 1)	Inhibit to delete in non-accessed UPC deleting job (#105 in Z1 mode)	1
	Delete in non-accessed UPC deleting job (#105 in Z1 mode)	0
B Tare table number		1 thru 9
C Scale entry	Inhibit	0
	Enable	1
	Compulsory	2
	Prohibit mode	0
D Type of unit price entry	Open price only (for only PLU)	1
	Preset price only	2
	Open price and preset price (for only PLU)	3
	Delete mode	4

Example

To program BCD=003 for PLU1

For each PLU/UPC

Key operation

2210
 1 003

Print

```
#2210 *PGM2*
P00001 (02) /00
      KP000 1.25
      0.00
PLU00001 COM00
1003 A00 S 0.000
```

A thru D

Programming the PLU 11 thru 20 for "Open and preset price"

For a range of PLUs

Key operation

2231
 11 20
 003

Print

```
#2231 *PGM2*
00011-
00020
1003
```

Procedure

For each PLU/UPC

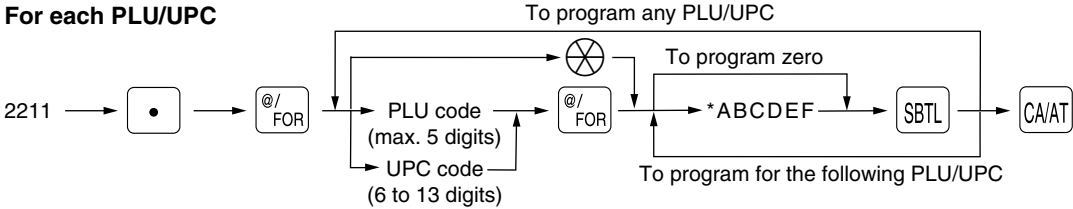

For a range of PLUs

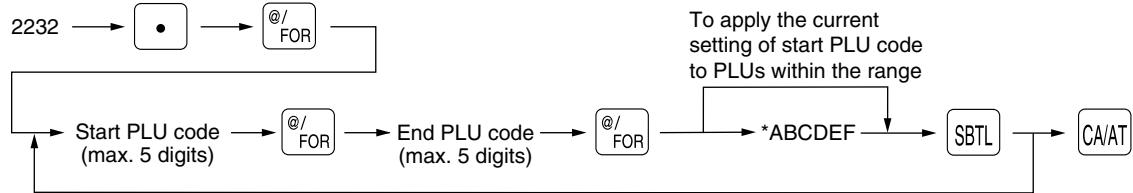

* Item:	Selection:	Entry:
A Sign (+/-)	Plus	0
	Minus	1
B Food stamp status	Ineligible	0
	Eligible	1
C Tax 4 status	Non-taxable	0
	Taxable	1
D Tax 3 status	Non-taxable	0
	Taxable	1
E Tax 2 status	Non-taxable	0
	Taxable	1
F Tax 1 status	Non-taxable	0
	Taxable	1

Note **Tax status (taxable 1 thru 4/non-taxable)**
 Tax 4 is prohibited if you use the food stamp function.
 A PLU/UPC not programmed for Tax 1 thru Tax 4 statuses is registered depending on the tax status of the department which the PLU/UPC belongs to.

Example Programming ABCDEF=000001 for PLU 1 and ABCDEF=010000 for PLU 2

For each PLU/UPC

Key operation

Print

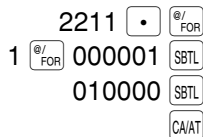

Taxable 1
 Food stamp eligible

```
#2211 *PGM2*
P00001 (02) /00
T1 KP000 1.25
      0.00
PLU00001 COM00
1003 A00 S 0.000
P00002 (01) /12
F KP000 0.00
      0.00
PLU00002 COM00
1002 A00 S 0.000
```

For a range of PLUs

Key operation	Print
2232 <input type="button" value="•"/> <input type="button" value="@/ FOR"/> 11 <input type="button" value="@/ FOR"/> 20 <input type="button" value="@/ FOR"/> 000001 <input type="button" value="SBTL"/> <input type="button" value="CA/AT"/>	<pre>#2232 *PGM2* 00011- 00020 T1</pre>

Alphanumeric characters PGM 2 2214

You can program a maximum of 16 characters (item label) for each PLU/UPC. Select the characters you want to program, referring to section “2 How to program alphanumeric characters” in chapter “PRIOR TO PROGRAMMING”.

Procedure

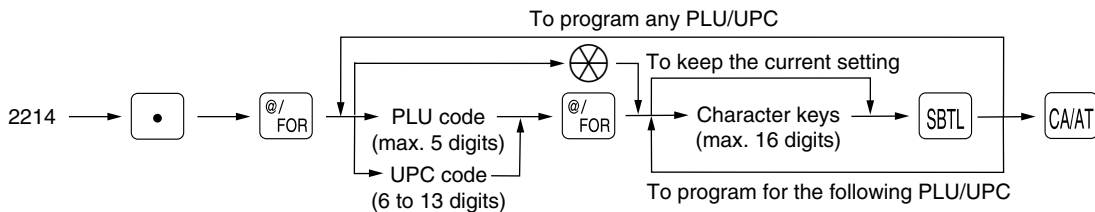

Example

Programming MILK (milk) for PLU 1

Key operation	Print
2214 <input type="button" value="•"/> <input type="button" value="@/ FOR"/> 1 <input type="button" value="@/ FOR"/> MILK <input type="button" value="SBTL"/> <input type="button" value="CA/AT"/>	<pre>#2214 *PGM2* P00001 (02) /00 T1 KP000 1.25 0.00 MILK COM00 1003 A00 S 0.000</pre>

You can assign PLUs/UPCs to commission groups.

Procedure

For each PLU/UPC

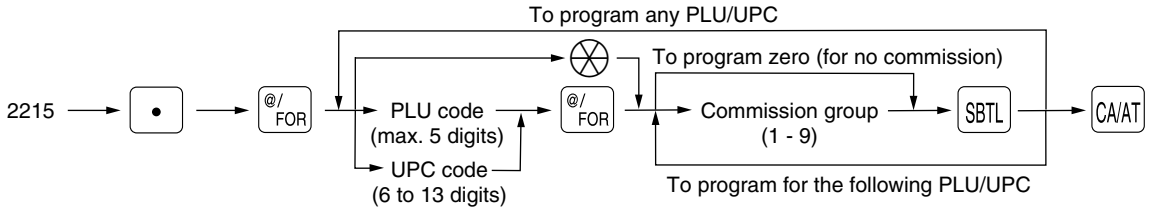

For a range of PLUs

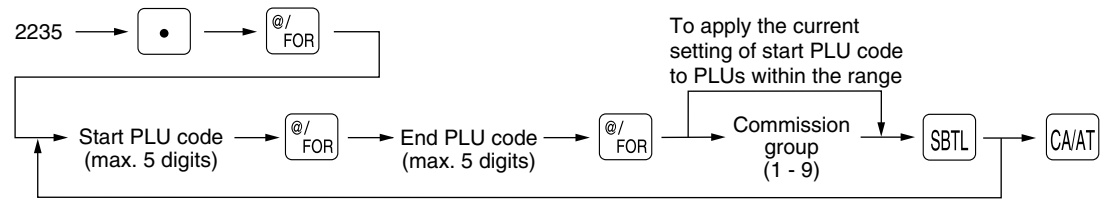

Example Programming the commission group 1 for PLU 1

For each PLU/UPC

Key operation

2215 • @/FOR
1 @/FOR 1 SBT
CA/AT

Print

```
#2215 *PGM2*

P00001 (02) /00
T1 KP000 1.25
      0.00
MILK
1003 A00 S C1M00
      0.000
```

Commission group no.

Programming all of PLU 11 thru 20 for the commission group 1

For a range of PLUs

Key operation

2235 • @/FOR
11 @/FOR 20 @/FOR
1 SBT
CA/AT

Print

```
#2235 *PGM2*

00011-
00020
C1
```

Age limitation PGM 1 PGM 2 2280 2236

If an item sold is not allowed to be sold to certain aged persons by law, program the age limitation for the corresponding PLU/UPC.

Procedure

For each PLU/UPC

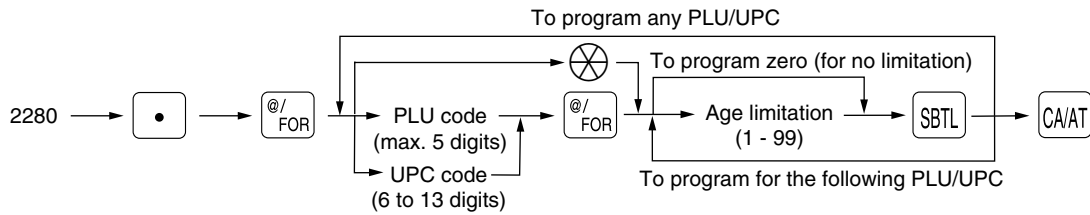

For a range of PLUs

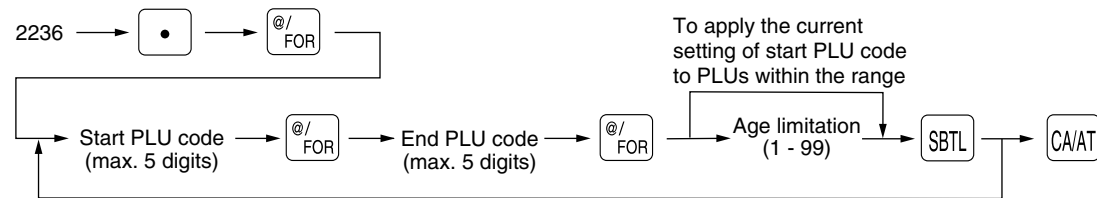

Note

When a PLU/UPC for which a setting other than zero (1 to 99) has been programmed as the age limitation is entered, the birthday entry will be enforced.

Example

Programming the age limitation "18" for PLU 2

For each PLU/UPC

Key operation

2280 • @/FOR
2 @/FOR 18 SBTL
CA/AT

Print

```
#2280 *PGM2*
P00002 (01) /12
F KP000 0.00
0.00
PLU00002 COM00
1002 A18 S 0.000
```

Age limitation

Programming the PLU 11 thru 20 for the age limitation "18"

For a range of PLUs

Key operation

2236 • @/FOR
11 @/FOR 20 @/FOR
18 SBTL
CA/AT

Print

```
#2236 *PGM2*
00011-
00020
A18
```

Stock quantity PGM 1 PGM 2 1222 1220 1221

You can assign a stock quantity to each PLU/UPC code. (If you want to control a stock quantity, please consult your dealer.) When you assign it for the first time, follow the below procedure:

Procedure

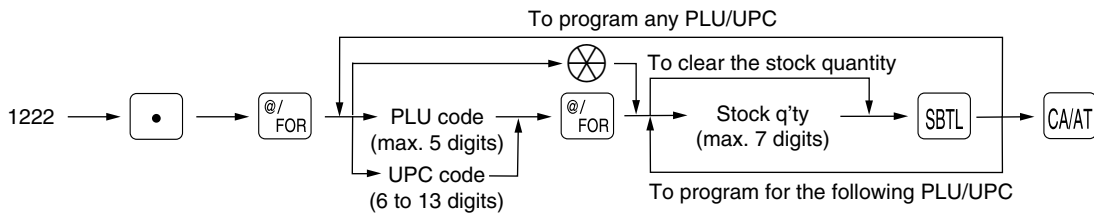

Example

To program the stock quantity "10" for PLU 2

Key operation

1222 \cdot @/FOR
 2 @/FOR 10 SBTL
 CA/AT

Print

```
#1222 *PGM2*

P00002          0.000
                10.000
S              10.000 — Stock q'ty
```

Note

- If you assign another stock quantity to the PLU/UPC code which you have assigned a stock quantity to, it will be overridden.
- You must use a decimal point (\cdot) key when setting quantities that are fractional.

If you need to add or subtract a stock quantity, follow the below procedure:

Procedure

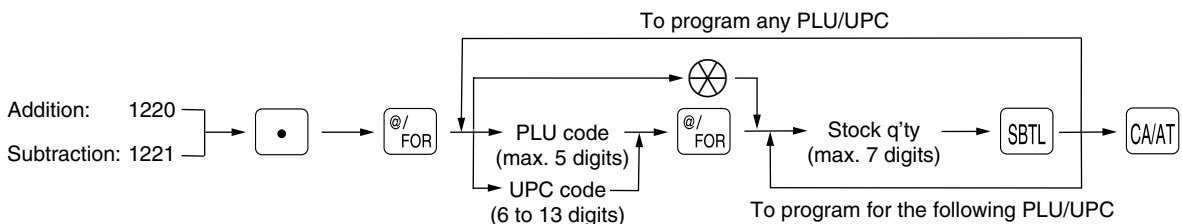

Adding the stock quantity

Example

To add the stock quantity "4" to the current stock quantity "10" of PLU2

Key operation

1220 \cdot @/FOR
 2 @/FOR 4 SBTL
 CA/AT

Print

```
#1220 *PGM2*

P00002          10.000
                4.000
S              14.000 — Added stock q'ty
```

Subtracting the stock quantity

Example

To subtract the stock quantity "1.5" from the current stock quantity "14" of PLU 2

Key operation

```

1221 [.] [ @/FOR ]
2 [ @/FOR ] 1 [.] 5 [ SBTL ]
                                     [ CA/AT ]
    
```

Print

```

#1221 *PGM2*
P00002      14.000
             -1.500
             $ 12.500
    
```

Subtracted stock q'ty

Set PLU

PGM 2

2221

Procedure

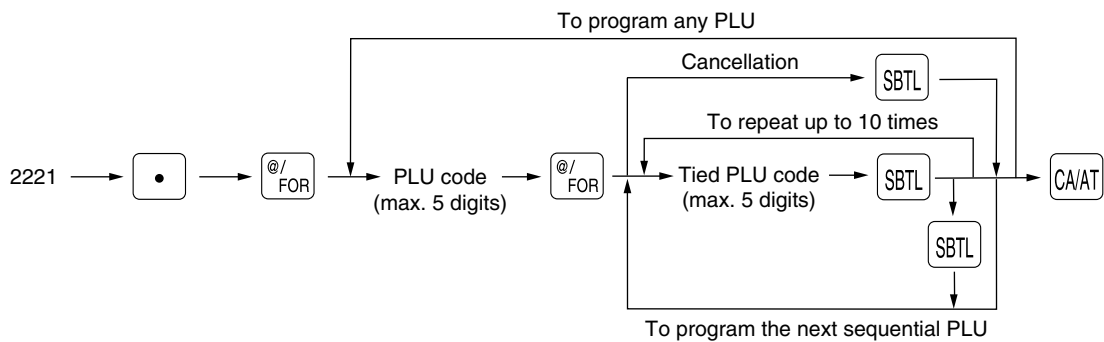

Note

PLU codes must have already been defined.

You can program a maximum of 15 set PLUs. A set PLU can be tied to a maximum of 10 PLUs.

Example

Programming the set PLU 20 (tied PLUs: PLU 201 and PLU 202)

Key operation

```

2221 [.] [ @/FOR ]
20 [ @/FOR ] 201 [ SBTL ]
202 [ SBTL ]
                                     [ CA/AT ]
    
```

Print

```

#2221 *PGM2*
P00020      SP00201
             P00202
    
```

Tied PLUs

Mix-and-match table PGM 2 2217 2225

The mix-and-match table consists of the adjustment amount and the matching count for discount (satisfying the count of entered items). You can program a maximum of 10 mix-and-match tables. One table can be assigned maximum of 5 kind of items.

[Ex.] Mix-and-match table no. 1: matching count=3, adjustment amount \$7.00
 Mix-and-match items of table no. 1: Item-A (\$2.30), Item-B (\$3.10), Item-C (\$2.50)

<Sale 1>	<Sale 2>	<Sale 3>
Item-A \$2.30	Item-C \$2.50	Item-A \$2.30
Item-A \$2.30	Item-C \$2.50	Item-B \$3.10
Item-B \$3.10	Item-C \$2.50	Item-C \$2.50
Subtotal \$7.70	Subtotal \$7.50	Subtotal \$7.90
(Discount \$0.70)	(Discount \$0.50)	(Discount \$0.90)
Total \$7.00	Total \$7.00	Total \$7.00

Programming of matching count and adjustment amount

Procedure

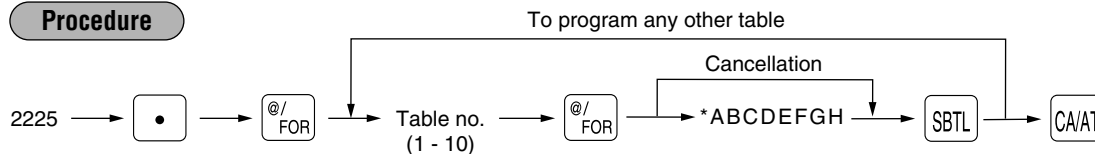

* AB: Matching count (1 - 99)
 CDEFGH: Adjustment amount (max. 6 digits)

Example

Programming mix-and-match table no.1 (matching count=3, adjustment amount \$5.00)

Key operation

```

2225 [.] [ @/FOR ]
1 [ @/FOR ] 03000500 [ SBTL ]
                                     [ CA/AT ]
    
```

Print

```

#2225 *PGM2*
#01 /03 5.00
    
```

Adjustment amount

Matching count

Assigning items to the mix-and-match tables

Procedure

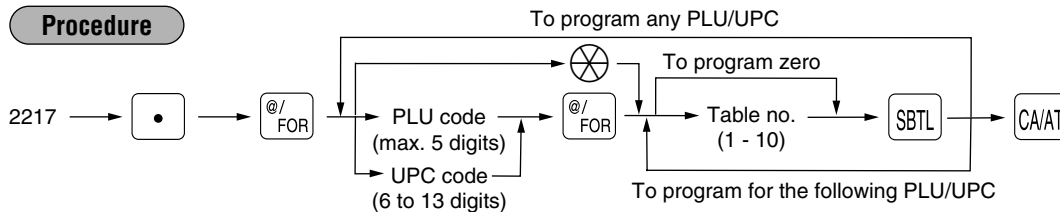

Example

Programming mix-and-match table no.1 for PLU 1

Key operation

```

2217 [.] [ @/FOR ]
1 [ @/FOR ] 1 [ SBTL ]
                                     [ CA/AT ]
    
```

Print

```

#2217 *PGM2*
P00001 (02) /00
T1 KP000 1.25
          0.00
MILK          C1M01
1003 A00 S 0.000
    
```

Mix-and-match table no.

Print station to PLU/UPC assignment PGM 2 **2218**

When you use a remote printer, consult your dealer.

Procedure

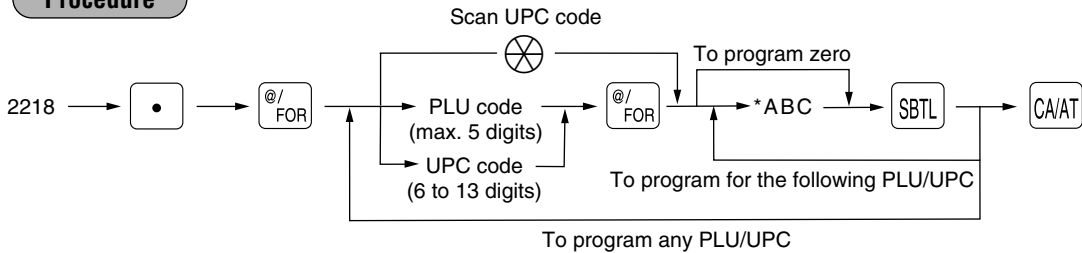

* Item:	Selection:	Entry:
A Remote printer 1 output	Output	1
	Not output	0
B Remote printer 2 output	Output	1
	Not output	0
C Printing on the chit receipt	Yes	1
	No	0

Note PLU/UPC code must have been already defined.

Example

Key operation

2218
 9
 101

Print

```
#2218 *PGM2*
P00009 (01) /00
        KP101 0.00
        0.00
PLU00009 COM00
1002 A00 S 0.000
```

Print station

Delete period for non-accessed UPC codes PGM 2 **2029**

You can delete the UPC codes which have not been accessed during the period you set in this program when you execute the job #105 in Z1 mode when you set "Delete in non-accessed UPC deleting job" in the UPC delete method (#2210).

Procedure

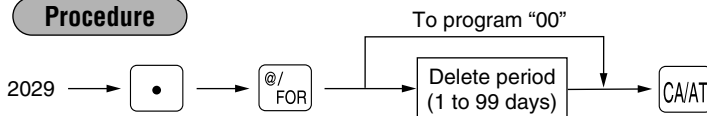

* When you select "00" for the period, no UPC code is deleted by the non-accessed UPC deleting job.

Example

Key operation

2029
 60

Print

```
#2029 *PGM2*
60
```

■ Programming Non-PLU code format PGM 2 2025

The register allows you to specify the Non-PLU code format (flag code: 2, 02, 20 -29).
The format data is as follows:

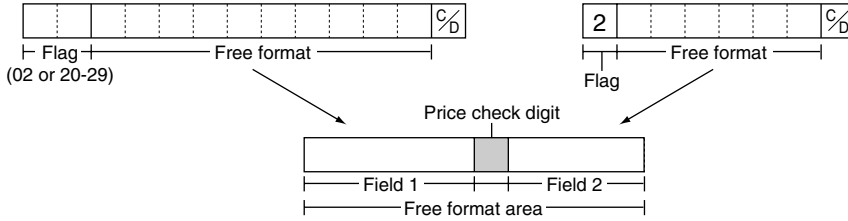

Procedure

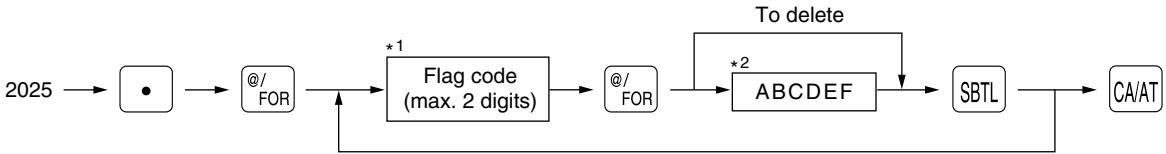

*1 Flag code: 2, 02, 20 - 29

*2 Item:	Selection:	Entry:
A Length of field 1 (number of digits)		0 - 9
B Length of field 2 (number of digits)		0 - 9
C Always enter 0.	(Fixed position)	0
D Meaning of field 2*3	Quantity	2
	Price	0
E Price check digit used	Yes	1
	No	0
F TAB or decimal point of field 2 (0, 1, 2, 3)		0 - 3

*3: When you preset a quantity, the sales amount is calculated as follows: quantity x unit price programmed in #1210.

Example

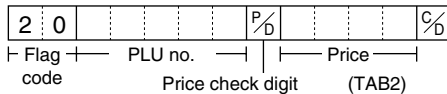

Key operation

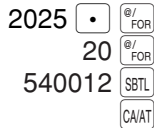

Print

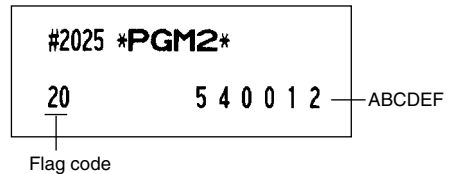

■ Link PLU/UPC link PGM 2 2220

Procedure

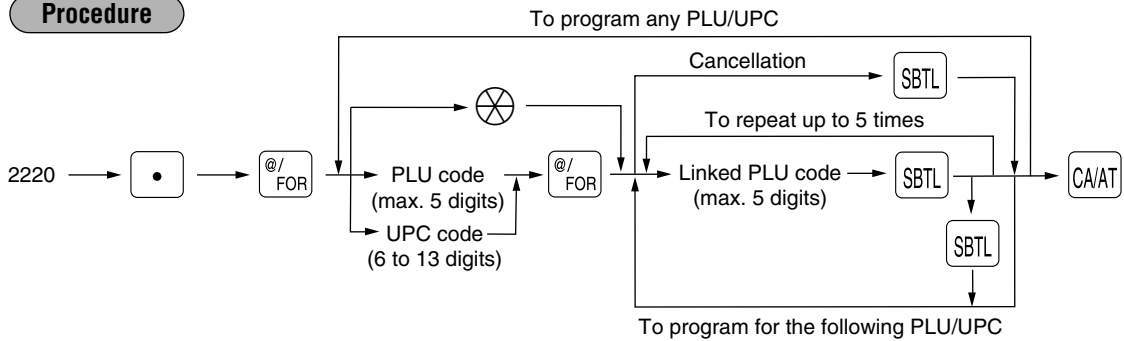

Note *PLU/UPC codes must have already been defined. You can program a maximum of 15 link PLUs/UPCs. A link PLU/UPC can be linked to a maximum of 5 PLUs.*

Example Programming so that PLU 25, 26 and 27 are linked to PLU 21

Key operation

```

2220 [•] [④/ FOR]
21 [④/ FOR] 25 [SBTL]
           26 [SBTL]
           27 [SBTL]
           [CA/AT]
    
```

Print

```

#2220 *PGM2*

P00021      LP00025
             P00026
             P00027
    
```

Linked PLUs

■ Programming of PLU levels and direct PLU keys PGM 2 2219

You can assign PLU codes to fixed keys in each PLU level and use those keys as direct PLU key. For assigning a PLU level, press the **L1**, **L2** or **L3** key. For example, if you want to assign PLU level 1 and key no. 1 to a PLU code, press the **L1** key and enter 1 before entering the PLU code. For key no. position, refer to section “3 Standard key number layout” in chapter “KEYBOARD”.

Procedure

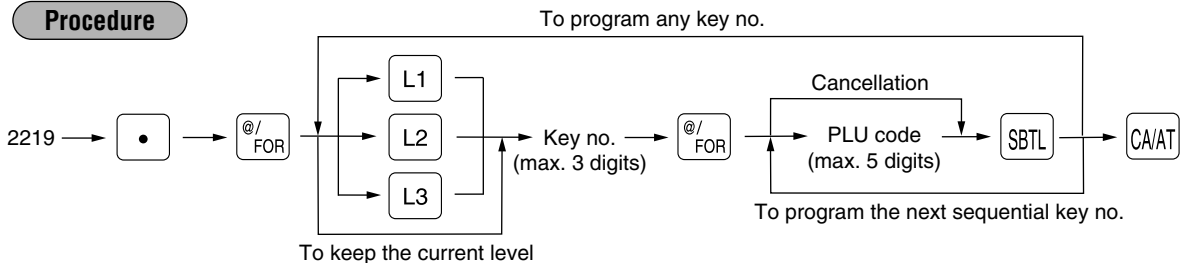

Note *The key number placement is determined by your local Authorized SHARP Dealer.*

Example Programming of PLU 1 (level 1) and PLU 65 (level 2) are assigned to key no. 21

Key operation

```

2219 [•] [④/ FOR]
[L1] 21 [④/ FOR] 1 [SBTL]
[L2] 21 [④/ FOR] 65 [SBTL]
           [CA/AT]
    
```

Print

```

#2219 *PGM2*

O21 L1      P00001
O21 L2      P00065
    
```

Key no.

6 Programming for miscellaneous keys

Only function keys which you have programmed on the keyboard will allow this programming.

■ Programming the rate (%), (CONV), commission) and the discount (⊖) PGM 1

PGM 2 1310 Direct

You can program percent rates, currency conversion rates, commission rate, and discount amount.

Procedure

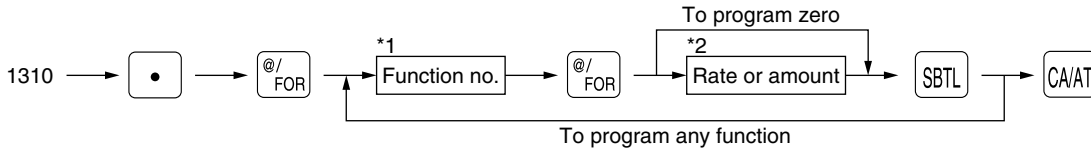

*1: Function no.

1: For the ⊖ key	7: For the %3 key	109: For the commission sale 1	115: For the commission sale 7
2: For the ⊖2 key	8: For the %4 key	110: For the commission sale 2	116: For the commission sale 8
3: For the ⊖3 key	71: For the CONV key	111: For the commission sale 3	117: For the commission sale 9
4: For the ⊖4 key	72: For the CONV2 key	112: For the commission sale 4	
5: For the % key	73: For the CONV3 key	113: For the commission sale 5	
6: For the %2 key		114: For the commission sale 6	

*2: Rate or amount

- 0 — 999999 (Discount amount)
- 0.00 — 100.00 (% rate)
- 0.0000 — 9999.9999 (Currency conversion rate)
- 0.00 — 999.99 (Commission rate)

Example

Assigning \$10.00 to the ⊖ key, 10.25% to the % key, and 1.325 to the CONV key.

Key operation

```

1310 [.] [ @/FOR ]
1 [ @/FOR ] 1000 [ SBTL ]
5 [ @/FOR ] 10 [.] 25 [ SBTL ]
71 [ @/FOR ] 1 [.] 325 [ SBTL ]
[ CA/AT ]
  
```

Print

```

#1310 *PGM2*
F001 (—) 1
S          -10.00 — Discount amount
           L17
F005 %1
S          3  -10.25% — Percent rate
           L100.00%
F071 CONV 1
           1.3250 — Conversion rate
  
```

Note

You must use a decimal point when setting percentage rates that are fractional.

■ Currency description text programming (CONV) PGM 2 2334

You can program a maximum of 4 characters for each of the CONV thru CONV4 keys.

Procedure

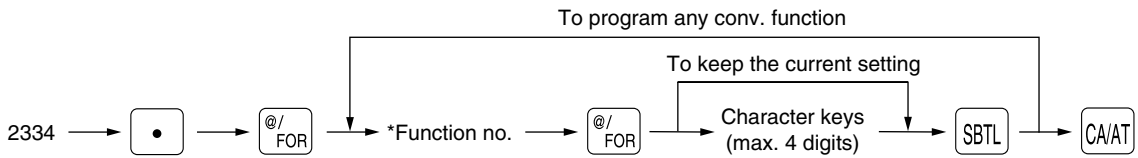

*: Function no.

71: For the CONV key 73: For the CONV3 key
 72: For the CONV2 key 74: For the CONV4 key

Example

Programming "US\$" for the CONV2 key

Key operation

2334 [.] [@/ FOR]
 72 [@/ FOR] [SPACE] US\$ [SBTL]
 [CA/AT]

Print

```

#2334 *PGM2*

F072 CONV 2   US$
                0.0000
  
```

Currency description text

■ A limit amount (HALO) of entry (⊖, TAX, RA, PO) PGM 2 2312 Direct

The HALO limit is in effect for the REG-mode operations but can be overridden in the MGR mode. The HALO limit is represented by two figures as follows:

Procedure

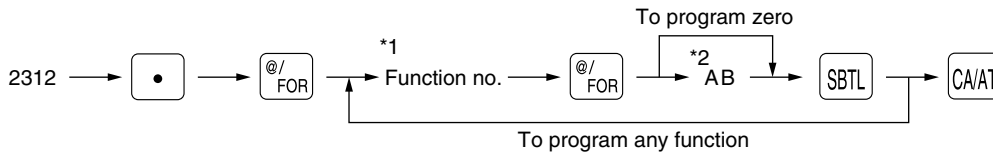

*1: Function no.

- | | |
|---------------------|---------------------|
| 1: For the ⊖ key | 64: For the RA key |
| 2: For the ⊖2 key | 65: For the RA2 key |
| 3: For the ⊖3 key | 66: For the PO key |
| 4: For the ⊖4 key | 67: For the PO2 key |
| 32: For the TAX key | |

*2: AB is the same as $A \times 10^B$.

- A: Significant digit (0 through 9)
 B: Number of zeros to follow significant digit
 0 through 7 (for the ⊖ thru ⊖4, and TAX keys)
 0 through 8 (for the RA, RA2, PO, and PO2 keys)

For example, presetting 13 (\$10.00) here means that amount entries of up to \$10.00 are allowed in the REG mode.

You can set up AB = 17 for no limitation (for the ⊖ thru ⊖4, and TAX keys).

You can set up AB = 18 for no limitation (for the RA, RA2, PO, and PO2 keys).

Example

Programming 13 for the ⊖ key.

Key operation

```
2312 . @/ FOR
1 @/ FOR 13 SBTL
CA/AT
```

Print

```
#2312 *PGM2*
F001 (-) 1
S -10.00
L13 —HALO limit
```

■ +/- sign, food stamp status, and tax status (% , ⊖) PGM 2 2311 Direct

+/- sign: Programming of the +/- sign assigns the premium or discount function for each key.

Food stamp status: Programming of the food stamp status decides whether a premium or discount should be dealt with as a food stamp-eligible amount or not.

Tax status: Programming of the tax status decides whether a premium or discount should be dealt with as a taxable (taxable 1/2/3/4) or non-taxable amount.

Note Tax 4 is prohibited if you use the food stamp function.

Procedure

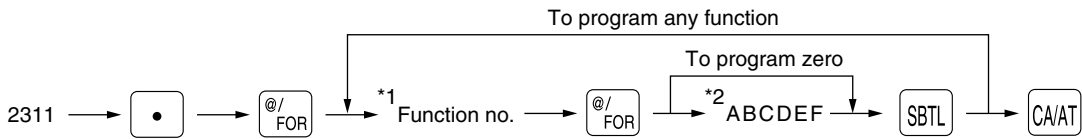

*1: Function no.

- 1: For the ⊖ key
- 2: For the ⊖2 key
- 3: For the ⊖3 key
- 4: For the ⊖4 key
- 5: For the % key
- 6: For the %2 key
- 7: For the %3 key
- 8: For the %4 key

*2: Item:	Selection:	Entry:
A (+/-) sign	Plus	0
	Minus	1
B Food stamp status	Ineligible	0
	Eligible	1
C Tax 4 status	Non-taxable	0
	Taxable	1
D Tax 3 status	Non-taxable	0
	Taxable	1
E Tax 2 status	Non-taxable	0
	Taxable	1
F Tax 1 status	Non-taxable	0
	Taxable	1

Example

Programming ABCDEF=100001 for the % key and ABCDEF=000000 for the %2 key

Key operation

2311 • @/ FOR
 5 @/ FOR 100001 SBTL
 6 @/ FOR 000000 SBTL
 CA/AT

Print

```
#2311 *PGM2*
F005 %1
S      3      -10.25%
      T1      L100.00%
F006 %2
S      3           0.00%
           L100.00%
```

Taxable 1

■ Percent entry type (%) PGM 2 2310

You can program the entry type of rates for percent entries.

Procedure

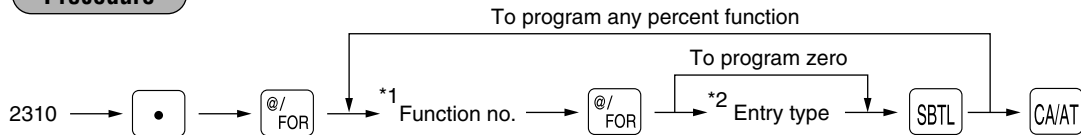

- | | |
|---------------------|------------------------------|
| *1: Function no. | *2: Entry type |
| 5: For the [%] key | 0: Inhibited entry |
| 6: For the [%2] key | 1: Open rate only |
| 7: For the [%3] key | 2: Preset rate only |
| 8: For the [%4] key | 3: Open rate and preset rate |

Example

Programming "Preset rate only" for the [%2] key

Key operation

```
2310 [.] [ @/ FOR ]
6 [ @/ FOR ] 2 [ SBTL ]
[ CA/AT ]
```

Print

```
#2310 *PGM2*
F006 [%2]
S 2 0.00%
L100.00%
```

"Preset rate only"

■ Item% or subtotal% selection (%) PGM 2 2315 Direct

Item%: Select this when a percent calculation is desired for the individual department and PLU.
Subtotal%: Select this when a percent calculation is desired for merchandise subtotals.

Procedure

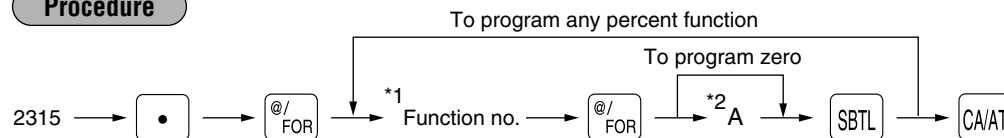

- | | |
|---------------------|--------------|
| *1: Function no. | *2: A |
| 5: For the [%] key | 0: Subtotal% |
| 6: For the [%2] key | 1: Item% |
| 7: For the [%3] key | |
| 8: For the [%4] key | |

Example

Programming "Item%" for the [%2] key

Key operation

```
2315 [.] [ @/ FOR ]
6 [ @/ FOR ] 1 [ SBTL ]
[ CA/AT ]
```

Print

```
#2315 *PGM2*
F006 [%2]
I 2 0.00%
L100.00%
```

Item%

■ Percent rate limitation (%) PGM 2 2313

You can program the upper limit of percent rates for percent entries.
Percent entries that use the upper limit may be overridden in the MGR mode.

Procedure

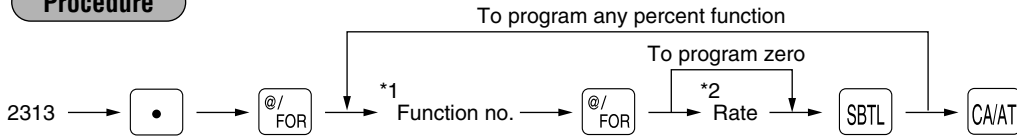

*1: Function no.

5: For the [%] key 7: For the [%3] key
6: For the [%2] key 8: For the [%4] key

*2: Rate

0.00 – 100.00 (Entering 0.00 inhibits the open percent rate entry)

Note The [.] key is needed only for fractional entry.

Example

Programming the limit to 15.5% for the [%2] key

Key operation

```

2313 [.] [%/FOR]
6 [%/FOR] 15 [.] 5 [SBTL]
                                     [CA/AT]
    
```

Print

```

#2313 *PGM2*
F006 [%2]
I      2          0.00%
L 15.50% — Limitation
    
```

■ Vendor or store coupon selection (⊖) PGM 2 2316 Direct

Vendor coupon: Select this when the coupon is to be applied to the total sales amount.
Store coupon: Select this when the coupon is to be applied to an individual department or PLU.

Procedure

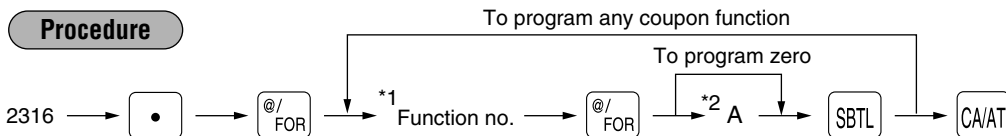

*1: Function no.

1: For the [⊖] key 3: For the [⊖3] key
2: For the [⊖2] key 4: For the [⊖4] key

*2: A

0: Vendor coupon (subtotal ⊖)
1: Store coupon (item ⊖)

Example

Programming the "Store coupon" for the [⊖2] key.

Key operation

```

2316 [.] [%/FOR]
2 [%/FOR] 1 [SBTL]
                                     [CA/AT]
    
```

Print

```

#2316 *PGM2*
F002 (→) 2
I          -0.00
L17
    
```

Item ⊖

7 Programming for the CA/AT, CA2, CHK, CHK2, and CH thru CH5 keys

Functional programming PGM 2 2320 Direct

You can set each media for:

- CAT transaction is compulsory**
- CAT action (POST-AUTH/DIAL)**
- CAT type (CREDIT/DEBIT/CHECK)**
- Card number printing selection**
- Card number print format (partial/full)**
- CAT signature line print selection**
- CAT expiration printing selection**
- Number of CAT authorization receipts (0 - 9)**
- Bill (slip) print compulsory**
- Footer printing on receipt**

This programming decides whether or not your machine should print a message at the foot of a receipt when a specified media key is used.

Non-add code compulsory

You can enforce the non-add code entry when a media entry is accepted.

Change enable (over tender enable)

Either change enable or disable can be selected for a corresponding media key.

Validation printing compulsory

If media entries must be validated, set the corresponding media for compulsory validation print.

Drawer opening

You can program each media key to or not to open the drawer.

Amount tendered compulsory

You may select amount tendered compulsory or optional for the CA/AT, CA2, CHK, and CHK2 keys.

You may select amount tendered compulsory or inhibited for the CH thru CH5 keys.

Procedure

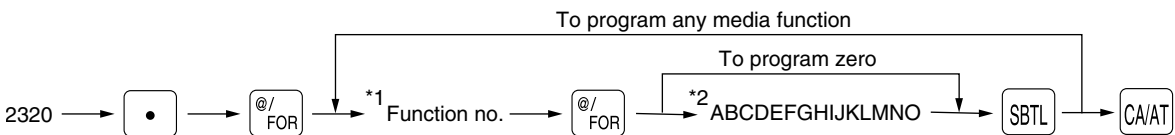

*1: Function no.

- 61: For the CA/AT key
- 62: For the CA2 key
- 76: For the CH key
- 78: For the CH2 key

- 80: For the CH3 key
- 82: For the CH4 key
- 84: For the CH5 key
- 86: For the CHK key

- 87: For the CHK2 key
- 56: For the SRVC key
- 63: For the FS TEND key
- 159: For the FINAL key

*2: Item:	Selection:	Entry:
A CAT transaction	Non-compulsory	0
	Compulsory	1
B CAT action	POST-AUTH	0
	DIAL	1
C CAT type	CREDIT	0
	DEBIT	1
	CHECK	2
D Card number printing	Yes	0
	No	1
E Card number print format	Partial (printing only part of the card number)	0
	Full (printing the entire card number)	1
F CAT signature line print	Yes	0
	No	1
G CAT expiration printing	Yes	0
	No	1
H Number of CAT authorization receipts		0 thru 9
I Bill (slip) printing	Non-compulsory	0
	Compulsory	1
J Footer printing on receipt	No	0
	Yes	1
K Non-add code entry	Non-compulsory	0
	Compulsory	1
L Change enable (over tender enable)	Enable	0
	Disable	1
M Validation printing	Non-compulsory	0
	Compulsory	1
N Drawer opening	Yes	0
	No	1
O Amount tendered operation	Optional amount tendered for cash or check	0
	Inhibit amount tendered for charge	0
	Compulsory amount tendered	1

Note

- For the **SRVC** or **FINAL** key, always enter 0 as A thru H and J thru O.
- For the **FS/TEEND** key, always enter 0 as A thru H, K, L, and O.

Example

Programming of the **CH3** key for selecting only to have compulsory amount tendered

Key operation	Print
2320 <input type="checkbox"/> @/FOR 80 <input type="checkbox"/> @/FOR 0000000000000001 <input type="checkbox"/> SBTL <input type="checkbox"/> CA/AT	#2320 *PGM2* F080 CHARGE3 KP000 L18 0000 0000000000000001
	A thru O

Tax delete PGM 2 2326

You can program each media key to delete tax (i.e. tax 1, tax 2, tax 3, tax 4) when it is pressed.

Procedure

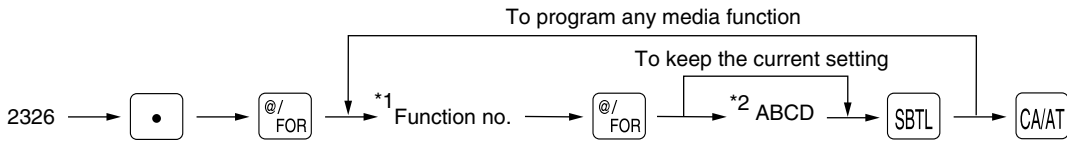

*1: Function no.

- 61: For the key
- 62: For the key
- 76: For the key
- 78: For the key
- 80: For the key
- 82: For the key
- 84: For the key
- 86: For the key
- 87: For the key

*2: Item:	Selection:	Entry:
A Tax 4 calculation status	calculate tax 4	0
	delete tax 4	1
B Tax 3 calculation status	calculate tax 3	0
	delete tax 3	1
C Tax 2 calculation status	calculate tax 2	0
	delete tax 2	1
D Tax 1 calculation status	calculate tax 1	0
	delete tax 1	1

Example

Programming the key to delete tax 1

Key operation

2326
 80 0001

Print

```
#2326 *PGM2*
F080 CHARGE3 KP000 L18
0001 0000000000000001
```

A thru D

■ High amount lockout (HALO) for check cashing, check change, and cash in drawer PGM 2 2321

You can program the upper limit amounts for check cashing, check change, and cash in drawer.

Procedure

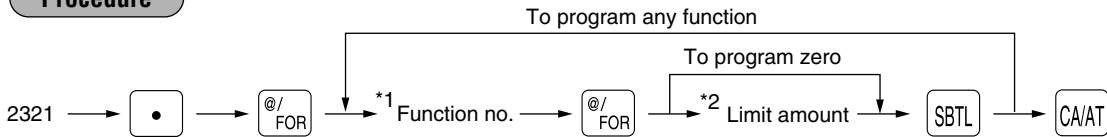

*1: Function no.

68: For check cashing

69: For check change

89: For cash in drawer (sentinel)

*2: Limit amount

0 thru 999999.99 (check cashing and check change)

0 thru 999999.99 (cash in drawer)

Example

Setting the limit to \$99.99 for check cashing.

Key operation

2321 • @/FOR
68 @/FOR 9999 SBTL
CA/AT

Print

```
#2321 *PGM2*
F068 CA/CHK          99.99
```

■ High amount lockout (HALO) of entry for media keys PGM 2 2322 Direct

The HALO limit is in effect for REG mode operations but can be overridden in the MGR mode. The HALO limit is represented by two figures as follows:

Procedure

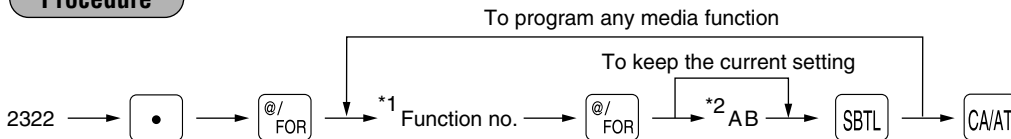

*1: Function no.

61: For the CA/AT key

62: For the CA2 key

76: For the CH key

78: For the CH2 key

80: For the CH3 key

82: For the CH4 key

84: For the CH5 key

86: For the CHK key

87: For the CHK2 key

*2: AB

A: Significant digit (1 thru 9)

B: Number of zeros to follow significant digit (0 thru 8)

You can set up AB = 18 for no limitation.

Example

Setting the HALO limit to \$1000.00 (15) for the CH3 key

Key operation

2322 • @/FOR
80 @/FOR 15 SBTL
CA/AT

Print

```
#2322 *PGM2*
F080 CHARGE3 KP000 L15 — HALO
0001 0000000000000001
```

Print station assignment PGM 2 2328

When you use a remote printer, consult your dealer.

Procedure

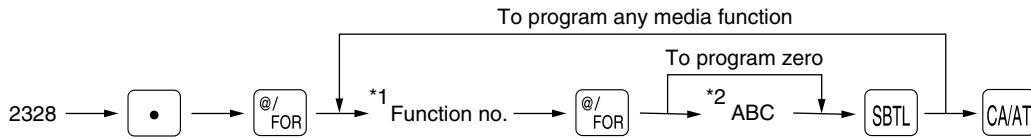

*1: Function no.

61: For the CA/AT key

62: For the CA/2 key

76: For the CH key

78: For the CH/2 key

80: For the CH/3 key

82: For the CH/4 key

84: For the CH/5 key

86: For the CHK key

87: For the CHK/2 key

56: For the SRVC key

63: For the FS TEND key

159: For the FINAL key

*2: **Item:**

Selection:

Entry:

Item:	Selection:	Entry:
A Remote printer 1 output	Output	1
	Not output	0
B Remote printer 2 output	Output	1
	Not output	0
C Printing on the chit receipt	Yes	1
	No	0

Example

Programming of the CH/3 key for selecting “remote printer 1 output/remote printer 2 not output/printing on chit receipt”

Key operation

2328 • @/ FOR
 80 @/ FOR
 101 SBTL
CA/AT

Print

#2328 *PGM2*

F080 CHARGE3 KP101 L15

0001 0000000000000001

Print station

8 Programming of function text

■ Programming PGM 2 2314

You can program a maximum of 8 characters for each function key and other functions using the table on the following pages. Select the characters you want to program referring to section "2 How to program alphanumeric characters" in chapter "PRIOR TO PROGRAMMING".

Procedure

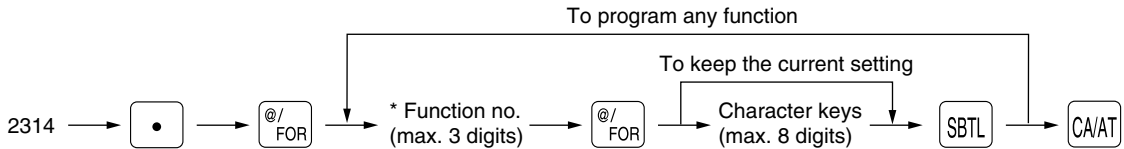

* Function no.: See "List of function texts" on the following pages.

Example

Programming VISA for CH3 key

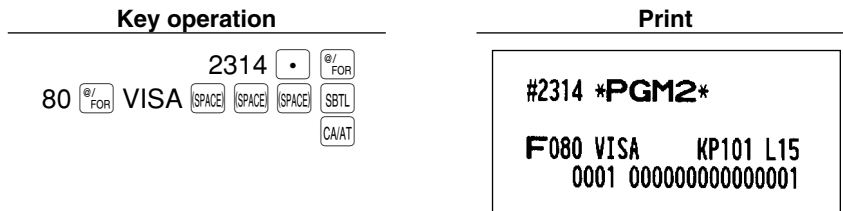

■ List of function texts

Function no.	Key or function	In default of programming
1	⊖ 1	(-) 1
2	⊖ 2	(-) 2
3	⊖ 3	(-) 3
4	⊖ 4	(-) 4
5	%1	% 1
6	%2	% 2
7	%3	% 3
8	%4	% 4
9	Net sales total	NET 1
10	Net taxable 1 subtotal	TAX1 ST
11	Gross tax 1 total	GRS TAX1
12	Tax 1 total of refund entries	RFD TAX1
13	Net tax 1 total	TAX1
14	Exempt tax 1	TX1 EXPT
15	Net taxable 2 subtotal	TAX2 ST
16	Gross tax 2 total	GRS TAX2
17	Tax 2 total of refund entries	RFD TAX2
18	Net tax 2 total	TAX2
19	Exempt tax 2	TX2 EXPT
20	Net taxable 3 subtotal	TAX3 ST
21	Gross tax 3 total	GRS TAX3
22	Tax 3 total of refund entries	RFD TAX3
23	Net tax 3 total	TAX3
24	Exempt tax 3	TX3 EXPT
25	Net taxable 4 subtotal	TAX4 ST
26	Gross tax 4 total	GRS TAX4
27	Tax 4 total of refund entries	RFD TAX4
28	Net tax 4 total	TAX4
29	Exempt tax 4	TX4 EXPT
30	Gross manual tax total	GRS MTAX
31	Refund manual tax total	RFD MTAX
32	Net manual tax total	M-TAX
*33	Exempt total from GST	GST EXPT
*34	PST total	PST TTL
*35	GST total	GST TTL
36	FS1 forgive	FS TX1
37	FS2 forgive	FS TX2
38	FS3 forgive	FS TX3
39	Tax total	TTL TAX
40	Net	NET
41	Sales total including tax total	NET 2
42	Coupon-like PLU	CP PLU
43	Item void	VOID
44	Subtotal void	SBTL VD
45	Manager void	MGR VD
46	Void mode	VOID
47	Refund	REFUND

Function no.	Key or function	In default of programming
48	Hash item void	HASH VD
49	Hash item refund	HASH RF
50	No sale	NO SALE
51	Validation print counter	VP CNT
52	Bill (slip) counter	BILL CNT
53	Drawer counter	DRW CNT
54	Tray subtotal	TRAY TL
55	PBAL	* * *PBAL
56	Service	SERVICE
57	Deposit	DEPOSIT
58	Deposit refund	DPST RF
59	Customer counter	TRANS CT
60	Sales total	NET 3
61	Cash	C ASH
62	Cash2	C ASH2
63	Food stamp sales	FSSALE
64	RA	* * *RA
65	RA2	* * *RA2
66	PO	* * *PO
67	PO2	* * *PO2
68	Check cashing	CA/CHK
69	Check change	CHK/CG
70	Food stamp change	FS/CG
71	Currency conversion1	CONV 1
72	Currency conversion2	CONV 2
73	Currency conversion3	CONV 3
74	Currency conversion4	CONV 4
75	Food stamp in drawer	FS/ID
76	Gross charge1	CHARGE1
77	Refund charge1	CHARGE1-
78	Gross charge2	CHARGE2
79	Refund charge2	CHARGE2-
80	Gross charge3	CHARGE3
81	Refund charge3	CHARGE3-
82	Gross charge4	CHARGE4
83	Refund charge4	CHARGE4-
84	Gross charge5	CHARGE5
85	Refund charge5	CHARGE5-
86	Check	CHECK1
87	Check2	CHECK2
88	Cash + check in drawer	CA/CH ID
89	Cash in drawer	* * * *CID
*90	Exempt VAT	VAT EXPT
91	Sales average	AVE.
92	Group 1	G ROUP01
93	Group 2	G ROUP02
94	Group 3	G ROUP03

Function no.	Key or function	In default of programming	Function no.	Key or function	In default of programming
95	Group 4	G ROUP04	134	CCD differ total	DIF. TL
96	Group 5	G ROUP05	135	Subtotal	SUBTOTAL
97	Group 6	G ROUP06	136	Merchandise subtotal	MDSE ST
98	Group 7	G ROUP07	137	Total	***TOTAL
99	Group 8	G ROUP08	138	Change	CHANGE
100	Group 9	G ROUP09	139	Food stamp subtotal	FS ST
101	Price level 1 for PLU	LEVEL 1	140	Food stamp tender	FS TEND
102	Price level 2 for PLU	LEVEL 2	141	Food stamp change	FS CG
103	(+)Dept. total	*DEPT TL	142	Items	ITEMS
104	(-)Dept. total	DEPT(-)	143	Copy receipt title	D E P T
105	Hash (+)dept. total	*HASH TL	144	Group report title	GROUP
106	Hash (-)dept. total	HASH(-)	145	PLU/UPC report title	PLU/UPC
107	(+)Bottle return total	*BTTL TL	146	Stock report title	STOCK
108	(-)Bottle return total	BTTL(-)	147	Zero sales report title	ZERO SAL
109	Commission sale 1	COM.SAL1	148	Category report title	CATEGORY
110	Commission sale 2	COM.SAL2	149	Transaction report title	TRANS.
111	Commission sale 3	COM.SAL3	150	Cash in drawer report title	C I D
112	Commission sale 4	COM.SAL4	151	Commission sales report title	SALES
113	Commission sale 5	COM.SAL5	152	CCD report title	C C D
114	Commission sale 6	COM.SAL6	153	Cashier report title	CASHIER
115	Commission sale 7	COM.SAL7	154	Hourly report title	HORLY
116	Commission sale 8	COM.SAL8	155	Daily net report title	DAILY
117	Commission sale 9	COM.SAL9	156	PBLU report title	P B L U
118	Non commission sale	NON COM.	157	Non-add code text	#
119	Commission amount 1	COM.AMT1	158	Copy receipt title	C O P Y
120	Commission amount 2	COM.AMT2	159	Final (used only for PGM mode)	FINAL
121	Commission amount 3	COM.AMT3	160	Balance	BALANCE
122	Commission amount 4	COM.AMT4	161	Slip print message on journal	SLIP PR.
123	Commission amount 5	COM.AMT5	162	Slip next page	NEXT P.
124	Commission amount 6	COM.AMT6	163	Balance forward	BAL FWD
125	Commission amount 7	COM.AMT7	164	Tare weight	TARE WT.
126	Commission amount 8	COM.AMT8	165	DUE (text on display)	DUE
127	Commission amount 9	COM.AMT9	166	TAX ST (text on display)	TAX ST
128	Commission amount total	COM.TTL	167	AMOUNT (text on display)	AMOUNT
129	Cash/check is	CA/CH IS	168	WEIGHT (text on display)	WEIGHT
130	Conversion1 is	CONV1 IS	169	Refund type of sales (text on display)	RF SALE
131	Conversion2 is	CONV2 IS	170	Vender coupon UPC	V. CP UPC
132	Conversion3 is	CONV3 IS	171	Non-accessed UPC report title	NO ACCES
133	CCD differ	CCD DIF.	172	Price change title	PR. CHNG

Note

- The items marked with “ * ” are for Canada only.
- The function no. 90 “Exempt VAT” is only effective for the Canadian tax system (2 GST, VAT type).

9 Cashier programming

■ Cashier code PGM 1 PGM 2 1500

You can assign a cashier code to each cashier. For more details, please contact your local dealer.

Procedure

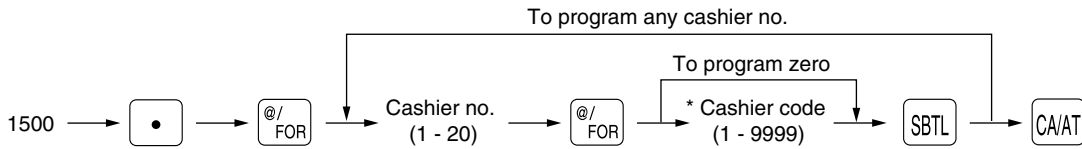

* Programming cashier code "0" inhibits entries of the cashier code.

Example

To program 1111 for cashier no.1 and 1014 for cashier no. 4

Key operation

```

1500 [.] [ @/FOR ]
1 [ @/FOR ] 1111 [ SBT ]
4 [ @/FOR ] 1014 [ SBT ]
                                     [ CA/AT ]
    
```

Print

```

#1500 *PGM2*

01CSR#      1111
             D1
04CSR#      1014
             D1
    
```

Cashier code

■ Cashier name PGM 1 PGM 2 1514

You can program a maximum of 8 characters (cashier name) for each cashier. Select the characters you want to program referring to section "2 How to program alphanumeric characters" in chapter "PRIOR TO PROGRAMMING".

Procedure

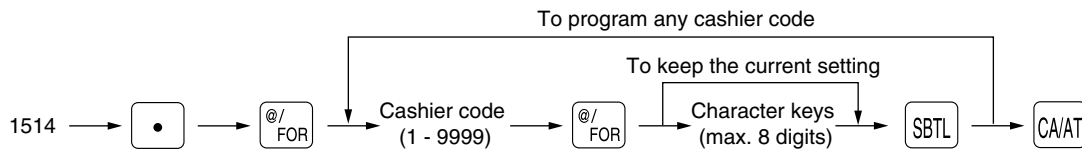

Note

The cashier code must be programmed for the cashier by job #1500 prior to assigning text.

Example

To program "DICK" for cashier code 1111 and "PETER" for cashier code 1014

Key operation

```

1514 [.] [ @/FOR ]
1111 [ @/FOR ] DICK [ SBT ]
1014 [ @/FOR ] PETER [ SBT ]
                                     [ CA/AT ]
    
```

Print

```

#1514 *PGM2*

01CSR# DICK      1111
             D1
04CSR# PETER     1014
             D1
    
```

Cashier name

Journal print form

You may choose either of the following forms.

- Detailed journal print that shows the details of all entries – the same information as printed on the receipt.
- Summary journal print that shows information about all entries other than normal department entries (entries into “+” departments and their associated “+” PLUs).

Availability of the item validation printing

Validation printing in a discount (⊖) entry

Zero skip for various reports

Automatic return mode for PLU level

- By one receipt: Returns the PLU level to level 1 after each receipt.
- By one item: Returns the PLU level to level 1 after each item entry.

Available mode for PLU/UPC price shift

PLU/UPC price shift mode

- Automatic return mode: This mode automatically shifts the price level back to price 1 (ordinary level) after the entry.
- Lock shift mode: This mode holds the current price level until making a price shift selection (pressing the price shift key).

Automatic return mode for PLU/UPC price level

- By one receipt: Returns the price level to price 1 after each receipt.
- By one item: Returns the price level to price 1 after each item entry.

No sale in REG mode

Finalization when the subtotal amount is zero in the REG mode

Item printing in PBLU transactions on the slip

Usability of the RA entry

Validation printing in a check cashing entry

Validation printing in a RA entry

Validation printing in a PO entry

Birthday date printing for the age limitation

Footer graphic logo printing

Learning function of UPC entry

Price change function in REG mode

Printing of the price shift text on the receipt/journal

Treating the EAN8 code (200XXXXC/D)

Price entry after ISBN/ISSN code entry

Procedure

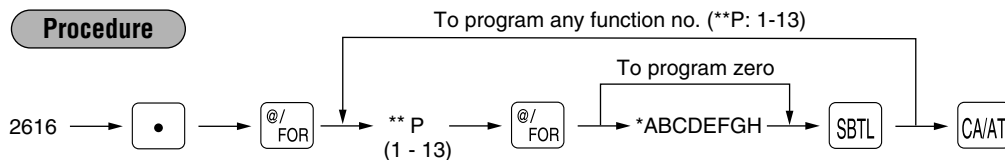

**P: 1

* Item:	Selection:	Entry:
A OP X/Z mode	Enable	0
	Disable	1
B Paid-out in REG mode	Enable	0
	Disable	1
C Refund type of sale in the REG mode	Enable	0
	Disable	1
D Refund in the REG mode	Enable	0
	Disable	1
E Direct void in REG mode	Enable	0
	Disable	1
F Indirect void in the REG mode	Enable	0
	Disable	1

* Item:	Selection:	Entry:
G Subtotal void in REG mode	Enable	0
	Disable	1
H Validation printing in a refund entry	Non-compulsory	0
	Compulsory	1

**P: 2

* Item:	Selection:	Entry:
A The first item direct void	Enable	0
	Disable	1
B PLU level shift mode	Automatic return mode	0
	Lock shift mode	1
C Available mode for PLU level shift	REG and MGR modes	0
	MGR mode only	1
D Printing of the number of purchased items	No	0
	Yes	1
E Time printing on the receipt/journal	Yes	0
	No	1
F Journal print form	Detailed	0
	Limited	1
G Availability of the item validation printing	Enable	0
	Disable	1
H Validation printing in a discount (⊖) entry	Non-compulsory	0
	Compulsory	1

**P: 3

* Item:	Selection:	Entry:
A Always enter 0.		0
B Always enter 0.		0
C Zero skip in cashier report	Yes	0
	No	1
D Zero skip in transaction report	Yes	0
	No	1
E Zero skip in department report	Yes	0
	No	1
F Zero skip in PLU/UPC report	Yes	0
	No	1
G Zero skip in hourly report	Yes	0
	No	1
H Zero skip in daily net report	Yes	0
	No	1

**P: 4

* Item:	Selection:	Entry:
A Always enter 0.		0
B Always enter 0.		0
C Always enter 0.		0
D Always enter 0.		0
E Always enter 0.		0
F Always enter 0.		0
G Always enter 0.		0
H Automatic return mode for PLU level	After each item	0
	After each receipt	1

**P: 5

* Item:	Selection:	Entry:
A Always enter 0.		0
B Always enter 0.		0
C Always enter 0.		0
D Always enter 0.		0
E Always enter 0.		0
F Available mode for PLU/UPC price shift	REG and MGR modes	0
	MGR mode only	1
G PLU/UPC price shift mode	Automatic return mode	0
	Lock shift mode	1
H Automatic return mode for PLU/UPC price level	After each item	0
	After each receipt	1

**P: 6 (ABCDEFGH: Always enter 0.)

**P: 7

* Item:	Selection:	Entry:
A Always enter 0.		0
B Always enter 0.		0
C No sale in REG mode	Enable	0
	Disable	1
D Finalization when the subtotal amount is zero in the REG mode	Enable	0
	Disable	1
E Item printing in PBLU transaction on the slip	Yes	0
	No	1
F Always enter 0.		0
G Always enter 0.		0
H Always enter 0.		0

**P: 8

* Item:	Selection:	Entry:
A Always enter 0.		0
B Always enter 0.		0
C Always enter 0.		0
D Usability of the RA entry	Without limitation	0
	Only for PBLU transaction	1
E Validation printing in a check cashing	Non-compulsorly	0
	Compulsory	1
F Validation printing in a RA entry	Non-compulsorly	0
	Compulsory	1
G Validation printing in a PO entry	Non-compulsorly	0
	Compulsory	1
H Always enter 0.		0

**P: 9

* Item:	Selection:	Entry:
A Always enter 0.		0
B Always enter 0.		0
C Birthday date printing for the age limitation	Yes	0
	No	1
D Always enter 0.		0
E Always enter 0.		0
F Always enter 0.		0
G Always enter 0.		0
H Footer graphic logo printing	No	0
	Yes	1

**P: 10

* Item:	Selection:	Entry:
A and B Always enter 0.		0
C Learning function of UPC entry	Yes	0
	No	1
D to H Always enter 0.	(Fixed position)	0

**P: 11 (ABCDEFGH: Always enter 0.)

**P: 12

* Item:	Selection:	Entry:
A to G Always enter 0.		0
H Price change function in REG mode	Enable	0
	Disable	1

**P: 13

* Item:	Selection:	Entry:
A to C Always enter 0.		0
D Printing of the price shift text on the receipt/journal	Yes	0
	No	1
E Always enter 0.		0
		0
F Treating the EAN8 code (200XXXXC/D)	Yes	0
	No	1
G Always enter 0.		0
H Price entry after ISBN/ISSN code entry	Compulsory	0
	Inhibited	1

Example

Programming to select zero suppression for the cashier report, transaction report, dept. report, PLU/UPC report and daily net report, and to select non-skip printing for an hourly report.

Key operation

2616 • @/FOR
 3 @/FOR 00000010 SBT/L
 CA/AT

Print

#2616 *PGM2*
 03 00000010
 P: 1 thru 13
 A thru H

■ Programming the parameter of the slip printer

PGM 2

2615

Procedure

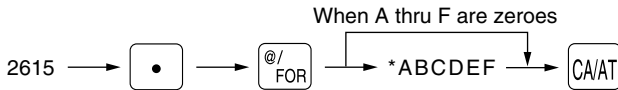

- * AB: Initial slip feed line (0 to 64)
- CD: Slip print max. line no. (0 to 99)
- E: Validation printing counter (1 thru 9 times)
To inhibit validation printing, enter 0.
- F: Feed lines after printing of a tray subtotal (0 thru 9 lines)

Example

Entering 009910 to ABCDEF

Key operation

2615 [•] [@/ FOR]
009910 [CAVAT]

Print

```
#2615 *PGM2*
          00 99 1 0
```

■ Setting the time limit for THE TILL TIMER™

PGM 2

2617

The machine counts the number of times the drawer is left open for longer than a programmed time limit. The counter will be incremented by one each time a programmed time limit is reached. The time limit for THE TILL TIMER™ can be preset for 0 to 255 seconds. The count is printed on the general report and cashier report.

Procedure

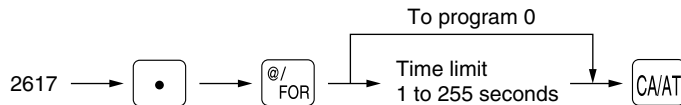

Example

Setting the time limit as 30 (seconds).

Key operation

2617 [•] [@/ FOR]
30 [CAVAT]

Print

```
#2617 *PGM2*
          030
```



■ Programming of logo messages PGM 2 2614

Your register can print programmed messages for customers on every receipt. On the standard model, the ER-A410 prints a graphic logo/the ER-A420 is set to print a header 3-line message on the receipt. (If you want a graphic logo customerized for your store, please consult your dealer.)

If you want to print logo message, please consult your dealer too. You have five options described below.

Select the characters you want to program, referring to section "2 How to program alphanumeric characters" in chapter "PRIOR TO PROGRAMMING."

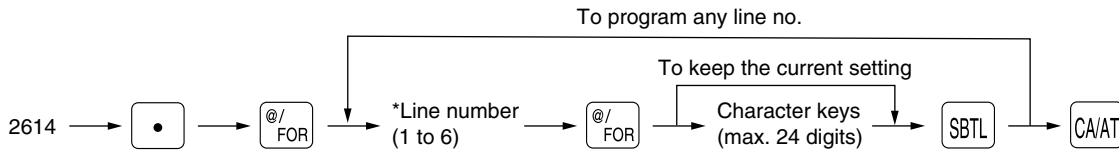
Procedure



* "Header 3-line message" type: 1 to 3

"Footer 3-line message" type : 4 to 6

"Header 6-line message" type: 1 to 6

"Header 3-line and footer 3-line message" type: 1 to 6 (1 to 3 as header, 4 to 6 as footer)

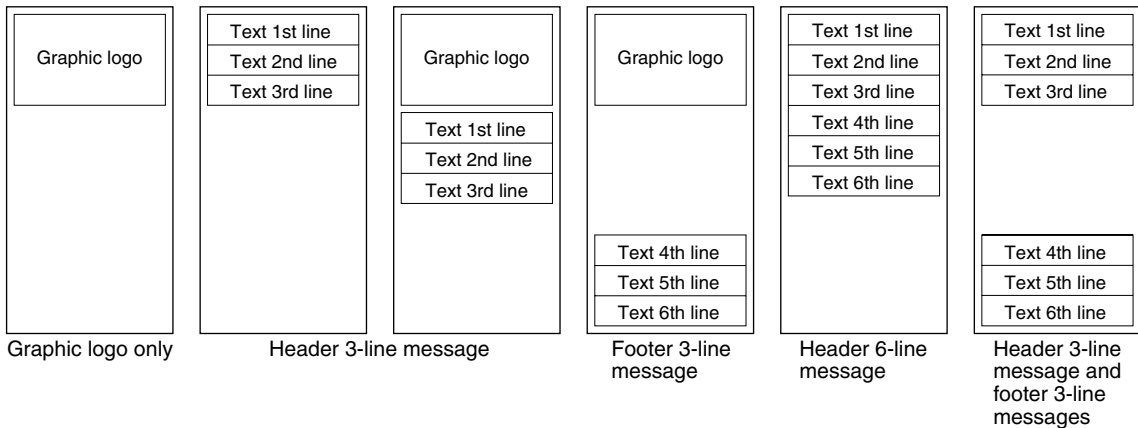

Example

To program the following logo message by using 3 lines:

YOUR
STORE
MESSAGE

Key operation

```

2614 [.] [ @/ FOR ]
1 [ @/ FOR ] [SPACE] [SPACE] [SPACE] [SPACE] [SPACE] [SPACE] [SPACE] [SPACE]
  (DC) YOUR (DC)
  [SPACE] [SPACE] [SPACE] [SPACE] [SPACE] [SPACE] [SPACE] [SPACE]
2 [ @/ FOR ] [SPACE] [SPACE] [SPACE] [SPACE] [SPACE] [SPACE] [SPACE] [SPACE]
  (DC) STORE (DC)
  [SPACE] [SPACE] [SPACE] [SPACE] [SPACE] [SPACE] [SPACE] [SPACE]
3 [ @/ FOR ] [SPACE] [SPACE] [SPACE] [SPACE] [SPACE] [SPACE] [SPACE] [SPACE]
  (DC) MESSAGE (DC)
  [SPACE] [SPACE] [SPACE] [SPACE] [SPACE] [SPACE] [SPACE] [SPACE]
  [ SBT ]
  [ CA/AT ]
  (SPACE):Space key
  
```

Print

```

#2614 *PGM2*
YOUR
STORE
MESSAGE
  
```

■ Selection of X1/Z1 and X2/Z2 reports to be printed in the stacked report sequence PGM 2 2620

Your register is equipped with the stacked report printing function that enables multiple X/Z reports to be printed in sequence with only a single request.

Procedure

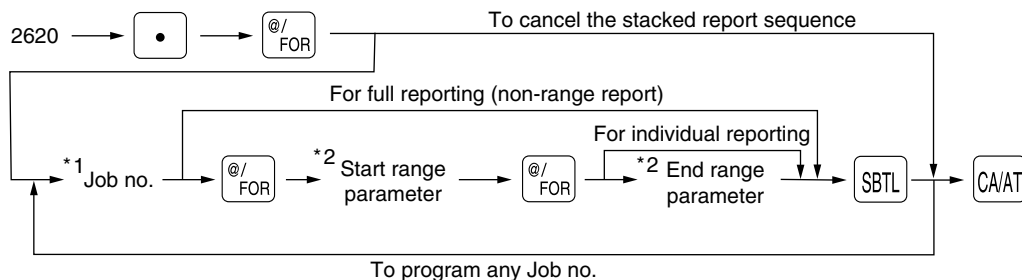

Note

- A maximum of 70 steps are programmable. "1 step" means the memory size used for one no-range type job no. The range type job no. needs "8 steps".
- When the Z of stacked report is initiated, X only reports will be skipped.

Job code numbers to be used are as follows.

*1: Job no.	Report name	*2: Start/End range parameter	Note
00	General		
10	Full department		
13	Full department group		
20	PLU/UPC	*3 Start code/End code (max. 5/13 digits)	
24	PLU/UPC stock	*3 Start code/End code (max. 5/13 digits)	
27	PLU/UPC zero sales		
29	PLU/UPC price category	*3 Start price amount/End price amount	
30	Transaction		
31	Cash in drawer		
32	Commission sale		
50	Full cashier		
60	Hourly sales information	*3 Start time/End time (0 thru 2330)	Range report is available only in the X1 mode.
70	Daily net report		
80	PBLU report	*3 Start PBLU code/End PBLU code (1 thru 9999)	

*3: Both range setting and full setting are allowed.

Example

To print reports 10 and 13 as a stacked report.

Key operation

2620 • @/
FOR
10 SBTL
13 SBTL
CA/AT

Print

#2620 *PGM2*

10
13

■ Setting the time range for hourly reports PGM 2 2619

You can set the time range for the hourly report.

Procedure

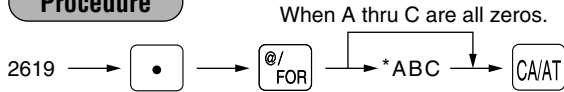

*A: Time range

To set the time range to 30 minutes (in the 24-hour system), enter 0.

To set the time range to 60 minutes (in the 24-hour system), enter 1.

BC: Starting time (hour = 00 to 23)

Example

Setting the time range to 60 minutes with the starting time being set at 7:00

Key operation

```

    2619 • @/ FOR
          107 CA/AT
  
```

Print

```

    #2619 *PGM2*
                1 07
  
```

Note To change this setting, an hourly Z report (#160) must be taken prior to the changes.

■ Programming of power saving mode PGM 2 2689

Procedure



* Item:	Selection:	Entry:
A Entering power save mode when time is displayed.	Enable	0
	Disable	1
BCD Time (min.) to entering power save mode since no operation is made.		1 through 254 (min.) (999: The power save mode is inhibited.)

Example

Key operation

```

    2689 • @/ FOR
          0030 CA/AT
  
```

Print

```

    #2689 *PGM2*
                0 030
  
```

■ PBLU code programming PGM 2 2810

You can specify the range of PBLU codes available for the register.

Procedure

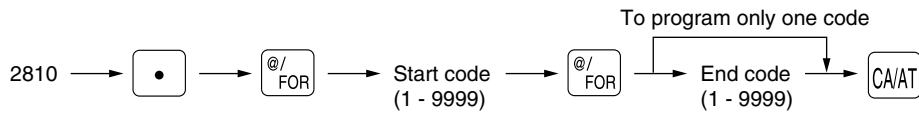

Example

Programming 1 for start code and 1000 for end code

Key operation

2810
 1
 1000

Print

```
#2810 *PGM2*
          0001-1000
```

■ Functional programming for the printer PGM 2 2990

You can program the printing density of the receipt/journal printer.

Procedure

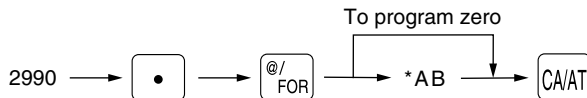

*AB: Printing density (00 – 99)

00 = 80% for standard density
 50 = 90% for standard density
 99 = 100% for standard density

Example

Programming "90% for standard density"

Key operation

2990
 50

Print

```
#2990 *PGM2*
          50
```

■ Programming of error messages PGM 2 2641

Your register has standard error messages as indicated in the following list. For more information about the alphanumeric characters programming, see section “2 How to program alphanumeric characters” under the chapter “PRIOR TO PROGRAMMING”.

Procedure

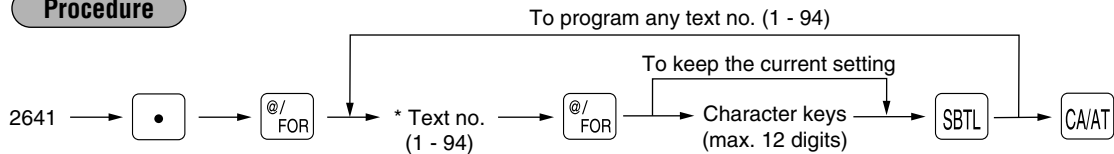

* Text no.: See “LIST OF ERROR MESSAGES” shown below.

Example

Programming “ENTRY ERROR” for text no. 1

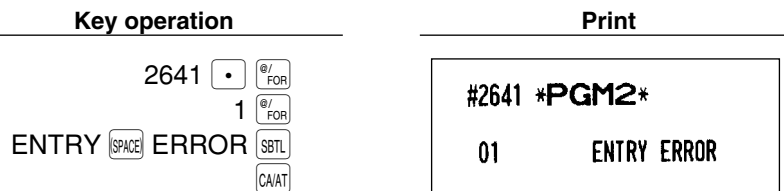

■ LIST OF ERROR MESSAGES

Text no.	Description	In default of programming
1	Registration error	ENTRY ERROR
2	Misoperation error	MISOPERATION
3	Desired code is not programmed yet.	NO RECORD
4	(Reserved)	
5	Secret code error	SECRET CODE
6	Code is not free	NOT FREE
7	Memory is full.	MEMORY FULL
8	Insert slip paper.	INSERT SLIP
9	The entered cashier's code is not authorized.	NO AUTHORITY
10	Stock is empty.	OUT OF STOCK
11	Compulsory pushing the subtotal key	SBTL COMPUL.
12	Compulsory tendering	TEND COMPUL.
13	Compulsory PBLU entry	PB COMPUL.
14-19	(Reserved)	
20	Remote printer off line	OFF LINE
21	(Reserved)	
22	Overlapped cashier error	CASHIER ERR.
23-26	(Reserved)	
27	Power off	POWER OFF
28-30	(Reserved)	
31	Compulsory non-add code	# COMPULSORY
32	The cashier is not assigned.	NOT ASSIGNED
33	(Reserved)	
34	Overflow limitation	OVER LIMIT.
35	The open price entry is inhibited.	INH. OPEN PR
36	The unit price entry is inhibited.	INH. UNIT PR
37	The direct non-tendering finalization after previous tender entry is inhibited.	NOT NON-TEND
38	Read error of scale data	SCALE ERROR

Text no.	Description	In default of programming
39-50	(Reserved)	
51	Weight on scale	WEIGHT
52-53	(Reserved)	
54	Entry of tare weight	ENTR TARE WT
55-60	(Reserved)	
61	Desired code is not programmed yet. (learning function)	NO RECORD
62	Enter price and dept. no.	PRICE → DEPT
63	Enter price and dept. no.	PRICE & DEPT
64	Enter dept. no.	ENTER DEPT#
65-66	(Reserved)	
67	REG buffer is full.	BUFFER FULL
68-69	(Reserved)	
70	Price entry at UPC refund	ENTER PRICE
71-73	(Reserved)	
74	Non-accessed UPC delete job	DELETE
75	(Reserved)	
76	Closing the drawer is compulsory.	CLOSE DRAWER
77-78	(Reserved)	
79	Reading of undefined vender coupon UPC	OP ENTER
80	(Reserved)	
81	Message for prompting entry of secret code	ENTR SECRET#
82-83	(Reserved)	
84	Data backup send success	SEND OK
85	Data backup receive success	RECEIVE OK
86	Data backup communication error	COM. ERROR
87	Backup data format error	DATA ERROR
88	Data backup time out error	TIME OUT
89-93	(Reserved)	
94	Age limitation error	AGE ERROR

■ Check validation message PGM 2 2642

You can program the text (3 lines) to be printed on validation slip. Up to 24 characters can be programmed per line.

Procedure

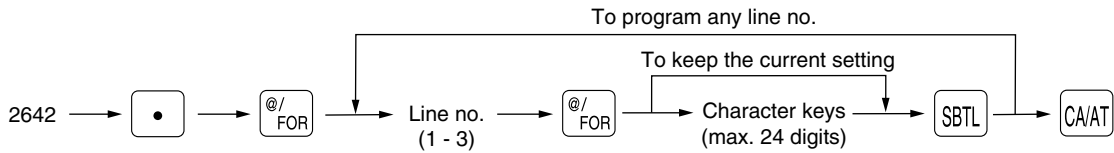

Example

Programming “FOR DEPOSIT ONLY” for the check validation message

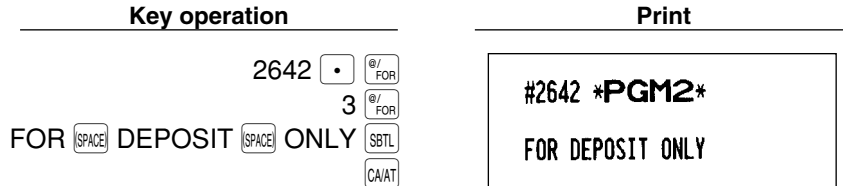

Note The PRINT key must be placed on the keyboard.

■ Slip printer’s logo message PGM 2 2643

You can program the text (3 lines) to be printed on slip. Up to 24 characters can be programmed per line.

Procedure

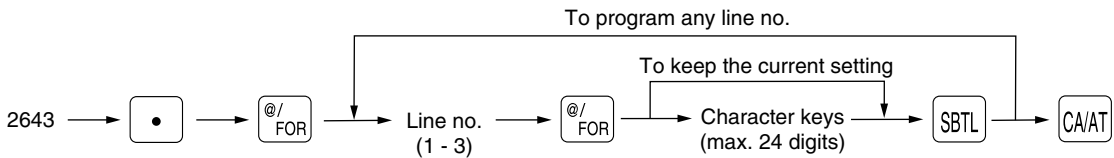

Example

Programming “TEXT1” for the slip printer’s logo message

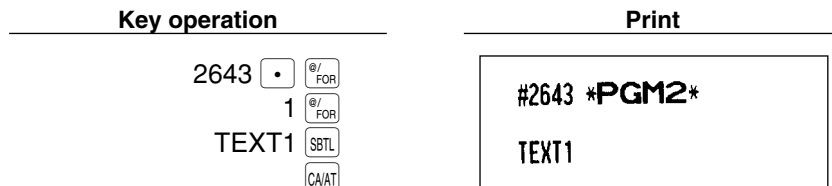

Note The SLIP key must be placed on the keyboard.

■ RS-232C channel assignment PGM 2 2690

Your register is equipped with two RS-232C interfaces. If you use the communication functions, the channel number of each RS-232C interface must be programmed by using the following procedure.
To activate the communication functions, please consult your dealer.

Procedure

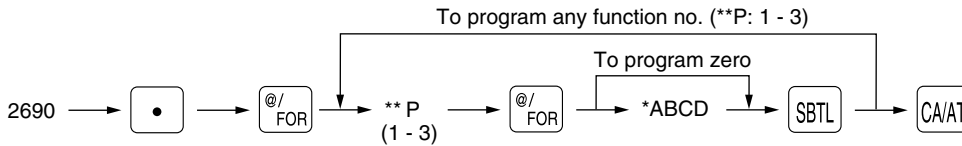

** P: 1

* Item:	Selection:	Entry:
A Channel no. for the ON-LINE communication or sending the print data	Not connected	0
	Standard channel 1	1
	Standard channel 2	2
B Always enter 0.		0
C Channel no. for the scale	Not connected	0
	Standard channel 1	1
	Standard channel 2	2
D Channel no. for the coin dispenser	Not connected	0
	Standard channel 1	1
	Standard channel 2	2

** P: 2

* Item:	Selection:	Entry:
A Channel no. for the barcode reader	Not connected	0
	Standard channel 1	1
	Standard channel 2	2
B Channel no. for the remote printer 1	Not connected	0
	Standard channel 1	1
	Standard channel 2	2
C Channel no. for the remote printer 2	Not connected	0
	Standard channel 1	1
	Standard channel 2	2
D Always enter 0.		0

Note For the barcode reader, when you use the model ER-A6HS1, always select the standard channel 1.

** P: 3

* Item:	Selection:	Entry:
A Always enter 0.		0
B Channel no. for the slip printer	Not connected	0
	Standard channel 1	1
	Standard channel 2	2
C Always enter 0.		0
D Channel no. for CAT	Not connected	0
	Standard channel 1	1
	Standard channel 2	2

Note

- Never enter any number other than 0, 1 and 2.
- The data backup function always uses standard channel 1.

Example

Assigning channel 1 to the slip printer

Key operation

2690 [•] [@/FOR]
 3 [3] [0100] [SBTL]
 [CA/AT]

Print

#2690 *PGM2*
 3 0100

Barcode reader programming

PGM 2

2691

Procedure

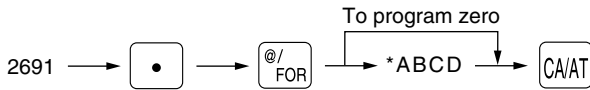

* Item:	Selection:	Entry:	
A Data bit	7 bits	1	
	8 bits	0	
	B Parity bit	Non parity	2
	Odd parity	1	
	Even parity	0	
	C Stop bit	1 bit	1
	2 bits	0	
	D Transmission speed	19200 bps	2
	9600 bps	1	
	4800 bps	0	

Example

Key operation

2691 [•] [@/FOR]
 1110 [CA/AT]

Print

#2691 *PGM2*
 1110 — ABCD

Remote printer programming PGM 2 2692

Procedure

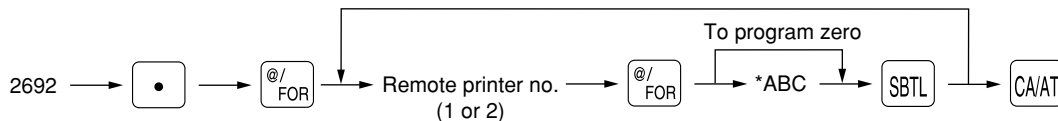

* Item:	Selection:	Entry:
A Logo text printing	Not print	0
	Print	1
B Auto cutter function	Disable	0
	Enable	1
C Type of the printer	TM-U200	0
	TM-U230	1
	TM-T88(3)	2
	TM-T88(3)+Logo	3

Example

Key operation

2692
 1 100

Print

```
#2692 *PGM2*
      1           100
```

Second remote printer programming PGM 2 3653

Procedure

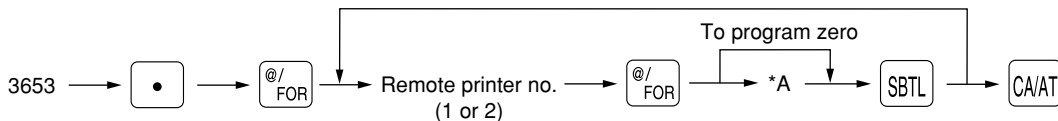

* Item:	Selection:	Entry:
A Second remote printer	Nothing	0
	Remote printer 1	1
	Remote printer 2	2

Example

Key operation

3653
 1 2

Print

```
#3653 *PGM2*
      KP1           00000
                        KP-2
```

Remote printer name programming PGM 2 3654

Procedure

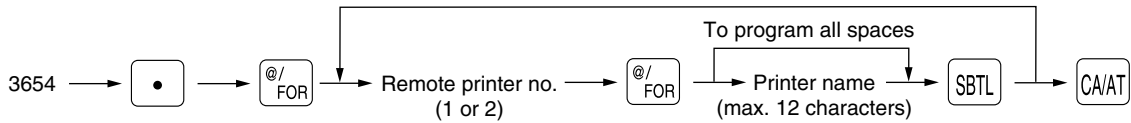

Example

Key operation

3654 **.** **@/FOR**
 1 **@/FOR** KP1 **SBTL**
CA/AT

Print

```
#3654 *PGM2*
KP1 KP1      00000
                KP-2
```

Printer name

Print format for remote printer PGM 2 3655

Procedure

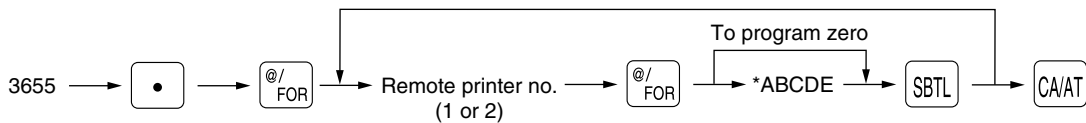

* Item:	Selection:	Entry:
A Taxable status print	Not print	0
	Print	1
B Q'ty print when q'ty is "1".	Not print	0
	Print	1
C Dept./PLU/UPC code print	Not print	0
	Print	1
D Unit price print	Not print	0
	Print	1
E Amount print	Not print	0
	Print	1

Example

Key operation

3655 **.** **@/FOR**
 1 **@/FOR** 00000 **SBTL**
CA/AT

Print

```
#3655 *PGM2*
KP1 KP1      00000
                KP-2
```

ABCDE

Chit receipt format PGM 2 3656

Procedure

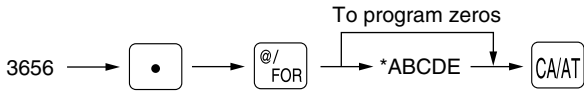

* Item:	Selection:	Entry:
A Taxable status print	Not print	0
	Print	1
B Q'ty print when q'ty is "1".	Not print	0
	Print	1
C Dept./PLU/UPC code print	Not print	0
	Print	1
D Unit price print	Not print	0
	Print	1
E Amount print	Not print	0
	Print	1

Example

Key operation	Print
3656 . @/ FOR 00000 CA/AT	<pre> #3656 *PGM2* CHIT FORMAT 00000 </pre>

6220

Online terminal number

Procedure

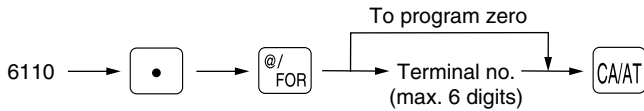

Transmission line form system

Procedure

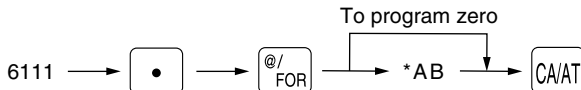

* Item:	Selection:	Entry:
A Sensing of the CI signal	No	0
	Sensing	1
B Line form	Full duplex system	0
	Half duplex system	1

Functional programming

Procedure



* Item:	Selection:	Entry:
A Selection of print data send/data download and upload	Data download and upload	0
	Print data send	1
B Baud rate (38400/19200/9600/4800 bps) The selected baud rate is used for on-line communications and print data sending. It is not used for the data backup function.	4800 bps	4
	9600 bps	5
	19200 bps	6
	38400 bps	7

Start code and end code

Procedure

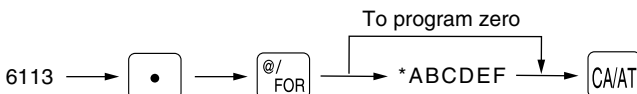

* ABC: Start code (000 – 127)
DEF: End code (000 – 127)

Time out setting

Procedure

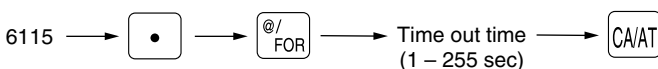

Programming for print data sending

Procedure



* Item:	Selection:	Entry:
A Sensing of DR signal	Yes	0
	No	1
B Sensing of CS signal	Yes	0
	No	1
C Sending of all print data	Disable	0
	Enable	1

■ Programming the CAT interface PGM 2 7110 7111 7112 7113 7114 7115

Phone number for dial out

Procedure

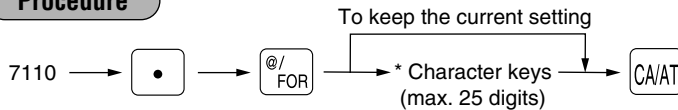

* The valid characters for dialing are "0 – 9", "W" and ",".

Password for dial out

Procedure

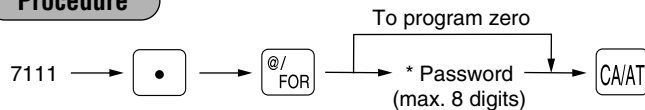

* The password can be programmed with zero suppression, however it is used without zero suppression (00000000 - 99999999) for dialing.

Functional programming

Procedure

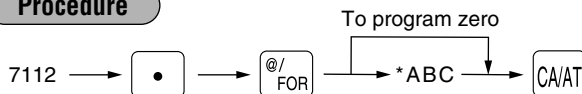

* Item:	Selection:	Entry:
A PIN PAD on CAT for DEBIT CARD	Yes	0
	No	1
B Key type for PIN PAD	STATIC	0
	DUKPT	1
	INDEX	2
C Dial mode for dial out	Tone	0
	Pulse	1

Time out setting for time 1 (reading the card)

Procedure

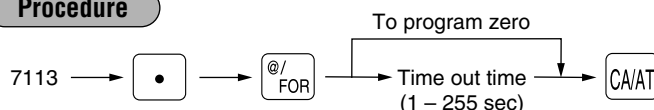

Time out setting for time 2 (response of authorization)

Procedure

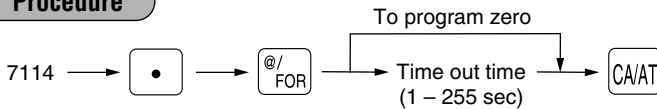

Time out setting for time 3 (reading of dial in/out)

Procedure

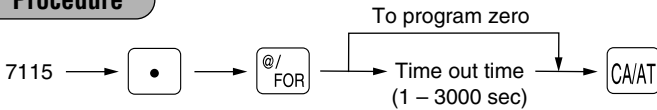

■ Secret codes to control access to the PGM1 mode, X1/Z1 mode and X2/Z2 mode

PGM 2 2630 2631 2632

When a secret code has been set for that specific mode operation, before performing any PGM1 mode, X1/Z1 mode or X2/Z2 mode operation, you must enter a secret code according to the following procedure.

Operating

Procedure

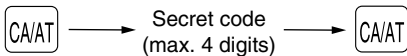

Note

Once a secret code is entered, it does not need to be entered again unless the mode switch setting is changed or an operation is performed.

Programming

Procedure

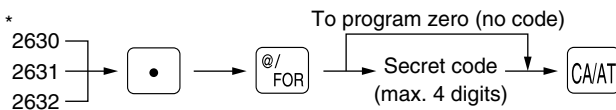

- * 2630 for the PGM1 mode
- 2631 for the X1/Z1 mode
- 2632 for the X2/Z2 mode

Example

Programming secret code 1234 for X1/Z1 mode

Key operation

2631 @/ FOR
1234 CA/AT

Print

#2631 *PGM2*

1234

■ Setting the AUTO key — Automatic sequencing key — X2/Z2 2900

If you program frequently performed transactions or report sequences for the AUTO keys, you can enter those transactions simply by pressing the corresponding AUTO keys during key operations. This programming can be done when your machine is in the X2/Z2 mode.

Procedure

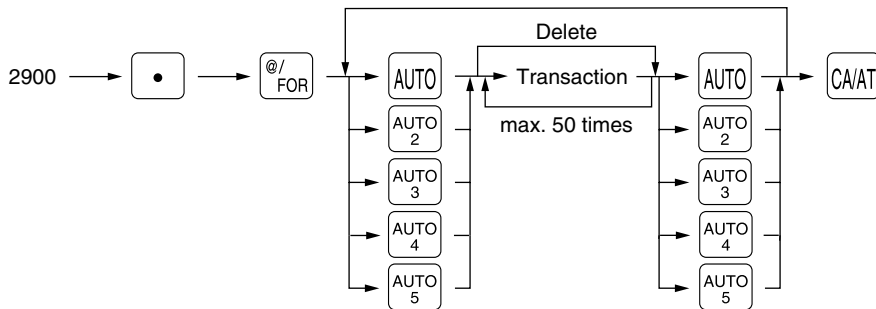

Example

Programming for the **AUTO** key and **AUTO₂** key as follows:

AUTO; entering a \$1.50 item (PLU2) and a \$1.00 item (dept. 3)

AUTO₂; selling a \$5.00 -programmed- item (dept. 2) for cash

Key operation	Print
2900 • @/FOR AUTO AUTO1 setting → 2 PLU/UPC 100 3 AUTO AUTO ₂ AUTO2 setting → 2 CA/AT AUTO AUTO ₂ CA/AT	<pre> #2900 *PGM2* #1 2 KEY PLU/UPC 1 KEY 0 KEY 0 KEY #2 L1 D03 L1 D02 CA/AT </pre>

Note

- When the AUTO key has been programmed to execute a report job function etc., the mode switch must be in the corresponding position.
- The AUTO sequence key can not be preset to another AUTO sequence key.

11 TRAINING mode

The training mode is used when the operator or the manager practices register operations.

When a training cashier has been selected, the machine automatically enters the training mode. When a training cashier has not been selected, the register automatically enters the ordinary REG mode. (For programming of a training cashier, please consult your local dealer.)

The training operations are valid only in REG, MGR, and VOID mode.

The training cashier memory is updated in the training mode. Other memories are not updated.

Example

Key operation

1000
3

Print

```
08/31/2004 8:38PM 1014
123456#5016 PETER

**TRAINING**
DPT.01 T1 $10.00
          3 @ $1.50
DPT.02 T1 $4.50
MDSE ST $14.50
TAX1 $0.87

CASH $15.37
```

12 Reading stored programs

Your machine allows you to read every program stored in the PGM1 and PGM2 modes.

Program details and procedures for their reading

Program for:	Mode switch position	Job code no.	Procedure	Related job code nos.
1 Departments	PGM2 or PGM1	1100		1110, 2110, 2111, 2112, 2114, 2115, 2116, 2180, 2118
2 PLUs/UPCs	PGM2 or PGM1	1200		1200, 1210, 1211, 2210, 2211, 2214, 2215, 2230, 2231, 2232, 2235, 2236, 2280, 2218
3 Key nos. for departments and PLUs	PGM2	2119		2119, 2219
4 Link PLUs/UPC link	PGM2	2220		2220
5 Set PLUs	PGM2	2221		2221
6 Mix-and-match table	PGM2	2225		2217, 2225
7 UPC's function	PGM2	2025		2025, 2029
8 Cashiers	PGM2 or PGM1	1500		1500, 1514, 2510
9 PBLU code	PGM2	2800		2810

Program for:		Mode switch position	Job code no.	Procedure	Related job code nos.
10	Function preset 1	PGM2 or PGM1	1300	→ 1300 → @/FOR → CAIAT	1310, 2310, 2311, 2312, 2313, 2314, 2315, 2316, 2320, 2321, 2322, 2326, 2334, 2328
11	Function preset 2	PGM2	2600	→ 2600 → @/FOR → CAIAT	2614, 2615, 2616, 2617, 2618, 2619, 2620, 2630, 2631, 2632, 2689, 2690, 2691, 2692
12	Messages	PGM2	2640	→ 2640 → @/FOR → CAIAT	2641, 2642, 2643
13	Tax tables and rates	PGM2 or PGM1	2700	→ 2700 → @/FOR → CAIAT	2710, 2711, 2715
14	Auto keys	PGM2	2900	→ 2900 → @/FOR → CAIAT	2900
15	Thermal printer	PGM2	2990	→ 2990 → @/FOR → CAIAT	2990
16	Remote printer	PGM2	3650	→ 3650 → @/FOR → CAIAT	3653, 3654, 3655, 3656
17	On-line preset	PGM2 or PGM1	6110	→ 6110 → @/FOR → CAIAT	6110, 6111, 6112, 6113, 6115, 6220
18	CAT preset	PGM2	7110	→ 7110 → @/FOR → CAIAT	7110, 7111, 7112, 7113, 7114, 7115

Sample printouts

1 Reading of programmed items for departments (Reading in the PGM1 and PGM2 modes)

08/26/2004 10:59PM
123456#1114

Job code no. #1100 *PGM2* Mode switch position*

Range 01-20

Dept. code D01 10.00 Unit price

Item label STEAK G01 Group no.

000003 KP000 A00 C1L95

D02 0.00

DPT. 02 G02

000001 KP000 A18 COL17

D03 0.00 HALO limit.

DPT. 03 G00

000003 KP000 A00 COL17 Commission group

D04 FT1 0.00 Function programming

DPT. 04 G00

000001 KP000 A00 COL17

Print station

Tax status

D09 T1 0.00

DPT. 09 G00

000001 KP101 A00 COL17

D10 -0.00

DPT. 10 G00

000001 KP000 A00 COL17

D11 0.00

Age limitation

D20 0.00

DPT. 20 G00

000001 KP000 A00 COL17

2 Reading of programmed items for PLUs/UPCs (Reading in the PGM1 and PGM2 modes)

08/26/2004 11:03PM
123456#1116

#1200 *PGM2* Mode switch position*

00001- Range

00020

PLU code P00001 (02) /00

Tax status T1 KP000 1.25 Unit price (level 1)

Item label MILK C1M01 0.00 Unit price (level 2)

1003 A00 S 0.00 Associated dept. code

P00002 (01) /12 Base q'ty

F KP000 0.00

1003 Type of unit price entry

PLU00002 COM00 0.00 Scale entry

1002 A18 S 12.500 Tare table no.

P00003 (01) /00 Delete method

KP000 0.00

PLU00003 COM00 Commission group and mix-and-match table no.

1002 A00 S 0.000

P00004 (01) /00

KP000 0.00 Age limitation

Link PLU

P00018 (03) L/00

T1 KP000 0.00

Print station

PLU00018 C1M00

1003 A18 S 0.000

P00019 (03) /00

T1 KP000 0.00

PLU00019 C1M00

1003 A18 S 0.000

P00020 (03) S/00 Set PLU

T1 KP000 0.00

PLU00020 C1M00

1003 A18 S 0.000

* When you take this report in the PGM1 mode, the PGM2 indication is replaced by "PGM1".

**3 Reading of programmed key nos. for departments and PLUs
(Reading in the PGM2 mode)**

08/26/2004 11:08PM 123456#1117		
#2119 *PGM2*		
001	L1	D01
002	L1	D02
003	L1	D03
004	L1	D04
005	L1	D05
006	L1	D06
007	L1	D07
008	L1	D08
009	L1	D09
010	L1	D10
011	L1	D11
012	L1	D12
013	L1	D13
014	L1	D14
015	L1	D15
016	L1	D16
017	L1	D17
018	L1	D18
019	L1	D19
020	L1	D20
021	L1	P00001
	L2	P00065
	L3	----
022	L1	P00002
	L2	----
	L3	----
023	L1	P00003
	L2	----
	L3	----
024	L1	P00004
	L2	----
	L3	----
025	L1	P00005
	L2	----
	L3	----

119	L1	----
	L2	----
	L3	----

**4 Reading of programmed items for link PLUs
(Reading in the PGM2 mode)**

08/26/2004 11:11PM 123456#1120	
#2220 *PGM2*	
00001-	999999
P00018	LP00015
	P00016
	P00017
P00021	LP00025
	P00026
	P00027

**5 Reading of programmed set PLUs
(Reading in the PGM2 mode)**

08/26/2004 11:12PM 123456#1121	
#2221 *PGM2*	
P00020	00001- 99999
	SP00201
	P00202

**6 Reading of mix-and-match table
(Reading in the PGM2 mode)**

08/26/2004 11:14PM 123456#1122			
#2225 *PGM2*			
#01	/03	5.00	Mix-and-match table no.
#02	/00	0.00	Adjustment amount
#03	/00	0.00	
#04	/00	0.00	Matching count
#05	/00	0.00	
#06	/00	0.00	
#07	/00	0.00	
#08	/00	0.00	
#09	/00	0.00	
#10	/00	0.00	

**8 Reading of programmed items for cashiers
(Reading in the PGM1 and PGM2 modes)**

08/26/2004 11:26PM 123456#1125			
#1500 *PGM2*			Mode switch position*
Cashier name	01CSR# DICK	1111	Cashier code
Cashier no.	02CSR#	D1	Drawer no.
	03CSR#	0002	
	04CSR# PETER	D1	
		0003	
		D1	
		1014	
		D1	
	20CSR#	0020	
		D1	

* When you take this report in the PGM1 mode, the PGM2 indication is replaced by "PGM1".

**7 Reading of programmed UPC's function
(Reading in the PGM2 mode)**

08/26/2004 11:15PM 123456#1123			
#2025 *PGM2*			
#2025			
2	2 4 0 0 0 2	Non-PLU code format	
02	5 4 0 0 1 2		
20	5 4 0 0 1 2		
#2029	60	Delete period for non-accessed UPC	

**9 Reading of programmed PBLU code
(Reading in the PGM2 modes)**

08/26/2004 11:29PM 123456#1126	
#2800 *PGM2*	
#2810	0001-1000

10 Reading of programmed items for functions - 1
 (Reading in the PGM1 and PGM2 modes)

```

08/26/2004 11:33PM
123456#1130

#1300 *PGM2*

F001 (-) 1
S                -10.00
                  L13

F002 (-) 2
I                -0.00
                  L17

F003 (-) 3
S                -0.00
                  L17

F004 (-) 4
S                -0.00
                  L17

F005 %1
S      3        -10.25%
      T1        L100.00%

F006 %2
I      2         0.00%
      L 15.50%

F007 %3
S      3        -0.00%
      L100.00%

F008 %4
S      3        -0.00%
      L100.00%

F009 NET 1
F010 TAX1 ST
F011 GRS TAX1
F012 RFD TAX1
F013 TAX1
F014 TX1 EXPT
F015 TAX2 ST
F016 GRS TAX2
F017 RFD TAX2
F018 TAX2
F019 TX2 EXPT
F020 TAX3 ST
F021 GRS TAX3
F022 RFD TAX3
F023 TAX3
F024 TX3 EXPT
F025 TAX4 ST
F026 GRS TAX4
F027 RFD TAX4
F028 TAX4
F029 TX4 EXPT
F030 GRS MTAX
F031 RFD MTAX
F032 M-TAX                L17
  
```

```

F033 GST EXPT
F034 PST TTL
F035 GST TTL
F036 FS TX1
F037 FS TX2
F038 FS TX3
F039 TTL TAX
F040 NET
F041 NET2
F042 CP PLU
F043 VOID
F044 SBTL VD
F045 MGR VD
F046 VOID
F047 REFUND
F048 HASH VD
F049 HASH RF
F050 NO SALE
F051 VP CNT
F052 BILL CNT
F053 DRW CNT
F054 TRAY TL
F055 ***PBAL
F056 SERVICE KP000
      0000000000000000

F057 DEPOSIT
F058 DPST RF
F059 TRANS CT
F060 NET3
F061 CASH KP000 L18
      0000 0000000000000000
F062 CASH2 KP000 L18
      0000 0000000000000000
F063 FSSALE KP000
      0000000000000000

F064 ***RA L18
F065 ***RA2 L18
F066 ***PO L18
F067 ***PO2 L18
F068 CA/CHK
      99.99

F069 CHK/CG
      999999.99

F070 FS/CG
F071 CONV 1
      1.3250
F072 CONV 2 US$
      0.0000
F073 CONV 3
      0.0000

F074 CONV 4
F075 FS/ID
  
```

```

F076 CHARGE1 KP000 L18
      0000 0000000000000000
F077 CHARGE1-
F078 CHARGE2 KP000 L18
      0000 0000000000000000
F079 CHARGE2-
F080 VISA KP101 L15
      0001 0000000000000001
F081 CHARGE3-
F082 CHARGE4 KP000 L18
      0000 0000000000000000
F083 CHARGE4-
F084 CHARGE5 KP000 L18
      0000 0000000000000000
F085 CHARGE5-
F086 CHECK1 KP000 L18
      0000 0000000000000000
F087 CHECK2 KP000 L18
      0000 0000000000000000
F088 CA/CH ID
F089 ***CID
      9999999.99

F090 VAT EXPT
F091 AVE.
F092 GROUP01
F093 GROUP02
F094 GROUP03
F095 GROUP04
F096 GROUP05
F097 GROUP06
F098 GROUP07
F099 GROUP08
F100 GROUP09
F101 LEVEL 1
F102 LEVEL 2
F103 *DEPT TL
F104 DEPT (-)
F105 *HASH TL
F106 HASH (-)
F107 *BTTL TL
F108 BTTL (-)
F109 COM. SAL1
      0.00%

F110 COM. SAL2
      0.00%
F111 COM. SAL3
      0.00%
F112 COM. SAL4
      0.00%
F113 COM. SAL5
      0.00%
F114 COM. SAL6
      0.00%
F115 COM. SAL7
      0.00%
  
```

* When you take this report in the PGM1 mode, the PGM2 indication is replaced by "PGM1".

To be continued on the next page

11 Reading of programmed items for functions - 2
(Reading in the PGM2 mode)

```

F116 COM. SAL8          0.00%
F117 COM. SAL9          0.00%

F118 NON COM.
F119 COM. AMT1
F120 COM. AMT2
F121 COM. AMT3
F122 COM. AMT4
F123 COM. AMT5
F124 COM. AMT6
F125 COM. AMT7
F126 COM. AMT8
F127 COM. AMT9
F128 COM. TTL
F129 CA/CH IS
F130 CONV1 IS
F131 CONV2 IS
F132 CONV3 IS
F133 CCD DIF.
F134 DIF. TL
F135 SUBTOTAL
F136 MDSE ST
F137 ***TOTAL
F138 CHANGE
F139 FS ST
F140 FS TEND
F141 FS CG
F142 ITEMS
F143 DEPT
F144 GROUP
F145 PLU/UPC
F146 STOCK
F147 ZERO SAL
F148 CATEGORY
F149 TRANS.
F150 CID
F151 SALES
F152 CCD
F153 CASHIER
F154 HOURLY
F155 DAILY
F156 PBLU
F157 #
F158 COPY
F159 FINAL KP000
      0000000000000000

F160 BALANCE
F161 SLIP PR.
F162 NEXT P.
F163 BAL FWD
F164 TARE WT.
F165 DUE
F166 TAX ST
F167 AMOUNT
F168 WEIGHT
F169 RF SALE
F170 V. CP UPC
F171 NO ACCES
F172 PR. CHNG
    
```

```

08/26/2004 11:39PM
123456#1131

#2600 *PGM2*

#2614 _____ Logo message
      YOUR
      STORE
      MESSAGE

#2615      00 99 1 0
#2616 _____ Line feed for tray subtotal
      01      00000000
      02      00000000
      03      00000010
      04      00000000
      05      00000000
      06      00000000
      07      00000000
      08      00000000
      09      00000000
      10      00000000
      11      00000000
      12      00000000
      13      00000000
#2617      030 _____ Drawer open alarm time
#2618
      1      0.20
      2      0.00
      3      0.00
      4      0.00
      5      0.00
      6      0.00
      7      0.00
      8      0.00
      9      0.00
#2619      1 07 _____ Hourly report format/start
#2620      10 _____ hour
      13 _____ Stacked report
#2630      0000
#2631      1234 _____ Secret code
#2632      0000
#2689      0 030 _____ Power saving mode
#2690
      1      0000
      2      0000
      3      0100
#2691      1110 _____ Barcode reader data
#2692
      1      100
      2      000 _____ Remote printer data
    
```

12 Reading of programmed messages
(Reading in the PGM2 mode)

```

08/26/2004 11:45PM
123456#1135

#2640 *PGM2*

#2641
01      ENTRY ERROR
02      MISOPERATION
03      NO RECORD
04
05      SECRET CODE
06      NOT FREE
07      MEMORY FULL
08      INSERT SLIP
09      NO AUTHORITY
10      OUT OF STOCK
11      SBTL COMPUL.
12      TEND COMPUL.
13      PB COMPUL.
14
15
16
17
18
19
20      OFF LINE
21
22      CASHIER ERR.
23
24
25
26
27      POWER OFF
28
29
30
31      # COMPULSORY
32      NOT ASSIGNED
33
34      OVER LIMIT.
35      INH. OPEN PR
36      INH. UNIT PR
37      NOT NON-TEND
38      SCALE ERROR
39
40
41
42
43
44
45
46
47
48
49
    
```

— Error messages

```

50
51      WEIGHT
52
53
54      ENTR TARE WT
55
56
57
58
59
60
61      NO RECORD
62      PRICE → DEPT
63      PRICE & DEPT
64      ENTER DEPT#
65
66
67      BUFFER FULL
68
69
70      ENTER PRICE
71
72
73
74      DELETE
75
76      CLOSE DRAWER
77
78
79      OP ENTER
80
81      ENTR SECRET#
82
83
84      SEND OK
85      RECEIVE OK
86      COM. ERROR
87      DATA ERROR
88      TIME OUT
89
90
91
92
93
94      AGE ERROR
95
96
97
98
99
#2642 —————
FOR DEPOSIT ONLY
#2643 —————
TEXT1
    
```

— Check validation message

— Slip printer's logo message

To be continued

**13 Reading of programmed tax tables and rates
(Reading in the PGM2 mode)**

```

08/26/2004 11:53PM
123456#1143

#2700 *PGM2*

TAX1          6.0000%
              / 1.00
              1    0.11
              2    0.23
              3    0.39
              4    0.57
              5    0.73
              6    0.89
              7    1.11

TAX2          4.0000%
              0.12

TAX3          5.0000%
              0.20
    
```

Tax rate

Tax table

Tax rate

Lowest taxable amount

**15 Reading of programmed items for the thermal printer
(Reading in the PGM2 mode)**

```

08/26/2004 11:54PM
123456#1146

#2990 *PGM2*

                    50

10 : 0123456789ABCDEF
20 : 0123456789ABCDEF
30 : 0123456789ABCDEF
40 : 0123456789ABCDEF
50 : 0123456789ABCDEF
60 : 0123456789ABCDEF
70 : 0123456789ABCDEF
80 : 0123456789ABCDEF
90 : 0123456789ABCDEF
    
```

Printing density

Entered Value

Printing density example

**14 Reading of programmed items
for auto keys
(Reading in the PGM2 mode)**

```

08/26/2004 11:54PM
123456#1145

#2900 *PGM2*

#1
      2 KEY
      PLU/UPC
      1 KEY
      0 KEY
      0 KEY

L1    D03

#2
      L1
      D02
      CA/AT

#3
      ----

#4
      ----

#5
      ----
    
```

**16 Reading of remote printer preset
(Reading in the PGM2 mode)**

```

08/26/2004 11:55PM
123456#1148

#3650 *PGM2*

KP1 KP1          00000
                  KP-2
KP2              00000
                  KP-0
CHIT FORMAT      00000
    
```

**17 Reading of ON-LINE preset
(Reading in the PGM2 mode)**

```

08/26/2004 11:55PM
123456#1149

#6110 *PGM2*

#6110
TERMINAL NO.    000001
#6111
MODEM CONTROL   00
#6112
TYPE            0
BPS             6
#6113
START CODE     002
END CODE       013
#6115
TIME OUT       007
#6220
PROGRAM        000
    
```

**18 Reading of CAT preset
(Reading in the PGM2 mode)**

```

08/26/2004 11:55PM
123456#1150

#7110 *PGM2*

#7110
TEL NO. 0

#7111
PASSWORD      00000000
#7112
FUNC. SELECT   000
#7113
TIME OUT1     030
#7114
TIME OUT2     099
#7115
TIME OUT3     0099
    
```

13 Universal Product Code (UPC) or European Article Number (EAN)

■ UPC or EAN code

Your machine can support the following codes:

- UPC-A (Number system character: 0, 2, 3, 4) • UPC-E
- EAN-8 • EAN-13 • Internal code EAN-8/EAN-13

For the codes used in-store marking, there are two types of PLU type (treated as a code like PLU no.) and Non-PLU type (price/quantity information is included in the code).

When a code is non-PLU type, the price/quantity in the code is read for sales entry (in case of quantity, "quantity multiplies preset unit price" is processed to obtain price.)

UPC-A

- Number system character: 0 <used in the source marking>
- Number system character: 3 <used as NDC or HRI>

For entry, a full 12 digit number or 11 digit number (omitting the check digits) must be entered.

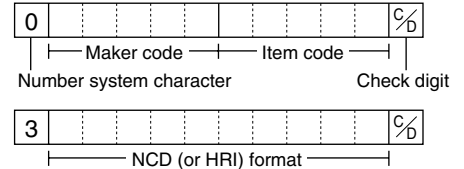

- Number system character: 2 <In-store marking Non-PLU type>
You can program the format by the job #2025.
- Number system character: 4 <In-store marking PLU type>

For entry, a full 12 digit number, 11 digit number (omitting the check digit), or a leading zero plus 12 digit number must be entered. (Any numbers are allowed for the digits marked with *, and on the receipt/journal, non-PLU type code is printed like 202008**** (****: price information).)

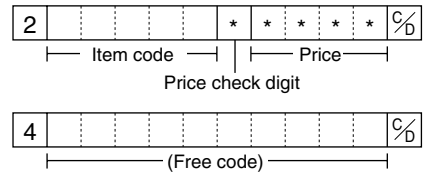

UPC-E

- UPC-E is a zero-suppressed version of UPC-A that conforms to the UPC-E Standards. This code is used for marking small packages.

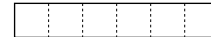

For entry, a 6 digit number or a leading zero plus 6 digits number must be entered.

EAN 8

- Ordinary EAN-8 code (flag: neither 0 nor 2) <used in the source marking>

For entry, a full 8 digit number must be entered.

- Internal code (flag 2) <in-store marking non-PLU short type>
Program the format by the job #2025.
- Internal code (flag 0) <in-store marking PLU short type>

For entry, a full 8 digit number must be entered. On the receipt/journal, non-PLU type code is printed like 208**** (****: price/quantity information)

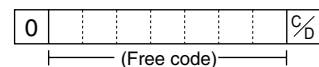
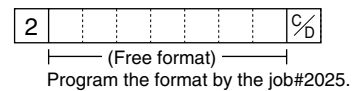
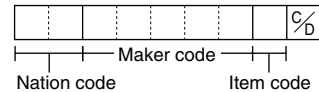

EAN-13

- Ordinary EAN-13 code (used in the source marking)
- Specific EAN-13 code (flag 977, 978, 979) (used in the source marking: ISBM, ISSN)

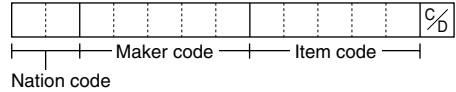

For entry, you must enter a full of 13 digits number.

- Internal code (used in the in-store marking, the flag character number: 20 through 29 and 02)
Program the format by the job# 2025.

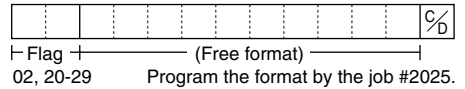

■ Add-on code

UPC-A and EAN-13 may be followed by a two digits number or a five digits number as add-on code, excepting UPC-A without a check digit plus two or five digits add-on code.

Therefore, the total number of digits enterable for sales entries are as shown below:

Code entry	No add-on code	2-digit add-on code	5-digit add-on code
UPC-A	12	14	17
UPC-A w/leading zero	13	15	18
UPC-A w/o check digit	11	–	–
UPC-E	6	–	–
EAN-8	8	–	–
EAN-13	13	15	18

Note

Your register automatically judges the add-on code in an UPC/EAN code entered from the total number of digits and the flag.

READING (X) AND RESETTING (Z) OF SALES TOTALS

- Use the reading function (X) when you need to take a reading of sales information entered since the last resetting. You can take this reading any number of times. It does not affect the register's memory.
- Use the resetting function (Z) when you need to clear the register's memory. Resetting prints all sales information and clears the entire memory except for the GT1 thru GT3 and training GT, reset count, and consecutive number.
- If you want to stop the printing report, turn the mode switch to the MGR position. The symbol ("*****") is printed.

1 Summary of reading (X) and resetting (Z) reports and the key operations to obtain the reports

X1 and Z1 reports: Daily sales reports

X2 and Z2 reports: Periodic (monthly) consolidation reports

Item	Mode switch position		Job code	Key operation
	X1/Z1	X2/Z2		
Flash report: (Only display) To clear the display, press the CL key or turn the mode switch to another position.	X1	—	—	Dept. key (1 to 99) Dept. code → DEPT # : Department total amount
				@/FOR key: Amount of cash in drawer
				SBTL key: Paid total
General report	X1, Z1	X1, Z1	100	100 → Reading → @/FOR → CAIAT 200 → Resetting
		X2, Z2	200	
Individual cashier report	X1, Z1	X1, Z1	151	151 → Reading → @/FOR → CAIAT 251 → Resetting → For assigned cashier → Cashier code → CAIAT
				X2, Z2
		<OP X/Z>	X, Z	51
Full cashier report	X1, Z1	X1, Z1	150	150 → Reading → @/FOR → CAIAT 250 → Resetting
			X2, Z2	250
Full department report	X1	X1	110	110 → @/FOR → CAIAT
			X2	210
Individual group total report on department	X1	X1	112	112 → @/FOR → Group number → CAIAT
			X2	212
Full group total report on department	X1	X1	113	113 → @/FOR → CAIAT
			X2	213
PLU/UPC report by designated range	X1, Z1	X1, Z1	120	120 → Reading → @/FOR → CAIAT 220 → Resetting
			X2, Z2	220

Item	Mode switch position		Job code	Key operation
	X1/Z1	X2/Z2		
PLU/UPC report by pick up list	X1, Z1	X1, Z1	109	
		X2, Z2	209	
PLU/UPC report by associated department	X1, Z1	X1, Z1	121	
		X2, Z2	221	
PLU/UPC zero sales report	X1, Z1	X1, Z1	127	
		X2	227	
PLU/UPC price category report	X1	X1	129	
		X2	229	
PLU/UPC stock report		X1	124	
PLU/UPC stock report by pick up list		X1	104	
PBLU report		X1, Z1	180	
PBLU report by cashier		X1, Z1	181	
Commission sales report	X1	X1	132	
		X2	232	

Item	Mode switch position		Job code	Key operation
	X1/Z1	X2/Z2		
Transaction report	X1	X1	130	130 → [@/ FOR] → [CA/AT] 230
		X2	230	
Cash in drawer report	X1	X1	131	131 → [@/ FOR] → [CA/AT] 231
		X2	231	
Hourly report	X1		160	<p>Reading: (For individual time range)</p> <p>* Enter the time in the 24-hour system.</p> <p>Reading and Resetting: 160 → [Reading / Resetting] → [@/ FOR] → [CA/AT]</p>
		X1, Z1		
Stacked report	X1, Z1	X1, Z1	190	<p>When Z of stacked report is initiated, X only reports will be skipped.</p>
		X2, Z2	290	
Daily net report		X2, Z2	270	

Non-accessed UPC deleting

Item	Mode switch position		Job code	Key operation
	X1/Z1	X2/Z2		
Reading of non-accessed UPCs	X1		105	105 → [@/ FOR] → [CA/AT]
Deleting of non-accessed UPCs		Z1	105	

Note When you execute the job #105 in Z1 mode, not only the sales data, but also the UPC code(s) (the related data files) themselves will be deleted.

2 Daily sales totals

General report

You can take X and Z reports in the X1/Z1 mode. The use of the decimal (\square) key determines when the report will actually reset the totals.

• Sample X report

08/27/2004 6:45PM 1111 123456#1658 DICK	Report no.
#100 *X1*	Read symbol
GT1 \$00000118275.95	
GT2 \$00000118688.60	
GT3 -00000000412.65	
TR \$00000000173.98	
DEPT	Dept. code
D01 475.000 Q	Sales q'ty
DPT. 01 \$2501.95	Sales amount
18.34%	Ratio of dept. 1 sales amount to "+" real dept. total
D02 338.000 Q	
DPT. 02 \$1981.78	
14.52%	

D20 6.000 Q	
DPT. 20 \$83.49	
0.61%	
*DEPT TL 1910.000 Q	"+" real dept. counter and total
\$13643.69	
100.00%	
D11 2.000 Q	
DPT. 11 -12.24	
DEPT (-) 2.000 Q	"-" real dept. counter and total
-12.24	
D12 4.000 Q	
DPT. 12 \$8.52	
*HASH TL 4.000 Q	"+" hash dept. counter and total
\$8.52	
D13 3.000 Q	
DPT. 13 -2.65	
HASH (-) 3.000 Q	"-" hash dept. counter and total
-2.65	

To be continued on the next page

• Sample Z report

08/27/2004 8:12PM 1111 123456#1780 DICK	Report no.
#100 *Z1*	Read symbol
Z1 0015	Reset symbol
GT1 \$00000118559.63	Reset counter
GT2 \$00000118972.28	Net grand total (GT2 - GT3)
GT3 -00000000412.65	Grand total of plus registration
TR \$00000000173.98	Grand total of minus registration
	Grand total of training mode registration

The subsequent printout occurs in the same format as in the X report.

Note

Not all reports provide the resetting capability. Please refer to the chart on pages 157–159.

D14	15.000 Q				
DPT. 14		\$11.25			
*BTTL TL	15.000 Q			} "+" bottle return dept. counter and total	
		\$11.25			
D15	7.000 Q				
DPT. 15		-5.95			
BTTL (-)	7.000 Q			} "-" bottle return dept. counter and total	
		-5.95			
* TRANS. *					
(-) 1	2 Q			} ⊖1 counter and total	
		-2.78			
(-) 2	1 Q			} ⊖2 counter and total	
		-1.75			
%1	2 Q			} Percent 1 counter and total	
		-12.31			
%2	1 Q			} Percent 2 counter and total	
		-5.29			
NET 1		\$13616.42		Net sales total	
				(When the Canadian tax system is selected)	
TAX1 ST	\$304.58		TAX1 ST	\$1601.14	} Tax 1
GRS TAX1	\$19.92		GRS TAX1	\$101.97	
RFD TAX1	-1.64		RFD TAX1	-5.88	
TAX1	\$18.28		TAX1	\$96.09	
TX1 EXPT	\$17.35		TX1 EXPT	\$24.64	} Tax 4
TAX2 ST	\$164.83		TAX2 ST	\$297.49	
GRS TAX2	\$7.63		GRS TAX2	\$12.11	
RFD TAX2	-1.05		RFD TAX2	-0.21	
TAX2	\$6.58		TAX2	\$11.90	} Manual tax
TX2 EXPT	\$23.75		TX2 EXPT	\$32.80	
TAX3 ST	\$172.15		TAX3 ST	\$799.94	
GRS TAX3	\$10.07		GRS TAX3	\$40.29	
RFD TAX3	-1.46		RFD TAX3	-0.29	} Exempt total from GST
TAX3	\$8.61		TAX3	\$40.00	
TX3 EXPT	\$46.10		TX3 EXPT	\$62.10	
GRS MTAX	\$2.87		TAX4 ST	\$67.30	
RFD MTAX	-1.12		GRS TAX4	\$4.79	} PST total
M-TAX	\$1.75		RFD TAX4	-0.74	
FS TX1	\$29.10		TAX4	\$4.05	
FS TX2	\$6.45		TX4 EXPT	\$26.10	
FS TX3	\$14.45		GRS MTAX	\$2.13	} GST total
			RFD MTAX	-1.50	
TTL TAX	\$35.22		M-TAX	\$0.63	
NET	\$13616.42		GST EXPT	\$187.60	
NET2	\$13651.64		PST TTL	\$9.07	
			GST TTL	\$4.05	

To be continued on the next page

(-) 3	2 Q	-2.22	⊖3 counter and total
(-) 4	2 Q	-3.57	⊖4 counter and total
%3	2 Q	-2.17	Percent 3 counter and total
%4	2 Q	-1.65	Percent 4 counter and total
CP PLU	2 Q	-4.33	Coupon-like PLU counter and total
V. CP UPC	3 Q	-1.80	Vender coupon UPC counter and total
VOID	4 Q	\$86.79	Item void counter and total
SBTL VD	1 Q	\$88.15	Subtotal void counter and total
MGR VD	1 Q	\$17.71	Manager item void counter and total
VOID	1 Q	\$17.71	Void-mode transaction counter and total
REFUND	4 Q	\$255.38	Refund counter and total
HASH VD	1 Q	\$15.30	Hash item void counter and total
HASH RF	1 Q	\$8.10	Hash item refund counter and total
NO SALE	5 Q		No-sale (exchange) counter
VP CNT	0 Q		Validation print counter
BILL CNT	0 Q		Bill counter
DRW CNT	8 Q		Drawer counter
TRAY TL	5 Q		Tray subtotal counter
***PBAL	1 Q		PBAL counter
SERVICE	3 Q		Service counter
TRANS CT	1187 Q		Customer counter
NET3		\$13657.51	Sales total (including hash dept. total)
CASH	1174 Q	\$12562.64	Cash counter and total
CASH2	3 Q	\$110.74	Cash 2 counter and total
FSSALE	3 Q	\$172.83	Sales for food stamp counter and total
***RA	3 Q	\$188.43	Received on account counter and total
***RA2	1 Q	\$80.00	Received on account 2 counter and total

***PO	1 Q	\$30.00	Paid out counter and total
***PO2	1 Q	\$20.00	Paid out 2 counter and total
CA/CHK	2 Q	\$87.00	Check cashing counter and total
CHK/CG		\$15.86	Cash change total for check and charge 1 - 5 tendering
FS/CG		\$0.50	Cash change total for food stamp tendering
CONV 1		30.00	Currency conversion 1 total (by programmed rate)
CONV 2		80.00	Currency conversion 2 total (by programmed rate)
CONV 3		100.00	Currency conversion 3 total (by programmed rate)
CONV 4		100.00	Currency conversion 4 total (by manual rate)
FS/ID		\$117.00	Food stamp in drawer total
CHARGE1	6 Q	\$87.98	Charge 1 sales and tendering counter
CHARGE1-	2 Q	-10.65	Charge 1 in drawer
CHARGE2	5 Q	\$125.59	Charge 1 refunds counter
CHARGE2-	2 Q	-9.48	Charge 1 refunds total
CHARGE3	5 Q	\$81.84	
CHARGE3-	1 Q	-7.20	
CHARGE4	4 Q	\$89.50	
CHARGE4-	1 Q	-5.18	
CHARGE5	4 Q	\$72.50	
CHARGE5-	1 Q	-6.12	
CHECK1	5 Q	\$233.95	Check sale and tendering counter
CHECK2	3 Q	\$133.40	Check in drawer
CA/CH ID		\$12983.00	Cash + check in drawer
****CID		\$12615.65	Cash in drawer
DEPOSIT	1 Q	\$30.00	Deposit counter and total
DPST RF	1 Q	-20.00	Deposit refund counter and total

■ Cashier report

Using this function, you can take X and Z reports for individual cashiers or all cashiers.

Individual cashier reading and resetting

Note

The OP X/Z-mode reading and resetting is allowed only when your machine has been programmed for "OP X/Z mode available" in the PGM2 mode.

• Sample X report

```

08/27/2004 6:46PM 1111
123456#1668      DICK

#151 *X1*
*CASHIER *

01CSR#1111 DICK
NET1          $12298.94
V.CP UPC      2 Q
              -1.20

TRANS CT      812 Q
NET3          $12367.14
***RA         3 Q
              $188.43
***RA2        1 Q
              $80.00
***PO         1 Q
              $30.00
***PO2        1 Q
              $20.00
REFUND        4 Q
              $171.50
VOID          4 Q
              $77.60
MGR VD        1 Q
              $17.71
VOID          1 Q
              $17.71
(-) 1         2 Q
              -2.78
(-) 2         1 Q
              -1.75
    
```

Cashier no.

Cashier name

Sales total

Customer counter

• Sample Z report

```

08/27/2004 8:24PM 1111
123456#1782      DICK

#151 *Z1*
*CASHIER *

Z1 0021
    
```

The subsequent printout occurs in the same format as in the sample X report.

```

CHECK1        5 Q
              $233.95
CHECK2        3 Q
              $133.40
CA/CH ID     $11686.10
****CID      $11318.75

COM. SAL1    $59.67
COM. AMT1    $0.90
COM. SAL2    $48.71
COM. AMT2    $1.02
COM. SAL3    $70.07
COM. AMT3    $2.24
COM. SAL4    $36.59
COM. AMT4    $0.44
COM. SAL5    $49.12
COM. AMT5    $0.34
COM. SAL6    $34.04
COM. AMT6    $0.37
COM. SAL7    $2715.09
COM. AMT7    $141.18
COM. SAL8    $1527.76
COM. AMT8    $47.36
COM. SAL9    $71.65
COM. AMT9    $1.79
COM. TTL     $195.64
NON COM.     $7734.82
    
```

Commission 1 sales total

Commission 1 amount
(commission 1 sales
total x commission 1 rate)

Commission amount total

Non-commission sales
total

```

%4           4 Q
              -1.65
NO SALE      5 Q
DRW CNT      220 Q
CONV 1       30.00
CONV 2       80.00
CONV 3       100.00
CONV 4       100.00
FS/ID        $117.00
CASH         1306 Q
              $11265.74
CASH2        6 Q
              $110.74
CHARGE1      6 Q
              $87.98
CHARGE1-     2 Q
    
```

* When you take these reports in the OP X/Z mode, the X report shows an "OP X" and the Z report shows an "OP Z".

Full cashier reading and resetting

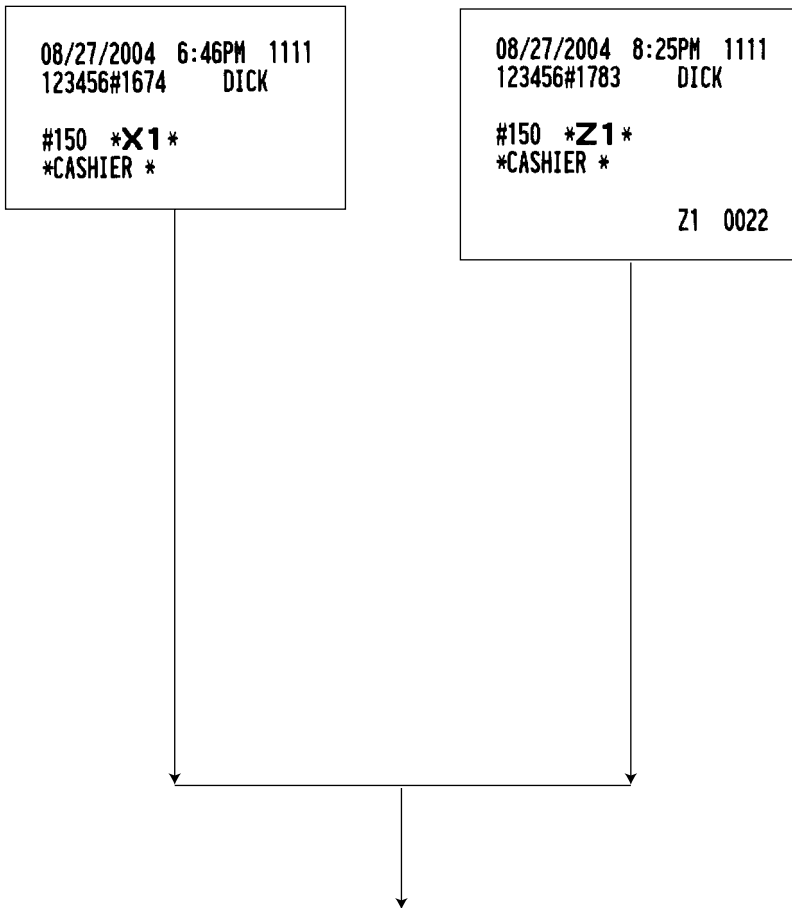

The subsequent printout occurs in the same format as in the sample report shown in the previous page: and sales data for cashiers print in this sequence.

■ Hourly report

You can take X and Z reports for sales totals and transaction (customer) counters for 48 half hours, or 24 hours. If both quantity and amount are zero, their print is skipped.

• Sample X report

08/27/2004 6:47PM 1111	
123456#1676 DICK	
#160 *X1*	
* HOURLY *	
9:00AM	82 Q
	\$563.49
AVE.	\$6.87
9:30AM	171 Q
	\$1127.45
AVE.	\$6.59
SUBTOTAL	253 Q
	\$1690.94
10:00AM	121 Q
	\$750.17
AVE.	\$6.20
10:30AM	157 Q
	\$1274.90
AVE.	\$8.12
SUBTOTAL	278 Q
	\$2025.07

• Sample Z report

08/27/2004 8:26PM 1111	
123456#1785 DICK	
#160 *Z1*	
* HOURLY *	
	Z1 0015

The subsequent printout occurs in the same format as in the sample X report.

5:00PM	136 Q
	\$1171.50
AVE.	\$8.61
5:30PM	133 Q
	\$1010.42
AVE.	\$7.60
SUBTOTAL	269 Q
	\$2181.92
6:00PM	147 Q
	\$1123.58
AVE.	\$7.64
6:30PM	144 Q
	\$1224.15
AVE.	\$8.50
SUBTOTAL	291 Q
	\$2347.73

— Customer counter
 — Sales total
 — Average sales amount per customer
 (sales total ÷ customer counter)

■ Full department report

```

08/27/2004 6:47PM 1111
123456#1679 DICK

#110 *X1*
*DEPT*

D01 475.000 Q
DPT.01 $2501.95
      18.34%
D02 338.000 Q
DPT.02 $1981.78
      14.52%
D03 165.000 Q
DPT.03 $1400.89
      10.27%
    
```

Sales q'ty and amount

Ratio of dept. 1 sales
amount to "+" real
dept. total

■ Individual group total report on department

```

08/27/2004 6:48PM 1111
123456#1680 DICK

#112 *X1*
*GROUP*

D02 338.000 Q
DPT.02 $1981.78
D15 7.000 Q
DPT.15 -5.95
GROUP01 345.000 Q
        $1975.83
    
```

Group 1 total

```

D20 7.000 Q
DPT.20 $53.51
      0.39%
*DEPT TL 1916.000 Q
        $13645.49
        100.00%

D11 2.000 Q
DPT.11 -12.24
DEPT(-) 2.000 Q
        -12.24

D12 4.000 Q
DPT.12 $8.52
*HASH TL 4.000 Q
        $8.52

D13 3.000 Q
DPT.13 -2.65
HASH(-) 3.000 Q
        -2.65

D14 15.000 Q
DPT.14 $11.25
*BTTL TL 15.000 Q
        $11.25

D15 7.000 Q
DPT.15 -5.95
BTTL(-) 7.000 Q
        -5.95
    
```

■ Full group total report on department

```

08/27/2004 6:48PM 1111
123456#1690 DICK

#113 *X1*
*GROUP*

GROUP01 345.000 Q
        $1975.83
GROUP02 167.000 Q
        $1412.15
GROUP03 478.000 Q
        $2521.42
    
```

Group 1 total

```

GROUP08 18.000 Q
        $89.08
GROUP09 263.000 Q
        $2861.91
    
```

■ PLU/UPC report (by designated range or pick up list)

This function provides you with X and Z reports for sales information of PLUs/UPCs.

You can select either of the designated range operation or pick up list operation. The range may represent all or part of the PLUs/UPCs in your register.

• Sample X report

08/27/2004 6:48PM 1111		
123456#1695		DICK
#120 *X1*		
*PLU/UPC *		
	00001-	
	999999999999	Range
PLU code	P00001	10.000 Q
Item label	PLU00001	\$14.48
	L2	2.000 Q
		\$4.00
	P00002	7.000 Q
	PLU00002	\$9.79
	L2	1.000 Q
		\$0.99

***TOTAL		162.876 Q	
		\$46393.13	
	L2	27.000 Q	
		\$105.31	
UPC			
UPC code	5012345678900#		
		14.000 Q	
Item label	APPLE	\$22.09	
	L2	1.000 Q	
		\$2.80	
	5056789123404#		
		1.000 Q	
	DPT. 05	\$7.50	
	L2	2.000 Q	
		\$12.40	
	5087654321106#		
		2.000 Q	
	ORANGE	\$12.00	
	L2	3.000 Q	
		\$24.00	
	5089123456708#		
		1.000 Q	
	GRAPE	\$5.20	
	L2	2.000 Q	
		\$12.20	
	5099887654302#		
		40.000 Q	
	CLOTH	\$200.00	
	L2	1.000 Q	
		\$20.00	
***TOTAL		58.000 Q	
		\$246.79	
	L2	9.000 Q	
		\$71.40	

• Sample Z report

08/27/2004 8:29PM	
123456#1790	
#120 *Z1*	
*PLU/UPC *	
	Z1 0005

The subsequent printout occurs in the same format as in the sample X report.

Note

The PLU/UPC range is not printed in pick report (#109).

■ PLU/UPC report by associated department

• Sample X report

```

08/27/2004 6:50PM 1111
123456#1697 DICK

#121 *X1*
*PLU/UPC*

DPT. 02      D02
PLU
P00001      10.000 Q
PLU00001    $14.48
L2          2.000 Q
           $4.00

***TOTAL    10.000 Q
           $14.48
L2          2.000 Q
           $4.00

UPC
5012345678900#
APPLE      14.000 Q
           $22.09
L2         1.000 Q
           $2.80

***TOTAL    14.000 Q
           $22.09
L2          1.000 Q
           $2.80
    
```

Associated dept.code

PLU code

Sales q'ty and total (for price level 1)

• Sample Z report

```

08/27/2004 8:31PM
123456#1792

#121 *Z1*
*PLU/UPC*

                Z1 0006
    
```

The subsequent printout occurs in the same format as in the sample X report.

■ PLU/UPC price category report

```

08/27/2004 6:50PM 1111
123456#1704 DICK

#129 *X1*
*CATEGORY*

                0.00 - 9999.99
PLU
P00001
PLU00001
L1      10.000 Q
           $14.48
L2       2.000 Q
           $4.00
    
```

Price amount range

Sales q'ty and total (for price level 1)

```

***TOTAL
L1      157.876 Q
           $46484.99
L2       27.000 Q
           $105.31

UPC
5012345678900#
APPLE
L1      14.000 Q
           $22.09
L2       1.000 Q
           $2.80
    
```

```

***TOTAL
L1      58.000 Q
           $246.79
L2       9.000 Q
           $71.40
    
```

■ PLU/UPC zero sales report

```

08/27/2004 6:49PM 1111
123456#1699 DICK

#127 *X1*
*ZERO SAL*

PLU
P00012
PLU00012
P00014
PLU00014
P00015
PLU00015

UPC
5023456789102#
BOWL
323210987650#
DRINK-A
323456789108#
DRINK-B
35555555551#
DRINK-C
    
```

PLU code

Item label

■ PLU/UPC stock report (by designated range or pick up list)

08/27/2004 6:50PM 1111	
123456#1706 DICK	
#124 *X1*	
* STOCK *	
	00001-9999999999999999
	Range
PLU	
P00001	
PLU00001	38.000 S
	Current stock
P00002	
PLU00002	34.500 S
P00003	
PLU00003	63.000 S
P00004	
PLU00004	56.000 S

UPC	
5012345678900#	
APPLE	63.000 S
5023456789102#	
BOWL	32.000 S
5056789123404#	
DPT. 05	42.000 S
5087654321106#	
ORANGE	47.000 S
5089123456708#	
GRAPE	83.000 S
5099887654302#	
CLOTH	110.000 S

■ Commission sales report

08/27/2004 6:51PM 1111		
123456#1708 DICK		
#132 *X1*		
* SALES *		
COM. SAL1	\$96.47	Commission 1 (sales total)
COM. AMT1	\$1.45	Commission 1 (amount)
COM. SAL2	\$19.16	
COM. AMT2	\$0.40	
COM. SAL3	\$89.47	
COM. AMT3	\$2.86	
COM. SAL4	\$16.86	
COM. AMT4	\$0.20	
COM. SAL5	\$76.56	
COM. AMT5	\$0.54	
COM. SAL6	\$84.29	
COM. AMT6	\$0.93	
COM. SAL7	\$2983.42	
COM. AMT7	\$155.14	
COM. SAL8	\$1717.12	
COM. AMT8	\$53.23	
COM. SAL9	\$85.35	
COM. AMT9	\$2.13	Commission amount total
COM. TTL	\$216.88	
NON COM.	\$8475.72	Non-commission sales
NET 1	\$13616.42	Net sales total

Note The PLU/UPC range is not printed in pick up report (#104).

■ PBLU report

• Sample X report

08/27/2004 6:51PM 1111	
123456#1710 DICK	
#180 *X1*	
PBLU	
	0001-9999
0001#	1111
***PBAL	\$27.95
0002#	1111
***PBAL	\$21.65
***TOTAL	
***PBAL	\$49.60

• Sample Z report

08/27/2004 8:34PM 1111	
123456#1788 DICK	
#180 *Z1*	
PBLU	
	Z1 0015

The subsequent printout occurs in the same format as in the sample X report.

■ PBLU report by cashier

• Sample X report

```

08/27/2004 6:51PM 1111
123456#1711 DICK

#181 *X1*
*PBLU*

01CSR#1111 DICK
0001#
***PBAL $27.95
0002#
***PBAL $21.65

***TOTAL
***PBAL $49.60
    
```

• Sample Z report

```

08/27/2004 8:35PM 1111
123456#1789 DICK

#181 *Z1*
*PBLU*

Z1 0016
    
```

The subsequent printout occurs in the same format as in the sample X report.

■ Cash in drawer report

You can take full cashier X reports for cash in drawer.

■ Transaction report

```

08/27/2004 6:52PM 1111
123456#1713 DICK

#130 *X1*
* TRANS. *
    
```

In this report the same transaction data as those printed when general reading is taken are printed except department sales totals.

```

08/27/2004 7:16PM 1111
123456#1775 DICK

#131 *X1*
* CID *

01CSR1111 DICK
TRANS CT 1354 Q
NET3 $12360.61
****CID $11318.75

02CSR0002 CASHIER2
TRANS CT 53 Q
NET3 $283.68
****CID $283.68

***TOTAL
TRANS CT 1552 Q
NET3 $13941.19
****CID $12899.33
    
```

Cashier no.
Cashier name
Customer counter
Sales total
Cash in drawer

■ X1/Z1 stacked report

You can print multiple X1/Z1 reports in sequence at a single time. In this case, you need to program in advance what X1/Z1 reports should be printed in the stacked report sequence.

Note

The following job code numbers (only) can be used for stacked report printing.

Job code number: 100, 110, 113, 120, 124, 127, 129, 130, 131, 132, 150, 160, 180

Refer to "Selection of X1/Z1 and X2/Z2 reports to be printed in the stacked report sequence" for further details.

■ Deleting of non-accessed UPCs

• Sample X report (Reading)

	11/28/2004 5:23AM 1111
	123456#1807 DICK
	#105 *X1*
	NO ACCE
UPC code	323456789108#
	0.000 Q
Item label	DRINK-B \$0.00
	L2 0.000 Q
	\$0.00
	Z2 1.000 Q
	\$2.50
	Periodic sales*

• Sample Z report (Deleting)

	11/28/2004 5:24AM 1111
	123456#1808 DICK
	#105 *Z1*
	NO ACCE
	DELETE

↓
The subsequent printout occurs in the same format as in the sample X report.

*: When there is any sales data of the UPC for #209 report, the data is printed here.
When you delete the UPC in Z1 mode under this situation, the data for #209 is also deleted.

3 Periodic consolidation

Your register allows you to take consolidation X and Z reports of a chosen period (normally one week or a month).

■ General Overview

The periodic reading or resetting reports are the same in format as those in the X1/Z1 report for daily total except job code no. (#2xx) and mode indication ("X2" or "Z2".)

• Sample X report

```
08/27/2004 7:20PM 1111
123456#1777 DICK
#200 *X2*
```

Read symbol

• Sample Z report

```
08/27/2004 8:39PM 1111
123456#1790 DICK
#200 *Z2*
          Z1 0015
          Z2 0002
GT1      $00000118559.63
GT2      $00000118972.28
GT3      -00000000412.65
TR       $00000000173.98
```

Reset symbol
Reset counter of daily total
Reset counter of periodic consolidation
Grand total

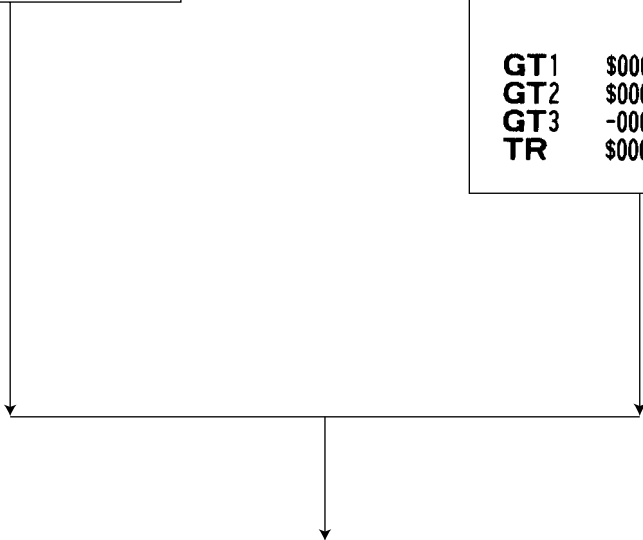

The subsequent printouts are the same in format as those in the X/Z report for daily total.

■ Daily net report

• Sample X report

10/31/2004 11:35PM 1111	
123456#8750 DICK	
#270 *X2*	
* DAILY *	
10/01	212 Q
	\$1292.75
10/02	200 Q
	\$1826.18
10/03	248 Q
	\$2399.87
10/04	232 Q
	\$2255.01
10/05	504 Q
	\$5096.48
10/30	332 Q
	\$2600.41
10/31	288 Q
	\$2899.76
***TOTAL	4542 Q
	\$71243.42

• Sample Z report

11/01/2004 1:30AM 1111	
123456#8771 DICK	
#270 *Z2*	
* DAILY *	
	Z2 0002

↓
The subsequent printout occurs in the same format as in the sample X report.

■ X2/Z2 stacked report

You can print multiple X2/Z2 reports in sequence at a single time. In this case, you need to program in advance what X2/Z2 reports should be printed in the stacked report sequence.

Note

The following job code numbers (only) can be used for stacked report printing.

Job code number: 200, 210, 213, 220, 227, 229, 230, 231, 232, 250, 270

Refer to "Selection of X1/Z1 and X2/Z2 reports to be printed in the stacked report sequence" for further details.

COMPULSORY CASH/CHECK DECLARATION

If you want to make the declaration of the cash and check amount in the drawer mandatory before performing cashier Z reports, please consult your dealer and have your register programmed for compulsory cash/check declaration.

If your register is programmed for compulsory cash/check declaration (CCD), a cashier must first count and declare the cash and check amounts (of domestic and foreign currency) in the drawer, before he or she can performing a cashier report. The procedure for outputting a CCD report is shown below.

Types of compulsory cash/check declarations

- Compulsory declaration prior to individual cashier resetting
- Compulsory declaration prior to full cashier resetting

Note

- Compulsory cash/check declaration is available in the above two types. You can choose either of these. Please consult your dealer for further details.
- When the cash/check declaration is compulsory, flash reports are not available.

Key operation

After the **CA/AT** key is pressed, the register prompts the cashier to input the cash and check accounts for both domestic and foreign currency. The cashier can simply input the total amounts of each currency unit, or the number of bills or coins of each denomination of each currency unit.

Individual cashier report

OP X/Z mode



X1/Z1 mode

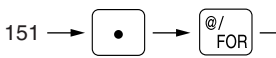

Full cashier report

X1/Z1 mode

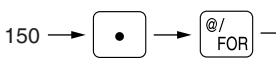

The drawer opens and the cashier is prompted to enter the cash and check amounts. ("CCD" is displayed.)

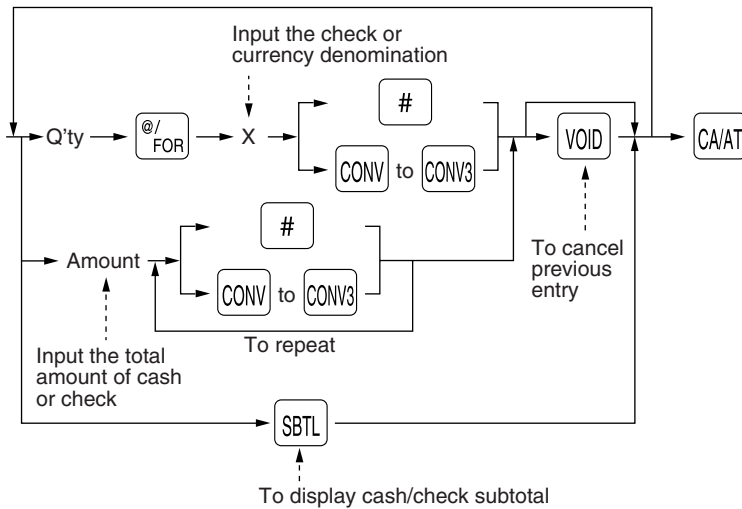

: When inputting the cash or check amount (domestic currency) in the drawer

CONV to CONV3 : When inputting the amount of a foreign currency in the drawer

08/28/2004 11:50PM 1111
123456#2928 DICK

#151 *Z1*
* CCD *

CA/CH IS	\$11686.10
CONV1 IS	30.00
CONV2 IS	80.00
CONV3 IS	100.00

} CCD entry amount

*CASHIER *

Z1 0023
01CSR#1111 DICK
NET 1 \$12319.52

CONV 1	30.00
CONV1 IS	30.00
CCD DIF.	0.00
CONV 2	80.00
CONV2 IS	80.00
CCD DIF.	0.00
CONV 3	100.00
CONV3 IS	100.00
CCD DIF.	0.00
CONV 4	100.00
FS/ID	\$117.00
CASH	1306 Q
	\$11265.74
CASH2	6 Q
	\$110.74
CHARGE1	6 Q
	\$87.98

— Currency conversion 1 in drawer to be obtained
— Total of entered (declared) conversion 1 in drawer
— Difference

CHECK2	3 Q
	\$133.40
CA/CH ID	\$11686.10
CA/CH IS	\$11686.10
CCD DIF.	\$0.00
DIF. TL	\$0.00
****CID	\$11318.75
COM. SAL1	\$59.67
COM. AMT1	\$0.90

— Check 2 (in domestic currency) in drawer to be obtained
— Cash/check in drawer to be obtained
— Total of entered (declared) cash/check in drawer
— Difference
— Total of difference
— Cash in drawer to be obtained

COM. SAL9	\$71.65
COM. AMT9	\$1.79
COM. TTL	\$195.64
NON COM.	\$7734.82

OPERATOR MAINTENANCE

1 In case of power failure

When power is lost, the machine retains its memory contents and all information on sales entries.

- When a power failure is encountered in register idle state or during an entry, the machine returns to the normal state of operation after power recovery.
- When a power failure is encountered during a printing cycle, the register prints "======" and then carries out the correct printing procedure after power recovery. (See the sample print.)

DPT. 03	\$10.00
NDT AE	\$25.00
=====	=====
DPT. 05	\$35.00
CASH	\$45.00

2 In case of printer error

If the printer runs out of paper, the printer will halt, "PAPER EMPTY" error will appear on the display, and the register will start to continuously produce an intermittent beeping tone. Key entries will not be accepted. Referring to "4. Installing and removing the paper roll" in this chapter, install a new roll paper in the proper position, then press the **CL** key. The printer will print the power failure symbol and resume printing.

If the print head is up, the printer halts, "HEAD UP" error will appear on the display, and the register will start to continuously produce an intermittent beeping tone. Key entries will not be accepted. Bring the print head to the correct position, then press the **CL** key. The printer will print the power failure symbol and resume printing.

3 Thermal printing

Your register prints by means of thermal printing. The print head applies heat to thermal paper which is chemically treated to change color when heated to a certain level. This creates the printed text.

■ Cautions in handling the printer

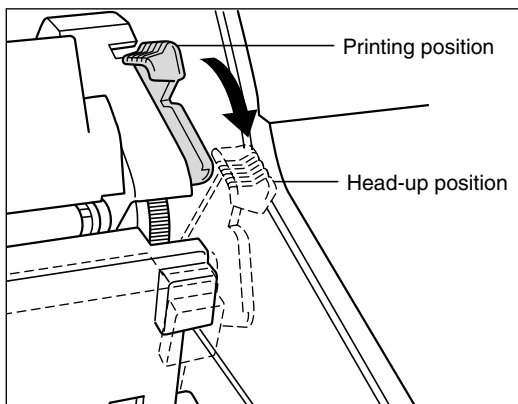

- If you are not going to use the register for an extended period of time, pull the print head release lever toward you so that the print head is set apart from the plate.

- Avoid the following environments:
 - Dusty and humid places
 - Direct sunlight
 - Iron powder (A permanent magnet and electromagnet are used in this machine.)
- Use the print head release lever only when necessary.
- Never pull the paper when it is in contact with the print head. First release the head with the print head release lever, and then remove the paper.
- Never touch the surface of the print head.
- Never touch around the print head and the motor during printing or before they have had sufficient time to cool.

■ Cautions in handling the recording paper (thermal paper)

- Use only the paper specified by SHARP.
- Do not unpack the thermal paper until you are ready to use it.
- Avoid heat. The paper will color at around 70°C.
- Avoid dusty and humid places for storage. Avoid direct sunlight.
- The printed text on the paper can discolor under the following conditions:
 - Exposure to high humidity and temperature
 - Exposure to the direct sunlight
 - Contact with glue, thinner or a freshly copied blueprint
 - Heat caused by friction from scratching or other such means
 - Contact with a rubber eraser or adhesive tape
- Be very careful when handling the thermal paper. If you want to keep a permanent record, copy the printed text with a photocopier.

4 Installing and removing the paper roll

■ Recording paper specifications

Be sure to use paper rolls specified by SHARP.

The use of any other paper rolls than specified could cause paper jamming, resulting in register malfunction.

Paper specification

Paper width:	1.75 ± 0.02 in. (44.5 ± 0.5 mm)
Max. outside diameter:	3.15 in. (80 mm)
Quality:	Thermal paper
Paper tube:	0.71 in. (18 mm)

- Be sure to set paper roll(s) prior to using your machine, otherwise it may cause a malfunction.

Install the paper roll in the printer. Be careful then to set the roll and cut the paper end correctly.

Note

If the top end of the paper roll is fixed with paste or tape, the paper may lose its color development ability in the pasted or taped area due to the deterioration of the heat-sensitive color development component of the paper surface. This may result in nothing appearing at this location when printing is performed. Therefore, when setting a new paper roll in the machine, be sure to cut off approximately one revolution (approx. 25 cm long).

(How to set the paper roll)

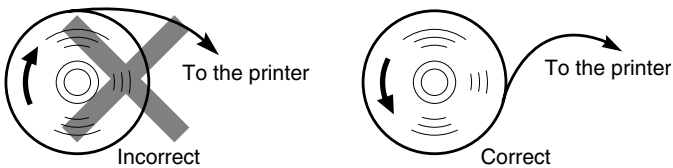

(How to cut the paper end)

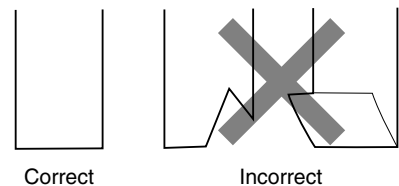

■ Installing the paper roll

Installing the receipt paper roll

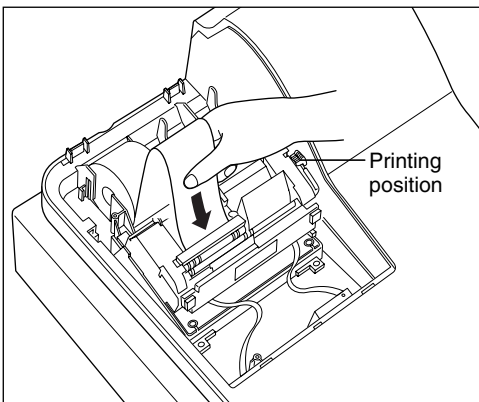

1. Turn the mode switch to the "REG" position with the AC cord connected.
2. Remove the printer cover.
3. Check that the print head release lever is in its printing position.
4. Set the paper correctly as illustrated above in the receipt side of the printer.
5. Insert the end of the paper into the paper chute as shown on the left. It will automatically be fed through the printer.
6. Cut off the excess paper that comes out of the printer with the manual cutter.
7. Replace the printer cover.

Installing the journal paper roll

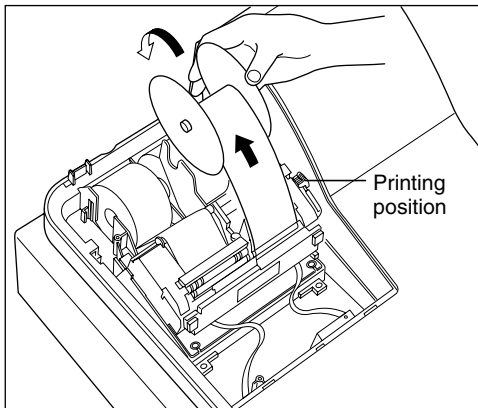



1. Turn the mode switch to the "REG" position with the AC cord connected.
2. Remove the printer cover.
3. Check that the print head release lever is in its printing position.
4. Set the paper correctly as illustrated on the previous page in the journal side of the printer.
5. Insert the end of the paper into the paper chute as shown on the left. It will automatically be fed through the printer.
6. Insert the end of the paper into the slit in the paper take-up spool. (Press the  key to feed more paper through if required.)
7. Wind the paper two or three turns around the spool shaft.
8. Set the spool on the bearing.
9. Replace the printer cover.

Note

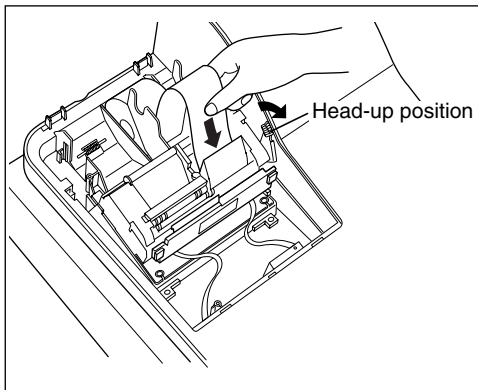
- When it is difficult to insert paper into the paper chute, try inserting it again by following the steps described below.



1. Cut off the end of paper in a single straight cut.
2. Pull the print head release lever toward you to lift up the print head.
3. Insert the end of paper into the paper chute, while pressing the corresponding paper feed key ( key or  key).
4. When the end of paper comes out of the printer, release the feed key and return the print head release lever to its original position.
5. Press the feed key to feed more paper.

In case of inserting the journal paper roll

- When you want to manually install a new roll of paper while your machine is turned off, follow the steps shown below:
 1. Pull the print head release lever toward you to lift up the print head.
 2. Correctly place the new paper roll into the receipt/journal paper roll location.
 3. Insert the paper end into the paper chute until it comes out of the printer.
 4. Cut or roll the paper onto the take-up spool as described for automatic installation.
 5. Return the print head release lever to its original position.

■ Removing the paper roll

When a colored dye appears on the paper roll, it is time to replace the existing paper roll. Replace the paper roll with a new one. If you plan not to use your register for an extended period of time, remove the paper roll, and store it in the appropriate place.

Removing the receipt paper roll

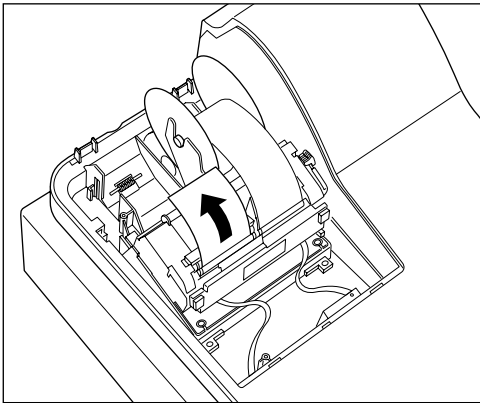



1. Remove the printer cover.
2. Cut the paper behind the printer and near the paper roll.
3. Press the  key until the paper remaining in the printer comes out completely.
4. Remove the paper roll from the back of the printer.

Note

Do not pull the paper through the printer.

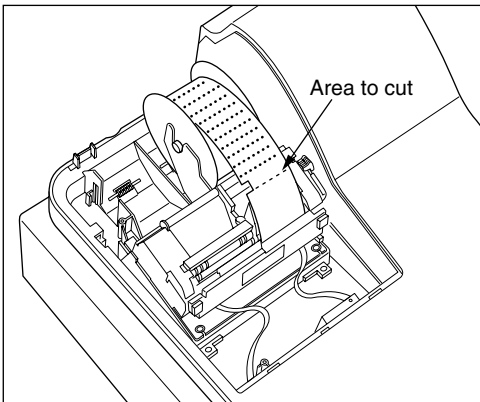
Removing the journal paper roll



1. Remove the printer cover.
2. Press the  key to advance the journal paper until its printed part is out of the way.
3. Cut the paper and remove the take-up spool.

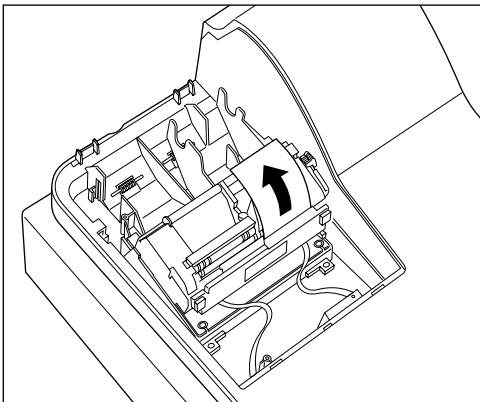

4. Cut the paper behind the printer and near the paper roll.
5. Press the  key until the paper remaining in the printer comes out completely.
6. Remove the paper roll from the back of the printer.

Note

Do not pull the paper through the printer.

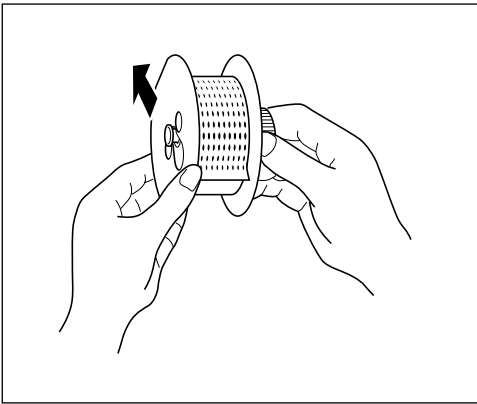

7. Remove the outer side of the take-up spool as shown on the left.

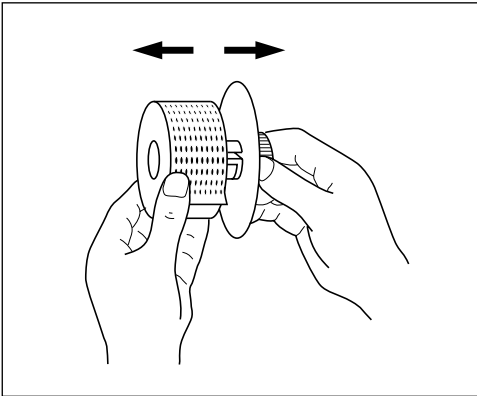

8. Remove the printed journal roll from the take-up spool.

■ Removing a paper jam

Precaution: Be very careful with the manual paper cutter, so as not to cut yourself. Never touch the print head immediately after printing, because the head may still be hot.

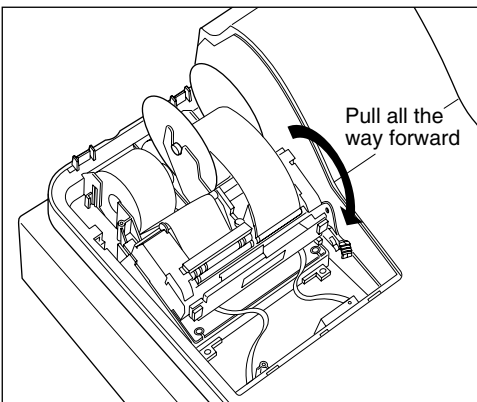

- 1.** Remove the printer cover.
- 2.** Pull the print head release lever all the way forward (after it stops at one position, continue pulling forward until it stops again and cannot be pulled forward any further).
- 3.** Remove the paper jam. Check for and remove any shreds of paper that may remain in the printer.
- 4.** Reset the paper roll correctly by following the steps in "Installing the paper roll".
- 5.** Return the print head release lever to its original position.
- 6.** Replace the printer cover.

5 Cleaning the print head

When the printed text is getting dark or faint, paper dust may be stuck to the print head. Clean the print head as follows:

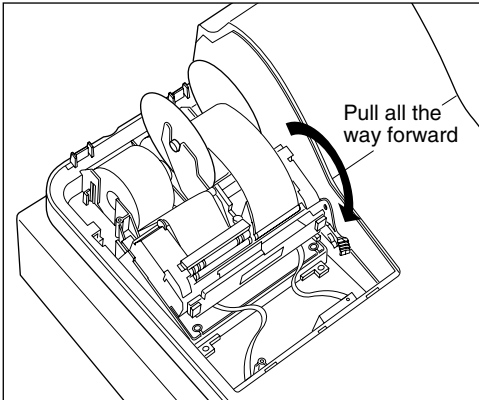

1. Turn the mode switch to the "OFF" position.
2. Remove the printer cover.
3. Pull the print head release lever all the way forward (after it stops at one position, continue pulling forward until it stops again and cannot be pulled forward any further).

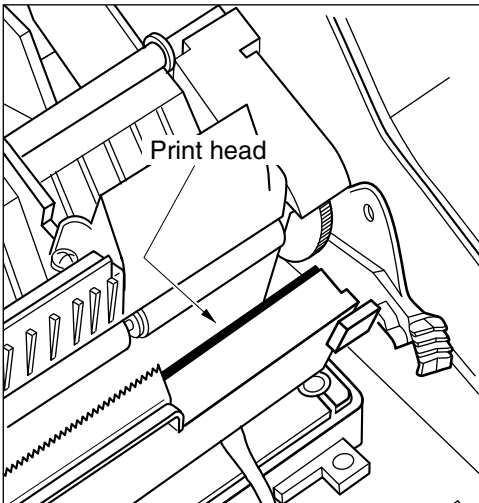

4. Clean the print head with a soft rag moist with ethyl alcohol or isopropyl alcohol.
5. Return the print head release lever to its original position immediately after cleaning.
6. Replace the printer cover.

Caution:

- Never touch the print head with a tool or anything hard as it may damage the head.
- The paper cutter is mounted on the printer (receipt side). Be careful not to cut yourself.

6 Removing the till and the drawer

The till in the register is detachable. After closing your business for the day, remove the till from the drawer and keep the drawer open. To detach the drawer, pull it forward fully with the till removed, and remove it by lifting it up.

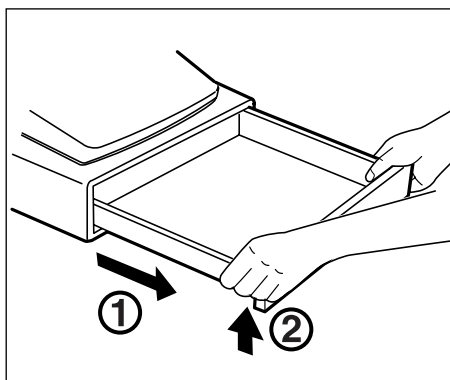
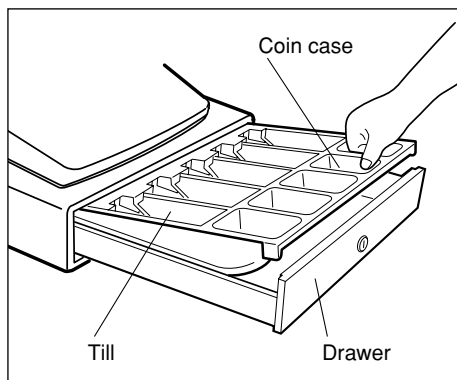

7 Opening the drawer by hand

The drawer automatically opens normally. However, when power failure is encountered or the machine becomes out of order, slide the lever located on the machine bottom toward the rear. (See the figure below.) The drawer will not open if it is locked with a drawer lock key.

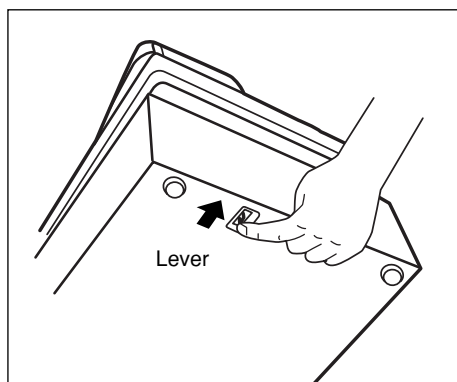

8 Before calling for service

The malfunctions shown in the left-hand column below, labelled "Fault," do not necessarily indicate functional faults of the machine. It is therefore advisable to refer to the "Checking" shown in the right-hand column before calling for service.

Fault	Checking
(1) The display won't be illuminated even when the mode switch is turned to any other position than "OFF".	<ul style="list-style-type: none"> • Is power supplied to the electrical outlet? • Is the power cord plug out or loosely connected to the electrical outlet?
(2) The display is illuminated, but the whole machine refuses registrations.	<ul style="list-style-type: none"> • Is a cashier code assigned to the register? • Is the mode switch set properly at the "REG" position?
(3) No receipt is issued.	<ul style="list-style-type: none"> • Is the receipt paper roll properly installed? • Is there a paper jam? • Is the receipt function in the "OFF" status? • Is the print head release lever at the printing position?
(4) No journal paper is taken up.	<ul style="list-style-type: none"> • Is the take-up spool installed on the bearing properly? • Is there a paper jam?
(5) Printing is unusual.	<ul style="list-style-type: none"> • Is the print head release lever at the printing position? • Is the paper roll properly installed?

■ Error message table

Text no.	Description	In default of programming
1	Registration error	ENTRY ERROR
2	Misoperation error	MISOPERATION
3	Desired code is not programmed yet.	NO RECORD
4	(Reserved)	
5	Secret code error	SECRET CODE
6	Code is not free	NOT FREE
7	Memory is full.	MEMORY FULL
8	Insert slip paper.	INSERT SLIP
9	The entered cashier's code is not authorized.	NO AUTHORITY
10	Stock is empty.	OUT OF STOCK
11	Compulsory pushing the subtotal key	SBTL COMPUL.
12	Compulsory tendering	TEND COMPUL.
13	Compulsory PBLU entry	PB COMPUL.
14-19	(Reserved)	
20	Remote printer off line	OFF LINE
21	(Reserved)	
22	Overlapped cashier error	CASHIER ERR.
23-26	(Reserved)	
27	Power off	POWER OFF
28-30	(Reserved)	
31	Compulsory non-add code	# COMPULSORY
32	The cashier is not assigned.	NOT ASSIGNED
33	(Reserved)	
34	Overflow limitation	OVER LIMIT.
35	The open price entry is inhibited.	INH. OPEN PR
36	The unit price entry is inhibited.	INH. UNIT PR
37	The direct non-tendering finalization after previous tender entry is inhibited.	NOT NON-TEND
38	Read error of scale data	SCALE ERROR

Text no.	Description	In default of programming
39-50	(Reserved)	
51	Weight on scale	WEIGHT
52-53	(Reserved)	
54	Entry of tare weight	ENTR TARE WT
55-60	(Reserved)	
61	Desired code is not programmed yet. (learning function)	NO RECORD
62	Enter price and dept. no.	PRICE → DEPT
63	Enter price and dept. no.	PRICE & DEPT
64	Enter dept. no.	ENTER DEPT#
65-66	(Reserved)	
67	REG buffer is full.	BUFFER FULL
68-69	(Reserved)	
70	Price entry at UPC refund	ENTER PRICE
71-73	(Reserved)	
74	Non-accessed UPC delete job	DELETE
75	(Reserved)	
76	Closing the drawer is compulsory.	CLOSE DRAWER
77-78	(Reserved)	
79	Reading of undefined vender coupon UPC	OP ENTER
80	(Reserved)	
81	Message for prompting entry of secret code	ENTR SECRET#
82-83	(Reserved)	
84	Data backup send success	SEND OK
85	Data backup receive success	RECEIVE OK
86	Data backup communication error	COM. ERROR
87	Backup data format error	DATA ERROR
88	Data backup time out error	TIME OUT
89-93	(Reserved)	
94	Age limitation error	AGE ERROR

LIST OF OPTIONS

For your register, the following Sharp options are available.

For further details on additional options that may be considered, please contact your dealer.

- Remote drawer model ER-04DW
- Till model ER-55CC2
- Key kit models

By using the following key kits, the keyboard layout can be changed on your register including the expansion of the number of departments.

ER-11KT7: 30 regular size key kits

ER-12KT7: 30 1 x 2 size key kits

ER-22KT7: 10 2 x 2 size key kits

ER-11DK7G: 30 regular size dummy key kits

ER-51DK7G: 10 5 x 1 size dummy key kits

} for ER-A410 only

- Barcode reader model ER-A6HS1 (only for the standard channel 1)

SPECIFICATIONS

Model:	ER-A410/A420																				
Dimensions:	16.5 (W) x 16.8 (D) x 11.7 (H) in. (420 (W) x 427 (D) x 297 (H) mm)																				
Weight:	29.1 lbs (13.2 kg)																				
Power source:	120V \pm 10% AC, 60Hz																				
Power consumption:	Stand-by 9 W Operating 46.5 W (max.)																				
Working temperature:	32 to 104°F (0 to 40°C)																				
Electronics:	LSI (CPU) etc.																				
Built-in battery:	Rechargeable battery, memory holding time about 1 month (with fully charged built-in battery, at room temperature)																				
Display:																					
Operator display:	LCD dot-matrix display (16 positions x 2 lines)																				
Customer display:	7-segment display (7 positions)																				
Printer:																					
Type:	2-station thermal printer																				
Printing speed:	Approx. 13.3 lines/second																				
Printing capacity:	24 digits each for receipt and journal paper																				
Other functions:	<ul style="list-style-type: none">• Graphic logo printing function• Logo text printing function• Receipt (ON-OFF) function, journal selective function• Receipt and journal independent paper feed function																				
Paper roll:	Width: 1.75 \pm 0.02 in. (44.5 \pm 0.5 mm) Max. diam.: 3.15 in. (80 mm) Quality: High quality (0.06 to 0.08 mm thickness)																				
Cash drawer:	5 slots for bill and 5 for coin denominations																				
Accessories:	<table><tr><td>Manager key</td><td>2</td><td rowspan="8">} for ER-A420 only</td></tr><tr><td>Submanager key</td><td>2</td></tr><tr><td>Operator key</td><td>2</td></tr><tr><td>Drawer lock key</td><td>2</td></tr><tr><td>Paper roll</td><td>2</td></tr><tr><td>Take-up spool</td><td>1</td></tr><tr><td>Standard key sheet</td><td>1 (mounted on the keyboard)</td></tr><tr><td>Programming key sheet</td><td>1 (mounted on the keyboard)</td></tr><tr><td>Instruction manual</td><td>1 copy</td></tr></table>		Manager key	2	} for ER-A420 only	Submanager key	2	Operator key	2	Drawer lock key	2	Paper roll	2	Take-up spool	1	Standard key sheet	1 (mounted on the keyboard)	Programming key sheet	1 (mounted on the keyboard)	Instruction manual	1 copy
Manager key	2	} for ER-A420 only																			
Submanager key	2																				
Operator key	2																				
Drawer lock key	2																				
Paper roll	2																				
Take-up spool	1																				
Standard key sheet	1 (mounted on the keyboard)																				
Programming key sheet	1 (mounted on the keyboard)																				
Instruction manual	1 copy																				

* Specifications and appearance subject to change without notice for improvement.

NOTICE

BE SURE TO ASK YOUR AUTHORIZED SHARP DEALER ABOUT THE WARRANTY THAT YOUR SELLING DEALER EXTENDS TO YOU. In order to assure you, the end-user, of warranty protection, Sharp extends a limited warranty to each of its authorized dealers, and in turn requires each of its authorized dealers to extend its own warranty to you on terms that are no less favorable than those given to the dealer by Sharp. You should be aware, however, that Sharp does not itself extend any warranties, either express or implied, directly to you, the end-user, and no one is authorized to make any representations or warranties on behalf of Sharp. Specifically, SHARP DOES NOT EXTEND TO YOU, THE END-USER, ANY EXPRESS WARRANTY OR ANY IMPLIED WARRANTY OF MERCHANTABILITY, FITNESS FOR USE OR FITNESS FOR ANY PARTICULAR PURPOSE IN CONNECTION WITH THE HARDWARE, SOFTWARE, OR FIRMWARE EMBODIED IN OR USED IN CONJUNCTION WITH THIS PRODUCT. Sharp is not responsible for any damages or loss, either direct, incidental or consequential, which you, the end-user, may experience as a result of your purchase or use of the hardware, software or firmware embodied in or used in conjunction with this product. Your sole remedy in the event that you encounter any difficulties with the product is against the authorized dealer from which you purchased the product. In the event that this authorized dealer does not honor its warranty commitments, please contact the General Manager of Sales, Retail and Financial System Division, ISG, Sharp Electronics Corporation, Sharp Plaza, P.O. Box 650, Mahwah, NJ 07430-2135 so that Sharp can try to help you to assure complete satisfaction of all the warranty rights to which you are entitled from the authorized dealer.

SHARP®

SHARP ELECTRONICS CORPORATION

Sharp Plaza, Mahwah, New Jersey 07430-2135

1-800-BE-SHARP

<http://www.sharp-usa.com>

SHARP CORPORATION

Free Manuals Download Website

<http://myh66.com>

<http://usermanuals.us>

<http://www.somanuals.com>

<http://www.4manuals.cc>

<http://www.manual-lib.com>

<http://www.404manual.com>

<http://www.luxmanual.com>

<http://aubethermostatmanual.com>

Golf course search by state

<http://golfingnear.com>

Email search by domain

<http://emailbydomain.com>

Auto manuals search

<http://auto.somanuals.com>

TV manuals search

<http://tv.somanuals.com>