

# *FM Stereo FM-AM Receiver*

---

## Operating Instructions

### Owner's Record

The model and serial numbers are located on the rear of the unit. Record the serial number in the space provided below. Refer to them whenever you call upon your Sony dealer regarding this product.

Model No. \_\_\_\_\_ Serial No. \_\_\_\_\_

***STR-DA7ES  
STR-DA4ES***

## WARNING

**To prevent fire or shock hazard, do not expose the unit to rain or moisture.**

To prevent fire, do not cover the ventilation of the apparatus with news papers, table-cloths, curtains, etc. And don't place lighted candles on the apparatus.

To prevent fire or shock hazard, do not place objects filled with liquids, such as vases, on the apparatus.



Don't throw away the battery with general house waste, dispose of it correctly as chemical waste.

Do not install the appliance in a confined space, such as a bookcase or built-in cabinet.

For customers in the United States

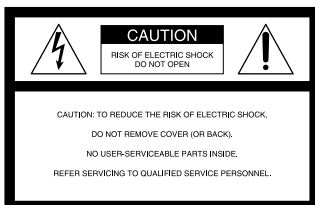

This symbol is intended to alert the user to the presence of uninsulated "dangerous voltage" within the product's enclosure that may be of sufficient magnitude to constitute a risk of electric shock to persons.



This symbol is intended to alert the user to the presence of important operating and maintenance (servicing) instructions in the literature accompanying the appliance.

## WARNING

This equipment has been tested and found to comply with the limits for a Class B digital device, pursuant to Part 15 of the FCC Rules. These limits are designed to provide reasonable protection against harmful interference in a residential installation. This equipment generates, uses, and can radiate radio frequency energy and, if not installed and used in accordance with the instructions, may cause harmful interference to radio communications. However, there is no guarantee that interference will not occur in a particular installation. If this equipment does cause harmful interference to radio or television reception, which can be determined by turning the equipment off and on, the user is encouraged to try to correct the interference by one or more of the following measures:

- Reorient or relocate the receiving antenna.
- Increase the separation between the equipment and receiver.
- Connect the equipment into an outlet on a circuit different from that to which the receiver is connected.
- Consult the dealer or an experienced radio/TV technician for help.

## CAUTION

You are cautioned that any changes or modification not expressly approved in this manual could void your authority to operate this equipment.

Note to CATV system installer:

This reminder is provided to call CATV system installer's attention to Article 820-40 of the NEC that provides guidelines for proper grounding and, in particular, specifies that the cable ground shall be connected to the grounding system of the building, as close to the point of cable entry as practical.



ENERGY STAR® is a U.S. registered mark.

As an ENERGY STAR® partner, Sony Corporation has determined that this product meets the ENERGY STAR® guidelines for energy efficiency.

For customers in Canada

### CAUTION

TO PREVENT ELECTRIC SHOCK, DO NOT USE THIS POLARIZED AC PLUG WITH AN EXTENSION CORD, RECEPTACLE OR OTHER OUTLET UNLESS THE BLADES CAN BE FULLY INSERTED TO PREVENT BLADE EXPOSURE.

If you have any questions about this product, you may call; Sony Customer Information Center 1-800-488-7669.

The Number below is for the FCC related matters only.

### Regulatory Information

#### Declaration of Conformity

Trade name: SONY

Model No.: STR-DA7ES/STR-DA4ES

Responsible Party: Sony Electronics Inc.

Address: 680 Kinderkamack Road, Oradell  
NJ 07649 U.S.A.

Telephone No.: 201-930-6972

This device complies with Part 15 of the FCC Rules. Operation is subject to the following two conditions:

(1) This device may not cause harmful interference, and (2) this device must accept any interference received, including interference that may cause undesired operation.

## About This Manual

- The instructions in this manual are for models STR-DA7ES and STR-DA4ES. Check your model number by looking at the lower right corner of the front panel. In this manual, the STR-DA7ES (area code U) is used for illustration purposes unless stated otherwise. Any difference in operation is clearly indicated in the text, for example, “STR-DA7ES only”.
- The instructions in this manual describe the controls on the receiver. You can also use the controls on the supplied remote if they have the same or similar names as those on the receiver. For details on the use of your remote:
  - STR-DA7ES  
RM-TP1: See the separate operating instructions supplied with the remote.  
RM-US105A: See pages 66–74.
  - STR-DA4ES  
RM-LP211: See the separate operating instructions supplied with the remote.

### About area codes

The area code of the receiver you purchased is shown on the upper portion of the rear panel (see the illustration below).

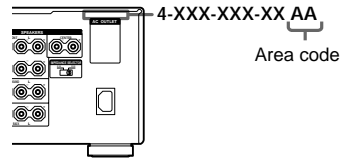

Any differences in operation, according to the area code, are clearly indicated in the text, for example, “Models of area code AA only”.

This receiver incorporates Dolby\* Digital and Pro Logic Surround and the DTS\*\* Digital Surround System.

\* Manufactured under license from Dolby Laboratories.

“Dolby”, “Pro Logic” and the double-D symbol are trademarks of Dolby Laboratories.

\*\* “DTS”, “DTS-ES Extended Surround” and “Neo:6” are trademarks of Digital Theater Systems, Inc.

# Table of Contents

---

## List of Button Locations and Reference Pages

Main unit .....	6
-----------------	---

---

## Getting Started

1: Check how to hookup your components .....	8
1a: Connecting components with digital audio output jacks .....	10
1b: Connecting components with multi channel output jacks .....	13
1c: Connecting components with only analog audio jacks .....	15
2: Connecting the antennas .....	17
3: Connecting speakers .....	18
4: Connecting the AC power cord .....	20
5: Setting up the speakers .....	21
6: Adjusting the speaker levels and balance (TEST TONE) .....	26

---

## Amplifier/Tuner Operation

Selecting the component .....	27
Listening to multi channel sound (MULTI CH DIRECT) .....	28
Listening to FM/AM radio .....	28
Presetting radio stations .....	30
Changing the display .....	31
About the indications in the display ....	32

---

## Enjoying Surround Sound

Automatically decoding the input audio signal (AUTO DECODING) .....	34
Using only the front speakers .....	34
Selecting a sound field .....	35
Enjoying Dolby Pro Logic II and DTS Neo:6 (2CH MODE) .....	38
Selecting the surround back decoding mode (SB DECODING) .....	39

---

## Advanced Adjustments and Settings

Assigning the audio input (AUDIO SPLIT) .....	41
Switching the audio input mode for digital components (INPUT MODE) .....	42
Customizing sound fields .....	43
Adjusting the equalizer .....	45
Advanced settings .....	47
Custom install mode .....	57

---

## Other Operations

Naming preset stations and functions ..	58
Using the Sleep Timer .....	59
Selecting the speaker system .....	59
Recording .....	60
CONTROL A1 II/S-LINK control system .....	61

---

## Operations Using the Remote (STR-DA7ES only)

Using the remote RM-US105A .....	66
Listening to the sound in another room .....	67

---

## Additional Information

Precautions .....	75
Troubleshooting .....	75
Specifications .....	78
Index .....	Back cover



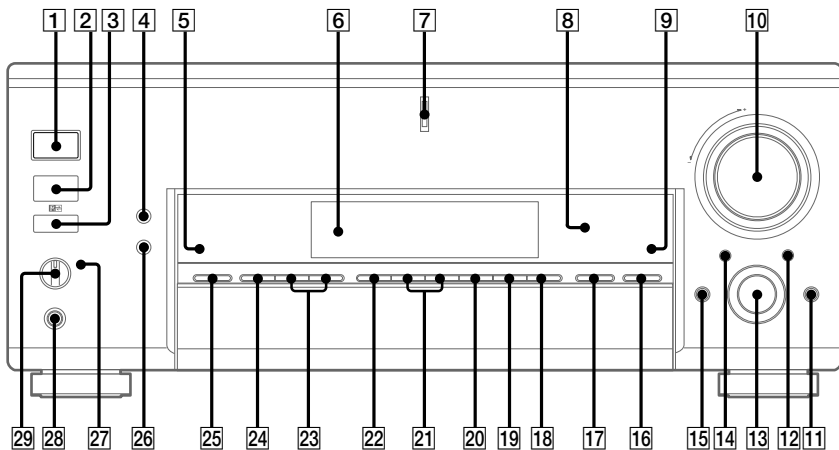

Open the front door

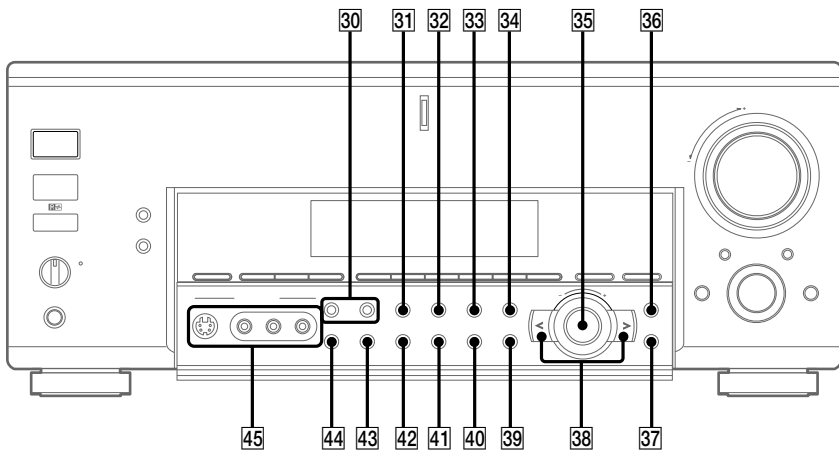

# 1: Check how to hookup your components

Steps 1a through 1c beginning on page 10 describe how to hook up your components to this receiver. Before you begin, refer to “Connectable components” below for the pages which describe how to connect each component.

After hooking up all your components, proceed to “2: Connecting the antennas” (page 17).

## Connectable components

Component to be connected	Page
DVD/LD player	
With digital audio output* <sup>1</sup>	10–11
With multi-channel audio output* <sup>2</sup>	13–14
With analog audio output only* <sup>3</sup>	10–11
TV monitor	
With component video input* <sup>4</sup>	11 or 14
With S-Video or composite video input only	16
Satellite tuner	
With digital audio output* <sup>1</sup>	10–11
With analog audio output only* <sup>3</sup>	10–11
CD/Super Audio CD player	
With digital audio output* <sup>1</sup>	12
With multi-channel audio output* <sup>2</sup>	13
With analog audio output only* <sup>3</sup>	15
MD/DAT deck	
With digital audio output* <sup>1</sup>	12
With analog audio output only* <sup>3</sup>	15
Cassette deck, analog disc turntable	
Multi-channel decoder	
VCR, video camera, video game, etc.	

\*<sup>1</sup> Model with a DIGITAL OPTICAL OUTPUT or DIGITAL COAXIAL OUTPUT connector, etc.

\*<sup>2</sup> Model with a MULTI CH OUTPUT connectors, etc. This connection is used to output the audio decoded by the component’s internal multi-channel decoder through this receiver.

\*<sup>3</sup> Model equipped only with AUDIO OUT L/R jacks, etc.

\*<sup>4</sup> Model with component video (Y, B-Y, R-Y) input jacks.



## Required cords

The hookup diagrams on the subsequent pages assume the use of the following optional connection cords (**A** to **H**) (not supplied).

### **A** Audio cord

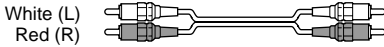

### **B** Audio/video cord

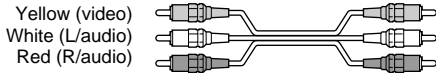

### **C** Video cord



### **D** S-video cord

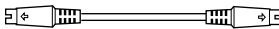

### **E** Optical digital cord



### **F** Coaxial digital cord



### **G** Monaural audio cord



#### Tip

Audio cord **A** can be torn into two monaural audio cords **G**.

### **H** Component video cord

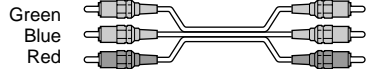

#### Notes

- Turn off the power to all components before making any connections.
- Be sure to make connections firmly to avoid hum and noise.
- When connecting an audio/video cord, be sure to match the color-coded pins to the appropriate jacks on the components: yellow (video) to yellow; white (left, audio) to white; and red (right, audio) to red.
- When connecting optical digital cords, insert the cord plugs straight in until they click into place.
- Do not bend or tie optical digital cords.

If you have a Sony components with CONTROL A1 II/S-LINK jack

See “CONTROL A1 II/S-LINK control system” on page 61.

# 1a: Connecting components with digital audio output jacks

Hooking up a DVD player, LD player, TV, or satellite tuner

For details on the required cords (A–H), see page 9.

1 Connect the audio jacks.

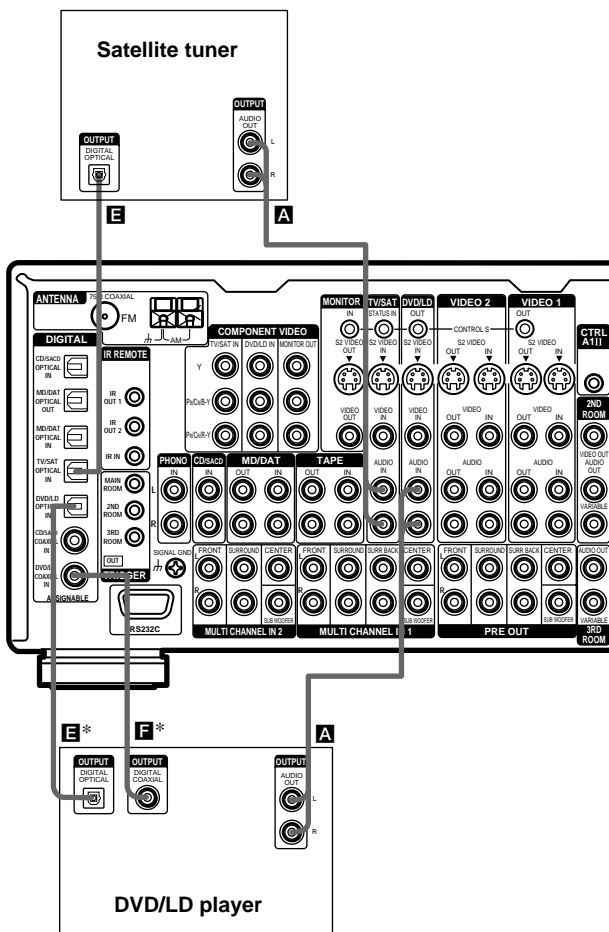

\* Connect to either the COAXIAL IN or the OPTICAL IN jack. We recommend making connections to the COAXIAL IN jack.

## 2 Connect the video jacks.

The following illustration shows how to connect a TV or satellite tuner and a DVD/LD player with COMPONENT VIDEO (Y, B-Y, R-Y) output jacks. Connecting a TV with component video input jacks allows you to enjoy higher quality video.

### Notes

- On this receiver, the component video signals cannot be converted to S-video or standard video signals (or vice versa).
- The on-screen display will not appear on a TV connected to the COMPONENT VIDEO MONITOR OUT jacks even if you press ON SCREEN.

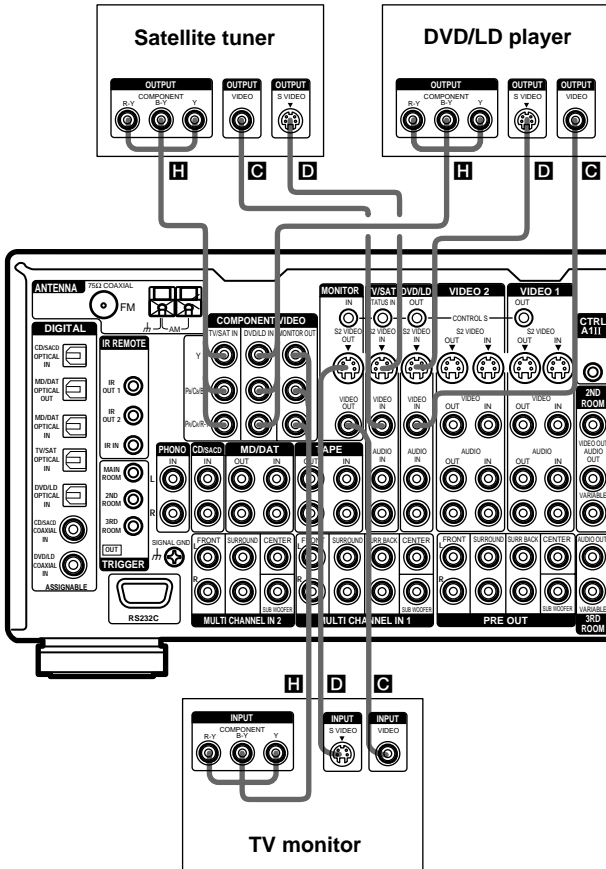

### Tip

When the component is equipped with S-video jacks, you can connect the component to the S2 VIDEO jacks on this receiver. In addition, this receiver can convert standard video signals to S-video signals for output from the MONITOR OUT (S-VIDEO) jacks.

### Note

You can listen to the sound of your TV by connecting your TV's audio output jacks to the TV/SAT AUDIO IN jacks on the receiver. In this case, do not connect the TV's video output jack to the TV/SAT VIDEO IN jack on the receiver. If you connect a separate satellite tuner, etc., connect both the audio and video output jacks to the receiver as shown above.

continued

## 1a: Connecting components with digital audio output jacks (continued)

Hooking up a CD/Super Audio CD player and MD/DAT deck

For details on the required cords (A–H), see page 9.

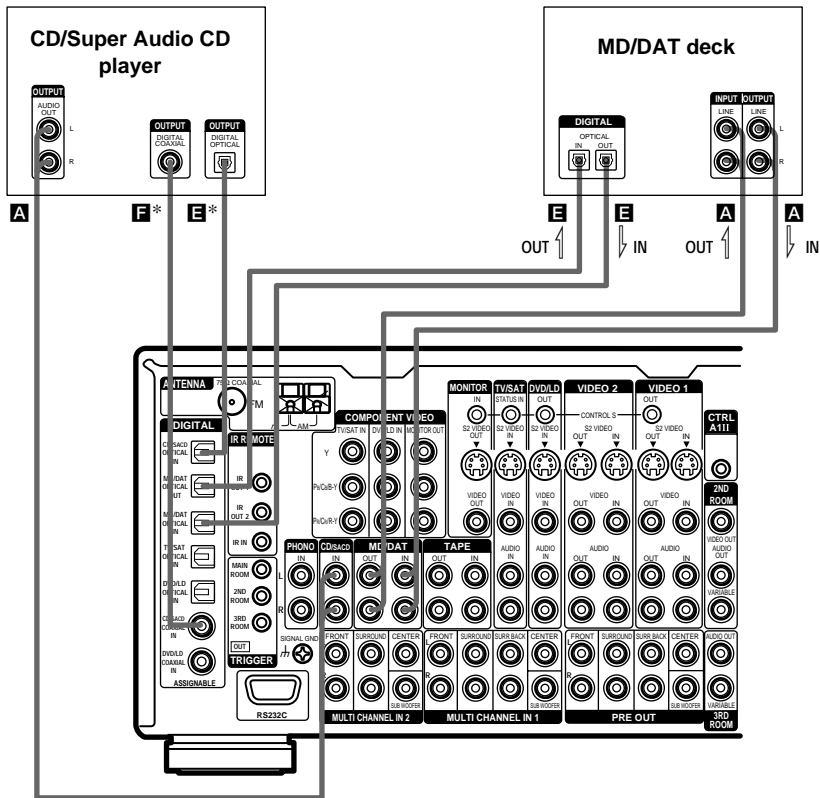

\* Connect to either the COAXIAL IN or the OPTICAL IN jack. We recommend making connections to the COAXIAL IN jack.

If you want to connect several digital components, but cannot find an unused input

See “Assigning the audio input (AUDIO SPLIT)” (page 41).

### Tips

- All the digital audio jacks are compatible with 32 kHz, 44.1 kHz, 48 kHz and 96 kHz sampling frequencies.
- You can also connect an LD player with a DOLBY DIGITAL RF OUT jack via an RF demodulator (You cannot connect an LD player’s DOLBY DIGITAL RF OUT jack directly to this unit’s digital input jacks). Refer to the operating instructions supplied with the RF demodulator.

### Notes

- No sound is output when playing a Super Audio CD disc on a Super Audio CD player connected to the CD/SACD OPTICAL or COAXIAL IN jacks on this receiver. Connect the player to the analog input jacks (CD/SACD IN jacks). Refer to the operating instructions supplied with the Super Audio CD player.
- You cannot make digital recordings of digital multi channel surround signals.

# 1b: Connecting components with multi channel output jacks

1 Connect the audio jacks.

If your DVD/LD and CD/Super Audio CD players are equipped with multi channel decoder, you can connect them to this receiver's MULTI CHANNEL IN jacks to enjoy the sound of the connected component's multi channel decoder. Alternatively, the multi channel input jacks can be used to connect an external multi channel decoder.

For details on the required cords (**A-H**), see page 9.

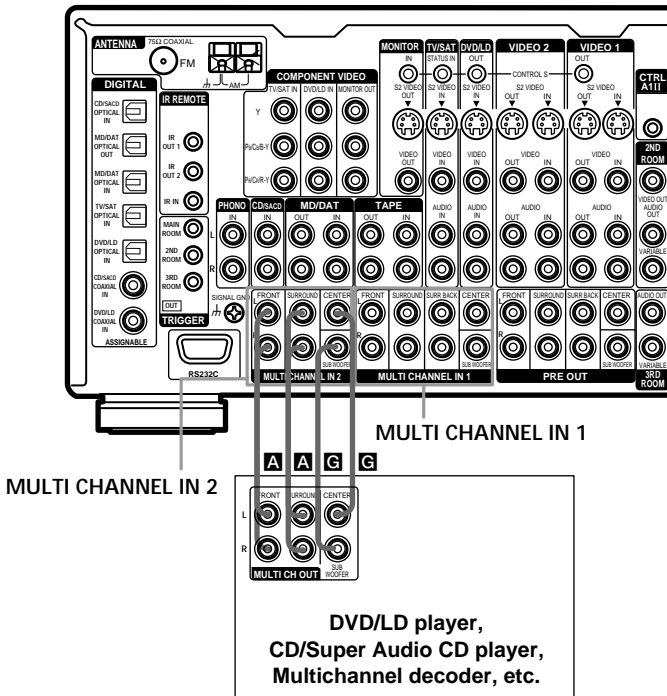

## Tips

- This connection also allows you to enjoy software with multi-channel audio recorded in formats other than the Dolby Digital, DTS and MPEG-2.
- Make connections to either the MULTI CHANNEL IN 1 or 2 jacks according to the number of audio output jacks of the component.

## Note

DVD and Super Audio CD players do not have SURR BACK terminals.

continued

## 1b: Connecting components with multi channel output jacks (continued)

2 Connect the video jacks.

The following illustration shows how to connect a DVD or LD player with COMPONENT VIDEO (Y, B-Y, R-Y) output jacks. Connecting a TV with component video input jacks allows you to enjoy higher quality video.

### Notes

- On this receiver, the component video signals cannot be converted to S-video or standard video signals (or vice versa).
- The on-screen display will not appear on a TV connected to the COMPONENT VIDEO MONITOR OUT jacks even if you press ON SCREEN.

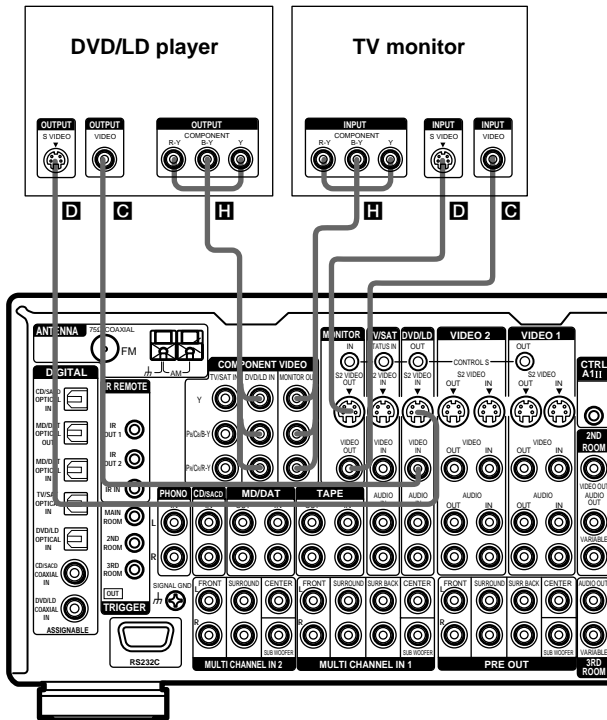

### Tip

When the component is equipped with S-video jacks, you can connect the component to the S2 VIDEO jacks on this receiver. In addition, this receiver can convert standard video signals to S-video signals for output from the MONITOR OUT (S-VIDEO) jacks.

### Note

You can listen to the sound of your TV by connecting your TV's audio output jacks to the TV/SAT AUDIO IN jacks on the receiver. In this case, do not connect the TV's video output jack to the TV/SAT VIDEO IN jack on the receiver. If you connect a separate satellite tuner, etc., connect both the audio and video output jacks to the receiver as shown above.

# 1c: Connecting components with only analog audio jacks

## Hooking up audio components

For details on the required cords (**A-H**), see page 9.

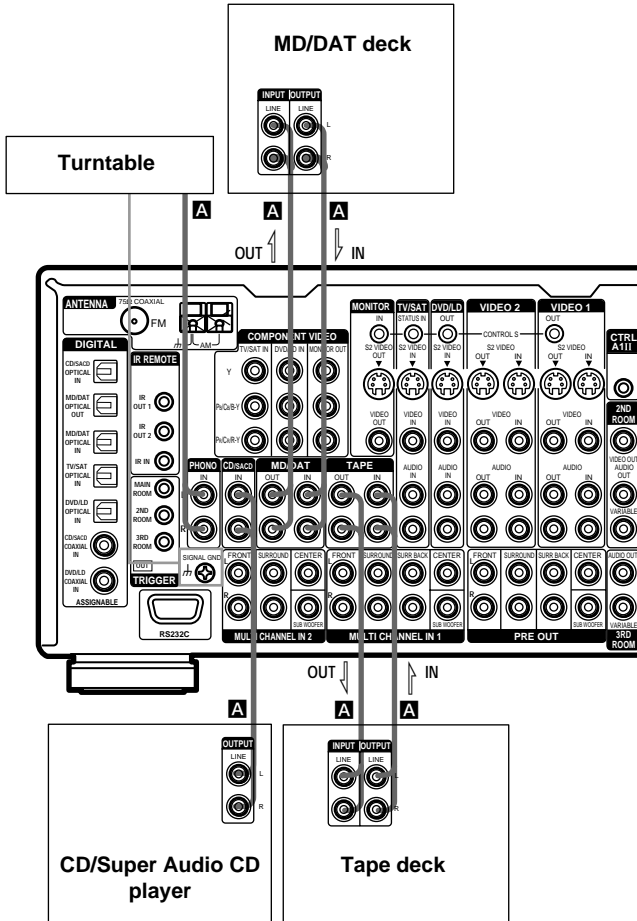

**Note**

If your turntable has a ground wire, connect it to the  $\hbar$  SIGNAL GND terminal.

continued

## 1c: Connecting components with only analog audio jacks (continued)

### Hooking up video components

If you connect your TV to the MONITOR jacks, you can watch the video from the selected input (function) (page 27). In addition, you can display the SET UP, SURROUND, LEVEL, EQ parameters and the selected sound field by pressing ON SCREEN.

For details on the required cords (A-H), see page 9.

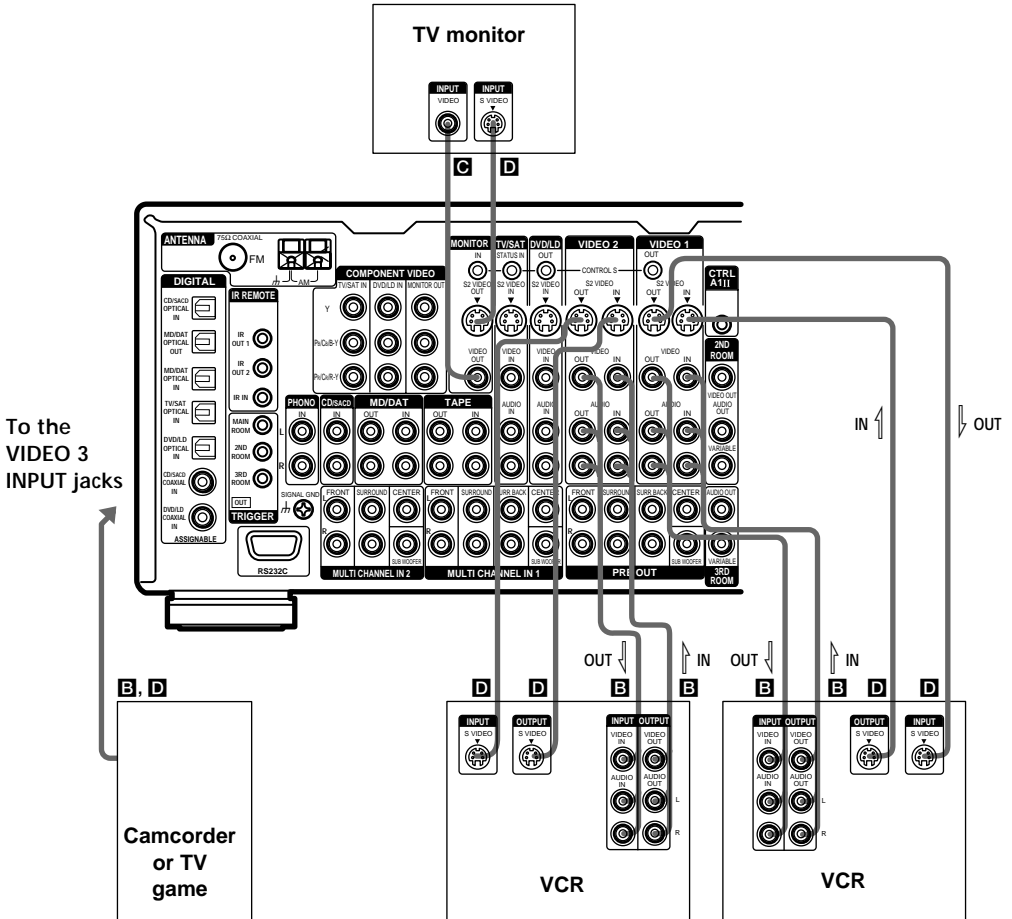

#### Tip

When the component is equipped with S-video jacks, you can connect the component to the S2 VIDEO jacks on this receiver. In addition, this receiver can convert standard video signals to S-video signals for output from the MONITOR OUT (S-VIDEO) jacks.

#### Note

You can listen to the sound of your TV by connecting your TV's audio output jacks to the TV/SAT AUDIO IN jacks on the receiver. In this case, do not connect the TV's video output jack to the TV/SAT VIDEO IN jack on the receiver. If you connect a separate satellite tuner, etc., connect both the audio and video output jacks to the receiver as shown above.



## 2: Connecting the antennas

Connect the supplied AM loop antenna and FM wire antenna.

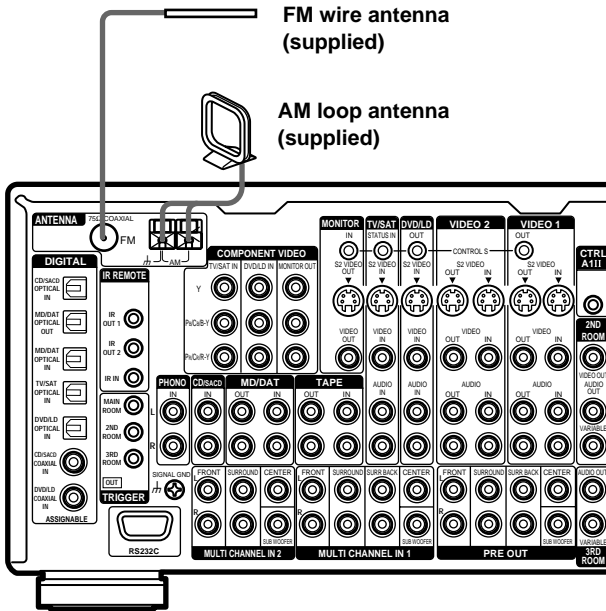

### Notes

- To prevent noise pickup, keep the AM loop antenna away from the receiver and other components.
- Be sure to fully extend the FM wire antenna.
- After connecting the FM wire antenna, keep it as horizontal as possible.
- Do not use the  $\hbar$  SIGNAL GND terminal for grounding the receiver.

## 3: Connecting speakers

Connect your speakers to the receiver. This receiver allows you to use a 7.1 channel speaker system. To fully enjoy theater-like multi channel surround sound requires five speakers (two front speakers, a center speaker, and two surround speakers) and a sub woofer (5.1 channel). You can enjoy high fidelity reproduction of DVD software recorded in the Surround EX format if you connect one additional surround back speaker (6.1 channel) or two additional surround back speakers (7.1 channel). (See “Selecting the surround back decoding mode” on page 39.)

Example of 7.1 channel speaker system configuration

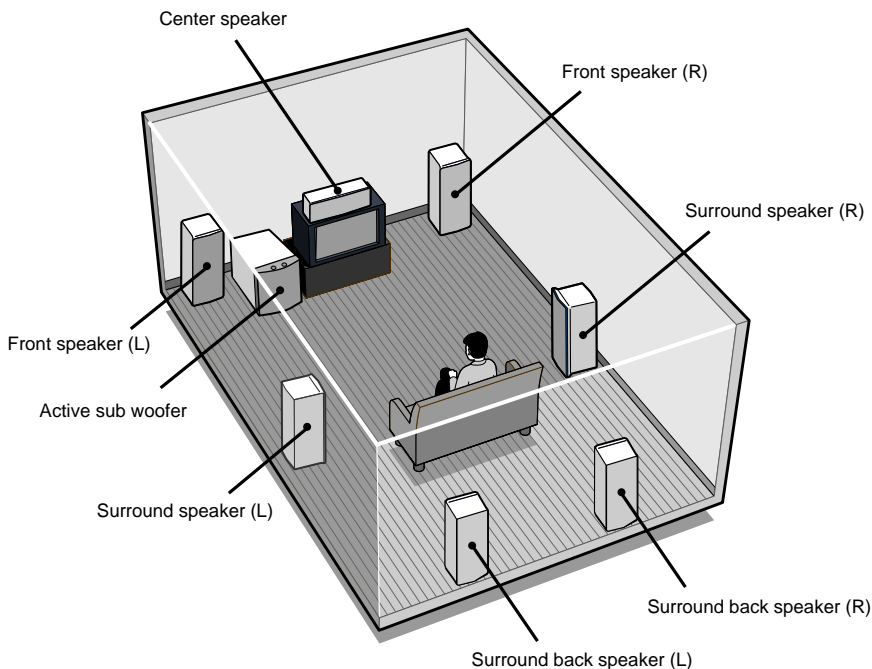

### Tip

Since the active sub woofer does not emit highly directional signals, you can place it wherever you want.

### Speaker impedance

To enjoy the best possible multi channel surround, connect speakers with a nominal impedance of 8 ohms or higher to the FRONT, CENTER, SURROUND and SURROUND BACK terminals, and set the IMPEDANCE SELECTOR to “8Ω”. Refer to the operating instructions supplied with your speakers if you are not sure of their impedance. (This information is often on the back of the speaker.)

Alternatively, you may connect speakers with nominal impedances between 4 and 8 ohms to any or all of the speaker terminals. However, be sure to set the IMPEDANCE SELECTOR to “4Ω” if you connect even one speaker with a nominal impedance between 4 and 8 ohms.

### Note

Be sure to turn the power off before adjusting the IMPEDANCE SELECTOR.

Required cords

**A** Speaker cords (not supplied)

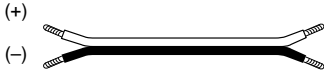

**B** Monaural audio cord (not supplied)



Getting Started

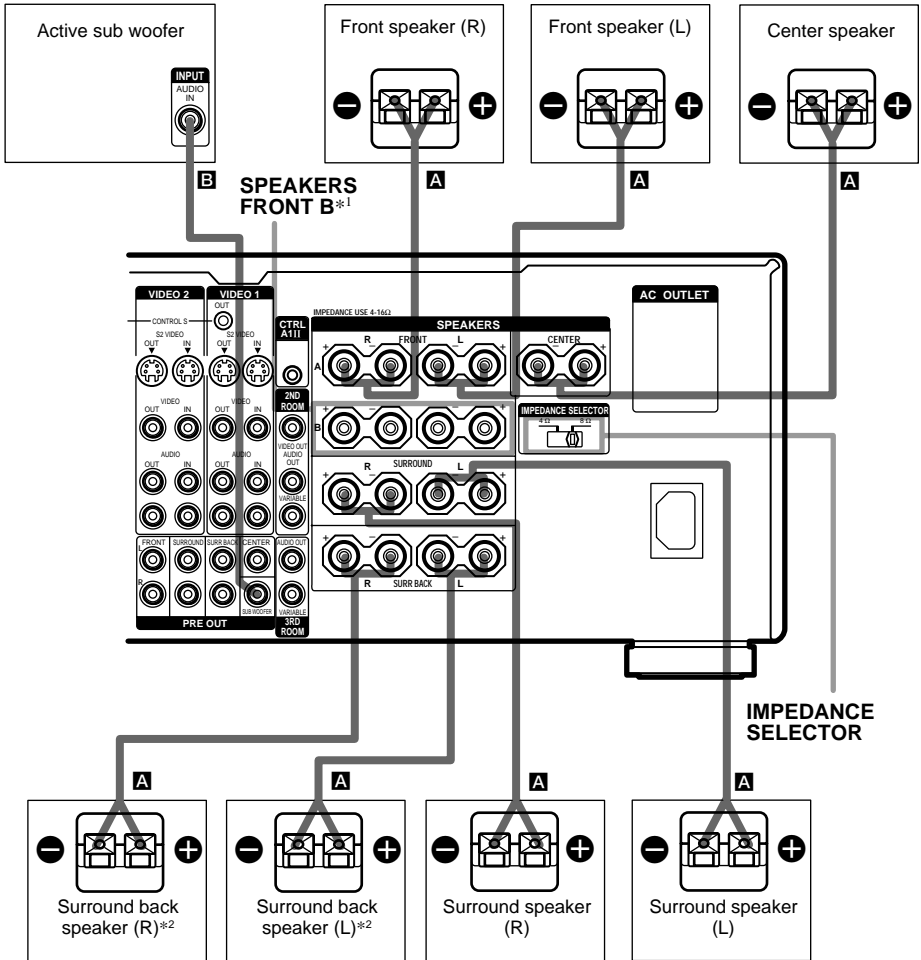

\*1 You can select the font speakers you want to use with the SPEAKERS switch. For details. see “Selecting the speaker system” (page 59).

\*2 If you only plan to connect one surround back speaker, connect it to the SPEAKERS SURR BACK L terminal.

## 4: Connecting the AC power cord

Connect the supplied AC power cord to the AC IN terminal on the receiver, then connect the AC power cord to a wall outlet.

You can connect up to one component to the AC OUTLET(s) on the receiver.

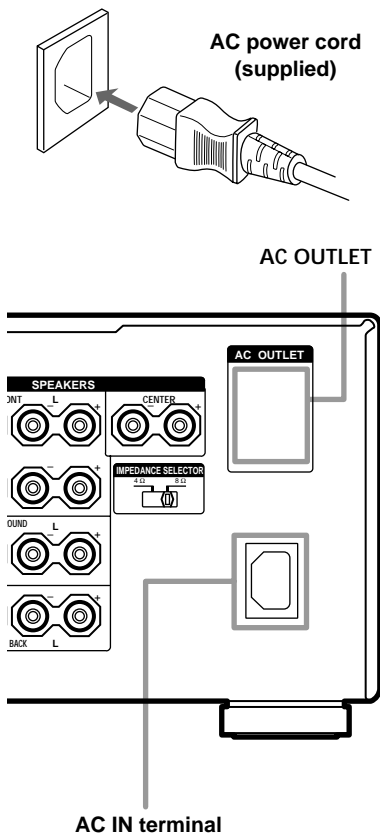

### Notes

- The AC OUTLET(s) on the rear of the receiver is a switched outlet, which supplies power to the connected component only while the receiver is turned on.
- Make sure that the total power consumption of the component(s) connected to the receiver's AC OUTLET(s) does not exceed the wattage stated on the rear panel. Do not connect high-wattage electrical home appliances such as electric irons, fans, or TVs to this outlet. This may cause a malfunction.

## Performing initial setup operations

Before using the receiver for the first time, initialize the receiver by performing the following procedure.

This procedure can also be used to return settings you have made to their factory defaults.

- 1 Press I/⏻ to turn off the receiver.
- 2 Hold down I/⏻ for 5 seconds.  
“ENTER to Clear All” appears in the display.
- 3 Press DOOR OPEN to open the door of the front panel, then press ENTER.

After “MEMORY CLEARING...” appears in the display for a while, “MEMORY CLEARED!” appears.

The following are reset to their factory settings.

- All settings in the SET UP, CUSTOMIZE, SURROUND, LEVEL, and EQ menus.
- The sound field memorized for each function and preset station.
- All preset stations.
- All index names for functions and preset stations.

## 5: Setting up the speakers

Use the SET UP menu to set the types and sizes of the speakers connected to the receiver.

- 1 Press I/⏻ to turn on the receiver.
- 2 Press SET UP.  
The SET UP button lights up and the first SET UP parameter appears in the display.
- 3 Press the cursor buttons (< or >) to select the speaker.  
For details, see “Speaker setup parameters” below.

### Notes

- Certain setup parameters may be dimmed in the display. This means that the selected parameter is either unavailable or fixed and unchangeable due to sound field (pages 35–37) or other settings.
- Some speaker settings may appear dimmed in the display. This means that they have been changed automatically due to other speaker settings. The dimmed settings may or may not be adjustable.

- 4 Turn the jog dial to select the parameter.
- 5 Repeat steps 3 and 4 until you have set all of the items that follow.

### Speaker setup parameters

The initial setting is underlined.

#### ■ FRONT SP (Front speaker size)

- LARGE  
If you connect large speakers that will effectively reproduce bass frequencies, select “LARGE”. Normally, select “LARGE”.
- SMALL  
If the sound is distorted, or you feel a lack of surround effects when using multi channel surround sound, select “SMALL” to activate the bass redirection circuitry and output the front channel bass frequencies from the sub woofer. When the front speakers are set to “SMALL”, the center, surround, and surround back speakers are also automatically set to “SMALL” (unless previously set to “NO”).

continued

## 5: Setting up the speakers (continued)

### ■ CENTER SP (Center speaker size)

- LARGE  
If you connect a large speaker that will effectively reproduce bass frequencies, select “LARGE”. Normally, select “LARGE”. However, if the front speakers are set to “SMALL”, you cannot set the center speaker to “LARGE”.
- SMALL  
If the sound is distorted, or you feel a lack of surround effects when using multi channel surround sound, select “SMALL” to activate the bass redirection circuitry and output the center channel bass frequencies from the front speakers (if set to “LARGE”) or sub woofer.
- NO (for all sources except MULTI CH 1/2)  
If you did not connect a center speaker, select “NO”. The sound of the center channel will be output from the front speakers (digital downmix).
- MIX (for all sources except MULTI CH 1/2)  
If you did not connect a center speaker but want to downmix the center channel audio, select “MIX”.  
This is only active when the front, surround, and surround back speakers are set to “LARGE” (ANALOG DOWNMIX). When all speakers are not set to “LARGE”, the center channel will be downmixed digitally (DIGITAL DOWNMIX).
- \* When using MULTI CH 1/2 sources, the sound of the center channel is output from the front speakers if you select either “NO” or “MIX”.

### ■ SURROUND SP (Surround speaker size)

- LARGE  
If you connect large speakers that will effectively reproduce bass frequencies, select “LARGE”. Normally, select “LARGE”. However, if the front speakers are set to “SMALL”, you cannot set the surround speakers to “LARGE”.
- SMALL  
If the sound is distorted, or you feel a lack of surround effects when using multi channel surround sound, select “SMALL” to activate the bass redirection circuitry and output the surround channel bass frequencies from the sub woofer or other “LARGE” speakers.
- NO  
If you did not connect surround speakers, select “NO”. When the surround speakers are set to “NO”, the surround back speakers are also automatically set to “NO”.

### ■ SURR BACK SP (Surround back speaker size)

When the surround speakers are set to “NO”, the surround back speakers are also automatically set to “NO” and the setting cannot be changed.

- **LARGE**  
If you connect a large speaker that will effectively reproduce bass frequencies, select “LARGE”. Normally, select “LARGE”. However, if the front speakers are set to “SMALL”, you cannot set the surround back speaker to “LARGE”.
- **SMALL**  
If the sound is distorted, or you feel a lack of surround effects when using multi channel surround sound, select “SMALL” to activate the bass redirection circuitry and output the surround back channel bass frequencies from the front speakers (if set to “LARGE”) or sub woofer.
- **NO**  
If you did not connect a surround back speaker, select “NO”.

#### Tip

The LARGE and SMALL settings for each speaker determine whether or not the internal sound processor will cut the bass signal from that channel. When the bass is cut from a channel, the bass redirection circuitry sends the corresponding bass frequencies to the sub woofer or other “LARGE” speakers.

However, since bass has a certain amount of directionality, it best not to cut them, if possible. Therefore, even when using small speakers, you can set them to “LARGE” if you want to output the bass frequencies from that speaker. On the other hand, if you are using a large speaker, but prefer not to have bass frequencies output from that speaker, set it to “SMALL”.

If the overall sound level is lower than you prefer, set all speakers to “LARGE”. If there is not enough bass, you can use the equalizer to boost the bass levels. To adjust the equalizer, see page 45.

### ■ SURR BACK L/R (7.1 channel/ 6.1 channel switching)

- **YES**  
If you connect two surround back speakers, select “YES”. The sound will be output to a maximum of 7.1 channels.
- **NO**  
If you connect only one surround back speaker, select “NO”. The sound will be output to a maximum of 6.1 channels.

### ■ SUB WOOFER (Sub woofer selection)

- **YES**  
If you connect a sub woofer, select “YES”.
- **NO**  
If you did not connect a sub woofer, select “NO”. This activates the bass redirection circuitry and outputs the LFE signals from other speakers.

#### Tip

In order to take full advantage of the Dolby Digital bass redirection circuitry, we recommend setting the sub woofer’s cut off frequency as high as possible.

**continued**

## 5: Setting up the speakers (continued)

### ■ FRONT XX feet (Front speaker distance)

Initial setting: 16 feet

Lets you set the distance from your listening position to the front speakers (A). You can adjust from 3 feet to 40 feet in 1 foot steps.

If both front speakers are not placed an equal distance from your listening position, set the distance to the closest speaker.

When placing surround speakers to your side (long room)

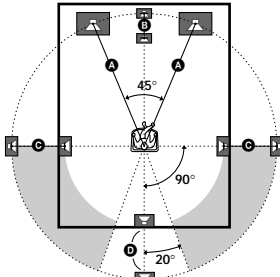

When placing surround speakers behind you (wide room)

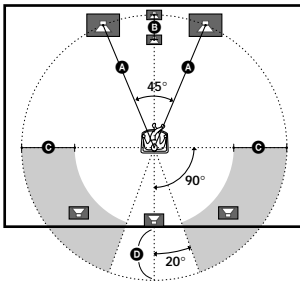

### ■ CENTER XX feet (Center speaker distance)

Initial setting: 16 feet

Lets you set the distance from your listening position to the center speaker. You can adjust from a distance equal to the front speaker distance (A) to a distance 5 feet closer to your listening position (B) in 1 foot steps.

When this range is exceeded, the display blinks. If you select a setting while the display is blinking, you will not be able to enjoy full surround effects.

### ■ SURROUND XX feet (Surround speaker distance)

Initial setting: 16 feet

Lets you set the distance from your listening position to the surround speakers. You can adjust from a distance equal to the front speaker distance (A) to a distance 15 feet closer to your listening position (C) in 1 foot steps.

When this range is exceeded, the display blinks. If you select a setting while the display is blinking, you will not be able to enjoy full surround effects.

If both surround speakers are not placed an equal distance from your listening position, set the distance to the closest speaker.

### ■ SURR BACK XX feet (Surround back speaker distance)

Initial setting: 16 feet

Lets you set the distance from your listening position to the surround back speakers. You can adjust from 3 feet to 40 feet in 1 foot steps.

If both surround back speakers are not placed an equal distance from your listening position, set the distance to the closest speaker.

### ■ SUB WOOFER XX feet (Sub woofer distance)

Initial setting: 16 feet

Lets you set the distance from your listening position to the sub woofer. You can adjust from 3 feet to 40 feet in 1 foot steps.



**Tip**

The receiver lets you to input the speaker position in terms of distance. However, it is not possible to set the center speaker further than the front speakers. Also, the center speaker cannot be set more than 5 feet closer than the front speakers.

Likewise, the surround speakers can not be set farther away from the listening position than the front speakers. And they can be no more than 15 feet closer.

This is because incorrect speaker placement is not conducive to the enjoyment of surround sound.

Please note that, setting the speaker distance closer than the actual location of the speakers will cause a delay in the output of the sound from that speaker. In other words, the speaker will sound like it is farther away.

For example, setting the center speaker distance 3–6 feet closer than the actual speaker position will create a fairly realistic sensation of being “inside” the screen. If you cannot obtain a satisfactory surround effect because the surround speakers are too close, setting the surround speaker distance closer (shorter) than the actual distance will create a larger sound stage.

Adjusting these parameter while listening to the sound often results in much better surround sound. Give it a try!

**For advanced speaker setups**

Use the CUSTOMIZE menu and set “MENU EXPAND” to “ON”. This enables advanced setups including those of the distances to the speakers and heights of the speakers.

For details on “MENU EXPAND”, see page 47. For details on how to set the items, see page 49.

## 6: Adjusting the speaker levels and balance

### (TEST TONE)

Adjust the speaker levels and balance while listening the test tone from your listening position. Use the remote for the operation.

#### Tips

- The receiver employs a test tone with a frequency centered at 800 Hz.
- Although these adjustments can also be made via the LEVEL button on the front panel, we recommend you follow the procedure described below and make adjustments from your listening position using the remote.

**1 Press I/⏻ on the remote to turn on the receiver.**

**2 Press TEST TONE on the remote.**

“TEST TONE” in the LEVEL menu appears in the display and the test tone is output from each speaker in sequence.

**3 Adjust the speaker level and balance using the LEVEL menu so that the level of the test tone sounds the same from each speaker.**

For details on the LEVEL menu settings, see page 44.

#### Tips

- To adjust the level of all speakers at the same time, press MASTER VOL +/- on the remote or turn MASTER VOLUME on the receiver.
- You can also use the jog dial on the receiver for the adjustment.

**4 Press TEST TONE again after adjustment.**

The test tone turns off.

To output the test tone only from a specific speaker

Set “TEST TONE” in the LEVEL menu to “FIX” (page 44). The test tone is output only from the selected speaker.

For more precise adjustment

You can output the test tone or sound source from two adjacent speakers to adjust their balance and level.

Set “T.TONE” in the CUSTOMIZE menu to “PHASE NOISE” or “PHASE AUDIO” (page 48). Then select the two speakers you want to adjust using “PHASE NOISE” or “PHASE AUDIO” in the LEVEL menu (page 44).

#### Note

When you select analog audio using the MULTI CH DIRECT or ANALOG DIRECT buttons, the power to the digital circuits is turned off.\* When you output the test tone in this setting, it takes a few seconds to output the test tone. This, however, is not a malfunction.

\* When “D.POWER” in the CUSTOMIZE menu is set to “AUTO OFF” (page 47).

## Selecting the component

### 1 Rotate **FUNCTION** to select the function.

The selected function appears in the display.

To select the	Display
VCR	VIDEO 1 or VIDEO 2
Camcorder or TV game	VIDEO 3
DVD or LD player	DVD/LD
Satellite tuner	TV/SAT
Tape deck	TAPE
MD or DAT deck	MD/DAT
CD or Super Audio CD player	CD/SACD
Built in tuner	TUNER
Turntable	PHONO

### 2 Turn on the component and start playback.

When you select a component which is also connected to the TV (such as VCR or DVD player), turn on the TV and set the TV's video input to match the component you selected.

If your TV is connected to the receiver's MONITOR jack, the video from the selected function will be displayed on the TV.

### 3 Rotate **MASTER VOLUME** to adjust the volume.

To mute the sound  
Press **MUTING**.

Notes on using headphones

- When headphones are connected, you can select only the following sound fields (page 35).
  - HEADPHONE (2CH)
  - HEADPHONE (DIRECT)
  - HEADPHONE (MULTI1)
  - HEADPHONE (MULTI2)
  - HEADPHONE THEATER
- When headphones are connected and you use the MULTI CH DIRECT function with center speaker (CENTER SP) set to "NO" or "MIX", and sub woofer (SUB WOOFER) set to "NO", only the front L/R signals of the multi channel sound are output from the headphones.  
To listen to the sound of all channels, press one of the other sound field buttons to cancel the MULTI CH DIRECT function.

## Listening to multi channel sound

### **(MULTI CH DIRECT)**

You can select the audio directly from the components connected to the MULTI CHANNEL IN jacks. This function enables you to enjoy high quality analog sources like DVD or Super Audio CD.

Also see “D.POWER” on page 47.

Surround effects are not activated when using this function.

**Press MULTI CH DIRECT repeatedly to select the multi channel audio source (“MULTI CH 1 DIRECT” or “MULTI CH 2 DIRECT”).**

The selected audio source is output.

#### Note

This function is canceled when you switch the function (page 27) or sound field (pages 35–37).

When the center speaker or sub woofer is not connected (Analog downmix function)

If you set the center speaker size (CENTER SP) or sub woofer selection (SUB WOOFER) in the SET UP menu to “NO” or “MIX” (CENTER SP only) (page 22) and activate the MULTI CH DIRECT function, the analog center or sub woofer audio will be downmixed to the FRONT L/R channel audio.

To assign the multi channel audio to a specific function

Set “MULTI CH 1” or “MULTI CH 2” in the CUSTOMIZE menu (page 47). The multi channel audio inputs can be assigned to any functions except TUNER and PHONO.

## Listening to FM/AM radio

You can listen to FM and AM broadcasts through the built-in tuner. Before operation, make sure you have connected the FM and AM antennas to the receiver (see page 17).

#### Tip

The tuning scale is:

FM: 100 kHz

AM: 10 kHz\*

\* The AM tuning scale can be changed (see page 79).

### Automatic tuning

- 1 Rotate FUNCTION to switch the function to TUNER.**
- 2 Press FM/AM to select the FM or AM band.**
- 3 Press TUNING + or –.**

Press + to scan from low to high; press – to scan from high to low.

The receiver stops scanning whenever a station is received.

In case of poor FM stereo reception Press FM MODE to switch to monaural audio. If the FM stereo reception is poor and “STEREO” flashes in the display, select the monaural audio so that the sound will be less distorted.

## Direct tuning

Enter a frequency of the station directly by using the remote.

For details on the supplied remote, refer to the operating instructions supplied with the remote.

### STR-DA7ES

Use the supplied remote RM-TP1.

#### 1 Touch RM SELECT.

The RM SELECT screen appears.

#### 2 Touch AMP.

The screen for operating the receiver appears.

#### 3 Touch TUNER.

The receiver switches to the TUNER input.

#### 4 Touch ◀ to return to the RM SELECT screen.

#### 5 Touch TUNER in the RM SELECT screen.

#### 6 Touch FM/AM to select the FM or AM band.

You can also use the FM/AM button on the receiver.

#### 7 Touch ➡ to display screen 2/3.

#### 8 Touch DIRECT.

#### 9 Touch the numeric buttons to enter the frequency.

Example 1: FM 102.50 MHz

Touch 1 ➡ 0 ➡ 2 ➡ 5 ➡ 0

Example 2: AM 1,350 kHz

(You don't have to enter the last "0" when the tuning scale is set to 10 kHz.)

Touch 1 ➡ 3 ➡ 5 ➡ 0

If you've tuned in an AM station, adjust the direction of the AM loop antenna for optimum reception.

### STR-DA4ES

Use the supplied remote RM-LP211.

#### 1 Select "TUNER" from the FUNCTION list to switch the function to TUNER.

You can also use the FUNCTION control on the receiver.

#### 2 Select "FM/AM" from the SUB menu to select the FM or AM band.

You can also use the FM/AM button on the receiver.

#### 3 Select "DIRECT TUNING" from the SUB menu.

#### 4 Select the numbers for the frequency using the NUM menu.

Example 1: FM 102.50 MHz

Press 1 ➡ 0 ➡ 2 ➡ 5 ➡ 0

Example 2: AM 1,350 kHz

(You don't have to enter the last "0" when the tuning scale is set to 10 kHz.)

Press 1 ➡ 3 ➡ 5 ➡ 0

If you've tuned in an AM station, adjust the direction of the AM loop antenna for optimum reception.

If you cannot tune in a station and the entered numbers flash

Make sure you've entered the right frequency.

If not, repeat steps 3 and 4. If the entered numbers still flash, the frequency is not used in your area.

## Presetting radio stations

You can preset up to 30 FM or AM stations. Then you can easily tune in the stations you often listen to.

### Presetting radio stations

- 1 Rotate FUNCTION to switch the function to TUNER.**
- 2 Tune in the station that you want to preset using Automatic Tuning (page 28) or Direct Tuning (page 29).**
- 3 Press MEMORY.**  
“MEMORY” appears in the display for a few seconds. Do steps 4 to 5 before the display goes out.
- 4 Press PRESET TUNING + or – to select a preset number.**  
If “MEMORY” goes out before you select the preset number, start again from step 3.
- 5 Press MEMORY again.**  
The station is stored to the selected preset number.  
If “MEMORY” goes out before you press MEMORY, start again from step 3.
- 6 Repeat steps 2 to 5 to preset another station.**

### Tuning to preset stations

Using the receiver

- 1 Rotate FUNCTION to switch the function to TUNER.**  
The last received station is tuned in.
- 2 Press PRESET TUNING + or – repeatedly to select the preset station you want.**  
Each time you press the button, you can select the preset station as follows:

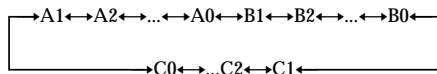

Using the remote

STR-DA7ES

Use the supplied remote RM-TP1.

- 1 Touch RM SELECT.**  
The RM SELECT screen appears.
- 2 Touch AMP.**  
The screen for operating the receiver appears.
- 3 Touch TUNER.**  
The receiver switches to the TUNER input.
- 4 Touch ◀ to return to the RM SELECT screen.**
- 5 Touch TUNER in the RM SELECT screen.**
- 6 Touch SHIFT repeatedly to select A, B or C.**
- 7 Touch PRESET +/- repeatedly to select the preset station you want.**  
You can also select the preset stations directly. Do the following after step 5 (above).
  - 1 Touch ▶ to the display screen 2/3.**
  - 2 Touch A, B, or C.**
  - 3 Touch the numeric buttons to enter the preset number.**

STR-DA4ES

Use the supplied remote RM-LP211.

- 1 Select “TUNER” from the FUNCTION list to switch the function to TUNER.**
- 2 Move the easy scroll key to select the preset number you want, then press the key to enter the selection.**

## Changing the display

### Changing the information in the display

You can check the volume, sound field, or the decoding information by changing the information in the display.

#### Press DISPLAY repeatedly.

The displayed information varies according to the selected function.

All functions except TUNER

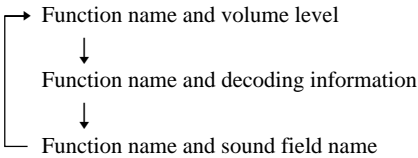

All functions except TUNER  
(When the function name is indexed)  
(page 58)

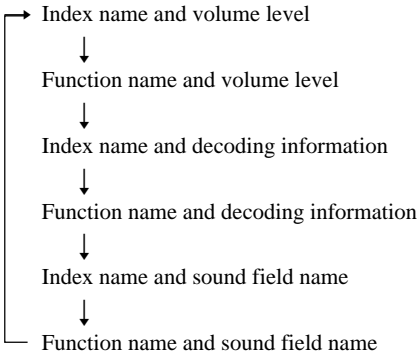

### TUNER

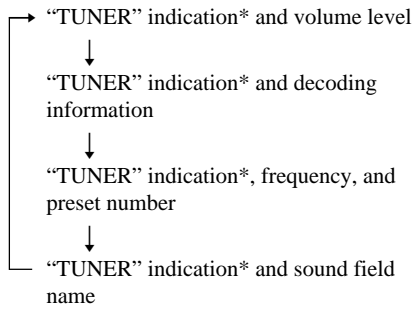

\* When you have entered names to the preset stations (page 58), the index name appears instead of the "TUNER" indication.

### Changing the brightness of the display

#### Press DIMMER repeatedly.

The DIMMER button lights up and the brightness of the display changes in 6 steps. When you set to "[ ]" (the display is turned off), the MULTI CH DECODING indicator is also turned off.

## About the indications in the display

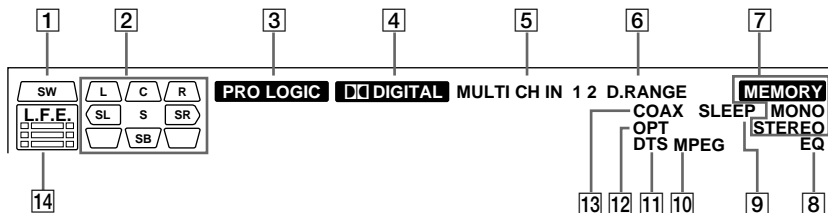

- 1 SW:** Lights up when sub woofer selection is set to “YES” and the receiver detects that the disc being played back does not contain the LFE channel signal. While this indicator lights up, the receiver creates a sub woofer signal based on the low frequency components of the front channels.
- 2 Playback channel indicators:** The letters (L, C, R, etc.) indicate the channels being played back. The boxes around the letters vary to show how the receiver downmixes the source sound (based on the speakers settings). When using sound fields like “D.CONCERT HALL”, the receiver adds reverberation based on the source sound.  
L (Front Left), R (Front Right), C (Center (monaural)), SL (Surround Left), SR (Surround Right), S (Surround (monaural or the surround components obtained by Pro Logic processing)), SB (Surround Back (the surround back components obtained by 6.1 channel decoding)), SBL (Surround Back Left), SBR (Surround Back Right)  
**Example:**  
Recording format (Front/Surround): 3/2  
Output channel: Surround speakers absent  
Sound Field: AUTO DECODING.
- 3 PRO LOGIC:** Lights up when the receiver applies Pro Logic processing to 2 channel signals in order to output the center and surround channel signals. However, this indicator also lights when the Pro Logic II movie/music decoder is in active. However, this indicator does not light if the center and surround speakers are set to “NO”.
- 4 DIGITAL:** Lights up when the receiver is decoding signals recorded in the Dolby Digital format.
- 5 MULTI CH IN 1/2:** Lights up when MULTI CH IN 1 or 2 is selected.
- 6 D.RANGE:** Lights up when dynamic range compression is activated. See page 55 to adjust the dynamic range compression.
- 7 Tuner indicators:** Light up when using the receiver to tune in radio stations, etc. See pages 28–30 for tuner operations.
- 8 EQ:** Lights up when the equalizer is functioning.
- 9 SLEEP:** Lights up when sleep timer is activated.

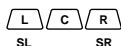



- 10 MPEG:** Lights up when MPEG signals are input.
- Note  
Only the front 2 channels are compatible with MPEG format. Multi channel surround sound is downmixed and output from the front 2 channels.
- 11 DTS:** Lights up when DTS signals are input. When playing a DTS format disc, be sure that you have made digital connections and that INPUT MODE is NOT set to ANALOG 2CH FIXED (see page 42).
- 12 OPT:** Lights up when the source signal is a digital signal being input through the OPTICAL terminal.
- 13 COAX:** Lights up when the source signal is a digital signal being input through the COAXIAL terminal.
- 14 L.F.E.:** Lights up when the disc being played back contains the LFE (Low Frequency Effect) channel. When the sound of the LFE channel signal is actually being reproduced, the bars underneath the letters lights up to indicate the level. Since the LFE signal is not recorded in all parts of the input signal the bar indication will fluctuate (and may turn off) during playback.

## Automatically decoding the input audio signal

### **(AUTO DECODING)**

In this mode, the receiver automatically detects the type of audio signal being input (Dolby Digital, DTS, standard 2 channel stereo, etc) and performs the proper decoding if necessary. This mode presents the sound as it was recorded/encoded, without adding any surround effects.

If you connect an active sub woofer

When the audio signal is 2 channel stereo or if the source signal does not include a LFE signal, the receiver generates a low frequency signal for output to the sub woofer.

#### **Press AUTO DEC.**

“AUTO DECODING” appears in the display and the receiver switches to the AUTO DECODING mode.

#### **Tip**

In most cases AUTO DECODING provides the most appropriate decoding. However, when playing software encoded in the Dolby Digital EX format, you may want to use SURR BACK DECODING (page 39) to match the input stream to the mode you prefer.

## Using only the front speakers

In this mode, the receiver outputs the sound from the front L/R speakers only. There is no sound from the sub woofer.

### Listening to 2 channel stereo sources (2CH STEREO)

Standard 2 channel stereo sources completely bypass the sound field processing and multi channel surround formats are downmixed to 2 channel.

#### **Press 2CH STEREO.**

“2CH STEREO” appears in the display and the receiver switches to the 2CH STEREO mode.

#### **Note**

No sound is output from the sub woofer in the 2CH STEREO mode. To listen to the 2 channel stereo sources using the front L/R speakers and a sub woofer, set to the AUTO DECODING mode.

### Listening to analog audio (ANALOG DIRECT)

You can switch the audio of the selected function to the two channel analog input. This function enables you to enjoy high quality analog sources. Also see “D.POWER” on page 47.

When using this function, only the volume and front speaker balance can be adjusted.

**1 Rotate FUNCTION to select the function you want to listen to in analog audio.**

**2 Press ANALOG DIRECT.**

“ANALOG DIRECT” appears in the display and the analog audio is output.

#### **Note**

This function is canceled when you switch the sound field (pages 35–37).

## Selecting a sound field

You can take advantage of surround sound simply by selecting one of the receiver's pre-programmed sound fields. They bring the exciting and powerful sound of movie theaters and concert halls into your home.

### Sound field list

NORMAL SURROUND
CINEMA STUDIO EX A <b>DCS</b>
CINEMA STUDIO EX B <b>DCS</b>
CINEMA STUDIO EX C <b>DCS</b>
MONO MOVIE
STEREO MOVIE
D.CONCERT HALL A
D.CONCERT HALL B
CHURCH
OPERA HOUSE
JAZZ CLUB
DISCO/CLUB
LIVE CONCERT
ARENA
STADIUM
GAME

About DCS (Digital Cinema Sound) Sound fields with **DCS** marks use DCS technology.

DCS is the concept name of the surround technology for home theater developed by Sony. DCS uses the DSP (Digital Signal Processor) technology to reproduce the sound characteristics of an actual cinema cutting studio in Hollywood.

When played at home, DCS will create a powerful theater effect that mimics the artistic combination of sound and action as envisioned by the movie director.

## Enjoying movies using the CINEMA STUDIO EX modes

CINEMA STUDIO EX modes are suitable for watching motion picture DVDs (etc.), with multi channel surround effects. You can reproduce the sound characteristics of Sony Pictures Entertainment's dubbing studio in your home.

**Press CINEMA STUDIO EX repeatedly to select the CINEMA STUDIO EX mode you want.**

The selected CINEMA STUDIO EX mode appears in the display.

### ■ CINEMA STUDIO EX A **DCS**

Reproduces the sound characteristics of the Sony Pictures Entertainment "Cary Grant Theater" cinema production studio. This is a standard mode, great for watching most any type of movies.

### ■ CINEMA STUDIO EX B **DCS**

Reproduces the sound characteristics of the Sony Pictures Entertainment "Kim Novak Theater" cinema production studio. This mode is ideal for watching science-fiction or action movies with lots of sound effects.

### ■ CINEMA STUDIO EX C **DCS**

Reproduces the sound characteristics of the Sony Pictures Entertainment scoring stage. This mode is ideal for watching musicals or films where orchestra music is featured in the soundtrack.

continued

## Selecting a sound field (continued)



About CINEMA STUDIO EX modes

The CINEMA STUDIO EX modes consist of the following three elements.

- **Virtual Multi Dimension**  
Creates 5 sets of virtual speakers from a single pair of actual surround speakers.
- **Screen Depth Matching**  
Creates the sensation that the sound is coming from inside the screen like in theaters.
- **Cinema Studio Reverberation**  
Reproduces the type of reverberation found in theaters.

The CINEMA STUDIO EX modes integrate these three elements simultaneously.

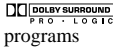
Tips

- You can also select the CINEMA STUDIO EX mode by pressing MODE +/- repeatedly.
- You can identify the encoding format of DVD software, etc. by looking at the logo on the package.
  - : Dolby Digital discs
  - : Dolby Surround encoded programs
  - : DTS Digital Surround encoded programs

Notes

- The effects provided by the virtual speakers may cause increased noise in the playback signal.
- When listening with sound fields that employ the virtual speakers, you will not be able to hear any sound coming directly from the surround speakers.

## Selecting the DIGITAL CONCERT HALL modes

These modes reproduce the acoustics of a concert hall by applying multi-speaker system dynamics to 2 channel audio signals, like those from CDs, etc.

**Press MODE +/- repeatedly to select the DIGITAL CONCERT HALL mode you want.**

The selected mode appears in the display.

### ■ D.CONCERT HALL A

Uses 3D sound imaging to reproduce the sound characteristics of the CONCERTGEBOUW in Amsterdam, which is famous for a large sound stage produced by reflectivity.

### ■ D.CONCERT HALL B

Uses 3D sound imaging to reproduce the sound characteristics of the MUSIKVEREIN in Vienna, which is famous for its hall resonance and unique reverberative sound.

## Selecting other sound fields

**Press MODE +/- repeatedly to select the sound field you want.**

The selected sound field appears in the display.

### ■ NORMAL SURROUND

Software with multi channel surround audio signals is played back according to the way it was recorded. This sound field reproduces the acoustics of a small rectangular concert hall. For software with 2 channel audio signals, you can select from a variety of decoding modes according to the 2CH MODE setting.

### ■ MONO MOVIE

Creates a theater like environment from movies with monaural soundtracks.

### ■ STEREO MOVIE

Creates a theater like environment from movies recorded with stereo soundtracks.

### ■ CHURCH

Reproduces the acoustics of a stone church.

### ■ OPERA HOUSE

Reproduces the acoustics of an opera house.

### ■ JAZZ CLUB

Reproduces the acoustics of a jazz club.

### ■ DISCO/CLUB

Reproduces the acoustics of a discotheque/dance club.

### ■ LIVE CONCERT

Reproduces the acoustics of a 300-seat live house.

### ■ ARENA

Reproduces the acoustics of a 1,000-seat concert hall.

### ■ STADIUM

Reproduces the feeling of a large open-air stadium.

### ■ GAME

Obtains maximum audio impact from TV game software.

When the headphones are connected You can select only from the following sound fields.

### ■ HEADPHONE (2CH)

Outputs the sound in 2 channel (stereo). Standard 2 channel stereo sources completely bypass the sound field processing and multi channel surround formats are downmixed to 2 channels.

### ■ HEADPHONE (DIRECT)

Outputs the analog signals without digital processing by the equalizer, sound field, etc.

### ■ HEADPHONE (MULTI 1/2)

Outputs the analog signals input to the MULTI CHANNEL IN jacks.

### ■ HEADPHONE THEATER **DCS**

Allows you to experience a theater like environment while listening through a pair of headphones.

To turn off the surround effect Press AUTO DEC or 2CH STEREO.

continued

## Selecting a sound field (continued)

### Enjoying the surround effect at low volume level (NIGHT MODE)

This function allows you to retain a theater like environment at low volume levels. This function can be used with other sound fields.

When watching a movie late at night, you will be able to hear the dialog clearly even at a low volume level.

#### Press NIGHT MODE.

The "NIGHT MODE" indicator in the display lights up and the NIGHT MODE function is activated.

#### Tip

While this function is on, the BASS, TREBLE, and EFFECT level increase, and "D.RANGE COMP." is automatically set to "MAX".

#### Note

This function cannot be activated when the ANALOG DIRECT or MULTI CH DIRECT function is used.

## Enjoying Dolby Pro Logic II and DTS Neo:6

### (2CH MODE)

This function lets you specify the type of decoding for 2 channel audio sources.

This receiver can reproduce 2 channel sound in 5 channels through Dolby Pro Logic II; 6 channels through DTS Neo:6; or 4 channels through Dolby Pro Logic. However, MPEG 2CH sources are not decoded by DTS Neo:6; they are output in 2 channels.

#### Press NORMAL SURR (□□PLII/Neo:6) repeatedly to select the 2 channel decoding mode.

The selected mode appears in the display. The sound field automatically switches to "NORMAL SURROUND" (page 37).

#### 2 channel decoding modes

- **PRO LOGIC**  
Performs Pro Logic decoding. The source recorded in 2 channel is decoded into 4.1 channels.
- **PLII MOVIE**  
Performs Pro Logic II Movie mode decoding. This setting is ideal for movies encoded in Dolby Surround. In Addition, this mode can reproduce sound in 5.1 channel when watching videos of overdubbed or old movies.
- **PLII MUSIC**  
Performs the Pro Logic II Music mode decoding. This setting is ideal for normal stereo sources such as CDs.
- **Neo: Cinema**  
Performs the DTS Neo:6 Cinema mode decoding. This setting is ideal for movies encoded in DTS Surround.
- **Neo: Music**  
Performs the DTS Neo:6 Music mode decoding. This setting is ideal for normal stereo sources such as CDs.

### Tips

- When “PLII MUSIC” is selected, you can make further adjustments using “CENTER WIDTH”, “DIMENSION”, “PANORAMA” in the SURROUND menu.
- You can select the 2 channel decoding mode using “2CH MODE” in the CUSTOMIZE menu (page 47).

## Selecting the surround back decoding mode

### (SB DECODING)

This function lets you select the decoding mode for the surround back signals of the multi channel input stream.

By decoding the surround back signal of DVD software (etc.) recorded in the Surround EX format\*, you can enjoy the surround sound intended by the filmmakers.

\* Dolby Digital EX, DTS-ES Matrix, DTS-ES Discrete 6.1, etc.

**Press SURR BACK DECODING repeatedly to select the surround back decoding mode.**

“SB DECODING XXXX” appears in the display.

When the receiver is decoding the surround back signal the “SB DEC” indicator lights up.

Surround back decoding modes

- AUTO
- MATRIX
- OFF

For details, see “How to select the surround back decoding mode” on the next page.

#### Tip

You can select the surround back decoding mode using “SB DECODING” in the CUSTOMIZE menu (page 47).

#### Note

You cannot select the surround back decoding mode when using the 2CH STEREO (page 34), ANALOG DIRECT (page 34) or MULTI CH DIRECT mode (page 28) or when headphones are connected.

**continued**

## Selecting the surround back decoding mode (continued)

### How to select the surround back decoding mode

You can select the surround back mode you want according to the input stream.

When you select "AUTO"

When the input stream contains the 6.1 channel decode flag\*<sup>1</sup>, the appropriate decoder is applied to decode the surround back signal.

For the DTS-ES Matrix 6.1 source, DTS Matrix decoder is applied.

For the DTS-ES Discrete 6.1 source, DTS Discrete decoder is applied to reproduce the Discrete 6.1 channel signal.

Input stream	Output channel	Applied surround back decoder
Dolby Digital 5.1	5.1* <sup>5</sup>	—
DTS 5.1	5.1* <sup>5</sup>	—
Dolby Digital EX* <sup>2</sup>	6.1* <sup>5</sup>	Matrix decoder conforms to Dolby Digital EX
DTS-ES Matrix 6.1* <sup>3</sup>	6.1* <sup>5</sup>	DTS Matrix decoder
DTS-ES Discrete 6.1* <sup>4</sup>	6.1* <sup>5</sup>	DTS Discrete decoder

When you select "MATRIX"

Dolby Digital EX is applied to decode the surround back signal regardless of the 6.1 channel decode flag\*<sup>1</sup> in the input stream. This decoder conforms to Dolby Digital EX and functions the same as the decoders used in movie theaters. This decoder can be used for all the Surround EX formats (Dolby Digital EX, DTS-ES Matrix 6.1, DTS-ES Discrete 6.1).

Input stream	Output channel	Applied surround back decoder
Dolby Digital 5.1	6.1* <sup>5</sup>	Matrix decoder conforms to Dolby Digital EX
Dolby Digital EX	6.1* <sup>5</sup>	Matrix decoder conforms to Dolby Digital EX
DTS 5.1	6.1* <sup>5</sup>	Matrix decoder conforms to Dolby Digital EX
DTS-ES Matrix 6.1* <sup>3</sup>	6.1* <sup>5</sup>	Matrix decoder conforms to Dolby Digital EX
DTS-ES Discrete 6.1* <sup>4</sup>	6.1* <sup>5</sup>	Matrix decoder conforms to Dolby Digital EX

When you select "OFF"

Surround back decoding is not performed.

\*<sup>1</sup> 6.1 channel decode flag is the information recorded in software like DVDs.

\*<sup>2</sup> Dolby Digital DVD that includes a Surround EX flag. The Dolby Corporation web page can help you distinguish Surround EX films.

\*<sup>3</sup> Software encoded with a flag to denote it has both Surround EX and 5.1 channel signals.

\*<sup>4</sup> Software encoded with both 5.1 channel signals and an extension stream designed for returning those signals to 6.1 discrete channels. Discrete 6.1 channel signals are DVD specific signals not used in movie theaters.

\*<sup>5</sup> When two surround back speakers are connected, the output channel will be 7.1 channels.



## Assigning the audio input

### (AUDIO SPLIT)

You can assign the audio input for each function. This function is convenient in the following cases.

**(Example) When you have two DVD players and no digital audio input jack is available for the second DVD player.**

Connect the first DVD player to the DVD/LD COAXIAL IN jack and connect the second DVD player to the DVD/LD OPTICAL IN jack.

Also, connect the analog audio/video output jacks on the second DVD player to the VIDEO 2 INPUT jacks on the receiver.

Assign "DIGITAL ONLY COAXIAL" to DVD/LD function and assign "DVD/LD (OPTICAL)" to VIDEO 2 function.

- 1 **Rotate FUNCTION to select the function whose audio input mode you want to assign.**
- 2 **Press AUDIO SPLIT.**
- 3 **Rotate FUNCTION to select the audio input.**  
The audio input you can assign varies for each function. For details, see "Selectable audio inputs for each function" below. Select "NO ASSIGN" if you do not want to assign any audio input to the selected function.
- 4 **Press AUDIO SPLIT.**

The audio input is assigned to the function selected in step 1. If you do not press AUDIO SPLIT within 8 seconds, the receiver automatically assigns the audio input displayed in the display.

Selectable audio inputs for each function

---

#### DVD/LD, CD/SACD function

---

NO ASSIGN → DIGITAL: ONLY COAX →  
DIGITAL: ONLY OPT → ONLY ANALOG INPUT

---

#### TV/SAT, MD/DAT function

---

NO ASSIGN → DVD/LD (COAXIAL) →  
CD/SACD (COAXIAL) → ONLY ANALOG  
INPUT

---

#### PHONO function

---

NO ASSIGN → VIDEO 1 → VIDEO 2 →  
VIDEO 3 → DVD/LD (ANALOG) →  
TV/SAT (ANALOG) → TAPE → MD/DAT  
(ANALOG) → CD/SACD (ANALOG)

---

#### All other analog functions

---

NO ASSIGN → DVD/LD (COAXIAL) →  
DVD/LD (OPTICAL) → TV/SAT (OPTICAL) →  
MD/DAT (OPTICAL) → CD/SACD (COAXIAL)  
→ CD/SACD (OPTICAL)

---

#### Tips

- When you select a function for which an audio input is assigned, the AUDIO SPLIT button lights up.
- You can also select the audio input assigned with this function using INPUT MODE (page 42).

#### Notes

- You cannot use the AUDIO SPLIT function when the ANALOG DIRECT or MULTI CH DIRECT function is activated.
- You cannot assign an audio input for TUNER function.

## Switching the audio input mode for digital components

### **(INPUT MODE)**

You can switch the audio input mode for functions which have digital audio input jacks. You can also select the COAXIAL or OPTICAL audio inputs of other functions using the AUDIO SPLIT (page 41).

**1 Rotate FUNCTION to select the function whose audio input mode you want to switch.**

**2 Press INPUT MODE repeatedly to select the audio input mode.**

The selected audio input mode appears in the display.

Audio input modes

- **AUTO 2CH**  
Gives priority to the analog audio signals input to the AUDIO IN (L/R) jacks when there is no digital audio signals.
- **COAXIAL FIXED**  
Specifies the digital audio signals input to the DIGITAL COAXIAL input jacks.
- **OPTICAL FIXED**  
Specifies the digital audio signals input to the DIGITAL OPTICAL input jacks.
- **ANALOG 2CH FIXED**  
Specifies the analog audio signals input to the AUDIO IN (L/R) jacks.

When the multi channel audio input is assigned to a specific function (page 47)

The following is displayed instead of “AUTO 2CH” and “ANALOG 2CH FIXED”.

- **AUTO MULTI CH 1/2**  
Gives priority to the analog audio signals input to the MULTI CHANNEL IN 1/2 jacks when there is no digital audio signals.
- **MULTI CH 1/2 FIXED**  
Specifies the analog audio signals input to the MULTI CHANNEL IN 1/2 jacks.

## Customizing sound fields

By adjusting the SURROUND menu and LEVEL menu, you can customize the sound fields to suit your particular listening situation.

Note on the displayed items

The setup items you can adjust in each menu vary depending on the sound field. Certain setup parameters may be dimmed in the display. This means that the selected parameter is either unavailable or fixed and unchangeable.

### Adjusting the SURROUND menu

You can customize the surround effects of the selected sound field. The settings are stored individually for each sound field.

- 1 Start playing a source encoded with multi channel surround effects (DVD, etc.).**
- 2 Press SURROUND.**  
The SURROUND button lights up and the SURROUND menu appears in the display.
- 3 Press the cursor buttons (< or >) to select the parameter.**  
For details, see “SURROUND menu parameters” below.
- 4 While monitoring the sound, turn the jog dial to adjust the selected parameter.**
- 5 Repeat steps 3 and 4 to adjust the other parameters.**

### SURROUND menu parameters

■ EFFECT LEVEL XXX %  
(Effect level)

Initial setting: 100 %

Higher settings apply more surround effect. You can adjust from 0 % to 150 % in 5 % steps.

■ BASS GAIN XXX.X dB  
(Bass gain level of the equalizer)

Initial setting: 0 dB

Unlike the equalizer in the EQ menu (which lets you adjust the overall sound of each speaker), this parameter lets you adjust the bass gain level of each sound field.

You can adjust from -10 dB to +10 dB in 0.5 dB steps.

■ TREBLE GAIN XXX.X dB  
(Treble gain level of the equalizer)

Initial setting: 0 dB

Unlike the equalizer in the EQ menu (which lets you adjust the overall sound of each speaker), this parameter lets you adjust the treble gain level of each sound field.

You can adjust from -10 dB to +10 dB in 0.5 dB steps.

For advanced SURROUND menu adjustments

Use the CUSTOMIZE menu and set “MENU EXPAND” to “ON” to enable advanced adjustments.

For details on “MENU EXPAND”, see page 47.

For details on how to set the items, see page 52.

continued

## Customizing sound fields (continued)

### Adjusting the LEVEL menu

You can adjust the balance and level of each speaker. These settings are applied to all sound fields.

- 1 Start playing a source encoded with multi channel surround effects (DVD, etc.).**
- 2 Press LEVEL.**  
The LEVEL button lights up and the LEVEL menu appears in the display.
- 3 Press the cursor buttons (< or >) to select the parameter.**  
For details, see “LEVEL menu parameters” below.
- 4 While monitoring the sound, turn the jog dial to adjust the selected parameter.**
- 5 Repeat steps 3 and 4 to adjust the other parameters.**

#### LEVEL menu parameters

##### ■ TEST TONE (Test tone)\*<sup>1</sup>

Initial setting: OFF

Lets you output the test tone sequentially from each speaker. When set to “AUTO”, the test tone is output from each speaker automatically. When set to “FIX”, you can select which speaker will output the test tone.

##### ■ PHASE NOISE (Phase noise)\*<sup>1</sup>

Initial setting: OFF

Lets you output the test tone sequentially from two adjacent speakers.

##### ■ PHASE AUDIO (Phase audio)\*<sup>1</sup>

Initial setting: OFF

Lets you output the source sound (instead of the test tone) sequentially from two adjacent speakers.

##### ■ FRONT (Front speaker balance)

Initial setting: midpoint (0)

Lets you adjust the balance between front left and right speakers. You can adjust from -8 dB to +8 dB in 0.5 dB steps.

■ CENTER XXX.X dB  
(Center speaker level)

■ SURROUND L XXX.X dB  
(Surround speaker (L) level)

■ SURROUND R XXX.X dB  
(Surround speaker (R) level)

■ SURR BACK XXX.X dB  
(Surround back speaker level)\*<sup>2</sup>

■ SURR BACK L XXX.X dB  
(Surround back speaker (L) level)\*<sup>3</sup>

■ SURR BACK R XXX.X dB  
(Surround back speaker (R) level)\*<sup>3</sup>

Initial setting: 0 dB

You can adjust from -20 dB to +10 dB in 0.5 dB steps.

■ S.WOOFER XXX.X dB  
(Sub woofer level)

Initial setting: 0 dB

You can adjust from -20 dB to +10 dB in 0.5 dB steps.

■ MULTI CH 1 SW XXX dB  
(Multi channel 1 sub woofer level)

■ MULTI CH 2 SW XXX dB  
(Multi channel 2 sub woofer level)

Initial setting: 0 dB

Lets you increase the level of the MULTI CHANNEL IN 1/2 sub woofer channel by +10 dB. This adjustment may be necessary when connecting a DVD player to the MULTI CHANNEL IN 1/2 jacks. The sub woofer level from DVD players is 10 dB lower than Super Audio CD players.

\*<sup>1</sup> Only one of these parameters appears according to the “T.TONE” setting in the CUSTOMIZE menu (page 48).

\*<sup>2</sup> Only when “SURR BACK L/R” is set to “NO” (page 23).

\*<sup>3</sup> Only when “SURR BACK L/R” is set to “YES” (page 23).

#### Note

When one of the following sound fields are selected, no sound is output from the sub woofer if “FRONT SP” (front speaker size) in the SET UP menu is set to “LARGE”. However, the sound will be output from the sub woofer if the digital input signal contains LFE (Low Frequency Effect) signals.

- D.CONCERT HALL A/B
- CHURCH
- OPERA HOUSE
- JAZZ CLUB
- LIVE CONCERT
- ARENA
- STADIUM

For advanced LEVEL menu adjustments

Use the CUSTOMIZE menu and set “MENU EXPAND” to “ON” to enable advanced adjustments.

For details on “MENU EXPAND”, see page 47.

For details on how to set the items, see page 54.

## Resetting sound fields to the initial settings

- 1 Press I/⏻ to turn off the power.
- 2 While holding down MODE +, press I/⏻.  
“S.F Initialize” appears in the display and all sound fields are reset to the initial settings.

## Adjusting the equalizer

You can adjust the tonal quality (bass, midrange, treble level) of each speaker using the EQ menu.

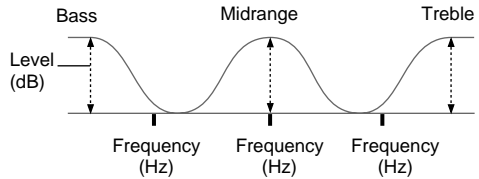

You can store up to 5 different equalizer settings in the equalizer bank (EQ [1]–[5]) and apply them by pressing EQ BANK.

- 1 Start playing a source encoded with multi channel surround effects (DVD, etc.).
- 2 Press EQ BANK repeatedly to select the equalizer you want to adjust (EQ [1]–[5]).
- 3 Press EQ.  
The EQ button lights up and the EQ menu appears in the display.
- 4 Press the cursor buttons (< or >) to select the parameter.  
For details, see “EQ menu parameters” below.
- 5 While monitoring the sound, turn the jog dial to adjust the selected parameter.
- 6 Repeat steps 4 and 5 to adjust the other items.

continued

## Adjusting the equalizer (continued)

### EQ menu parameters

- FRONT BASS XXX.X dB  
(Front speaker bass level)
  - FRONT MID XXX.X dB  
(Front speaker midrange level)
  - FRONT TREBLE XXX.X dB  
(Front speaker treble level)
  - CENTER BASS XXX.X dB  
(Center speaker bass level)
  - CENTER MID XXX.X dB  
(Center speaker midrange level)
  - CENTER TREBLE XXX.X dB  
(Center speaker treble level)
  - SURROUND BASS XXX.X dB  
(Surround speaker bass level)
  - SURROUND TRE. XXX.X dB  
(Surround speaker treble level)
  - SUR.BACK BASS XXX.X dB  
(Surround back speaker bass level)
  - SUR.BACK TRE. XXX.X dB  
(Surround back speaker treble level)
- Initial setting: 0 dB  
You can adjust from -10 dB to +10 dB in 0.5 dB steps.

To apply the stored equalizer  
Press EQ BANK repeatedly to select EQ [1]–[5].  
Select “EQ [OFF]” to turn off equalization.

### Clearing Stored Equalizer Settings

- 1 Press EQ BANK repeatedly to select the equalizer (EQ [1]–[5]) you want to clear.
- 2 Press EQ.
- 3 Press the cursor buttons (< or >) to select “PRESET CLEAR”.
- 4 Turn the jog dial to select “YES”, then press ENTER.  
“Are you sure?” appears in the display.
- 5 Turn the jog dial to select “YES”, then press ENTER.  
The adjusted contents of the selected equalizer bank are cleared.

For advanced EQ menu adjustments  
Use the CUSTOMIZE menu and set “MENU EXPAND” to “ON” to enable advanced adjustments.

For details on “MENU EXPAND”, see page 47.

For details on how to set the items, see page 55.

# Advanced settings

## Using the CUSTOMIZE menu to adjust the receiver

You can adjust various receiver settings using the CUSTOMIZE menu.

### 1 Press CUSTOMIZE.

The CUSTOMIZE button lights up and the CUSTOMIZE menu appears in the display.

### 2 Press the cursor buttons (< or >) to select the parameter.

For details, see “CUSTOMIZE menu parameters” below.

### 3 Turn the jog dial to adjust the selected parameter.

### 4 Repeat steps 2 and 3 to adjust the other items.

## CUSTOMIZE menu parameters

The initial setting is underlined.

### ■ MENU EXPAND (Menu expanding)

- ON  
The advanced parameters for the SET UP, SURROUND, LEVEL, and EQ menus are displayed and can be adjusted. For details on each setup items, see pages 21, 43–45 and the following pages.

- OFF

The advanced parameters are not displayed.

### ■ dts 96/24DEC. (DTS 96/24 decoding mode)

- AUTO  
When a DTS 96/24 signal is input, it is played back at 96 kHz sampling frequencies.
- OFF  
Even when a DTS 96/24 signal is input, it is played back at 48 kHz sampling frequencies.

### Note

This parameter is valid only in the AUTO DECODING mode (page 34). In other sound fields, this parameter is always set to “OFF”.

### ■ 2CH MODE

(2 channel decoding mode)

You can use the CUSTOMIZE menu to set the 2 channel decoding mode (page 38).

You can set this parameter only when NORMAL SURROUND or AUTO DECODING\* is selected. In the Cinema Studio EX mode, this parameter is always set to “PRO LOGIC” and cannot be changed.

For details on each decoding mode, see page 38.

\* The selected decoding mode is applied only when the Dolby Digital [L/R] signal is input.

- PRO LOGIC
- PLII MOVIE
- PLII MUSIC
- Neo: Cinema
- Neo: Music

### ■ SB DECODING

(Surround back decoding mode)

You can use the CUSTOMIZE menu to set the surround back decoding mode (page 39).

For details on each decoding mode, see page 39.

- AUTO
- MATRIX
- OFF

### ■ MULTI CH 1

(Multi channel 1 assignment)

### ■ MULTI CH 2

(Multi channel 2 assignment)

Initial setting: NONE (no assignment)

Lets you assign the audio signal input to MULTI CHANNEL IN 1 (or 2) jacks to any function except TUNER and PHONO.

You cannot assign both “MULTI CH 1” and “MULTI CH 2” to the same function.

### ■ D.POWER (Digital power management)

- AUTO OFF

Lets you turn off the power of the unnecessary digital circuits automatically when outputting the analog audio signals using the ANALOG DIRECT or MULTI CH DIRECT function. You can enjoy high quality analog audio without the influence of digital circuits.

- ALWAYS ON

Lets you keep the power of digital circuits on. Select if you do not like the time lag that occurs with the “AUTO OFF” setting when digital circuits are turned on, etc.

continued

## Advanced settings (continued)

### ■ V.POWER (Video power management)

#### • AUTO OFF

Lets you turn off the power of the unnecessary video circuits automatically. You can enjoy high quality audio without the influence of video circuits.

#### • ALWAYS ON

Lets you keep the power of video circuits on. Depending on the monitor, noise may be produced or the picture may be distorted when the power of the video circuits is turned on. In this case, select "ALWAYS ON".

### ■ S.FIELD LINK (Sound field link)

#### • ON

Lets you apply the last selected sound field to a function whenever it is selected. For example, if you select STADIUM for CD/SACD function, change to a different function and return to CD/SACD function, STADIUM is automatically applied again.

#### • OFF

Sound field link is not activated.

### ■ DECODE FORMAT

(Digital audio input decoding mode)

Lets you specify the input mode for the digital signal input to the DIGITAL IN jacks.

#### • AUTO

Automatically switches the input mode between DTS, Dolby Digital, PCM, or MPEG2.

#### • PCM

Decodes all the input signals as PCM signals. If a Dolby Digital, DTS, or MPEG (etc.) signal is input, no sound is output. When set to "AUTO", and the sound from the digital audio jacks (for CD, etc.) is interrupted when playback starts, set to "PCM".

### ■ AUTO FUNCTION

(Control A1: Function link)

#### • ON

Lets you switch the function of this receiver to the Sony components connected via CONTROL A1 cords (page 61) automatically when the playback on the component is started.

#### • OFF

Function link is not activated.

### ■ 2 WAY REMOTE

(2 way remote control system)

#### • ON

Lets you turn on the 2 way remote control system. Normally, select "ON".

#### • OFF

Lets you turn off the 2 way remote control system. When you use another receiver, etc. that is also compatible with the 2 way remote control system, together with this receiver, select the component for which you use the 2 way remote control system.

Then set the 2 way remote control system for the component to "ON". For other components, set the 2 way remote control system to "OFF".

### ■ T.TONE (Test tone mode)

Lets you select the test tone output mode (page 26).

#### • NORMAL

Lets you output the test tone from each speaker in sequence.

#### • PHASE NOISE

Lets you output the test tone from two adjacent speakers at a time in sequence.

#### • PHASE AUDIO

Lets you output the source sound instead of the test tone from two adjacent speakers at a time in sequence.

### ■ INSTALLER MODE (RS232C control)

#### ■ 12V TRIG.MAIN

(12 V trigger for the main room)

#### ■ 12V TRIG.2ND

(12 V trigger for the 2nd room)

#### ■ 12V TRIG.3RD

(12 V trigger for the 3rd room)  
(STR-DA7ES only)

For details, see "Custom install mode" on page 57.



### ■ OSD COLOR

(Color of the on-screen display)

Lets you select the color of the on-screen display.

- COLOR

The on-screen display is displayed in color.

- MONOCHROME

The on-screen display is displayed in monochrome.

### ■ OSD H.POSITION

(OSD horizontal position)

Initial setting: 4

Lets you adjust the position of the on-screen display horizontally. You can adjust from 0 to 64.

### ■ OSD V.POSITION

(OSD vertical position)

Initial setting: 4

Lets you adjust the position of the on-screen display vertically. You can adjust from 0 to 32.

### ■ COMMAND MODE (Command mode)

Lets you select the command mode of the remote. If the command mode of the receiver and the remote is different, operation from the remote is not possible.

- AV1

- AV2

### ■ NAME IN?

(Naming preset stations and functions)

For details, see “Naming preset stations and functions” on page 58.

## Advanced SET UP menu parameters

When “MENU EXPAND” is set to “ON”, all of the following parameters are displayed and adjustable.

See page 21 for the SET UP menu adjustments.

Initial settings are underlined.

### All SET UP menu parameters

FRONT SP

CENTER SP

SURROUND SP

SURR BACK SP

SURR BACK L/R

SUB WOOFER

FRONT XX feet

CENTER XX feet

SURROUND XX feet

SURR BACK XX feet

SUB WOOFER XX feet

S.W PHASE\*

DISTANCE UNIT\*

SURR POSL.\*

SURR HEIGHT\*

SURR BACK HGT.\*

FRONT SP > XXX Hz\*

CENTER SP > XXX Hz\*

SURROUND SP > XXX Hz\*

SURR BACK SP > XXX Hz\*

LFE HIGH CUT > XXX Hz\*

\* Adjustable only when “MENU EXPAND” is set to “ON”.

continued

## Advanced settings (continued)

### ■ S.W PHASE

(Sub woofer phase polarity)

Lets you set the sub woofer phase polarity.

- **NORMAL**

Normally, select "NORMAL".

- **REVERSE**

Depending on the type of front speakers, the position of the sub woofer, and the cut-off frequency of the sub woofer, setting the phase polarity to "REVERSE" (reverse) may produce better bass. Besides bass reproduction, the richness and tightness of the overall sound may also be affected. While listening from the main listening position, select the setting that best suits your environment.

### ■ DISTANCE UNIT (Distance unit)

Lets you select the unit of measure for setting distances.

- **meter**

The distance is displayed in meters.

- **feet**

The distance is displayed in feet.

### ■ SURR POSI.

(Surround speaker position)\*1

Lets you specify the location of your surround speakers for proper implementation of the surround effects in the Cinema Studio EX modes (page 35).

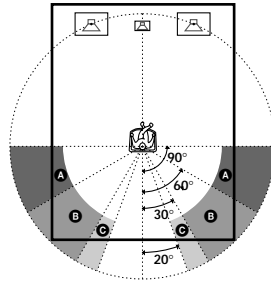

- **SIDE**

Select if the location of your surround speakers corresponds to section **A**.

- **MIDDLE**

Select if the location of your surround speakers corresponds to section **B**.

- **BEHIND**

Select if the location of your surround speakers corresponds to section **C**.

## Tip

“SURR POSI.” (Surround speaker position) is designed specifically for implementation of the sound fields of the Cinema Studio EX modes.

For other sound fields, speaker position is not so critical. Those sound fields were designed under the premise that the surround speakers would be located behind the listening position, but presentation remains fairly consistent even with the surround speakers positioned at a rather wide angle. However, if the speakers are pointing toward the listener from the immediate left and right of the listening position, the surround effects becomes unclear unless set to “SIDE”.

Nevertheless, each listening environment has many variables, like wall reflections, and you may obtain better results using “BEHIND” or “MIDDLE” if your speakers are located high above the listening position, even if they are to the immediate left and right.

Therefore, although it may result in a setting contrary to the above explanation, we recommend that you playback multi channel surround encoded software and select the setting that provides a good sense of spaciousness and that best succeeds in forming a cohesive space between the surround sound from the surround speakers and the sound of the front speakers. If you are not sure which sounds best, select “BEHIND” and then use the speaker distance parameter and speaker level adjustments to obtain proper balance.

■ **SURR HEIGHT**  
(Surround speaker height)\*<sup>1</sup>

■ **SURR BACK HGT.**  
(Surround back speaker height)\*<sup>2</sup>

Lets you specify the hight of your surround speakers and the surround back speakers for proper implementation of the surround effects of the Cinema Studio EX modes (page 35).

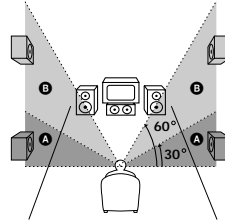

- **LOW**

Select if the height of your surround speakers or the surround back speakers corresponds to section **A**.

- **HIGH**

Select if the height of your surround speakers or the surround back speakers corresponds to section **B**.

\*<sup>1</sup> This setup item is not available when “SURROUND SP” (surround speaker size) is set to “NO”.

\*<sup>2</sup> This setup item is not available when “SURR BACK SP” (surround back speaker size) is set to “NO”.

■ **FRONT SP > XXX Hz**  
(Front speaker crossover frequency)

Initial setting: STD (120 Hz)

Lets you adjust the front speaker bass crossover frequency when “FRONT SP” (front speaker size) is set to “SMALL”. You can adjust from 40 Hz to 200 Hz in 10 Hz steps.

■ **CENTER SP > XXX Hz**  
(Center speaker crossover frequency)

Initial setting: STD (120 Hz)

Lets you adjust the center speaker bass crossover frequency when “CENTER SP” (center speaker size) is set to “SMALL”. You can adjust from 40 Hz to 200 Hz in 10 Hz steps.

**continued**

## Advanced settings (continued)

■ **SURROUND SP > XXX Hz**  
(Surround speaker crossover frequency)

Initial setting: STD (120 Hz)

Lets you adjust the surround speaker bass crossover frequency when “SURROUND SP” (surround speaker size) is set to “SMALL”. You can adjust from 40 Hz to 200 Hz in 10 Hz steps.

■ **SURR BACK SP > XXX Hz**  
(Surround back speaker crossover frequency)

Initial setting: STD (120 Hz)

Lets you adjust the surround back speaker bass crossover frequency when “SURR BACK SP” (surround back speaker size) is set to “SMALL”. You can adjust from 40 Hz to 200 Hz in 10 Hz steps.

■ **LFE HIGH CUT > XXX Hz**  
(LFE high cut filter)

Initial setting: STD (120 Hz)

Lets you select the cut off frequency of the LFE channel high cut filter. Normally, select “STD (120 Hz)”.

When using a passive sub woofer powered by a separate power amplifier, it may be better to change the cut off frequency. In this case, you can adjust from 40 Hz to 200 Hz in 10 Hz steps.

## Advanced SURROUND menu parameters

When “MENU EXPAND” is set to “ON”, all of the following parameters are displayed and adjustable.

See page 43 for the SURROUND menu adjustments.

Initial settings are underlined.

All SURROUND menu parameters

C.WIDTH\*

DIMENSION\*

PANORAMA MODE\*

EFFECT LEVEL XXX %

WALL\*

REVERB\*

FRONT REVERB\*

SCREEN DEPTH\*

VIR.SPEAKERS\*

SURR ENHANCER\*

BASS GAIN XXX.X dB

BASS FREQ. XXX.X Hz\*

TREBLE GAIN XXX.X dB

TREBLE FREQ. XXX.X Hz\*

\* Adjustable only when “MENU EXPAND” is set to “ON”.

### ■ C WIDTH

(Center width control)

Initial setting: (3)

Lets you perform further adjustments for Dolby Pro Logic II Music mode decoding (PLII MUSIC). You can set this parameter only when "2CH MODE" is set to "PLII MUSIC" (page 38) and NORMAL SURROUND is selected.

You can adjust the distribution of the center channel signal, generated through the Dolby Pro Logic II decoding, to the L/R speakers.

### ■ DIMENSION

(Dimension control)

Initial setting: midpoint (0)

Lets you perform further adjustments for Dolby Pro Logic II Music mode decoding (PLII MUSIC). You can set this parameter only when "2CH MODE" is set to "PLII MUSIC" (page 38) and NORMAL SURROUND is selected.

You can adjust the difference between the front channels and the surround channels.

### ■ PANORAMA MODE

(Panorama mode)

Lets you perform further adjustments for Dolby Pro Logic II Music mode decoding (PLII MUSIC). You can set this parameter only when "2CH MODE" is set to "PLII MUSIC" (page 38) and NORMAL SURROUND is selected.

- ON

Lets you enjoy the surround sound by spreading the sound field of front speakers to the left and right of the listening position (panorama mode).

- OFF

Panorama mode is not activated.

### ■ WALL (Wall type)

Initial setting: midpoint (0)

When sound is reflected off soft material, such as a curtain, the high frequency elements are reduced. A hard wall is highly reflective and does not significantly effect the frequency response of the reflected sound.

"WALL" lets you control the level of the high frequencies to alter the sonic character of your listening environment by simulating a softer (S) or harder (H) wall. You can adjust from S to H in 17 steps. The center (0) setting designates a neutral wall made of wood.

### ■ REVERB (Reverberation)

Initial setting: midpoint (0)

Before sound reaches our ears, it is reflected (reverberated) many times between the left and right walls, ceiling, and floor. In a large room, sound takes more time to bounce from one surface to another than in a smaller room.

"REVERB" lets you control the spacing of the early reflections to simulate a sonically longer (L) or shorter (S) room. You can adjust from S to L in 17 steps. The midpoint (0) designates a standard room with no adjustment.

### ■ FRONT REVERB (Front reverberation)

This parameter is especially for "D.CONCERT HALL A/B" (page 36).

This parameter lets you adjust the amount of reverberations to add to the front signals according to the original reverberations in the source.

- DRY

Select to decrease front reverberations.

- STD

Normally, select "STD".

- WET

Select to increase front reverberations.

### ■ SCREEN DEPTH (Screen depth)

Lets you create the sensation that the sound of the front speakers comes from inside the screen in your listening room, like theaters.

- OFF

This function is not activated.

- MID

Normally, select "MID".

- DEEP

Lets you create the sensation that the sound comes from a very large screen with a greater amount of screen depth.

**continued**

## Advanced settings (continued)

### ■ VIR.SPEAKERS (Virtual speakers)

This parameter is especially for the Cinema Studio EX modes (page 35).

- ON  
The virtual speakers are created.
- OFF  
The virtual speakers are not created.

### ■ SURR ENHANCER (Surround reflection enhancer)

This parameter is especially for the Cinema Studio EX modes (page 35).

This parameter lets you add the effect of a broader sound when the surround channel sound is monaural.

- ON  
The effect is automatically applied to sources recorded in Dolby Pro Logic, Dolby Digital [2/1], [3/1] or dts [2/1], [3/1], etc. and the surround channel is monaural.
- OFF  
This function is not activated.

### ■ BASS FREQ. XXX.X Hz (Bass frequency of the equalizer)

Initial setting: 250 Hz

Unlike the equalizer in the EQ menu (which lets you adjust the overall sound quality of each set of speakers), this parameter lets you adjust the bass frequency of each sound field. You can adjust from 99 Hz to 1.0 kHz in 21 steps.

### ■ TREBLE FREQ. XXX.X Hz (Treble frequency of the equalizer)

Initial setting: 2.5 kHz

Unlike the equalizer in the EQ menu (which lets you adjust the overall sound quality of each set of speakers), this parameter lets you adjust the treble frequency of each sound field. You can adjust from 1.0 kHz to 10.0 kHz in 23 steps.

## Advanced LEVEL menu parameters

When “MENU EXPAND” is set to “ON”, all of the following parameters are displayed and adjustable.

See page 44 for the LEVEL menu adjustments. Initial settings are underlined.

### All LEVEL menu parameters

---

TEST TONE

---

FRONT L    I    R

---

CENTER XXX.X dB

---

SURROUND L XXX.X dB

---

SURROUND R XXX.X dB

---

SURR BACK    XXX.X dB

---

SURR BACK L XXX.X dB

---

SURR BACK R XXX.X dB

---

S.WOOFER XXX.X dB

---

MULTI CH 1 SW XXX dB

---

MULTI CH 2 SW XXX dB

---

LFE MIX LEVEL XXX.X dB\*

---

D.RANGE COMP.\*

---

\* Adjustable only when “MENU EXPAND” is set to “ON”.

### ■ LFE MIX LEVEL XXX.X dB (LFE (Low Frequency Effect) mix level)

Initial setting: 0 dB

Lets you attenuate the level of the LFE (Low Frequency Effect) channel output from the sub woofer without effecting the level of the bass frequencies sent to the sub woofer from the front, center or surround channels via the Dolby Digital or DTS bass redirection circuitry. You can adjust from -20 dB to 0 dB (line level) in 0.5 dB steps. “0 dB” outputs the full LFE signal at the mix level determined by the recording engineer. When set to “OFF”, the sound of the LFE channel from the sub woofer is muted. In this case, the low frequency sounds of the front, center, or surround speakers are output from the sub woofer according to the settings made for each speaker (pages 21–23).

## ■ D.RANGE COMP.

(Dynamic range compressor)

Lets you compress the dynamic range of the sound track. This may be useful when you want to watch movies at low volumes late at night.

- OFF

The dynamic range is not compressed.

- 0.1–0.9

The dynamic range is compressed in small steps to achieve the sound you desire.

- STD

The dynamic range is compressed as intended by the recording engineer.

- MAX

The dynamic range is compressed dramatically.

### Tip

“D.RANGE COMP.” lets you to compress the dynamic range of the soundtrack based on the dynamic range information included in the Dolby Digital signal. “STD” is standard compression, but because many sources have only light compression, you may not notice much difference when using 0.1–0.9.

Therefore, we recommend using the “MAX” setting. This greatly compresses the dynamic range and lets you view movies late at night at low volumes. Unlike analog limiters, the levels are predetermined and provide a very natural compression.

### Notes

- Dynamic range compression is possible with Dolby Digital sources only.
- While NIGHT MODE is activated, D.RANGE COMP. is automatically set to MAX and the setting cannot be changed.

## Advanced EQ menu parameters

When “MENU EXPAND” is set to “ON”, all of the following parameters are displayed and adjustable.

See page 45 for the EQ menu adjustments.

Initial settings are underlined.

### All EQ menu parameters

FRONT BASS XXX.X dB

FRONT BASS XXX Hz\*

FRONT MID XXX.X dB

FRONT MID XXX Hz\*

FRONT MID\*

FRONT TREBLE XXX.X dB

FRONT TREBLE XXX Hz\*

CENTER BASS XXX.X dB

CENTER BASS XXX Hz\*

CENTER MID XXX.X dB

CENTER MID XXX Hz\*

CENTER MID\*

CENTER TREBLE XXX.X dB

CENTER TREBLE XXX Hz\*

SURROUND BASS XXX.X dB

SURROUND BASS XXX Hz\*

SURROUND TRE. XXX.X dB

SURROUND TRE. XXX Hz\*

SUR.BACK BASS XXX.X dB

SUR.BACK BASS XXX Hz\*

SUR.BACK TRE. XXX.X dB

SUR.BACK TRE. XXX Hz\*

PRESET CLEAR

\* Adjustable only when “MENU EXPAND” is set to “ON”.

**continued**

## Advanced settings (continued)

### ■ FRONT BASS XXX.X Hz

(Front speaker bass frequency)

Initial setting: 250 Hz

You can adjust from 99 Hz to 1.0 kHz in 21 steps.

### ■ FRONT MID XXX.X Hz

(Front speaker midrange frequency)

Initial setting: 1.0 kHz

You can adjust from 198 Hz to 10 kHz in 37 steps.

### ■ FRONT MID

(Front speaker midrange bandwidth)

#### • WIDE

Provides a wide band centered on the selected frequency, for general adjustments.

#### • MID

Provides a normal band.

#### • NARR

Provides a narrow band centered on the selected frequency, for specific adjustments.

### ■ FRONT TREBLE XXX.X Hz

(Front speaker treble frequency)

Initial setting: 2.5 kHz

You can adjust from 1.0 kHz to 10 kHz in 23 steps.

### ■ CENTER BASS XXX.X Hz

(Center speaker bass frequency)

Initial setting: 250 Hz

You can adjust from 99 Hz to 1.0 kHz in 21 steps.

### ■ CENTER MID XXX.X Hz

(Center speaker midrange frequency)

Initial setting: 1.0 kHz

You can adjust from 198 Hz to 10 kHz in 37 steps.

### ■ CENTER MID

(Center speaker midrange bandwidth)

#### • WIDE

Provides a wide band centered on the selected frequency, for general adjustments.

#### • MID

Provides a normal band.

#### • NARR

Provides a narrow band centered on the selected frequency, for specific adjustments.

### ■ CENTER TREBLE XXX.X Hz

(Center speaker treble frequency)

Initial setting: 2.5 kHz

You can adjust from 1.0 kHz to 10 kHz in 23 steps.

### ■ SURROUND BASS XXX.X Hz

(Surround speaker bass frequency)

Initial setting: 250 Hz

You can adjust from 99 Hz to 1.0 kHz in 21 steps.

### ■ SURROUND TRE. XXX.X Hz

(Surround speaker treble frequency)

Initial setting: 2.5 kHz

You can adjust from 1.0 kHz to 10 kHz in 23 steps.

### ■ SUR.BACK BASS XXX.X Hz

(Surround back speaker bass frequency)

Initial setting: 250 Hz

You can adjust from 99 Hz to 1.0 kHz in 21 steps.

### ■ SUR.BACK TRE. XXX.X Hz

(Surround back speaker treble frequency)

Initial setting: 2.5 kHz

You can adjust from 1.0 kHz to 10 kHz in 23 steps.



## Custom install mode

This receiver features the custom install modes described below. Depending on how you intend to use these features, use of these modes may require additional equipment (available separately) or modification of your listening environment. Please consult the retailer where you purchased this receiver for more information.

### INSTALLER mode

- **ON**  
The receiver can receive commands from the RS232C port even when the power is off (standby mode).
- **OFF**  
The receiver does not receive commands from the RS232C port when the power is off (standby mode).

### 12V TRIG mode

Lets you control external equipment by outputting 12V triggers (STR-DA7ES: 3 outputs, STR-DA4ES: 2 outputs) in conjunction with the receiver's function operations. For example, you can automatically unroll your video screen when you select DVD/CD.

■ **12V TRIG.MAIN**  
(12 V trigger for the main room)  
Controls the main room 12V trigger output.

- **ON**  
Lets you turn on output of 12V triggers for the main room when the receiver in the main room is turned on.
- **OFF**  
Lets you turn off output of 12V triggers for the main room even when the receiver in the main room is turned on.
- **FUNC**  
Lets you select which functions will output the 12V triggers for the main room.  
Initial settings when 12V. TRIG MAIN is set to ON:  
VIDEO 1, VIDEO 2, VIDEO 3, DVD/LD, TV/SAT, TAPE, MD/DAT, CD/SACD, TUNER, PHONO

To select the functions which will output the 12V triggers

- 1 Press ENTER while "12V. TRIG MAIN [FUNC]" is displayed.
- 2 Press the cursor buttons (< or >) to select a function.
- 3 Turn the jog dial to turn the 12V trigger ON/OFF.
- 4 Repeat steps 2 and 3 to make all necessary changes.
- 5 Press ENTER when you have finished.

■ **12V TRIG.2ND**  
(12 V trigger for the 2nd room)  
Controls the 2nd room 12V trigger output.

- **ON**  
Lets you turn on output of 12V triggers for the 2nd room when the amplifier in the 2nd room is turned on.
- **OFF**  
Lets you turn off output of 12V triggers for the 2nd room even when the amplifier in the 2nd room is turned off.
- **MAIN**  
Lets you link 2nd room trigger operation to the main room.

■ **12V TRIG.3RD**  
(12 V trigger for the 3rd room)  
(STR-DA7ES only)  
Controls the 3rd room 12V trigger output.

- **ON**  
Lets you turn on output of 12V triggers for the 3rd room when the amplifier in the 3rd room is turned on.
- **OFF**  
Lets you turn off output of 12V triggers for the 3rd room even when the amplifier in the 3rd room is turned off.
- **MAIN**  
Lets you link 3rd room trigger operation to the main room.

## Naming preset stations and functions

You can enter a name of up to 8 characters for preset stations and functions and display it in the receiver's display.

- 1 To index a preset station  
**Rotate FUNCTION to select TUNER, then tune in the preset station you want to create an index name for (page 31).**

To index a function

**Rotate FUNCTION to select a function you want to create an index name for.**

- 2 **Press CUSTOMIZE.**  
The CUSTOMIZE button lights up and the CUSTOMIZE menu appears in the display.

- 3 **Press the cursor button (>) to select "NAME IN?".**  
The preset station name or the function name flashes.

- 4 **Press ENTER.**  
The cursor flashes and you can select a character.

- 5 **Create an index name by using the jog dial and cursor buttons (< or >).**  
Turn the jog dial to select a character, then press the cursor button (>) to move the cursor to the next position.

Tips

- You can select the character type as follows by turning the jog dial.  
Alphabet (upper case) → Alphabet (lower case)  
→ Numbers → Symbols
- To enter a blank space, turn the jog dial until a blank space appears in the display.
- If you made a mistake, press the cursor button (< or >) until the character you want to change flashes, then turn the jog dial to select the correct character.

- 6 **Press ENTER.**  
The entered name is registered.

- 7 **To create index names for other preset stations and functions, repeat steps 1 to 6.**

## Using the Sleep Timer

You can set the receiver to turn off automatically at a specified time by using the remote.

For details, refer to the operating instructions supplied with the remote.

STR-DA7ES

Use the supplied remote RM-TP1.

**1 Touch RM SELECT.**

**2 Touch AMP in the RM SELECT screen.**

**3 Touch SLEEP while the power is on.**

STR-DA4ES

Use the supplied remote RM-LP211.

**Select SLEEP from the RECEIVER menu.**

Each time you touch or press the button, the display changes cyclically as follows:

2:00:00 → 1:30:00 → 1:00:00 → 0:30:00 → OFF

While using Sleep Timer, “SLEEP” lights up in the display.

Tip

To check the remaining time before the receiver turns off, touch or press SLEEP. The remaining time appears in the display.

## Selecting the speaker system

Set the SPEAKERS switch according to the front speakers you want to drive.

Set to	To select
A	The speakers connected to the FRONT SPEAKERS A terminals.
B	The speakers connected to the FRONT SPEAKERS B terminals.
A+B*	The speakers connected to both the FRONT SPEAKERS A and B terminals (parallel connection). The sound field is automatically set to 2CH STEREO.
OFF	No speaker output.

\* Be sure to connect front speakers with a nominal impedance of 8 ohms or higher if you want to select both sets of front speakers (A+B). In this case, set the IMPEDANCE SELECTOR to “4Ω”.

## Recording

Before you begin, make sure you've connected all components properly.

### Recording on an audio tape or MiniDisc

You can record on a MiniDisc or cassette tape using the receiver. See the operating instructions of your cassette deck or MD deck if you need help.

- 1 Select the component to be recorded.**
- 2 Prepare the component for playing.**  
For example, insert a CD into the CD player.
- 3 Insert a blank tape or MD into the recording deck and adjust the recording level, if necessary.**
- 4 Start recording on the recording deck, then start playback on the playback component.**

#### Notes

- You cannot record a digital audio signal using a component connected to the analog TAPE OUT or MD/DAT OUT jacks. To record a digital audio signal, connect a digital component to the DIGITAL MD/DAT OUT jacks.
- Sound adjustments do not affect the signal output from the TAPE OUT or MD/DAT OUT jacks.
- The analog audio signals of the current function is output from the REC OUT jacks.
- The signals input to the MULTI CHANNEL IN jacks are not output from the REC OUT jacks even when MULTI CH DIRECT is selected. The analog audio signals of the current function are output.
- No signals are output from DIGITAL OUT jacks (MD/DAT OPTICAL OUT) when ANALOG DIRECT is selected. The digital circuitry power is cut off to ensure superior sound quality when "D.POWER" is set to "AUTO OFF".

### Recording on a video tape

You can record from a VCR, a TV, or an LD player using the receiver. You can also add audio from a variety of audio sources when editing a video tape. See the operating instructions of your VCR or LD player if you need help.

- 1 Select the program source to be recorded.**
- 2 Prepare the component for playing.**  
For example, insert the laser disc you want to record into the LD player.
- 3 Insert a blank video tape into the VCR (VIDEO 1 or VIDEO 2) for recording.**
- 4 Start recording on the recording VCR, then start playing the video tape or laser disc you want to record.**

#### Tip

You can record the sound from any audio source onto a video tape while copying from a video tape or laser disc. Locate the point where you want to start recording from another audio source, select the program source, then start playback. The audio from that source will be recorded onto the audio track of the video tape instead of the audio from the original medium. To resume audio recording from the original medium, select the video source again.

#### Notes

- You cannot record a digital audio signal using a component connected to the analog VIDEO 1 OUT or VIDEO 2 OUT jacks.
- Make sure to make both digital and analog connections to the TV/SAT and DVD/LD inputs. Analog recording is not possible if you make only digital connections.
- Some sources contain copy guards to prevent recording. In this case, you may not be able to record from the sources.
- The analog audio signals of the current function is output from the REC OUT jacks.
- The signals input to the MULTI CHANNEL IN jacks are not output from the REC OUT jacks even when MULTI CH DIRECT is selected. The analog audio signals of the current function are output.

# CONTROL A1II/S-LINK control system

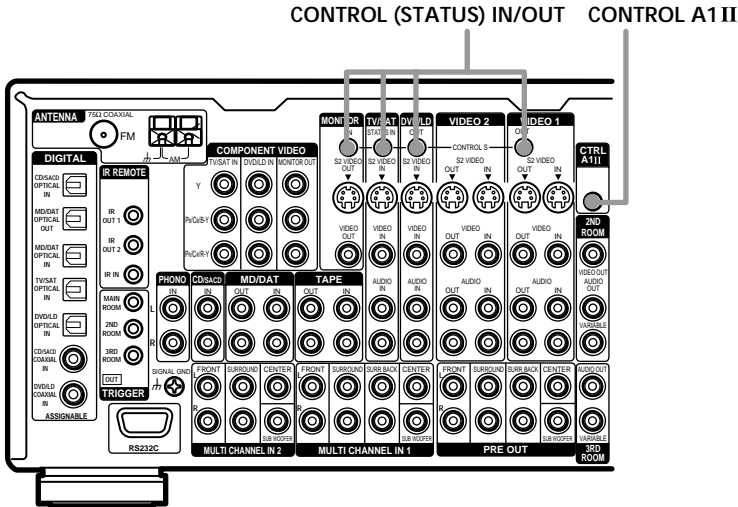

Other Operations

## Using the CONTROL A1 II system

### Getting Started

**This section explains the basic functions of the CONTROL A1II Control System. Certain components have special functions, like “CD Synchro Dubbing” on cassette decks, that require CONTROL A1II connections. For detailed information regarding specific operations, be sure to also refer to the Operating Instructions supplied with your component(s).**

The CONTROL A1II Control System was designed to simplify the operation of audio systems composed of separate Sony components. CONTROL A1II connections provide a path for the transmission of control signals which enable automatic operation and control features usually associated with integrated systems.

Currently, CONTROL A1II connections between a Sony CD player, amplifier (receiver), MD deck and cassette deck provide automatic function selection and synchronized recording.

In the future, the CONTROL A1II connection will work as a multifunction bus allowing you to control various functions for each component.

### Notes

- The CONTROL A1II Control System is designed to maintain upward compatibility as the Control System is upgraded to handle new functions. In this case, however, older components will not be compatible with the new functions.
- Do not operate a 2 way remote control unit when the CONTROL A1II jacks are connected via a PC interface kit to a personal computer running “MD Editor” or similar application. Also, do not operate the connected component in a manner contrary to the functions of the application, as this may cause the application to operate incorrectly.

**continued**

## CONTROL A1II/S-LINK control system (continued)

CONTROL A1 II and CONTROL A1 compatibility

The CONTROL A1 control system has been updated to the CONTROL A1II which is the standard system in the Sony 300 disc CD changer and other recent Sony components. Components with CONTROL A1 jacks are compatible with components with CONTROL A1II, and can be connected to each other. Basically, the majority of the functions available with the CONTROL A1 control system will be available with the CONTROL A1II control system.

However, when making connections between components with CONTROL A1 jacks and components with CONTROL A1II jacks, the number of functions that can be controlled may be limited depending on the component. For detailed information, refer to the operating instructions supplied with the component(s).

### CONTROL A1 II hookup

- **If you have a CONTROL A1 II compatible Sony CD player, Super Audio CD player, tape deck, or MD deck**

Use a CONTROL A1 cord (mini jack) (not supplied) to connect the CONTROL A1 II jack on the CD player, Super Audio CD player, tape deck, or MD deck to the CONTROL A1 II jack on the receiver. See page 60 and the operating instructions supplied with your CD player, Super Audio CD player, tape deck, or MD deck for details.

#### Note

If you make CONTROL A1II connections from the receiver to an MD deck that is also connected to a computer, do not operate the receiver while using the "Sony MD Editor" software. This may cause a malfunction.

- **If you have a Sony CD changer with a COMMAND MODE selector**

If your CD changer's COMMAND MODE selector can be set to CD 1, CD 2, or CD 3, be sure to set the command mode to "CD 1" and connect the changer to the CD jacks on the receiver.

If, however, you have a Sony CD changer with VIDEO OUT jacks, set the command mode to "CD 2" and connect the changer to the VIDEO 2 jacks on the receiver.

### Connections

Connect monaural (2P) mini-plug cords in series to the CONTROL A1 II jacks on the back of each component. You can connect up to 10 CONTROL A1 II compatible components in any order. However, you can connect only one of each type of component (i.e., 1 CD player, 1 MD deck, 1 tape deck and 1 receiver).

(You may be able to connect more than one CD player or MD deck, depending on the model. Refer to the operating instructions supplied with the respective component for details.)

#### Example

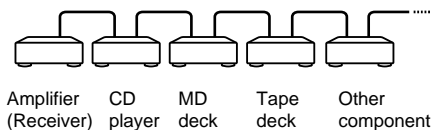

In the CONTROL A1 II control system, the control signals flow both ways, so there is no distinction of IN and OUT jacks. If a component has more than one CONTROL A1 II jack, you can use either one, or connect different components to each jack.

## Jacks and connection examples

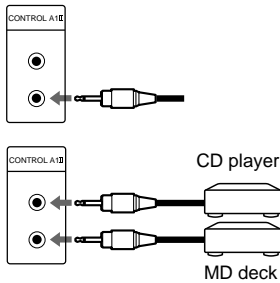

### On CONTROL A1 jacks and connections

It is possible to make connections between CONTROL A1 and CONTROL A1II jacks. For details regarding particular connections or set up options, refer to the operating instructions supplied with the component(s).

### About the connecting cord

Some CONTROL A1 compatible components are supplied with a connecting cord as an accessory. In this case, use the connecting cord for your connection.

When using a commercially available cord, use a monaural (2P) mini-plug cord less than 2 meters long, with no resistance.

## Basic Functions

The CONTROL A1II functions will operate as long as the component you want to operate is turned on, even if all of the other connected components are not turned on.

### ■ Automatic function selection

When you connect a CONTROL A1II compatible Sony amplifier (or receiver) to other Sony components using monaural mini-plug cords, the function selector on the amplifier (or receiver) automatically switches to the correct input when you press the play button on one of the connected components.

### Notes

- You must connect a CONTROL A1 compatible amplifier (receiver) using a monaural mini-plug cord in order to take advantage of the automatic function selection feature.
- This function only works when the components are connected to the amplifier (or receiver) inputs according to the names on the function buttons. Certain receivers allow you to switch the names of the function buttons. In this case, refer to the operating instructions supplied with the receiver.
- When recording, do not play any components other than the recording source. It will cause the automatic function selection to operate.

**continued**

## **CONTROL A1II/S-LINK control system (continued)**

### ■ Synchronized recording

This function lets you conduct synchronized recording between the selected source and recorder components.

- 1** Set the function selector on the amplifier (or receiver) to the source component.
- 2** Set the source component to pause mode (make sure both the ► and ■■ indicators light together).
- 3** Set the recorder component to the REC-PAUSE mode.
- 4** Press PAUSE on the recorder component.  
The source component is released from the pause mode, and recording begins shortly thereafter.  
When playback ends from the source component, recording stops.

#### Notes

- Do not set more than one component to the pause mode.
- Certain recorder components may be equipped with a special synchronized recording function that uses the CONTROL A1II Control System, like “CD Synchro Dubbing”. In this case, refer to the operating instructions supplied with the recorder component.

## Using S-LINK CONTROL S system

If you have a S-LINK CONTROL S-compatible Sony TV, satellite tuner, monitor, DVD player or VCR, use an audio/video/control S connecting cord (supplied) or a control S connecting cord (supplied) to connect the CTRL S (STATUS) IN (for TV, satellite tuner, or monitor) or OUT (for VCR, etc.) jack on the receiver to the appropriate S-LINK jack on the respective component. Refer to the operating instructions supplied with your TV, satellite tuner, monitor, VCR, etc., for details.

The following illustration is an example of S-LINK CONTROL S hookups between the receiver, a TV, a VCR, and a DVD player. When your TV is connected to the receiver as shown below, the TV input mode will change to video input whenever you turn on the receiver. When you connect the receiver as shown below, input mode of the receiver changes to VIDEO 1 or DVD/LD whenever you play your VCR or DVD.

The following connections also change the input mode of the receiver to TV whenever you operate your TV.



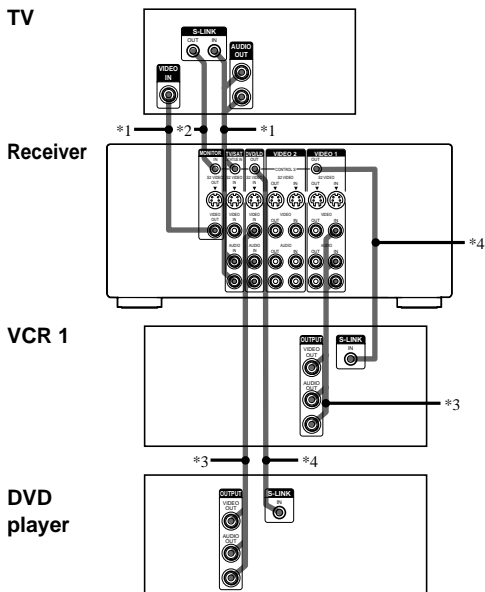

- \*1 Audio/video/control S cord (supplied).  
Pull the video cord away from the supplied audio/video/control S cord.
- \*2 Control S cord (supplied).
- \*3 Audio/video cord (not supplied).
- \*4 Control S cord (not supplied).  
Use a monaural (2P) mini-plug cord less than 2 meters long.

#### Note

Refer to the operating instructions supplied with your TV for details regarding the operations you can control from your TV.

For STR-DA7ES, two remotes are supplied (RM-TP1 and RM-US105A). For details on RM-TP1, refer to the separate operating instructions. For details on RM-US105A, refer to the following pages.

### Using the remote RM-US105A

#### When using as a simplified remote

This remote can be used as a simplified substitute of the supplied remote (RM-US105A). The following operations are possible:

- Adjusting the volume.
- Switching the power on or off.
- Switching sources.
- Controlling each component.
- Selecting a sound field.

When using this remote, the command mode of the remote and the receiver should be the same. As the default setting of the command mode of the receiver is “AV SYSTEM 2” and the default setting of the command mode of the remote is “AV SYSTEM 1”, set the command mode of the remote to “AV SYSTEM 2”.

#### Setting the command mode

**1 Press USE MODE momentarily with the tip of a pen, etc.**

The current command mode button slowly lights up 5 times.

**2 Press AV SYSTEM 2 while the button blinks.**

The AV SYSTEM 2 button lights up twice and the command mode changes.

#### Tip

When the command mode of the receiver is set to “AV SYSTEM 1”, press AV SYSTEM 1 instead of AV SYSTEM 2 in step 2 above.

#### Note

If the USE MODE indicator remains lit or blinks quickly, start over from step 1.

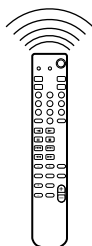
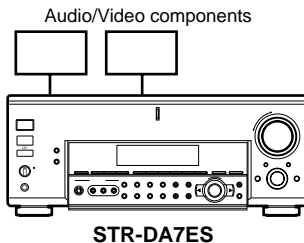

# Listening to the sound in another room

## 2ND ROOM OUT

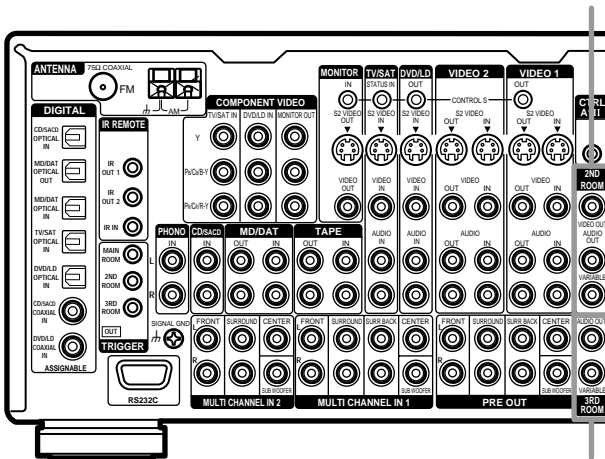

## 3RD ROOM OUT (STR-DA7ES only)

You can select video and analog audio signals for output to another room.

- 1 Press **POWER (2ND ROOM)** or **POWER (3RD ROOM) (STR-DA7ES only)** to turn on the amplifier in the 2nd room or 3rd room (STR-DA7ES only).
- 2 (STR-DA7ES) Press **2ND/3RD ROOM** repeatedly to select "2ND ROOM" or "3RD ROOM".  
(STR-DA4ES) Press **2ND ROOM**.
- 3 Turn the jog dial to select the source signals you wish to output.

### For 2ND ROOM

(Video and analog audio signals)

The sources change cyclically as follows:  
SOURCE\* → VIDEO 1 → VIDEO 2 → VIDEO 3 → DVD/LD → TV/SAT → TAPE → MD/DAT → CD/SACD → TUNER

### For 3RD ROOM (STR-DA7ES only)

(Analog audio signals only)

The sources change cyclically as follows:  
SOURCE\* → VIDEO 1 → VIDEO 2 → VIDEO 3 → DVD/LD → TV/SAT → TAPE → MD/DAT → CD/SACD → TUNER

\* The signals of the current function is output.

### Tips

- Only signals from components connected to the analog input jacks are output through the 2ND ROOM OUT jacks. No signals are output from components connected to only the digital input jacks.
- When "SOURCE" is selected, the signals input to the MULTI CH IN jacks are not output from the 2ND ROOM OUT jacks even when MULTI CH DIRECT is selected. The analog audio signals of the current function are output.

### Notes

- When you turn off the receiver in the main room, the components in the 2nd or 3rd room also turn off.
- The default setting of the volume is  $-\infty$  dB (no sound output).

Operations Using the Remote (STR-DA7ES only)

continued

## Listening to the sound in another room (continued)

### ■ 2nd room operation

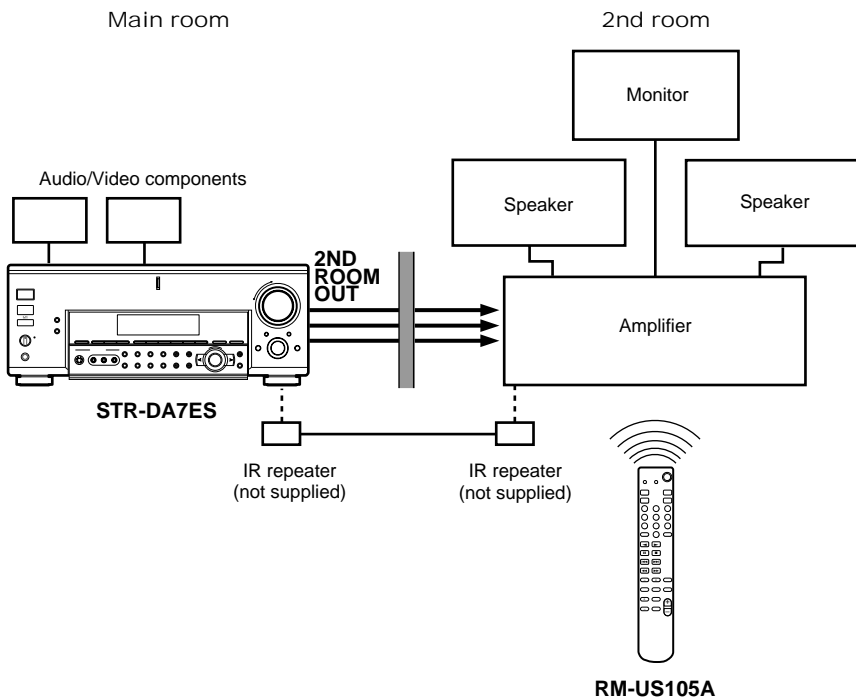

Using an optional IR repeater as shown above

The following operations are possible with the RM-US105A remote:

- Switching the output source for the 2ND ROOM OUT jacks.
- Adjusting the volume from the 2ND ROOM OUT jacks.
- Switching the output to the 2ND ROOM OUT jacks on or off.

Set the command mode of the RM-US105A remote to the 2ND ROOM mode.

#### 1 Press **USE MODE** momentarily.

The current command mode button slowly lights up 5 times.

#### 2 While the button blinks, press **AV SYSTEM 1** or **AV SYSTEM 2** according to the command mode of the receiver in the main room.

#### 3 Press **USE MODE** momentarily again.

#### 4 Press **2ND ROOM** while the button blinks.

The command mode has been set to the 2nd room mode.

Tip

Once steps 1 and 2 are done, the setting is stored in the remote's memory. However, when you change the command mode of the receiver, perform steps 1 to 4 again.

## ■ 3rd room operation

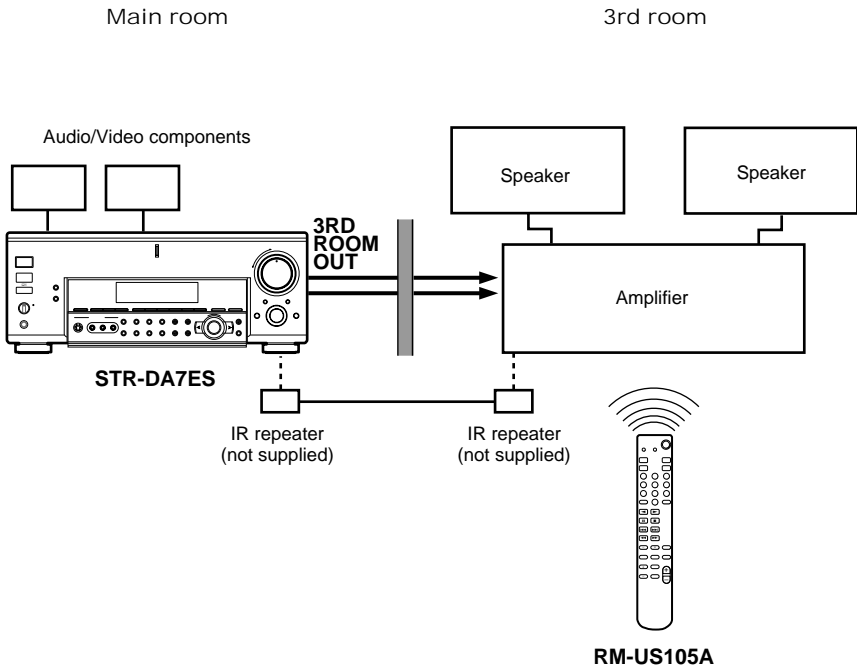

Using an optional IR repeater as shown above

The following operations are possible with the RM-US105A remote:

- Switching the output source for the 3RD ROOM OUT jacks.
- Adjusting the volume from the 3RD ROOM OUT jacks.
- Switching the output to the 3RD ROOM OUT jacks on or off.

Set the command mode of the RM-US105A remote to the 3RD ROOM mode.

### 1 Press USE MODE momentarily.

The current command mode button slowly lights up 5 times.

### 2 While the button blinks, press AV SYSTEM 1 or AV SYSTEM 2 according to the command mode of the receiver in the main room.

### 3 Press USE MODE momentarily again.

### 4 Press 3RD ROOM while the button blinks.

The command mode has been set to the 3rd room mode.

#### Tip

Once steps 1 and 2 are done, the setting is stored in the remote's memory. However, when you change the command mode of the receiver, perform steps 1 to 4 again.

## Listening to the sound in another room (continued)

### Inserting batteries into the remote

Insert two R6 (size-AA) batteries with the + and – properly oriented in the battery compartment. When using the remote, point it at the remote sensor on the receiver.

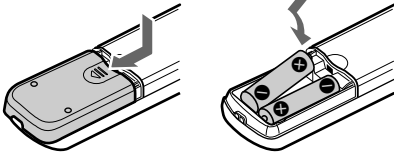

#### Tip

Under normal conditions, the batteries should last for about 6 months. When the remote no longer operates the receiver, replace both batteries with new ones.

#### Notes

- Do not leave the remote in an extremely hot or humid place.
- Do not use a new battery with an old one.
- Do not expose the remote sensor of the receiver to direct sunlight or lighting apparatuses. Doing so may cause a malfunction.
- If you don't use the remote for an extended period of time, remove the batteries to avoid possible damage from battery leakage and corrosion.

## Location of parts

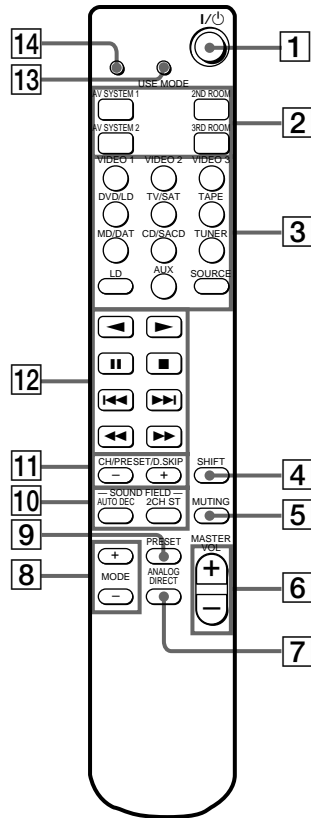

### 1 I/Power switch

Press to turn the receiver on or off, or to turn the 2nd (or 3rd) room output on or off.

### 2 Command mode buttons

Press to select the command mode.

#### Tips

- Each time you press a function button or other operation buttons on the remote, the current command mode button lights up.
- You can switch the command mode temporarily. For example, when set to AV SYSTEM 1, if you press CD/SACD while holding down AV SYSTEM 2, the signal for AV SYSTEM 2 mode is output.

**3 Function buttons**

The function changes according to the mode of the remote.

**AV SYSTEM 1/2: Press to select the source of the receiver.**

**2ND ROOM: Press to select the source you want to output from the 2ND ROOM jacks.**

**3RD ROOM: Press to select the source you want to output from the 3RD ROOM jacks.**

Press one of the buttons to select the component you want to use. When you press any of the function buttons, the receiver turns on. The components are factory assigned to the buttons as follows. When you want to assign other components, program the remote following the steps in “Changing the button assignments”.

Button	Assigned component
VIDEO1	VCR (VTR mode 3)
VIDEO2	VCR (VTR mode 1)
VIDEO3	VCR (VTR mode 2)
DVD/LD	DVD player
TV/SAT	TV tuner
TAPE	Tape deck B
MD/DAT	MD deck
CD/SACD	CD/Super Audio CD player
TUNER	Built-in tuner <sup>1)</sup>
LD <sup>2)</sup>	LD player
AUX <sup>2)</sup>	—
SOURCE	2ND ROOM, 3RD ROOM only

<sup>1)</sup> The setting cannot be changed.

<sup>2)</sup> LD and AUX do not operate this unit (STR-DA7ES/STR-DA4ES).

**4 SHIFT button**

When the tuner is selected, press repeatedly to select a memory page for presetting radio stations or tuning to preset stations.

**5 MUTING button**

The function of this button is same as the MUTING button on the receiver. See page 27.

**6 MASTER VOL +/- buttons**

Press to adjust the volume level of all speakers at the same time.

**7 ANALOG DIRECT button**

The function of this button is same as the ANALOG DIRECT button on the receiver. See page 34.

**8 MODE +/- buttons**

The function of these buttons is same as the MODE +/- buttons on the receiver. See pages 36–37.

**9 PRESET button**

Press to select CINEMA STUDIO EX A–C or D.CONCERT HALL A, B.

**10 SOUND FIELD AUTO DEC/2CH ST buttons**

The function of these buttons is same as the AUTO DEC and 2CH STEREO buttons on the receiver. See page 34.

**11 CH/PRESET/D.SKIP/+/- buttons\***

Press repeatedly to select a preset station or channel. When using a multi-disc changer, press to skip a disc.

**12 Operation buttons\***

The following table describes the function of the buttons.

Button(s)	Function
▶	Starts play. (Starts play on the front side of the cassette.)
◀	Starts play on the reverse side of the cassette.
	Pauses play or recording, and starts recording when the component is in recording standby.
■	Stops play.
◀◀/▶▶	Skips tracks.
◀◀/▶▶	Fast forwards or rewinds.

**continued**

## **Listening to the sound in another room (continued)**

### **13 USE MODE button**

Press to change the mode of the remote or to change the category of the buttons.

### **14 USE MODE indicator**

\* The function of these buttons switches automatically each time you press the function buttons (13). The above explanation is intended to serve as an example only. Therefore, depending on the component, the above operation may not be possible or may operate differently than described.

#### **Tip**

To clear all programmed signals, press 1/⏻ and USE MODE at the same time. The remote is reset to its factory-setting.

## **Changing button assignments**

You can change the factory settings of the function buttons to suit the components in your system. For example, if you connect a LD player to the VIDEO 2 jacks on the receiver, you can set the VIDEO2 button on this remote to control the LD player.

Note, however, that the settings of the TUNER button cannot be changed.

### **1 Press USE MODE for more than 2 seconds.**

The indicator remains lit.

### **2 Press the function button you want to change the assignment of.**

The indicator turns off when a valid button is pressed. Only the first function button that is pressed will be registered.

Example: Press VIDEO2.

### **3 Press the function button whose assignment you want to change.**

See the table below for the factory assigned categories of each button. To select "2nd pressed" or "3rd pressed" categories, press the same button twice or three times. The indicator turns off when a valid button is pressed.

Example: Press DVD/LD twice.

### **4 Press SOURCE.**

The new assignment is registered.

The indicator slowly lights up twice, then goes off.

#### **Tip**

If the operation is unsuccessful, the indicator flashes four times and the remote automatically exits the button assignment mode. In this case, the new assignment is not registered and the previous setting remains.



## Notes

- If you do not press a button during step 2 through 4 within thirty seconds, the remote automatically exits the button assignment mode. Start again from step 1.
- In step 3, if you press the same button more than the possible number of categories that can be selected, only the last category is registered for the new assignment.
- In step 3, if you press several function buttons, the category of the last pressed button is selected.

## Valid buttons and the corresponding categories

Button	Categories*		
	1st pressed	2nd pressed	3rd pressed
VIDEO1	VTR1	VTR4	—
VIDEO2	VTR2	VTR5	—
VIDEO3	VTR3	VTR6	—
DVD/LD	DVD player	LD player	—
TV/SAT	TV	SAT	—
TAPE	Tape deck A	Tape deck B	—
MD/DAT	MD deck	DAT deck	—
CD/SACD	CD player 1	CD player 2	CD player 3

\* To assign to VIDEO CD, press VIDEO 1 first, then press CD/SACD.

To clear all remote button assignments

Hold Down USE MODE, then press I/⏻.

## Advanced remote operations

When using a Sony receiver as an amplifier in the 2nd (or 3rd) room, the following operations are possible:

- Switching the output source for the 2ND (or 3RD) ROOM OUT jacks.
- Switching the Sony receiver's power on or off in the 2nd (or 3rd) room.
- Adjusting the volume of the Sony receiver in the 2nd (or 3rd) room.

## Notes

- This receiver has only 2 command modes (AV SYSTEM 1 and AV SYSTEM 2). Therefore this receiver should only be used as an amplifier for one additional room (2nd or 3rd room). The first command mode will be used for the main room, the second can be used for either the 2nd or 3rd room.
- When using this remote in the 2nd (3rd) room, be sure to set each receiver (main room and 2nd (3rd) room) to a different command mode. The reason for this is that if the command modes of the two receivers are the same, the volume of the receiver in the main room will increase when you raise the volume in the 2nd (3rd) room.

**continued**

## Listening to the sound in another room (continued)

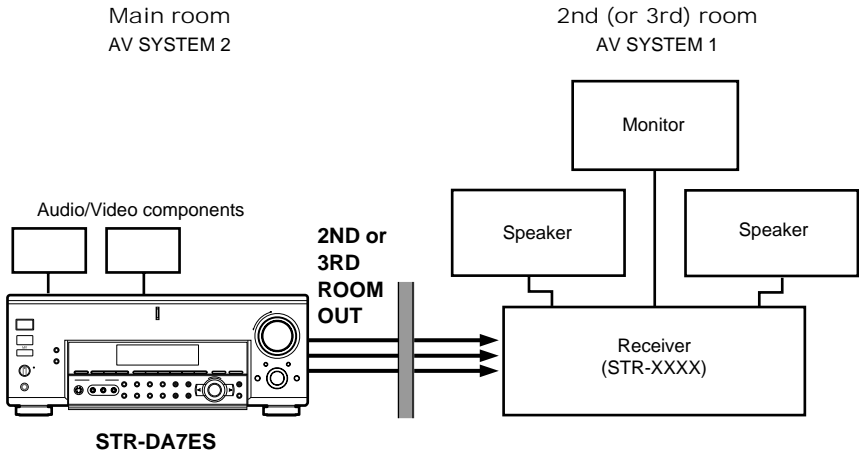

To change button assignments for the 2nd room mode

When the remote is set to the 2nd room mode, you can set the remote to turn the receiver on/off or adjust the volume.

You can assign the following buttons:

I/⏻, MUTING, MASTER VOL +, MASTER VOL -

Example: To set the command mode of above 4 buttons to "AV SYSTEM 1" while in the 2nd room mode.

**1 Press USE MODE more than 2 seconds.**  
The indicator remains lit.

**2 Press 2ND ROOM.**

**3 Press AV SYSTEM 1.**

**4 Press SOURCE.**

The indicator slowly lights up twice, then goes off.

For the above 4 buttons, the signals for AV SYSTEM 1 are output even in the 2nd room mode. Besides, you can operate the receiver whose command mode is "AV SYSTEM 1".

To change assignments for the 3rd room

Press 3RD ROOM in step 2.

### Note

To reset the assignments of I/⏻, MUTING, MASTER VOL +, MASTER VOL -, press 2ND ROOM (during 2nd room mode) or 3RD ROOM (during 3rd room mode) in step 3. Or, clear all remote button assignments (page 73), then perform the procedures on page 68 or 69.

To set the remote RM-US105A not to adjust the volume

Press the following buttons in step 3:

- 3RD ROOM (during 2nd room mode)
- 2ND ROOM (during 3rd room mode)

This locks the use of I/⏻, MASTER VOL +, MASTER VOL - on the remote RM-US105A from controlling any receiver in the main/2nd/3rd room.

## Precautions

### On safety

Should any solid object or liquid fall into the cabinet, unplug the receiver and have it checked by qualified personnel before operating it any further.

### On power sources

- Before operating the unit, check that the operating voltage is identical with your local power supply. The operating voltage is indicated on the nameplate at the rear of the receiver.
- The unit is not disconnected from the AC power source (mains) as long as it is connected to the wall outlet, even if the receiver itself has been turned off.
- If you are not going to use the receiver for a long time, be sure to disconnect the receiver from the wall outlet. To disconnect the AC power cord, grasp the plug itself; never pull the cord.
- One blade of the plug is wider than the other for the purpose of safety and will fit into the wall outlet only one way. If you are unable to insert the plug fully into the outlet, contact your dealer.
- AC power cord must be changed only at the qualified service shop.

### On heat buildup

Although the unit heats up during operation, this is not a malfunction. If you continuously use this unit at a large volume, the cabinet temperature of the top, side and bottom rises considerably. To avoid burning yourself, do not touch the cabinet.

### On placement

- Place the receiver in a location with adequate ventilation to prevent heat buildup and prolong the life of the receiver.
- Do not place the receiver near heat sources, or in a place subject to direct sunlight, excessive dust or mechanical shock.
- Do not place anything on top of the cabinet that might block the ventilation holes and cause malfunctions.

### On operation

Before connecting other components, be sure to turn off and unplug the receiver.

### On cleaning

Clean the cabinet, panel and controls with a soft cloth slightly moistened with a mild detergent solution. Do not use any type of abrasive pad, scouring powder or solvent such as alcohol or benzene.

If you have any question or problem concerning your receiver, please consult your nearest Sony dealer.

## Troubleshooting

If you experience any of the following difficulties while using the receiver, use this troubleshooting guide to help you remedy the problem. Should any problem persist, consult your nearest Sony dealer.

---

### **There is no sound no matter which component is selected.**

- Check that both the receiver and all components are turned on.
- Check that the MASTER VOLUME control is not set at  $-\infty$  dB.
- Check that the SPEAKERS switch is not set to OFF (page 59).
- Check that all speaker cords are connected correctly.
- Press MUTING to cancel the muting function.

---

### **“Not PCM” appears in the display and no sound is heard.**

- Set “DECODE FORMAT” to “AUTO” in the CUSTOMIZE menu (page 48).

---

### **There is no sound from a specific component.**

- Check that the component is connected correctly to the audio input jacks for that component.
- Check that the cord(s) used for the connection is (are) fully inserted into the jacks on both the receiver and the component.

---

### **There is no sound from one of the front speakers.**

- Connect a pair of headphones to the PHONES jack to verify that sound is output from the headphones.

If only one channel is output from the headphones, the component may not be connected to the receiver correctly. Check that all the cords are fully inserted into the jacks on both the receiver and the component.

If both channels are output from the headphones, the front speaker may not be connected to the receiver correctly. Check the connection of the front speaker which is not outputting any sound.

**continued**

## Troubleshooting (continued)

---

### There is no sound or only a very low-level sound is heard.

- Check that the speakers and components are connected securely.
- Check that you have selected the correct component on the receiver.
- Check that the SPEAKERS switch is not set to OFF (page 59).
- Check that the headphones are not connected.
- Press MUTING to cancel the muting function.
- The protective device on the receiver has been activated because of a short circuit. Turn off the receiver, eliminate the short-circuit problem and turn on the power again.
- When only a very low-level sound is heard, check to see if NIGHT MODE is activated (page 38).

---

### The left and right sounds are unbalanced or reversed.

- Check that the speakers and components are connected correctly and securely.
- Adjust balance parameters in the LEVEL menu.

---

### There is severe hum or noise.

- Check that the speakers and components are connected securely.
- Check that the connecting cords are away from a transformer or motor, and at least 3 meters away from a TV set or fluorescent light.
- Move your TV away from the audio components.
- Make sure you have grounded  $\hbar$  SIGNAL GND terminal (only when a turntable is connected).
- The plugs and jacks are dirty. Wipe them with a cloth slightly moistened with alcohol.

---

### There is no sound from the center speaker.

- Make sure the sound field function is on (press MODE +/-).
- Select the CINEMA STUDIO EX mode (page 35).
- Adjust the speaker level (page 44).
- Make sure the center speaker size parameter is set to either "SMALL" or "LARGE" (page 22).

---

### There is no sound or only a very low-level sound is heard from the surround/surround back speakers.

- Make sure the sound field function is on (press MODE +/-).
- Select the CINEMA STUDIO EX mode (page 35).
- Adjust the speaker level (page 44).
- Make sure the surround/surround back speaker size parameter is set to either "SMALL" or "LARGE" (pages 22–23).

---

### The surround effect cannot be obtained.

- Make sure the sound field function is on (press MODE +/-).
- Sound fields do not function for the signals with a sampling frequency of more than 48 kHz.
- When the INPUT MODE is set to "AUTO MULTI CH 1 or 2" and no digital signal is input, or INPUT MODE is set to "MULTI CH 1 or 2 FIXED", you cannot change the sound field (page 42).

---

### Dolby Digital or DTS multi channel sound is not reproduced.

- Check that the playing DVD, etc. is recorded in Dolby Digital or DTS format.
- When connecting the DVD player, etc. to the digital input jacks of this receiver, check the audio setting (settings for the audio output) of the connected component.

---

### Recording cannot be done.

- Check that the components are connected correctly.
- Select the source component with FUNCTION control.
- When recording from a digital component, make sure the INPUT MODE is set to ANALOG 2CH FIXED (page 42) before recording with a component connected to the analog MD/DAT or TAPE terminals.
- When recording from a digital component, make sure the INPUT MODE is set to COAXIAL FIXED or OPTICAL FIXED (page 42) before recording with the component connected to the DIGITAL MD/DAT OUT terminals.
- Set "D.POWER" to "ALWAYS ON" when ANALOG DIRECT is selected, for the digital audio signal is not output in "AUTO OFF" setting.

**To connect an LD player via an RF demodulator**

- Connect the LD player to the RF demodulator, then connect the RF demodulator's optical or coaxial digital output to the receiver's DVD/LD OPTICAL IN or COAXIAL jack. When making this connection, be sure to set INPUT MODE manually (page 42). The receiver may not operate correctly if INPUT MODE is set to AUTO 2CH.

For details on DOLBY DIGITAL RF hookups, see the operating instructions supplied with your RF demodulator.

**The FM reception is poor.**

- Use a 75-ohm coaxial cable (not supplied) to connect the receiver to an outdoor FM antenna as shown below. If you connect the receiver to an outdoor antenna, ground it against lightning. To prevent a gas explosion, do not connect the ground wire to a gas pipe.

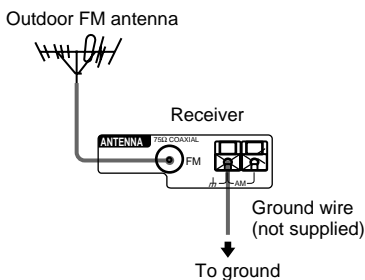
**Radio stations cannot be tuned in.**

- Check that the antennas are connected securely. Adjust the antennas and connect an external antenna if necessary.
- The signal strength of the stations is too weak (when tuning in with automatic tuning). Use direct tuning.
- Make sure you set the tuning interval correctly (when tuning in AM stations with direct tuning).
- No stations have been preset or the preset stations have been cleared (when tuning by scanning preset stations). Preset the stations (page 30).
- Press DISPLAY so that the frequency appears in the display.

**There is no picture or an unclear picture appears on the TV screen or monitor.**

- Select the appropriate function on the receiver.
- Set your TV to the appropriate input mode.
- Move your TV away from the audio components.

## Remote control

**The remote does not function.**

- Point the remote at the remote sensor on the receiver.
- Remove any obstacles in the path between the remote and the receiver.
- Replace all the batteries in the remote with new ones, if they are weak.
- If the receiver's COMMAND MODE and the remote's COMMAND MODE do not match, transmission is not possible between the remote and the receiver (page 49).
- Make sure you select the correct function on the remote.
- When you operate a programmed non-Sony component, the remote may not function properly depending on the model and the make of the component.

Reference sections for clearing the memory

To clear	See
All memorized settings	page 21
Customized sound fields	page 45
All the settings in the remote	page 73

# Specifications

## AUDIO POWER SPECIFICATIONS

### POWER OUTPUT AND TOTAL HARMONIC DISTORTION:

#### STR-DA7ES

With 8 ohm loads, both channels driven, from 20 – 20,000 Hz; rated 120 watts per channel minimum RMS power, with no more than 0.05 % total harmonic distortion from 250 milliwatts to rated output.

#### STR-DA4ES

With 8 ohm loads, both channels driven, from 20 – 20,000 Hz; rated 110 watts per channel minimum RMS power, with no more than 0.05 % total harmonic distortion from 250 milliwatts to rated output.

### Amplifier section

#### POWER OUTPUT

##### Rated Power Output at Stereo Mode

(8 ohms 20 Hz – 20 kHz, THD 0.05 %)

STR-DA7ES: 120 W + 120 W

STR-DA4ES: 110 W + 110 W

(4 ohms 20 Hz – 20 kHz, THD 0.09 %)

STR-DA7ES: 100 W + 100 W

STR-DA4ES: 90 W + 90 W

#### Reference Power Output

(8 ohms 20 Hz – 20 kHz, THD 0.05 %)

STR-DA7ES: FRONT<sup>1)</sup>: 120 W + 120 W

CENTER<sup>1)</sup>: 120 W

SURR<sup>1)</sup>: 120 W + 120 W

SURR BACK<sup>1)</sup>:  
120 W + 120 W

STR-DA4ES: FRONT<sup>1)</sup>: 110 W + 110 W

CENTER<sup>1)</sup>: 110 W

SURR<sup>1)</sup>: 110 W + 110 W

SURR BACK<sup>1)</sup>:  
110 W + 110 W

(4 ohms 20 Hz – 20 kHz, THD 0.09 %)

STR-DA7ES: FRONT<sup>1)</sup>: 100 W + 100 W

CENTER<sup>1)</sup>: 100 W

SURR<sup>1)</sup>: 100 W + 100 W

SURR BACK<sup>1)</sup>:  
100 W + 100 W

STR-DA4ES: FRONT<sup>1)</sup>: 90 W + 90 W

CENTER<sup>1)</sup>: 90 W

SURR<sup>1)</sup>: 90 W + 90 W

SURR BACK<sup>1)</sup>:  
90 W + 90 W

1) Depending on the sound field settings and the source, there may be no sound output.

## Frequency response

PHONO	RIAA equalization curve ±0.5 dB
CD/SACD, TAPE, MD/DAT, TV/SAT, DVD/LD, VIDEO 1, 2, 3	10 Hz – 100 kHz +0.5/-2 dB (with sound field, equalizer, and bass boost bypassed)

## Inputs (Analog)

PHONO	Sensitivity: 2.5 mV Impedance: 50 kilohms S/N <sup>2)</sup> : 86 dB (A, 2.5 mV <sup>3)</sup> )
MULTI CHANNEL IN 1, 2, CD/SACD, TAPE, MD/DAT, DVD/LD, TV/SAT, VIDEO 1, 2, 3	Sensitivity: 150 mV Impedance: 50 kilohms S/N <sup>2)</sup> : 100 dB (A, 150 mV <sup>3)</sup> )

2) INPUT SHORT.

3) Weighted network, input level.

## Inputs (Digital)

CD/SACD, DVD/LD (Coaxial)	Sensitivity: – Impedance: 75 ohms S/N: 100 dB (A, 20 kHz LPF)
CD/SACD, DVD/LD, TV/SAT, MD/DAT (Optical)	Sensitivity: – Impedance: – S/N: 100 dB (A, 20 kHz LPF)

## Outputs

TAPE, MD/DAT (REC OUT), VIDEO 1, 2 (AUDIO OUT)	Voltage: 150 mV Impedance: 10 kilohms
FRONT L/R, CENTER, SURROUND L/R, SURROUND BACK L/R, SUB WOOFER	Voltage: 2 V Impedance: 1 kilohms

## EQ

BASS:	99 Hz~1.0 kHz (21 steps)
MID (FRONT L/R, CENTER only):	198 Hz~10 kHz (36 steps)
TREBLE:	1.0 kHz~10 kHz (23 steps)
Gain levels:	±10 dB, 0.5 dB step

## FM tuner section

<b>Tuning range</b>	87.5 - 108.0 MHz
<b>Antenna terminals</b>	75 ohms, unbalanced
<b>Sensitivity</b>	
Mono:	18.3 dBf, 2.2 $\mu$ V/75 ohms
Stereo:	38.3 dBf, 22.5 $\mu$ V/75 ohms
<b>Usable sensitivity</b>	11.2 dBf, 1 $\mu$ V/75 ohms
<b>S/N</b>	
Mono:	76 dB
Stereo:	70 dB
<b>Harmonic distortion at 1 kHz</b>	
Mono:	0.3%
Stereo:	0.5%
<b>Separation</b>	45 dB at 1 kHz
<b>Frequency response</b>	30 Hz – 15 kHz, +0.5/-2 dB
<b>Selectivity</b>	60 dB at 400 kHz

## AM tuner section

<b>Tuning range</b>	
With 10-kHz tuning scale:	530 – 1,710 kHz <sup>4)</sup>
With 9-kHz tuning scale:	531 – 1,710 kHz <sup>4)</sup>
<b>Antenna</b>	Loop antenna
<b>Usable sensitivity</b>	50 dB/m (at 1,000 kHz or 999 kHz)
<b>S/N</b>	54 dB (at 50 mV/m)
<b>Harmonic distortion</b>	0.5 % (50 mV/m, 400 Hz)
<b>Selectivity</b>	
At 9 kHz:	35 dB
At 10 kHz:	40 dB

- 4) You can change the AM tuning scale to 9 kHz or 10 kHz. After tuning in any AM station, turn off the receiver. Hold down TUNING + and press I/⏻. All preset stations will be erased when you change the tuning scale. To reset the scale to 10 kHz (or 9 kHz), repeat the procedure.

## Video section

### Inputs/Outputs

Video:	1 V <sub>p-p</sub> , 75 ohms
S-video:	Y: 1 V <sub>p-p</sub> , 75 ohms C: 0.286 V <sub>p-p</sub> , 75 ohms
COMPONENT VIDEO:	Y: 1 V <sub>p-p</sub> , 75 ohms B-Y: 0.7 V <sub>p-p</sub> , 75 ohms R-Y: 0.7 V <sub>p-p</sub> , 75 ohms

Remote control RM-US105A  
(STR-DA7ES only)

### Remote control system

Infrared control

<b>Power requirements</b>	3 V DC with two R6 (size-AA) batteries
<b>Dimensions</b>	210 × 45 × 25 mm
<b>Mass (approx.)</b>	95 g excluding batteries

### General

<b>Power requirements</b>	120 V AC, 60 Hz
---------------------------	-----------------

### Power consumption

Models of area code U	
STR-DA7ES:	450 W
STR-DA4ES:	420 W

Models of area code CA

STR-DA7ES:	490 VA
STR-DA4ES:	470 VA

<b>Power consumption (during standby mode)</b>	1 W
--	-----

<b>AC outlets</b>	2 switched, 120 W/1A
-------------------	----------------------

<b>Dimensions</b>	430 × 174 × 465 mm including projecting parts and controls
-------------------	--

### Mass (Approx.)

STR-DA7ES:	21.0 kg
STR-DA4ES:	21.0 kg

### Supplied accessories

FM wire antenna (1)  
AM loop antenna (1)  
Audio/video/control S cord (1)  
Control S cord (mini jack) (1)  
STR-DA7ES only;  
Remote commander RM-TP1 (1)  
Base unit RMB-TP1 (1 for RM-TP1)  
AC adapter (1 for RM-TP1)  
Remote commander RM-US105A (1)  
R6 (size-AA) batteries (2)  
STR-DA4ES only;  
Remote commander RM-LP211 (1)  
R6 (size-AA) batteries (3)

For details on the area code of the component you are using, see page 3.

Design and specifications are subject to change without notice.

# Index

## A, B

### Adjusting

- brightness of the display 31
- CUSTOMIZE parameters 47, 58
- EQ parameters 45, 55
- LEVEL parameters 44, 54
- SET UP parameters 21, 49
- speaker volumes 26
- SURROUND parameters 43, 52

Automatic tuning 28

## C

### Changing

- display 31
- effect level 43

Clearing receiver's memory 21

Crossover frequency 51–52

CUSTOMIZE menu 47, 58

## D

Digital Cinema Sound 35

Direct tuning 29

Dubbing. See Recording

## E, F, G, H

Editing. See Recording

Effect level 43

EQ menu 45, 55

## I, J, K

Indexing. See Naming

## L, M

Labeling. See Naming

LEVEL menu 44, 54

## N

Naming 58

## O

OSD 49

## P, Q

Preset stations

how to preset 30

how to tune 30

## R

Recording

on an audio tape or MD 60

on a video tape 60

## S

Scanning

preset stations. See Preset tuning

radio stations. See Automatic tuning

Selecting

component 27

front speaker system 59

sound field 35–37

SET UP menu 21, 49

Sleep timer 59

Sound field

customizing 43

pre-programmed 35–37

resetting 45

selecting 35–37

Speakers

adjusting speaker volume 26

connection 19

impedance 18

placement 18

Supplied accessories 79

SURROUND menu 43, 52

## T, U, V, W, X, Y, Z

Test tone 26

Tuning

automatically 28

directly 29

preset stations 30

## Numbers

2nd room 67–69

3rd room 67–69



## Free Manuals Download Website

<http://myh66.com>

<http://usermanuals.us>

<http://www.somanuals.com>

<http://www.4manuals.cc>

<http://www.manual-lib.com>

<http://www.404manual.com>

<http://www.luxmanual.com>

<http://aubethermostatmanual.com>

Golf course search by state

<http://golfingnear.com>

Email search by domain

<http://emailbydomain.com>

Auto manuals search

<http://auto.somanuals.com>

TV manuals search

<http://tv.somanuals.com>