

/ Marley NC Class Stainless Crossflow Cooling Tower /

Product Specifications



Specifications / Base

Base	4
Thermal Performance	4
Performance Warranty	5
Design Loading	5
Construction	6
Mechanical Equipment	7
Fill, Louvers and Drift Eliminators	8
Hot Water Distribution System	9
Casing, Fan Deck and Fan Cylinder	9
Access	10
Cold Water Collection Basin	10

Specifications / Options

Convenience and Safety Options

Guardrail and Ladder	11
Ladder Extension	11
Ladder Safety Cage	11
Ladder Safety Gate	11
Access Door Platform	12
Plenum Walkway	12
Interior Mechanical Equipment Access Platform	12

Control Options

Fan Motor Starter Control Panel	14
Vibration Limit Switch	15
Basin Heater	15
Electric Water Level Control	15
Fan Motor Variable Speed Drive	16
Marley Premium VFD System	17

Miscellaneous Options

Motor Outside of the Airstream	18
Fan Cylinder Extensions	18
Inlet Flow Control Valves	19
Equalizer Flume Weir Gate	19
Sound Control	19
Inlet Sound Attenuators	19
Outlet Sound Attenuators	20
Low Noise Fan	20
Ultra Low-Noise Fan	21
Single Hot Water Inlet Connection	21
Air Inlet Screens	21
High Wind/Seismic Designs	21
Multicell Basin Equalizer Outlets	22
Basin Sweeper Piping	22
Extended Geareducer Lube Line Dipstick	22



NC Class Stainless Steel towers are factory assembled, crossflow cooling towers, designed to serve air conditioning and refrigeration systems as well as light to medium industrial process loads on clean water. They evolve from a factory-assembled concept of towers pioneered by Marley some 50 years ago, and incorporate all of the design advancements that our customers have found valuable. The **NC Class** has been designed specifically for sound control and tonnage density and represents the current state of the art in this cooling tower category.

This booklet not only relates the language to use in describing an appropriate **NC Class** cooling tower—but also defines why certain items and features are important enough to specify with the intention of insisting upon compliance by all bidders. The left-hand column of pages 4 thru 22 provides appropriate text for the various specification paragraphs, whereas the right hand column comments on the meaning of the subject matter and explains its value.

Pages 4 thru 10 indicate those paragraphs which will result in the purchase of a basic cooling tower—one that accomplishes the specified thermal performance, but which will lack many operation—and maintenance-enhancing accessories and features that are usually desired by those persons who are responsible for the continued and continuing operation of the system of which the tower is part. It will also incorporate those standard materials which testing and experience has proven to provide acceptable longevity in normal operating conditions.

Pages 11 thru 22 provide paragraphs intended to add those features, components and materials that will customize the tower to meet the user's requirements.

Space does not permit definition and explanation of all of the possible options that can be applied to the **NC Class**. We realize that you, the purchaser, must be happy with the tower's characteristics, and we are prepared to provide—or provide for—any reasonable enhancement that you are willing to define and purchase. *Your needs will become part of the continuing evolution of this Marley product line.*

Specifications	Specification Value
<p>1.0 Base:</p> <p>1.1 Provide an induced draft, crossflow type, factory assembled, film fill, industrial duty, stainless steel cooling tower situated as shown on the plans. The limiting overall dimensions of the tower shall be _____ wide, _____ long, and _____ high. Total operating kilowatt of all fans shall not exceed _____ kW, consisting of ____ @ _____ kW motor(s). Tower shall be similar and equal in all respects to Marley Model _____.</p>	<p>■ Your specification base establishes the type, configuration, base material and physical limitations of the cooling tower to be quoted. During the planning and layout stages of your project, you will have focused your attention on a cooling tower selection that fits your space allotment, and whose power usage is acceptable. Limitations on physical size and total operating horsepower avoid the introduction of unforeseen operational and site-related influences. Specifying the number of cells, and the maximum fan kW/cell will work to your advantage.</p> <p>The benefit of crossflow towers is that they are inherently easy to operate, access and maintain. Compared to counterflow towers, crossflow towers have a spacious plenum between banks of fill for easy access to all of the tower's internal components, plus the water distribution system is adjacent to the fan deck and can be maintained during operation.</p> <p>The NC is also available unassembled for on-site assembly.</p>

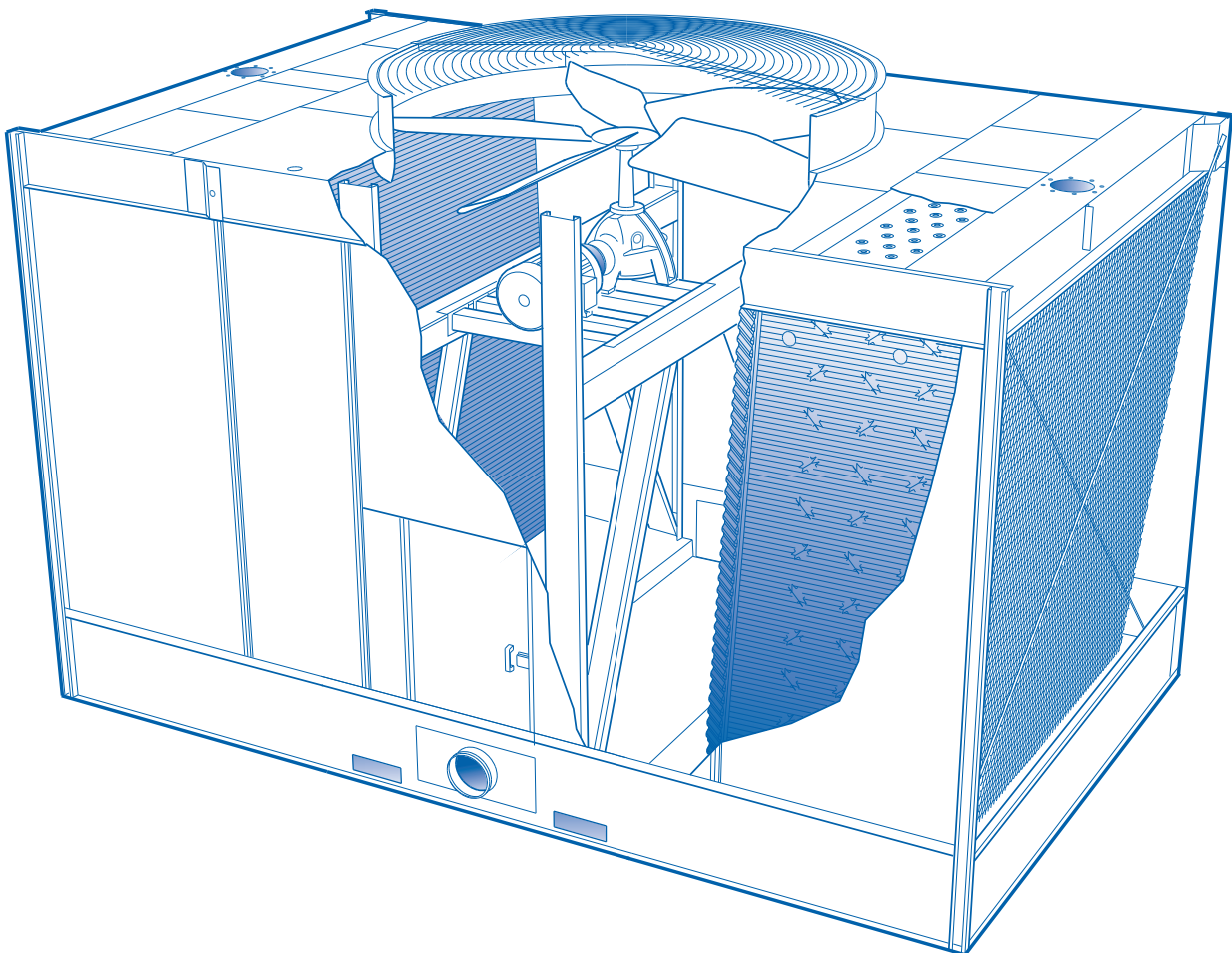

Specifications	Specification Value
<p>2.0 Thermal Performance and Efficiency:</p> <p>2.1 The tower shall be capable of cooling _____ m³/h of water from _____ °C to _____ °C at a design entering air wet-bulb temperature of _____ C and its thermal rating shall be Certified by the Cooling Technology Institute.</p> <p>2.2 The tower shall be capable of a minimum _____ m³/h/kilowatt efficiency per ASHRAE Standard 90.1.</p> <p>2.3 CTI Certification notwithstanding, the cooling tower manufacturer shall guarantee that the tower supplied will meet the specified performance conditions when the tower is installed according to plan. If, because of a suspected thermal performance deficiency, the owner chooses to conduct an on-site thermal performance test under the supervision of a qualified, disinterested third party in accordance with CTI or ASME standards during the first year of operation; and if the tower fails to perform within the limits of test tolerance; then the cooling tower manufacturer will pay for the cost of the test and will make such corrections as are appropriate and agreeable to the owner to compensate for the performance deficiency.</p> <p>3.0 Warranty:</p> <p>3.1 The entire tower, including structure, casing, basins, decking, fan(s), motor(s), and all mechanical drive components (including belts, if used) shall be warranted against failure due to defects in materials and workmanship for a period of five (5) years from the date of shipment to the job. Towers not covered by a warranty of this scope will not be accepted.</p> <p>4.0 Design Loading:</p> <p>4.1 The tower structure, anchorage and all its components shall be designed by licensed structural engineers per the International Building Code to withstand a wind load of 1.44k/Pa, as well as a .3g seismic load. The fan deck and hot water basin covers shall be</p>	<div style="display: flex; justify-content: space-between; align-items: flex-start;"> <div style="width: 65%;"> <ul style="list-style-type: none"> ■ CTI Certification means that the tower has been tested under operating conditions and found to perform as rated by the manufacturer under those circumstances. It assures the buyer that the tower is not intentionally or inadvertently undersized by the manufacturer. ■ The minimum efficiency per ASHRAE Standard 90.1 for induced draft open cooling towers applied to comfort cooling is 8.68 kW @ 35/29.5/24. There are no efficiency requirements for non-comfort cooling applications. If you want greater efficiency you can require it by specifying a higher ASHRAE Standard 90.1 m³/h/kilowatt. ■ CTI certification alone is not sufficient to assure you that the tower will perform satisfactorily in your situation. Certification is established under relatively controlled conditions, and towers seldom operate under such ideal circumstances. They are affected by nearby structures, machinery, enclosures, effluent from other towers, etc. Responsible and knowledgeable bidders will take such site-specific effects into consideration in selecting the tower—but the specifier must insist by the written specification that the designer/manufacturer guarantee this “real world” performance. Any reluctance on the part of the bidder should cause you some concern. <ul style="list-style-type: none"> ■ It is important to understand the distinction between structure and anchorage. Specifying that only the anchorage meet these requirements means the tower can become non-functional, even fall down, yet remain attached to the foundation. Specifying structure will require the tower to remain operational. The indicated design values are the minimum allowables under accepted design standards. They give you assurance that the tower can be </div> <div style="width: 30%; text-align: center;">  </div> </div>



Specifications	Specification Value
<p>designed for 2.4kPa live load or a 91kg concentrated load. Guardrails, where specified, shall be capable of withstanding a 890N concentrated live load in any direction, and shall be designed in accordance with OSHA guidelines.</p>	<p>shipped, handled, hoisted—and ultimately operated in a normal cooling tower environment. Most NC Class models will withstand significantly higher wind and seismic loads. If your geographic location dictates higher wind load or seismic load values, please make the appropriate changes, after discussion with your Marley sales representative. Note: Some countries and states (Florida) require structure not anchorage. Check with you local officials.</p>
<p>5.0 Construction:</p>	<p>1.44k/Pa windload, .3g seismic load—applicable for most applications but consult the local code official for actual requirements. 2.4kPa live load, 890N concentrated load—ensures the tower can be safely accessed for routine maintenance when a guardrail is installed as well ensuring the end user complies with government safety laws.</p>
<p>5.1 Except where otherwise specified, all components of the cooling tower shall be fabricated of heavy-gauge, series 300 stainless steel. The tower shall be capable of withstanding water having a chloride content (NaCl) up to 750 mg/L; a sulfate content (SO₄) up to 1200 mg/L; a calcium content (CaCO₃) up to 800 ppm; silica (SiO₂) up to 150 mg/L; and design hot water temperatures up to 52°C. The circulating water shall contain no oil, grease, fatty acids, or organic solvents.</p>	<p>■ For pure resistance to corrosion—coupled with the capability to meet stringent fire and building codes—there is no substitute for stainless steel! No paints or electrostatically-applied coatings, however exotic they may be, can match stainless steel's ability to withstand adverse operating conditions.</p>
<p>5.2 The specifications, as written, are intended to indicate those materials that will be capable of withstanding the above water quality in continuing service, as well as the loads described in paragraph 4.1. They are to be regarded as minimum requirements. Where component materials peculiar to individual tower designs are not specified, the manufacturers shall take the above water quality and load carrying capabilities into account in the selection of their materials of manufacture.</p>	<p>Although SPX Cooling Technologies makes use of many structural FRP components in various other product lines, they are held to a relative minimum in the NC Class Stainless line. This is to assure that there will be no question as to the structural integrity, fire resistance, and life expectancy in the mind of the owner.</p> <p>Except for those unusual operating situations where the circulating water may be so laden with suspended solids, algae, fatty acids, product fibers, active organisms reflected in BOD, and the like that plugging of film type fill is a probability, the NC Class Stainless is relatively immune to poor water quality. Where such conditions do exist, however, thought should be given to the prevention of such carryover—or to the use of a Marley splash-fill product. Please discuss your situation with your Marley sales representative.</p>

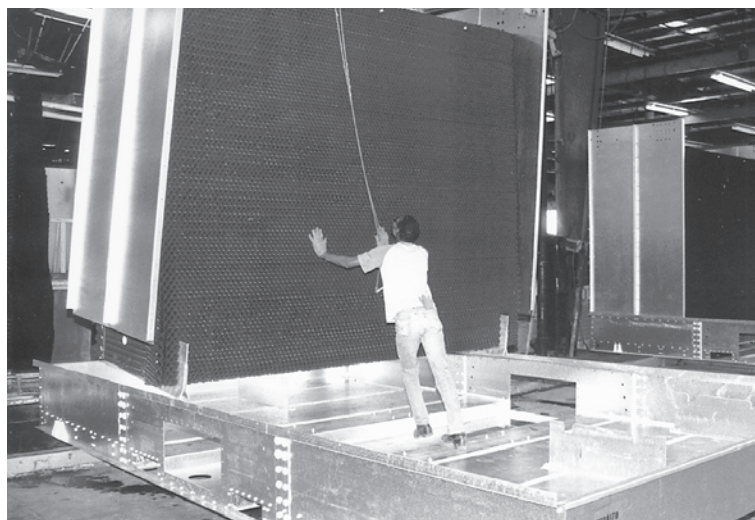

Factory Assembly

Specifications	Specification Value
<p>5.3* The tower shall include all design and material modifications necessary to meet the fire rating requirements of Factory Mutual. The product proposed shall be listed in the FM Approval Guide, latest edition.</p> <p><i>*Standard on models NC8301 thru NC8309. Available as an option on models NC8310 thru NC8312.</i></p>	<p>■ The Marley NC is the only crossflow cooling tower approved for single-cell FM installations. This could have a very beneficial effect upon your fire insurance premiums. Towers not able to meet FM requirements may require the inclusion of a fire protection sprinkler system to achieve a comparable level of insurance premium cost. Even if you are not insured by FM, this requirement ensures that each cell will contain any fire that may occur without losing the ability of limited operations and capacity.</p> <div style="text-align: right;">  </div>
<p>6.0 Mechanical Equipment:</p>	<p>■ Propeller-type fans require only half the operating hp of blower-type fans. However, they should be readily adjustable to permit compensation for jobsite conditions.</p>
<p>6.1 Fan(s) shall be propeller-type, incorporating wide-chord aluminum alloy blades and galvanized hubs. Blades shall be individually adjustable. Maximum fan tip speed shall be 66 m/s. Fan(s) shall be driven through a right angle, industrial duty, oil lubricated, geared speed reducer that requires no oil changes for the first five (5) years of operation. The gearbox bearings shall be rated at an L_{10A} service life of 100,000 hours or greater.</p>	<p>With NC, the choice is yours. The exclusive Marley System5 Geareducer® requires no oil changes for five years, offering you unmatched reliability and low maintenance. Ideal for owners concerned about downtime or maintenance costs. Currently available on 49 NC models, the Marley Power Belt drive system features all-aluminum sheaves, power band belts and long-life bearings for dependable service.</p>
<p>6.1 (alternate)* Fan(s) shall be propeller-type, incorporating wide-chord aluminum alloy blades and galvanized hubs. Blades shall be individually adjustable. Fan(s) shall be driven through a one-piece multi-groove, solid back V-type belt, pulleys, and tapered roller bearings. Bearings shall be rated at an L_{10A} service life of 40,000 hours or greater. <i>*Currently available on Models NC8304 through NC8309.</i></p>	<p>TEFC motors offer additional benefits over TEAO motors whose only source of cooling is the flow of air produced by the cooling tower fan. This air rate is not always ideal due to motor position, blockage, etc. TEFC ensures the motor will always be cooled properly.</p>
<p>6.2 Motor(s) shall be ___ kW maximum, TEFC, 1.15 service factor, variable torque, and specially insulated for cooling tower duty. Speed and electrical characteristics shall be ___ RPM, single-winding, ___ phase, ___ hertz, ___ volts. Motor shall operate in the shaft-horizontal position, and nameplate kilowatt shall not be exceeded at design operation.</p>	<p>Unless otherwise specified, motor speed will be 1500 RPM on standard models. Low noise models will use motor speeds appropriate for the specific model. If you prefer the operating flexibility of two-speed operation, please specify two-speed, single-winding motors which offer full and half speeds for maximum energy savings. Incidentally, two speed motors are a better choice than separate "pony" motors which simply double the problems indicated above and induce parasitic loads during operation for lower than nameplate efficiency.</p>
<p>6.3 The complete mechanical equipment assembly for each cell shall be supported by a rigid steel structural support that resists misalignment between the motor and the gear reducer.</p>	

Specifications	Specification Value
----------------	---------------------

7.0 Fill, Louvers and Drift Eliminators:

7.1 Fill shall be film type, thermoformed of 0.40mm thick PVC, with louvers formed as part of each fill sheet. Fill shall be suspended from hot dip galvanized structural tubing supported from the tower structure, and shall be elevated above the floor of the cold water basin to facilitate cleaning. Air inlet faces of the tower shall be free of water splash-out. Fill shall be capable of withstanding a hot water temperature of 52°C.

7.2 Drift eliminators shall be PVC, triple-pass, and shall limit drift losses to 0.005% or less of the design water flow rate.

■ Louvers integral with the fill keep the flowing water within the confines of the fill. The separate external louvers used by others permit water to escape the fill and form ice or produce an unsightly situation adjacent to the tower and waste water. If you plan to use your tower in the wintertime, particularly for free cooling, integral louvers will put your operating concerns to rest. Integral louvers offer the best available technology for winter operation and water conservation.

Fill options are available for hot water temperatures up to 60°C.

■ Drift rate varies with design water loading and air rate, as well as drift eliminator depth and number of directional changes. A drift rate of 0.001% is readily available in standard configuration without premium cost. If a lower rate is required, please discuss with your Marley sales representative.

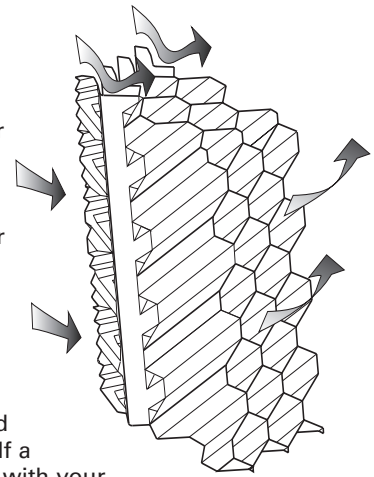

Keep in mind...

- Drift for towers with three-pass high efficiency eliminators constitute a small percentage of water usage.
- Unlike thermal performance, drift rates are not certified and field drift tests are cost prohibitive for most applications.
- Drift rates below 0.001 are difficult to measure in the field.
- Certain water treatment chemicals can impact the drift rate.

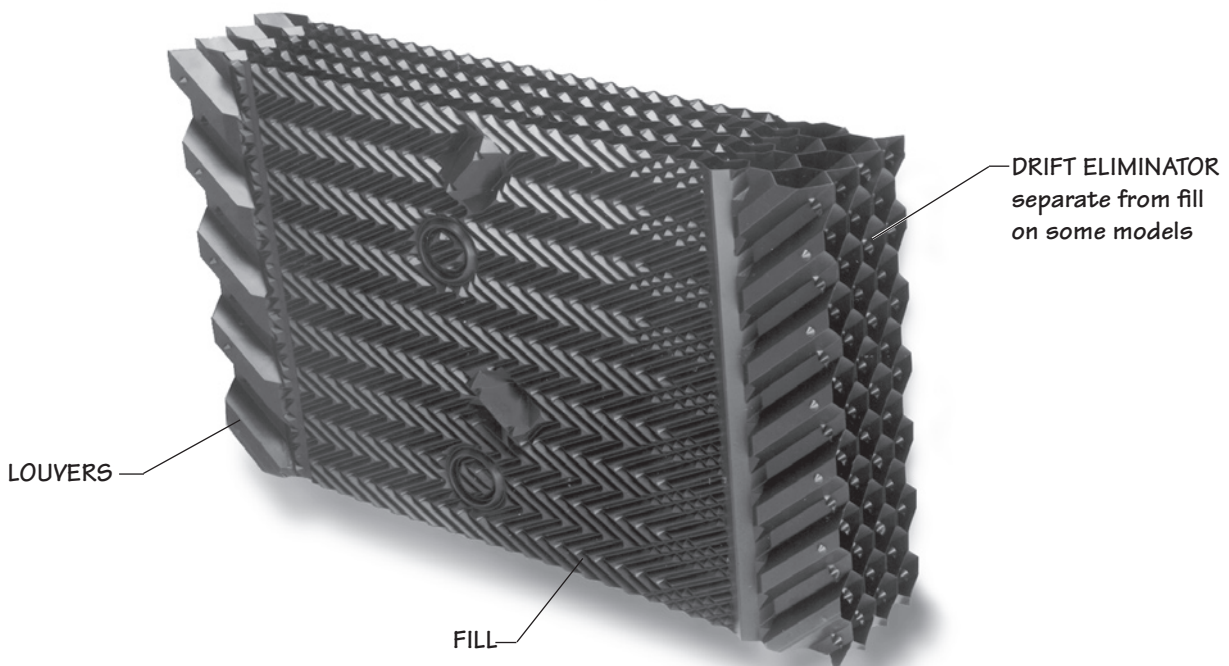

Specifications	Specification Value
<p>8.0 Hot Water Distribution System:</p> <p>8.1 Two stainless steel open basins (one above each bank of fill) shall receive hot water piped to each cell of the tower. These basins shall be installed and sealed at the factory, and shall be equipped with removable, stainless steel covers capable of withstanding the loads described in paragraph 4.1. All components of these basins, with the exception of the nozzles, shall be stainless steel. The water distribution system shall be accessible and maintainable during tower fan and water operation.</p> <p>8.2 Each basin shall include an inlet hole and bolt circle to accept a 125# flange connection per ANSI B16.1. Removable, interchangeable polypropylene nozzles installed in the floor of these basins shall provide full coverage of the fill by gravity flow.</p> <p>8.3 The water distribution system shall be accessible and maintainable while tower is operating.</p> <p>9.0 Casing, Fan Deck and Fan Guard:</p> <p>9.1 The casing and fan deck shall be heavy-gauge stainless steel, and shall be capable of withstanding the loads described in paragraph 4.1. The top of the fan cylinder shall be equipped with a conical, non-sagging, removable fan guard, fabricated of welded 8mm and 7 gauge rods, and hot dip galvanized after fabrication. Fan cylinders 1.5m in height and over shall not be required to have a fan guard.</p>	<ul style="list-style-type: none"> ■ Gravity-flow distribution basins are a feature of crossflow type towers, resulting in operating pump heads of 3 to 6 meters less than that encountered in counterflow towers with pressurized spray systems. Also, these basins are located where they can be easily inspected—even maintained—while the tower is in operation. ■ Some manufacturers require shutting down the tower to clean the distribution system. Can you afford to do that? ■ Materials other than heavy-gauge steel for fan decks may be unable to meet your specified loading requirements. See remarks Guardrail and Ladder on page 13. <p>In addition steel is excellent at resisting damage, cracking, UV and fire.</p> <p><i>The heavy construction of the Marley fan guard generally precludes the need for stainless steel material. If you would prefer these to be stainless steel, please adjust the wording of the last sentence accordingly.</i></p> 

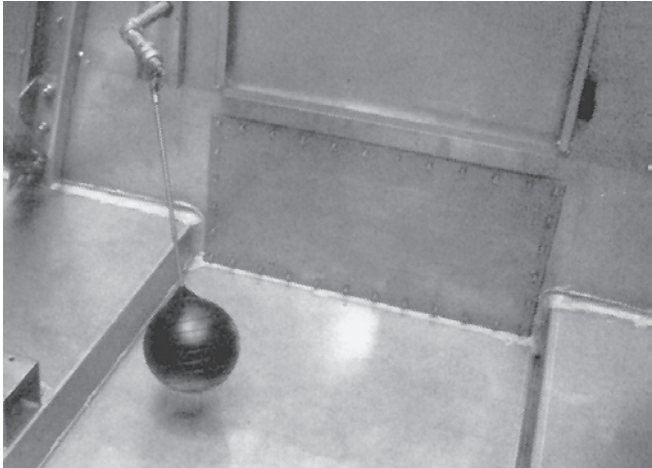
Specifications	Specification Value
<p>10.0 Access:</p> <p>10.1 A large stainless steel, rectangular access door shall be located on both end panels for entry into the cold water basin. Doors shall provide access to the fan plenum area to facilitate inspection and allow maintenance to the fan drive system.</p> <p>11.0 Cold Water Collection Basin:</p> <p>11.1 The collection basin shall be heavy-gauge S300 stainless steel, and shall include the number and type of suction connections required to accommodate the outflow piping system shown on the plans. Suction connections shall be equipped with stainless steel debris screens. A factory-installed, float-operated, mechanical make-up valve shall be included. An overflow and drain connection shall be provided in each cell of the cooling tower. The basin floor shall slope toward the drain to allow complete flush out of debris and silt which may accumulate. Towers of more than one cell shall include stainless steel flumes for flow and equalization between cells. The basin shall be accessible and maintainable while water is circulating.</p>	<ul style="list-style-type: none"> ■ The access doors on NC8301 and NC8302 towers are 76cm wide by 84cm high. On NC8303 thru NC8312 the access doors are 122cm high. Small access doors are prohibitive and discourage maintenance, which in turn can impact your operation. Specifying the size of the door will cause some bidders to take exception, alerting you to a potential maintenance headache. Two doors are standard on all NC Class towers—one in each endwall. ■ The NC tower design offers side-suctions, side-outlet sumps, and bottom outlets to accommodate a significant variety of piping schemes. Unless so specified, the tower you may be asked to approve may only be available with one type of suction connection, requiring you to redesign your piping layout. <div style="text-align: right; margin-top: 10px;">  </div> <div style="text-align: center; margin-top: 20px;">  </div>

Specifications	Specification Value
<p>Convenience and Safety Options</p>	
<p>Guardrail and Ladder:</p>	
<p>11.2 <i>Add the following paragraph in the Access section:</i> The top of the tower shall be equipped with a sturdy guardrail, complete with kneerail and toeboard, designed according to OSHA guidelines and factory welded into subassemblies for ease of field installation. Posts, top rails and kneerails shall be 38mm square tubing. The guardrail assembly shall be hot dipped galvanized after welding and capable of withstanding a 890N concentrated live load in any direction. Posts shall be spaced on centers of 2.4m or less. A 46cm wide aluminum ladder with 76mm I-beam side rails and 32mm diameter rungs shall be permanently attached to the endwall casing of the tower, rising from the base of the tower to the top of the guardrail.</p>	<ul style="list-style-type: none"> ■ The NC Class cooling tower has been designed to minimize the need for maintenance personnel to get on top of the tower to perform maintenance and inspections. <p>For the comfort and safety of your operating personnel, we recommend that you specify a ladder and guardrail—and that you <i>require it of all bidders!</i> Although not required for safe operation by OSHA many user's own safety rules may dictate these options.</p> <p><i>Outside the tower, stainless steel guardrail material is not normally considered necessary. If you air quality is sufficiently poor to warrant stainless steel, change the specification wording accordingly.</i></p>
<p>11.2 <i>Add the following to the end of the above paragraph:</i> Provide a ladder extension for connection to the foot of the ladder attached to the tower casing. This extension shall be long enough to rise from the roof (grade) level to the base of the tower. The installing contractor shall be responsible for cutting the ladder to length; attaching it to the foot of the tower ladder; and anchoring it at its base.</p>	<ul style="list-style-type: none"> ■ Many towers are installed such that the base of the tower is 61cm or more above the roof or grade level. This makes it difficult to get up to the foot of the attached ladder. The ladder extension alleviates this problem. Marley ladder extensions are available in standard 1.5m and 3.3m lengths.
<p>Ladder Extension:</p>	
<p>11.3 <i>Add the following paragraph in the Access section:</i> A heavy gauge galvanized steel safety cage shall surround the ladder, extending from a point approximately 2m above the foot of the ladder to the top of the guardrail.</p>	<ul style="list-style-type: none"> ■ To meet OSHA guidelines, towers whose fan decks are 6m or more above roof or grade, and which are equipped with ladders, should have safety cages surrounding the ladders, but with approximately 2m clear headroom. <p><i>Outside the tower, stainless steel safety cage material is not normally considered necessary. If you air quality is sufficiently poor to warrant stainless steel, change the specification wording accordingly.</i></p>
<p>Ladder Safety Cage:</p>	
<p>10.3 <i>Add the following paragraph in the Access section:</i> A galvanized steel, self-closing gate shall be provided at the guardrail level of the ladder.</p>	<ul style="list-style-type: none"> ■ A galvanized self-closing gate located at the guardrail level of the fan deck, exterior motor access platform and access door platform. Stainless steel is available with the stainless guardrail option.
<p>Ladder Safety Gate:</p>	



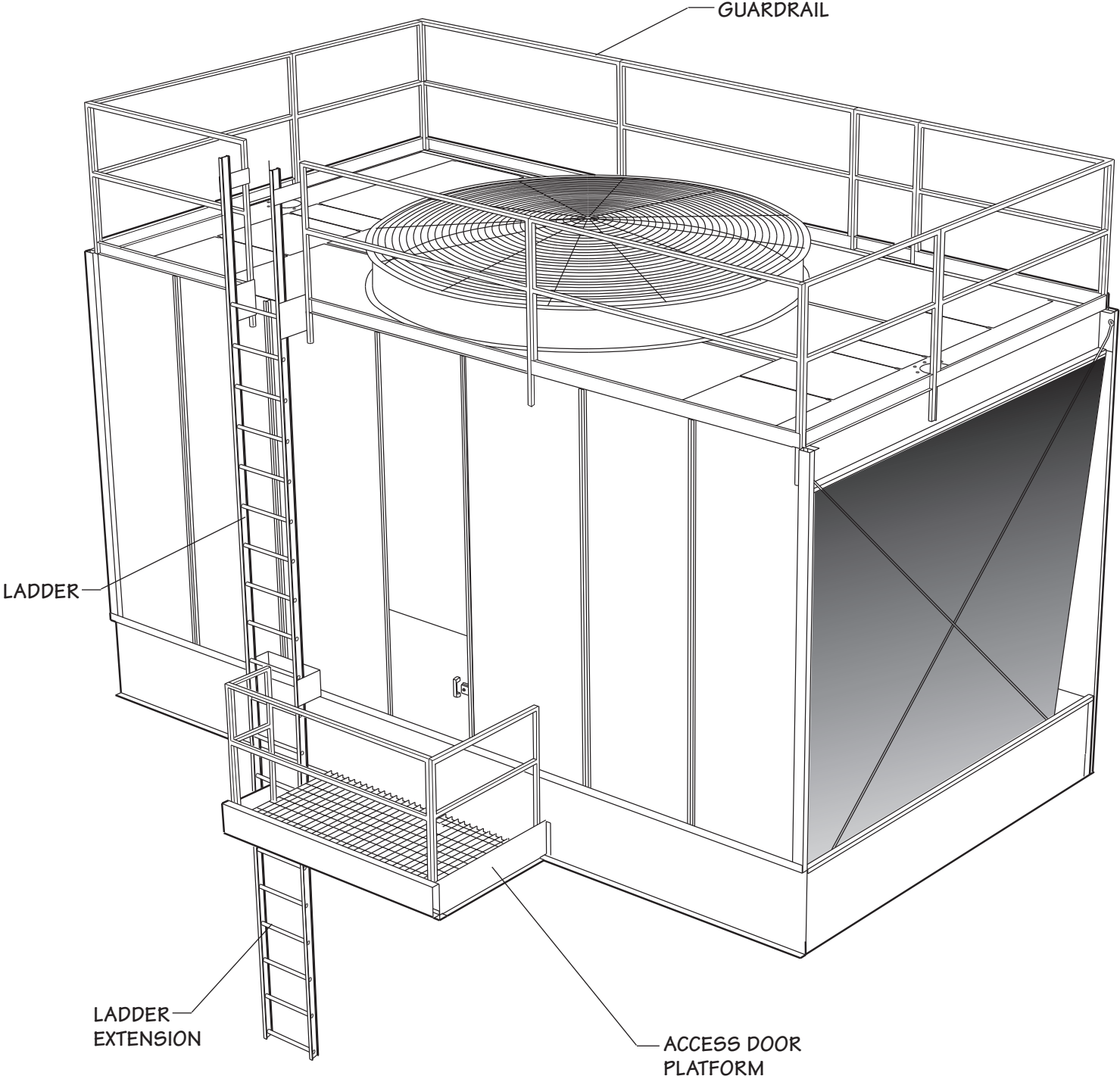

Specifications	Specification Value
----------------	---------------------

Access Door Platform:

11.2 *Add the following paragraph in the Access section:* There shall be an access platform at the base of the tower extending from the vertical ladder to the endwall access door. The platform shall be galvanized steel bar grating, supported by galvanized steel framework attached to the tower. The platform shall be surrounded by a guardrail, kneerail, and toeboard.

Plenum Walkway

11.2 *Add the following paragraph in the Access section:* Provide a factory-installed, galvanized steel bar grating walkway extending from one endwall access door to the other endwall. This walkway shall be supported by a galvanized steel framework, and the top of the grating shall be at or above the cold water basin overflow level.

Interior Mechanical Equipment Access Platform NC8303 thru NC8309

11.2 *Add the following paragraph in the Access section:* A factory-installed, elevated galvanized bar grating platform convenient to the care and maintenance of the tower's mechanical equipment shall be provided.

Interior Mechanical Equipment Access Platform NC8310 thru NC8312

11.2 *Add the following paragraph in the Access section:* An internal ladder shall extend upward from the plenum walkway to an elevated galvanized bar grating platform convenient to the care and maintenance of the tower's mechanical equipment. The platform shall be surrounded by a sturdy guardrail and kneerail system.

■ Where towers are installed on an elevated grillage or piers, it is often difficult to get to—and through—the access door conveniently. This platform provides easy, safe and comfortable access to that door. It also extends beyond the door to provide ready access to the optional Control System. See drawing on page 12.

Outside the tower, stainless steel platform material is not normally considered necessary. If your air quality is sufficiently poor to warrant stainless steel, change the specification wording accordingly.



NOTE

OSHA and other concerned authorities are in the process of developing guidelines regarding the safety procedures and protective equipment that should be provided maintenance personnel who are required to go inside cooling towers. We feel it advisable to provide for as much maintenance as possible from outside the cooling tower and, to that end, offer such options as Guardrail and Ladder—pg 11, Ladder Extension—pg 11, Ladder Safety Cage—pg 11, Access Door Platform—pg 13, and Motor Out of the Airstream—pg 18. Such interior convenience options as Plenum Walkway—pg 13, that are offered are not meant as an invitation to perform inside maintenance. They are intended solely to maximize the comfort and safety of maintenance personnel during the performance of any inside work may become necessary.

Specifications	Specification Value
<p>Control Options</p>	
<p>Fan Motor Starter Control Panel:</p>	
<p>6.4 <i>Add the following paragraph in the Mechanical Equipment section:</i> Each cell of the cooling tower shall be equipped with a UL listed control system in a IP14 or IP56 outdoor enclosure capable of controlling single-speed or two-speed motors as required, and designed specifically for cooling tower applications. The panel shall include a main fused disconnect or main circuit breaker with an external operating handle, lockable in the off position for safety. Across-the-line magnetic starters or solid-state soft-start starters as required shall be controlled with a thermostatic or solid-state temperature controller. Door mounted selector switches shall be provided to enable automatic or manual control and wired for 240VAC control. Control circuit to be wired out to terminal blocks for field connection to a remote vibration switch, overload trip alarms and remote temperature control devices. The temperature controller shall be adjustable for the required cold-water temperature. If a thermostatic controller is used it shall be mounted on the side of the tower with the temperature sensing bulb installed in the cold water basin using a suspension mounting bracket. If a solid-state temperature controller is used the controller will be door mounted on the control panel. The temperature controller will display two temperatures, one for outgoing water and the other for set point. Water temperature input shall be obtained using a three-wire RTD with dry well in the outlet water piping and wired back to the solid-state temperature controller in the control panel.</p>	<p>■ If it is your opinion that the control system for the cooling tower be part of the tower manufacturer's responsibility, we are in wholehearted agreement with you. Who better to determine the most efficient mode and manner of a cooling tower's operation—and to apply a system most compatible with it—than the designer and manufacturer of the cooling tower?</p> <p>Marley variable speed drives are also available for the ultimate in temperature control, energy management and mechanical equipment longevity. See specifications on page 16.</p>
	

Specifications

Specification Value

Vibration Limit Switch:

6.5 *Add the following paragraph in the Mechanical Equipment section:* A single-pole, double-throw vibration limit switch in a IP56 housing shall be installed on the mechanical equipment support for wiring into the fan motor shutdown circuit. The purpose of this switch will be to interrupt power to the motor in the event of excessive vibration. It shall be adjustable for sensitivity, and shall require manual reset.

■ Unless specified otherwise, a Metrix switch will be provided. A double-pole, double-throw model is also available. If purchased in conjunction with the Control System, it is also factory-wired. The requirement for manual reset assures that the cooling tower will be visited to determine the cause of excess vibration.



Basin Heater:

11.2 *Add the following paragraph in the Cold Water Basin section:* Provide a system of electric immersion heaters and controls for each cell of the tower to prevent freezing of water in the collection basin during periods of shutdown. The system shall consist of one or more stainless steel electric immersion heaters installed in threaded couplings provided in the side of the basin. A IP56 enclosure shall house a magnetic contactor to energize heaters; a transformer to provide 24-volt control circuit power; and a solid-state circuit board for temperature and low water cut-off. A control probe shall be located in the basin to monitor water level and temperature. The system shall be capable of maintaining 5°C water temperature at an ambient air temperature of ____ °C.

■ The Marley basin heater components described at left represent our recommendation for a reliable automatic system for the prevention of basin freezing. They are normally shipped separately for installation at the job-site by the installing contractor. When purchased in conjunction with the enhanced Control System option, however, they are customarily factory-mounted and tested.

Submerged in basin water, in which zinc ions are present, copper immersion heaters must not be used. Insist upon stainless steel.

The ambient air temperature that you insert in the specifications should be the lowest 1% level of winter temperature prevalent at site.



Electric Water Level Control:

11.1 *Replace this paragraph with the following:* The collection basin shall be heavy-gauge series 300 stainless steel and shall include the number and type of suction connections required to accommodate the out-flow piping system shown on the plans. Suction connections shall be equipped with stainless steel debris screens. A solid-state water level control system to monitor the water level with a multi-relay control panel pre-wired and mounted in a IP56 nonmetallic enclosure shall be provided. The system shall consist of water level sensing and control units

■ Solid-state liquid level controls provide you with state of the art systems to control and monitor the water level in your cooling tower collection basin. Relays operating in conjunction with suspended stainless steel electrode probes monitor basin water levels, providing simple solenoid-valve water makeup or discrete on/off signals to more sophisticated automation controls. Optional configurations might include makeup along with high and low water level alarm and cutoff, or pump cutoff. Packaged systems including any of these variations are available. Consult you Marley sales representative or download a copy of ACC-NC-9D from spxcooling.com for additional information.



Specifications	Specification Value
<p>in quantities and locations as indicated on the drawings. An overflow and drain connection shall be provided in each cell of the cooling tower. The basin floor shall slope toward the drain to allow complete flush out of debris and silt which may accumulate. Towers of more than one cell shall include stainless steel flumes for flow and equalization between cells. The basin shall be accessible and maintainable while water is circulating.</p> <p>Fan Motor Variable Speed Drive:</p> <p>Marley All Weather ACH550 System</p> <p>6.4 <i>Add the following paragraph in the Mechanical Equipment section when VFD is used with customers Building Management System:</i> A complete UL listed Variable Speed Drive system in a IP10 indoor, IP52 indoor or IP14 outdoor enclosure shall be provided. The VFD shall use PWM technology with IGBT switching and integrated bypass design. VFD out put switching shall not cause mechanical issues with gearbox teeth or drive shafts. The VFD shall catch a fan spinning in the reverse direction without tripping. The panel shall include a main disconnect with short circuit protection and external operating handle, lockable in the off position for safety. The VFD system shall receive a speed reference signal from the Building Management System monitoring the tower cold-water temperature. As an option to receiving the speed reference signal from a building management system, the drive must have the capability to receive a 4-20 ma temperature signal from an RTD transmitter. The VFD shall have an internal PI regulator to modulate fan speed maintaining set point temperature. The drive's panel display shall be able to display the set-point temperature and cold-water temperature on two separate lines. The bypass shall include a complete magnetic bypass circuit and with capability to isolate the VFD when in the bypass mode. Transfer to the bypass mode shall be manual in the event of VFD failure. Once the motor is transferred to the by-pass circuit the fan motor will run at constant full speed. The bypass circuit will not modulate ON and OFF based on</p>	<ul style="list-style-type: none"> ■ Marley Variable Speed Drive systems are designed to combine absolute temperature control with ideal energy management. The cooling tower user selects a cold water temperature and the drive system will vary the fan speed to maintain that temperature. Precise temperature control is accomplished with far less stress to the mechanical equipment components. The improved energy management provides fast payback to the user.

Specifications	Specification Value
----------------	---------------------

cold-water temperature. The application must be able to handle very cold water while VFD is in a by-pass mode. Operator controls shall be mounted on the front of the enclosure and shall consist of start and stop control, bypass/VFD selection, Auto/Manual selections, manual speed control. To prevent heating problems in the cooling tower fan motor and to assure proper gear reducer lubrication the VFD system shall de energize the motor once 25% motor speed is reached and cooling is no longer required. The cooling tower manufacturer shall supply VFD start-up assistance. Tower vibration testing throughout the speed range is required to identify and lockout any natural frequency vibration levels which may exceed CTI guidelines.

Marley Premium VFD System

6.4 *Add the following paragraph in the Mechanical Equipment section when VFD is used as a stand alone system:* A complete UL listed Variable Speed Drive system in a IP52 indoor or IP14 outdoor enclosure shall be provided. The VFD shall use PWM technology with IGBT switching and integrated bypass design. VFD output switching shall not cause mechanical issues with gearbox teeth or drive shafts. The VFD shall catch a fan spinning in the reverse direction without tripping. The panel shall include a main disconnect with short circuit protection and external operating handle, lockable in the off position for safety. The system shall include a solid state, PI temperature controller to adjust frequency output of the drive in response to the tower cold-water temperature. The temperature of the cold water and set point shall be displayed on the door of the control panel. The bypass shall include a complete magnetic bypass circuit with capability to isolate the VFD when in the bypass mode. Transfer to the bypass mode shall be automatic in the event of VFD failure or for specific trip conditions allowing safe transfer of utility voltage to the motor. Automatic bypass with an earth ground condition is not allowed. The bypass contactor shall be cycled on and off while operating in bypass, to maintain the set-point temperature of the cold water. The drive design



Specifications	Specification Value
----------------	---------------------

shall be operated as a stand-alone system without the need for a BMS system. Operator controls shall be mounted on the front of the enclosure and shall consist of start and stop control, bypass/VFD selector switch, Auto/Manual selector switch, manual speed control, and solid-state temperature controller. An emergency bypass selector switch internal to the panel allowing the cooling tower fan motor to be run at full speed shall be furnished. To prevent heating problems in the cooling tower fan motor and to assure proper gear box lubrication the VFD system shall de-energize the motor once 25% motor speed is reached and cooling is no longer required. The VFD shall include de-icing logic with auto canceling and adjustable time. Speed in De-Ice mode shall not exceed 50 % motor speed. The cooling tower manufacturer shall supply VFD start-up assistance. Tower vibration testing throughout the speed range is required to identify and lockout any natural frequency vibration levels which may exceed CTI guidelines.

Miscellaneous Options

Motor out of the Airstream:

6.1 *Add the following to the end of this paragraph:* The motor shall be mounted outside the casing of the tower, and shall be connected to the gear reducer by a dynamically-balanced, stainless steel tube and flange driveshaft.

Fan Cylinder Extensions:

9.1 *Insert the following after the first sentence:* Fan cylinder extensions shall be provided to elevate the fan discharge to a height of ___ m above the fan deck level.

■ For many years, a feature of Marley cooling towers was that the electric motors were located outside the fan cylinders, where they were easily accessible, and where they were not subjected to the constant humidity that exists inside the tower plenum.

Although improved motor designs (insulation, bearings, seals, and lubricants) have now made it feasible for us to locate the motor inside the tower in close-coupled proximity to the Geareducer® (page 7), many users still prefer the motor to be located outside the humid airstream. If you are among those users—or are among those who see the wisdom of their thinking—please specify this option. If you do, however, *please require it of all bidders.*



■ Extensions are available in 305mm increments to a maximum height equal to the diameter of the fan. Such extensions may be considered necessary in order to elevate the discharge beyond the bounds of an enclosure. Discuss applicability with your local Marley sales representative.

Specifications

Inlet Flow Control Valves:

8.2: *Add the following to the end of the paragraph:* Heavy-duty flow-regulator valves shall be provided at the hot water inlet connections. These valves shall be disc-type, with cast iron bodies and stainless steel operating stems. There shall be a locking handle to maintain the valve setting in any position. Valves shall be right-angle configuration, precluding the need for inlet elbows.

Equalizer Flume Weir Gates:

11.2: *Add the following paragraph under Cold Water Collection Basin:* The interconnecting flume between cells shall be equipped with a removable cover plate to permit the shutdown of one cell for maintenance purposes, or to permit independent cell operation.

Sound Control

1.2 *Add the following paragraph under Base:* The cooling tower shall be quiet operation, and shall produce an overall level of sound not higher than _____ dB(A) measured at _____ m from the locations in the table below. All low noise options and combinations shall be CTI Certified for thermal performance.

Location	63	125	250	500	1000
Discharge					
Air Inlet					
Cased Face					

Location	2000	4000	8000	Overall dB(A)
Discharge				
Air Inlet				
Cased Face				

Inlet Sound Attenuation

1.3 *Add the following paragraph under Base:* The cooling tower shall be equipped with inlet sound attenuation baffles positioned and spaced vertically. The baffles will be spaced across the entire length and extend the full height of the air inlet. The baffles will be constructed of perforated sheet metal and contained within a steel

Specification Value

■ Marley flow-control valves have been a favorite of users since the 1950s. They remain serviceable for the life of the tower and provide a continuing means of flow-regulation between hot water basins—and between cells of multicell towers as well.

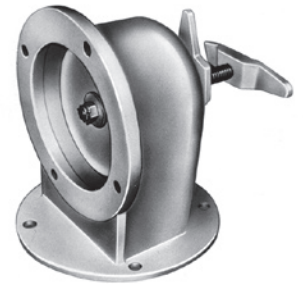

■ Where it is your intention to be able to operate both cells of the tower while the flume cover plate is installed, separate outlet connections, float valves and overflows must be provided for each cell. Likewise, this would require separate sensors and controls for basin heater systems, if installed.

■ Sound produced by a standard NC Cooling Tower operating in an unobstructed environment will meet all but the most restrictive noise limitations—and will react favorably to natural attenuation. Where the cooling tower has been sized to operate within an enclosure, the enclosure itself will have a damping effect on sound. Sound also declines with distance—by about 5 or 6 dB(A) each time the distance doubles. Where noise at a critical point is likely to exceed an acceptable limit, you have several options—listed below in ascending order of cost impact:



- Where only a slight reduction in noise will satisfy—and the source of concern is in a particular direction—merely turning the cooling tower may be the answer. Less sound emanates from the cased face of the cooling tower than does from the air intake face.

- In many cases, noise concerns are limited to nighttime, when ambient noise levels are lower and neighbors are trying to sleep. You can usually resolve these situations by using two-speed motors—operating the fans at reduced speed without cycling “after hours.” The natural nighttime reduction in wet-bulb temperature makes this a very feasible solution in most areas of the world, but the need to avoid cycling may cause the cold water temperature to vary significantly.

- A Marley Variable Speed Drive automatically minimize the tower’s noise level during periods of reduced load and/or reduced ambient



Specifications	Specification Value
<p>box which is self supporting. The inlet attenuation will not be allowed to impact the thermal performance efficiency of the basic tower configuration.</p> <p>Outlet Sound Attenuation</p> <p>1.4 <i>Add the following paragraph under Base:</i> The cooling tower shall be equipped with outlet sound attenuation baffles positioned and spaced horizontally across the entire fan opening. The baffles will be constructed of perforated sheet metal and contained within a steel box which is self supporting and made of the same material as the tower.</p> <p>Low Noise Fan</p> <p>1.4 <i>Replace paragraph 6.1 with the following:</i> Fan(s) shall be propeller-type, incorporating a minimum of seven wide-chord aluminum alloy blades and galvanized hubs. Blades shall be individually adjustable. Maximum fan tip speed shall be 56 m/s. Fan(s) shall be driven through a right angle, industrial duty, oil lubricated, geared speed reducer that requires no oil changes for the first five (5) years of operation. The gearbox bearings shall be rated at an L_{10A} service life of 100,000 hours or greater.</p> <p>6.1 (alternate)* Fan(s) shall be propeller-type, incorporating a minimum of seven wide-chord aluminum alloy blades and galvanized hubs. Blades shall be individually adjustable. Fan(s) shall be driven through a one-piece multi-groove, solid back V-type belt, pulleys, and tapered roller bearings. Bearings shall be rated at an L_{10A} service life of 40,000 hours or greater. *Currently available on Models NC8304 through NC8309.</p>	<p>temperature without sacrificing the system’s ability to maintain a constant cold water temperature. This is a relatively inexpensive solution, and can pay for itself quickly in reduced energy costs.</p> <ul style="list-style-type: none"> • The most extreme cases may require inlet and discharge sound attenuator sections—however, the static pressure loss imposed by discharge attenuators may necessitate an increase in tower size. Two stages of inlet or discharge attenuators supported by the tower and designed and tested for the most stringent requirements are available as an option. ■ Falling water sound—unlike counterflow towers which allow the water to free-fall and splash into the cold water collection basin, PVC film-fill crossflow towers have no splashing. This allows a crossflow tower much lower sound levels at the air inlet than a counterflow tower—especially induced draft counterflow towers. Even with the “splash-matting” option in a counterflow cold water collection basin, a crossflow tower air inlet is still quieter. Plus you do not have to worry about clogging the splash matting. Yet another maintenance and operation advantage of the crossflow configuration. ■ NC Class models with the “L” suffix in the model number are the special low sound editions. To achieve the very lowest possible sound levels while maintaining efficiency, the best available combination of motor, gear ratio, fan blade count and blade profile were carefully selected for every “L” model. All “L” models come with the Low-Noise Fan option. If you choose the sound attenuator option, the fan will automatically change to the Low-Noise Fan option. ■ Tip Speed—unlike thermal performance, no certification program exists for sound. While Marley conducts actual sound tests on all its configurations there are only a few ways for the client to ensure they get a quiet tower. <ul style="list-style-type: none"> • One is to conduct a field sound test after installation. On-site testing after installation can however be inaccurate depending on the environment. • Another is to conduct a sound test at the factory. However both can be cost prohibitive for smaller applications. • Specifying fan blade tip speed is one way to physically force the tower selection to be quiet. Tip speed is easily checked by multiplying the fan rpm by the fan circumference at the blade tip (π fan dia). Over 61m/s is considered <i>high</i> by most people. 51-61 is considered typical and expected. 41-51 would be considered low noise. Below 41 is difficult to hear above the water noise.



Specifications	Specification Value
<p>Ultra Low-Noise Fan</p> <p>1.4 <i>Replace paragraph 6.1 with the following:</i> Fan(s) shall be propeller-type, incorporating wide-chord forward-swept FRP blades and galvanized hubs. Blades shall be individually adjustable. Maximum fan tip speed shall be 51 m/s. Fan(s) shall be driven through a right angle, industrial duty, oil lubricated, geared speed reducer that requires no oil changes for the first five (5) years of operation. The gearbox bearings shall be rated at an L_{10A} service life of 100,000 hours or greater. Available on Models NC8302 through NC8312.</p> <p>Single Hot Water Inlet Connection per Cell:</p> <p>8.2 <i>Replace this paragraph with the following:</i> Each cell of the tower shall include a single hot water inlet connection located as shown on the plans. An internal system of piping shall deliver water equally to the distribution basins without the need for balancing valves. This internal piping system shall require no scheduled maintenance, and shall be located such that it does not interfere with normal maintenance access. The internal piping must extend to the tower exterior. Removable, interchangeable polypropylene nozzles installed in the floor of these basins shall provide full coverage of the fill by gravity flow.</p> <p>Air Inlet Screens:</p> <p>9.1 <i>Add the following paragraph to the Casing, Fan Deck and Fan Guard section:</i> The air inlet faces of the tower shall be covered by 1" mesh hot-dipped galvanized welded wire screens. Screens shall be secured to removable galvanized U-edge frames.</p> <p>High Wind Load/Seismic Designs:</p> <p>4.1 <i>Replace this paragraph with the following:</i> The tower structure, anchorage and all its components shall be designed by licensed structural engineers per the international building code to withstand a wind load of</p>	<p>■ For more severe cases requiring the lowest possible fan sound levels the Marley "Ultra Low-Noise" fan option is now available on all but the NC8301 NC Class models. Tower height may increase slightly—obtain current sales drawings from your Marley sales representative for accurate dimensions. If your requirement calls for inlet and outlet attenuation, you might consider the Ultra Low-Noise fan in lieu of attenuation. Outlet attenuators are not available with the Ultra Low-Noise Fan option.</p> <p>■ This option reduces what might otherwise be a complex hot water piping layout to a simple, single connection per cell. It also avoids an unsightly (perhaps unsafe) maze of pipe exposed above the top deck of the tower.</p> <p>The single inlet connection can be located either in the tower's endwall casing, or below the cold water basin. The endwall entry point is suitable for single-cell towers, and for those that might be installed in groups of two cells each. Bottom inlet piping lends itself to close-spaced, multicell installations and to those situations where it is appropriate to keep all pipework below the level of the tower.</p> <p>Be sure to specify that the internal pipe extends to the tower exterior panel, either the casing panel or collection basin floor. Some manufacturers require the contractor to complete the internal piping adding to your cost.</p> <p>■ In wooded or windy areas, these screens help to keep leaves or blowing debris out of the cooling tower and circulating water system.</p> <p>■ High wind load designs greater than 30 psf are available up to 100 psf. It is important to consult the local code official for actual requirements. Some manufacturers will claim their tower is capable but have never had the design reviewed by a licensed structural expert. Not requiring expert review for high wind and seismic regions is dangerous to you and the public.</p>



Specifications	Specification Value
<p>_____ psf, as well as a _____ seismic load. The fan deck and hot water basin covers shall be designed for 50 psf live load or a 200 lb. concentrated load. Guardrails, where specified, shall be capable of withstanding a 200 lb. concentrated live load in any direction, and shall be designed in accordance with OSHA guidelines.</p> <p>Multicell Basin Equalizer Outlets:</p> <p><u>11.1</u> <i>Add the following paragraph in the Access section:</i> A hole and bolt circle shall be provided in the depressed section of the basin for equalizer piping between cells. A full-face, .25" thick, 50 durometer gasket shall be provided at each equalizer location.</p> <p>Basin Sweeper Piping:</p> <p><u>11.1</u> <i>Add the following paragraph in the Access section:</i> The cold water basin shall be equipped with PVC sweeper piping with plastic eductor nozzles. The piping should create a grid under the fill and force all dirt and debris to the depressed section of the collection basin.</p> <p>Extended Geareducer Lube Line with Dipstick:</p> <p><u>6.1</u> <i>Add the following paragraph in the Mechanical Equipment section:</i> An external oil level dipstick shall be located adjacent to the motor at the fan deck surface and shall be accessible from a portable maintenance ladder.</p>	<ul style="list-style-type: none"> ■ Used as water level equalizers between multicell towers. Not intended for water migration. Piping and attachment hardware by others. Flat faced flange required. ■ PVC sweeper piping and Lakos nozzles. Designed for the following flows at 20 psig: <ul style="list-style-type: none"> NC8301 thru NC8304, 33m³/h NC8305, 47m³/h NC8306 thru NC8312, 64m³/h ■ The dipstick option is accessible from a portable maintenance ladder on one and two cell towers only. Maintenance considerations recommends this option be combined with the ladder and guardrail option on installations of three or more cells since the dipstick cannot be reached without accessing the fan deck.



SPX®

COOLING TECHNOLOGIES

SPX COOLING TECHNOLOGIES UK LTD.
GREGORY'S BANK
WORCESTER WR3 8AB
UNITED KINGDOM
+44 (0) 1905 720 200
info.uk@spx.com
spxcooling.com

In the interest of technological progress,
all products are subject to design and/or
material change without notice.
©2008 SPX Cooling Technologies
uk_SPEC-SS-NC-08A

Free Manuals Download Website

<http://myh66.com>

<http://usermanuals.us>

<http://www.somanuals.com>

<http://www.4manuals.cc>

<http://www.manual-lib.com>

<http://www.404manual.com>

<http://www.luxmanual.com>

<http://aubethermostatmanual.com>

Golf course search by state

<http://golfingnear.com>

Email search by domain

<http://emailbydomain.com>

Auto manuals search

<http://auto.somanuals.com>

TV manuals search

<http://tv.somanuals.com>