

CVC230HZ

23X AUTO FOCUS ZOOM COLOR CAMERA

OPERATION / INSTALLATION MANUAL



200 New Highway, Amityville, NY 11701

www.specotech.com

Speco Technologies is constantly developing product improvements. We reserve the right to modify product design and specifications without notice and without incurring any obligation.

Rev. 4/28/10

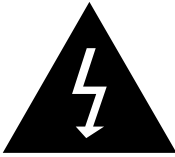

CAUTION
RISK OF ELECTRIC SHOCK
DO NOT OPEN



The lightning flash with an arrowhead symbol, within an equilateral triangle is intended to alert the user to the presence of uninsulated dangerous voltage within the product's enclosure the may be of sufficient to constitute a risk of electric shock to persons.



The exclamation point within an equilateral triangle is intended to alert the user to the presence of important operating and maintenance (servicing) instructions in the literature accompanying the appliance.

INFORMATION – This equipment has been tested and found to comply with limits for a Class A digital device, pursuant to part 15 of the FCC Rules.

These limits are designed to provide reasonable protection against harmful interference when the equipment is operated in a commercial environment.

This equipment generates, uses, and can radiate radio frequency energy and, if not installed and used in accordance with the instruction manual, may cause harmful interference to radio communications.

Operation of this equipment in a residential area is likely to cause harmful interference in which case the user will be required to correct the interference at his own expense.

WARNING – Changes or modifications not expressly approved by the manufacturer could void the user's authority to operate the equipment.

CAUTION - To prevent electric shock and risk of fire hazards :

- Do NOT use power sources other than that specified.
- Do NOT expose this appliance to rain or moisture.

**This installation should be made by a qualified service person and
Should conform to all local codes.**

Features

1. 23X Optical Zoom

- The built-in optical zoom lens is a highly durable component. It Features auto focus, auto iris, and zoom functions.

2. SSNR (Super Noise Reduction)

- By using built-in SSNR Function manufactured by MC Electronics, the amount of low light noise has been significantly reduced, and the signal-to-noise ratio (S/N)

3. Fine Picture Quality under Ultra Low Lighting

- 1/4" high density CCD allows the user to capture bright, high-quality images under ultra low lighting conditions.

4. High Resolution

- Featuring 550TV line horizontal resolution in color mode and 600TV line horizontal resolution in BW mode, the camera features Sony's 410,000 Pixel CCD and captures clean, noiseless, high-quality images.

5. Day & Night

- The camera automatically determines whether it is night time or day time, selecting operating mode automatically. The camera operates in color mode during day light conditions and BW mode in night conditions for clearer identification.

6. DIS (Digital Image Stabilizer)

- The DIS function can compensate for vibration of the camera. so it helps you obtain more stabilized image under the shaking conditions.

7. Motion Detection

- Once motion is detected, the camera sends an alert signal to the processing unit, which, if used in conjunction with an optional alarm, can provide effective surveillance of your property.

8. Miscellaneous Functions

- Other miscellaneous functions of the camera include privacy zone masking, digital zoom, freeze, horizontal inversion, and user-configured presets.

9. Control via OSD Menu and RS-485

- The OSD menu and RS-485 pins allow for remote control of the camera. The user can also directly control the lens using external control connection.

CONTENTS

- 1. Overview ----- 5**
 - TOP / Bottom ----- 5
 - Back ----- 5

- 2. Connection ----- 7**
 - Connecting to Monitor ----- 7
 - Connecting to Power ----- 8
 - Connecting to Connection ----- 8

- 3. Operating Your Camera ----- 9**
 - Menu Configuration ----- 9
 - Menu Setup ----- 10
 - Cam title ----- 11
 - White balance ----- 13
 - Backlight ----- 14
 - Motion detection ----- 14
 - Focus ----- 15
 - Exposure ----- 18
 - Special ----- 21
 - Reset ----- 25
 - EXIT ----- 25

- 4. Specifications ----- 27**

1. Overview

Top / Bottom

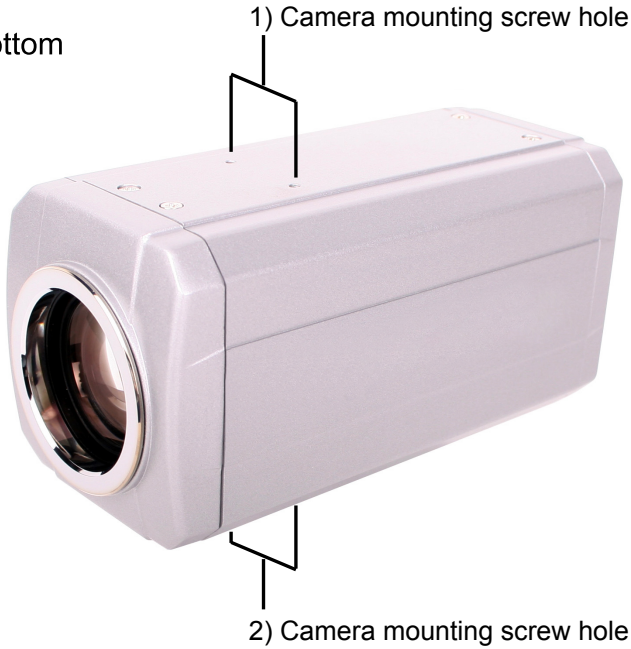

Back

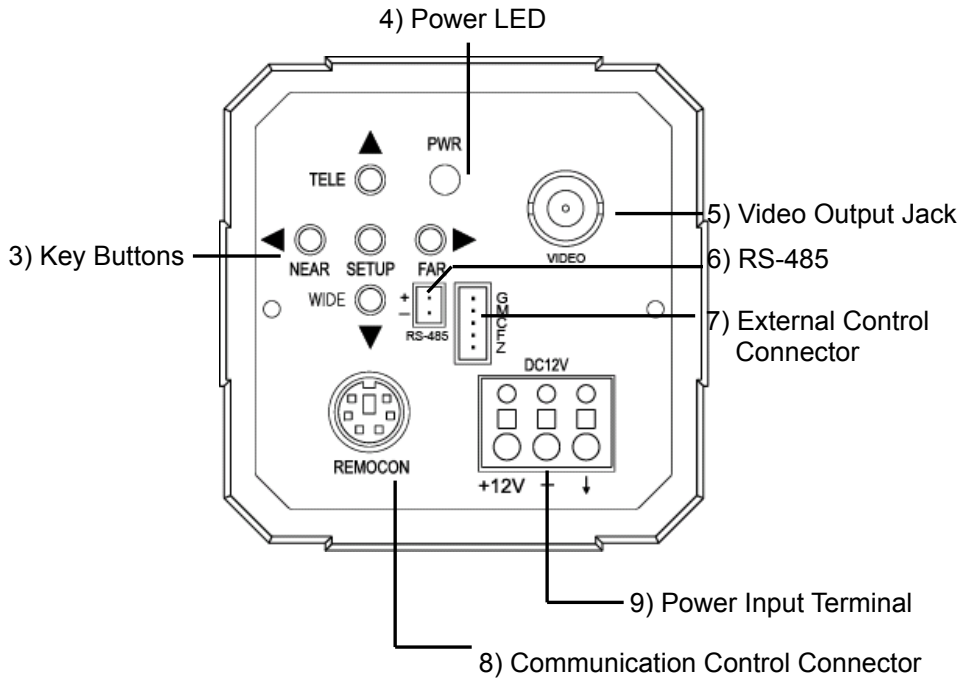

1. Top Mounting Bracket Screw Hole

Used to fix tripod mounting bracket on top of the camera.

2. Tripod Mounting Hole

Used to install the camera on an optional tripod.

The tripod must be equipped with screws with specifications shown on the right.

3. Key Buttons

Following buttons control zoom, focus, and auto focus functions.

WIDE button : To widen the view. (ZOOM OUT)

TELE button : To close in on a far object. (ZOOM IN)

F-NEAR button : To see a near object clearly.

F-FAR button : To see a far object clearly.

AF button : To activate auto focus just once.

Pressing the 'SET' button locks the zoom control function of these buttons and prompts the main setup menu.

***The zoom position is saved after 5 seconds when you set zoom function.**

Main setup menu can be navigated using these buttons.

SET : To access the main setup menu.

UP (WIDE button) : To Move the arrow indicator to up.

Down (TELE button) : To Move the arrow indicator to down.

LEFT (F-NEAR button) : To Move the arrow indicator to left.

RIGHT (F-FAR button) : To Move the arrow indicator to right.

4. Power LED

Illuminates when power is supplied.

5. Video Output Jack

Used to connect an external video monitor in jack.

6. RS-485

Includes the RS-485 communication pin

7. External Control connector

Relates to the motion detection output signal.

Zoom and focus functions can be controlled using external signals.

8. Communication Control Connector

Used to connect the Remote Controller (Option).

9. Power Input Terminal

Power supply terminal

2. Connection

1) Connecting to Monitor

Connect video out jack to the monitor's video in jack as shown below.

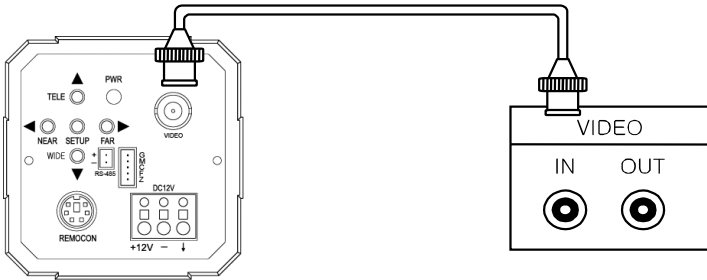

+ Connection methods may vary depending on the video equipment. Please refer to the model specific instruction manual.

+ Connect cables with the unit powered down.

+ Set the 75Ω / Hi-Z selection switch as shown below if you have an intermediate device.

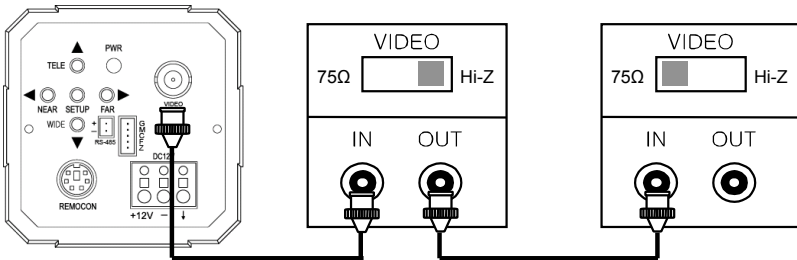

2) Connecting to Power

Each model has a different power input specification.
Please check the model type and standard power requirement before connecting to power.

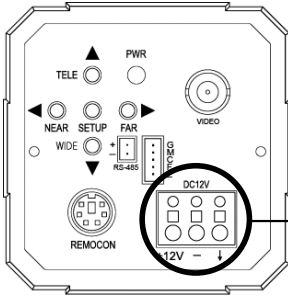

- DC Power Type (DC 12V, 500mA)**
+ Use DC 12V/500mA power source for camera.
- AC Power Type (AC 24V, 500mA)**
+ Use AC 24V/500mA power source for camera.
- AC 230 Power Type**
+ Use AC 230V/500mA power source for camera.

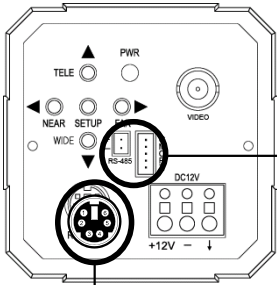

Communication Control connector
+ The camera can be controlled by using external controllers like a remote controller.
(RS-485 Communication)

External Control connector
Relates to the motion detection output signal.
Zoom and focus functions can be controlled using external signals.
G : GND, M : MD, C : COM, F : FOCUS, Z : ZOOM

Connector	Function	Signal Level	I/O
ZOOM	Tele	+6V~+12V COM	I
	Wide	COM -6V~-12V	
FOCUS	Far	+6V~+12V COM	I
	Near	COM -6V~-12V	
COM		COM	-
MD		+4.0V~+5.0V There is no motion 0V 5s/0.5sec There is motion	O



+ Communication Control Connector Pin Description.

Number	Name	Number	Name
1	Right	4	Auto Focus
2	Left	5	Down
3	Setup	6	Up

3. Operating Your Camera

Menu Configuration

MAIN SETUP MENU			
CAM TITLE	OFF	ON	
WHITE BALANCE	ATW(OUTDOOR)	AWC→SET	MANUAL
BACKLIGHT	OFF HIGH	LOW	MIDDLE
MOTION DET	OFF		
FOCUS	MODE ZOOM SPEED DISP ZOOM MAG LENS INIT	ZOOM TRK D-ZOOM ZOOM POS INIT END	
EXPOSURE	BRIGHTNESS AGC END	IRIS SSNR	SHUTTER SENS-UP
SPECIAL	USER PRESET DAY/NIGHT COMM ADJ	PRIVACY DIS IMAGE ADJ	SYNC END
RESET			
EXIT			

Menu Setup

Use the six buttons on back of the camera

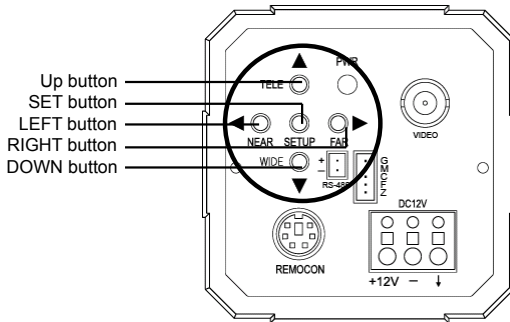

1. Press the SET button to access the main setup mode.
 - Main setup menu is displayed on the monitor screen

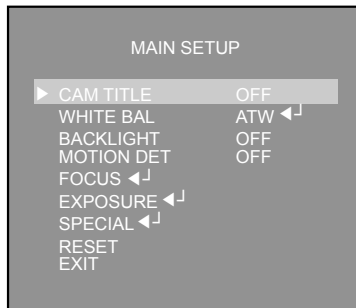

2. Select the desired feature using the UP or DOWN button.
 - Each pressing of the UP or DOWN button moves the indicator to the next or previous feature.
 - Move the arrow indicator to the desired feature item.

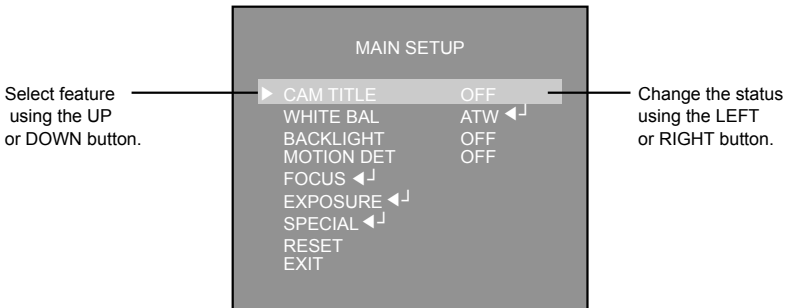

3. Change the status of the selected feature using the LEFT or RIGHT button.
4. When completed, move the arrow indicator to 'EXIT' and press the SET button.

Note

Features marked with a ◀↓ have an accessible submenu. Access the submenu by pressing the SET button.

Cam Title

Use this feature to designate a name for the camera, which will display on the monitor screen.

1. Press the SET Button to display the main setup menu and move the arrow indicator to 'CAM TITLE' using the UP or DOWN button.
2. Set 'CAM TITLE' to 'ON' using the LEFT or RIGHT button.

Note

If the CAM TITLE feature is set to 'OFF' The name will not displayed in the monitor.

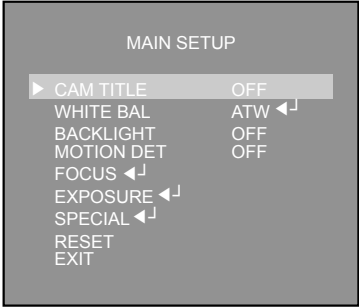

The screenshot shows a menu titled 'MAIN SETUP'. The first item is 'CAM TITLE' with 'OFF' to its right, and a grey highlight bar is over this item. Below it are 'WHITE BAL' (ATW), 'BACKLIGHT' (OFF), 'MOTION DET' (OFF), 'FOCUS' (◀↓), 'EXPOSURE' (◀↓), 'SPECIAL' (◀↓), 'RESET', and 'EXIT'.

3. Press SET button.

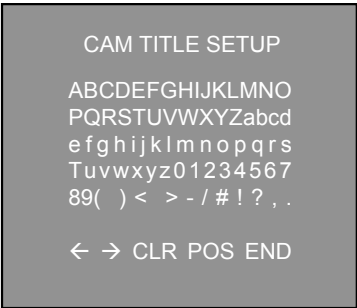

The screenshot shows a screen titled 'CAM TITLE SETUP'. It displays two rows of characters: 'ABCDEFGHIJKLMNO' and 'PQRSTUVWXYZabcd'. Below these are two rows of characters: 'efghijklmnopqrs' and 'Tuvwxyz01234567'. At the bottom, it shows '89() < > - / # ! ? , .'. At the very bottom, there are navigation options: '← → CLR POS END'.

4. You can enter up to 20 characters.

- 1) Move the cursor to the character entry field using the LEFT or RIGHT button.
- 2) Use UP, DOWN, LEFT, and RIGHT buttons to select a desired character.

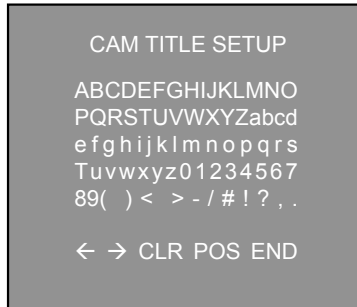

- 3) Press the SET button to confirm selection of the blinking character. The character is then saved, and the cursor in the entry field moves to the next position.
- 4) Repeat steps 1) through 3) until the desired name has been entered.

Note

Correcting Mistakes

Move the cursor to 'CLR' and press the SET button to clear the entire entry. To modify one character, use ← or → to position the cursor above the character to be modified and click the SET button after selecting the character to enter.

5. Select on screen position of the CAM TITLE.

- 1) Move the cursor to 'POS' and press SET button.

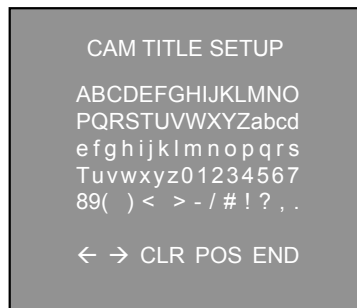

- 2) The CAM TITLE is displayed on the top-left of the monitor screen. (Default position)
- 3) Select the position by using the 4-directional buttons, then press the SET button to confirm the position.

6. When completed, move the cursor to 'END' and press SET button.

White Balance Control

Your camera provides three 'WHITE BAL' control modes for your choosing in Adjusting the white balance.

1. Press the SET button to access the main setup menu and move the indicator to 'WHITE BAL' using the UP or DOWN button.
2. Set 'WHITE BAL' using the LEFT or RIGHT button.

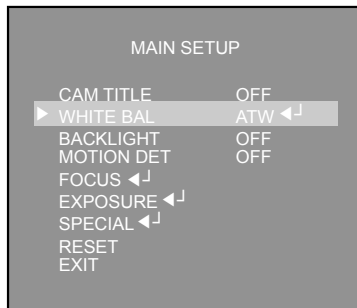

The three white balance control modes are as follows :

- ◆ ATW (Auto Tracking White Balance) :
 - OUTDOOR : This mode can be used within the color temperature range 1,800~10,500K
(Ex: fluorescent light, outdoor, sodium vapor lamp or inside tunnels)
 - INDOOR : This mode can be used within the color temperature range 3,000K~10,500K
- ◆ AWC (Auto White balance Control) :

The white balance is automatically adjusted in a specific environment. In order to obtain the best result, press the SET button while the camera focuses
- ◆ Manual :

To fine adjust, select the Manual mode. You can increase or decrease the red or blue factor while monitoring the difference on the screen. Set to 'MANUAL' mode and press the SET button. Increase or decrease the value for red (R-Gain) and blue (B-Gain), watching the color of the picture, and press the SET button when you obtain the best color.

Note

Proper White Balance may not be obtained under the following conditions.

- 1) When the scene contains mostly high color temperature object, such as a blue sky or sunset.
- 2) When the scene is dim.
- 3) If your camera directly faces a fluorescent lamp or is used in an environment of varying lighting conditions.

Backlight

When there is a strong backlight behind the object, clear images of the background as well as the object can still be obtained by using the BACKLIGHT function.

1. Please position the arrow to point to 'BACKLIGHT' on the SETUP menu by using the UP and DOWN buttons.
2. Please select the mode you wish to operate by pressing the LEFT or RIGHT button.

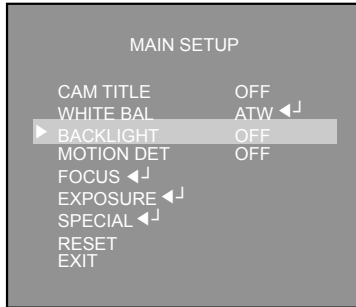

- ◆ HIGH/MIDDLE/LOW: You can adjust the sensitivity of Backlight Compensation.
- ◆ OFF: BACKLIGHT function does not operate.

Motion Detection

This product has a feature that allows you to observe movement of objects in 4 different areas on the screen, and the words 'MOTION DETECTED' appear on the screen when movement is detected; hence a single individual can conduct supervision efficiently. The camera detects an object's movement by sensing disparity of outline, and level of brightness and color. The camera receives detection signal from MD output terminal.

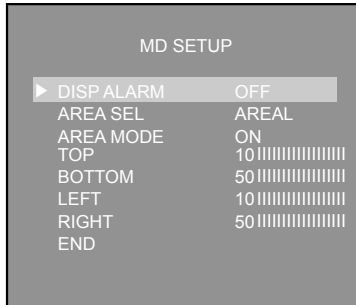

- + Please press the SETUP button.
 - OFF : MOTION DETECTION mode is cancelled.
 - ON : Any motion in the selected areas is observed.
- + Please press the SETUP button.
 - OFF : MOTION DETECTION mode is cancelled.
 - ON : Any motion in the selected areas is observed.
- + Please select the area you wish to observe from the 4 areas in AREA SEL mode.
- + Please select ON mode for the chosen area.
- + Please adjust the size of the area to be observed by using the UP, DOWN, LEFT or RIGHT button.
- + Please press the SETUP button to save changes and complete the setting.

FOCUS

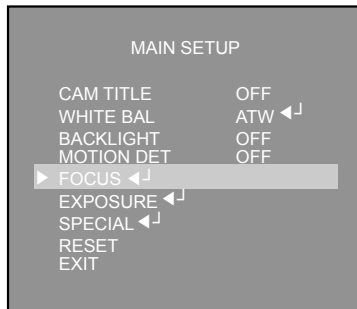

1. Press the SET button to access the main setup menu and then position the indicator over FOCUS using the UP or DOWN button.
2. Press the SET button.

→MODE: You can select the most suitable zoom mode. Move the arrow indicator to 'MODE' using UP or DOWN button.

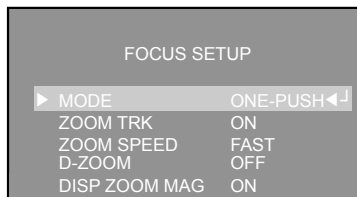

- + AUTO: Select auto and press the SET button to confirm. Increase or decrease optical zoom (ZOOM) or digital zoom (D-ZOOM) positions using the UP or DOWN button while verifying the changes on screen. Enabling D-ZOOM(ON) means that digital zoom will activate once optical zoom ends. Focus is automatically adjusted with moving zoom.

- + ONE PUSH: Focus is automatically adjusted just once, after zoom position is changed. Select 'ONE PUSH' and press the SET button to confirm. Increase or decrease optical zoom (ZOOM) or digital zoom (D-ZOOM) positions using the directional buttons while verifying the changes on screen. Press the SET button once desired image quality is obtained.
- + MANUAL: Select 'MANUAL' and press the SET button to confirm. Increase or decrease optical zoom (ZOOM) or digital zoom (D-ZOOM) positions using the directional buttons while verifying the changes on screen. Press the SET button once desired image quality is obtained. Focus can be manually adjusted, independent of moving zoom.
- ZOOM TRK: You can select to use 'ZOOM TRK'. Move the arrow indicator to 'ZOOM TRK' using UP or DOWN button. Set 'ZOOM TRK' to on using LEFT or RIGHT button.

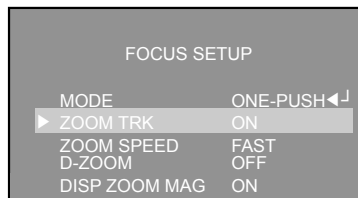

Configure zoom tracing speed using this feature. Position the indicator over 'ZOOM SPEED' using the UP or DOWN button and then set to desired mode using the LEFT or RIGHT button

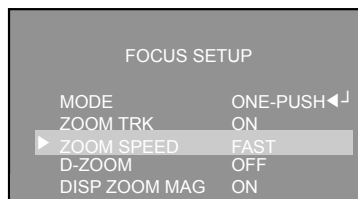

* FAST : To move zoom fast.

* SLOW : To move zoom slowly.

Note

The 'ZOOM SPEED' mode cannot be used if 'MODE' is set to 'AUTO' and 'ZOOM TRK' is 'ON'.

→D-ZOOM : Configure magnification limit from x2~x10 using this feature. Position the indicator over 'D-ZOOM' using the UP or DOWN button. Set 'D-ZOOM' to 'ON' and press the SET button to confirm.

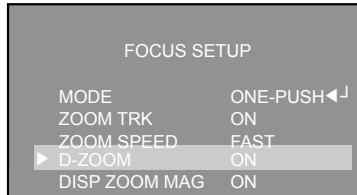

Set 'ZOOM LIMIT' to the desired level using the LEFT or RIGHT button.

→DISP ZOOM MAG: Use this feature to display the current zoom magnification level on screen. Position the indicator over 'DISP ZOOM MAG' using the UP or DOWN button. Then set to ON using the LEFT or RIGHT button.

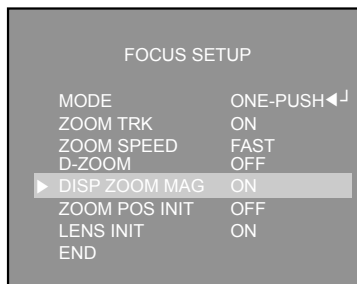

→ZOOM POS INIT: Moves to the controlled ZOOM position when the power turned on and is a function of the initial ZOOM position control

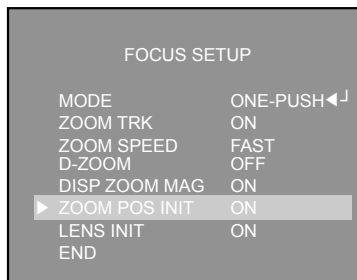

→LENS INIT: Use this feature to initialize the lens. Position the indicator over LENS INIT. Using the UP or Down button. Press the SET button to confirm.

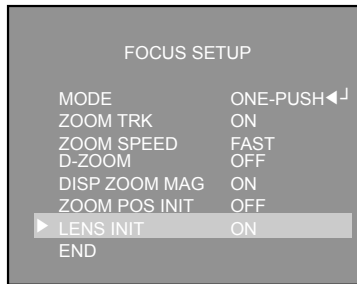

→END: To revert to the main setup menu.

EXPOSURE

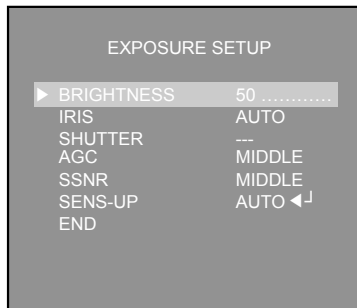

1. Press the SET button to access the main setup menu and then position the indicator over 'EXPOSURE' using the UP or DOWN button.
2. Press the SET button to confirm.

→BRIGHTNESS: Use this feature to adjust image brightness. Position the indicator over 'BRIGHTNESS' using the UP or DOWN button. Then increase or decrease brightness level using the LEFT or RIGHT button while verifying the changes on screen. Set END once desired level is obtained.

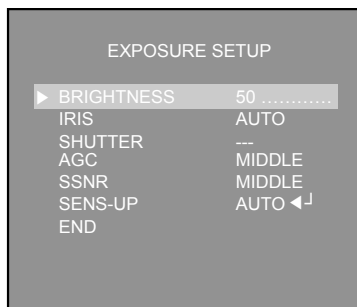

→IRIS: Set 'IRIS' to 'AUTO' or 'MANUAL'. Position the indicator over 'IRIS' using the UP or DOWN button and then select the desired iris mode using the LEFT or RIGHT button.

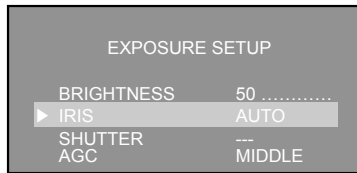

-AUTO : The iris is automatically activated upon illumination.

-MANUAL : Manual iris configuration. Set 'IRIS' to 'MANUAL' using the LEFT or RIGHT button and then press the SET button. Increase or decrease iris level using the LEFT or RIGHT button while verifying the changes on screen.

→SHUTTER: Control image brightness by adjusting shutter speed.

1. Position the indicator over 'SHUTTER' using the UP or DOWN button. Then select the desired shutter mode (A.FLK, ESC, MANUAL) using the LEFT or RIGHT button

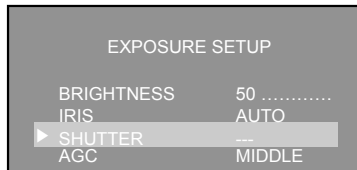

- **A.FLK (NTSC: 1/100, PAL: 1/120):** Flicker-free mode
- **ESC:** Automatic shutter speed setting (optimal)
- **MANUAL:** Manual shutter speed setting

2. If you choose 'MANUAL', select the optimal shutter speed. In MANUAL mode, the optimal shutter speed needs to be designated. Select from 1/60 to 1/120,000(NTSC) or from 1/50 to 1/120,000 (PAL)

* 'Sens-up' mode can be configured manually (2x to 128x).

Verify changes made to the shutter speed by referencing to changes in on screen brightness.

3. Press the SET button to complete.

Note

- Image may become unstable if the camera is set to 'ESC' mode and faces a strong fluorescent light.
- Under 'ESC' mode, the brightness can be adjusted using the LEFT or RIGHT button.
- Sens-up is disabled under 'MANUAL' or 'A.FLK' mode.

→AGC (Auto Gain Control) : For brighter images.

1. Position the indicator over 'AGC' using the UP or DOWN button.
2. Set 'AGC' to the desired mode using the LEFT or RIGHT button.

- **HIGH** : Wide range gain value adjustment
- **MIDDLE** : Middle range gain value adjustment
- **LOW** : Narrow range gain value adjustment
- **OFF** : Disabled

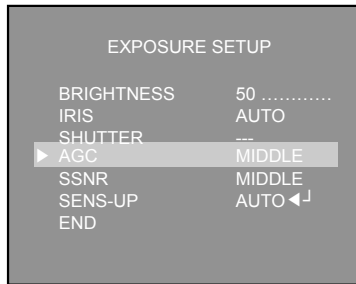

→SSNR (Super Noise Reduction) : On screen noise reduction.

1. Position the indicator over 'SSNR' using the UP or DOWN button.
2. Set 'SSNR' to the desired mode using the LEFT or RIGHT button.

- **LOW** : Low noise reduction
- **MIDDLE** : Medium noise reduction
- **HIGH** : High noise reduction
- **OFF** : Disabled

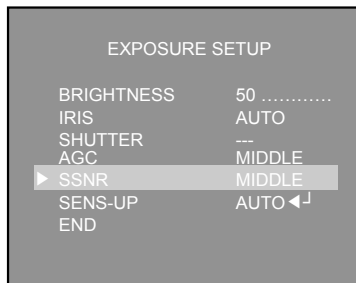

Note

- Changing 'AGC' setting from LOW to HIGH results in greater sensitivity, as well as on screen noise.
- Setting 'AGC' to OFF locks 'SSNR' configuration.

→SENS-UP : This feature ensures clear images at night or under low lighting conditions.

1. Position the indicator over 'SENS-UP' using the UP or DOWN button.
2. Set 'SENS-UP' to the desired mode using the LEFT or RIGHT button.

- **AUTO** : Select this mode for use in night time or under low lighting conditions.
- **OFF** : Disabled

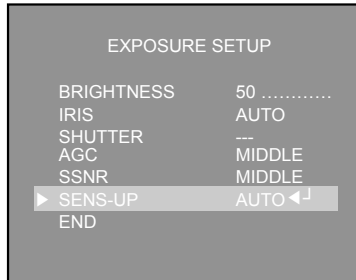

Note

- Once 'AUTO' mode is set, the user can configure Sens-Up limit by increasing / decreasing the shutter speed (e.g.: x2, ..., x32, x64, 128)
- Enabling Sens-Up increases camera sensitivity and may result in additional noise and/or other phenomenon. This is normal.

SPECIAL

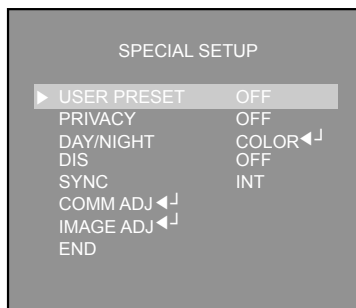

1. Press the SET button to access the main setup menu and then position the indicator over 'SPECIAL' using the UP or DOWN button.
2. Press the SET button to confirm.

→USER PRESET:

Preset user-Designated configurations using this feature. Position the indicator over 'USER PRESET' using the UP or DOWN button and then set to 'ON' using the LEFT or RIGHT button. Press the SET button to confirm.

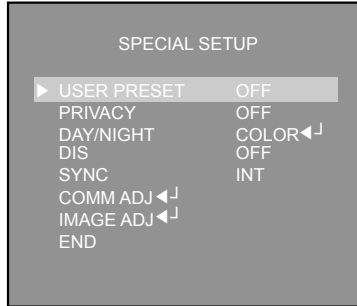

- PRESET NO : Up to eight different preset configurations are supported.

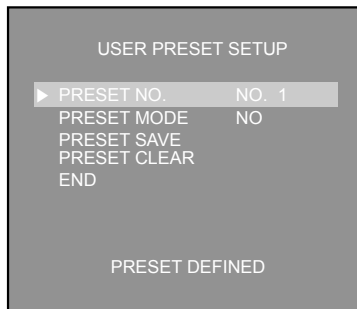

- PRESET MODE : Configure initial settings under FOCUS, EXPOSURE, etc.

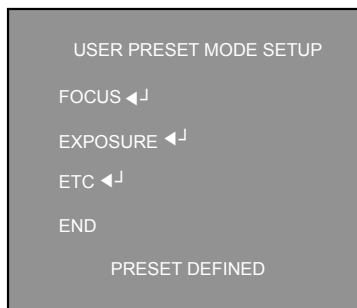

- PRESET SAVE : Save configured preset.

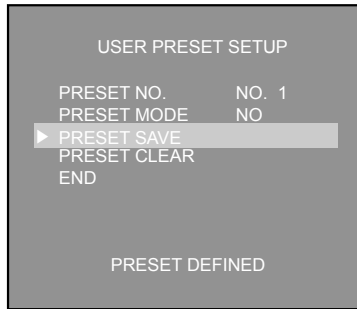

- PRESET CLEAR : Clear configured preset.

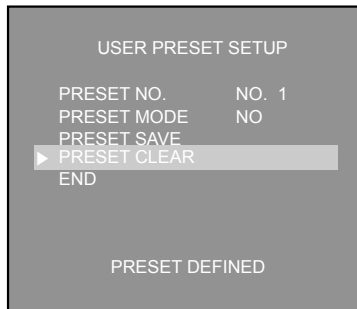

- END : Revert to the SPECIAL SETUP menu.

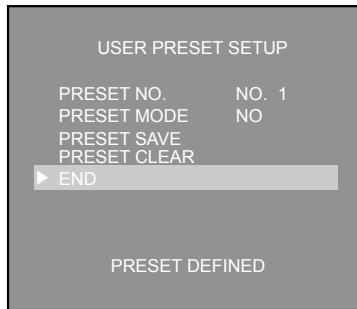

→PRIVACY : Mask privacy area using this feature. The mask area expand / contract upon the zoom position.

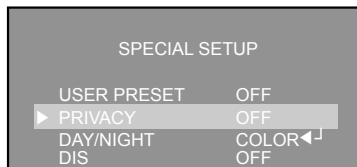

- **GROUP SEL** : Choose up to eight groups. Each group can consist of four mask areas.
- **MASK COLOR** : Adjust desired mask color level.
- **AREA SEL** : Configure eight mask areas.
- **AREA MODE** : Mask area display.
- **TOP** : To move the mask area up.
- **BOTTOM** : To move the mask area down.
- **LEFT** : To move the mask area left.
- **RIGHT** : To move the mask area right.

→DAY/NIGHT : Select from COLOR, BW or AUTO modes.

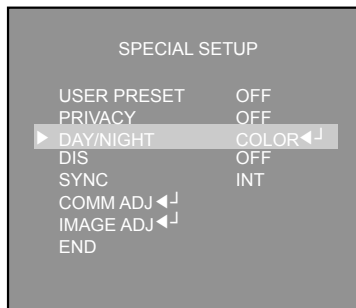

- **COLOR** : Color mode.
- **B/W** : BW mode.
- **AUTO** : The camera automatically detects lighting conditions and selects the mode accordingly.

→DIS : The DIS mode can compensate for vibration of the camera.

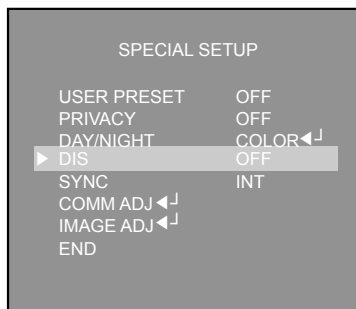

Note

- When DIS is operating, D-ZOOM does not operate.

→**SYNC** : Two synchronization modes are presented, INTERNAL and EXTERNAL LINE-LOCK. EXTERNAL LINE-LOCK mode is not available at the moment. Needed to be upgraded.

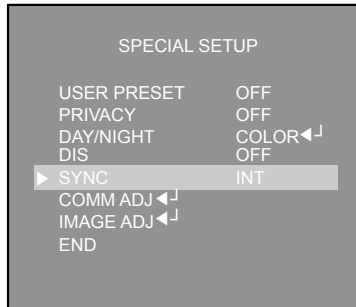

- **INT** : Internal synchronization.
- **LL** : External line-lock synchronization. It is not available at the moment.

Note

- The LINE-LOCK mode is not available at the moment.

→**COMM ADJ** : Use this feature to select communication protocol (refer to p.46~p.51 for details). Position the indicator over 'COMMUNICATION' using the UP or DOWN button.

- **CAM ID** : Assign an ID number to the camera (1 to 255)
Identification number zero is used for Remote controller setup.
- **DISP CAM ID** : Displays camera ID on top left corner of the screen.
- **BAUD RATE** : Configure baud rate from 2400 / 4800 / 9600 / 19200 / 38400 / 57600 bps.
- **UART MODE** : Configure parity bit to NON, EVEN, or ODD, Data bit is set to 8bit, and stop bit to 1bit. Set the UART MODE to EVEN if using the Remote Controller.
- **UART MODE** :Used to transfer a packet.
- **END**

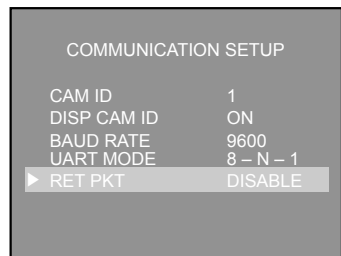

→**IMAGE ADJ** : Includes image quality or special function factors.

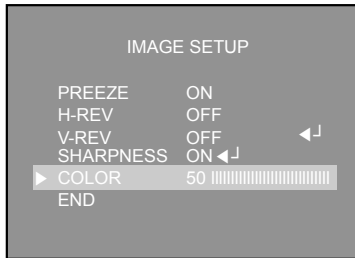

- **FREEZE** : Use this feature to freeze capture an image.
- **H-REV** : Use this feature to horizontally inverse the screen.
- **V-REV** : Use this feature to vertically inverse the screen.
- **SHARPNESS** : Increasing this value sharpens object edges. Too high of a setting, however, produces noise and may obscure the image.
- **COLOR** : Adjusting this value affects the chroma level only; the burst level is unaffected.

→**END** : Evert back to the USER PRESET menu.

RESET

To reset your camera to factory default condition.

EXIT

To finish setup menu.

10. SPECIFICATIONS

MODEL	CVC652HZ 23X COLOR ZOOM CAMERA	
Signal Format	NTSC	PAL
Scanning System	2 : 1 Interlace	
Pick-Up Device	1/4" Color Sony™ Super-HAD CCD	
Total Pixels Number	811 (H) x 508 (V)	795 (H) x 596 (V)
Picture Element	768 (H) x 494 (V)	752 (H) x 582 (V)
S/N Ratio	50dB (AGC Off, Weight On)	
Horizontal Resolution	Color : 550TV Lines, B/W : 600TV Lines	
Lens	23X Zoom, f=3.84 to 88.4mm	
Min. Focus Distance	1000mm	
D. Zoom	OFF/ON (Limit 10X)	
Angle field of view	H : Appr. 58.0° (Wide) to 2.22° (Tele) V : Appr. 44.8° (Wide) to 1.68° (Tele)	
Minimum Illumination	0.6 Lux (50 IRs) F1.6	
	0.1 Lux (B/W)	
	0.004 Lux (Sense-up mode)	
Digital Zoom Ration	ON / OFF (Limit 10x)	
Sync Scanning System	2:1 Interlace	
Sync Synchronization	Internal	
Frequency	Horizontal:15,734KHz / Vertical : 59.94Hz	Horizontal:15,625KHz / Vertical : 50.00Hz
OSD (On Screen Display)	OSD On / Off	
Camera Title	ON/OFF (Displayed 20 characters)	
Camera ID	255 ID Selectable	
Video Output	CVBS : 1.0Vp.p / 75Ω	
Camera Control	RS-485 (2400,4800,9600,19200,38400,57600bps)	
Day & Night	Auto/Color/ B/W (ICR type)	

10. SPECIFICATIONS

MODEL	CVC652HZ 23X COLOR ZOOM CAMERA	
Gain Control	Low, Middle, High, OFF Selectable	
White Balance	ATW (INDOOR (3,000~10500K), OUTDOOR (1,800~10,500K)) / AWC / MANUAL	
Electronic shutter speed	Auto/Manual (X128 ~ 1/60sec. ~ 1/120,000 sec.) Sense-up Limit is selectable	Auto/Manual (X128 ~ 1/50sec. ~ 1/120,000 sec.) Sense-up Limit is selectable
OSD	Built-in	
Motion Detection	ON/OFF (Built-in alarm output connector)	
SSNR	Low / Middle / High / Off Selectable (Noise Control)	
Focus	Auto / Manual / One Push	
Zoom Movement Speed	5.2 Sec : Wide to Tele	5.4 Sec : Wide to Tele
Lens Initialize	Built-in	
Preset	8-Positions	
DIS	ON/OFF	
Privacy Function	On/Off (32 Zones, 8 Groups / 4 Programmable Zones per Screen)	
FLIP	LEFT / RIGHT, UP / DOWN	
FREEZE	ON/OFF	
IRIS Control	Auto / Manual	
Operation Temperature / Humidity	-10 ~ 50°C / 30% to 90% RH	
Supplied Voltage	DC12V ±10% , Max 5W	
Power Consumption	Max. 4.8W (500mA)	
Option	Remote Controller (RS-485 type)	

Free Manuals Download Website

<http://myh66.com>

<http://usermanuals.us>

<http://www.somanuals.com>

<http://www.4manuals.cc>

<http://www.manual-lib.com>

<http://www.404manual.com>

<http://www.luxmanual.com>

<http://aubethermostatmanual.com>

Golf course search by state

<http://golfingnear.com>

Email search by domain

<http://emailbydomain.com>

Auto manuals search

<http://auto.somanuals.com>

TV manuals search

<http://tv.somanuals.com>