

Technika

EXCLUSIVELY FROM TESCO

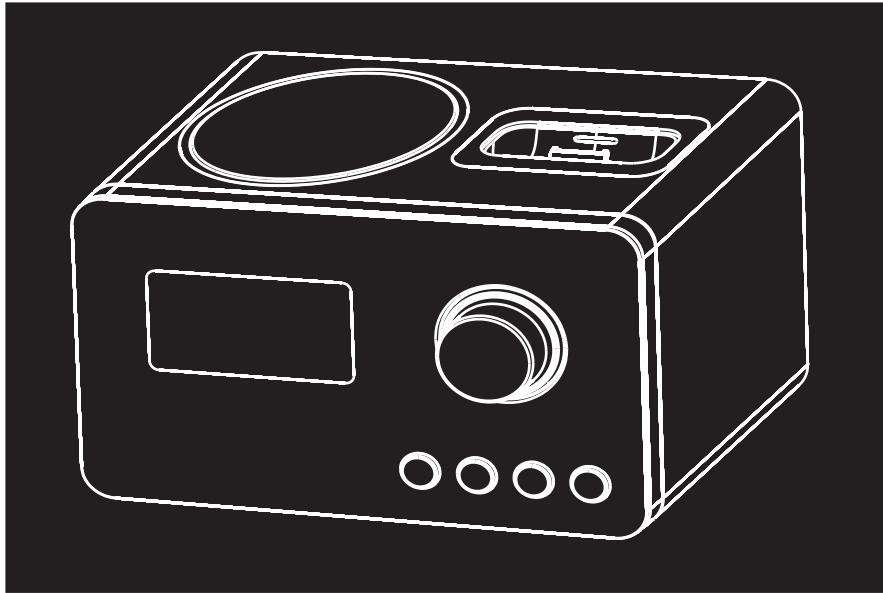

DAB-129ID

Owner's Handbook

Clock radio with dock for iPod



IMPORTANT SAFETY INFORMATION



This symbol indicates that there are important operating and maintenance instructions in the literature accompanying this unit.



This symbol indicates that dangerous voltage constituting a risk of electric shock is present within this unit.

Read these instructions.

Keep these instructions.

Heed all warnings.

Follow all instructions.

Do not use this apparatus near water.

Clean only with a slightly damp cloth.

Do not block any ventilation openings.

Install in accordance with the manufacturer's instructions.

Do not install or operate near any heat sources such as radiators, stoves, or other apparatus that produce heat.

Unplug this apparatus during lightning storms or when unused for long periods of time.

Refer all servicing to qualified service personnel. Servicing is required when the apparatus has been damaged in any way, such as the power-supply cord or plug is damaged, liquid has been spilled or objects have fallen into the apparatus, the apparatus has been exposed to rain or moisture, does not operate normally, or has been dropped.

Warning: To reduce the risk of fire or electrical shock, do not expose this product to rain or moisture. The product must not be exposed to dripping and splashing and no object filled with liquids such as a vase of flowers should be placed on the product.

No naked flame sources such as candles should be placed on the product.

Caution: Changes or modifications not expressly approved by the manufacturer could void the user's authority to operate this device.

Caution: Usage of controls or adjustments or performance of procedures other than those specified herein may result in hazardous exposure.

IMPORTANT

This equipment generates, uses and can radiate radio frequency energy and, if not installed and used in accordance with the instructions, may cause harmful interference to radio communication. However, this is no guarantee that interference will not occur in a particular installation. If this equipment does cause harmful interference to radio or television reception, which can be determined by turning the equipment off and on, the user is encouraged to try to correct the interference by one of the following measures:

- Reorient or relocate the receiving antenna.
- Increase the separation between the equipment and receiver.
- Connect the equipment into an outlet on a circuit different from that to which the receiver is connected.
- Consult the dealer or an experienced radio/TV technician for help.

ELECTRICAL INFORMATION

Use this appliance only with the supplied AC Adaptor. Using non-approved power supplies will void the warranty.

Mains Supply: The mains operating voltage of the AC Adaptor is marked on a rating plate on the AC Adaptor.

The means of disconnecting this appliance from the mains supply is the AC adaptor. This should be unobstructed and readily operable at all times.

INDEX

INDEX

Important safety information	1
Introduction	2
Unpacking	2
Controls & Connections.....	3
Display features	4
Remote control.....	5
Getting started	5
Power control	6
DAB reception.....	6
Volume control	6
DAB scanning	7
DAB display modes.....	7
Selecting a source.....	8
FM reception.....	8
Radio presets.....	8
Docking connecting and playing an iPod.....	9
Playing Aux sources	10
Setting the alarms.....	11
Checking and waking to the alarms.....	12
DAB Settings menu.....	13
FM settings menu and display modes.....	15
Sleep function	15
Care & Maintenance.....	15
Troubleshooting	15
Specifications	15
Warranty	15

INTRODUCTION

The DAB-129ID is a full-function remote controlled DAB and FM clock/radio with dual alarms and dock for an iPod.

The clock/radio function features a large-format backlit display for easy night reading.

PRELIMINARIES

UNPACKING

Carefully unpack the unit. If it is damaged, please return it to your nearest Tesco store for replacement. Remember to take your purchase receipt with you.

Retain the User Handbook. If you pass the unit on to a third party make sure you pass on the handbook.

We suggest you retain the packaging. If you dispose of it, do so having regard to any recycling regulations in your area.

CONTENTS

The carton should contain:

- The DAB-129ID Clock/radio
- AC adaptor
- Remote control with battery
- Operating Manual

If any items are missing or damaged, contact your nearest TESCO store for a replacement. Have your receipt ready when you call. Retain the packaging. If you dispose of it, do so having regard to any recycling regulations in your area.

LOCATION

Place the unit on dry stable surface away from heat and damp and where it is unlikely to fall or be knocked over.

CONTROLS & CONNECTIONS

FRONT VIEW

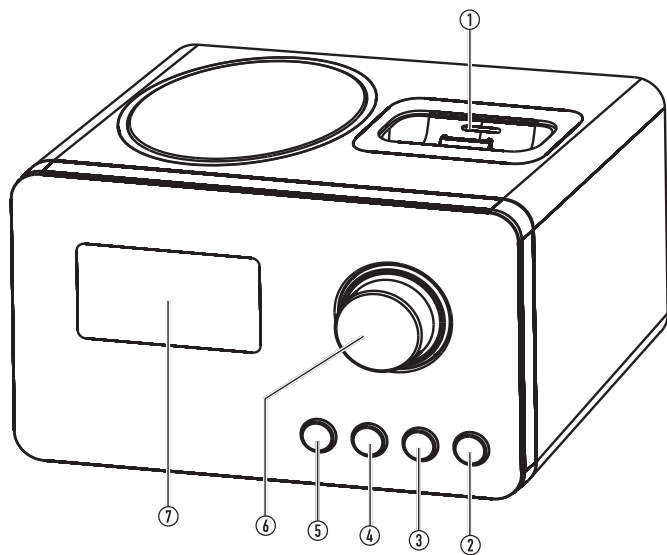

- ① iPod docking bay
- ② Menu/Standby button
- ③ Function button
- ④ ►||/Scan button
- ⑤ Snooze/Dimmer button
- ⑥ Volume/Select Control
- ⑦ Display

BACK VIEW

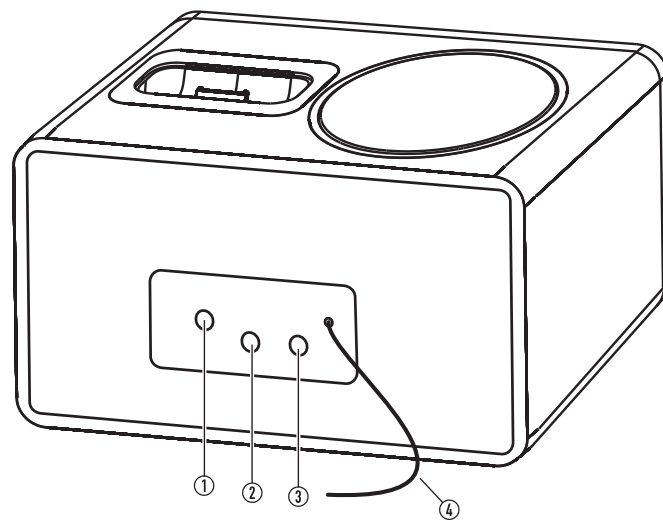

- ① DC input jack
- ② Aux in jack
- ③ Headphone jack
- ④ DAB/FM Aerial wire

DISPLAY FEATURES

TIME DISPLAY



The display shows the current time and date when set to Standby.

VOLUME DISPLAY



When changing the volume level, the display shows a volume bargraph.

SNOOZE DISPLAY

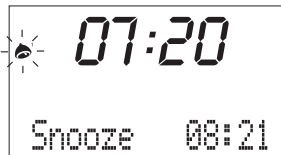

When Snooze has been set after the alarm has sounded, the remaining snooze time counts down at the bottom of the display.

DISPLAY LAYOUT



- ① Alarm 1 set symbol
- ② Alarm 2 set symbol
- ③ Sleep symbol
- ④ Time display
- ⑤ Station name/Source display
- ⑥ Info display

REMOTE CONTROL

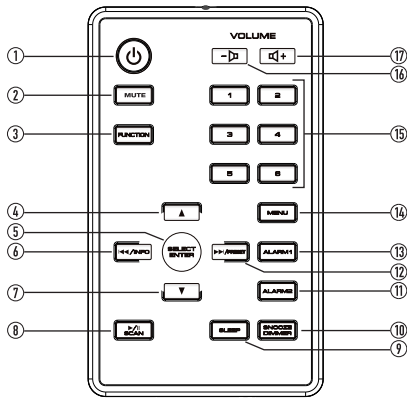

- ① Standby button
- ② Mute button
- ③ Function button
- ④ Up button
- ⑤ Select/Enter button
- ⑥ ◀/Info button
- ⑦ Down button
- ⑧ ▶/Scan button
- ⑨ Sleep button
- ⑩ Snooze/Dimmer button
- ⑪ Alarm 2 button
- ⑫ ▶▶/Preset button
- ⑬ Alarm 1 button
- ⑭ Menu button
- ⑮ Numeric keypad
- ⑯ Volume down button
- ⑰ Volume up button

REMOTE CONTROL BATTERIES

BEFORE FIRST USE

Before using the remote control, the battery (supplied) must be fitted.

FITTING/REPLACING THE BATTERY

When fitting or replacing the battery in the remote control, refer to the diagram below.

1. Press the catch across.
2. While holding the catch, open the battery door.

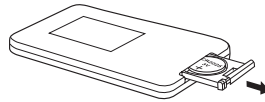

3. Fit the battery observing polarity as shown. When replacing the battery, use only the same CR2025 type specified.

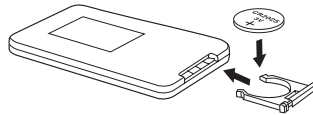

BATTERY DISPOSAL

Dispose of used batteries with regard to the recycling regulations in your area. Do NOT short circuit batteries or throw them into water, the general rubbish or in a fire. Weak batteries can leak and damage the remote control. Replace them in good time!

GETTING STARTED

DAB/FM AERIAL

Before using your radio for DAB or FM reception, unwrap and fully extend the aerial wire. You may need to adjust the position of the aerial wire for maximum signal strength.

CONNECTING POWER

Before connecting the power, check that the mains voltage on the rating plate of the AC adaptor is the same as the voltage in your area.

- Plug the DC cord from the AC adaptor into the DC jack on the back of the unit.
- Plug the AC adaptor into the wall socket and switch the mains power on.

The unit is now ready for use.

NOTE:- The AC adaptor may become warm during operation - this is normal.

When first connected to the power, the clock and calendar display will show 'zeros'.



SETTING THE CLOCK



The clock on your radio is automatically set when first used from the time signal broadcast with DAB radio stations.

If a DAB station is not available, the clock may be set manually via the MENU system (see page 13).

POWER CONTROL



STANDBY CONTROL

To turn the radio on:

- Press the **MENU**/ button on the front panel or the red  button on the remote control.

The display will light and the radio will switch on.

To turn the radio off:

- Press and **hold** the **MENU**/ button on the front panel or press the  button on the remote control **briefly**.

The radio will switch off. The clock will continue to run whilst mains power is connected.

INITIAL SCAN

When your radio is switched on for the first time the scanning display will be shown while the scanning process takes place:



Progress bar

Number of stations found

The radio scans all usable stations (full scan) and stores them alphanumerically - 1 Radio, 2 Radio, AA Radio, AB Radio... The initial scan will take a few minutes. After the scan, the clock will be set and the radio will display the name of the first station in the sequence. To select this station, push the **VOLUME/SELECT/ENTER** control on the front panel (or the **SELECT/ENTER** button on the remote control). To browse for another station, refer to the next section.



BROWSING FOR A STATION

To browse for another DAB station from the front panel controls:

- Press the **MENU** button.
- <Station list> will be displayed.
- Push the **VOLUME/SELECT** control to display the station list.
- Turn the **VOLUME/SELECT** control to browse the station list.
- Push the **VOLUME/SELECT** control to select the station displayed.

After a short delay, the radio will tune to the station.

To browse for another DAB station from the remote control:

- Press the  or  button repeatedly to browse through the station list.
- When you find a station you want to play, press the **SELECT/ENTER** button.



After a short delay, the radio will tune to the station.

ADJUSTING THE VOLUME

To adjust the volume from the front panel controls:

- Turn the **VOLUME/SELECT** button to adjust the volume, clockwise to increase and anti-clockwise to decrease.

To adjust the volume from the remote control:

- Press the  or  button to increase or decrease the volume level.

When the volume is adjusted the display will change to show the current volume setting on a bargraph.



Volume bargraph

MUTE

To mute the sound:

- Press the **MUTE** button.
- The sound will mute and 'Volume Muted' will be displayed.*
- Press the **MUTE** button again to restore the sound to its previous volume level..

DAB SCANNING

RE-SCANNING FOR DAB STATIONS

When first used, your radio scanned the DAB band for available stations. The station services found were then stored in your system's memory.

You can re-scan the band at any time if you move to a different area or just to refresh the stored list of available stations.

To scan for DAB stations manually:

- Select the DAB band.
- Press the ►II/SCAN button on the front panel or remote control.

The scanning process will take a few minutes. The number of services found during the scan will be shown at the right side of the display.

After the scan, the radio will re-tune to the last station playing if it is available. If this station is not available, the name of the first station in the sequence will be displayed. To select this station, push the **VOLUME/SELECT** control or press the **SELECT/ENTER** button on the remote control.

Alternatively, you can continue to browse for another station as described on the previous page.

DISPLAY DIMMER

The display brightness can be switched between high and low settings by pressing the **SNOOZE/DIMMER** button on the front panel or remote control.

DAB DISPLAY MODES

DISPLAY MODE OPTIONS

The bottom line of the display can be switched to show different items of information that may be transmitted with a DAB station.

Choosing the information display:

Press the ◀◀/INFO button on the remote control repeatedly to change the information displayed while playing a DAB radio station.

The full range of display options are shown below. Some stations may not broadcast all of these options.

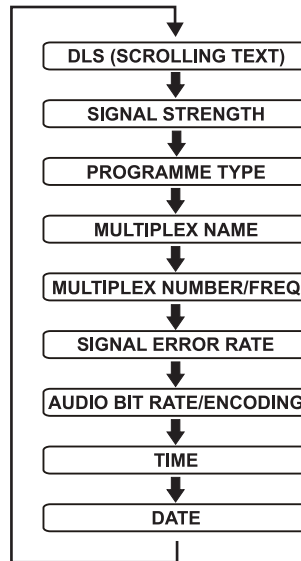

DLS (Dynamic Label Segment): This is a scrolling message giving real-time information - song titles, news headlines, etc.

SIGNAL STRENGTH: This setting will display a signal strength bargraph. The longer the bargraph, the stronger the signal. Setting the display to show signal strength is useful when setting up the aerial for the strongest signal.

PROGRAMME TYPE: This describes the style of the programme being broadcast.

MULTIPLEX NAME: DAB Digital radio stations are broadcast in multiplexes. Each multiplex is a bundle of radio stations transmitted in a single frequency. There are national and local multiplexes; local ones contain stations specific to your area. This option displays the name of the multiplex name that contains the station you are listening to.

MULTIPLEX NUMBER/FREQ: This option will display the multiplex number and frequency that contains the station you are listening to.

SIGNAL ERROR RATE: This option will display the level of signal errors in the current broadcast. The lower the number, the better the quality of the signal.

BIT RATE: DAB allows broadcasters to vary the BIT RATE (or the amount by which an audio signal can be compressed) depending on the type of broadcast. This enables the amount of stations on a multiplex to be maximised. Speech and News are often broadcast at a lower Bit Rate; music needs a higher Bit Rate for good fidelity.

TIME AND DATE: Time and date are updated by broadcasted information.

SELECTING A SOURCE

SOUND SOURCES

You can choose to listen to the following sources -

- DAB radio
- FM radio
- iPod (when docked)
- Aux source (when connected via the rear panel AUX jack).

Selecting a source:

- Press the **FUNCTION** button on the front panel or remote control repeatedly to scroll through the available sources.

LISTENING TO FM RADIO

Your radio can also receive FM band radio stations and display RDS data (where broadcast).

To change to the FM band

- Press the **FUNCTION** button repeatedly to select FM mode.

To auto-tune to FM stations

- Press the **SCAN** button to search for the next station in the band.

The radio will search and the tuning frequency will be displayed whilst searching.

When a usable station is detected the radio will stop tuning and play the station. If RDS data is present, the station name and scrolling radio text will be displayed. If RDS data is not present, the tuned frequency will be displayed.

To manually tune to FM stations

- Press the **▲** or **▼** button on the remote control to tune the band in 50kHz steps.

STEREO/MONO RECEPTION

You can set your radio to switch automatically between stereo and mono FM reception (Mono/Stereo mode) or to receive in mono only (Mono Only mode). Setting to Mono Only mode may improve sound quality in areas where a weak aerial signal results in a high level of background noise. FM audio mode selection is made via Audio Setting in the FM menu. Refer to the FM Settings Menu section on page 15 for more details of the FM menu.

STATION PRESETS

DAB and FM presets

Using the remote control, your radio can store up to 10 of your favourite stations as presets on both the DAB and FM bands for quick recall. Direct access number buttons are available for Presets 1 to 6. For this reason you may prefer to store your most-used stations in Presets 1 to 6.

To quick store preset 1 to 6

- Tune to the station you want to store as a preset.
- Press and **hold** one of the **NUMBER** buttons.

To recall a preset 1 to 6

- Press one of the **NUMBER** buttons **briefly**.

The preset station will be tuned. If the preset selected is empty, then the radio will continue to play the last selected station.

To store any preset 1-10

- Tune to the station you want to store as a preset.
- Press and **hold** the **►/PRESET** button.

'Preset Stored' will be displayed.

- Press the **▲** or **▼** button repeatedly to find the preset number you want to store.

For each preset number the preset station currently stored will be displayed or 'Empty' if none is stored.

- Press the **SELECT/ENTER** button to confirm if you want to store the station in the displayed preset number.

To recall any preset 1-10

- Press the **►/PRESET** button **briefly**.
- Press the **▲/UP** or **▼/DOWN** repeatedly to find the preset number you want to play.
- Press the **SELECT** button **briefly** to play the preset.

iPod ADAPTORS

Before docking your iPod you must first check if your iPod has a docking connector. Early iPod models do not have one and cannot be docked to your unit. The docking connector is located on the base of the iPod as shown below.

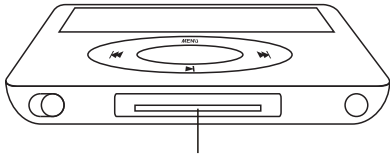

Docking Connector

Before docking your iPod, you must first fit the correct iPod adaptor to the docking bay. Each iPod adaptor matches the shape of a particular iPod and is necessary to ensure that your iPod is securely held when docked.

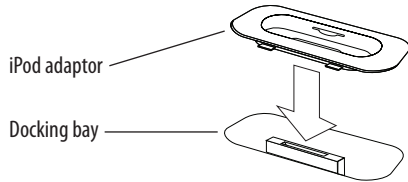

FITTING THE iPod ADAPTOR

When your iPod was new it may have been supplied with a standard dock adaptor in the packaging. If so, fit the adaptor by pressing it gently into the Docking Bay as shown above.

NOTE: Do not dock an iPod without fitting the correct adaptor, you may damage the iPod and your unit.

FINDING AN ADAPTOR

If you don't have a dock adaptor

If your iPod was not supplied with a standard dock adaptor, or if you have lost the adaptor, you can buy one from Apple on-line. To determine the exact model of your iPod, refer to this web-link - <http://support.apple.com/kb/HT1353>. You can then browse the iPod accessories page on the Apple website to find an adaptor for your iPod model that can be purchased on-line.

CONNECTING OTHER iPod MODELS (INC SHUFFLE)

If you own an iPod Shuffle, a model without dock connector or prefer to connect your iPod by cable, you can connect the sound output to the AUX IN jack on the rear panel.

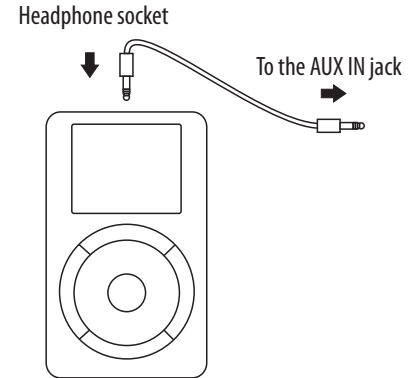

- Using a 3.5mm stereo jack to jack cable (supplied), connect one end of the cable to the headphone socket of the iPod, and the other end to the AUX IN jack on the back panel.
- To listen to your iPod, follow the instructions on page 10 for playing equipment connected to the AUX IN jack.

NOTE:- The volume control of the iPod must be turned up when playing through the AUX IN jack.

NOTE:- An iPod connected to the AUX IN jack cannot be operated from the remote control and will not be activated by the alarm.

DOCKING AN iPod

DOCKING YOUR iPod

To dock your iPod:

- Switch off the power.
- Check that the correct iPod adaptor is fitted to the docking bay.
- Locate the iPod on the Docking Connector and press it gently home.
- The unit will switch on and the iPod will start to play.

To remove your iPod from the dock:

- Grip the iPod at the sides.
- Lift the iPod gently from the dock.

CHARGING AN iPod

When an iPod is docked, the iPod will begin to charge automatically.

NOTE:- The iPod will not charge when the radio is set to Standby.

PLAYING FROM AN iPod

Once an iPod is docked, you can operate your iPod functions from the remote control.

Playback functions:

- Press the **▶||/SCAN** button to toggle between Play and Pause mode at any time.
- Press the **▶▶/PRESET** or **◀◀/INFO** button to select the next or previous track on your iPod.

iPod menu functions:

When an iPod is docked and playing you can navigate the menus from the front panel or remote control.

- To move up through the iPod menu, press the **MENU** button.
- To scroll up and down options displayed on the iPod menu, turn the **VOLUME/SELECT** control on the front panel or press the **▲** or **▼** button on the remote control.
- To select menu items, push the **VOLUME/SELECT** control or press the **SELECT/ENTER** button on the remote control.

AUX SOURCES

The AUX IN input may be used to connect sound sources with a Line or Headphone analogue output to play through your unit. These may include -

- iPod models that cannot be docked to the unit
- MP3 players
- CD walkman players
- Tape walkman players
- Personal computers or laptops

Connecting to the AUX IN jack

- Connect a stereo 3.5mm jack cable (supplied) between the headphone or LINE/AUX output of the personal audio player and the AUX IN jack on the back panel.

Playing the AUX source

- Press the **FUNCTION** button repeatedly to select AUX mode.

Auxiliary Input Mode will be displayed.

- Set your personal audio player/computer to **PLAY**.
- Set the listening volume to the level you want with the volume controls on the radio or remote control.

If there is no sound or if the volume level is not loud enough, you may need to increase the volume setting on your personal audio player/computer.

SETTING THE ALARMS

SETTING THE ALARMS

You can set two completely separate alarm times (ALARM 1 and ALARM 2) and activate either or both of them to wake you with a buzzer, radio, or music from a docked iPod. You can also pre-set the station preset and volume settings that the alarms will wake you with.

The alarms are set from the remote control or from within the Settings Menu (see page 13).

Checking and changing alarm settings:

All alarm settings are made through the Alarm menu.

NOTE:- You must complete all settings before leaving the menu or your changes won't be saved.

Setting Alarm 1:

- Switch on the radio (Alarm settings cannot be changed when set to Standby).

- Press the **ALARM1** button on the remote control.

'Alarm 1 Setup' will appear on the display.

- Press the **SELECT/ENTER** button if you want to set Alarm 1.

'Alarm 1 Wizard' will appear on the display.

The alarm is now set in the sequence shown in the next column.

NOTE: Press the **MENU** button at any time to exit alarm setting, leaving the settings unchanged.

ALARM SETTING SEQUENCE

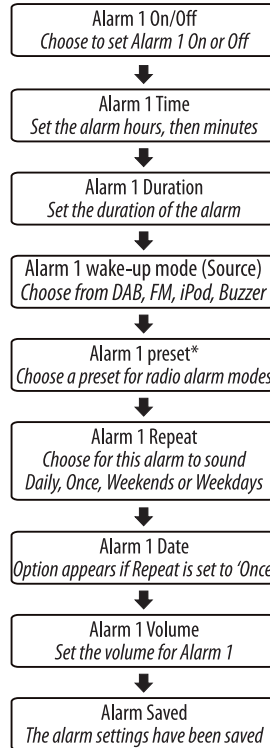

To make a change to a setting:

1. Press the ▲ or ▼ button to scroll through the options available for a setting (or times when clock setting).
2. When you have finished changing a setting, press the **SELECT/ENTER** button to confirm the setting and move on to the next setting in the sequence.
3. Repeat the previous two steps to change each setting as required.

*NOTE:- When changing the Alarm radio preset setting, choose the 'Last listened' option to wake to the last station you played before setting the radio to Standby.

Saving alarm settings:

Your alarm settings are automatically saved when you complete the last setting and press **SELECT/ENTER**.

The display will confirm with the words 'Alarm saved'.

Setting Alarm 2:

- Press the **ALARM2** button on the remote control to open the Alarm menu and set Alarm 2.
- To change the settings, follow the procedure described for setting Alarm 1 on this page.

CHECKING ALARM SETTINGS

You can step through the setting procedure without making any changes to check the alarm settings.

To check the settings for Alarm 1 or 2:

- Switch the radio on.
- Press the **ALARM1** (or **ALARM 2**) button.
- Press the **SELECT/ENTER** button repeatedly to step through the settings and view them without making any changes.
- Continue to view the steps until 'Alarm Saved' is displayed.

ALARM REPEAT

The alarm(s) will repeat according to the Alarm Repeat setting you made when setting the alarm.

- Daily - The alarm will sound every day.
- Weekdays - The alarm will sound on weekdays, but not at weekends.
- Weekends - The alarm will sound on weekends, but not on weekdays.
- Once - The alarm will sound only once. If this setting has been chosen, an extra option is added for you to set the date that you want the alarm to sound.

WAKING TO THE ALARMS

SETTING THE ALARM TO WAKE YOU

To set the alarm to wake you:

- Check that the Alarm 1 and/or Alarm 2 symbols are displayed as required. If not, set the Alarm(s) On as described in the 'Setting the Alarms' section on the previous page.



- If you have set either wake up mode to 'iPod', make sure that your iPod is docked.
- Set the radio to Standby (or set the SLEEP function).

The radio will switch off and the time and date will be displayed with the Alarm Symbol(s).

WHEN THE ALARM WAKES YOU

When the alarm sounds you can choose to set snooze, which will reset the alarm for a further 9 minutes, or to switch it off.

To set snooze:

- To set snooze, press the **SNOOZE/DIMMER** button when the alarm sounds.

The alarm will stop and the alarm indicator and the snooze time will count down on the display. After 9 minutes the alarm will sound again.

To switch off the alarm:

- To switch off the alarm, press the **MENU/⏻** button or the **⏻** button on the remote control.

The unit will set to Standby.

ADVANCED OPERATION - DAB SETTINGS MENU

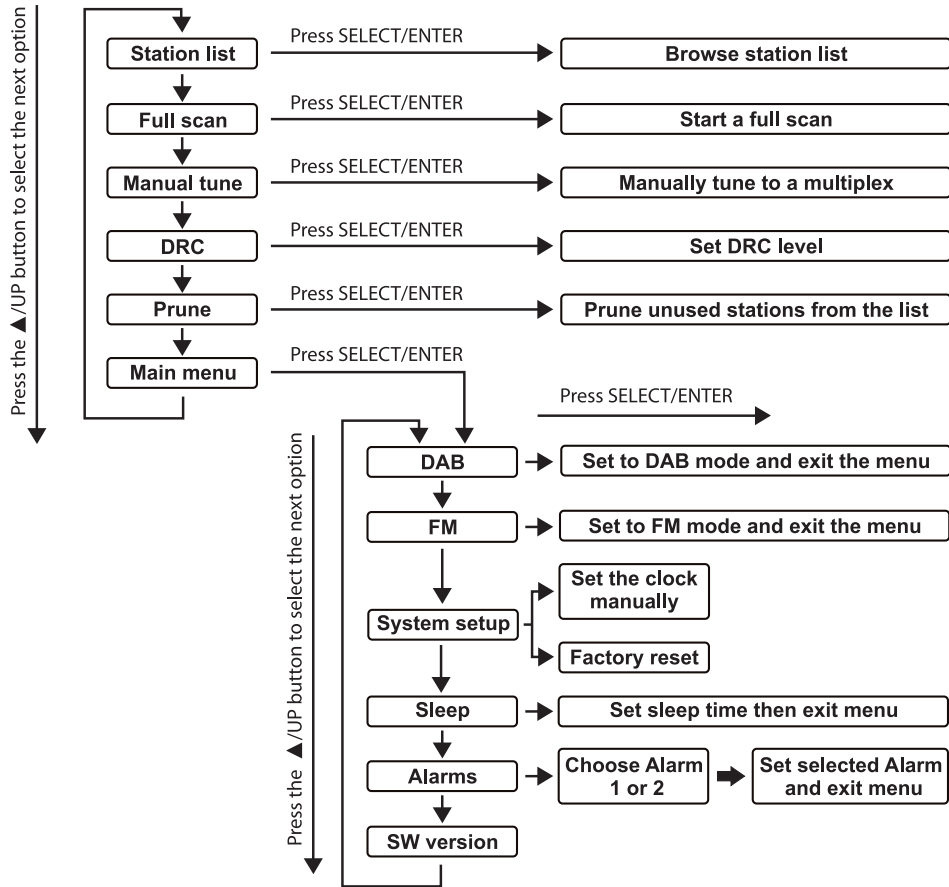

DAB SETTINGS MENU (contd.)

DAB SETTINGS MENU

Your radio has some additional features and options that may be reached through the Settings Menu.

A complete map of the menu is shown on the previous page.

NOTE: The main menu options may be useful for accessing features such as alarm setting and sleep time if the remote control is not to hand.

To enter the DAB Settings Menu from the front panel controls:

- Set to DAB mode.
- Press the **MENU**/ button.

*To scroll through available options, turn the **VOLUME/SELECT** control. To choose an option from the menu, push the **VOLUME/SELECT** control.*

To enter the DAB Settings Menu from the remote control:

- Set to DAB mode.
- Press the **MENU** button.
- Press the  button to scroll through available options.
- To choose an option from the menu, press the **SELECT/ENTER** button.

MORE DETAIL OF THE DAB SETTINGS MENU OPTIONS:

STATION LIST: Selecting Station List will exit the Settings Menu to browse the DAB station list. Stations may be selected from the list.

FULL SCAN: Select Full Scan to re-scan the entire DAB band and refresh the station list. A Local Scan (selected with the **SCAN** button) will scan only the bands used in the locality of the radio. A full scan will scan all bands.

MANUAL TUNING: Manual tuning enables you to search the band manually, stepping through the multiplex numbers to check if any have usable signal strength. Manual tuning is not necessary in normal operation where scanning will have automatically established a station list of all useable stations.

DRC: DRC is Dynamic Range Compression. Enabling DRC may improve the sound of DAB radio when listening in a noisy room.

PRUNE: If your station list includes stations that you can no longer receive (you may have moved to a different area), you can select the 'Prune' option to remove any stations that can no longer be received from the Station List.

MAIN MENU/DAB: This option will exit the settings menu to play DAB radio.

MAIN MENU/FM: This option will exit the settings menu to play FM radio.

MAIN MENU/SYSTEM SETUP/TIME SETUP: This menu option enables the clock to be set manually if there is no available DAB transmission.

MAIN MENU/SYSTEM SETUP/FACTORY RESET: This option will restore all settings to 'factory original'. All clock and alarm times, station lists and any stored preset stations will be cleared. After factory reset the radio will automatically re-scan the DAB band when first used.

MAIN MENU/SLEEP: Choose this option to set the Sleep time from within the settings menu. Note that this option enables Sleep time to be set from the control panel of the unit if the remote control is not available.

MAIN MENU/ALARMS: Choose this option to view or change the settings of Alarm 1 or Alarm 2 from within the settings menu. Note that this option enables Alarm settings to be checked or changed from the control panel of the unit if the remote control is not available.

MAIN MENU/SW VERSION: This option will display the version number of the control software currently installed in your radio. This will be helpful to a technician who is servicing the radio.

FM SETTINGS MENU

FM SETTINGS MENU

There are also some menu settings that are specific to FM radio operation. These settings may be changed through the Settings Menu.

To enter the FM Settings Menu:

- Set to FM mode.
- Press the **MENU/** button on the front panel or the **MENU** button on the remote control.

A map of the menu is shown below. To scroll through available options, turn the **VOLUME/SELECT** control or press the **▲** button on the remote control. To choose an option from the menu, press the **SELECT/ENTER** button.

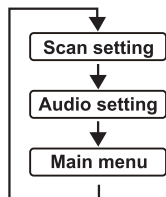

MORE DETAIL OF THE FM SETTINGS MENU OPTIONS

SCAN SETTING: With this menu option you can set the scanning sensitivity of the FM radio to two different levels- 'Strong stations only' or 'All stations'. Setting to 'Strong stations only' will exclude weaker stations resulting in a quicker scan. If you set to 'All stations' the scan will stop at every station detected, even if the signal is weak.

AUDIO SETTINGS: This option enables you to set the radio to receive FM in Auto mode (Mono/Stereo) or in Mono only. This may be useful if the signal is weak and the broadcast is noisy.

FM DISPLAY MODES

FM DISPLAY MODE OPTIONS

The bottom line of the display can be switched to show different items of information that may be transmitted with an FM station.

To change the display mode:

Press the **◀◀/INFO** button on the remote control repeatedly to change the information displayed while playing an FM radio station.

The full range of display options are shown below. Some stations may not broadcast all of these options.

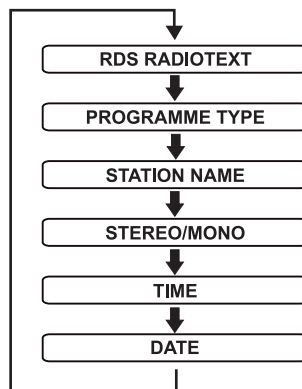

SLEEP FUNCTION

SLEEP TIMER

You can set the Sleep timer to play music for a set period while you are falling asleep.

To set the sleep timer:

- Play your choice of music.
- Press the **SLEEP** button on the remote control repeatedly to cycle through the sleep time options of 15 minutes, 30 minutes, 45 minutes, 60 minutes, 90 minutes or OFF (sleep off).
- Press the **SELECT/ENTER** button to confirm the sleep time.

The Sleep symbol will be displayed and music will continue to play for the time you selected, then the unit will set to Standby.

NOTE:- Sleep time can also be set through the Settings Menu if the remote control is not available.

HEADPHONES

There is a headphone output jack on the back panel of the radio. If headphones are connected to this socket for private listening, the speakers will cut out automatically.

CARE AND MAINTENANCE

CARE AND CLEANING

All care and cleaning operations should be carried out with the unit unplugged from the mains power.

The surface of the unit can be cleaned with a barely damp cloth and then dried carefully. Never use abrasives, abrasive cloths or chemical solvents.

TROUBLESHOOTING

Poor quality radio reception

The aerial signal may not be adequate. Try repositioning the aerial while watching the signal strength. Signal strength can be displayed by tuning to a DAB station and pressing the **◀/INFO** button

Alarm not sounding

Check that you set Alarm 1 or Alarm 2 on in the alarm setting sequence. When the alarms are on, the Alarm 1 or Alarm 2 symbol will be displayed.

Alarm sound not audible or too loud:

Change the alarm volume setting. This setting is changed in the 'alarm setting' sequence.

No sound/low volume from AUX source:

Check that the volume control is turned up on the AUX source.

Poor quality radio reception when an iPhone is docked:

You may need to set the iPhone to 'airplane' mode when docked.

WARRANTY & SPECIFICATIONS

SPECIFICATIONS

Supply Voltage, Current : 9V ---, 1.5A

AC Adaptor input:..... 100-240V ~, 0.5A max.

Output power..... 2W rms

Frequency range 174.928-239.200MHz (DAB)
87.5-108MHz (FM)

Net Weight:..... 2.85kg



Class II construction double insulated.

This product must not be connected to earth.



UK: Waste electrical products/batteries should not be disposed of with household waste. Separate disposal facilities exist, for your nearest facilities see www.recycle-more.co.uk or in-store for details.

ROI: Produced after 13th August 2005. Waste electrical products/batteries should not be disposed of with household waste. Please recycle where facilities exist. Check with your Local Authority or retailer for recycling advice.

WARRANTY

Your Tesco appliance is covered by a warranty for 12 months from the date of purchase. If a fault develops during this period, please contact the TESCO electrical help line on 0845 456 6767. Please have your original purchase receipt with you when you call. This warranty in no way affects your consumer rights.

Technika

Tesco Stores Ltd,
Delamare Road, Cheshunt, Herts, EN8 9SL

► **Technika Helpline: 0845 456 6767** (Calls cost up to 4p per minute from a BT landline, other providers may vary)

DAB129ID V0.1

Free Manuals Download Website

<http://myh66.com>

<http://usermanuals.us>

<http://www.somanuals.com>

<http://www.4manuals.cc>

<http://www.manual-lib.com>

<http://www.404manual.com>

<http://www.luxmanual.com>

<http://aubethermostatmanual.com>

Golf course search by state

<http://golfingnear.com>

Email search by domain

<http://emailbydomain.com>

Auto manuals search

<http://auto.somanuals.com>

TV manuals search

<http://tv.somanuals.com>