

Telex®

Operating Instructions



FMR-500

User Guide

TELEX®

Section 1 - Quick Set-Up

Quick Set-up: Receiver

1. Do not connect the receiver to any other equipment yet!
2. Connect the two antennas to the receiver.
3. Plug the power supply into the back of the receiver and into an outlet.
4. Press the POWER switch. Display will light up.
5. Press and hold the SET button until ClearScan™ shows and starts flashing on the right side of the screen.
6. When ClearScan stops flashing, the receiver will automatically set itself and display the clearest group and channel.
7. If you are using a guitar, turn off the receiver. Press and hold SET while you turn the receiver on. A guitar symbol will appear in the display to indicate instrument mode.
8. Turn the receiver off and connect the mixer or other audio system to the receiver XLR Connector or the ¼ inch Line Level Jack.
9. Set the audio mixer or other system input level to minimum.
10. Press the Power switch button in again.

Receiver "Quick Set-up" is complete.

Quick set-up: Transmitter

1. With the Power Switch on the transmitter OFF, install a fresh alkaline battery into the transmitter.
2. Place the transmitter Power Switch to the ON position.
3. The Red Battery Low Light near the display will flash on and then off. The display will also come on and display a group and channel.
4. Press the SET button once and the Group number will flash.

Section 2 - System Description

The FMR-500 Wireless Microphone system combines frequency agility and ease of use like no other. The transmitters and receivers operate over a 24 MHz bandwidth in the UHF portion of the Radio Frequency spectrum.

System Features Include:

- Advanced ClearScan technology for selecting the clearest available channels in intermodulation free groups
- Completely programmable in 25 kHz steps for over 950 possible frequencies
- LCD Displays for ease of viewing-Group, Channel, Frequency, Battery Status, Diversity Activity, Audio Meter and RF Meter
- Patented Phase Diversity System
- Adjustable Unbalanced Line Level 1/4 inch output jack
- Balanced XLR output jack for fixed Microphone Level or adjustable Line Level

5. Use the up and down arrows to change the Group number to match the Group number displayed on the receiver. Press SET and the Channel Number will flash.
6. Use the up and down arrow buttons to change the Channel to match the receiver. Press Set and nothing will be flashing. The channel is now set.
7. If you are using a bodypack transmitter, plug the microphone into the transmitter connector. If using a guitar, turn the transmitter off and wait until display is blank. Hold SET down and turn the transmitter on. A guitar symbol should appear on the display. Plug the cord into the transmitter and guitar.

Transmitter "Quick Set-up" is complete.

Quick set-up: System Operation

1. With the transmitter and receiver on, monitor the display screen. Note that the RF (1-100) Bar graph should indicate near the 100 mark. The AF Bar should show very little, if any, indication until you talk or sing into the microphone. While talking or singing in the loudest voice used in performance, adjust the transmitter gain control *if necessary* to cause the AF Bar Graph to peak near -6 to -3 but not over +3 for best performance.
2. Set the mixer/amp gain.
3. Talk or sing into the microphone or play the guitar at a normal volume. You should hear audio coming out of the system.
4. If using the unbalanced 1/4" output, you may have to adjust the gain (via the control next to the connector on the back panel) to match the level found when singing or playing with a wired connection.

"Quick Set-up" is now complete.

Please enjoy your FMR-500 system.

The high quality audio circuitry and advanced Radio Frequency (RF) signal processing offer broadcast quality signal-to-noise and audio clarity.

Section 3 - Detailed Components Description

FMR-500 Receiver Controls, Connectors, and Indicators

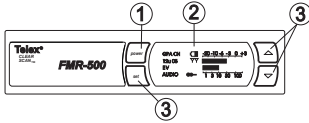

Figure 1 - FMR-500 Front Panel

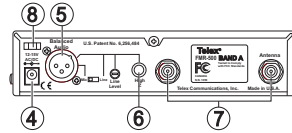
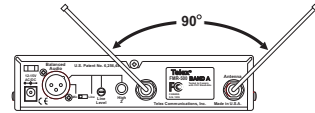

Figure 2 - FMR-500 Back Panel

1. Power ON/OFF
2. Graphical Display
 - a. Channel Display
 - b. Frequency
 - c. Battery Strength Indicator
 - d. Diversity Indicator
 - e. RF Strength of Signal Indicator
 - f. Audio Level Indicator
 - g. Guitar Mode Indicator
3. Display Control Buttons (Set/Up/Down)
4. Power Connector
5. XLR Balanced Mic/Line Level Audio Output Line Level Adjustable
6. Unbalanced Line Level Audio Output Connector with Level Adjustment
7. TNC Antenna Input Connectors
8. Power Cord Retainer



Proper Antenna Orientation

Receiver Setup and Operation

1. Place the receiver and antennas where there is a clear line of sight to the area where the transmitter will be used. Rotate the antennas to separate them by 90 degrees.
2. **Connect the power supply** cord to the receiver. Plug the power supply into an AC outlet. Turn the receiver on and confirm that it is ON by checking the main display screen.

Caution: Please make sure the AC power supply is the correct voltage for your local requirements before it is plugged into the wall.

3. **Manual Channel Change.** Press the SET button and the Group number will start to flash. The Up and DOWN buttons allow you to scroll through the factory set group. When the group you desire is displayed, press SET to select that group and the Channel Number will start flashing. Scroll to the desired channel and press SET to select. The numbers will stop flashing and the new group and channel are installed.
4. **Frequency Assignment (Outside of preset Groups and Channels),** press SET and UP at the same time and the group and channel will go blank and the Frequency will start flashing. Use UP/DOWN to scroll in 25 KHz steps to the desired frequency. Press SET and the frequency will be selected and stop flashing. Press Set and UP at the same time to return to group and channel operation. Hint: holding in the Up or Down key will increase the speed of the scroll. Just release and press again for fine control.
5. **Advanced ClearScan:** This feature automates the process of finding a clear group of inter-modulation free channels and the clearest channels within those groups.

- a. **ClearScan for Groups:** From the main display screen, push SET once and the Group Number will flash. While Group is flashing, press and hold SET until ClearScan appears, release the set key. When the scan is completed, the display will show the group with the most clear channels and the Channel number will indicate how many clear channels are in that group. Use the UP/DOWN keys and to view other groups and press SET to select a group. The Group will be set and the Channel will start to flash. Select a channel manually or use ClearScan for Channels.
- b. **ClearScan for Channels:** To scan for the clearest channel in a group, press and hold set while the Channel is flashing until ClearScan appears, release the SET button. When the scan is complete, the display will show the clearest available channel. Use UP/DOWN to scroll through the other available channels rank from clearest to least clear (but still available for use, ClearScan will not display any channel that can't be used). Press SET to select the channel.
- c. **Auto ClearScan:** This function will find the clearest group and channel with the press of just one button. With nothing flashing, press and hold the SET button until ClearScan appears on the right side of the screen. When the scan is complete, the receiver will be set to the clearest channel in the clearest group.
- d. **ClearScan Band:** While in the Frequency Mode, this function will scan the entire band looking for the clearest frequency, regardless of groups and channels. In Frequency Mode, press Set once and the frequency will flash, press and hold set until ClearScan appears on the right side of the display. The scan will continue until you press Set again so you can scan a location overnight, 24 hrs, a week, or a few seconds. When you press Set again, the scan will stop and the clearest frequency will be displayed. You can scroll through the 8 clearest frequencies using the Up and Down buttons. Press Set to accept the frequency displayed.

NOTE: Groups 9 and above are set up to work with the other US frequency band (A and B). If you are using a mix of Band A and Band B, scroll down to these groups and use the clearest group.

6. **Change Lock-Out:** By pressing and holding the UP and DOWN arrow keys together for 3 seconds, the SET key is disabled. To reactivate the SET key, simply press and hold the UP and DOWN keys again for 3 seconds. This feature can be useful when the receiver is in a location where unauthorized personnel have access to the receiver.
7. For set up, make sure the mixer or amplifier input used for the FMR-500 is muted or turned down to a minimum level.
8. Plug an audio cable (not supplied) into the 3 pin XLR or 1/4 inch output of the FMR-500.
 - a. **NOTE:** The XLR connector is the preferred connection since the output is balanced and will be more immune to noise for longer runs of cable although either can be used with good results. If the 1/4 inch connector is used, adjust the output level on the back panel to 12 o'clock (midway in the range) to start and adjust later if necessary.

Now refer ahead to transmitter setup and return to step 9 when that is completed.

9. With the transmitter on, speak into the microphone or play the guitar. Turn up the level on the mixer or amplifier until you are able to hear the desired signal. If no audio is present, repeat setup and refer to the troubleshooting section.

NOTE: If the 1/4 inch output is used, it may be necessary to adjust the receiver output until the volume level from the wireless system approximates the level of an equivalent wired microphone/instrument.

10. **Squelch Adjustment** - The squelch setting can be used to maximize range or immunity to noise. Press and hold Up for 3 seconds. The current squelch setting will be displayed. Adjust the squelch using the UP/DOWN keys. Maximum squelch (9) maximizes noise immunity but limits the range. Minimum squelch (1) will maximize the range but allow more noise to break through the squelch. Press SET to save the new squelch setting.

Receiver Push-Button Reference Sheet

Display	Status Button	Function Activated	Edit	Accept
Nothing Flashing	Press and hold SET	Auto ClearScan	n/a	n/a
Nothing Flashing	SET	Edit Group -Group will flash	▲▼	SET
Group Flashing	Press and hold SET	ClearScan Group - list clear groups in order	▲▼	SET
Group Flashing	SET	Edit Channel - Channel will flash	▲▼	SET
Channel Flashing	Press and hold SET	ClearScan Channel - list clear channels in order	▲▼	SET
Nothing Flashing	Press and hold Up	Edit Squelch Setting	▲▼	SET
Nothing Flashing	Press and hold Up & Down	Edit Lock - Secure will appear	n/a	n/a
Edit Lock On	Press and hold Up & Down	Return to Access Mode	n/a	n/a
Power Off	Press and hold SET	Toggle between Guitar and Voice mode	n/a	n/a
Nothing Flashing	Press SET and Up	Toggle to Frequency Mode - Freq will flash	▲▼	SET
Frequency Flashing	Press and hold SET	ClearScan Band - Clear Scan will flash	n/a	SET
ClearScan Band Running	Press SET	End ClearScan Band after next full scan	n/a	n/a
ClearScan Band Results	n/a	Clearest frequencies listed	▲▼	SET
Frequency Mode	Press SET and Up	Return to Group and Channel Mode	n/a	n/a
Nothing Flashing	Press and hold Down	Display Software Revision	n/a	n/a

Rack Mount Installation

The FMR-500 is supplied with rack mounts for single and double mounting in a standard EIA 19"/483mm equipment rack (see Figure 3). For rack mounting a single unit, a long (#3) and short (#1) "ear" are used. For dual side-by-side mounting, use the short (#1) "ears" and the mid brackets (#2) from two FMR-500's as shown.

To assemble the rack mount adapters to the FMR-500 proceed as follows:

1. Remove the front Phillips head screws from each side of each unit.
2. Align the correct rack ear or bracket with the holes on the side of the unit. Install the previously removed screws. Insert an additional screw (#2, provided in the parts pack) into the remaining hole. Repeat this step for the opposite side of the unit. Be sure to tighten all screws securely.

Four double mounting of two FMR-500's proceed as follows:

1. Align the mid brackets (#2) with the holes on the adjacent sides of each unit.
2. Install the previously removed screws. Insert an additional screw (#4, provided in the parts pack) into the remaining holes. Tighten all screws securely.
3. Place the two assemblies side-by-side with the mid brackets together. (The left bracket should fit above the right so that the countersinks are visible). Install 4 flat head screws (#5, provided in the parts pack) and tighten them securely.

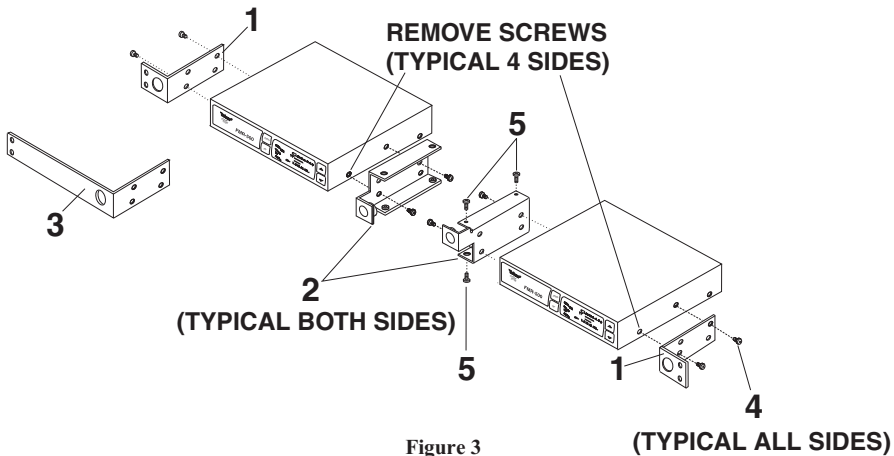

Figure 3
Rack Mount Installation

Front Mounting Antennas

1. Remove hole plugs from brackets.
2. Attach the antenna connectors to the brackets.
3. Attach the supplied extension cables from the rack connectors to the antenna connections on the back of the receiver. See Figure 4.

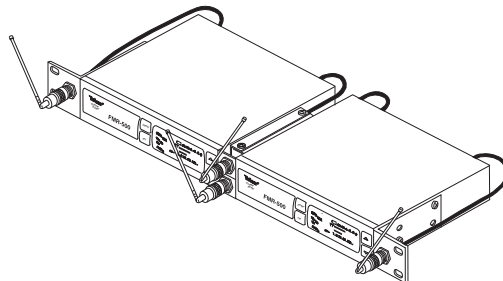

Figure 4
Front Mounting Antennas

Handheld Transmitter HT-500

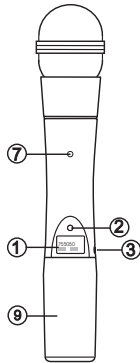

Figure 5
Handheld Transmitter

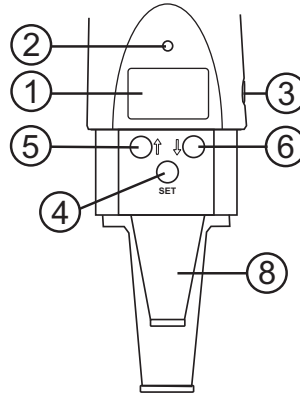

Figure 6
Transmitter

HT-500 Controls, Connectors, and Indicators

1. Main Display - LCD
(Channel, Frequency or Battery Level Indication)
2. Battery Low LED - Lights when battery is low
3. Power On/Off Switch
4. Set Switch
5. Channel/Frequency Up Switch
6. Channel/Frequency Down Switch
7. Microphone Gain
8. 9V Battery Holder
9. Battery Cover - Screw type

Handheld Transmitter Setup and Operation

1. **Insert Battery.** Remove the battery compartment cover by unscrewing it completely. Insert a 9V battery, terminal end first into the battery compartment.
NOTE: The HT-500 unique design allows the battery to be inserted and used regardless of the positive and negative terminal position.
2. **With battery compartment still open,** turn the unit so you can see the display and the control panel. Turn the unit on by sliding the power switch forward to the on position. The battery low LED will light for a second and the display will show the Group and Channel numbers.
3. **Change the group and channel numbers** to match those displayed on the receiver by pressing SET. The Group number will flash and can be changed with the UP/DOWN keys. Once the desired group number is showing, press SET to select and the Channel number will flash. Select the Channel and press SET again. The flashing will stop and the channel is now set.
4. **Other Screens:** Press SET and DOWN at the same time to display the battery level. Press SET and DOWN again to display frequency. Press them one more time to return to Group and Channel.
5. **Frequency Edit Mode** - Press SET from the frequency display screen to enter frequency edit mode. Press the Up and Down to adjust frequency in 25 kHz increments. Holding the Up or Down buttons down will auto step the frequency; slowly at first, then quickly. You can also enter frequency edit mode by pressing SET and UP at the same time from either the Group and Channel or Battery status display screens. Pressing SET and UP at the same time from the Frequency display screen will enter Group and Channel edit mode.
6. **Power Lock Out** - Press SET, UP, and DOWN at the same time and hold 3 seconds to lock the power switch on. To turn the unit off, place the power switch in the OFF position and push SET, UP, or DOWN. To remove the lock, press SET, UP, and DOWN again at the same time and hold 3 seconds. A one-time only ON-LOCK mode can also be entered by quickly cycling the power switch three times.
7. **Set Key Lock-Out,** by pressing and holding the UP and DOWN arrow keys together for 3 seconds, the SET key is disabled. To reactivate the SET key simply press and hold the UP and DOWN keys again for 3 seconds.

8. **Verify reception.** With the transmitter and receiver on and matching Group and Channel, the main receiver display should be indicating a RF signal on the bar graph. Speak into the microphone and the Audio Meter bar graph should indicate audio signal presence. If the level meters do not show reception, make sure the channels are matching and refer to the trouble shooting section.
9. **Adjustment of the transmitter audio gain - If necessary** The transmitter audio gain is factory set at the middle of the range, which should be suitable for most applications. For loud or soft speakers/singers, a gain adjustment may be necessary. Have the speaker or singer use the microphone in a normal performance level voice. The Audio Meter in the main receiver display screen should show peaks around the -3dB level. If the meter peaks all the way to the right or well below the -3dB level, adjust the transmitter audio gain.

To adjust the transmitter gain, gently insert the provided screwdriver (or other 3/32 - 2.5 mm screwdriver) into the adjustment hole above the display screen. Turn lightly until the screwdriver tip goes into the adjustment level control. Gently turn counterclockwise until the control stops (the microphone output is at minimum but not off). Slowly turn the gain control up (clockwise) while speaking/singing into the microphone and audiometer shows peaks around -3 dB.

NOTE: Operating with the transmitter audio gain set as high as possible (without distortion or peaks all the way to the right end of the meter) will result in the best performance and highest signal to noise ratio.

10. **Test Performance.** Go back to Section 3. Receiver Setup and Operation - Step 9 to complete system set up and test.

Bodypack Transmitter - WT-500

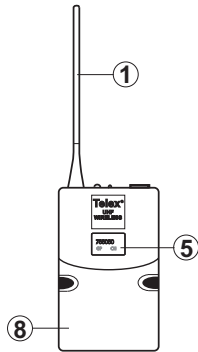

Figure 7
Bodypack Transmitter

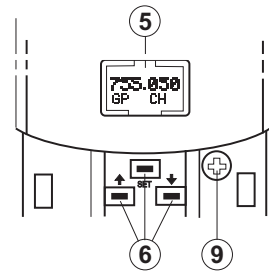

Figure 8
Control View

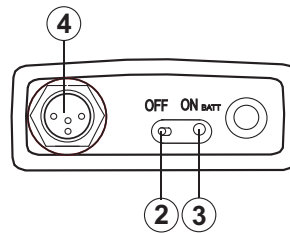

Figure 9
Top View

WT-500 Controls, Connectors, and Indicators

1. Antenna - flexible 1/4 wave antenna
2. Power On/Off Switch
3. Battery Low LED Indicator
4. TA4 Audio Connector
5. LCD Display (Channel, Frequency or Battery Level Indication)
6. Display Control Buttons (Set/Up/Down)
7. Belt Clip (Removable, not shown)
8. 9V Battery Compartment
9. Audio Gain Adjustment

Bodypack Transmitter Setup and Operation

1. **Insert Battery.** Pinch the battery door tabs inward and pull the door open. Insert a 9V battery as indicated by the +/- in the holder.
2. With battery compartment still open, turn the unit on with Power switch on the top panel. The battery low LED will light for a second and the display will show the Group and Channel numbers.
3. **Change the group and channel numbers** to match those displayed on the receiver by pressing SET. The Group number will flash and can be changed with the UP/DOWN keys. Once the desired Group number is showing, press SET to select and the Channel number will flash. Select the Channel and press SET again, the flashing will stop and the channel is now set.
4. **Set Key Lock-Out.** By pressing and holding the UP and DOWN arrow keys together for 3 seconds, the SET key is disabled. To reactivate the SET key, simply press and hold the UP and DOWN keys again for 3 seconds.
5. **Verify reception.** With the transmitter and receiver on and matching Group and Channel, the main receiver display should be indicating a RF signal on the bar graph. If the level meter does not show reception, make sure the channels are matching and refer to the trouble shooting section.
6. **Attach the Microphone or Guitar.**

Microphone: Plug the microphone cable into the top panel of the WT-500. Speak into the microphone and the Audio Meter bar graph should indicate audio signal presence.

Guitar: Turn off the bodypack, press and hold SET while you turn the bodypack on. A guitar symbol will appear in the display to indicate instrument mode. Repeat the process holding SET on the receiver as it is powered up. Plug in the MAC-G3 guitar cable. Strum the guitar and the Audio Meter bar graph on the receiver should indicate audio signal presence.

7. **Adjustment of the Transmitter Audio Gain - (if necessary).** The transmitter audio gain is factory set at the middle of the range, which should be suitable for most applications. For loud or soft speakers/singers, a gain adjustment may be necessary.

Have the speaker or singer use the microphone in a normal performance level voice. The Audio Meter in the main receiver display screen should show peaks around the -3 dB level. If the meter peaks all the way to the right or well below the -3 dB level, adjust the transmitter audio gain.

To adjust the transmitter gain, gently insert the provided screwdriver (or other screwdriver) into the adjustment potentiometer. Gently turn counterclockwise until the control stops (the microphone output is at minimum but not off). Slowly turn the gain control up (clockwise) while speaking/singing into the microphone or strumming the guitar and the audiometer shows peaks around -3 dB.

NOTE: Operating with the transmitter audio gain set as high as possible (without distortion or peaks all the way to the right end of the meter) will result in the best performance and highest signal to noise ratio.

Other Screens: Press SET and DOWN at the same time to display the battery level. Press SET and DOWN again to display frequency. Press them one more time to return to Group and Channel.

8. **Frequency Edit Mode** - Press SET from the frequency display screen to enter frequency edit mode. Press the Up and Down to adjust frequency in 25 kHz increments. Holding the Up or Down buttons down will auto step the frequency; slowly at first, then quickly. You can also enter frequency edit mode by pressing SET and UP at the same time from either the Group and Channel or Battery status display screens. Pressing SET and UP at the same time from the Frequency display screen will enter Group and Channel edit mode.
9. **Power Lock Out** - Press and hold SET, UP, and DOWN at the same time and hold for 3 seconds to lock the power switch on. To turn the unit off, place the power switch in the OFF position and push SET, UP, or DOWN. To remove the lock, press SET, UP, and DOWN again at the same time and hold for 3 seconds. A one-time only ON-Lock mode can also be entered by quickly cycling the power switch three times.
10. **Test Performance** - Go back to Section 3 - Receiver Setup & Operation, Step 9 to complete system set up and test.

APPROVAL INFORMATION

The Electro-Voice/Telex Transmitters are Type Accepted under United States Federal Communications Commission CFR 47, Part 74 and Industry Canada RSS123.

The Electro-Voice/Telex Receiver is approved under United States Federal Communications Commission CFR 47, Part 15 and Industry Canada RSS210.

Licensing of Electro-Voice/Telex equipment is the users responsibility and Licensability depends upon the users classification, users application and frequency selected. Electro-Voice/Telex strongly urges the user to contact the appropriate telecommunications authority for any desired clarification.

CAUTION: Any changes or modifications made to the above equipment could void the users authority to operate the equipment.

Section 4 - Receiver Display Screens and Functions

Main Operating Screen

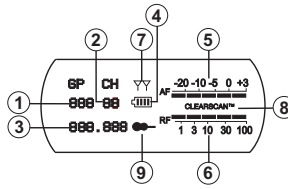

Figure 10
Main Operating Screen

Display:

1. Group Number 10 (factory set)
2. Channel Number 01 to 10
3. Frequency Displayed in MegaHertz
4. Battery Status 100 to 0 Pct in 25 Pct steps/Flash if low
5. Audio VU Meter -30 VU to + 3 VU
6. RF Signal Strength 1 μ V to 100 μ V
7. Antenna Diversity Status left or right antenna
8. ClearScan Indicates Scan is in progress
9. Guitar Symbol Indicates Instrument Mode

Controls:

1. Press and hold SET for 3 seconds starts Auto-ClearScan™
2. Press SET once, Group starts flashing, adjust with UP and DOWN
- 2.a With Group flashing, press and hold SET for 3 seconds to start Group Scan
3. Press SET twice, Channel starts flashing, adjust with UP and DOWN
- 3.a With Channel flashing, press and hold SET for 3 seconds to start Channel Scan
4. Press SET and UP at the same time to enter Frequency Mode
5. Press and hold UP for 3 seconds to adjust Squelch
6. Press and hold SET during power up to enter Instrument Mode
7. [UP] + [DOWN] for 3 seconds Sets/Resets Edit Lockout

Squelch Adjustment Screen

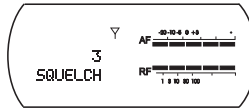

Figure 11

Display:

1. Squelch Level 1-10

Squelch Adjustment Screen

Controls:

1. [UP] + [DOWN] adjust the squelch level
2. SET saves the squelch level shown and returns you to the main screen

Transmitter Display and Controls

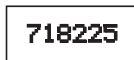
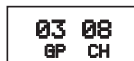

Figure 12
Transmitter Display and Controls

Display:

1. Group and Channel
2. Battery Level in Percentage
3. Frequency

Controls:

1. Press SET once, GP will flash, use UP and DOWN to adjust
2. Press SET again to accept GP, CH will flash, adjust with UP/DOWN
3. Press SET again to accept CH and channel will be installed
4. Press SET and DOWN at the same time to change display mode
5. Press SET and UP to enter Frequency Set Mode
6. Press SET and DOWN to return to the Group/Channel Mode
7. Press and hold UP and DOWN for 3 seconds to lock out SET
8. Press and hold UP and DOWN again to activate SET
9. Press and hold UP, DOWN, and SET to lock power (see Section 4)
10. Press and hold UP, DOWN, and SET to unlock power

Transmitter On/Off Lock-Out

There are two On/Off lockout modes available, One Time and Everytime.

One Time: Cycle the power switch 3 times in under 3 seconds and On-Loc will be displayed for a second and then return to normal operation. The power switch alone will no longer turn the unit off. To turn the unit off, put the power switch in the off position (On-Loc will be displayed) open the battery door and press [Set], [Up], or [Down] and the unit will power down. The next time the unit is powered on, the power switch will operate normally.

Everytime Use: With the unit on and operating in the normal mode, press and hold [Set], [Up], and [Down] for 3 seconds. On-Loc will be displayed and the power switch alone will no longer turn the unit off. To turn the unit off, put the power switch in the off position, (On-Loc will be displayed), open the battery door and press [Set], [Up], or [Down] and the unit will power down. The next time the unit is powered on, the On-loc function will still be on. To enable the power switch, press and hold [Set], [Up], and [Down] for 3 seconds (On-Off will be displayed).

Guidelines and Recommendations for Best Performance

Compatibility

The transmitter and receiver must be of the same frequency band and set to the same group and channel in order to work together. The FMR-500 is available in two frequency bands, A and B. The band information is available in the Group/Channel edit screen on the receiver, the bottom label on the handheld transmitter, and on the back panel label on the bodypack.

Using Multiple Wireless Systems

If two or more FMR-500 systems and/or other UHF/VHF wireless systems are being used in the same location, proper frequency coordination is necessary to avoid interference. All channels in the FMR-500 factory set groups are designed to work together, so if channels from just one group are used no further coordination is required. Contact your dealer or Telex for assistance if you are planning more systems or using the FMR-500 with other wireless equipment.

IMPORTANT NOTE: Always use the smallest preset group that meets your needs. For instance, if you want to set up 6 units, use one of the groups of 8 frequencies. The smaller the preset group, the more compatible the frequencies are.

Multiple Systems and Advanced ClearScan

Because all of the channels in the factory set groups are compatible, Advanced ClearScan can be used to set up multiple systems quickly and with confidence. When setting up more than one system, set up the first system using the Auto-ClearScan™ function.

Once the working Group has been established, leave the first transmitter on, set the next receiver Group to the working Group and run ClearScan for Channels. This will provide the next clearest channel in that group. Set the transmitter to match, leave it on and repeat until all the systems are set up. If you run out of clear channels in one group but need to set up more systems, contact your dealer or Telex for assistance in choosing additional frequencies.

Potential Sources of Interference

There are many potential sources of interference for your wireless system. Any electronic product that contains digital circuitry including digital signal processors (reverb/multi-effects units), electronic keyboards, digital lighting controllers, CD and DVD players, and computers, all emit RF energy that can adversely affect the performance of your wireless system. It is always best to place the receiver as far away as possible from these devices to minimize potential problems.

Analog and Digital Television stations can also interfere with your wireless system. The FMR-500 is designed to operate over 28 MHz of RF bandwidth, which covers six TV channels. The factory presets on the FMR-500 are optimized for conditions where one, two, or possibly three of the six stations are covered in your area. If four or more of the six stations are used in your area, it will severely limit the number of systems that will operate together and you should be using a different band.

Battery Recommendations

Fresh 9-volt alkaline batteries form a quality manufacturer will yield the best performance from your transmitters. Rechargeable 8.4-volt Ni-Cad batteries can be used but will result in much shorter operation time.

When the transmitters are turned on, the red battery LED will flash once if the battery is good. If the light does not light or stays lit continuously, the battery is weak or dead. If the light comes on during use, the battery is weakening and should be replaced as soon as possible. If sound quality degrades during use, it may be the result of a weakening battery.

Caution: The battery level indicators, on the transmitters and receiver displays, are based on the use of alkaline batteries. Use of other battery types will result in false readings on these indicators although the battery low LED on the transmitters will operate normally.

Receiver and Antenna Placement

Do not place the receiver near a large metal object or surface. Locate the receiver as close as possible to the area where the transmitter will be used. Ideally, position the receiver/antennas within sight of the transmitter. When using multiple systems, do not allow antennas to cross or touch each other. For best results with multiple receivers, use a UAD-2 antenna splitter. (See Section 7).

Section 5 - Trouble Shooting Guide

Problem	Possible Causes	Solutions
No audio and no display on the receiver	Receiver is off	Make sure that the power supply is properly connected and the on/off button is in the on position
No audio and no RF signal indicator on the receiver display	Transmitter is off	Turn on transmitter power switch
	Transmitter is on a different channel	Match the transmitter group and channel to the one displayed on the receiver
	No (or dead) battery in transmitter	Insert fresh battery in transmitter
	Faulty battery contacts	Clean and or bend contact
No Audio with good RF signal indicator but no (or low) Audio indicator on the receiver display	Microphone not connected	Check the TA4F connector on the bodypack or the detachable microphone element connection on the handheld
	Low gain setting on the transmitter	Increase the transmitter gain
No (or low) Audio with good RF signal and Audio indicators on receiver display	Receiver audio output cable is damaged or disconnected	Connect, repair or replace cable
	Gain not sufficient on mixer/preamp/amp input or it is muted	Increase gain on mixer or un-mute the input
	Receiver output too low (1/4" output)	Increase the audio output setting
Distorted audio signal	Transmitter audio gain too high	Decrease the transmitter gain setting
	Receiver output too high (1/4" output)	Decrease the receiver output setting
	Battery level low in transmitter	Insert fresh battery in transmitter
Interference	Another FMR-500 system in the installation is on the same channel or the signals are mixing	Make sure all the channels in use are from the same group. Use ClearScan to select the clearest group. If more channels are needed call Telex at 800-392-3497 for coordination help
	Another wireless product in the area is on the same frequency or the signals are mixing	Use ClearScan to change the operating frequency. If problems persist, call Telex at 800-392-3497 for coordination help

Trouble Shooting Guide (continued)

Problem	Possible Causes	Solutions
Interference (continued)	Receiver is too close to digital signal processor or similar device	Move the receiver to a different location
	Strong electromagnetic field from stage lighting or other source near the transmitter or receiver, which may be producing RF noise at or near the operating frequency	Use ClearScan to change the operating frequency. Repair or remove the source of interference. Move the receiver to a different location
Short range or drop-outs	RF reflective metal obstacles between the transmitter and receiver	Move the obstacles, or reposition the receiver/antennas
	Poorly oriented beltpack antenna	Check the antenna connection and re-orient the bodypack so the antenna is vertical (up and down) and facing the receiver, if possible
	Faulty receiving antenna system	Check all antenna connections and reposition to be in line-of-sight with the transmitter
Can't change settings on receiver or transmitter	Lock-out feature is enabled	Disable lock out (see pages 3 and 9)
Bodypack or Handheld transmitter will not turn off, display says On-Loc	On/Off lock-out is engaged	Put the on/off switch in the off position and press one of the programming buttons (see page 9)

Section 6 - Technical Specifications

FMR-500 Receiver

Specifications

Overall

Receiver Type	Synthesized PLL
Frequency Range (RF)	A Band 648 - 676 MHz (TV Channels 43 - 48) B Band 696 - 724 MHz (TV Channels 54 - 56)
Number of Channels	>1122 possible frequencies Programmable in 25 kHz steps
Modulation	+/- 40 kHz
Diversity	Digital Posi -Phase™ True Diversity
RF Sensitivity	<1.0 μ V for 12 dB SINAD
Image Rejection	>60 dB
Squelch	Tone Code plus Amplitude
Ultimate Quieting	>100 dB
FCC Certification	Approved under Part 15
Power Requirements	12-15V AC/DC, 300mA
Operating Temperature	-7° to 49° C (20° to 120° F)
Receiver Dimensions	1.72 in. H x 7.50 in. W x 5.9 in. D 43.69 mm H x 190.50 mm W x 150 mm D

Audio Parameters

Frequency Response	50 - 15 kHz +/- 2dB
Balanced Output (typical)	(max @ 40 kHz deviation) 330mV RMS 100K OHM Load, Mic Position 10mV to 2V RMS 100K OHM Load, Line Position
Unbalanced Output	adjustable 10 mV to 1V RMS, 100K OHM Load
Distortion	<1.0%, 0.5% typical (ref 1kHz, 40kHz deviation)
Signal-to-Noise Ratio	>100 dB A Weighted
Dynamic Range	>100 dB

Transmitters WT-500 and HT-500

Radiated Output	30 mW Typical
Microphone Head ElectroVoice 767a	N/D 767a supercardioid N/DYM dynamic
Microphone Head ElectroVoice RE410	RE410 cardioid condenser
Standard Lavalier Microphone	ELM-22 Omni-Dierctional Condenser
TA4F Connector Wiring	Pin 1: Ground; Pin 2 Mic Input; Pin 3: +5V bias; Pin 4: +5V bias through a 3k resistor
Audio Gain Adjustment Range	40 dB WT-500 26 dB HT-500
Power Requirements	9 Volt Alkaline Battery
Battery Life (Typical)	>8 hours with 9-Volt Alkaline Typical
Bodypack Antenna	Flexible external 1/4 wave
Handheld Antenna	Internal 1/2 wave
Dimensions (Handheld)	24.0 cm (9.4 in.) Long
Dimensions (bodypack)	3.8 in. H x 2.38 in. W x 0.92 in. D 96.5 mm H x 60.5 mm W x 23.4 mm D

Section 7 - Accessories and Parts

	MODEL No.	Order No.
Omnidirectional Lapel Microphone	WLM-50	64277000
Unidirectional Lapel Microphone	UML21	ULM21
Premium Omnidirectional Lapel Microphone	ELM-22	70925006
Premium Lapel/Instrument Unidirectional Microphone	ELM-33	70926001
Presenter's Headworn Microphone	HM2	HM2
Singer's Headworn Microphone	HM7	HM7
Hard Shell, Foam lined Road Case	RC-RE2	7185800
Foam Windscreen for Handheld	379-1	3792031
Handheld Transmitter Color Kit	HHCK	7185700
Bodypack Pouch	WP-1000	879553
Guitar Cord	MAC-G3	879706
Single Receiver Rack Mount Kit	RMS	71081001
Single Rack Mount Kit with front mount antenna cables	RMS-TNC	71081004
Double Rack Mount Kit	RM-D	71081002
Front Mount Antenna Cables (4)	FMC-K	878978
1/4 Wave Rx Antenna 600-746 MHz (A/B Bands)	ANU-14	879010
1/2 Wave Rx Antenna (680-870 MHz)	FA-500	860031
1/2 Wave Antenna Mounting Bracket with 10' of Coax	AB-2	71138000
Antenna/Pwr Distribution (600-780 MHz) (A/B Bands)	UAD-2	71253000
Termination Plug for UAD-2	TP-2	650095
Directional Rx Antenna (450-900 MHz) (A/B Bands)	ALP-450	71147000
Low Loss Coaxial Antenna Cable (25, 50, 75, 100 ft. with TNC Connectors)	CXU-25 CXU-50 CXU-75 CXU-100	71151025 71151050 71151075 71151100

Section 8 - Factory Service/Warranty (Limited)

FACTORY SERVICE (North America)

If factory service is required, ship the unit prepaid in its original carton to:

TELEX COMMUNICATIONS, INC.
Audio Service
8601 East Cornhusker Highway,
Lincoln, Nebraska 68507-9702 U.S.A.
Phone: (402) 467-5321 or 800-553-5992
Fax: 402-467-3279

Enclose a note describing the problem along with any other pertinent information and how to contact you.

Warranty (Limited)

Telex products are guaranteed against malfunction due to defects in materials or workmanship for a specific period, as noted in the individual product-line statement(s) below, or in the individual product data sheet or owner's manual, beginning with the date of original purchase. If such malfunction occurs during the specified period, the product will be repaired or replaced (at our option) without charge. The product will be returned to the customer prepaid via UPS Ground.

Exclusions and Limitations: The Limited Warranty does not apply to: (a) exterior finish or appearance; (b) certain specific described in the individual product-line statement(s) below, or in the individual product data sheet or owner's manual; (c) malfunction resulting from use or operation of the product other than as specified in the product data sheet or owner's manual; (d) malfunction resulting from misuse or abuse of the product; or (e) malfunction occurring at any time after repairs have been made to the product by anyone other than Telex or any of its authorized service representatives.

Obtaining Warranty Service: To obtain warranty service, the customer must deliver the product, prepaid, to Telex or any of its authorized service representatives together with proof of purchase of the product in the form of a bill of sale or receipted invoice. A list of authorized service representatives is available from Telex.

Incidental and Consequential Damages Excluded: Product repair or replacement and return to the customer are the only remedies provided to the customer. Telex shall not be liable for any incidental or consequential damages including, without limitation, injury to persons or property or loss of use.

Incidental and Consequential Damages Excluded: Product repair or replacement and return to the customer are the only remedies provided to the customer. Telex shall not be liable for any incidental or consequential damages including, without limitation, injury to persons or property or loss of use.

Other Rights (United States Only): This warranty gives you specific legal rights and you may also have other rights, which vary from state to state.

Telex Wireless systems are guaranteed against malfunction due to defects in materials or workmanship for a period of three (3) years from the date of original purchase. The Limited Warranty does not extend to cables or cable connectors. Additional details are included in the Uniform Limited Warranty Statement. Technical Assistance; 800-392-2497 (U.S. and Canada only)

TELEX®

TELEX COMMUNICATIONS, INC. 12000 Portland Ave. South, Burnsville, MN 55337

PN 803666 Rev B

Sept 2003

Made in U.S.A.

Free Manuals Download Website

<http://myh66.com>

<http://usermanuals.us>

<http://www.somanuals.com>

<http://www.4manuals.cc>

<http://www.manual-lib.com>

<http://www.404manual.com>

<http://www.luxmanual.com>

<http://aubethermostatmanual.com>

Golf course search by state

<http://golfingnear.com>

Email search by domain

<http://emailbydomain.com>

Auto manuals search

<http://auto.somanuals.com>

TV manuals search

<http://tv.somanuals.com>