

Parts List and Wiring Diagrams

Model PH-88 Headset



The PH-88 headset is a super lightweight, single sided headset for the ultimate in day-long comfort. The PH-88 features a high quality monaural dynamic earphone with dynamic noise cancelling microphone on an adjustable boom that can be bent to practically any mouth-to-mic position. The unit has a straight cord and is available in various connector configurations.

Specifications

Receiver Type Dynamic
 Receiver Impedance 300 ohms
 Microphone Type Dynamic
 Microphone Impedance 200 ohms
 Weight 4.6 ozs
 Cord 6 ft. straight

Parts List

| ITEM NO. | DESCRIPTION | QTY | PART NO. |
|----------|--|-----|------------|
| 1 | Windscreen | 1 | 59747-001 |
| 2 | PT-Pan Head Screw, KA15 x 6(.236) LG., Black | 2 | 590404-360 |
| 3 | Glider Spring | 2 | 64305-000 |
| 4 | Housing Assy. | 1 | 64308-107 |
| 5 | Glider Assy. | 2 | 64310-000 |
| 6 | Cord Amp Assy. | 1 | 64311-053 |
| 7 | Boom Mic / Housing Assy. | 1 | 800499-000 |
| 8 | Headband Assy. | 1 | 64352-026 |
| 9 | Temple Plate | 1 | 70531-002 |
| 10 | Foam Pad | 1 | 70533-000 |
| 11 | Ear Cushion | 1 | 590626-000 |
| 12 | Connector, PH-88 & PH-88E, XLR-4F | 1 | 35320-004 |
| | Connector, PH-88R, XLR-4M | 1 | 35398-004 |
| | Connector, PH-88R5, XLR-5M | 1 | 35398-005 |

Exploded View

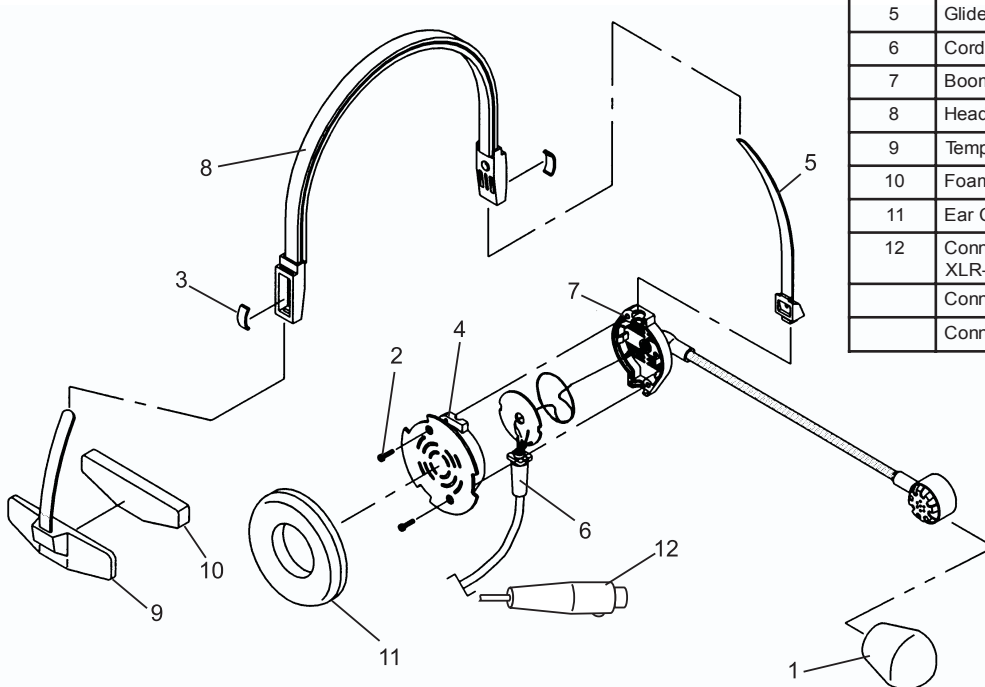

Wiring Diagram

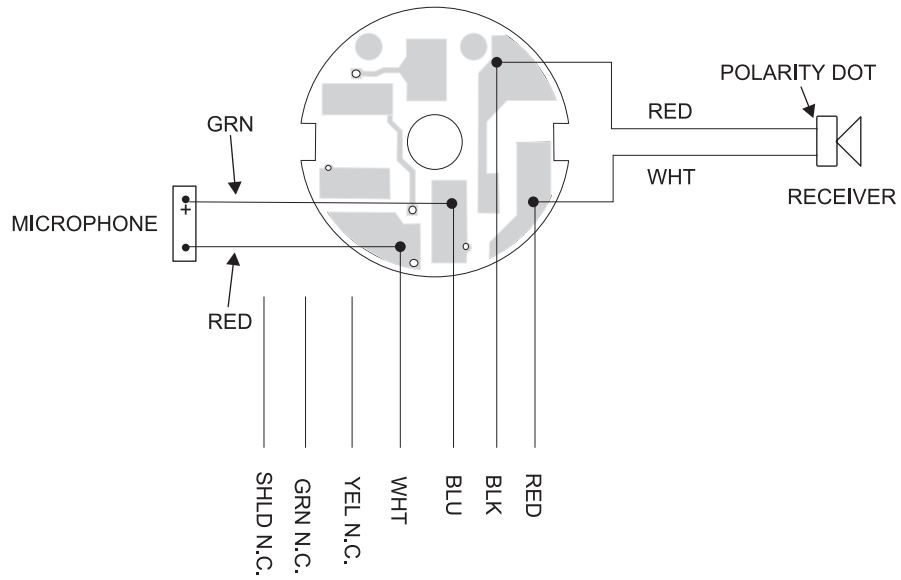

Connector Wiring

PH-88 / PH-88E

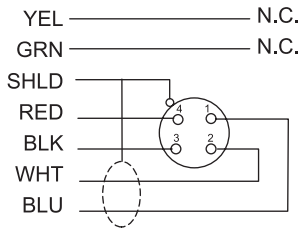
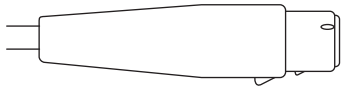

300852-100, -103

PH-88R

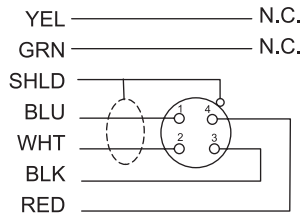
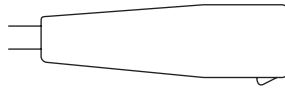

300852-101

PH-88R5

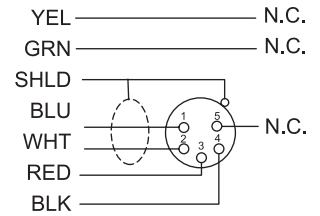
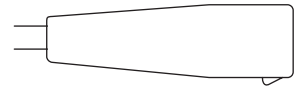

300852-102

TELEX[®]

Free Manuals Download Website

<http://myh66.com>

<http://usermanuals.us>

<http://www.somanuals.com>

<http://www.4manuals.cc>

<http://www.manual-lib.com>

<http://www.404manual.com>

<http://www.luxmanual.com>

<http://aubethermostatmanual.com>

Golf course search by state

<http://golfingnear.com>

Email search by domain

<http://emailbydomain.com>

Auto manuals search

<http://auto.somanuals.com>

TV manuals search

<http://tv.somanuals.com>