

User's Manual

CAMILEO H20

DE	IT
DK	NL
ES	NO
FI	PT
FR	SE

TOSHIBA
Leading Innovation >>>

Introduction

Welcome and thank you for choosing a TOSHIBA product.

For your convenience, your TOSHIBA product is furnished with two guides:

- a) a Quick Start Guide, and
- b) a comprehensive PDF User's Manual on the included CD.

Contents

Section 1 Getting to Know Your Camcorder	3
Overview	3
Check the Components	3
Safety Instructions	4
System Requirements	4
Front View	5
Rear View	5
Side View	6
Bottom View	6
Section 2 Getting Started	7
Loading the Battery	7
Inserting and Removing an SD Card (Optional)	7
Turning the Camcorder On and Getting Started	8
Turning the Camcorder Off	8
Section 3 Record Mode	9
Button Function	9
LCD Monitor Information	10
Movie Recording	11
Picture Recording	12
Taking Close up Pictures	12
Using Zoom	12
Options for Record Menu	13
Operations for Record Mode	13
Movie Mode Submenu Setting	14
Picture Mode Submenu Setting	15
Effect Submenu Setting	17

Contents

Section 4 Playback Mode.....	20
Button Function.....	20
LCD Monitor Information	21
Operations for Playback Mode.....	22
Movie Playback.....	22
Movie Playback Mode Menu	23
Picture Playback.....	25
Picture Playback Mode Menu	26
Section 5 Setting Your Camcorder	28
Setting Menu	28
Section 6 Viewing Pictures and Movies on a TV	32
Connecting to a high-definition TV	32
Connecting to a non-high-definition 16:9 or 4:3 TV	32
Section 7 Viewing Pictures and Movies on PC.....	33
Installing Bundled Software	33
Transferring Data to a Computer	33
Section 8 Burning the Recorded Clip into DVD.....	34
Section 9 Uploading Video Files to YouTube.....	36
Section 10 Specifications	40
Section 11 Troubleshooting.....	41
Section 12 Other Information	42
TOSHIBA Support.....	42
Operating Environment Conditions.....	42
Regulatory Information	42
Additional Information	44

Section 1

Getting to Know Your Camcorder

Overview

The Camcorder with 5 Mega Pixel sensor and 5X Optical Zoom Lens can take H.264 movies. By way of using H.264 technology, more videos can be taken within certain amount of memory. High quality images with up to 8 mega-pixels can also be delivered smoothly. With a color LCD monitor, users can compose images and examine them easily.

The Camcorder also features movie recording at HD resolution of 1080p. You can also connect it to an HDTV via HDMI cable, and easily playback recorded high-definition videos on the wide screen HDTV. Exposure and color balance can either be adjusted automatically or allowed to be changed manually. An 2x/4x zoom increases user control over the movies and pictures you take.

Built-in memory allows you to take pictures and movies without memory card. The memory card slot allows users to increase the storage capacity.



Note

Partial memory of the built-in memory is used for Firmware code.

Check the Components

Unpack the package and make sure all standard accessories listed are included:



Camcorder



USB Cable



AV Cable



HDMI Cable



AC-Adaptor



**Lithium-ion
Rechargeable
Battery**



Quick Start Guide



**CD-ROM
(Software
User's Manual)**



Cloth Bag



Remote Control



Cleaning Cloth



Warranty Leaflet

Safety Instructions

1. Do not drop, puncture or disassemble the camcorder; otherwise the warranty will be voided.
2. Avoid all contact with water, and dry hands before using.
3. Do not expose the camcorder to high temperature or leave it in direct sunlight. Doing so may damage the camcorder.
4. Use the camcorder with care. Avoid pressing hard on the camcorder body.
5. For your own safety, avoid using the camcorder when there is a storm or lightning.
6. Do not use batteries of different specifications. Doing so may lead to the potential for serious damage.
7. Remove the battery during long periods between usage, as a deteriorated battery may affect the functionality of the camcorder.
8. Remove the battery if it shows signs of leaking or distortion.
9. Use only the accessories supplied by the manufacturer.
10. Keep the camcorder out of the reach of infants.
11. Risk of explosion if battery is replaced by an incorrect type.
12. Dispose of used batteries according to the instructions.

System Requirements

- Microsoft Windows 2000/XP/Vista
- Intel Pentium III 800MHz or above
- 256 MB RAM
- CD-ROM Drive
- 700 MB free HDD space
- Available USB port
- 16-bit Color Display



Note

The LCD screen is manufactured using extremely high-precision technology. However, some tiny black and/or bright dots (white, red, blue or green) may appear on the LCD screen. These dots are a normal result of the manufacturing process, and do not affect the recording.

Front View

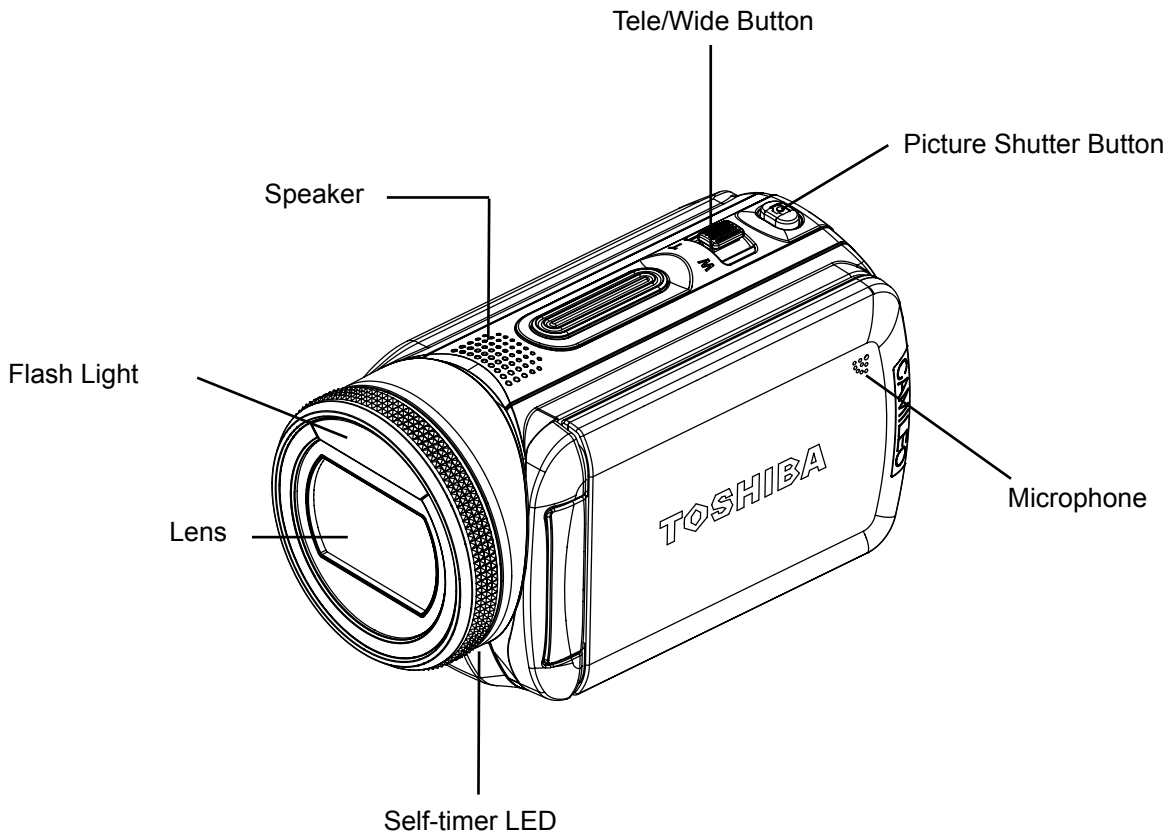

Rear View

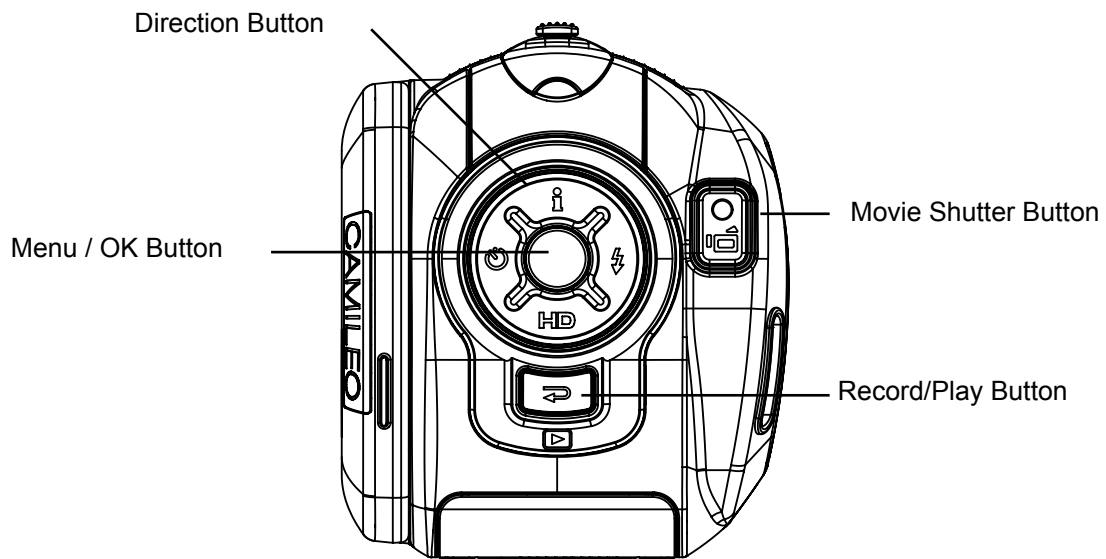

Side View

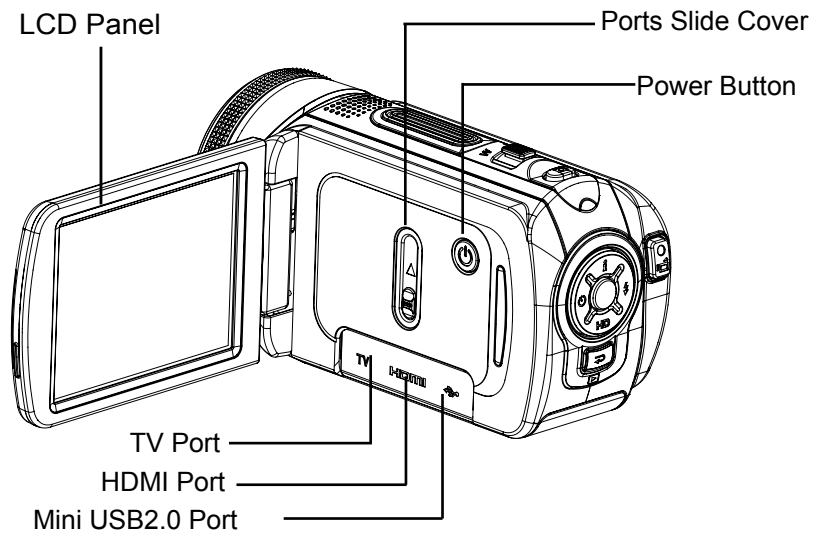

Bottom View

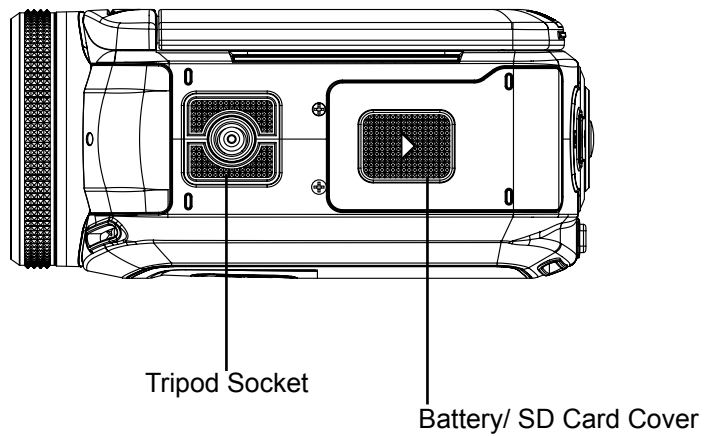

Section 2 Getting Started

Loading the Battery

Before using the camcorder, users must load Lithium-ion rechargeable battery

1. Insert the battery following to the correct polarity marks (+ or -).
2. Close the battery cover firmly.

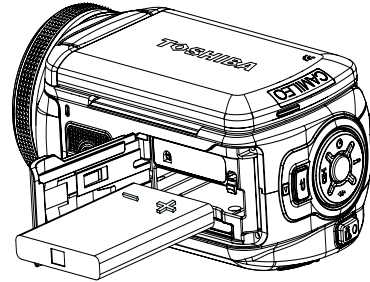

Inserting and Removing an SD Card (Optional)

The camcorder comes with internal memory which allows you to store pictures and movies. You can expand the memory capacity by using an optional SD memory card.

1. Insert the memory card into the right position. Please refer to the figure.
2. To remove an installed SD card, press the card inwards to release it.
3. When the card pops out, gently remove it from its slot.
4. Recommended memory capacity: 1GB or above

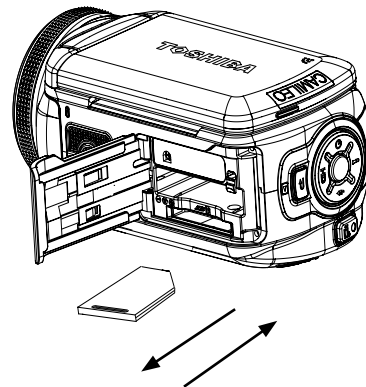

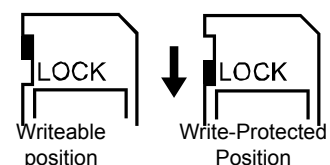

Note

- When a memory card is fitted, movies/pictures are saved on card rather than on the built-in memory.
- *Protecting Data on an SD Card: SD card is read-only by locking the SD card. No pictures and movies can be recorded when the SD card is locked. Make sure the lock is on writeable position before recording any media.*



Turning the Camcorder On and Getting Started

- To turn on the Camcorder: Flip out the LCD panel or press Power Button for one second. When the Camcorder is turned on, the green LED will light up.
- To take a movie, press the Movie Shutter Button ().
- To take a picture: Press the Picture Shutter Button () halfway down till the focusing frame turns from white to green. Then, press the Picture Shutter Button fully down to take picture.

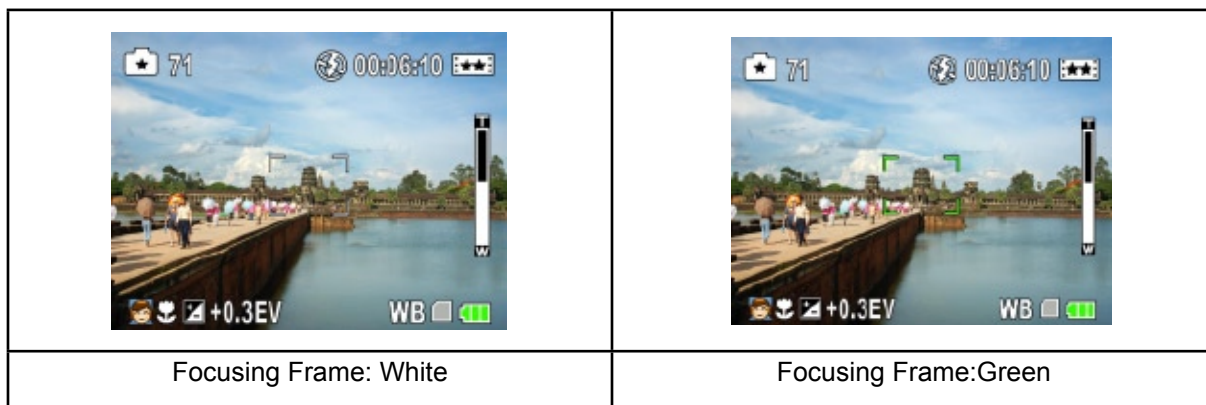





- To view stored movies, pictures, press Record/Play Button () once to switch to Playback Mode. Press a second time to return to Record Mode.

Turning the Camcorder Off

- To turn off the Camcorder, you can either press the Power Button for one second, or you can place the LCD panel back to its original position.

Section 3 Record Mode

Button Function











	<p>Direction Button</p> <p>Right Button: Flash Auto/Red-Eye-Reduction/OFF</p> <p>Left Button: Self timer ON/OFF</p> <p>Up Button: LCD Information ON/OFF</p> <p>Down Button: HD(1080p) / VGA mode switch</p> <p>Menu/OK Button: Menu On / Validate the setting</p> <p>Tele Button : Zoom In</p> <p>Wide Button : Zoom out</p>
	<p>Power Button: Press down for one second to turn on or turn off the Camcorder</p>
	<p>RECORD/PLAY Button functions:</p> <ol style="list-style-type: none"> 1. Switch between Record /Playback Mode 2. Return to the previous page 3. For quick review, press it after recording
	<p>Movie Shutter Button:</p> <ol style="list-style-type: none"> 1. Start to take movie. 2. To stop recording, press it again.
	<p>Picture Shutter Button: Start to take picture.</p>

LCD Monitor Information

The indicators shown below may display on LCD when movies and pictures are recorded:



(1)	Movie Resolution	
		HD (1080p) (30fps)
		HD (720p) (30fps)
		WVGA (60fps)
		VGA (30fps)
		QVGA (30fps)
	Picture Resolution	
		High
		Standard
	Low	
(2)	71	Number of images that can still be taken at current resolution
	14:26:08	Recording time of movie that can still be taken at current resolution
(3)		Auto Flash
		Red Eye Reduction
		Flash Off
(4)		Self-timer enabled



(5)	Scene	
		Skin
		Night
		Backlight
(6)		Macro Position Focusing
(7)		Exposure compensation value
(8)	WB	Manual White Balance
(9)		SD Card inserted
(10)		Battery: full power
		Battery: medium power
		Battery: low power
		Battery: power empty
(11)		Zoom meter: The Optical Zoom:1X~10X (5X Optical + 2X Digital) Other video resolution:1X~20X (5X Optical + 4X Digital)







Note

Scene: B/W / Classic / Negative effect can be previewed immediately without indicator on the LCD

Movie Recording

- Press Movie Shutter button () to start recording. When a movie is recording, a time indicator will display on LCD monitor. To stop recording, press Movie Shutter Button () again.
- Press RECORD/PLAY Button to view the recorded movie.
- Five resolution settings are available:

Video Quality	
	HD (1080p) (30fps)
	HD (720p) (30fps)
	WVGA (60fps)
	VGA (30fps)
	QVGA (30fps)

Picture Recording







- Press the Picture Shutter Button () halfway down till the focusing frame turns from white to green. Then, press the Picture Shutter Button fully down to take picture.
- Press RECORD/PLAY Button to view the picture.
- Three resolution settings are available:

Image Quality	
	High Quality: 8 Mega Pixels
	Standard Quality: 5 Mega Pixels
	Low Quality: 3 Mega Pixels

Taking Close up Pictures

The Camcorder has one close-up picture mode to allow you to take pictures at close range. The Macro Mode () should be used for objects located within 80 cm.

To take close-up pictures:

Operation	Display Screen
<ol style="list-style-type: none"> 1. In Effect Mode Submenu, press Up/Down Button to select Macro. 2. Use Right/Left Buttons to choose Macro or Normal. 3. Press Menu/OK Button to validate the setting. 	



Using Zoom

- The zoom magnifies images, when recording movies or taking pictures.
 - 1.To zoom in/out, press the Tele/Wide Button.
 - 2.The zoom can be set as 1X~10X (5X Optical + 2X Digital) / 1X~20X (5X Optical + 4X Digital).

Options for Record Menu

Movie Mode	Picture Mode	Effect
<ul style="list-style-type: none"> Resolution 	<ul style="list-style-type: none"> Resolution Flash Self-timer 	<ul style="list-style-type: none"> Macro Scene Exposure White Balance

Operations for Record Mode

Operation	Screen
1. Press Menu/OK Button when in Record Mode.	
<p>2. Use Right/Left Buttons to move between main Menu options, which are Movie Mode, Picture Mode, Effect, and Setting.</p> <p>3. Press Down Button to enter the folder of main option you select.</p> <p>4. Press Right/Left button to select the setting options, then press Menu/OK button to validate.</p> <p>5. Press RECORD/PLAY button to exit.</p>	

Movie Mode Submenu Setting

Operation	Display Screen
<ol style="list-style-type: none"> 1. In Record Mode, press Menu/OK Button to enter record Menu screen 2. Use Right/Left Buttons to select Movie Mode. 3. The Movie Mode Submenu contains 1 option. Resolution, for you to adjust the camera setting. 	 <p>The screenshot shows a camera's menu interface. At the top, there are icons for a movie camera, a still camera, a zoom, and a settings gear. Below these is a blue bar with 'Resolution' on the left and 'VGA' on the right. The background is a video feed of a boat on water. At the bottom, there are 'OK' and 'Exit' buttons.</p>

Movie Resolution

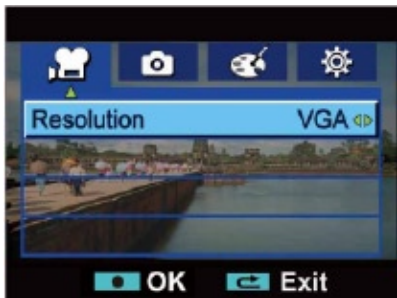
Operation	Display Screen
<ol style="list-style-type: none"> 1. In Movie Mode Submenu, press Down button to enter Resolution. 2. Use Right/Left Buttons to move between five settings. 3. Press Menu/OK Button to validate the setting. 	 <p>The screenshot shows the camera's menu interface with the 'Resolution' option highlighted in blue. The text 'Resolution' is on the left and 'VGA' is on the right. The background is a video feed of a boat on water. At the bottom, there are 'OK' and 'Exit' buttons.</p>

Picture Mode Submenu Setting

Operation	Display Screen
<ol style="list-style-type: none"> In Record Mode, press Menu/OK Button to enter record Menu screen. Use Right/Left Buttons to select Picture Mode. The Movie Mode Submenu contains 3 options, Resolution, Flash, and Self-timer, for you to adjust the camcorder setting. 	

Picture Resolution

Operation	Display Screen
<ol style="list-style-type: none"> In Picture Mode Submenu, press Down button to enter Resolution. Use Right/Left Buttons to move between three settings. Press Menu/OK Button to validate the setting. 	

Flash (Picture Record Mode Only)

This camcorder has three flash settings. To change flash setting by either hot key (Right Button) or Option Setting:

- **Auto** (⚡): The flash fires automatically according to light conditions. Use this mode for general photography.
- **Red Eye** (⚡👁): The pre-flash will fire to reduce the red-eye effect.
- **Off** (🚫): The flash will not fire under any circumstances. Use this mode when taking images in a place where flash photography is prohibited, or when the subject is distant (beyond the range of the flash).

Operation	Display Screen
<ol style="list-style-type: none"> 1. In Picture Mode Submenu, press UP/Down button to select Flash. 2. Use Right/Left Buttons to move between 3 settings. 3. Press Menu/OK Button to validate the setting. 	



Note

The flash will be disabled automatically when battery power is low (🔋).

Self-timer (Picture Record Mode Only)

The self-timer allows you to take pictures with a ten-second time delay. The self-timer LED on the front of the camcorder will also blink. The speed of blinking will increase just before the picture is taken.

Operation	Display Screen
<ol style="list-style-type: none"> 1. In Picture Mode Submenu, press Up/Down Button to select Self-timer. 2. Use Right/Left Buttons to choose On or Off. 3. Press Menu/OK Button to validate the setting. 	

Effect Submenu Setting

Operation	Display Screen
<ol style="list-style-type: none"> In Record Mode, press Menu/OK Button to enter record Menu screen. Use Right/Left Buttons to select Effect. The Effect Submenu contains 4 options, Macro, Scene, Exposure, and White Balance, for you to adjust the camcorder setting. 	

Macro

The Camcorder has one close-up picture mode to allow you to take pictures at close range. The Macro Mode () should be used for objects located within 80 cm.

Operation	Display Screen
<ol style="list-style-type: none"> In Effect Mode Submenu, press Up/Down Button to select Macro. Use Right/Left Buttons to choose Macro or Normal. Press Menu/OK Button to validate the setting. 	

Scene

You can select the mode according to the scene condition.

- **Auto:** Shoot without any special effect on the image.
- **Skin:** Shoot with an effect that makea skin tones more natural
- **Night:** Use Night mode for night scenes or low light conditions.
- **Backlight:** You can take shots when bright light is behind the subject.
- **B/W:** The image is converted to black-and-white.
- **Classic:** The image is converted to sepia look.
- **Negative:** The image is converted as the negative of the normal

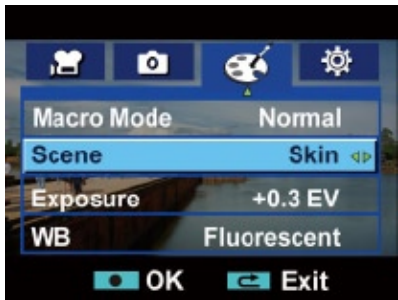
Operation	Display Screen
<ol style="list-style-type: none"> 1. In Effect Submenu, press Down button to enter Scene. 2. Use Right/Left Buttons to move between 7 settings. 3. Press OK Button to validate the setting. 	



Note

To avoid blurry pictures, place the Camcorder on a flat, steady surface, or use a tripod when taking shots in Night mode.

Exposure

The camcorder adjusts image exposure automatically. In certain circumstances you may wish to adjust the exposure compensation setting.

Operation	Display Screen
<ol style="list-style-type: none"> 1. In Effect Submenu, press Down button to select Exposure. 2. Use Right/Left Buttons to choose preferred EV(Exposure Value). The change can be previewed immediately. 3. Press OK Button to validate the setting. 	

WB (White Balance)

The camcorder adjusts the color balance of images automatically. Three manual white balance settings are available:



- **Auto:** The camcorder automatically adjusts white balance.
- **Daylight:** Under outdoors.
- **Fluorescent:** Under fluorescent light condition.
- **Tungsten:** Under tungsten light condition.

Operation	Display Screen
<ol style="list-style-type: none"> 1. In Effect Submenu, press Down button to select WB. 2. Use Right/Left Buttons to move between four settings. The change can be previewed immediately. 3. Press OK Button to validate the setting. 	

Section 4 Playback Mode

Button Function

The Buttons have the following functions in Movie and Picture Playback Modes.

	<p>Direction Button</p> <p>Right Button: Go to the next movie/picture. Fast forward</p> <p>Left Button: Go to the previous movie/picture. Fast rewind</p> <p>Up Button: Volume increase/Information ON/OFF</p> <p>Down Button: Volume decrease</p> <p>Menu/OK Button: Enter to movie or picture option Menu / Validate setting.</p> <p>Tele Button : Zoom in.</p> <p>Wide Button : Zoom out</p>
	<p>RECORD/PLAY Button functions:</p> <ol style="list-style-type: none"> 1. Switch between Record and Playback modes. 2. Return to the previous page.
	<p>Movie Shutter Button:</p> <p>Start playing the recorded movie.</p>

LCD Monitor Information



Indicators on the LCD screen while in Playback Mode:





(1)		HD (1080p) (30fps)
		HD (720p) (30fps)
		WVGA (60fps)
		VGA (30fps)
		QVGA (30fps)
		High
		Standard
		Low
(2)	00:06:10	Movie playback time counter
(3)		Indicate the selected movie/picture is locked.
(4)	0005/0005	Current Number/ Total number of movie or picture.
(5)		Volume
(6)		Indicate the screen is in movie playback mode:Play/Pause
(7)		Magnification Indicator.

Operations for Playback Mode

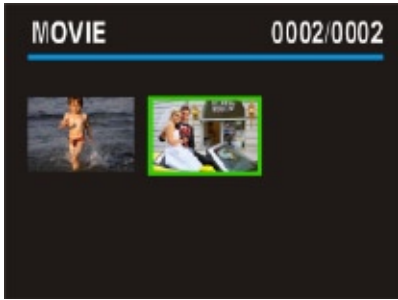
The Playback Mode is for viewing and managing movies and pictures on the built-in memory or on an SD card.

Operation	Display Screen
<ol style="list-style-type: none"> 1. Press RECORD/PLAY Button () to switch from Record Mode to Playback Mode Main Menu. There are 2 options in the Playback Mode, Movie and Picture. 2. Press Direction Button to select the specific option. 	
<ol style="list-style-type: none"> 3. Press Menu/OK Button to enter Movie/ Picture thumbnail preview folder. 4. Use direction buttons to locate the movies/ picture you want to view. 5. Press Menu/OK button to view the movies/ picture. 	

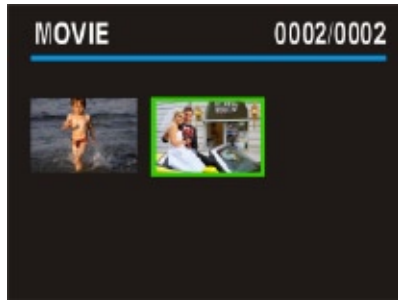

Movie Playback

Operation	Display Screen
<ol style="list-style-type: none"> 1. In movie thumbnail preview folder, use direction buttons to locate the movies you want to view. 2. Press Menu/OK button to play the movies. 	
<ol style="list-style-type: none"> 3. While playing movie, press Right/Left Buttons to fast forward/rewind, then release the button to stop. 4. Use Up/Down Buttons to adjust volume. 	

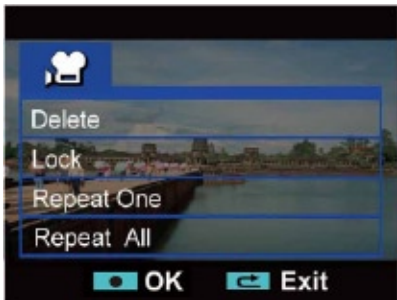
Movie Playback Mode Menu

Operation	Display Screen
<ol style="list-style-type: none"> 1. In Movie Playback Mode, press Menu/OK Button to enter Movie Playback Menu screen. 2. Use Up/Down Buttons to select four options, Delete, Lock, Repeat One, and Repeat All. 	

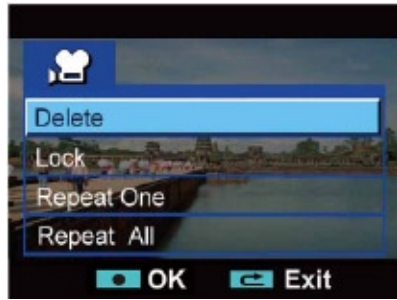
Delete Movies

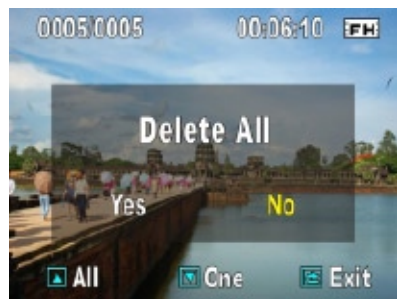
Operation	Display Screen
<ol style="list-style-type: none"> 1. Use Up/Down Buttons to select the Delete option. 	
<ol style="list-style-type: none"> 2. Press Menu/OK Button to go to the Delete Menu. 3. Use Right/Left Buttons to select the movie. 4. Use Up Button to delete all movies or Down Button to delete single movie. Or Press RECORD/PLAY Button to exit. 5. Before a movie is deleted, a confirmation screen will appear; choosing "Yes" will execute the operation and "No" will cancel the operation. 6. Press Menu/OK Button to validate the setting. 	
	





Note

- If a memory card is inserted, you can delete only those movies stored on the card.
- Movies on a written-protected memory card cannot be deleted.
- The delete function will only erase unlocked movies. Locked movies must be unlocked before being deleted.

Lock Movies

Single or all movies can be locked. This function can prevent the movies from being deleted accidentally.



Operation	Display Screen
<ol style="list-style-type: none"> 1. Use Up/Down Buttons to select the Lock option. 2. Press Menu/OK Button to go to the Lock Menu. 	 <p>A screenshot of a menu screen with a dark background and a blue header. The menu items are 'Delete', 'Lock', 'Repeat One', and 'Repeat All'. 'Lock' is highlighted with a blue bar. At the bottom, there are two buttons: 'OK' and 'Exit'.</p>
<ol style="list-style-type: none"> 3. Use Right/Left Buttons to select the movie. 4. Use Up Button to lock/unlock all movies or Down Button to lock/unlock single movie. 5. Press RECORD/PLAY Button to exit. 	 <p>A screenshot of a movie playing. The top of the screen shows '0005:0005' on the left, a lock icon in the center, and '00:06:10' on the right. The bottom of the screen shows three buttons: 'All', 'One', and 'Exit'.</p>

Repeat Movies

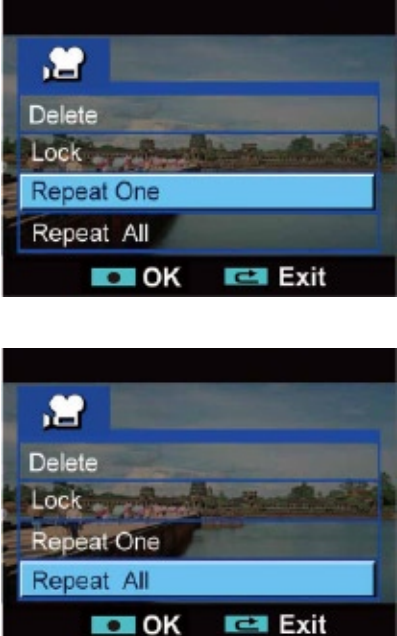
This function automatically repeats playing single movie or all movies in order.

Operation	Display Screen
<ol style="list-style-type: none"> 1. Use Up/Down Buttons to select the Repeat One option or Repeat All option. 2. Press Menu/OK Button to start repeating, press it again to stop and return to the previous page. 	 <p>Two screenshots of the menu screen. The top screenshot shows 'Repeat One' selected, and the bottom screenshot shows 'Repeat All' selected. Both screenshots have the same layout as the first screenshot in the 'Lock Movies' section.</p>

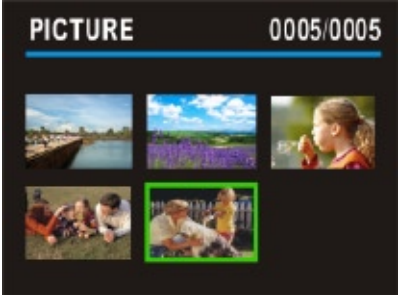

Picture Playback

Operation	Display Screen
<ol style="list-style-type: none"> 1. In Picture thumbnail preview folder, use direction buttons to locate the picture you want to view. 2. Press Menu/OK button to view the picture. 	
<ol style="list-style-type: none"> 3. Use Right/Left Buttons to go to the next or last picture. 4. While the picture is selected, use Tele Button to magnify. 5. Use Direction Buttons to navigate the magnified picture. Press Menu/OK Button to exit navigation mode. 	

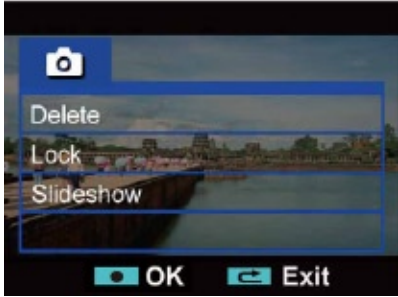
Picture Playback Mode Menu

Operation	Display Screen
<ol style="list-style-type: none"> 1. In Picture Playback Mode, press Menu/OK Button to enter Picture Playback Menu screen. 2. Use Up/Down Buttons to select three options, Delete, Lock, and Slideshow. 	

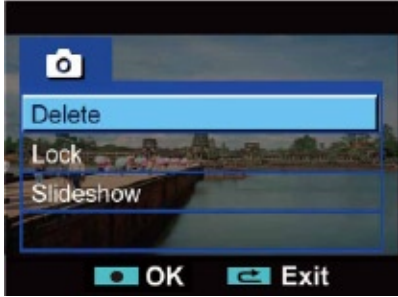
Delete Picture

Operation	Display Screen
<ol style="list-style-type: none"> 1. Use Down Buttons to select the Delete option. 	
<ol style="list-style-type: none"> 2. Press Menu/OK Button to go to the Delete Menu. 3. Use Right/Left Buttons to select the picture. 4. Use Up Button to delete all pictures or Down Button to delete single picture. Or Press RECORD/PLAY Button to exit. 5. Before a picture is deleted, a confirmation screen will appear; choosing "Yes" will execute the operation, "No" will cancel the operation. 6. Press Menu/OK Button to validate the setting. 	 





Note

- If a memory card is inserted, you can delete only those pictures stored on the card.
- Pictures on a written-protected memory card cannot be deleted.
- The delete function will only erase unlocked pictures. Locked pictures must be unlocked before being deleted.

Lock Pictures

Single or all pictures can be locked. This function can prevent the pictures from being deleted accidentally.

Operation	Display Screen
1. Use Up/Down Buttons to select the Lock option.	
2. Press Menu/OK Button to go to the Lock Menu. 3. Use Right/Left Buttons to select the picture. 4. Use Up Button to lock/unlock all pictures or Down Button to lock/unlock single picture. 5. Press RECORD/PLAY Button to exit.	

Make Slide Show

This function automatically repeats all pictures in order.

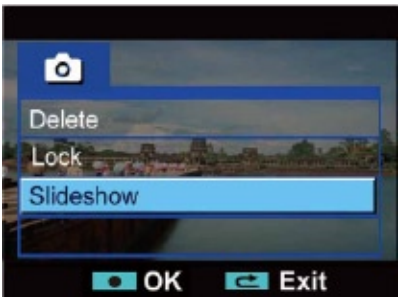
Operation	Display Screen
1. Use Up/Down Buttons to select the Slideshow option. 2. Press Menu/OK Button to start the slide show; press it again to stop and return to the previous page.	

Section 5

Setting Your Camcorder

Setting Menu

Setting Option	Display Screen
<ol style="list-style-type: none"> 1. In Record Mode, press Menu/OK Button to enter record Menu screen. 2. Use Right/Left Buttons to select Setting. 3. The Setting Submenu contains 7 options for configuring your camcorder set up. They are Sound (operation sound),Information,Time Setting,Format,TV,Language,and Default Setting. 	

Sound

Enable or disable KeyPad tone and operation sound.

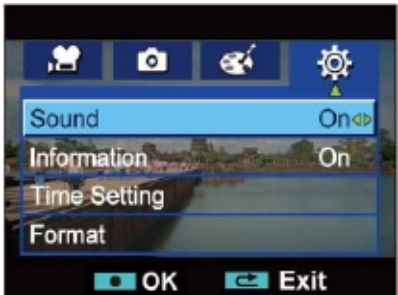
Operation	Display Screen
<ol style="list-style-type: none"> 1. In setting Submenu, press Down Button to go to the Sound Menu. 2. Use Right/Left Buttons to choose On or Off. 3. Press Menu/OK Button to validate the setting. 	

Information



To change Information setting by either hot key (Up Button) or Option Setting:

On: Show the indicator(s) on the LCD screen.

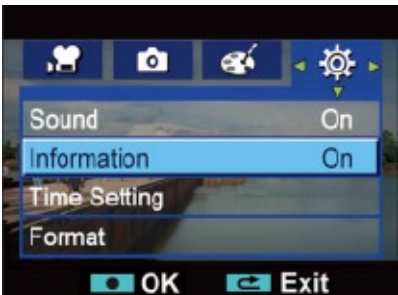
Off: Do not show the indicator(s) on the LCD screen

<ol style="list-style-type: none"> 1. In setting Submenu, press Down Button to go to the Information Menu. 2. Use Right/Left Buttons to choose On or Off. 3. Press Menu/OK Button to validate the setting. 	
---	--

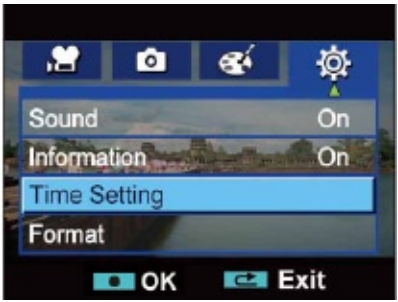

Time Setting

Operation	Display Screen
1. In setting Submenu, press Down Button to go to the Time Setting Menu.	
2. Move between Date, Time by using Up/Down Buttons. Adjust date and time by using Left/Right Buttons. 3. Press OK Button to validate the setting. Or Press RECORD/PLAY button to leave Time Setting without any change.	

Format

Yes: Format the built-in memory (When there is no SD Card in the camcorder) / SD Card (When there is an SD Card in the camcorder).

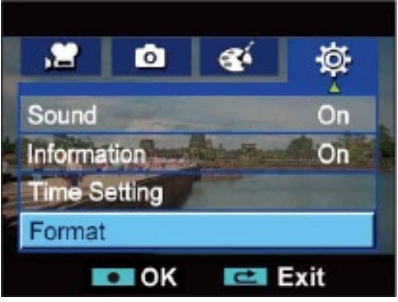
No: Do not format the built-in memory (When there is no SD Card in the camcorder) / SD Card (When there is an SD Card in the camcorder).

Operation	Display Screen
1. In setting Submenu, press Down Button to go to the Format Menu. 2. Press Menu/OK Button to go to the Format confirmation screen	
3. Use Right/Left Buttons to choose Yes or No. 4. Choosing "Yes" will execute the operation, "No" will cancel the operation. 5. Press Menu/OK Button to validate the setting.	



Note

All the data will be erased if the SD card is formatted. Make sure all the data are backed-up to PC before formatting SD card.

TV

Ensure that the appropriate TV standard of your area is selected – either NTSC or PAL.

Wrong TV system setting may cause image flicker.

NTSC standard: USA, Canada, Japan, South Korea and Taiwan etc.

PAL standard: UK, Europe, China, Australia, Singapore and Hong Kong etc.

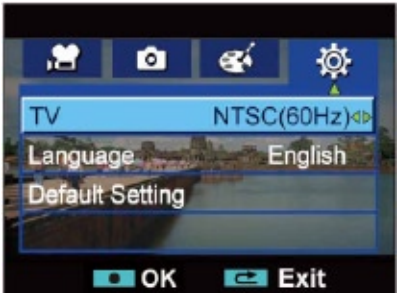
Operation	Display Screen
<ol style="list-style-type: none">1. In setting Submenu, press Down Button to go to the TV Menu.2. Use Right/Left Buttons to choose NTSC(60Hz) or PAL(50Hz).3. Press Menu/OK Button to validate the setting.	 A screenshot of a television's settings menu. At the top, there are four icons: a person, a camera, a signal tower, and a gear. Below these, the menu is divided into sections. The first section is 'TV', which is highlighted in blue and shows 'NTSC(60Hz)' with left and right arrow icons. Below it is 'Language', which is also highlighted in blue and shows 'English'. At the bottom of the menu, there are two buttons: 'OK' and 'Exit', both with blue highlights.

Language

Use this option to select the language of user interface which you want.

Operation	Display Screen
<ol style="list-style-type: none">1. In setting Submenu, press Down Button to go to the Language Menu.2. Use Right/Left Buttons to choose the language options.3. Press Menu/OK Button to validate the setting.	 A screenshot of a television's settings menu, similar to the one above. The 'TV' section is still visible at the top. The 'Language' section is now highlighted in blue and shows 'English' with left and right arrow icons. The 'OK' and 'Exit' buttons are at the bottom.

Default Setting

To restore the default factory setting, select this option.

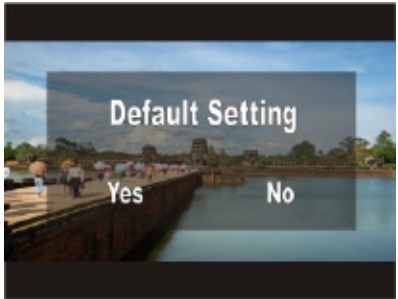
Operation	Display Screen
<ol style="list-style-type: none"> 1. In setting Submenu, press Down Button to go to the Default Setting Menu. 2. Press Menu/OK Button to go to the Default Setting confirmation screen. 	
<ol style="list-style-type: none"> 3. Use Right/Left Buttons to choose Yes or No. 4. Choosing "Yes" will execute the operation, "No" will cancel the operation. 5. Press Menu/OK Button to validate the setting. 	

The following table indicates the Camcorder's default setting

Setting	Default Factory Setting
Resolution	HD (1080p) for Movie Standard for Picture
Flash	Off
Self timer	Off
Scene	Auto
Exposure	0EV
WB (White Balance)	Auto
Sound	On
Information	On
TV	Depends on shipping area
Language	Depends on shipping area
Volume	Level 12
Macro	Normal

Section 6

Viewing Pictures and Movies on a TV

Connecting to a High-Definition

1. Connect one end of the HDMI cable to your Camcorder's HDMI Out port.
2. Connect the other end of the cable to a television.
3. Set video input source of a TV to "HDMI" option.
4. The steps for viewing stored pictures and movie on a TV are exactly the same as for viewing them on the LCD monitor.

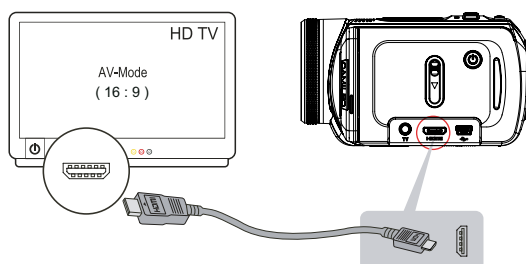

Note

The camcorder can not run movie recording and picture taking when it is connected to an HDTV. The LCD Panel does not display when the camcorder is connected to an HDTV.

Connecting to a non-high-definition

1. Connect one end of the AV cable to your Camcorder's AV Out port.
2. Connect the other end of the cable to a television.
3. The steps for viewing stored pictures and movie on a TV are exactly the same as for viewing them on the LCD monitor.

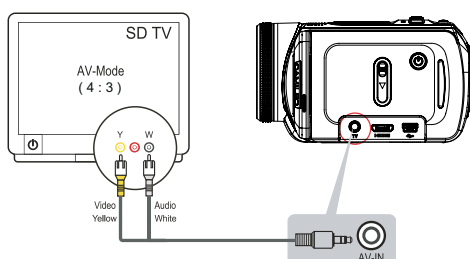

Note

The LCD Panel does not display when the camcorder is connected to a TV.

Section 7

Viewing Pictures and Movies on PC

Installing Bundled Software

The CD-ROM supplied with this Camcorder contains 2 pieces of software.

- **ArcSoft MediaImpression** is a user-friendly application that helps you managing your media, burning your video into DVD, and uploading your videos to YouTube easily.
- **Adobe Reader** is a popular program that you need to have installed to read the User's Manual. Many computer users will find they already have this software installed on their computer.

To install the bundled software:

1. Insert the CD-ROM into your computer's CD-ROM drive. The autorun screen appears.
2. Click **Install Application Software**. Follow the on-screen instructions to complete the installation.



Note

The detailed information can be found in online help of all the bundled software.

Transferring Data to a Computer

You can transfer pictures or movies stored on your Camcorder to a computer and send them in emails to friends or post them on websites.

To do this you should:

1. Connect the computer and Camcorder with the supplied mini USB 2.0 cable. The LED will light up and blink.
2. After the LED stops blinking, movies and picture(s) can be found on your computer at "My Computer\Removable Disk\DCIM\100MEDIA".
3. Under this folder, you can view, delete, move, or copy any movie/picture you want.
4. Use the bundled ArcSoft application software to edit the movies or pictures.

Section 8

Burning the Recorded Clip into DVD

Bundled software CD contains ArcSoft MediaImpression features burning the movie clip into DVD. You can share this DVD movie with family and friends by using regular DVD player.

To create a DVD:

1. Install ArcSoft MediaImpression (Refer to Section 7)
2. Click Windows [Start] → [(All) Programs] → [ArcSoft MediaImpression]
3. ArcSoft MediaImpression main screen will appear on your desktop.
4. Click [Make Movie] .



5. The operation screen will appear:

- Select the folder that contains the video files you want to burn.
- Select the file(s)
- Click button to add the files into slide
- Click [Burn to Disc]

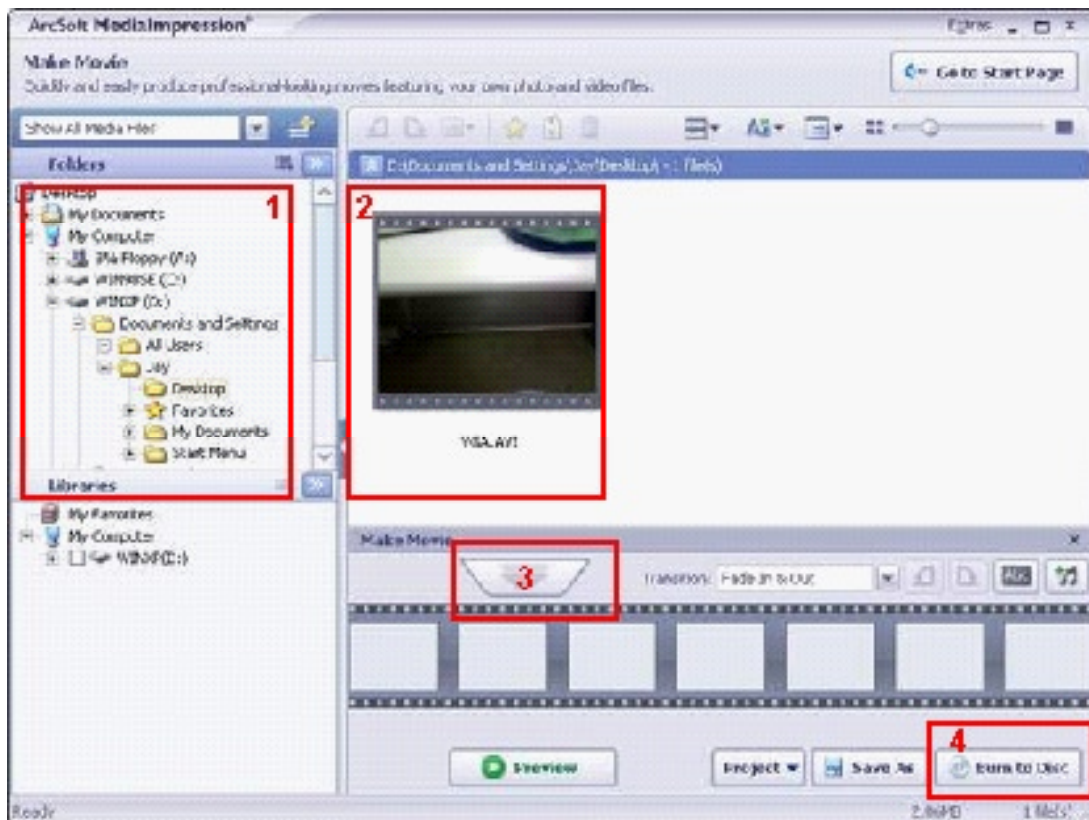

6. Click [Start] to start DVD burning.

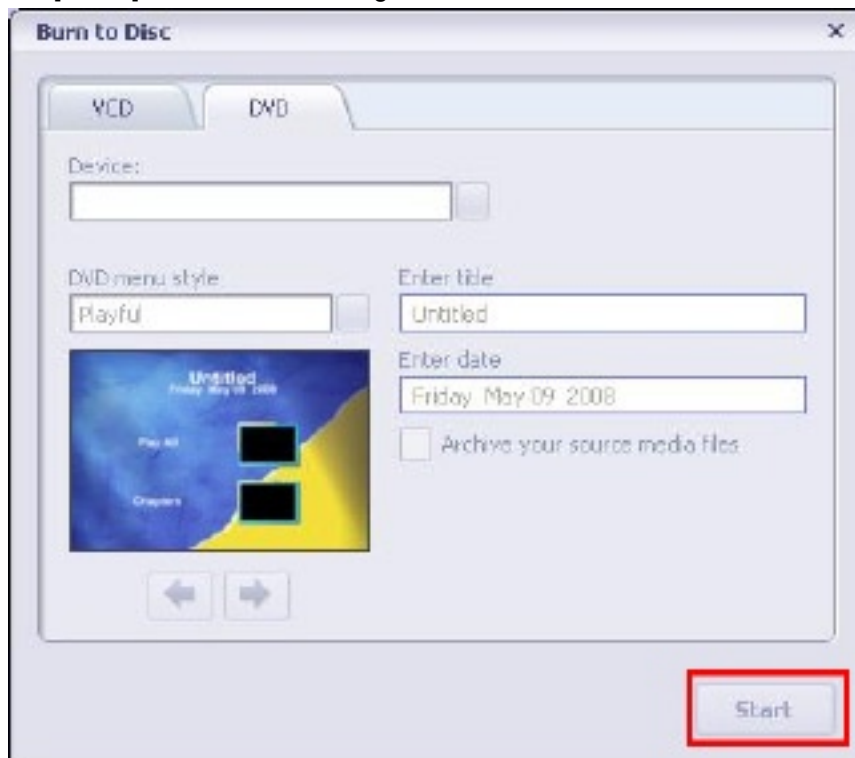

Section 9

Uploading Video Files to YouTube

Bundled software CD contains **ArcSoft MediaImpression** features uploading the recorded videos to YouTube. It will help you to share them with your family and friends on YouTube website.

To upload video files to YouTube:

1. Install ArcSoft MediaImpression (Refer to Section 7)
2. Click Windows [Start] → [(All) Programs] →[ArcSoft MediaImpression]
3. ArcSoft MediaImpression main screen will appear on your desktop.
4. Click [Video] Option.



5. Select the video file you want to upload and click [Upload to YouTube] option at the bottom Menu.

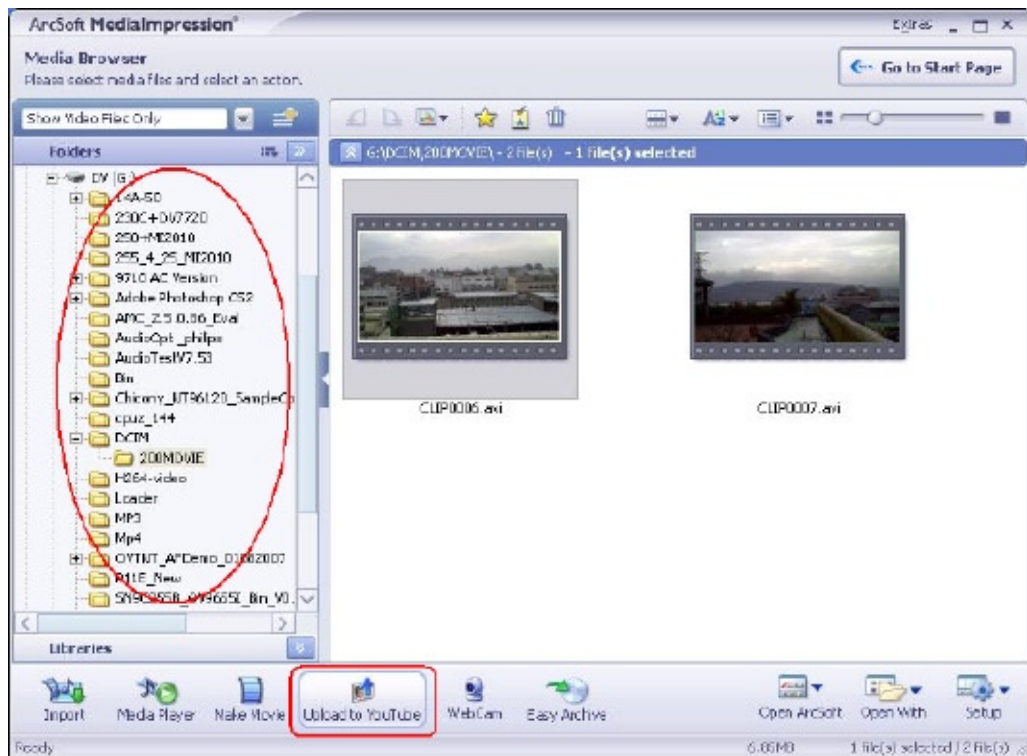

6. If this is your first using of this function, please follow the instruction on YouTube Setting Panel.

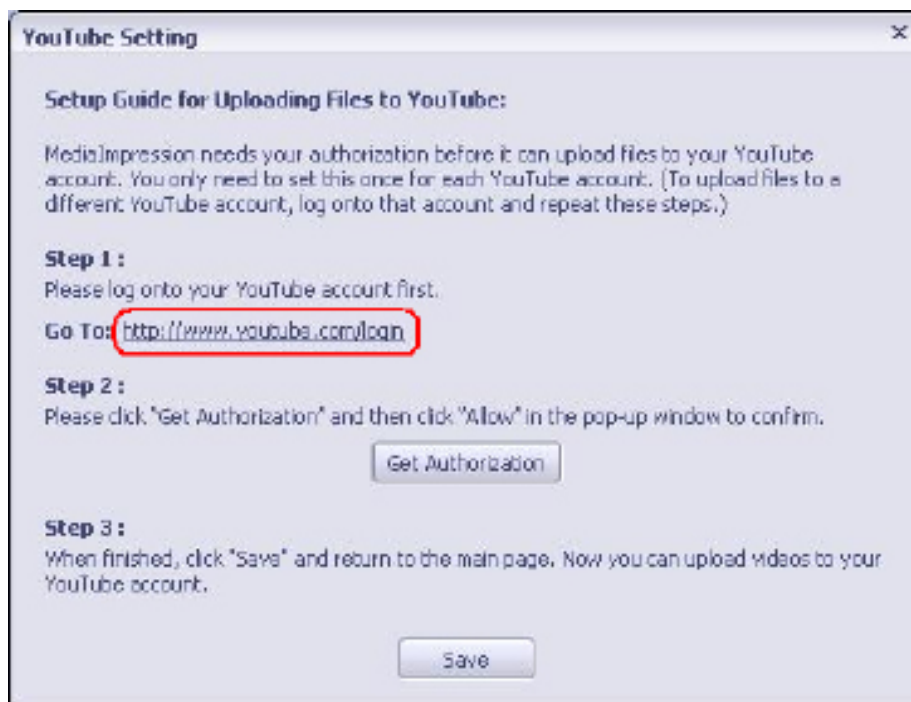

7. Go to <http://www.youtube.com/login>, then log onto your YouTube account.

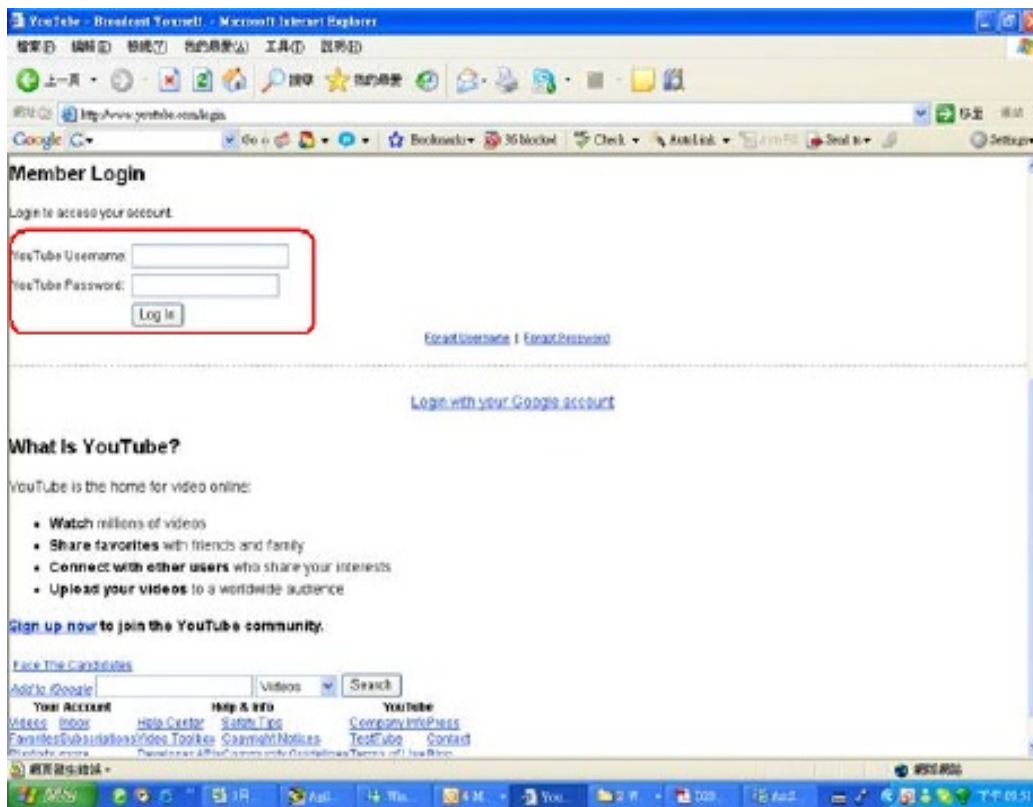

(If you do not have YouTube account, sign up here first.)

8. After you log onto your YouTube account, Click [Get Authorization] button below.

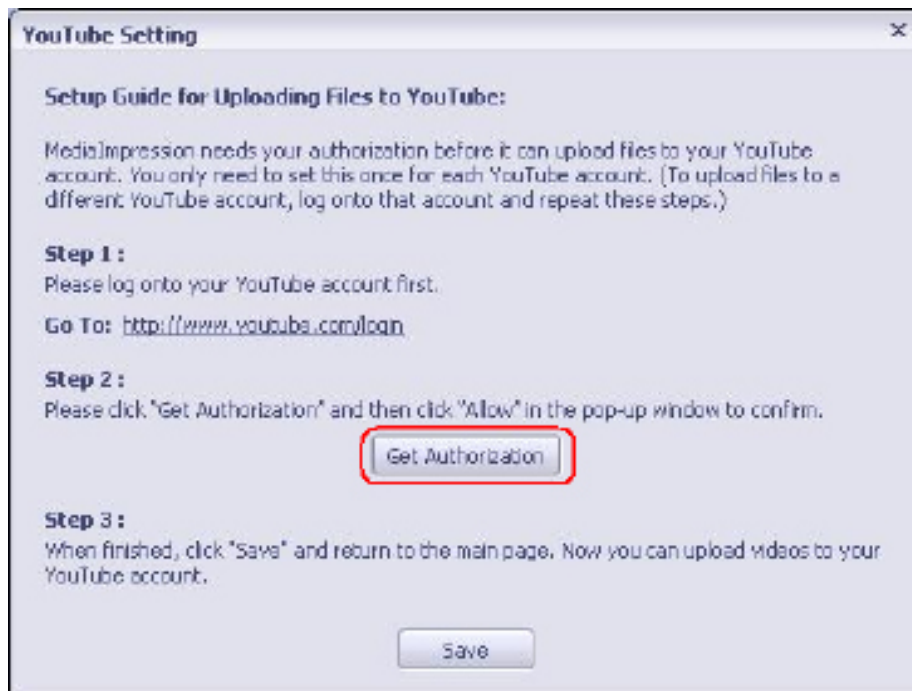

Then, Click [Allow] Button shown on YouTube website.

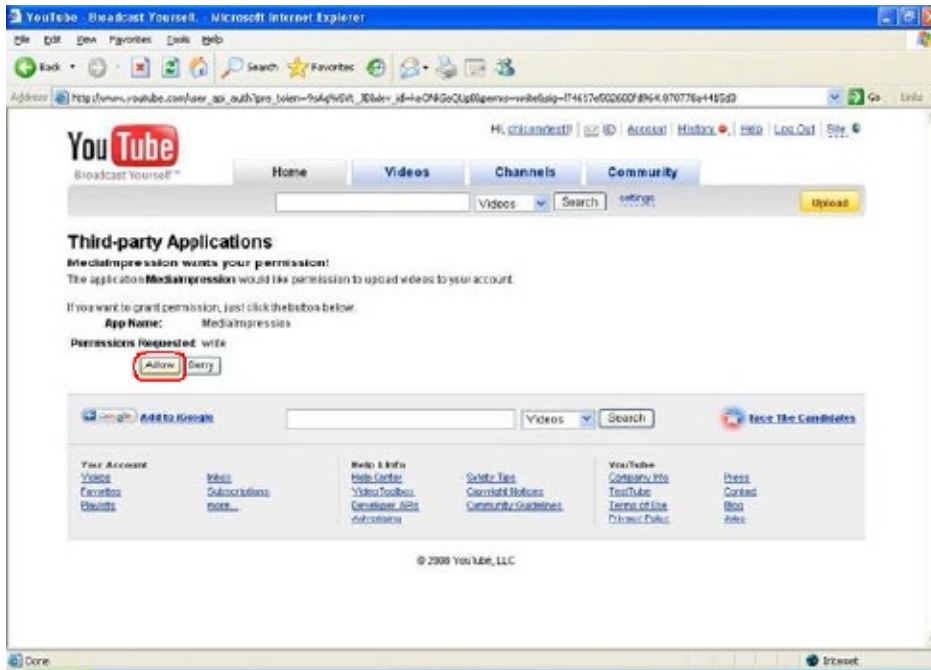

9. Click [Save] Button to upload the video.

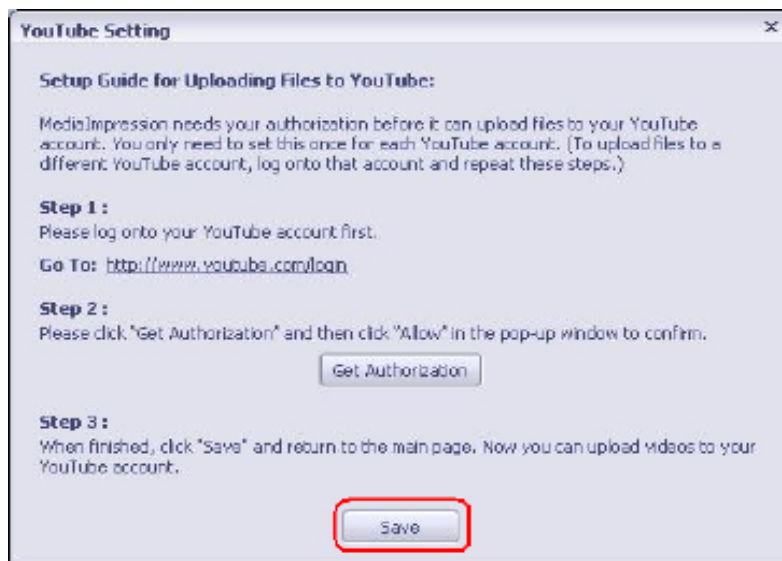

Section 10 Specifications

Specification	
Image Sensor	5 Mega Pixel CMOS Sensor
Operation Modes	Movie Record, Picture Record
Lens	f=6.8 ~ 34mm; F3.5 ~3.7
Focus Range	Macro: 1 ~ 80cm Normal: 10cm ~ infinite
Zoom	Optical:1X~10X (5X Optical + 2X Digital) . Other video resolution:1X~20X (5X Optical + 4X Digital)
Shutter	Electronic
LCD monitor	3"LCD
Storage Media	Built-in 128MB Memory (partial memory is used for Firmware code); SD Card Slot support
Image Resolution	High 3200x2400 (8M Pixels) Std 2592x1944 (5M Pixels) Low 2048x1536 (3M Pixels)
Movie Resolution	HD(1080p) 1440X1080(30fps) HD(720p) 1280X720(30fps) WVGA 848X480(60fps) VGA 640X480(30fps) QVGA 320X240(30fps)
White Balance	Auto/Manual (Daylight, Fluorescent, Tungsten)
Exposure	Auto/Manual
Self timer	10 second delay
Flash	Auto/Red-Eye-Reduction/Off
File Format	Picture: JPG Movie: MOV
Image play	Single Image/Slideshow
PC Interface	Mini USB 2.0 Port
TV out	NTSC/PAL Selectable, HDMI
Battery	Lithium-ion Rechargeable Battery
Dimension	117(H) * 56(W) * 65(D) mm
Weight	340g (without battery)

Section 11

Troubleshooting

Troubleshooting

1.If the LCD image is not clear when shooting, how can the focus be adjusted?

Taking photos and the object is within 80cm, use Macro Mode which is the Submenu of Effect Mode.

2.The flash is not working.

The camcorder is in Macro Mode / The battery power is low.

3.The files on the memory card do not display smoothly when the LCD shows the “!” marking.

The “!” means the SD card is low speed or having wrong content inside. The way to solve this condition is to format SD card by camcorder instead of PC (Please refer to the detail Format instruction in Section 5).

4.Why is Camcorder Flash not active when taking pictures?

Make sure that the focus range is NOT set at Macro mode, as flash is disabled in this mode. Scroll through Picture mode and set Flash as Auto; note that Flash OFF is the default pre-set mode for normal picture - taking. In Auto mode camcorder flash fires ONLY when necessary (in dark setting as example).

5.Why do some of my indoor pictures look blurry and dark?

Camcorder extends pictures exposure time under low light/ indoor condition. Keep camcorder (and photographed subject) steady for several seconds when taking pictures. Shutter will sound when picture has been taken.

6.How do I charge battery?

Computer will not charge battery when connected. You must use ONLY the supplied AC charger.

Camcorder must be turned OFF; blinking light confirms charging, but light is constant when charging has been completed.

Section 12

Other Information

TOSHIBA Support

Need help?

For the latest driver updates, user's manuals & FAQ's please have a look at the TOSHIBA options & services support page:
computers.toshiba.eu/options-support

Please see computers.toshiba.eu/options-warranty for the TOSHIBA hotline numbers.

Operating Environment Conditions

Operating temperature: 5 to 35° C

Operating humidity: 20 to 80 %

(no condensation allowed)

Regulatory Information

CE compliance

This product is CE marked in accordance with the requirements of the applicable EU Directives. Responsible for CE marking is Toshiba Europe GmbH, Hammfelddamm 8, 41460 Neuss, Germany. A copy of the official Declaration of Conformity can be obtained from following website:
<http://epps.toshiba-teg.com>.

Working Environment

The Electromagnetic Compliance (EMC) of this product has been verified typically for this product category for a so called Residential, Commercial & Light Industry Environment. Any other working environment has not been verified by Toshiba and the use of this product in these working environments is maybe restricted or cannot be recommended. Possible consequences of the use of this product in non verified working environments can be: Disturbances of other products or of this product in the nearby surrounding area with temporarily malfunction or data loss/corruption as result. Example of non verified working environments and related advices:

Industrial environment (e.g. environments where a mains voltage of 380V three-phase is being used mainly): Danger of disturbances of this product due to possible strong electromagnetic fields especially near to big machinery or power units.

Medical environment: The compliance to the Medical Product Directive has not been verified by Toshiba, therefore this product cannot be used as a medical product without further verification. The use in usual office environments e.g. in hospitals should be no problem if there is no restriction by the responsible administration.

This product is not certified as a medical product according to the Medical Product Directive 93/42 EEC.

Automotive environment: Please search the owner instructions of the related vehicle for advices regarding the use of this product (category).

Aviation environment: Please follow the instructions of the flight personnel regarding restrictions of use.

Additional environments not related to EMC

Outdoor use: As a typical home/office equipment this product has no special resistance against ingress of moisture and is not strong shock proofed.

Explosive atmosphere: The use of this product in such special working environment (Ex) is not allowed.

Following information is only valid for EU-member states:

Disposal of products

The crossed out wheeled dust bin symbol indicates that products must be collected and disposed of separately from household waste. Integrated batteries and accumulators can be disposed of with the product. They will be separated at the recycling centres.



The black bar indicates that the product was placed on the market after August 13, 2005.



By participating in separate collection of products and batteries, you will help to assure the proper disposal of products and batteries and thus help to prevent potential negative consequences for the environment and human health.

For more detailed information about the collection and recycling programmes available in your country, please visit our website (<http://eu.computers.toshiba-europe.com>) or contact your local city office or the shop where you purchased the product.

Disposal of batteries and/or accumulators

The crossed out wheeled dust bin symbol indicates that batteries and/or accumulators must be collected and disposed of separately from household waste.

If the battery or accumulator contains more than the specified values of lead (Pb), mercury (Hg), and/or cadmium (Cd) defined in the Battery Directive (2006/66/EC), then the chemical symbols for lead (Pb), mercury (Hg) and/or cadmium (Cd) will appear below the crossed out wheeled dust bin symbol.

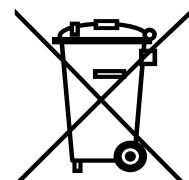

Pb,Hg,Cd

By participating in separate collection of batteries, you will help to assure the proper disposal of products and batteries and thus help to prevent potential negative consequences for the environment and human health.

For more detailed information about the collection and recycling programmes available in your country, please visit our website (<http://eu.computers.toshiba-europe.com>) or contact your local city office or the shop where you purchased the product.

Additional Information

© 2008 TOSHIBA Europe GmbH. All rights reserved.

TOSHIBA reserves the right to make technical changes. TOSHIBA assumes no liability for damages incurred directly or indirectly from errors, omissions or discrepancies between this product and the documentation.

2570A8382L-A01

For further options & services see:
computers.toshiba-europe.com

TOSHIBA
Leading Innovation >>>

Free Manuals Download Website

<http://myh66.com>

<http://usermanuals.us>

<http://www.somanuals.com>

<http://www.4manuals.cc>

<http://www.manual-lib.com>

<http://www.404manual.com>

<http://www.luxmanual.com>

<http://aubethermostatmanual.com>

Golf course search by state

<http://golfingnear.com>

Email search by domain

<http://emailbydomain.com>

Auto manuals search

<http://auto.somanuals.com>

TV manuals search

<http://tv.somanuals.com>