



**Quality Refrigeration**

# **OWNER'S MANUAL**

**Instructions for the installation, operation,  
and maintenance of Blast Chiller models:**

**TBC5 (5 pan level undercounter model)  
TBC13 (13 pan level reach-in model)  
TBC1H (1 rack capacity roll-in model)  
TBC1HR (1 rack capacity roll-thru model)**

This Traulsen unit is built to our highest quality standards. We build our refrigerators, freezers, blast chillers and heated cabinets this way as a matter of pride. This philosophy has made Traulsen the leader in commercial refrigeration since 1938. We thank you for your choice and confidence in Traulsen equipment and we know you will receive many years of utility from this equipment.

All Traulsen units are placed on a permanent record file with the service department. In the event of any future questions you may have, please refer to the model and serial number found on the name tag affixed to the unit. Should you need service, however, call us on our toll free number, 800-825-8220 between 7:30 am and 4:30 pm CST, Monday thru Friday. It is our pleasure to help and assist you in every possible way.

## **IMPORTANT WARRANTY NOTES**

### **TBC5 & TBC13 Owner/Operators**

**Please Contact the Service Dept. @ (800) 825-8220 upon start-up to register your warranty**

### **TBC1H & TBC1HR Owner/Operators**

**Please contact the Service Dept. @ (800) 825-8220 after installation but before start-up in order to register your warranty and arrange for a mandatory free Installation Validation & Service Check (allow at least 72 hours from time of call for this to be performed)**

**Contact your local Hobart/Traulsen sales representative to arrange for a free on-site demonstration (after warranty registration and/or installation validation)**

# I. TABLE OF CONTENTS

<b>II. Introduction</b>		<b>VIII. The Epicon Control</b>	
a-Purpose/Overview	Page 2	a-Epicon Control Overview	Page 8
b-Basic Operation	Page 2	b-Modes of Operation	Page 8
c-Defrost	Page 2	c-Chill Programs	Page 8
d-Installation Checklist	Page 2	d-Operating Methods	Page 8
		e-Maintenance Mode	Page 8
<b>III. Receipt Inspection</b>	Page 3	f-The Tool Box	Page 8
		g-Food Probes	Page 8
<b>IV. Installation</b>		h-USB Port	Page 8
a-Location	Page 3	i-Time Zones	Page 8
b-Packaging	Page 3	j-User Names	Page 9
c-Wiring Diagram	Page 3	k-Product Names	Page 9
d-Installing Legs or Casters	Page 3	l-Record & Label Printers	Page 9
e-Interior Arrangements	Page 3		
f-Electrical Requirements/Cord & Plug	Page 4	<b>IX. Operation</b>	
g-Proper Clearances	Page 4	a-Basic Operation - AUTO	Page 9
h-Condensate Removal	Page 4	b-Basic Operation - MANUAL	Page 9-10
i-Remote Unit BTU Requirements	Page 4	c-Printing	Page 10
j-Sealing Roll-In/Roll-Thru Units	Page 4	d-Adding Product to a Cycle in Progress	Page 10
k-ON/OFF Power Switch	Page 4	e-Freezing Product	Page 10
l-Printer Paper	Page 4	f-Entering Product & User Names at Cycle Start	Page 11
m-Capacity	Page 4	g-Entering Product & User Names at Cycle End	Page 12
		h-Updating Software	Page 12
<b>V. Care &amp; Maintenance</b>		i-Saving Recipes	Page 12
a-Cleaning The Condenser	Page 5	j-Cancelling a Chill Cycle	Page 12
b-Printer Supplies	Page 5	k-Understanding the RUN Screen	Page 13
c-Installing Printer Paper	Page 5	l-Deleting Recipes	Page 13
d-Battery Replacement	Page 5		
e-Cleaning The Exterior	Page 6	<b>X. Toolbox Features</b>	
f-Cleaning The Interior	Page 6	a-Accessing the Toolbox	Page 13
		b-User Menu, Setting the Clock	Page 14
<b>VI. Other</b>		c-User Menu, Adjusting Defrost Settings	Page 14
a-Service Agency Check & Start-Up	Page 6	d-User Menu, Download Cycle Data	Page 14
b-Service Information	Page 6	e-User Menu, Search Chill Cycle History	Page 15
c-The Serial Tag	Page 6	f-User Menu, Uploading Recipes	Page 15
d-On-Site Blast Chill Training	Page 6		
e-Demonstrations	Page 6	<b>XI. Glossary of Icons</b>	Page 16
		<b>XII. Trouble Shooting</b>	Page 17
<b>VII. Basic Operating Guidelines</b>		<b>XIII. Warranty Information</b>	Page 18
a-Chilling Within HACCP Guidelines	Page 7		
b-Loading	Page 7		
c-Use of Food Probes	Page 7		
d-Covering Products	Page 7		
e-Multi-Batching	Page 7		

## II. Introduction

### II. a - PURPOSE/OVERVIEW:

Thank you for your decision to purchase a Traulsen Blast Chiller. This important piece of food safety equipment is built to our highest standards and will provide you with years and years of dependable service.

It is important to note that although this product is designed to chill hot product from 135°F down to below 41°F within FDA/HACCP guidelines, several operational factors, such as product temperature, density, loading, etc. will all effect actual chilling performance. As a result, although easy to use, the operation of blast chilling requires diligent attention on the part of the operator(s) in order to insure proper results.

It is also important to note that many perceived service problems can actually be attributed to operational issues, resulting in lost product and/or down time. Please review the instructions contained within this manual completely, and make certain that all operators are well trained in the equipments proper use.

### II. b - BASIC OPERATION:

All Traulsen blast chillers accomplish their task by rapidly circulating very cold air. Upon starting a chill cycle using the STANDARD method, interior cabinet air temperature is set to a -27°F differential from the target temperature. When using the default target of 37°F the chiller will cycle between 10°F (OFF) and 14°F (ON). These temps were determined as optimum for rapid chilling product without freezing.

**NOTE:** For products prone to freezing (ex. high water content such as produce) we recommend use of the DELICATE method. Delicate uses a differential of only -7°F from the target temperature.

The blast chiller will continue this operation until such time as all probes reach the target temperature (when chilling by TEMP) or all time zones have elapsed (when chilling by TIME). At this point it will automatically return to MAINTENANCE operation with cabinet air temperature maintained at the target temperature (default 37°F). This maintains chilled food safely refrigerated and in the case of FREEZE cycles, the product will be held at the correct frozen temperature.

### II. c - DEFROST:

All refrigeration equipment require a regular defrost cycle in order to maintain their evaporator coils clear of ice. The Traulsen blast chillers covered in this manual are programmed to automatically defrost every six hours.

The period of defrost will be a maximum of 40-minutes in duration. This is temperature terminated. Should the coils reach their target temperature of 50°F prior to that time elapsing the blast chiller will automatically stop defrosting and return to normal operation.

To increase/decrease the interval between defrost cycles select: **MANUAL - TOOLBOX - USER - SCHEDULED DEFROST**. At the bottom of the screen adjust to the desired defrost interval, then press **SAVE**.

### II. c - DEFROST (cont'd):

Product left inside will be safely held because:

- a) If occurring at the end of a chill cycle the cabinet air temp of 10-15°F will hold the product safely for the maximum 40-minutes of defrost.
- b) If occurring while in maintenance mode the defrost period will almost certainly be significantly less than 40-minutes, so product temperature will not be effected.

**NOTE:** Do not open the door during defrost unless it is to remove all product inside.

### II. d - INSTALLATION CHECKLIST:

Install requirements vary by model...

#### Model TBC5

- 1) Insure proper clearances, no obstruction to either front louver for at least 24" from cabinet face.
- 2) Install all four standard legs or optional casters, insuring that the unit is level for proper operation.
- 3) Plug the power cord into a dedicated 115 volt/20 amp outlet.
- 4) Insure the paper supply for the printer(s) is properly installed and that the printers are operational.

#### Model TBC13

- 1) Insure proper clearances. No obstruction of the front louvers and 3" on the left, right and rear (86°F or less) or 5-1/2" on the left, right and rear (greater than 86°F).
- 2) Install the legs or casters, insuring that the unit is level for proper operation.
- 3) Place condensate tube in to floor drain or install optional condensate evaporator.
- 4) Plug the power cord into a dedicated 220/115/60/1 volt, 20 amp outlet.
- 5) Insure the paper supply for the printer(s) is properly installed and that the printers are operational.

#### Models TBC1H & TBC1HR

- 1) Insure proper clearances, no obstruction to either front louver for at least 12" above the cabinet. Unit must be located on a level surface.
- 2) Seal the unit to the floor in accordance with local sanitation codes.
- 3) Install the door ramp(s).
- 4) Place condensate tube into floor drain or install optional condensate evaporator.
- 5) Hardwire to a dedicated 115 volt/20 amp circuit.
- 6) Insure the paper supply for the printer(s) is properly installed and that the printers are operational.

#### IMPORTANT NOTE

In order to accomplish blast chilling, models TBC1H and TBC1HR require one properly sized remote condensing unit. This can be purchased from Traulsen or elsewhere, however installation would be by others.

### III. RECEIPT INSPECTION

All Traulsen products are factory tested for performance and are free from defects when shipped. The utmost care has been taken in crating this product to protect against damage in transit. All interior fittings have been carefully secured and the legs or casters are boxed and strapped inside to prevent damage. Door keys will be attached to the handle with a nylon strip. The handle is protected by an easily removable nylon netting.

You should carefully inspect your Traulsen unit for damage during delivery. If damage is detected, you should save all the crating materials and make note on the carrier's Bill Of Lading describing this. A freight claim should be filed immediately. If damage is subsequently noted during or immediately after installation, contact the respective carrier and file a freight claim. Under no condition may a damaged unit be returned to Traulsen without first obtaining written permission (return authorization).

### IV. INSTALLATION

#### IV. a - LOCATION:

Select a proper location for your Traulsen unit, away from extreme heat or cold. Allow enough clearance between the unit and the side wall so that the door(s) may open a minimum of 90°.

#### IV. b - PACKAGING:

All Traulsen units are shipped from the factory bolted to a sturdy wooden pallet and durably packaged. Care should be taken when removing the packaging in order to avoid scratching the unit's exterior metal finish.

To remove the wooden pallet, first if at all possible, we suggest that the cabinet remain bolted to the pallet during all transportation to the point of final installation. The bolts can then be removed with a 3/4" socket wrench. Avoid laying the unit on its front, side or back for removal of the pallet.

**NOTE: DO NOT LAY THE UNIT ON ITS SIDE DURING TRANSPORTATION OR INSTALLATION.**

#### IV. c - WIRING DIAGRAM:

Refer to the wiring diagram for any service work performed on the unit. Should you require a wiring diagram, please contact Traulsen Service at (800) 825-8220, and provide the model and serial number of the unit involved.

#### IV. d - INSTALLING LEGS OR CASTERS:

**▲ WARNING** The cabinet must be blocked and stable before installing legs or casters.

6" high stainless steel legs are supplied standard for models TBC5 and TBC13. Casters in lieu of legs are available as an optional accessory for the same models. These are shipped from the factory packed inside a cardboard box which is strapped to one of the shelves. Remove the nylon strap and open the box, it should contain either four (4) legs or casters (and four bolts for each caster).

### IV. INSTALLATION (continued)

#### IV. d - INSTALLING LEGS OR CASTERS (cont'd):

To install the legs or casters, first raise and block the unit a minimum of 7" from the floor.

For model TBC5 slide the legs or casters into the two channels under the front and back of the cabinet (see figure 1). Secure in place by tightening the two bolts located at the base of each leg or caster. NOTE: Legs or casters must be installed towards the four corners of the unit for proper support.

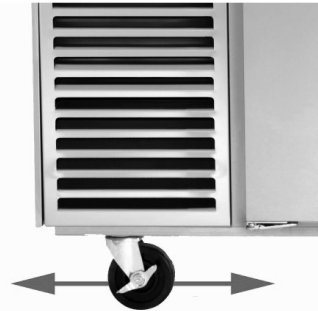

Fig. 1

On model TBC13 thread the legs into the threaded holes on the bottom of the cabinet (see fig. 2). Be certain that all legs are tightened securely. When the unit is set in its final position, it is important for proper operation that the unit be level. The legs are adjustable for this purpose, turn the bottom of the leg counter-clockwise to raise it, clockwise to lower it. Level the unit from front to back as well as side to side in this manner, using a level placed in the bottom of the cabinet.

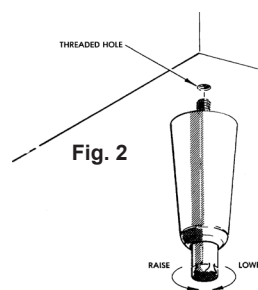

Fig. 2

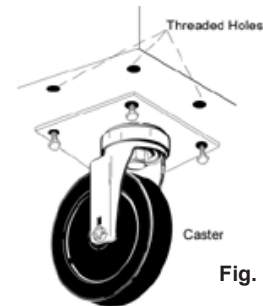

Fig. 3

For installing optional casters, these are "plate" type, and require the use of four (4) bolts to secure them firmly to the cabinet bottom at each corner (see figure 3). The caster bolts are tightened using a 1/2" socket wrench.

#### IV. e - INTERIOR ARRANGEMENTS:

Models TBC5 and TBC13 are shipped with their full complement of tray slides already installed from the factory. Upon delivery the plastic ties used to secure these during shipping should be removed prior to first use.

The slides are spaced to allow for maximum capacity of 2" deep pans. If use of deeper pans is required, the slides can be removed and adjusted to accommodate this. However please note that the total quantity of pans possible will be reduced in order to make room for the deeper pans.

Model TBC1H and TBC1HR are designed to accommodate one roll-in rack with overall dimension (wheels inboard of frame) which do not exceed 72" high by 27" wide by 29" deep.

## IV. INSTALLATION (continued)

### IV. f - ELECTRICAL REQUIREMENTS/CORD & PLUG:

Traulsen models TBC5 and TBC13 are supplied with a cord & plug attached. Models TBC1H and TBC1HR require hard wiring to the power supply, and the 4HP remote condensing unit requires a separate electrical connection of its own. For your safety and protection, all units supplied with a cord and plug include a special three-prong grounding plug on the service cord. Select only a certified electrical outlet with grounding plug for power source. NOTE: Do not under any circumstances, cut or remove the round grounding prong from the plug, or use an extension cord.

A dedicated, grounded circuit should be provided to assure that the computerized control is not adversely affected by the operation of other equipment.

Model TBC5 is provided with a NEMA 5-15P cordset.

Model TBC13 is provided with a NEMA L14-20P cordset.

### IV. g - PROPER CLEARANCES:

Model TBC5: Make certain that there are no obstructions in front of the left side louver panel. This will allow for sufficient air flow to the refrigeration system and maintenance access.

Model TBC13: No rear clearance is required. Allow for 6" on either side and make certain that there are no obstructions in front of the louver panel. This will allow for sufficient air flow to the refrigeration system and maintenance access.

Models TBC1H and TBC1HR: Insure an overhead clearance of at least 12". This will allow for sufficient air flow to the refrigeration system and maintenance access.

### IV. h - CONDENSATE REMOVAL:

All Traulsen Blast Chill models (except model TBC5) require the use of a floor drain or optional electric condensate evaporator.

Model TBC13 requires either a floor drain or the use of an optional bottom mounted electric condensate evaporator pan kit (TBCACC-BMCE) for condensate removal. The drain port location is at the bottom right of the unit. A receptacle is provided underneath.

Models TBC1H and TBC1HR require either a floor drain or the use of an optional electric condensate evaporator pan kit (BCACC-FMCE) for condensate removal. This can be installed on the chiller through the access panel located front right at the bottom.

This section applies only to models TBC1H and TBC1HR. A remote condensing unit, operating on R-404A refrigerant, is required for Blast Chill operation on these models. The remote condensing unit should be capable of providing 18,700 BTU/hr @ -10°F evaporator temperature in a 90°F ambient environment.

### IV. i - REMOTE CONDENSING UNIT REQUIREMENTS:

Both air-cooled and water-cooled remote condensing units are available from Traulsen as an optional accessory. Increased capacity of the remote condensing unit and line sizing will depend on the length and layout of the connecting piping from the remote condensing unit to the Blast Chill unit. Proper line sizing should be defined by a qualified refrigeration engineer or technician.

### IV. j - SEALING ROLL-IN/ROLL-THRU UNITS:

This section applies only to models TBC1H and TBC1HR. Roll-In and Roll-Thru cabinets set on the floor require the floor area to be flat and level. In addition, after the cabinet is set in place, sealant should be used around the perimeter of the base to comply with NSF International requirements. After sealing the unit, the enclosed ramp should then be installed.

### IV. k - ON/OFF SWITCH:

The Traulsen Blast Chiller models are all equipped with a power ON/OFF switch intended to cut power to the control as needed. In the event of routine maintenance and/or service is needed, be certain to disconnect the electrical power to the machine and follow lockout/tagout procedures.

This is located on top of models TBC1H, towards the rear on top. On model TBC5, this switch is located in the compressor compartment. On model TBC13 this is located on the bottom right behind the front louver assembly.

### V. l - PRINTER PAPER:

Load printer paper as shown in section "V. c" on page 5.

### V. m - CAPACITY:

Pan and approximate maximum product weight capacities for the individual blast chiller models is as follows:

	Pans		Product Weight
	18" x 26"	12" x 20"	
• TBC5	5	10	100
• TBC13	13	26	200
• TBC1H	1 Rack	1 Rack	300

Actual capacity (i.e. weight of product) that can be safely chilled within FDA guidelines varies greatly depending upon individual product density and pan loading.



## V. CARE & MAINTENANCE

**▲ WARNING** Disconnect electrical power supply before cleaning any parts of the unit.

### V. a - CLEANING THE CONDENSER:

The most important thing you can do to insure a long, reliable service life for your Traulsen is to regularly clean the condenser coil. The self-contained condensing unit requires regularly scheduled cleaning to keep the finned condenser clean of lint and dust accumulation. Keeping the condenser clean allows the cabinet to operate more efficiently and use less energy.

To clean the self-contained condenser, first disconnect electrical power. To access the coil:

**TBC5:** Open the refrigeration compartment door on left.

**TBC13:** Remove the four (4) screws securing the front louver panel at bottom and remove the panel.

**TBC1H/TBC1HR:** Remove the two (2) bottom screws securing the louver assembly located on the top/front of the cabinet and lift the louvers.

Vacuum or brush any dirt, lint or dust from the finned condenser coil, the compressor and other cooling system parts. If significant dirt is clogging the condenser fins, use compressed air to blow this clear. For care of the remote condensing unit(s) used for models TBC1H & TBC1HR, consult the manufacturer's product literature.

### V. b - PRINTER SUPPLIES:

Supplies to support the both standard epicon control printers are available directly from our Parts Department, or from your local Hobart Sales and Service Office. In addition it may also be possible to obtain one of these locally. The record printer paper is standard thermal paper which is readily available at most office supply outlets. Specifications are 2-1/2" wide by 85" long:

**Traulsen P/N 400-60003-00**  
**Office Depot #302-224**  
**Staples #PMF-5233**

The label printer uses a special peel-off label stock, Traulsen part number 400-60004-00. Each roll contains 225 labels.

### V. c - INSTALLING PRINTER PAPER:

To reload record or label paper, begin by opening the cover or door to access the printer(s). Remove the empty paper roll and place a new roll on spindle. Position the paper such that the paper feeds from the back of the roll. This allows the thermal sensitive side of the paper to be on the upper surface as it feeds through the printer. The ends of the spindle are installed in the roll holders on each side of the paper cradle.

Gently pull the feed roller tension arm slightly forward. It is located on the top of the printer and will open about 90 degrees.

### V. c - INSTALLING PRINTER PAPER (cont'd):

Feed the paper down into the loading slot directly behind the feed roller tension arm.

Return the feed roller tension arm to its original position. If this is not closed the printer will not operate. Labels are loaded in the same manner. Note after turning the chiller on the label printer will automatically orient the next label for printing.

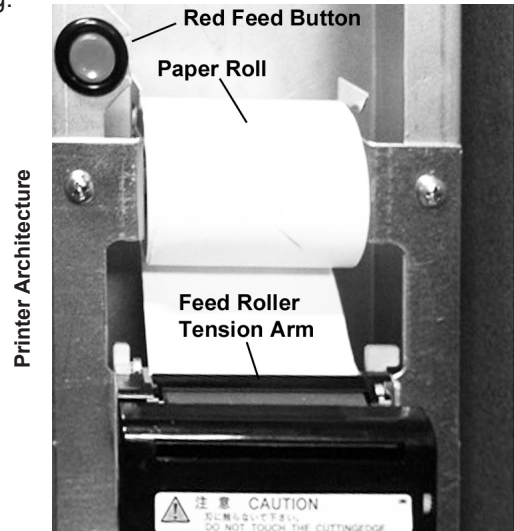

Press the red feed button to feed paper through the printer.

Replace the printer cover or close the printer door, taking care that the paper or label is passed through the paper slot on it's front.

### V. d - REPLACING THE BATTERY:

**▲ WARNING** Battery may explode if mistreated. Do not recharge, disassemble or dispose of in fire.

Replace battery with Panasonic Corp. Part No. CR2032 only. Use of another battery may present a risk of fire or explosion.

Replacement batteries can be obtained from Digi-Key ([www.digikey.com](http://www.digikey.com)), Newark ([www.newark.com](http://www.newark.com)), or other suitable suppliers.

The epicon control includes a battery back-up for the real time clock. Should this ever need to be replaced use the following procedure:

- Step 1: Turn off power to the blast chiller.**
- Step 2: Remove the top & bottom screws that hold the bessel on the blast chiller.**
- Step 3: Carefully pull the assembly out of the cavity.**
- Step 4: Slide the battery out of it's holder, located on the rear bottom of the control board.**
- Step 5: Slide a new battery into the holder, making sure that the positive side of the battery faces up as indicated on the battery holder.**
- Step 6: Install the assembly back in place, tighten the screws to ensure assembly is securely in place.**
- Step 7: Return power to the blast chiller.**

## V. CARE & MAINTENANCE

### V. e - CLEANING THE EXTERIOR:

Exterior stainless steel should be cleaned with warm water, mild soap and a soft cloth. Apply with a dampened cloth and wipe in the direction of the metal grain. Avoid the use of strong detergents and gritty, abrasive cleaners as they may tend to mar and scratch the surface. **NOTICE** Do **NOT** use cleansers containing chlorine, this may promote corrosion of the stainless steel.

Care should also be taken to avoid splashing the unit with water, containing chlorinated cleansers, when mopping the floor around the unit. For stubborn odor spills, use baking soda and water (mixed to a 1 TBSP baking soda to 1 pint water ratio).

### V. f - CLEANING THE INTERIOR:

For cleaning stainless steel interiors, the use of baking soda as described in section "V. d" is recommended. Use on breaker strips as well as door gaskets. All interior fittings are removable without tools to facilitate cleaning.

## VI. OTHER

### VI. a - TBC1H & TBC1HR SERVICE CHECK & START-UP:

After installation and start-up of models TBC1H or TBC1HR, please contact the Service Department at (800) 825-8220 to arrange for a "Mechanical Installation and Operation Inspection," which is required by Traulsen in order to validate the warranty. On-site inspection not required for models TBC5 and TBC13.

### VI. b - SERVICE INFORMATION:

Before calling for service, please check the following:

- Is the electrical cord plugged in?
- Is the fuse OK or circuit breaker on?
- Is the ON/OFF Power Switch in the ON position?

If after checking the above items and the unit is still not operating properly, please contact Traulsen (if under warranty) or an authorized Traulsen service agent. A complete list of authorized service agents was provided along with your Traulsen unit. If you cannot locate this, you may also obtain the name of a service agent from the Service/Contact page of our website: [www.traulsen.com](http://www.traulsen.com).

If service is not satisfactory, please contact our in-house service department at:



Traulsen  
4401 Blue Mound Road  
Fort Worth, TX 76106  
(800) 825-8220

Traulsen reserves the right to change specifications or discontinue models without notice.

## VI. OTHER

### VI. c - THE SERIAL TAG:

The serial tag is a permanently affixed sticker on which is recorded vital electrical and refrigeration data about your Traulsen product, as well as the model and serial number. This tag is located inside the door on the right interior wall of the cabinet.

 FORT WORTH, TX.			
SERIAL	MODEL	PH	
VOLTS	Hz		
TOTAL CURRENT	AMPS		
MINIMUM CIRCUIT	AMPS		
MAXIMUM OVERCURRENT PROTECTION		AMPS	
LIGHTS	WATTS		
HEATERS	AMPS		
REFRIGERANT		TYPE	OZ
DESIGN PRESSURE		HIGH	LOW
REFRIGERANT		TYPE	OZ
DESIGN PRESSURE		HIGH	LOW
<small>370-60294-00 REV (A)</small>			
			

### READING THE SERIAL TAG

- Serial = The permanent ID# of your Traulsen
- Model = The model # of your Traulsen
- Volts = Voltage
- Hz = Cycle
- PH = Phase
- Total Current = Maximum amp draw
- Minimum Circuit = Minimum circuit ampacity
- Lights = Light wattage
- Heaters
- Refrigerant = Refrigerant type used
- Design Pressure = High & low side operating pressures and refrigerant charge
- Agency Labels = Designates agency listings

### VI. d - ON-SITE BLAST CHILL TRAINING:

Traulsen offers the operator comprehensive one and two day, on-site training in the proper operation of your Blast Chiller. Contact your authorized Traulsen equipment dealer for pricing information.

### VI. e - DEMONSTRATIONS:

Traulsen sales representatives perform in-service operational training for the end-user. Contact your local Traulsen Sales Representative (after completion of the service agency start-up, on required models) to arrange this.

## VII. BASIC OPERATING GUIDELINES

### VII. a - CHILLING WITHIN HACCP GUIDELINES:

The current FDA Food Code allows much more time for safe chilling than 90-minutes. This actually requires two critical control points of:

- From 135°F to 70°F within two hours, then...
- From 70°F to below 41°F within four hours, for a total chill time from 135°F to below 41°F of no more than six hours.

Total chill time can exceed six-hours in duration and still be safe. This safety threshold does not include:

- Any time needed for product to chill from any start temp down to 135°F, or...
- Any time elapsed to chill to below 41°F.

### VII. b - LOADING:

To achieve quickest chill times product should be loaded to a depth of no greater than 2" (fig. 1).

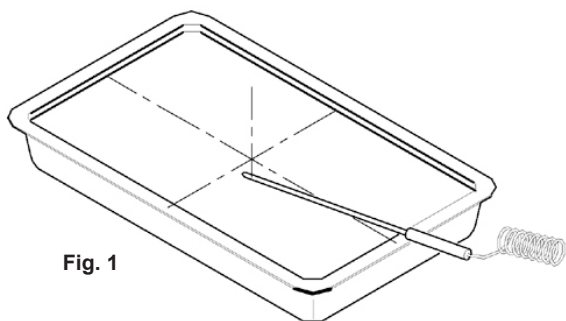

Fig. 1

Products should always be loaded into the shallowest pan possible.

Chilling of products of greater than 2" depth is often possible within FDA guidelines. However please note that actual chill times are a function of: Start Temperature, Product Density, Product Depth, and Total Load.

Chilling of products, such as whole cooked chickens or meatloaf can be accomplished. However these should be positioned inside the chiller to allow the air-flow to contact the greatest surface area of the product.

### VII. c - USE OF FOOD PROBES:

For most accurate results food probes should be used. These need to be properly placed in the center of the thickest part of the product to insure an accurate temperature reading.

Some products are not suitable for use of food probes. These products...

- Should be chilled by **TIME**.
- The correct chill time should be established by the operator based upon actual product testing.
- The end cycle temperature should be verified manually with a clean, accurate thermometer as soon as the pre-established chill time elapses.

### VII. d - COVERING PRODUCT:

Product does not always need to be covered. However before doing so please consider the following potential scenarios...

- If large loads of especially hot product are chilled there is the potential to freeze the coil.
- Loads of uncovered product that require especially long chilling times may have the potential to experience surface drying.
- Loads that are left uncovered in the chiller for long periods after completion of a chill cycle may also experience surface drying of the product if left uncovered.
- Loads of especially liquid product, such as soup, are highly recommended to be covered in order to prevent accidental spillage.
- Some foods, such as rice and pasta, are particularly vulnerable to drying and so should always be covered.

### VII. e - MULTI-BATCHING:

Often an operator may wish to chill less than a full load of product, and/or to chill multiple types of products simultaneously, or at different intervals. This is known as "Multi-Batching."

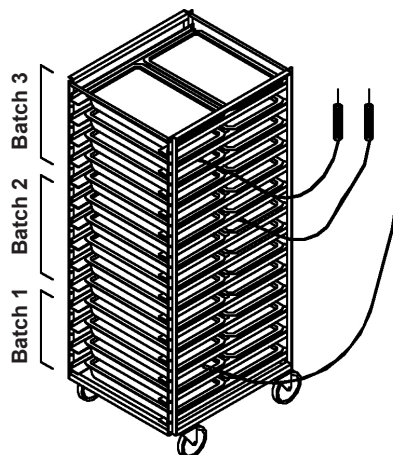

In a multi-batching scenario it is critically important to manage the use of probes. For example if more than four different products need to be chilled, it is necessary to take the following into consideration:

- Like products should be grouped together in a single batch using one probe.
- Different products, or products started at different times should each have their own probe.
- If more than three products will ultimately be placed in the chiller at the same or different times, it will be necessary to: a) group like products together, or b) group unlike products together with the probe placed in the product which will take the longest to chill.

In the latter scenario the easier to chill product will be safely chilled by default.



## VIII. THE EPICON CONTROL

### VIII. a - THE EPICON CONTROL - OVERVIEW:

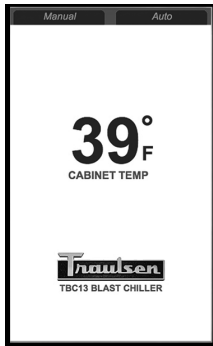

The Idle Screen  
(Indicates the chiller is in  
hold mode)

Traulsen blast chillers are equipped with our exclusive epicon control. This has a durable, water resistant, touch screen interface for ease of use, and is surrounded by a heavy gauge metal frame to protect it from damage.

The epicon control can be used in one of two distinct operating modes: **AUTO** or **MANUAL**.

### VIII. b - MODES OF OPERATION:

The first mode of operation is **AUTO**. This is designed to start a chill cycle whenever one or more probes is placed into product above 90 degrees F, insuring proper operation.

**MANUAL** is a fully adjustable mode which allows the operator to select from a wide range of chill settings.

### VIII. c - CHILL PROGRAMS:

Within the **AUTO** and **MANUAL** modes of operation, the operator can select that the chill cycle be regulated by either product core temperature, time, or by a previously prepared recipe.



Temp: Cycle ends upon reaching target temp.



Time: Cycle ends upon time elapsing.



Product: Chill according to an previously saved product "recipe."

### VIII. d - OPERATING METHODS:

The EPICON control also allows the operator to select from different cycle types, including Standard, Speed, Energy and Delicate.



Standard: Basic blast chill or freeze cycle.



Speed: Provides for fastest possible chilling.



Energy: Slightly slower chilling in a more energy efficient manner.



Delicate: Chill products prone to freezing with warmer, slower air.

### VIII. e - MAINTENANCE MODE:

At the end of every chill or freeze cycle the blast chiller will automatically switch to MAINTENANCE MODE. In this mode the cabinet will revert to a holding cabinet, where it will maintain an air temperature consistent with the target temperature. For example if the target temp was set at

### VIII. e - MAINTENANCE MODE:

37°F than the hold temp will be 37°F. If the target temp was 0°F than the hold temp will be 0°F.

Regardless of cycle type or target temperature, after pressing **DONE** for all probes or zones the chiller will automatically operate in **IDLE MODE** at 37°F.

### VIII. f - THE TOOL BOX:



The toolbox allows the operator to adjust default operating parameters, update control software, retrieve past chill cycle data, monitor chiller operation, and make use of service diagnostics.

To access the **TOOLBOX** features press the toolbox icon on the **MANUAL** menu. The **SECURITY LEVEL** screen will appear (fig. 2). Some areas of the control are password protected. Selecting a secure area will prompt a keyboard to appear on the display.

#### Factory Default Passwords

- **USER: No password**
- **SUPERVISOR: 1234\***
- **SERVICE: 4401**

\*Can be changed if needed.

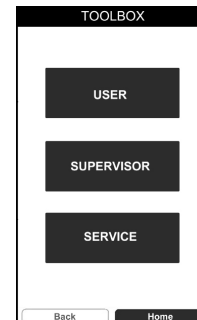

Fig. 2

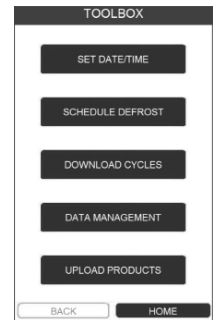

Fig. 3

The most common operations are included inside the non password protected **USER MENU** (fig. 3).

### VIII. g - FOOD PROBES:



Three food probes are provided, numbered 1 thru 3 to help the operator identify different products and/or batches. Each probe's activity status is indicated on the display as:

**INACTIVE:** Probe is available for placing in hot product.

**ACTIVE:** Probe has been inserted into hot product, but chill cycle has not yet been started.

**IN USE:** Cycle in progress, product core temperature is displayed underneath the probe icon on the run screen.

**DONE:** Displayed on the RUN screen, this indicates that it's cycle has been completed and product is ready to remove.

### VIII. h - USB PORT:

A standard USB data port is provided. This allows the operator to download chill cycle data on to a thumb drive for easy transfer to a PC. It is also used to update the control's operating software.

## VIII. THE EPICON CONTROL

### VIII. i - TIME ZONES:

When chilling without probes the epicon control allows for operation by an operator determined time. In the **TIME** program there are three time zones provided which make multi-batching possible.



Selecting a time zone permits entry of both a product and/or user name, just as is done when using probes.

The zones are not specific to any location or number of pans in the chiller. The operator should determine how best to utilize these, for example Zone 1 = Top, Zone 2 = Middle, etc.

### VIII. j - USER NAMES:



**USER** (i.e. operator) names can be programmed into the chiller memory using the **TOOLBOX**. If a user name is selected at the beginning of a chill cycle it will appear under the **USER** icon on the **RUN SCREEN**, as well as on any record or label printouts for that chill cycle.

If no **USER** name is selected at the beginning of a chill cycle **NO USER** will appear under the **USER** icon on the **RUN SCREEN**, as well as on any record or label printouts for that chill cycle.

At the end of the chill cycle a **USER** name may be entered prior to printing by pressing **DONE** and then the space marked **BLANK** next to user.

### VIII. k - PRODUCT NAMES:



**PRODUCT** names can be programmed into the chiller memory using the **TOOLBOX**. If a product name is selected at the beginning of a chill cycle it will appear under the **PRODUCT** icon on the **RUN SCREEN**, as well as on any record or label printouts for that chill cycle.

If no **PRODUCT** name is selected at the beginning of a chill cycle **NO PRODUCT** will appear under the **PRODUCT** icon on the **RUN SCREEN**, as well as on any record or label printouts for that chill cycle.

At the end of the chill cycle a **PRODUCT** name may be entered prior to printing by pressing **DONE** and then the space marked **BLANK** next to **FOOD PRODUCT**.

### VIII. l - RECORD & LABEL PRINTERS:

At the end of any chill cycle the epicon control allows the operator to print cycle data and/or print an adhesive label for the product container (on models equipped with the optional label printer). The label printer provides a condensed "**LABEL**" type of report with both **PRODUCT** and **USER** information.

## IX. OPERATION

### IX. a - BASIC OPERATION - AUTO:

Begin by pressing **AUTO** from the idle screen or simply insert a probe into hot product. Upon sensing hot product, the control will begin a 30-second count down to auto-start, at which time the chiller will begin a chill cycle in standard mode with a default end point of 37°F.

**NOTE:** Food must be above 90°F in order to **AUTO** start.

Before start, the operator can press any active probe in order to add their name, and/or the product name, to the cycle data.

When adding probes to a chill cycle already in process simply place any available probe into hot product above 90°F and these will be automatically added. Please note however that when doing so the **USER** and **PRODUCT** names cannot be added until cycle's end.

### IX. b - BASIC OPERATION - MANUAL:

**MANUAL** mode allows adjustments to be made to all chilling parameters, thus customizing the cycle to best suit the product and/or process.

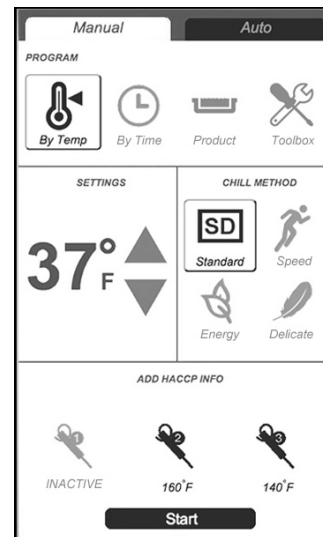

To start a chill cycle using **MANUAL** mode...

- 1) Begin by pressing **MANUAL** from the idle screen.
- 2) If all displayed parameters are OK press any active **PROBE** (indicated by a temperature displayed below highlighted probe icon) to enter the **PRODUCT** and **USER** names and either:
  - a- enter the **PRODUCT** and **USER** names, or...
  - b- press **SKIP** for both **PRODUCT** and **USER**.
- 3) Press **START** to begin a chill cycle using the factory default parameters.

## IX. OPERATION (cont'd.)

### IX. b - BASIC OPERATION - MANUAL (cont'd):

If parameters are not OK manually program the chill cycle using the following procedure:

1) Begin by choosing from **TEMP**, **TIME**, or **PRODUCT**.

**NOTE:** Selecting **PRODUCT** prompts a list of chill recipes to appear on the display. Select a product from the list and press **START** to start the chill cycle using the parameters set up for that specific product.

2) Adjust the **SETTINGS**. These are the desired end-point temperature (adjustable from +40 to -5°F or chill time (adjustable from 5-minutes to 6-hours, in 5-minute intervals).

3) Select a chill **METHOD**. Choose from **STANDARD**, **SPEED**, **ENERGY** or **DELICATE**.

4) Press any active **PROBE** (indicated by a temperature displayed below highlighted probe icon) to enter the **PRODUCT** and **USER** names.

5) Press **START** to begin a chill cycle using the selected parameters.

**NOTE:** If programming is stopped at any point prior to pressing **START** the control will timeout in 2-minutes. The blast chiller will first return to the **IDLE MODE** and then **AUTO** start a chill cycle if one or more probes had been placed in product above 90°F.

### IX. c - PRINTING:

When any probe reaches its designated target temperature (or when the time of any zone elapses), the blast chiller will beep for 20-seconds indicating that the cycle has completed. The control display will show **DONE** beneath this probe or zone.

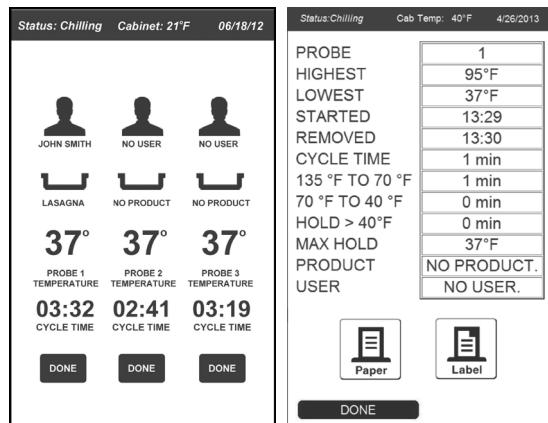

Press **DONE** and the the control will display the PRINT screen. The operator can then select...

### IX. c - PRINTING:

**NO PRODUCT:** to add a product name to the cycle data.

**NO USER:** to add a user names to the cycle data.

**PAPER:** to receive a cycle data printout.

**LABEL:** to receive an adhesive lable for the product container.

After printing, press **DONE** to move on to any remaining probes which require printing, or to return to the run or idle screens.

### IX. d - ADDING PRODUCT TO A CYCLE IN PROGRESS:

Additional products can be added to chill cycles already in progress when using either the **AUTO** or **MANUAL** mode.

For cycles started using either **AUTO** or **MANUAL**, simply insert an available probe into the new hot product to be added. The chiller will automatically add this probe to the cycle.

This can be repeated as long as there remains an available probe or zone to use with the new product.

### IX. e - FREEZING PRODUCT:

Freezing is done using the **MANUAL** mode. From the **MANUAL** programming screen...

1) Begin by inserting a probe into the product(s) to be frozen.

2) Press **MANUAL** then **TEMP**.

3) Adjust **SETTINGS** to desired target temp.

4) Select **METHOD** if other than **STANDARD** is needed.

5) Select active **PROBE**. Add operator and product name if desired.

6) Press **START**.

**NOTE:** Upon cycle completion the chiller will automatically enter "Maintenance Mode" at the target temperature.

## IX. OPERATION (cont'd.)

### IX. f - ENTERING PRODUCT/USER NAMES AT CYCLE START:

The epicon control provides two opportunities to enter both the product and operator's name. One at the beginning of the cycle, and the other at the end of the cycle. This varies by **OPERATING MODE**.

#### USING AUTO MODE

Prior to cycle start, press any active probe (by temp) or zone (by time) on the **MAIN MENU** screen in order to access the Product/Operator Name Entry Screen, shown below.

The screenshot shows the 'Manual' and 'Auto' tabs at the top. Below the 'Auto' tab, there is a 'PRODUCT NAME' field with a dropdown arrow. Below this is a 'SELECT PRODUCT' button and a 'CLEAR' button. Further down is a 'USER NAME' field with a dropdown arrow, a 'SELECT USER' button, and a 'CLEAR' button. At the bottom is a 'SAVE/SKIP' button.

Pressing either **SELECT PRODUCT** or **SELECT USER** will prompt a drop down list of products or users to choose from, shown below.

The screenshot shows a dropdown menu for 'USER NAME'. The menu lists several names: Acel Blas, Ana Flores, Andres Bolivar, Anselimo McLaren, Hector Calvo, and Henry Crespo. There are up and down arrow buttons on the right side of the list.

Select the **PRODUCT** then **USER** names. Once done the control will automatically return to the **AUTO**, **MANUAL** or **RUN** screen. At the end of the cycle this information will be displayed on the Print Screen and included on any **RECORD** and/or **LABEL** printouts.

#### USING MANUAL MODE

Prior to cycle start, press any active probe (by temp) or time zone (by time) on the **MAIN MENU** screen in order to access the Product/Operator Name Entry Screen, shown below.

The screenshot shows the 'Manual' and 'Auto' tabs at the top. Below the 'Manual' tab, there is a 'PRODUCT NAME' field. Below this is a 'CLEAR' button and a keyboard with letters QWERTYUIOP, ASDFGHJKL, ZXCVBNM, SPACE DEL, and numbers 1-0. At the bottom are 'SEARCH' and 'SKIP/ENTER' buttons.

The screenshot shows the 'Manual' and 'Auto' tabs at the top. Below the 'Manual' tab, there is a 'USER NAME' field with a person icon. Below this is a 'CLEAR' button and a keyboard with letters QWERTYUIOP, ASDFGHJKL, ZXCVBNM, SPACE DEL, and numbers 1-0. At the bottom are 'SEARCH' and 'SKIP/ENTER' buttons.

A keyboard will appear on the display. Type in the **PRODUCT** name using the keyboard or press **SEARCH** to select an existing name from a drop down list of products. Press **ENTER** when done.

Another keyboard will appear on the display. Type in the **USER** name using the keyboard or press **SEARCH** to select an existing name from a drop down list of products. Press **ENTER** when done.

Once done the control will automatically return to the **AUTO**, **MANUAL** or **RUN** screen. At the end of the cycle this information will be displayed on the Print Screen and included on any **RECORD** and/or **LABEL** printouts.

## IX. OPERATION (cont'd.)

### IX.g - ENTERING PRODUCT/USER NAMES AT CYCLE END:

The epicon control provides two opportunities to enter both the product and operator's name. One at the beginning of the cycle, and the other at the end of the cycle. This varies by **OPERATING MODE**.

At cycle end press **DONE** to access the Print Screen. Press **FOOD PRODUCT** and/or **USER** to prompt a keyboard with which to enter information for each, shown below.



Press **ENTER** when done. The control will automatically return to the **PRINT** screen where the entered information will now be displayed. It will also be included on any **RECORD** and **LABEL** printouts.

### IX.h - UPDATING SOFTWARE:

Updates to the operating software will occasionally become available, usually via e-mail or web download. The update file should be saved to the root directory of the thumb drive.

To update the operating software...

- 1) Place thumb drive into the chiller's USB data port.
- 2) Press **MANUAL - TOOL BOX - SERVICE**.
- 3) Type in your password. Note the factory default password is **4401**.
- 4) Update the appropriate software
- 5) Restart the chiller when prompted.

### IX.i - SAVING RECIPES:

Individual chill recipes can be saved to memory for later retrieval. To create and save a recipe to the **PRODUCT** menu...



- 1) Press **MANUAL** then **PRODUCT**.
- 2) Select **NEW PRODUCT** from the drop down menu.
- 3) A keyboard will appear. Type in the product's name and press **ENTER**.
- 4) Select chill by **TEMP** or **TIME**.
- 5) Adjust **SETTINGS** and select **CHILL METHOD**.
- 6) Press **SAVE**.

The control will return to the **IDLE** screen.

Factory preloaded recipes include:

- **CHICKEN**
- **CHICKEN (SPEED MODE)**
- **CHICKEN (ENERGY MODE)**
- **TOSSED SALAD**
- **FROZEN LASAGNA**
- **FROZEN LASAGNA (SPEED MODE)**
- **FROZEN LASAGNA (ENERGY MODE)**
- **MIXED VEGETABLES**
- **MIXED VEGETABLES (ENERGY MODE)**
- **CHICKEN NUGGETS**

### IX.j - CANCELLING A CHILL CYCLE:

Should you wish to cancel an active chill cycle in progress, press **CANCEL** underneath the desired **PROBE** or **ZONE**. Doing so does not cancel any other batches in progress. If you wish to cancel all active batches press **CANCEL** for each active **PROBE** or **ZONE**.

**NOTE:** When cancelling a batch all of its chill cycle data will be lost.



## IX. OPERATION (cont'd.)

### IX. k - UNDERSTANDING THE RUN SCREEN:

The **RUN** screen appears on the display during any active chill cycle. It provides the operator with important in-cycle data intended to aid with managing multiple batches.

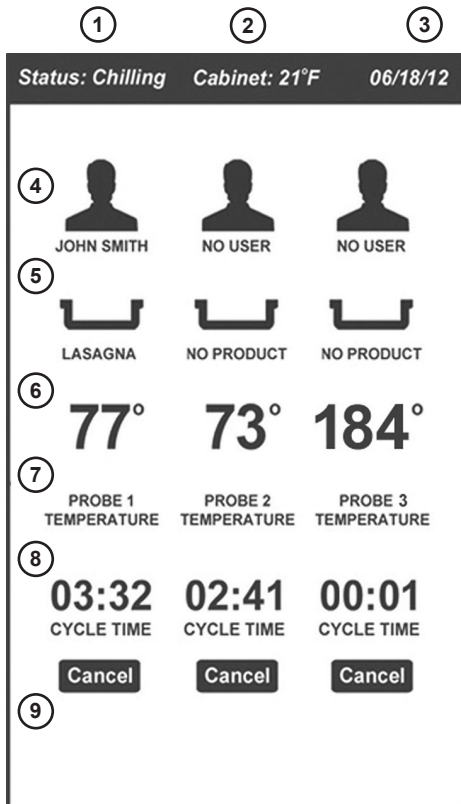

- 1) **Operation Status:** Chilling or Hold
- 2) **Actual Cabinet Air Temperature**
- 3) **Today's Date**
- 4) **Operator Name:** default NO USER
- 5) **Product Name:** default NO PRODUCT
- 6) **Current Product Core Temperature**
- 7) **Probe Number:** 1 - 2 - 3
- 8) **Time Elapsed Since Cycle Start**
- 9) **Cancel Button**

### IX. l - DELETING RECIPES:

The epicon control also allows for existing chill recipes in the product menu to be deleted if desired. To do so...

- 1) Select **MANUAL**
- 2) Select **TOOLBOX**
- 3) Select **SUPERVISOR** (password 1234)
- 4) Select **DELETE RECIPES**. A list of all recipes is displayed.
- 5) Select the recipes you want to delete (these will turn red when selected).
- 6) Press **DELETE**
- 7) Press **RETURN** to exit

## X. TOOLBOX FEATURES

### X. a - ACCESSING THE TOOLBOX:

From the **MANUAL** menu screen press the **TOOLBOX** icon.

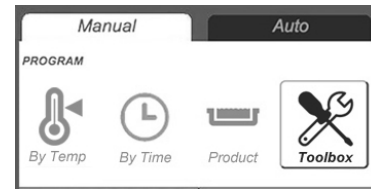

The control will now display the **TOOLBOX** access menu (fig. 1).

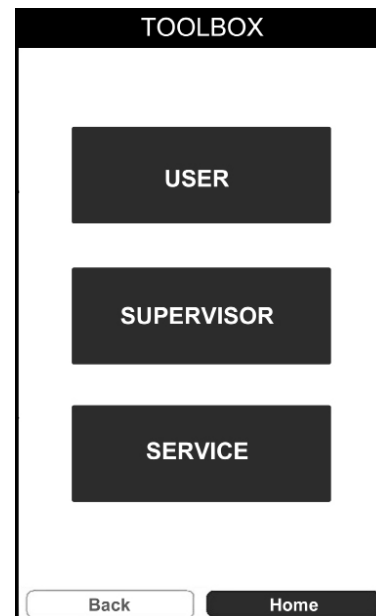

Fig. 1

Press **USER** for operator level access (fig. 2).

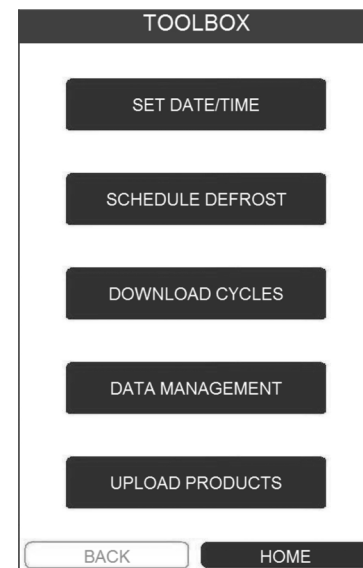

Fig. 2

This level allows you to: Set the Clock, Adjust Defrost Time and Settings, Download Cycle Data, Search Chill Cycle History, and Upload Recipes to the **PRODUCT** menu.

## X. TOOLBOX FEATURES (cont'd)

### X. a - ACCESSING THE TOOLBOX (cont'd):

Press **SUPERVISOR** for supervisor access. Note that this not intended for every day access and adjustments and so is password protected (fig. 3). Enter your access code to proceed. The factory default code is **1234**. This can be changed in the **SUPERVISOR** level.

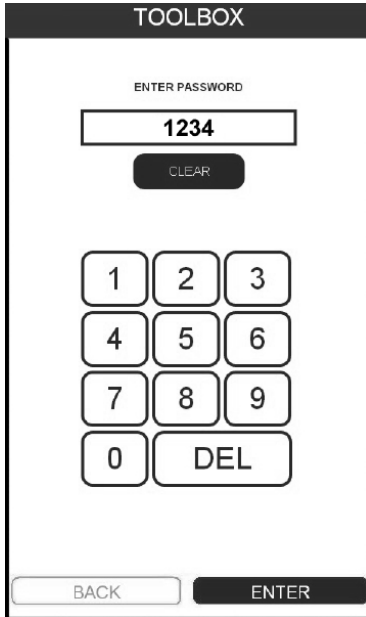

Fig. 3

Press **SERVICE** to access the service menu. Note that this is password protected. In the event you need to access this **TOOLBOX** level please contact the Traulsen Service Department at (800) 825-8220 to obtain a valid access code.

### X. b - USER MENU, SETTING THE CLOCK:

Begin by pressing **MANUAL - TOOLBOX - USER**, then press **SET DATE/TIME**. The display will change to the **SET DATE/TIME** screen (fig. 4).

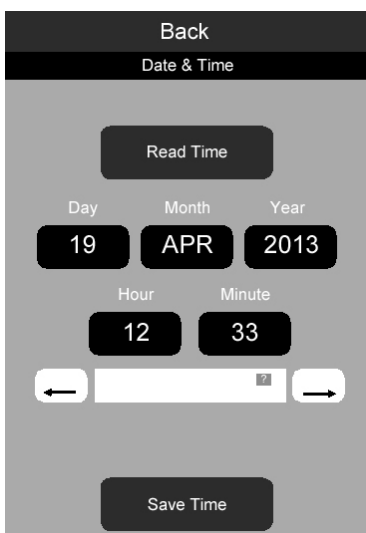

Fig. 4

### X. b - USER MENU, SETTING THE CLOCK (cont'd):

To adjust the Date and time settings:

- 1) Press **DAY - MONTH - YEAR - HOUR - MINUTE** as needed (after doing so the field will be highlighted).
- 2) Toggle the LEFT/RIGHT arrows at bottom to adjust this parameter
- 3) Proceed to the next parameter.
- 4) Press **SAVE TIME** to save these settings.

### X. c - USER MENU, ADJUSTING DEFROST SETTINGS:

The **DEFROST** menu allows you to adjust both the start time and interval (hours) between defrost cycles in order to better suit operational requirements. Defrost cycles are preset from the factory to occur every six-hours.

To adjust the defrost settings, begin by pressing **MANUAL - TOOLBOX - USER**, then press **SCHEDULE DEFROST**. The display will change to the **DEFROST** screen (fig. 5).

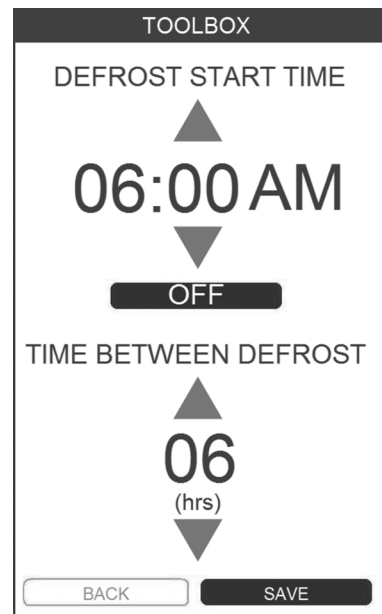

Fig. 5

Should you wish to adjust the time of day that the first defrost cycle occurs press the UP or DOWN arrows to set the **DEFROST START TIME** then press the **OFF** button. It will change to indicate that this feature is **ON**.

You may also adjust the interval between defrost cycles by pressing the UP or DOWN buttons under **TIME BETWEEN DEFROST**

Press **SAVE** to lock-in these settings.

### X. d - USER MENU, DOWNLOAD CYCLE DATA:

Begin by inserting a formatted thumb drive into the USB port. Press **MANUAL - TOOLBOX - USER**, then press **DOWNLOAD CYCLES**. All cycle data in the control's memory will be downloaded to the thumb drive.

## X. TOOLBOX FEATURES (cont'd)

### X. e - USER MENU, SEARCH CHILL CYCLE HISTORY:

The **DATA MANAGEMENT** feature allows you to retrieve cycle data memory within a selected a date range (beginning/end) for printing or downloading to a thumb drive. To access the **DATA MANAGEMENT** feature begin by pressing **MANUAL - TOOLBOX - USER**, then press **DATA MANAGEMENT**. The **DATA MANAGEMENT** screen will appear (fig. 6).

The screenshot shows the 'TOOLBOX' screen with two input fields for dates. The first field is labeled 'ENTER START DATE (MM/DD/YYYY)' and the second is 'ENTER STOP DATE (MM/DD/YYYY)'. Below these fields is a numeric keypad with buttons for digits 1-9, 0, and a slash (/). There are also 'DEL' and '/' buttons. At the bottom, there are 'BACK' and 'SEARCH' buttons.

Fig. 6

Enter the **START** and **STOP** dates in a **MM/DD/YYYY** format to establish the search range, then press **SEARCH** (see fig. 7).

The screenshot shows the 'TOOLBOX' screen with the date range entered. The 'ENTER START DATE (MM/DD/YYYY)' field contains '01/17/2013' and the 'ENTER STOP DATE (MM/DD/YYYY)' field contains '04/23/2013'. The numeric keypad and 'BACK'/'SEARCH' buttons are also visible.

Fig. 7

### X. e - USER MENU, SEARCH CHILL CYCLE HISTORY:

The selected data will appear on the display. You can select one or more items from the list by pressing the appropriate cycles (s) or print/export all shown (fig. 8).

The figure shows two screenshots of the 'TOOLBOX' screen. The left screenshot shows a list of cycle data with a 'Paper' icon and an 'EXPORT ALL' button. The right screenshot shows the same list with some items selected (indicated by a grey background) and an 'EXPORT SELECTED' button. Both screens have a 'BACK' button at the bottom.

Fig. 8

Press **PAPER** to print a record of all displayed or selected cycles.

Press **LABEL** to print an adhesive label of all displayed or selected cycles.

Press **EXPORT SELECTED** or **EXPORT ALL** to load all the selected or displayed cycles to a thumb drive through the USB port (a thumb drive must be loaded).

This data is saved to a csv type file and can be opened as an EXCEL spreadsheet (fig. 9).

Press **BACK** when done to exit.

### X. f - USER MENU, UPLOADING RECIPES:

Begin by inserting a thumb drive containing properly formatted recipes into the USB Port. Press **MANUAL - TOOLBOX - USER**, then press **PRODUCTS**. The recipes will be transferred to the **PRODUCT** menu.

ID Probe or Zone	User name	Product name	Start date	Start time	End date	End time	Cycle time	Min temp	Max temp	Time to 70F	Time to 40F	
3	1	CHARLES	Chicken	Tue Apr 09 2013	08.59.40	Tue Apr 09 2013	12.30.14	03.30.34	35	187	97	118

Fig. 9

## IX. GLOSSARY OF ICONS



By **TEMPERATURE** chill mode



Food **PROBE**, numbered 1-2-3



By **TIME** chill mode



**PRODUCT** name



The **TOOLBOX**



**DEFROST** cycle in progress



**STANDARD** chill method



By **PRODUCT** chill mode



**SPEED** chill method



Print **RECORD**

Paper



**DELICATE** chill method



Print **LABEL**

Label



**ENERGY** chill method



Time **ZONE**, numbered 1-2-3



**USER** name

## XII. TROUBLESHOOTING

SYMPTOM	POTENTIAL CAUSE	SOLUTION
1. No display on control.	<ul style="list-style-type: none"> <li>a. No power to unit.</li> <li>b. System problem.</li> </ul>	Check power supply and circuit breaker. Call for service.
2. Batch requires too much time to chill product down target temperature or time.	<ul style="list-style-type: none"> <li>a. Door not closed properly.</li> <li>b. Too much product loaded.</li> <li>c. Product depth in pan exceeds 2".</li> <li>d. Pan been covered with a lid, plastic wrap or foil, and is this not in direct contact with the product.</li> <li>e. Product loaded is of a high density.</li> <li>f. Dirty condenser coil.</li> <li>g. Evaporator coil iced.</li> </ul>	Close door completely. Adjust the load to not exceed capacity of the unit. Reduce pan load. Cover product correctly.  Allow additional chilling time. Clean condenser coil. Allow chiller to defrost.
3. Auto mode does not appear to work when placing probe in hot product.	<ul style="list-style-type: none"> <li>a. Probe not available.</li> <li>b. Probe not placed in product.</li> <li>c. Food probe placed in product below 90° F.</li> <li>d. Damaged or defective food probe.</li> </ul>	Press DONE to release probe for use. Place probe in product. Manually program cycle and select probe. Replace with new food probe.
4. Chill cycle starts with no product present	<ul style="list-style-type: none"> <li>a. Door open.</li> <li>b. Hot product inside but no probe placed.</li> </ul>	Close door. Press CANCEL then place probe to start cycle.
5. Unwanted product freezing.	<ul style="list-style-type: none"> <li>a. Previously chilled product not removed.</li> <li>b. Chill cycle By Time set for too long.</li> <li>c. High water content food (ex. soup).</li> </ul>	Remove DONE product before starting a new chill cycle. Reduce cycle time. Use DELICATE method.
6. Food drying out during chilling.	<ul style="list-style-type: none"> <li>a. Food chilled uncovered.</li> </ul>	Cover food before placing in chiller.
7. Printer not printing.	<ul style="list-style-type: none"> <li>a. Printer is out of paper.</li> <li>b. Printer paper installed incorrectly.</li> <li>c. Paper does not feed or jammed.</li> </ul>	Replace printer paper. Reload paper with the thermal side up. Remove paper and reinstall correctly.
8. Condensation on exterior surface.	<ul style="list-style-type: none"> <li>a. Door out of alignment or gasket issue.</li> <li>b. Door sweep worn/out of adjustment (TBC1H).</li> <li>c. Electric door heater malfunction.</li> </ul>	Check door alignment and gasket for proper seal. Adjust/replace door sweep. Call for service.
9. Upon starting a chill cycle, the product temperature displayed appears cooler than expected (cooked) temperature.	<ul style="list-style-type: none"> <li>a. Varied product temps within batch.</li> <li>b. Probe placed incorrectly.</li> <li>c. Small mass product (ex. chicken tender).</li> <li>d. Product held at room temp too long.</li> </ul>	Verify actual product temp using a manual thermometer. Relocate probe. Use chill by time. Verify actual product temp using a manual thermometer.



### **XIII. WARRANTY INFORMATION**

#### **STANDARD DOMESTIC WARRANTY**

TRAULSEN warrants new equipment to the original purchaser, when installed within the United States against defective material and workmanship for three (3) years from the date of original installation. Under this warranty, TRAULSEN will repair or replace, at its option, including service and labor, all parts found to be defective and subject to this warranty. Warranty term begins upon date of installation, the date of End User Invoice or the date of Dealer Invoice, whichever is proven to occur latest, not to exceed 18 months from Dealer Invoice date (the "Warranty Period"). Warranty excludes components that are removable without tools.

The compressor part (self-contained only) is warranted for an additional two (2) years. During this period TRAULSEN will supply replacement compressor(s) if deemed defective, however, all installation, recharging and repair costs will remain the responsibility of the owner.

This warranty does not apply to damage resulting from fire, water, burglary, accident, abuse, misuse, transit, acts of God, terrorism, attempted repairs, improper installation by unauthorized persons, and will not apply to food loss.

**THERE ARE NO ORAL, STATUTORY OR IMPLIED WARRANTIES APPLICABLE TO TRAULSEN, INCLUDING BUT NOT LIMITED TO, ANY IMPLIED WARRANTY OF MERCHANTABILITY OR FITNESS FOR ANY PARTICULAR PURPOSE WHICH EXTEND BEYOND THE DESCRIPTION ON THE FACE HEREOF. TRAULSEN SHALL HAVE NO OBLIGATION OR LIABILITY FOR CONSEQUENTIAL OR SPECIAL DAMAGES, GROWING OUT OF OR WITH RESPECT TO THE EQUIPMENT OR ITS SALE, OPERATION OR USE, AND TRAULSEN NEITHER ASSUMES NOR AUTHORIZES ANYONE ELSE TO ASSUME FOR IT ANY OBLIGATION OR LIABILITY IN CONNECTION WITH THE EQUIPMENT OR ITS SALE, OPERATION OR USE OTHER THAN AS STATED HEREIN.**

**THIS WARRANTY IS IN LIEU OF ALL OTHER WARRANTIES EITHER EXPRESSED OR IMPLIED AND CONSTITUTES TRAULSEN'S FULL OBLIGATION AND LIABILITY. WARRANTIES NOT AVAILABLE ON REMOTE MODELS.**

#### **INTERNATIONAL COMMERCIAL WARRANTY**

TRAULSEN warrants to the original purchaser the Refrigeration Equipment manufactured and sold by it to be free from defects in material and workmanship under normal use and service for a period of one (1) year from date of shipment. Under this warranty, **TRAULSEN** will reimburse the purchaser for the replacement of any part of said equipment (excluding dryers & refrigerant gas) which then proves to be defective. **This warranty does not apply to damage resulting from fire, water, burglary, accident, abuse, misuse, transit, acts of God, terrorism, attempted repairs, improper installation by unauthorized persons, and will not apply to food loss.**

TRAULSEN'S standard warranty does not apply to Export Sales. Rather, for a period of one (1) year from date of original installation not to exceed Fifteen (15) months from date of shipment from factory, TRAULSEN will, at Traulsen's sole discretion, replace, F.O.B. factory, any defective parts normally subject to warranty and will not cover the cost of packing, freight or labor such costs being the sole responsibility of the dealer.

**THERE ARE NO ORAL, STATUTORY OR IMPLIED WARRANTIES APPLICABLE TO TRAULSEN, INCLUDING BUT NOT LIMITED TO, ANY IMPLIED WARRANTY OF MERCHANTABILITY OR FITNESS FOR ANY PARTICULAR PURPOSE WHICH EXTEND BEYOND THE DESCRIPTION ON THE FACE HEREOF. TRAULSEN SHALL HAVE NO OBLIGATION OR LIABILITY FOR CONSEQUENTIAL OR SPECIAL DAMAGES, GROWING OUT OF OR WITH RESPECT TO THE EQUIPMENT OR ITS SALE, OPERATION OR USE, AND TRAULSEN NEITHER ASSUMES NOR AUTHORIZES ANYONE ELSE TO ASSUME FOR IT ANY OBLIGATION OR LIABILITY IN CONNECTION WITH THE EQUIPMENT OR ITS SALE, OPERATION OR USE OTHER THAN AS STATED HEREIN.**

**THIS WARRANTY IS IN LIEU OF ALL OTHER WARRANTIES EITHER EXPRESSED OR IMPLIED AND CONSTITUTES TRAULSEN'S FULL OBLIGATION AND LIABILITY. WARRANTIES NOT AVAILABLE ON REMOTE MODELS.**



Quality Refrigeration

**Traulsen**

4401 Blue Mound Road Fort Worth, TX 76106  
Phone: (800) 825-8220 Fax-Svce: (817) 740-6757  
Website: [www.traulsen.com](http://www.traulsen.com)

**HOURS OF OPERATION:**

Monday thru Friday 7:30 am - 4:30 pm CST

© 2013 Traulsen - All Rights Reserved

## Free Manuals Download Website

<http://myh66.com>

<http://usermanuals.us>

<http://www.somanuals.com>

<http://www.4manuals.cc>

<http://www.manual-lib.com>

<http://www.404manual.com>

<http://www.luxmanual.com>

<http://aubethermostatmanual.com>

Golf course search by state

<http://golfingnear.com>

Email search by domain

<http://emailbydomain.com>

Auto manuals search

<http://auto.somanuals.com>

TV manuals search

<http://tv.somanuals.com>