

ViewSonic®



VC3D2 3D Full HD Camcorder User Guide

IMPORTANT: Please read this User Guide to obtain important information on installing and using your product in a safe manner, as well as registering your product for future service. Warranty information contained in this User Guide will describe your limited coverage from ViewSonic Corporation, which is also found on our web site at <http://www.viewsonic.com> in English, or in specific languages using the Regional selection box in the upper right corner of our website. "Antes de operar su equipo lea cuidadosamente las instrucciones en este manual"

Model No. VS14308

Compliance Information

FCC Statement

This device complies with part 15 of FCC Rules. Operation is subject to the following two conditions: (1) this device may not cause harmful interference, and (2) this device must accept any interference received, including interference that may cause undesired operation.

This equipment has been tested and found to comply with the limits for a Class B digital device, pursuant to part 15 of the FCC Rules. These limits are designed to provide reasonable protection against harmful interference in a residential installation. This equipment generates, uses, and can radiate radio frequency energy, and if not installed and used in accordance with the instructions, may cause harmful interference to radio communications. However, there is no guarantee that interference will not occur in a particular installation. If this equipment does cause harmful interference to radio or television reception, which can be determined by turning the equipment off and on, the user is encouraged to try to correct the interference by one or more of the following measures:

- Reorient or relocate the receiving antenna.
- Increase the separation between the equipment and receiver.
- Connect the equipment into an outlet on a circuit different from that to which the receiver is connected.
- Consult the dealer or an experienced radio/TV technician for help.

Warning: You are cautioned that changes or modifications not expressly approved by the party responsible for compliance could void your authority to operate the equipment.

For Canada

- This Class B digital apparatus complies with Canadian ICES-003.
- Cet appareil numérique de la classe B est conforme à la norme NMB-003 du Canada.

CE Conformity for European Countries



The device complies with the EMC Directive 2004/108/EC and Low Voltage Directive 2006/95/EC.

Following information is only for EU-member states:

The mark is in compliance with the Waste Electrical and Electronic Equipment Directive 2002/96/EC (WEEE).

The mark indicates the requirement NOT to dispose the equipment including any spent or discarded batteries or accumulators as unsorted municipal waste, but use the return and collection systems available.

If the batteries, accumulators and button cells included with this equipment, display the chemical symbol Hg, Cd, or Pb, then it means that the battery has a heavy metal content of more than 0.0005% Mercury or more than, 0.002% Cadmium, or more than 0.004% Lead.



Important Safety Instructions

1. Read these instructions completely before using the equipment.
2. Keep these instructions in a safe place.
3. Heed all warnings.
4. Follow all instructions.
5. Do not use this equipment near water. Warning: To reduce the risk of fire or electric shock, do not expose this apparatus to rain or moisture.
6. Clean with a soft, dry cloth.
7. Do not block any ventilation openings. Install the unit in accordance with the manufacturer's instructions.
8. Do not install near any heat sources such as radiators, heat registers, stoves, or other devices (including amplifiers) that produce heat.
9. Do not defeat the safety purpose of the polarized or grounding-type plug. A polarized plug has two blades with one wider than the other. A grounding type plug has two blades and a third grounding prong. The wide blade and the third prong are provided for your safety. If the provided plug does not fit into your outlet, consult an electrician for replacement of the obsolete outlet.
10. Protect the power cord from being walked on or pinched particularly at plugs. Convenience receptacles and the point where they exit from the unit. Be sure that the power outlet is located near the unit so that it is easily accessible.
11. Only use attachments/accessories specified by the manufacturer.
12. Use only with the cart, stand, tripod, bracket, or table specified by the manufacturer, or sold with the unit. When a cart is used, use caution when moving the cart/unit combination to avoid injury from tipping over. 
13. Unplug this unit when unused for long periods of time.
14. Refer all servicing to qualified service personnel. Servicing is required when the unit has been damaged in any way, such as: if the power-supply cord or plug is damaged, if liquid is spilled onto or objects fall into the unit, if the unit is exposed to rain or moisture, or if the unit does not operate normally or has been dropped.
15. Caution: There is a risk of explosion if the battery is replaced by an incorrect type. Dispose of used batteries according to the instructions.
16. Only use battery packs approved by the manufacturer or else damage may occur.

Declaration of RoHS Compliance

This product has been designed and manufactured in compliance with Directive 2002/95/EC of the European Parliament and the Council on restriction of the use of certain hazardous substances in electrical and electronic equipment (RoHS Directive) and is deemed to comply with the maximum concentration values issued by the European Technical Adaptation Committee (TAC) as shown below:

| Substance | Proposed Maximum Concentration | Actual Concentration |
|---|--------------------------------|----------------------|
| Lead (Pb) | 0.1% | < 0.1% |
| Mercury (Hg) | 0.1% | < 0.1% |
| Cadmium (Cd) | 0.01% | < 0.01% |
| Hexavalent Chromium (Cr ⁶⁺) | 0.1% | < 0.1% |
| Polybrominated biphenyls (PBB) | 0.1% | < 0.1% |
| Polybrominated diphenyl ethers (PBDE) | 0.1% | < 0.1% |

Certain components of products as stated above are exempted under the Annex of the RoHS Directives as noted below:

Examples of exempted components are:

1. Mercury in compact fluorescent lamps not exceeding 5 mg per lamp and in other lamps not specifically mentioned in the Annex of RoHS Directive.
2. Lead in glass of cathode ray tubes, electronic components, fluorescent tubes, and electronic ceramic parts (e.g. piezoelectronic devices).
3. Lead in high temperature type solders (i.e. lead-based alloys containing 85% by weight or more lead).
4. Lead as an alloying element in steel containing up to 0.35% lead by weight, aluminium containing up to 0.4% lead by weight and as a copper alloy containing up to 4% lead by weight.

Copyright Information

Copyright © ViewSonic® Corporation, 2011. All rights reserved.

ViewSonic, the three birds logo, OnView, ViewMatch, and ViewMeter are registered trademarks of ViewSonic Corporation.

Disclaimer: ViewSonic Corporation shall not be liable for technical or editorial errors or omissions contained herein; nor for incidental or consequential damages resulting from furnishing this material, or the performance or use of this product.

In the interest of continuing product improvement, ViewSonic Corporation reserves the right to change product specifications without notice. Information in this document may change without notice.

No part of this document may be copied, reproduced, or transmitted by any means, for any purpose without prior written permission from ViewSonic Corporation.

Product Registration

To meet your future needs, and to receive any additional product information as it becomes available, please register your product on the Internet at: www.viewsonic.com. The ViewSonic® Wizard CD-ROM also provides an opportunity for you to print the registration form, which you may mail or fax to ViewSonic.

For Your Records

| | |
|-------------------------|---|
| Product Name: | VC3D2 ViewSonic 3D Full HD Camcorder |
| Model Number: | VS14308 |
| Document Number: | VC3D2_UG_ENG Rev. 1A 07-18-11 |
| Serial Number: | _____ |
| Purchase Date: | _____ |

Product disposal at end of product life

ViewSonic respects the environment and is committed to working and living green. Thank you for being part of Smarter, Greener Computing. Please visit ViewSonic website to learn more.

USA & Canada: <http://www.viewsonic.com/company/green/recycle-program/>

Europe: <http://www.viewsoniceurope.com/uk/kbase/article.php?id=639>

Taiwan: <http://recycle.epa.gov.tw/recycle/index2.aspx>

Table of Contents

| | | |
|------------|---|-----------|
| 1 | <i>Introducing the camcorder</i> | 4 |
| 1.1 | <i>System requirements</i> | 4 |
| 1.1.1 | Standard system requirements | 4 |
| 1.1.2 | System requirements (for 3D video playback)..... | 4 |
| 1.2 | <i>Features</i> | 4 |
| 1.3 | <i>Unpacking the camcorder</i> | 5 |
| 1.4 | <i>About the camcorder</i> | 6 |
| 1.4.1 | Front view | 6 |
| 1.4.2 | Top view..... | 7 |
| 1.4.3 | Bottom view | 7 |
| 1.4.4 | Back view | 8 |
| 1.4.5 | Left view | 8 |
| 1.4.6 | Right view | 9 |
| 1.4.7 | Operating the camcorder | 13 |
| 2 | <i>Getting started</i> | 15 |
| 2.1 | <i>Inserting an SD card</i> | 15 |
| 2.2 | <i>Inserting the battery</i> | 16 |
| 2.3 | <i>Charging the battery</i> | 18 |
| 2.4 | <i>Turning on/ off the camcorder</i> | 18 |
| 2.5 | <i>Connecting to TV (AV Cable)</i> | 19 |
| 2.6 | <i>Connecting to TV (HDMI Cable)</i> | 19 |
| 2.7 | <i>Connecting to PC (USB Cable)</i> | 20 |
| 2.8 | <i>Changing modes</i> | 20 |
| 2.9 | <i>Before you start</i> | 20 |

| | | |
|-------|------------------------------|----|
| 2.9.1 | Managing the Setup mode..... | 21 |
| 2.9.2 | Language..... | 22 |
| 2.9.3 | Date / Time | 22 |
| 2.9.4 | Format | 23 |
| 2.9.5 | Default | 23 |
| 2.9.6 | Auto Power Off | 24 |
| 2.9.7 | Frequency..... | 24 |
| 2.9.8 | TV Standard..... | 25 |
| 2.9.9 | Beep | 25 |

3 Using the Camcorder 26

3.1 Recording Videos..... 26

3.2 Video Mode Menu..... 29

| | | |
|-------|---------------------|----|
| 3.2.1 | White Balance | 30 |
| 3.2.2 | Resolution..... | 30 |
| 3.2.3 | Effect | 31 |
| 3.2.4 | Night Mode..... | 32 |
| 3.2.5 | Quality..... | 32 |

3.3 Playback Videos..... 33

| | | |
|-------|-----------------------|----|
| 3.3.1 | Playback Videos | 33 |
|-------|-----------------------|----|

3.4 Deleting Videos 35

3.5 Protecting Videos..... 36

3.6 Autoplay Videos 37

3.7 Video Output..... 38

3.8 Shooting Photos 39

3.9 Camera Mode Menu 41

| | | |
|-------|---------------------|----|
| 3.9.1 | White Balance | 42 |
| 3.9.2 | Resolution..... | 42 |

| | | |
|-----------------|---------------------------------------|-----------|
| 3.9.3 | Effect | 43 |
| 3.9.4 | Night Mode | 44 |
| 3.9.5 | Quality | 44 |
| 3.10 | <i>Playback Photos</i> | 45 |
| 3.10.1 | Playback Photos | 45 |
| 3.11 | <i>Deleting Photos</i> | 47 |
| 3.12 | <i>Protecting Photos</i> | 48 |
| 3.13 | <i>Autoplay Photos</i> | 49 |
| 3.14 | <i>Image Output</i> | 50 |
| Appendix | | 51 |
| | <i>Specification</i> | 51 |
| | <i>Troubleshooting</i> | 53 |

1 Introducing the camcorder

Read this section to learn about the features and functions of the camcorder. This chapter also covers system requirements, package contents, and descriptions of the hardware components.

1.1 System requirements

1.1.1 Standard system requirements

The camcorder requires a PC with the following specifications:

- Windows® 7 / Vista / XP SP2 operating system
- Intel® / AMD Dual-Core CPU or higher
- At least 1 GB of RAM or higher
- At least DirectX 9 video card, DirectX 10 is recommended
- Standard USB 1.1 port or higher
- At least 2GB or greater available hard disk

1.1.2 System requirements (for 3D video playback)

The camcorder requires a PC with the following specifications:

- Windows® 7 / Vista operating system
- Intel® Core 2 Duo or AMD Athlon X2 CPU or higher
- NVIDIA GeForce 8, 9 and 200 series
- 3D ready monitor (120Hz)
- 3D vision kits

1.2 Features

The camcorder offers a variety of features and functions including:

- 3D and 2D video/image shooting and playback
- 3.2" LCD 3D display
- Parallax barrier auto-stereoscopic technology
- USB mass storage
- 3D and 2D video/image playback
- 3D glasses not required

1.3 Unpacking the camcorder

The following items should be present in the package. If any item is missing or appears damaged, contact your dealer immediately.

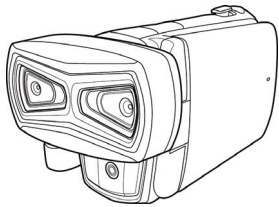

Camcorder



Quick Start Guide

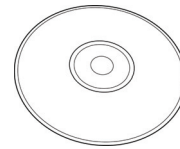

CD Rom

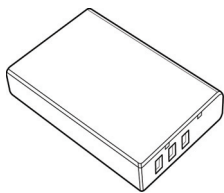

Li-ion Battery



Charger

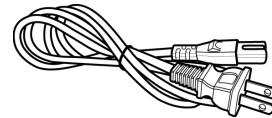

Power Cable

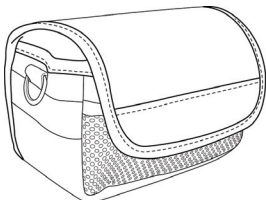

Pouch

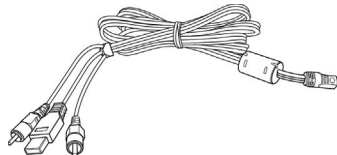

USB AV Cable

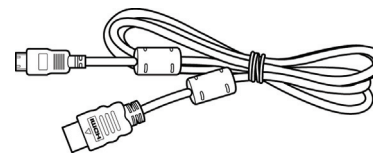

HDMI Cable

1.4 About the camcorder

Refer to the following illustrations to familiarize yourself with the buttons and controls of this camcorder.

1.4.1 Front view

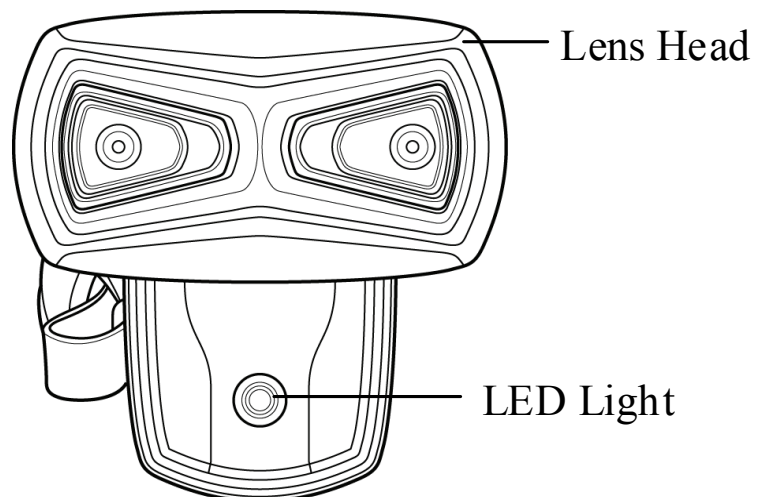
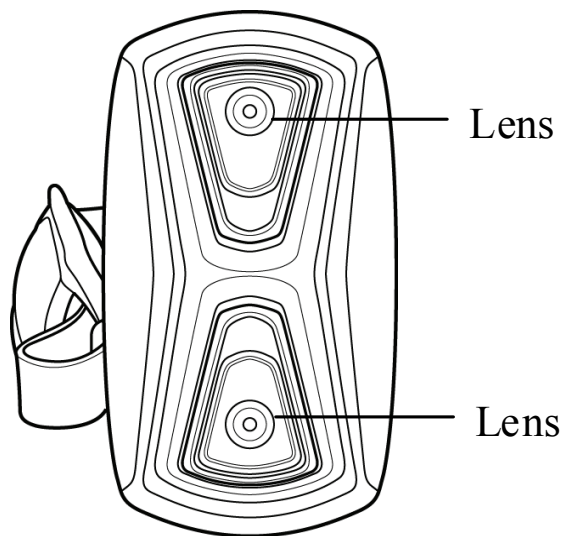

1.4.2 Top view

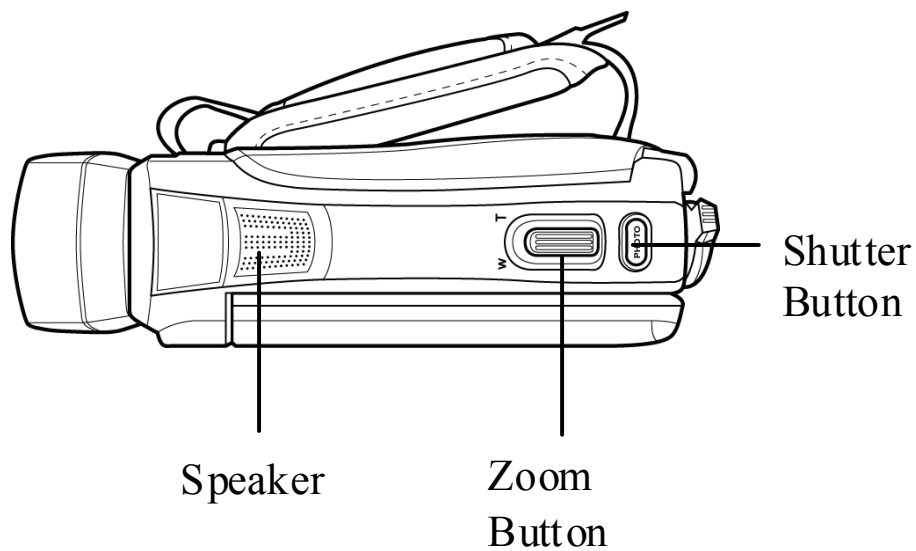

1.4.3 Bottom view

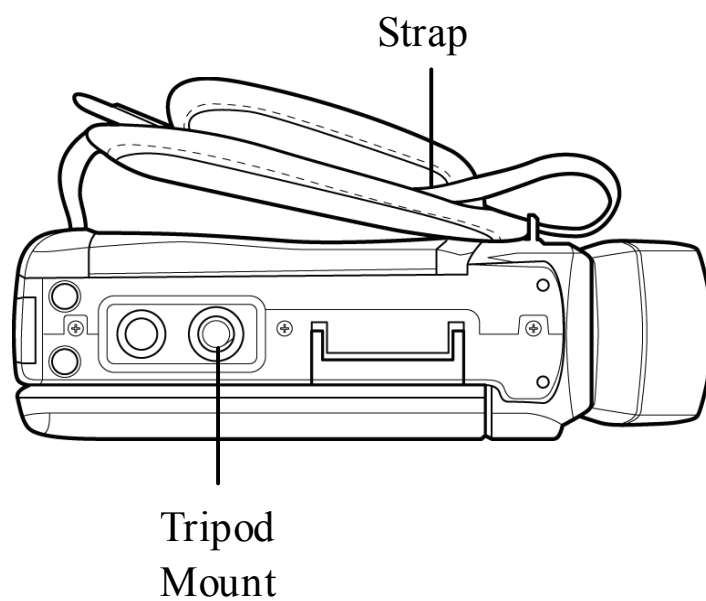

1.4.4 Back view

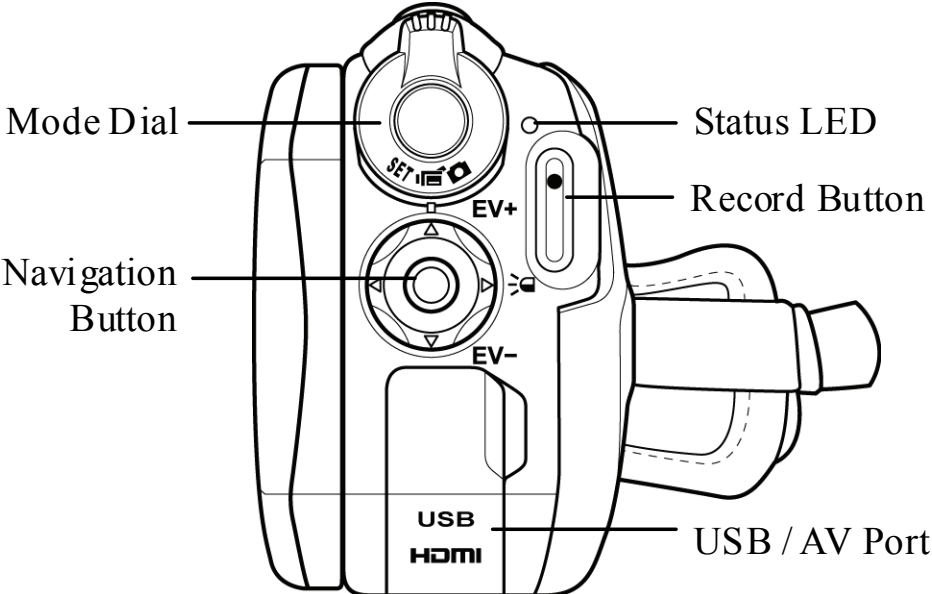



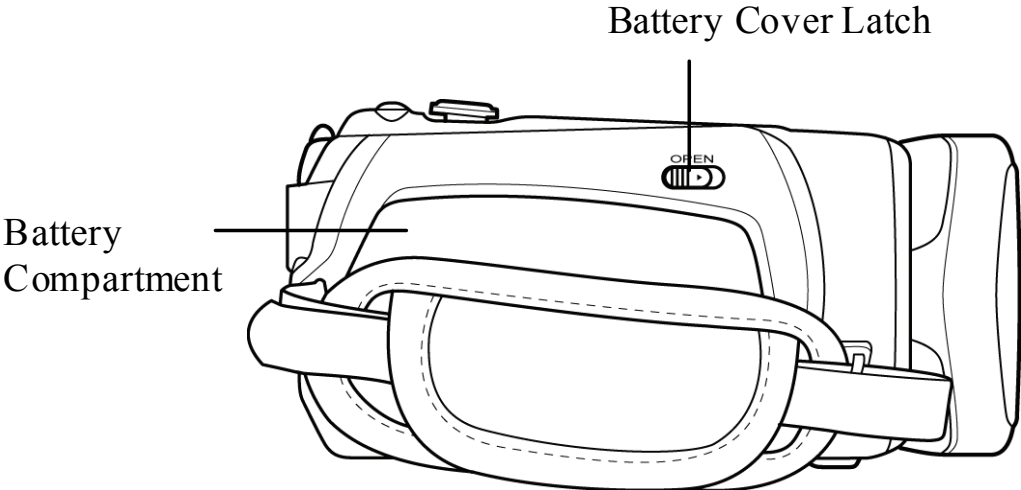

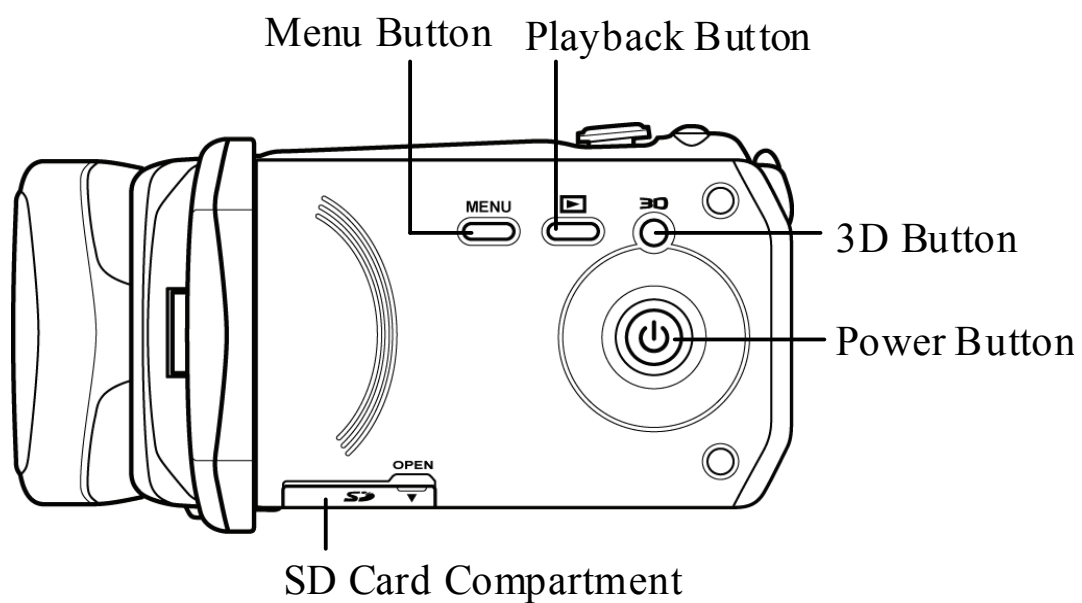
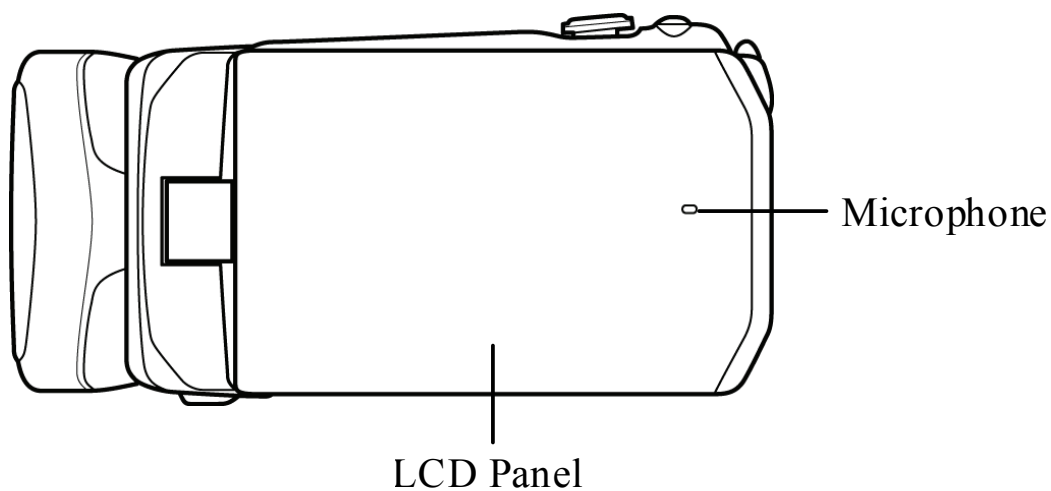

1.4.5 Left view



1.4.6 Right view



See the table below for a description of each button's function.

| Name | Button | Function |
|-----------------|--|---|
| Power Button |  | Press to turn the camcorder on or off. |
| Menu Button | <p data-bbox="533 589 655 622">MENU</p>  | Press to display the menu. Press again to go back the previous screen or close the menu. |
| Playback Button |  | Press to playback recorded videos or photos. |
| 3D Button | <p data-bbox="552 1010 636 1048">3D</p>  | Press to toggle between 3D and 2D modes. |
| Zoom Button |  | <ul style="list-style-type: none"> • In Video or Camera mode, press T to zoom in or press W to zoom out when shooting videos or photos. • In Video Playback mode, press T to increase the volume or W to decrease the volume. |
| Shutter Button |  | Press to take a picture. |

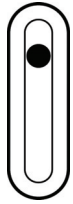
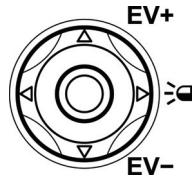
| Name | Button | Function |
|-------------------|---|---|
| Mode Dial |  | Adjust to switch to different modes: Video, Camera, or Setup. |
| Record Button |  | <ul style="list-style-type: none"> • In Video mode, press to start or stop recording a video. • In Video Playback mode, press to start and pause video playback. |
| Navigation Button |  | <p>In menu mode, use the four-way control to select items in the menu and press the middle button to confirm.</p> <p>In Video or Camera mode:</p> <ul style="list-style-type: none"> • Press the up/down button to increase/decrease the EV settings. • Press the left button to quickly adjust White Balance. • Press the right button to turn the LED on or off. <p>In Video Playback mode:</p> <ul style="list-style-type: none"> • Press the middle button to start or stop video playback. |

| Name | Button | Function |
|------|--------|---|
| | | <ul style="list-style-type: none"> • Press the left/right button to scroll through the videos. • While playing video, press the left/right button to rewind/fast-forward video playback. • While playing video, press and hold the left/right button increase/decrease to toggle the rewind/ fast-forward speed (2X, 4X, or 8X). <p>In Camera Playback mode:</p> <ul style="list-style-type: none"> • Press the left/right button to scroll through the photos. |

1.4.7 Operating the camcorder

To turn on the power, open the LCD panel or press the **Power Button** for one second.

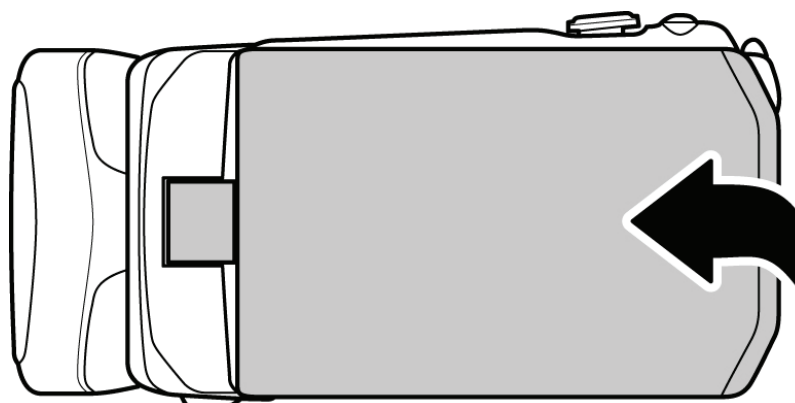

Rotate the LCD panel so you can view pictures and movies.

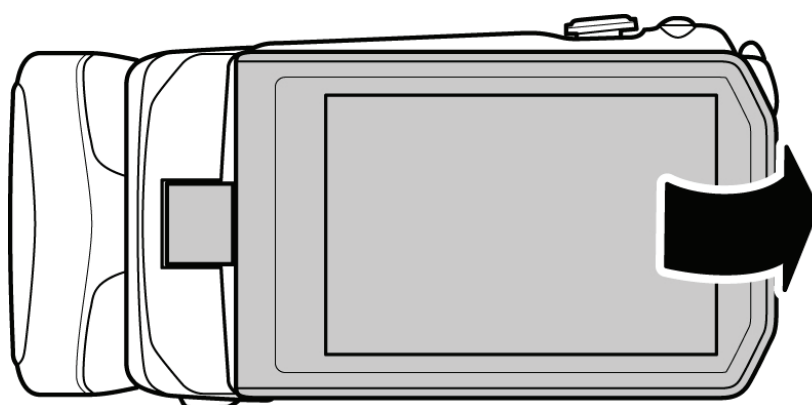
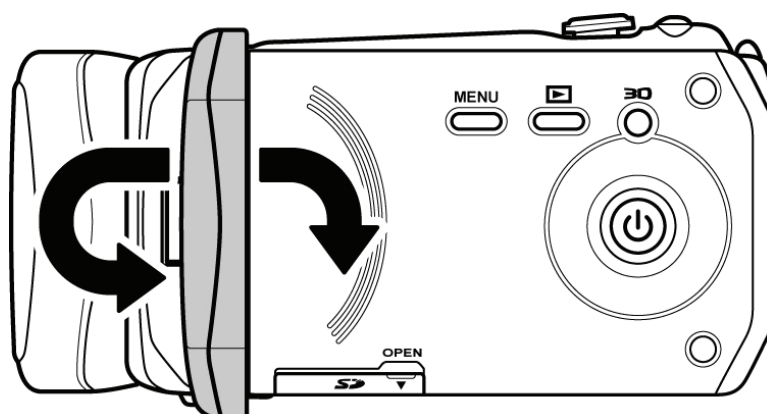

Rotate the lens head to open the lens.

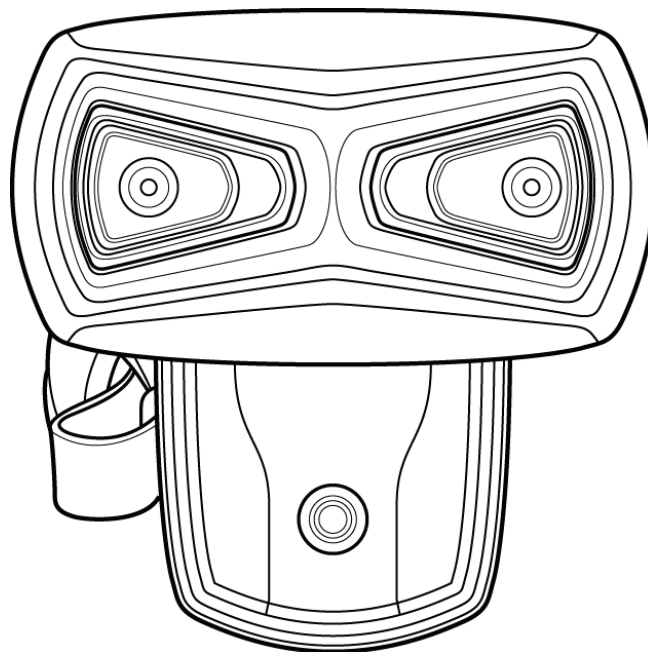
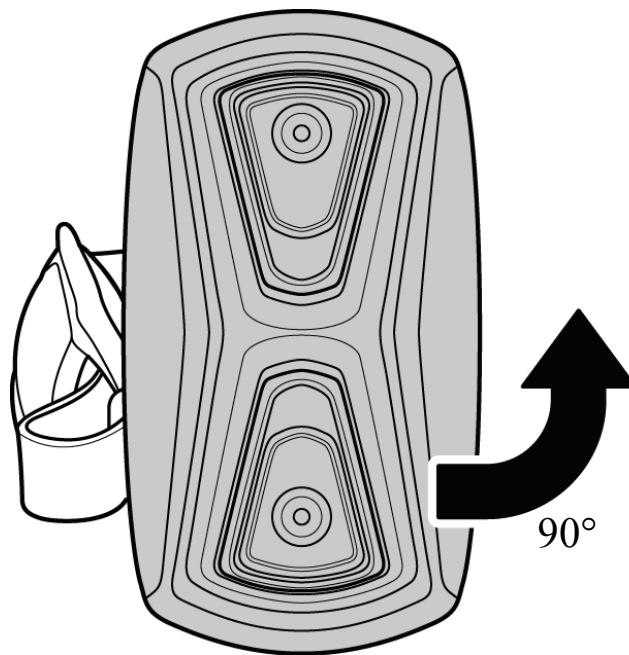

2 Getting started

Read this section to learn how to start using the camcorder. This section covers basic functions such as switching on, inserting the battery and memory cards, and configuring preliminary settings. See later chapters for advanced functions.

2.1 Inserting an SD card

An SD card can be installed in the camcorder to provide additional storage space for still images, video clips, or other files.

1. Open the SD card door as shown in the illustration.

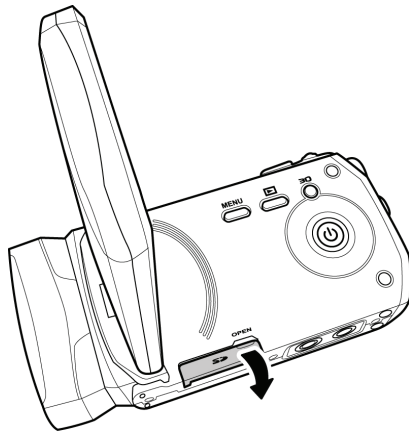

2. Insert the memory card. We recommend using a memory card with a capacity of 1 GB or higher.

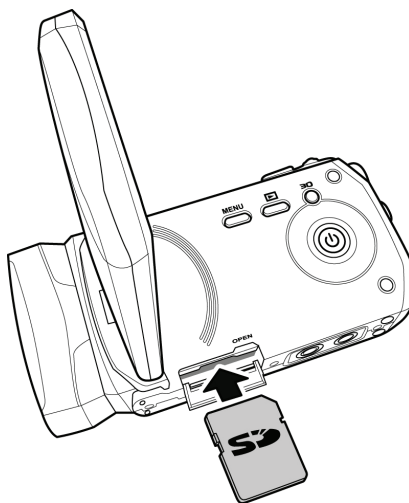

3. Close the SD card door.

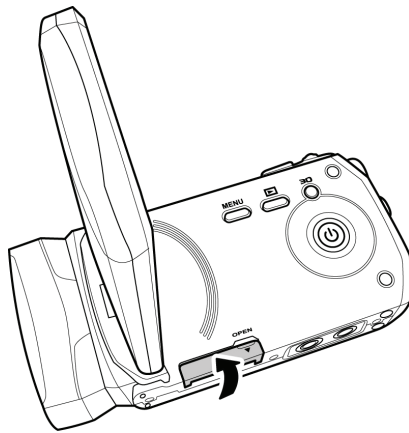

2.2 Inserting the battery

This camcorder is designed to use a rechargeable Li-ion battery. Only use the batteries supplied by the manufacturer or your dealer.

Note:

Install the battery exactly as described here. Installing the battery incorrectly could cause damage to the camcorder.

1. Slide the battery cover latch to open the battery cover.

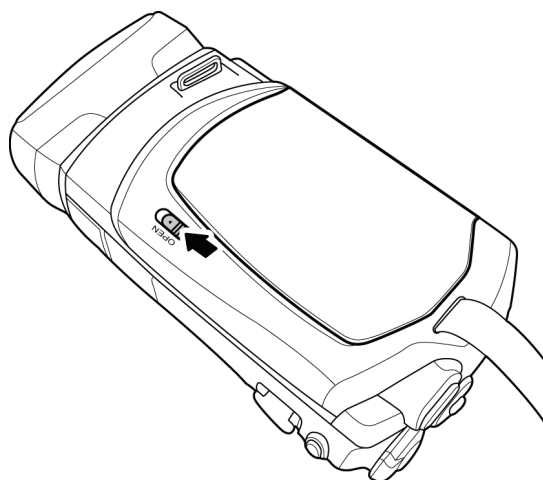

2. Insert the battery. Make sure that the + and – symbols on the battery line up with the + and – symbols on your camcorder.

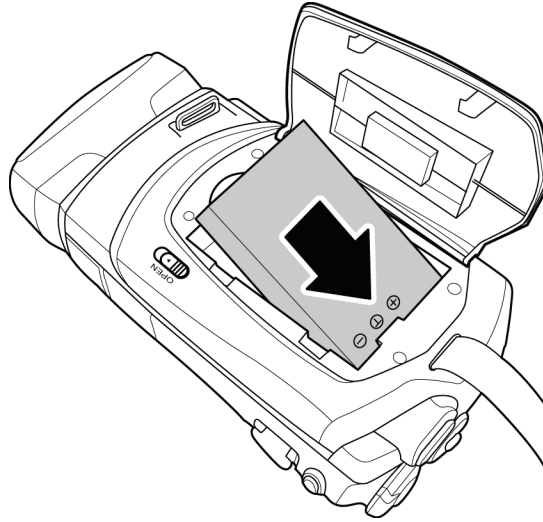

3. Close the battery cover.

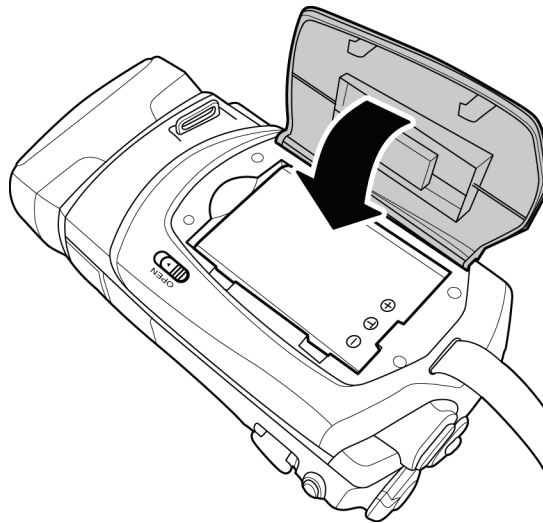

Note:

Make sure that the battery cover is tightly closed to ensure proper operation.

2.3 Charging the battery

You can charge the battery with the charging unit provided. Follow the steps below to charge the battery.

1. Insert the Li-ion battery into the charging bay. Connect one end of the power cord to the charging unit and then plug the other end to the wall outlet as shown.
2. The orange LED will light up for proper charging.
3. After full charge, the LED turns to green.
4. Actual charging time depends on current battery capacity and charging conditions.

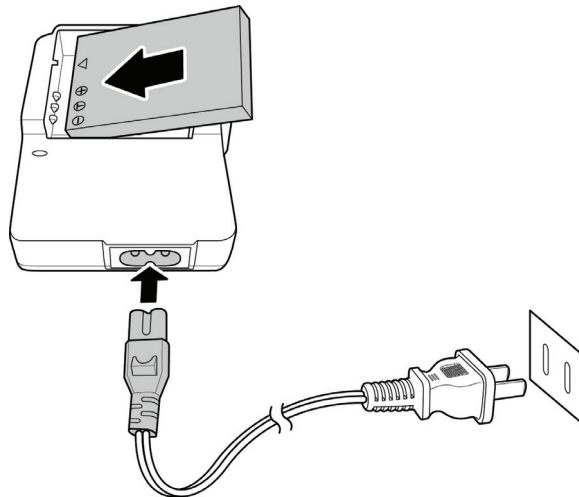

Approximate charging time is 240 minutes with a charger and a USB connection.

2.4 Turning on/ off the camcorder

Press and hold the **Power Button** to turn the camcorder on/off.

Note:

Closing and opening the LCD panel can power on/off the camera.

2.5 Connecting to TV (AV Cable)

To view pictures or videos on a TV, connect the camcorder to a TV using the supplied AV cable as shown.

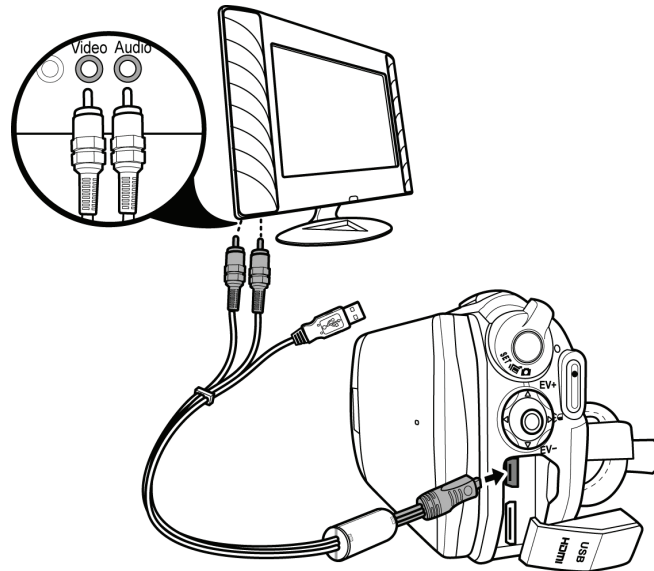

2.6 Connecting to TV (HDMI Cable)

You can also connect the camcorder to a TV using the HDMI cable.

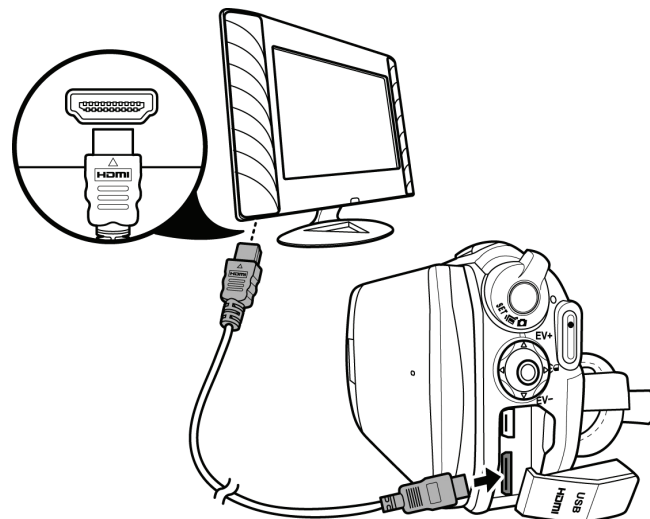

Note:

For 3D video playback, you need to use a 3D HDTV.

2.7 Connecting to PC (USB Cable)

Connect the camcorder to a computer with the USB cable provided as shown.

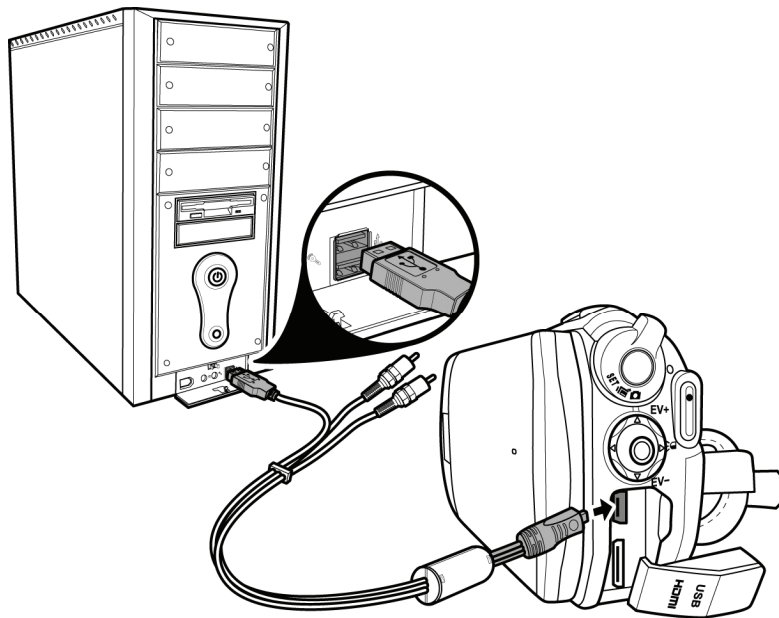

2.8 Changing modes

The camcorder can operate in three modes: Video, Camera, and Setup. Adjust the **Mode Dial** to switch between modes.

You can also press the **3D Button** to toggle between 2D and 3D modes.

In Video or Camera modes, press the **Menu Button** to enter the Video or Camera menu and adjust White Balance, Resolution, Color, Date Stamp, or Continuous Shooting.

2.9 Before you start

Before you start using the camcorder, some basic settings such as date and time, language, and beep function need to be configured.

2.9.1 Managing the Setup mode

To select a menu in the Setup mode, do the following:

1. Adjust the **Mode Dial** to Setup mode to display the Setup mode screen.
2. Use the **Navigation Button** to scroll through the options/pages until the desired menu is highlighted. Please see below for the available options.
3. Press the **middle Navigation Button** to open the menu.

The following options are available in the Setup mode:

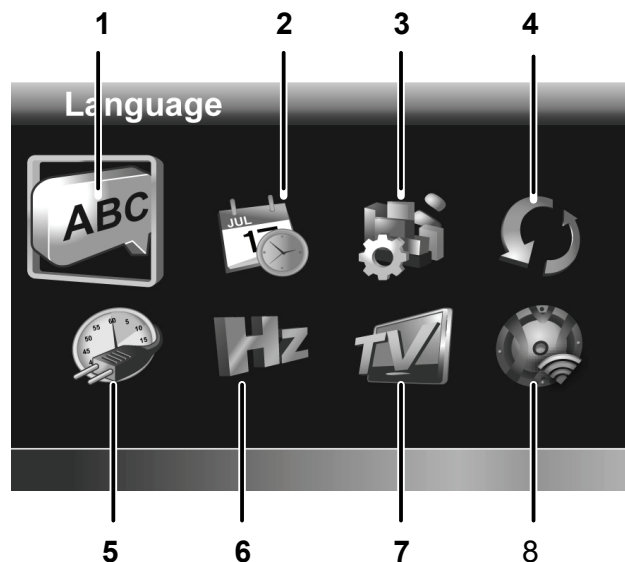

- | | |
|--------------|-------------------|
| 1. Language | 5. Auto power off |
| 2. Date/Time | 6. Frequency |
| 3. Format | 7. TV standard |
| 4. Default | 8. Beep |

Please read the following sections to learn how to operate each menu.

2.9.2 Language

The Language menu allows you to select the language displayed. To select the language, do the following:

1. Use the **left/right Navigation Button** to select the desired language.
2. Press the **middle Navigation Button** to confirm.

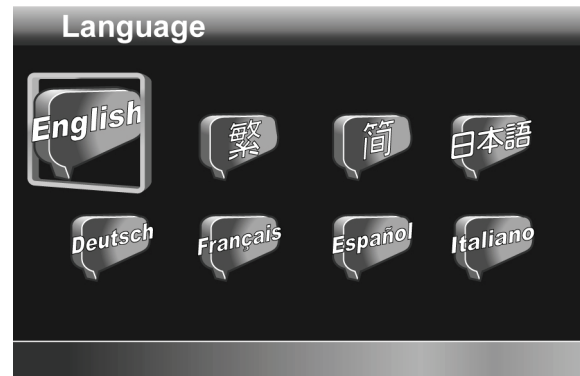

2.9.3 Date / Time

The Date / Time menu allows you to adjust the date and time. To adjust the Date / Time, do the following:

1. Use the **left/right Navigation Button** to select the field to be adjusted.
2. Use the **up/down Navigation Button** to adjust the value.
3. Press the **middle Navigation Button** to confirm.

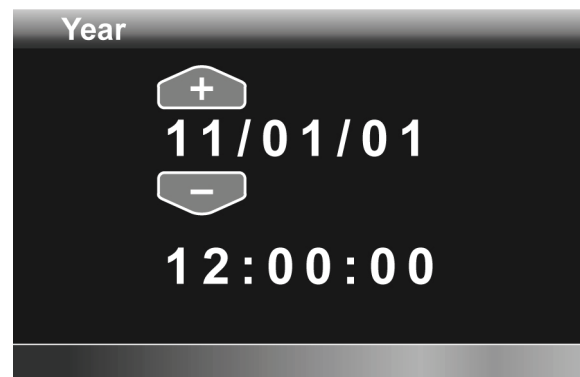

2.9.4 Format

The Format menu allows you to format your memory card or the internal memory when no memory card is inserted.

To format your memory card or internal memory, do the following:

1. Use the **left/right Navigation Button** to select \surd .
2. Press the **middle Navigation Button** to confirm.

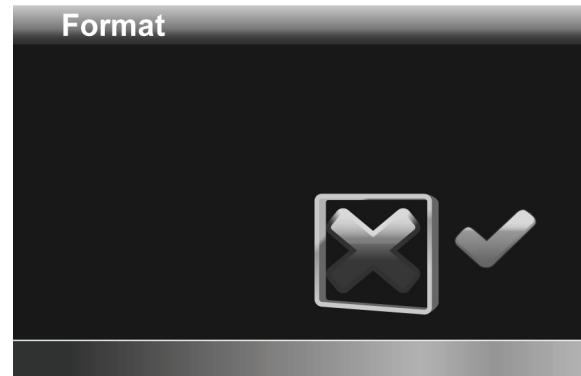

Warning: Formatting will delete everything on the media.

2.9.5 Default

The Default menu allows you to reset the camcorder to factory defaults.

To reset the camcorder, do the following:

1. Use the **left/right Navigation Button** to select \surd .
2. Press the **middle Navigation Button** to confirm.



2.9.6 Auto Power Off

The Auto Power Off menu allows you to set an idle time after which the camcorder automatically sets to sleep mode to save power.

To adjust the Auto Power Off, do the following:

1. Use the **left/right Navigation Button** to select:
 - **X**: Disable the Auto Power Off function.
 - **1 min.:** Auto Power Off after 1 minute.
 - **5 min.:** Auto Power Off after 5 minutes.



2. Press the **middle Navigation Button** to confirm.

2.9.7 Frequency

The Frequency menu allows you to set the refresh rate of the camcorder. Increasing the refresh rate decreases flickering, thereby reducing eyestrain.

To set the refresh rate, do the following:

1. Use the **left/right Navigation Button** to select **60Hz** or **50Hz**.
2. Press the **middle Navigation Button** to confirm.

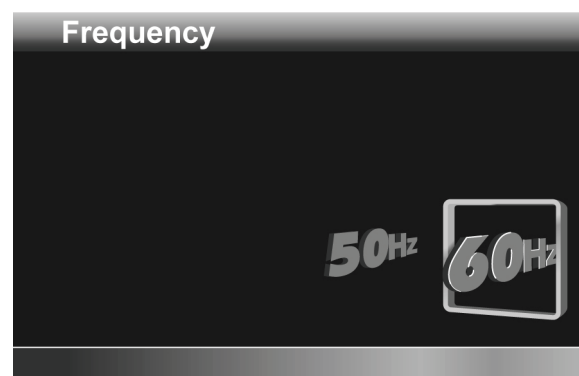

2.9.8 TV Standard

The TV Standard menu allows you to select the TV standard of the recorded videos.

To adjust the TV Standard, do the following:

1. Use the **left/right Navigation Button** to select **NTSC** or **PAL**.
2. Press the **middle Navigation Button** to confirm.

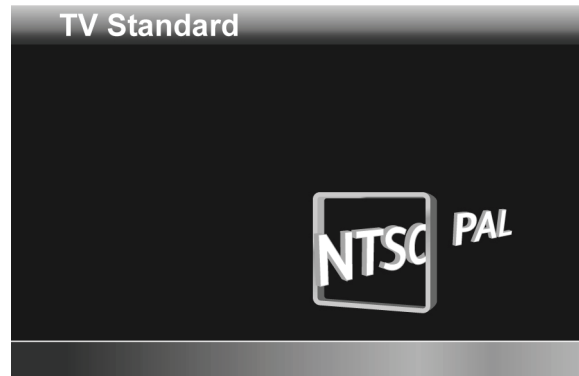

2.9.9 Beep

The Beep menu allows you to turn the operation sound and button sound off or on.

To adjust the Beep, do the following:

1. Use the **left/right Navigation Button** to select:
 - **X**: Turn the operation sound off.
 - **✓**: Turn the operation sound on.

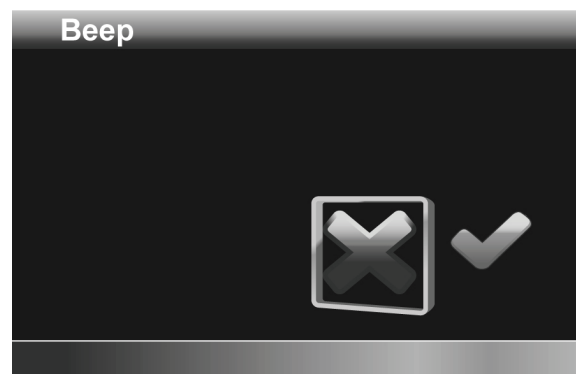

2. Press the **middle Navigation Button** to confirm.

3 Using the Camcorder

3.1 Recording Videos

To record a movie, do the following:

1. Rotate the lens head and flip open the LCD panel to turn on the camcorder.
2. Adjust the **Mode Dial** to Video mode.

To adjust the video, you may:

- Press the **3D Button** to switch to 3D or 2D mode. 3D mode allows you to record videos with 3D effects; 2D mode allows you to take regular 2D videos.
 - Press the **down Navigation Button** to decrease the EV settings.
 - Press the **up Navigation Button** to increase the EV settings.
 - Use the **Zoom Button** to zoom in and out in 2D mode.
 - Press the **left Navigation Button** to quickly change the White Balance.
 - Press the **right Navigation Button** to activate or disable the LED lighting.
 - Press the **Menu Button** to go to the Video mode menu for more adjustment options.
3. Press the **Record Button** to start recording the video.
 4. To stop movie recording, press the **Record Button** again.





Notes:



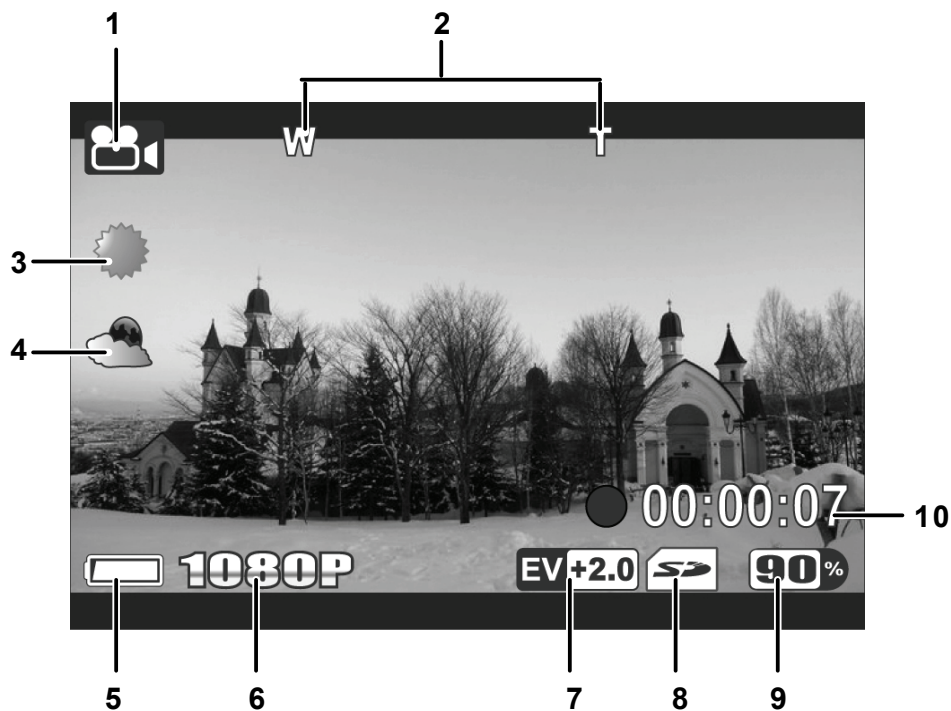



1. For best results, maintain a 30-40 cm distance between your eyes and the LCD panel when previewing 3D photos or videos.

- The maximum file size of each video recording is approximately 3.9GB. The system will separate another file automatically and record the video until the memory is full.

The Video Recording Screen



| # | Icon | Description |
|---|---|--|
| 1 |  | Indicates that the camcorder is in Video mode. |
| 2 |  | Indicates the amount of zoom being used. |
| 3 |  | Indicates the current White Balance mode. |
| 4 |  | Indicates that night mode is enabled. |

| # | Icon | Description |
|----|---|---|
| 5 |  | Indicates the amount of battery power left. |
| 6 |  | Indicates the current resolution. |
| 7 |  | Indicates the current exposure value. |
| 8 |  | Indicates the memory card is inserted. |
| |  | Indicates that the internal memory is used to store files. |
| 9 |  | Indicates the remaining space for your memory card/internal memory. |
| 10 |  | Indicates the recording time. |

3.2 Video Mode Menu

To select a menu in the Video mode, do the following:

1. Press the **Menu Button** to open the Video mode menu screen.
2. Use the **Navigation Button** to scroll through the options until the desired menu is highlighted. Please see below for the available options.
3. Press the **middle Navigation Button** to open the menu.
4. Press the **Record Button** to go back to Video mode.

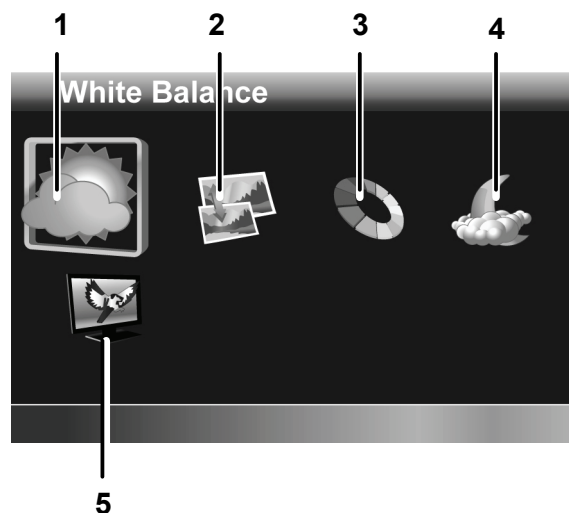

The following options are available in the Video mode menu:

options are

1. White Balance
2. Resolution
3. Effect
4. Night Mode
5. Quality

Please read the following sections to learn how to operate each menu.

Note: Quality is only available when an SD card is inserted.

3.2.1 White Balance

The White Balance menu allows you to set the white balance when capturing images under specific lighting conditions.

To set the White Balance, please do the following:

1. Use the **left/right Navigation Button** to select the desired option:

- **Auto:** Select this option to let the camcorder set the white balance automatically.
- **Sunny:** Select this option for daylight filming.
- **Cloudy:** Select this option for filming in cloudy days.
- **Fluorescent:** Select this option for fluorescent lighting.
- **Tungsten:** Select this option for normal indoor lighting conditions.

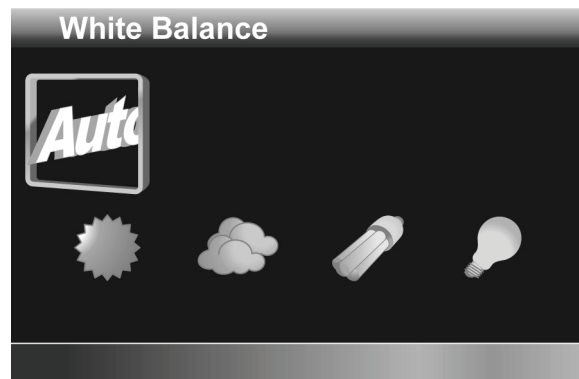

2. Press the **middle Navigation Button** to confirm.

3.2.2 Resolution

The Resolution menu allows you to set the resolution before you capture an image or a video. The higher the resolution, the more memory space is required.

To select the resolution, do the following:

1. Use the **left/right Navigation Button** to select the desired option:
 - **1080P**: Select this option for 1920 x 1080 resolution.
 - **720P30**: Select this option for 1280 x 720 resolution at 30 fps.
 - **720P60**: Select this option for 1280 x 720 resolution at 60 fps.
 - **WVGA**: Select this option for 848 x 480 resolution.
2. Press the **middle Navigation Button** to confirm.



3.2.3 Effect

The Effect menu allows you to change the recording effect.

To set the Effect, do the following:

1. Use the **left/right Navigation Button** to select the desired option:
 - **Natural**: Select it for color photography.
 - **Sepia**: Select it for brown color effect.
 - **Black and white**: Select it for black and white effect.
2. Press the **middle Navigation Button** to confirm.

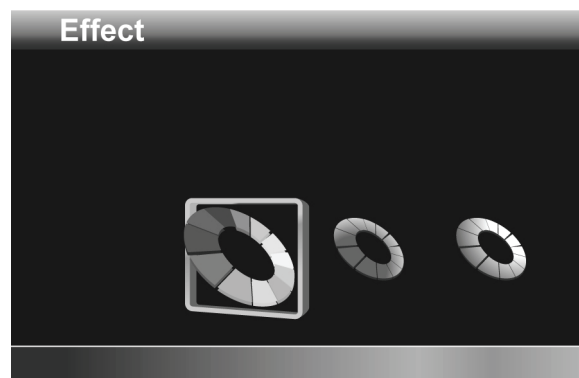

3.2.4 Night Mode

The Night Mode menu allows you to enable or disable the night mode feature.

To set night mode, do the following:

1. Use the **left/right Navigation Button** to select:
 - **X**: Turn night mode off.
 - **✓**: Turn night mode on.
2. Press the **middle Navigation Button** to confirm.

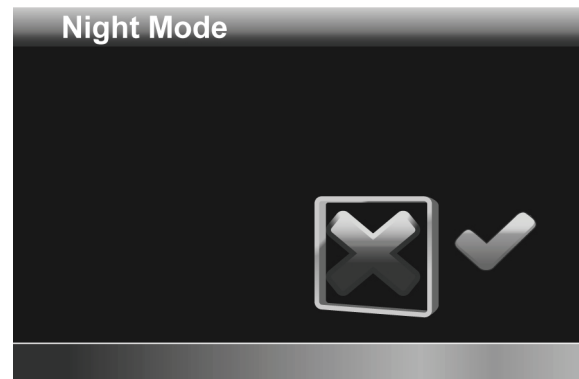

3.2.5 Quality

The Quality menu allows you to set the recording quality. Higher quality videos contain more details and therefore use more memory space.

To set the quality, do the following:

1. Use the **left/right Navigation Button** to select:
 - **Fine**: Select for higher recording quality.
 - **Normal**: Select for normal recording quality.
2. Press the **middle Navigation Button** to confirm.

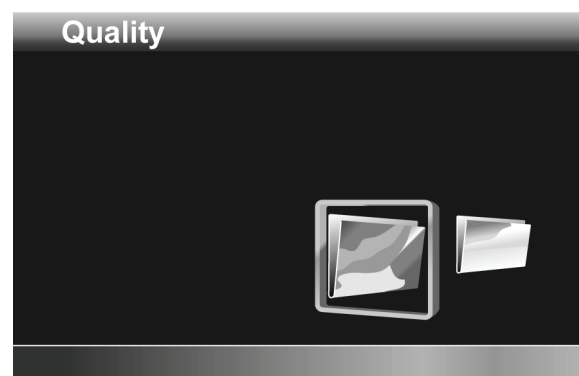

3.3 Playback Videos

3.3.1 Playback Videos

To playback videos, do the following:



1. Make sure you are in Video mode. Adjust the **Mode Dial** to switch to Video mode if not.
2. Press the **Playback Button** to open the Video playback screen.
3. Press the **left/right Navigation Button** to browse the recorded videos.
4. Press the **middle Navigation Button** or **Record Button** to playback the video.
 - To pause playback, press the **Record Button**. Press the **middle Navigation Button** to stop playback.
 - To adjust the volume, press the **Zoom Button**.
 - To rewind/fast-forward, press and hold the **left/right Navigation Button** to toggle different speeds (2X, 4X, or 8X). To return to the normal speed, press the **middle Navigation Button**.

Note:

Videos must be recorded in 3D mode to have 3D effects.

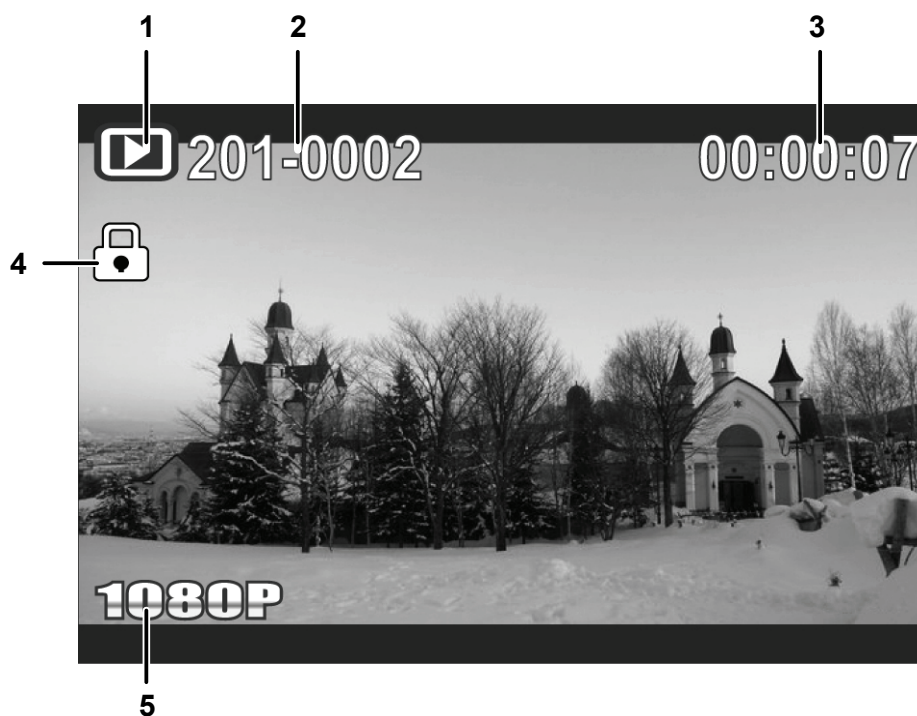
The Video Playback Screen



| # | Icon | Description |
|---|---|---|
| 1 |  | Indicates that the camcorder is in Playback mode. |
| 2 | 201-0002 | Indicates the video file number. |
| 3 | 00:00:07 | Indicates the total recorded time. |
| 4 |  | Indicates that the file is protected. |
| 5 | 1080P | Indicates the video resolution. |

3.4 Deleting Videos

To delete a single video, do the following:

1. In Video mode, press the **Playback Button** to enter the Video Playback mode.
2. Press the **left /right Navigation Button** to select the video you want to delete.
3. Press the **Menu Button** to open the Video Playback menu screen.
4. Use the **left/right Navigation Button** to select , then press the **middle Navigation Button** to confirm.
5. Press the **middle Navigation Button** to delete the selected video.



To delete all videos, do the following:

1. Press the **Playback Button** to enter Video Playback mode.
2. Press the **Menu Button** to open the Video Playback menu screen.
3. Use the **left/right Navigation Button** to select , then press the **middle Navigation Button** to confirm.
4. Use the **left/right Navigation Button** to select \surd , and then press the **middle Navigation Button** to delete all videos.



Note:

- Once deleted, files cannot be recovered. Ensure the files are transferred to the computer or saved to another storage device.
- Files that have been protected will not be deleted. You have to unlock the files first before deleting them.

3.5 Protecting Videos

To protect a video from being deleted, do the following:

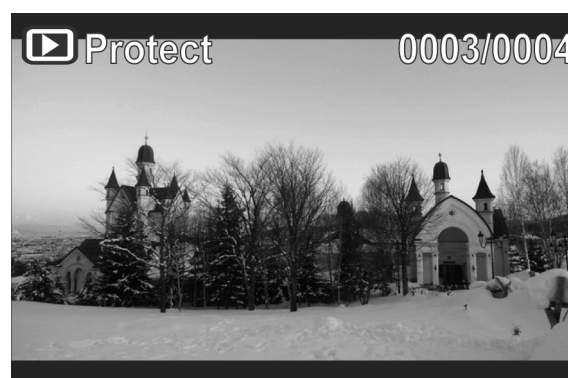

1. In Video mode, press the **Playback Button** to enter the Video Playback mode.
2. Press the **left /right Navigation Button** to select the video you want to protect/unprotect.
3. Press the **Menu Button** to open the Video Playback menu screen.
4. Use the **left/right Navigation Button** to select , then press the **middle Navigation Button** to confirm.
5. To protect/unprotect more files, use the **left/right Navigation Button** to select other files, then press the **middle Navigation Button** to protect/unprotect the file.



3.6 Autoplay Videos

The Autoplay function allows you to play each video clip in turn.

To start autoplay, do the following:

1. In Video mode, press the **Playback Button** to enter the Video Playback mode.
2. Press the **Menu Button** to open the Video Playback menu screen.
3. Use the **left/right Navigation Button** to select , then press the **middle Navigation Button** to confirm.
4. Use the **left/right Navigation Button** to select , and then press the **middle Navigation Button** to start autoplay.

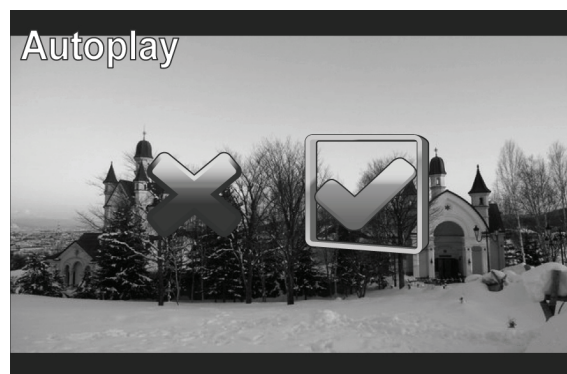

3.7 Video Output

The Video Output function allows you to change the display output in 3D format on a 3D TV.

To set video output, do the following:

1. In Video mode, press the **Playback Button** to enter the Video Playback mode.
2. Press the **Menu Button** to open the Video Playback menu screen.
3. Use the **left/right Navigation Button** to select , then press the **middle Navigation Button** to confirm.
4. Use the **left/right Navigation Button** to select desired option:
 - **2D**: You will see 2D video clips on TV.
 - **3D**: You will see 3D video clips on TV.
5. Press the **middle Navigation Button** to confirm.



Note:

- This function is only available on videos that have been recorded in 3D mode.
- If you are viewing with a regular 2D TV, the image will be displayed side by side.

3.8 Shooting Photos

To shoot a photo, do the following:





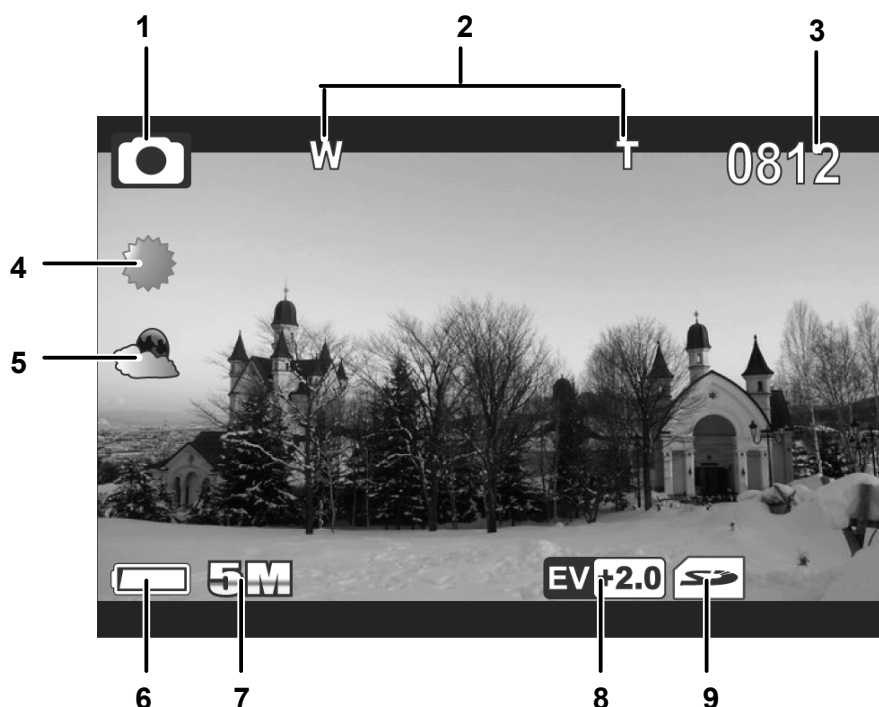

1. Rotate the lens head and flip open the LCD panel to turn on the camcorder.
2. Adjust the **Mode Dial** to switch to Camera mode.
3. Press the **Shutter Button** to capture a photo.

To adjust the camera, you may:

- Press the **3D Button** to switch to 3D or 2D mode. 3D mode allows you to take photos with 3D effects; 2D mode allows you to take regular 2D photos.
- Press the **down Navigation Button** to decrease the EV settings.
- Press the **up Navigation Button** to increase the EV settings
- Use the **Zoom Button** to zoom in and out.
- Press the **left Navigation Button** to quickly change the White Balance.
- Press the **right Navigation Button** to activate or disable the LED lighting.
- Press the Menu Button to enter the Camera mode menu for more adjustment options.

The Camera Screen



| # | Icon | Description |
|---|---|--|
| 1 |  | Indicates that the camcorder is in Camera mode. |
| 2 | W T | Indicates the amount of zoom being used. |
| 3 | 0812 | Indicates the total number of pictures. |
| 4 |  | Indicates the current White Balance mode. |
| 5 |  | Indicates that night mode is enabled. |
| 6 |  | Indicates the amount of battery power left. |
| 7 | 5M | Indicates the current resolution. |
| 8 | EV+2.0 | Indicates the current exposure value. |
| 9 |  | Indicates the memory card is inserted. |
| |  | Indicates that the internal memory is used to store files. |

3.9 Camera Mode Menu

To select a menu in the Camera mode, do the following:

1. Press the **middle Navigation Button** to open the Camera mode menu screen.
2. Use the **Navigation Button** to scroll through the options until the desired menu is highlighted. Please see below for the available options.
3. Press the **middle Navigation Button** to open the menu.
4. Press the **Record Button** to go back to Video mode.

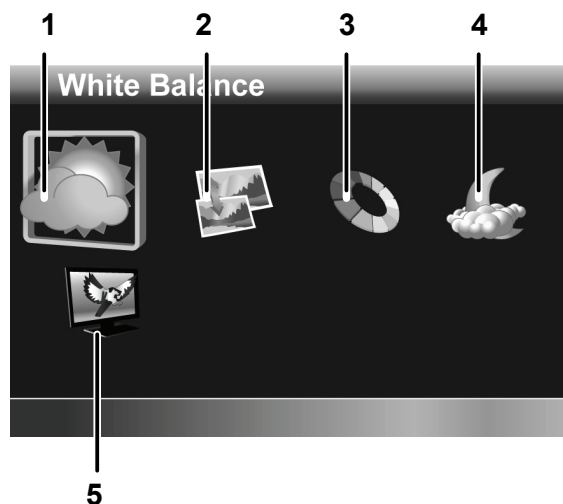

The following options are available in the Camera mode menu:

options are

1. White Balance
2. Resolution
3. Effect
4. Night Mode
5. Quality

Please read the following section to learn how to operate each menu.

Note: Quality is only available when an SD card is inserted.

3.9.1 White Balance

The White Balance menu allows you to adjust the white balance when capturing images under specific lighting conditions.

To set the White Balance, do the following:

1. Use the **left/right Navigation Button** to select the desired option:

- **Auto:** Select this option to let the camcorder set the white balance automatically.
- **Sunny:** Select this option for daylight filming.
- **Cloudy:** Select this option for filming in cloudy days.
- **Fluorescent:** Select this option for fluorescent lighting.
- **Tungsten:** Select this option for normal indoor lighting conditions.

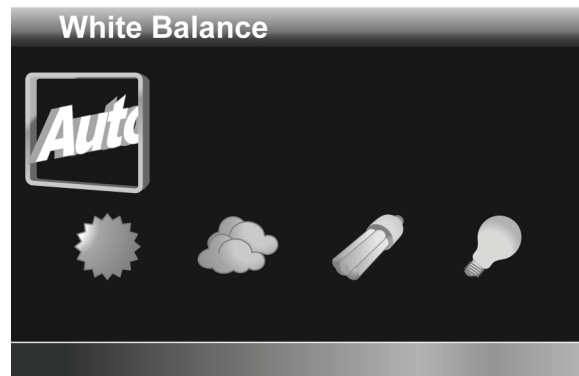

2. Press the **middle Navigation Button** to confirm.

3.9.2 Resolution

The Resolution menu allows you to set the resolution before you capture an image or a video. The higher the resolution, the more memory space is required.

To select the resolution, do the following:

1. Use the **left/right Navigation Button** to select the desired option:

(2D mode)

- **2M**: Select this option for 1832 x 1372 resolution.
- **5M**: Select this option for 2592 x 1944 resolution.
- **8M**: Select this option for 3200 x 2400 resolution.
- **16M**: Select this option for 4608 x 3456 resolution.



(3D mode)

- **2M**: Select this option for 1832 x 1030 resolution.
- **5M**: Select this option for 2280 x 1242 resolution.
- **16M**: Select this option for 4608 x 2592 resolution.

2. Press the **middle Navigation Button** to confirm.

3.9.3 Effect

The Effect menu allows you to change the camera effect.

To set the Effect, do the following:

1. Use the **left/right Navigation Button** to select the desired option:

- **Color**: Select this option for color photography.
- **Sepia**: Select this option for brown color effect.
- **Black and white**: Select this option for black and white effect.

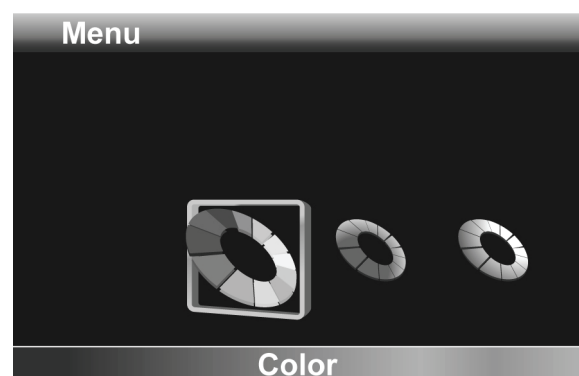

2. Press the **middle Navigation Button** to confirm.

3.9.4 Night Mode

The Night Mode menu allows you to enable or disable the night mode feature.

To set night mode, do the following:

1. Use the **left/right Navigation Button** to select:
 - **X**: Turn night mode off.
 - **✓**: Turn night mode on.
2. Press the **middle Navigation Button** to confirm.



3.9.5 Quality

The Quality menu allows you to set the image quality. Higher quality images contain more details and therefore use more memory space.

To set the quality, do the following:

1. Use the **left/right Navigation Button** to select:
 - **Fine**: Select for higher image quality.
 - **Normal**: Select for normal image quality.
2. Press the **middle Navigation Button** to confirm.

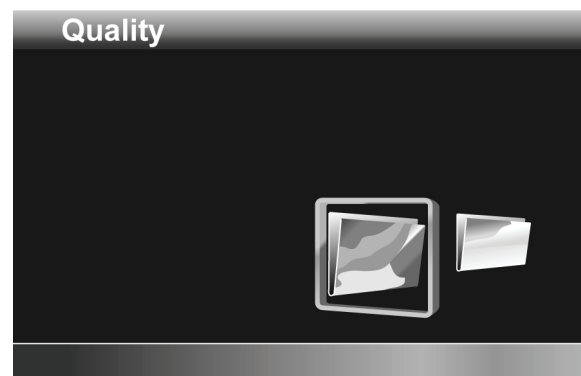

3.10 Playback Photos

3.10.1 Playback Photos

To playback photos, please do the following:



1. Make sure you are in the Camera mode. Adjust the **Mode Dial** to switch to Camera mode if not.
2. Press the **Playback Button** to enter the Photo playback screen.
3. Press the **left/right Navigation Button** to browse the recorded photos.

Note:

Photos must be recorded in 3D mode to have 3D effects.

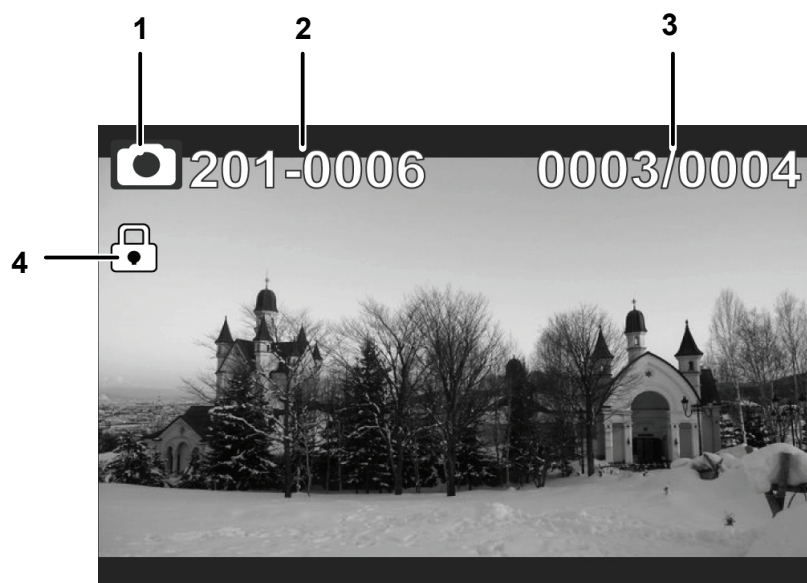
The Photo Playback Screen



| # | Icon | Description |
|---|---|---|
| 1 |  | Indicates that the camcorder is in Camera Playback mode. |
| 2 | 201-0006 | Indicates the file number of the current photo. |
| 3 | 0003/0004 | Indicates the sequence number of the current photo over the total number of photos. |
| 4 |  | Indicates the amount of battery power left. |



3.11 Deleting Photos

To delete a single photo, do the following:

1. In Camera mode, press the **Playback Button** to enter the Photo Playback mode.
2. Press the **left /right Navigation Button** to select the photo you want to delete.
3. Press the **Menu Button** to open the Photo Playback menu screen.
4. Use the **left/right Navigation Button** to select , then press the **middle Navigation Button** to confirm.
5. Press the **middle Navigation Button** to delete the selected photo.



To delete all photos, do the following:

1. Press the **Playback Button** to enter the Photo Playback mode.
2. Press the **Menu Button** to open the Photo Playback menu screen.
3. Use the **left/right Navigation Button** to select , then press the **middle Navigation Button** to confirm.
4. Use the **left/right Navigation Button** to select , and then press the **middle Navigation Button** to delete all photos.



Note:

- Once deleted, files cannot be recovered. Ensure the files are transferred to the computer or saved to another storage device.
- Files that have been protected will not be deleted. You have to unlock the files first before deleting them.

3.12 Protecting Photos

To protect a photo from being deleted, do the following:



1. In Camera mode, press the **Playback Button** to enter the Photo Playback mode.
2. Press the **left /right Navigation Button** to select the photo you want to protect/unprotect.
3. Press the **Menu Button** to open the Photo Playback menu screen.
4. Use the **left/right Navigation Button** to select , then press the **middle Navigation Button** to confirm.
5. To protect/unprotect more files, use the **left/right Navigation Button** to select other files, then press the **middle Navigation Button** to protect/unprotect the file.



3.13 Autoplay Photos

The Autoplay function allows you to play the slideshow of the photos on your camera.

To start autoplay, do the following:

1. In Camera mode, press the **Playback Button** to enter the Camera Playback mode.
2. Press the **Menu Button** to open the Camera Playback menu screen.
3. Use the **left/right Navigation Button** to select , then press the **middle Navigation Button** to confirm.
4. Use the **left/right Navigation Button** to select , and then press the **middle Navigation Button** to start autoplay.

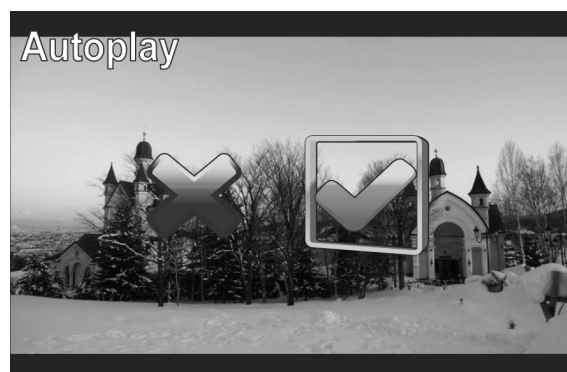

3.14 Image Output

The Image Output function allows you to change the display output in 3D format on a 3D TV.

To set image output, do the following:

1. In Camera mode, press the **Playback Button** to enter the Camera Playback mode.
2. Press the **Menu Button** to open the Camera Playback menu screen.
3. Use the **left/right Navigation Button** to select , then press the **middle Navigation Button** to confirm.
4. Use the **left/right Navigation Button** to select desired option:
 - **2D**: You will see 2D photos on TV.
 - **3D**: You will see 3D photos on TV.
5. Press the **middle Navigation Button** to confirm.



Note:

- This function is only available on photos that have been recorded in 3D mode.
- If you are viewing with a regular 2D TV, the image will be displayed side by side.

Appendix

Specification

| General | |
|----------------|--|
| Imaging sensor | 1/3.2" 5M CMOS Sensor x 2 |
| Active pixels | 5.0 Megapixel |
| Storage media | Internal: Built-in 128MB Flash Memory (Available memory for image storage is approximately 56MB) SD Card: (Up to SDHC 32GB Class6) |
| Sensitivity | Auto |
| Exposure mode | Programmed AE |
| Color effects | Natural/B&W/Sepia |
| Lens | F3.2, f=5.1mm |
| Focus range | Approx. 1.2m~infinity |
| Still image | Formats: JPEG (EXIF 2.2) 3D Still image: 2M, 5M, 16M (Firmware Interpolation) 2D Still image: 2M, 5M, 8M, 16M (Firmware Interpolation) |

General

| | |
|-----------------|---|
| Movie clips | H.264 (MP4) 3D and 2D Movie: WVGA 848x480 60fps, 720p 30/60fps, 1080p 30fps |
| Zoom | 3D: 8X 2D: 10X |
| LCD monitor | 3.2" color LCD monitor (320x480 pixels) |
| LED light | Effective range: < 1M Mode: On/Off |
| White balance | Auto/Sunny/Cloudy/Tungsten/ Fluorescent |
| EV compensation | -2.0 EV~+2.0 EV |
| Interface | AV-out: NTSC / PAL / HDMI MSDC: USB 2.0 (high speed) |
| Shutter speed | Video: 1/15 ~ 1/2000 second Still: 2 ~ 1/4000 speed |
| Power supply | Li-ion Battery NP120 |
| Dimension | 43 (W) x 68 (H) x 135 (D) mm |
| Weight | Approx. 232 ± 5 g (without battery and memory card) |

Troubleshooting

| Problem | Possible Cause | Solution |
|---|---|--|
| Cannot turn on the camcorder. | The battery is not inserted correctly. The batteries have no power. | <ul style="list-style-type: none"> ① Insert the battery correctly. ① Charge the battery. |
| The camcorder suddenly turns off. | The auto power off function is enabled. The camcorder is running out of battery power. | <ul style="list-style-type: none"> ① Turn the power on again. ① Replace the battery. |
| The captured image is not stored in memory. | Before the image is saved the power has been cut off. | <ul style="list-style-type: none"> ① When the battery indicator turns red, replace the battery immediately. |
| The camcorder turns off while taking a picture. | The camera is running out of battery power. | <ul style="list-style-type: none"> ① Replace the battery. |
| The image is out of focus. | The subject is beyond focus range. | <ul style="list-style-type: none"> ① Please take a picture within the available focus range |

| Problem | Possible Cause | Solution |
|---------------------------------------|---|--|
| A black screen appears on the screen. | The EV setting may be set too high. | ① Adjust the EV setting on the camcorder. |
| Memory card cannot be used. | The memory card is protected. The memory card contains non-DCF images taken by other camcorders. | ① Unlock the memory card. ① Format the memory card. Before formatting the card, ensure you back up the files. |
| All buttons are inactive. | Short circuit occurred when connecting the camera with other devices. | ① Remove the batteries from the camera and insert again. |



SDHC Logo is a trademark of SD-3C, LLC.

Customer Support

For technical support or product service, see the table below or contact your reseller.

Note : You will need the product serial number.

| Country/Region | Website | T = Telephone F = FAX | Email |
|---|-----------------------------|---|---|
| Australia/New Zealand | www.viewsonic.com.au | AUS= 1800 880 818 NZ= 0800 008 822 | service@au.viewsonic.com |
| Canada | www.viewsonic.com | T (Toll-Free)= 1-866-463-4775 T (Toll)= 1-424-233-2533 F= 1-909-468-3757 | service.ca@viewsonic.com |
| Europe | www.viewsoniceurope.com | www.viewsoniceurope.com/uk/Support/Calldesk.htm | |
| Hong Kong | www.hk.viewsonic.com | T= 852 3102 2900 | service@hk.viewsonic.com |
| India | www.in.viewsonic.com | T= 1800 266 0101 | service@in.viewsonic.com |
| Ireland (Eire) | www.viewsoniceurope.com/uk/ | www.viewsoniceurope.com/uk/support/call-desk/ | service_ie@viewsoniceurope.com |
| Korea | www.kr.viewsonic.com | T= 080 333 2131 | service@kr.viewsonic.com |
| Latin America (Argentina) | www.viewsonic.com/la/ | T= 0800-4441185 | soporte@viewsonic.com |
| Latin America (Chile) | www.viewsonic.com/la/ | T= 1230-020-7975 | soporte@viewsonic.com |
| Latin America (Columbia) | www.viewsonic.com/la/ | T= 01800-9-157235 | soporte@viewsonic.com |
| Latin America (Mexico) | www.viewsonic.com/la/ | T= 001-8882328722 | soporte@viewsonic.com |
| Renta y Datos, 29 SUR 721, COL. LA PAZ, 72160 PUEBLA, PUE. Tel: 01.222.891.55.77 CON 10 LINEAS Electroser, Av Reforma No. 403Gx39 y 41, 97000 Mérida, Yucatán. Tel: 01.999.925.19.16 Other places please refer to http://www.viewsonic.com/la/soporte/index.htm#Mexico | | | |
| Latin America (Peru) | www.viewsonic.com/la/ | T= 0800-54565 | soporte@viewsonic.com |
| Macau | www.hk.viewsonic.com | T= 853 2870 0303 | service@hk.viewsonic.com |
| Middle East | ap.viewsonic.com/me/ | Contact your reseller | service@ap.viewsonic.com |
| Puerto Rico & Virgin Islands | www.viewsonic.com | T= 1-800-688-6688 (English) T= 1-866-379-1304 (Spanish) F= 1-909-468-3757 | service.us@viewsonic.com soporte@viewsonic.com |
| Singapore/Malaysia/Thailand | www.viewsonic.com.sg | T= 65 6461 6044 | service@sg.viewsonic.com |
| South Africa | ap.viewsonic.com/za/ | Contact your reseller | service@ap.viewsonic.com |
| United Kingdom | www.viewsoniceurope.com/uk/ | www.viewsoniceurope.com/uk/support/call-desk/ | service_gb@viewsoniceurope.com |
| United States | www.viewsonic.com | T (Toll-Free)= 1-800-688-6688 T (Toll)= 1-424-233-2530 F= 1-909-468-3757 | service.us@viewsonic.com |

Limited Warranty

ViewSonic® 3D Full HD Camcorder

What the warranty covers:

ViewSonic warrants its products to be free from defects in material and workmanship, under normal use, during the warranty period. If a product proves to be defective in material or workmanship during the warranty period, ViewSonic will, at its sole option, repair or replace the product with a like product. Replacement product or parts may include remanufactured or refurbished parts or components.

How long the warranty is effective:

ViewSonic 3D Full HD Camcorder are warranted for 1 year for labor from the date of the first customer purchase.

Who the warranty protects:

This warranty is valid only for the first consumer purchaser.

What the warranty does not cover:

1. Any product on which the serial number has been defaced, modified or removed.
2. Damage, deterioration or malfunction resulting from:
 - a. Accident, misuse, neglect, fire, water, lightning, or other acts of nature, unauthorized product modification, or failure to follow instructions supplied with the product.
 - b. Any damage of the product due to shipment.
 - c. Removal or installation of the product.
 - d. Causes external to the product, such as electrical power fluctuations or failure.
 - e. Use of supplies or parts not meeting ViewSonic's specifications.
 - f. Normal wear and tear.
 - g. Any other cause which does not relate to a product defect.
3. Any product exhibiting a condition commonly known as "image burn-in" which results when a static image is displayed on the product for an extended period of time.
4. Removal, installation, one way transportation, insurance, and set-up service charges.

How to get service:

1. For information about receiving service under warranty, contact ViewSonic Customer Support (please refer to Customer Support page). You will need to provide your product's serial number.
2. To obtain warranted service, you will be required to provide (a) the original dated sales slip, (b) your name, (c) your address, (d) a description of the problem, and (e) the serial number of the product.
3. Take or ship the product freight prepaid in the original container to an authorized ViewSonic service center or ViewSonic.
4. For additional information or the name of the nearest ViewSonic service center, contact ViewSonic.

Limitation of implied warranties:

There are no warranties, express or implied, which extend beyond the description contained herein including the implied warranty of merchantability and fitness for a particular purpose.

Exclusion of damages:

ViewSonic's liability is limited to the cost of repair or replacement of the product. ViewSonic shall not be liable for:

1. Damage to other property caused by any defects in the product, damages based upon inconvenience, loss of use of the product, loss of time, loss of profits, loss of business opportunity, loss of goodwill, interference with business relationships, or other commercial loss, even if advised of the possibility of such damages.
2. Any other damages, whether incidental, consequential or otherwise.
3. Any claim against the customer by any other party.
4. Repair or attempted repair by anyone not authorized by ViewSonic.

4.3: ViewSonic 3D Full HD Camcorder Warranty

3DC_LW01 Rev. 1A 08-05-08

Mexico Limited Warranty

ViewSonic® 3D Full HD Camcorder

What the warranty covers:

ViewSonic warrants its products to be free from defects in material and workmanship, under normal use, during the warranty period. If a product proves to be defective in material or workmanship during the warranty period, ViewSonic will, at its sole option, repair or replace the product with a like product. Replacement product or parts may include remanufactured or refurbished parts or components.

How long the warranty is effective:

ViewSonic 3D Full HD Camcorder are warranted for 1 year for labor from the date of the first customer purchase.

Who the warranty protects:

This warranty is valid only for the first consumer purchaser.

What the warranty does not cover:

1. Any product on which the serial number has been defaced, modified or removed.
2. Damage, deterioration or malfunction resulting from:
 - a. Accident, misuse, neglect, fire, water, lightning, or other acts of nature, unauthorized product modification, or failure to follow instructions supplied with the product.
 - b. Any damage of the product due to shipment.
 - c. Removal or installation of the product.
 - d. Causes external to the product, such as electrical power fluctuations or failure.
 - e. Use of supplies or parts not meeting ViewSonic's specifications.
 - f. Normal wear and tear.
 - g. Any other cause which does not relate to a product defect.
3. Any product exhibiting a condition commonly known as "image burn-in" which results when a static image is displayed on the product for an extended period of time.
4. Removal, installation, one way transportation, insurance, and set-up service charges.

How to get service:

For information about receiving service under warranty, contact ViewSonic Customer Support (Please refer to the attached Customer Support page). You will need to provide your product's serial number, so please record the product information in the space provided below on your purchase for your future use. Please retain your receipt of proof of purchase to support your warranty claim.

For Your Records

Product Name: _____ Model Number: _____
Document Number: _____ Serial Number: _____
Purchase Date: _____ Extended Warranty Purchase? _____ (Y/N)
If so, what date does warranty expire? _____

1. To obtain warranty service, you will be required to provide (a) the original dated sales slip, (b) your name, (c) your address, (d) a description of the problem, and (e) the serial number of the product.
2. Take or ship the product in the original container packaging to an authorized ViewSonic service center.
3. Round trip transportation costs for in-warranty products will be paid by ViewSonic.

Limitation of implied warranties:

There are no warranties, express or implied, which extend beyond the description contained herein including the implied warranty of merchantability and fitness for a particular purpose.

Exclusion of damages:

ViewSonic's liability is limited to the cost of repair or replacement of the product. ViewSonic shall not be liable for:

1. Damage to other property caused by any defects in the product, damages based upon inconvenience, loss of use of the product, loss of time, loss of profits, loss of business opportunity, loss of goodwill, interference with business relationships, or other commercial loss, even if advised of the possibility of such damages.
2. Any other damages, whether incidental, consequential or otherwise.
3. Any claim against the customer by any other party.
4. Repair or attempted repair by anyone not authorized by ViewSonic.

| | |
|---|---|
| Contact Information for Sales & Authorized Service (Centro Autorizado de Servicio) within Mexico: | |
| Name, address, of manufacturer and importers: México, Av. de la Palma #8 Piso 2 Despacho 203, Corporativo Interpalmas, Col. San Fernando Huixquilucan, Estado de México Tel: (55) 3605-1099 http://www.viewsonic.com/la/soporte/index.htm | |
| NÚMERO GRATIS DE ASISTENCIA TÉCNICA PARA TODO MÉXICO: 001.866.823.2004 | |
| Hermosillo: Distribuciones y Servicios Computacionales SA de CV. Calle Juarez 284 local 2 Col. Bugambilias C.P: 83140 Tel: 01-66-22-14-9005 E-Mail: disc2@hmo.megared.net.mx | Villahermosa: Compumantenimientos Garantizados, S.A. de C.V. AV. GREGORIO MENDEZ #1504 COL, FLORIDA C.P. 86040 Tel: 01 (993) 3 52 00 47 / 3522074 / 3 52 20 09 E-Mail: compumantenimientos@prodigy.net.mx |
| Puebla, Pue. (Matriz): RENTA Y DATOS, S.A. DE C.V. Domicilio: 29 SUR 721 COL. LA PAZ 72160 PUEBLA, PUE. Tel: 01(52).222.891.55.77 CON 10 LINEAS E-Mail: datos@puebla.megared.net.mx | Veracruz, Ver.: CONEXION Y DESARROLLO, S.A DE C.V. Av. Americas # 419 ENTRE PINZÓN Y ALVARADO Fracc. Reforma C.P. 91919 Tel: 01-22-91-00-31-67 E-Mail: gacosta@qplus.com.mx |
| Chihuahua Soluciones Globales en Computación C. Magisterio # 3321 Col. Magisterial Chihuahua, Chih. Tel: 4136954 E-Mail: Cefeo@soluglobales.com | Cuernavaca Compusupport de Cuernavaca SA de CV Francisco Leyva # 178 Col. Miguel Hidalgo C.P. 62040, Cuernavaca Morelos Tel: 01 777 3180579 / 01 777 3124014 E-Mail: aquevedo@compusupportcva.com |
| Distrito Federal: QPLUS, S.A. de C.V. Av. Coyoacán 931 Col. Del Valle 03100, México, D.F. Tel: 01(52)55-50-00-27-35 E-Mail : gacosta@qplus.com.mx | Guadalajara, Jal.: SERVICRECE, S.A. de C.V. Av. Niños Héroes # 2281 Col. Arcos Sur, Sector Juárez 44170, Guadalajara, Jalisco Tel: 01(52)33-36-15-15-43 E-Mail: mmiranda@servicrece.com |
| Guerrero Acapulco GS Computación (Grupo Sesicomp) Progreso #6-A, Colo Centro 39300 Acapulco, Guerrero Tel: 744-48-32627 | Monterrey: Global Product Services Mar Caribe # 1987, Esquina con Golfo Pérsico Fracc. Bernardo Reyes, CP 64280 Monterrey N.L. México Tel: 8129-5103 E-Mail: aydeem@gps1.com.mx |
| MERIDA: ELECTROSER Av Reforma No. 403Gx39 y 41 Mérida, Yucatán, México CP97000 Tel: (52) 999-925-1916 E-Mail: rrrb@sureste.com | Oaxaca, Oax.: CENTRO DE DISTRIBUCION Y SERVICIO, S.A. de C.V. Murguía # 708 P.A., Col. Centro, 68000, Oaxaca Tel: 01(52)95-15-15-22-22 Fax: 01(52)95-15-13-67-00 E-Mail: gpotai2001@hotmail.com |
| Tijuana: STD Av Ferrocarril Sonora #3780 L-C Col 20 de Noviembre Tijuana, Mexico | FOR USA SUPPORT: ViewSonic Corporation 381 Brea Canyon Road, Walnut, CA. 91789 USA Tel: 800-688-6688 (English); 866-323-8056 (Spanish); Fax: 1-800-685-7276 E-Mail: http://www.viewsonic.com |



ViewSonic®

Free Manuals Download Website

<http://myh66.com>

<http://usermanuals.us>

<http://www.somanuals.com>

<http://www.4manuals.cc>

<http://www.manual-lib.com>

<http://www.404manual.com>

<http://www.luxmanual.com>

<http://aubethermostatmanual.com>

Golf course search by state

<http://golfingnear.com>

Email search by domain

<http://emailbydomain.com>

Auto manuals search

<http://auto.somanuals.com>

TV manuals search

<http://tv.somanuals.com>