

High Definition Digital Video Camera 980HD

User's Manual

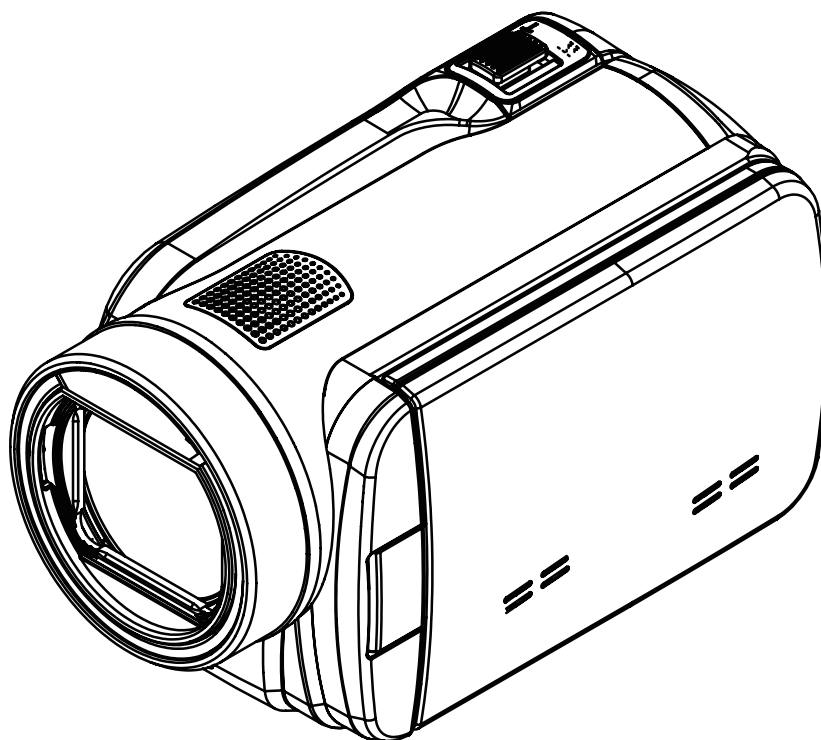

Vivitar[®]
we make it easy[™]

© 2010 Sakar International, Inc. All rights reserved.
Windows and the Windows logo are registered trademarks of Microsoft Corporation.
All other trademarks are the property of their respective companies.

Contents

Section 1	Getting to Know Your Camera.....	3
Section 2	Getting Started.....	6
Section 3	Enjoying the Record Mode	8
Section 4	Enjoying the Playback Mode	20
Section 5	Setting Your Camera	27
Section 6	Viewing Pictures and Movies on TV	31
Section 7	Using the Software.....	32
Section 8	Transferring Media	35
Section 9	Sakar Warranty Card	36
Section 10	Technical Support	36
Section 11	Specifications and System Requirements	37
Section 12	Troubleshooting	39

Section 1

Getting to Know Your Camera

Overview

Thank you for purchasing this camera. Everything you need to take quality digital photos and videos is included with your camera.

Vivitar makes capturing those special moments as easy as possible.

The camera with 5 Mega Pixel sensor can take H.264 movies. By way of using H.264 technology, more videos can be taken within certain amount of memory. High quality images with up to 16 mega-pixels can also be delivered smoothly. With a color LCD monitor, users can compose images and examine them easily.

The camera features 3" LCD touch panel which is an ideal platform for you to operate your camera. The menu options are accessible with your finger. With the touch panel, you can select the options directly and quickly.

The camera also features movie recording at an HD resolution of 1920x1080. You can also connect it to an HDTV via an HDMI cable, and easily playback the recorded high-definition videos on the wide screen HDTV.

Moreover, the camera has an advanced uploading feature. With the exclusive built-in **Internet Direct** application, you can upload the videos captured by the camera to Internet more effortlessly.

ISO sensitivity and color balance can either be adjusted automatically or changed manually. A 4x digital zoom helps you to control over the movies and pictures you take.

The varied effect options, such as Time Lapse and Slow Motion, make recording more fun.

The built-in memory allows you to take pictures and to record movies without a memory card. The memory card slot allows users to increase the storage capacity.



Note

Partial memory of the built-in memory is used for the camera's Firmware code.

Standard Accessories

Unpack the package and make sure all standard accessories listed are included:

- Camera
- USB Cable
- AV Cable
- HDMI Cable
- Adaptor
- Lithium-ion Rechargeable Battery
- Quick Guide
- CD-ROM (Software and User's Manual)
- Cloth Bag
- Lens Cover Set (Lens cover and Strap)

Front View

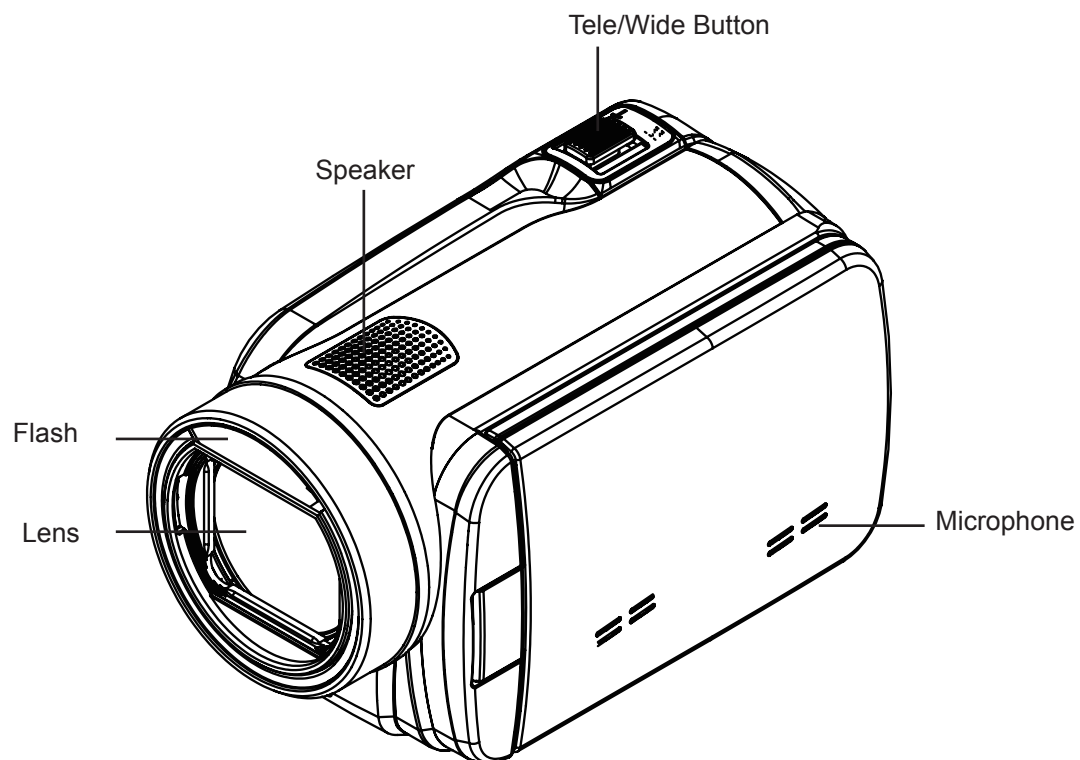

Rear View

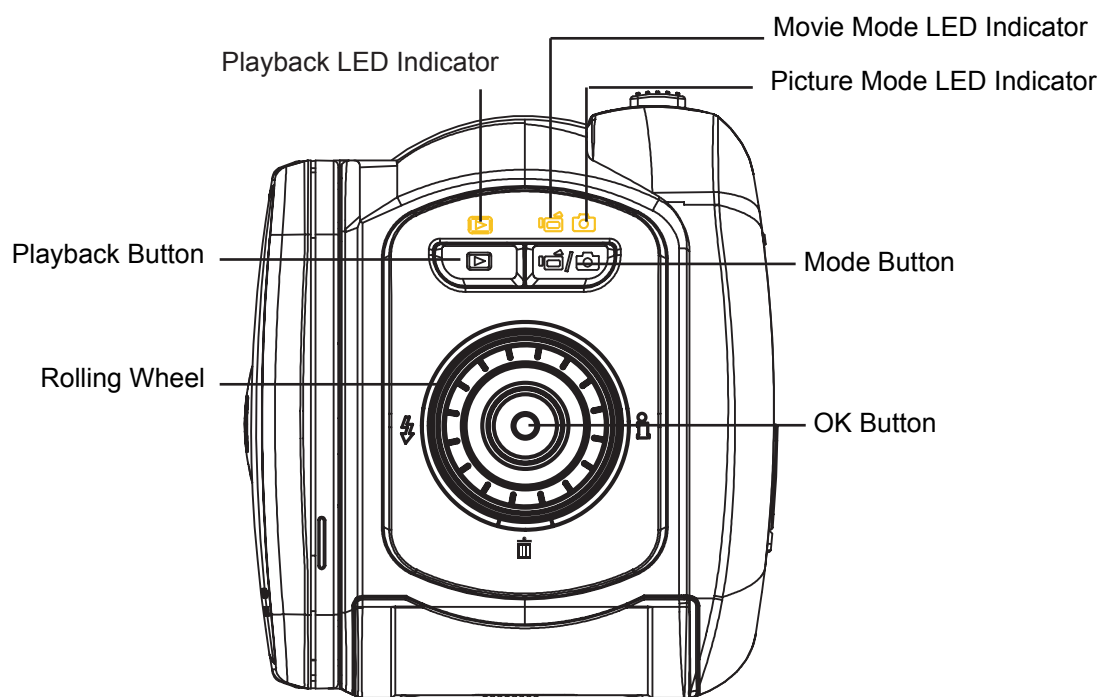

Side View

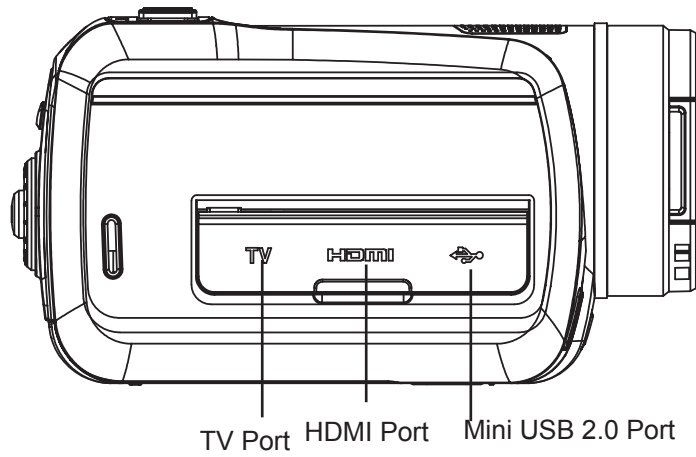
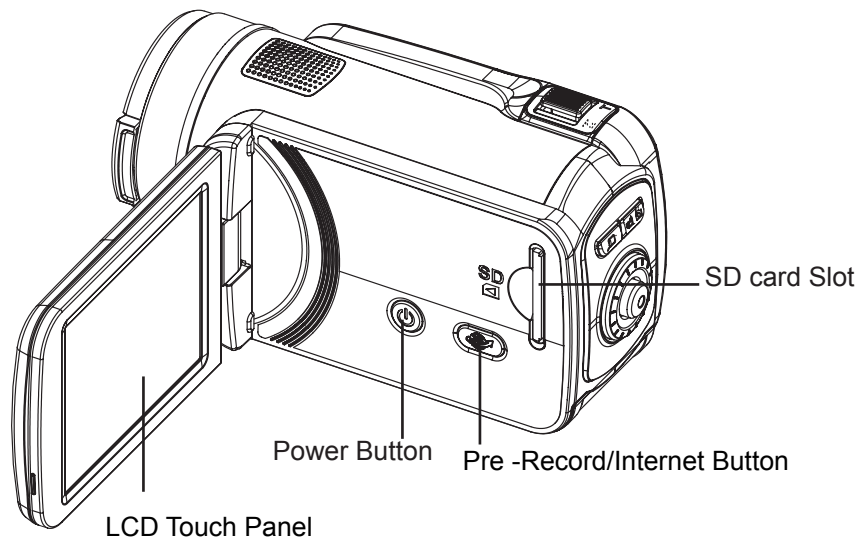

Bottom View

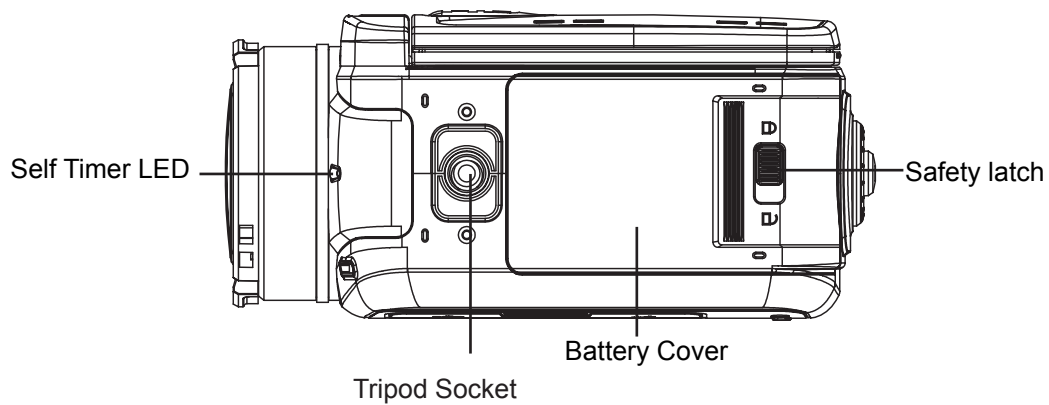

Section 2 Getting Started

Loading the Battery

Before using the camera, users must load the Lithium-ion rechargeable battery come within the package.

1. Slide the safety latch to the unlocked position and open the battery cover.
2. Insert the battery according to the correct polarity marks (+ or -).
3. Close the battery cover firmly, and slide the safety latch to the locked position.

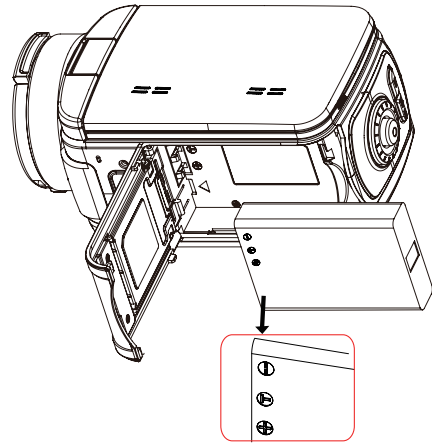

Inserting and Removing an SD Card (Optional)

The camera comes with an internal memory which allows you to store pictures and movies. You can expand the memory capacity by using an optional SD/SDHC memory card.

1. Insert the memory card into the slot. Please refer to the figure on the right side.
2. To remove an installed SD card, press the card inwards to release it.
3. When the card pops out, gently remove it from its slot.
4. Recommended memory capacity: 1GB or above.

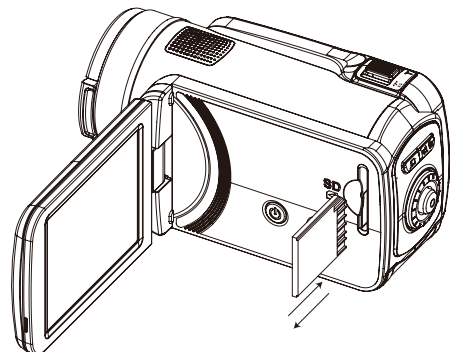



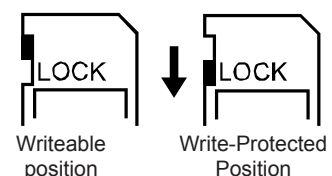

Note





- When a memory card is fitted, movies/pictures are saved on the card rather than on the built-in memory.
- *Protecting Data on an SD Card: SD Card is read-only when it is locked. No pictures or movies can be recorded when the SD card is locked. Make sure the lock is on the writeable position before recording any media.*

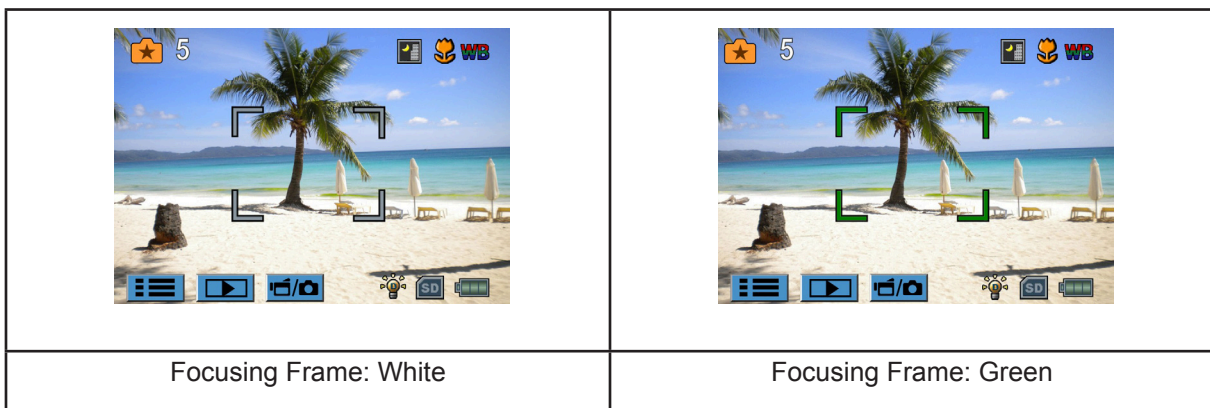

Turning the Camera On and Getting Started

- To turn on the camera:
 1. Flip out the LCD panel; the camera will turn on automatically.
 2. Or press Power Button for one second to turn it on.
- To record movies: Press Mode Button or touch  on the screen to switch to the Movie Record mode. (The Movie Mode LED Indicator  will light up.) Press OK Button to record movies.
- To take a picture: Press Mode Button or touch  on the screen to switch to the Picture Record mode. (The Picture Mode LED Indicator  will light up.) Press OK Button halfway down until the focusing frame turns from white to green. Then, press it fully down to take pictures.



- To take a picture during movie recording: When recording movies, press Mode Button () to capture the image. The Dual record icon () appears on the LCD monitor.
- To view stored movies and pictures: Press Playback Button or press  on the screen to switch to the Playback mode. (The Playback LED Indicator ) will light up.) Press Mode Button or touch  on the screen to switch between Movie Preview Screen and Picture Preview Screen.





Turning the Camera Off

- To turn off the camera: You can either press the Power Button for one second, or you can place the LCD panel back to its original position.

Section 3

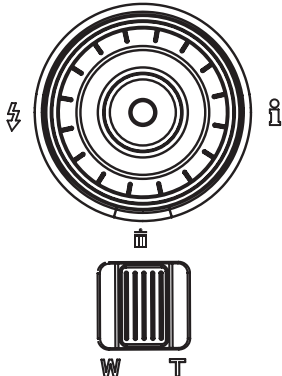
Enjoying the Record Mode













Button Function





















 <p>The image shows a rolling wheel with a lightning bolt icon on the left and an information icon on the right. Below it is a rectangular button with vertical lines and the letters 'W' and 'T' at the bottom.</p>	<p>Rolling Wheel: Rotate to move between the wheel menu options.</p> <p>Right Button: LCD Information ON/OFF. In Record menu, press to switch to the submenu.</p> <p>Left Button: Flash Auto/Red-Eye-Reduction/Digital Light/Flash OFF. In Record menu, press to return to the main menu.</p> <p>Up Button: Move between the option items.</p> <p>Down Button: Delete the current or all movies/pictures. Move between the option items.</p> <p>OK Button:</p> <ol style="list-style-type: none"> 1. Validate the setting. 2. In Movie Record Mode, press to take movies. To stop recording, press it again. 3. In Picture Record Mode, press to take pictures. <p>Tele Button : Zoom In</p> <p>Wide Button : Zoom out</p>
 <p>The image shows a button with a play icon (a right-pointing triangle inside a square) on a rounded rectangular background.</p>	<p>Playback Button:</p> <ol style="list-style-type: none"> 1. Switch between Record / Playback Mode. 2. For quick review, press it after recording. 3. In Record menu, press to exit.
 <p>The image shows a button with a movie camera icon and a still camera icon on a rounded rectangular background.</p>	<p>Mode Button:</p> <ol style="list-style-type: none"> 1. Switch between Movie Mode and Picture Mode. 2. When recording movies, press to capture the image.
 <p>The image shows a circular power button icon with a vertical line through the top curve.</p>	<p>Power Button: Press down for one second to turn on or turn off the camera.</p>
 <p>The image shows a button with a globe icon and a right-pointing arrow on a rounded rectangular background.</p>	<p>Pre-Record/Internet Button: In Record Mode, press to activate the function that the movies are recorded 3 seconds before the OK Button is pressed.</p>

LCD Monitor Information

The indicators shown below may display on LCD when movies and pictures are recorded:



(1)	Movie Resolution	
		FHD (1080p 30)
		HD (720p 30)
		WVGA 60
		VGA (4:3)
		Slow Motion (Record movies at 320x240 resolution.)
	Picture Resolution	
		High (16 MP)
		Standard (5 MP)
	Low (3 MP)	
(2)	00:05:30	Recording time of the movie that can still be taken at current resolution
	71	Number of images that can still be taken at current resolution
(3)		Self-timer enabled
		Dual Record
(4)		Stabilization
(5)		Pre-Record Mode
		Time Lapse



(6)	Scene	
		Skin
		Night
		Backlight
(7)		Macro Position Focusing
(8)		Manual White Balance
(9)		Motion Detection
(10)		Zoom meter: FHD (1080p 30):1X~10X (10X Optical zoom and 1X Digital zoom) Other video resolution:1X~40X (10X Optical zoom and 4X Digital zoom)
(11)		Option Menu
(12)		Playback Mode
(13)		Movie/Picture Record Mode
(14)	Movie Mode	
		Digital Light On
	Picture Mode	
		Flash Auto
		Red Eye Reduction
		Digital Light On
		Flash Off
(15)		SD Card Inserted
(16)		Battery: full power
		Battery: medium power
		Battery: low power
		Battery: empty power
		DC power mode







Note

Scene: B/W / Classic / Negative effect can be previewed immediately without indicator on the LCD.

Movie Recording



- In Movie Record Mode (The Movie Record LED Indicator  lights up), press OK Button to start recording. When a movie is being recorded, a time indicator will display on the LCD monitor. To stop recording, press OK Button again.
- Optional function
 1. Dual record: press Mode Button () to capture the image. The Dual record icon() appears on the LCD monitor.
- Press Playback Button to view the recorded movies.
- Four resolution settings are available:

Video Quality	
	FHD (1080p 30)
	HD (720p 30)
	WVGA 60
	VGA (4:3)

Note

- The image resolution captured during movies recording is the same as the video resolution.
- The flash can not be used when capturing image during movies recording.

Using the Pre-Record Function

- The Pre-record function ensures that you will not miss any critical recording opportunities, The movies are recorded 3 seconds before the OK Button is pressed.
- To use the Pre-Record function:
 1. Press the Pre-Record Button () in Record Mode. The Pre-Record icon() appears on the LCD monitor.
 2. Aim the camera at the subject and position it securely.
 3. Press the OK Button to start recording. (The camera records 3 seconds before you actually press the OK Button.)
- To use the function again, set it again.

Note

- Time Lapse function can not be used when the Pre-Record function is activated.

Picture Recording









- In Picture Record Mode (The Picture Record LED Indicator  lights up), press OK Button halfway down until the focusing frame turns from white to green. Then, press it fully down to take a picture.
- Press Playback Button to view the picture.
- Three resolution settings are available:

Image Quality	
	High Quality: 16 Mega Pixels
	Standard Quality: 5 Mega Pixels
	Low Quality: 3 Mega Pixels

Using Flash or Digital Light Function

- This camera has three flash settings and one setting to allow you to extend the brightness of the objects that are dark or in the shadow. Using Left Button to change the settings.
 1. **Flash Auto** (): The flash fires automatically according to light conditions. Use this mode for general photography. (Picture Recording Only)
 2. **Red Eye Reduction**(): The pre-flash will fire to reduce the red-eye effect. (Picture Recording Only)
 3. **Digital Light** (): To extend the dynamic range for backlight and high contrast sense so that the objects will be brighter and clearer.
 4. **Flash Off** (): The flash will not fire under any circumstances. Use this mode when taking images in a place where flash photography is prohibited, or when the subject is distant (beyond the range of the flash). (Picture Recording Only)



Note

The flash will be disabled automatically when the battery power is low ().

Using Zoom Function

- The zoom magnifies images when recording movies or taking pictures.
 1. To zoom in/out, press the Tele/Wide Button.
 2. It can be set from 1X~10X (10X Optical zoom and 1X Digital zoom)/1X~40X (10X Optical zoom and 4X Digital zoom)

Options for Record Menu







Movie Record Mode Menu

Movie Resolution	White Balance	Scene	Effect
<ul style="list-style-type: none"> FHD (1080p 30) HD (720p 30) WVGA60 VGA (4:3) 	<ul style="list-style-type: none"> Auto Daylight Fluorescent Tungsten 	<ul style="list-style-type: none"> Auto Skin Night Backlight B/W (Black/White) Classic Negative 	<ul style="list-style-type: none"> Stabilization Macro Mode Motion Detect. (Motion Detection) Slow Motion Time Lapse

Picture Record Mode Menu

Picture Resolution	White Balance	Scene	Effect
<ul style="list-style-type: none"> High (16MP) Std (5MP) Low (3MP) 	<ul style="list-style-type: none"> Auto Daylight Fluorescent Tungsten 	<ul style="list-style-type: none"> Auto Skin Night Backlight B/W (Black/White) Classic Negative 	<ul style="list-style-type: none"> Self-Timer Macro Mode ISO

Operations for Record Mode

Operation	Screen
<p>1. Touch  (on-screen icon) in Record Mode. The wheel menu will show on the screen.</p>	
<p>2. Scroll the wheel menu on the screen lightly with your finger to move between the options, which are Resolution, Scene, Effect, White Balance, and Setting.</p> <p>3. Submenu will pop up while stopping on each option.</p> <p>4. Touch to select the specific option you want to adjust, then touch [OK] to validate the setting.</p> <p>5. Or touch the Return icon () to exit without any change.</p> <p>6. Touch  /  on the screen to change between the pages.</p>	

Movie Resolution

Four resolution settings are available.

- **FHD (1080p 30)**: Record movies at 1920x1080p 30 resolution.
- **HD (720p 30)**: Record movies at 1280x720p 30 resolution.
- **WVGA 60**: Record movies at 848x480 60 resolution.
- **VGA(4:3)**: Record movies at 640x480p 30 resolution.

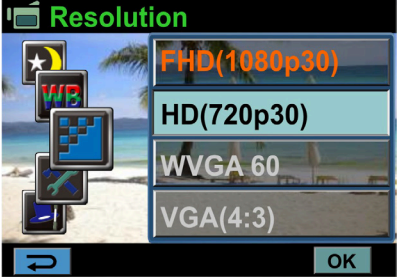
Operation	Display Screen
<ol style="list-style-type: none"> 1. In Movie Record Mode, touch  (on-screen icon) to show the wheel menu. 2. Scroll and stop on [Resolution]. The submenu of Resolution pops up. 3. Touch the desired option. 4. Touch [OK] to validate the setting. 	

Picture Resolution

Three resolution settings are available.

- **High (16MP)**: Shoot pictures at 4608x3456, 16MP quality.
- **Std (5MP)**(Standard): Shoot pictures at 2592x1944, 5MP quality.
- **Low (3MP)**: Shoot pictures at 2048 x 1536, 3MP quality.

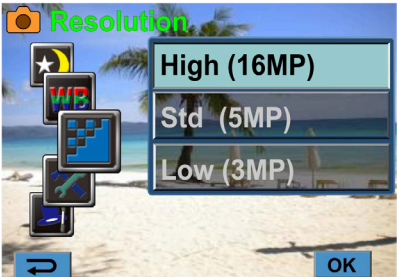
Operation	Display Screen
<ol style="list-style-type: none"> 1. In Picture Record Mode, touch  (on-screen icon) to show the wheel menu. 2. Scroll and stop on [Resolution]. The submenu of Resolution pops up. 3. Touch the desired option. 4. Touch [OK] to validate the setting. 	

White Balance

The camera adjusts the color balance of images automatically. Three manual white balance settings are available:

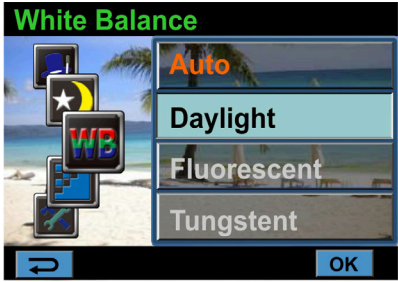

- **Auto:** The camera automatically adjusts white balance.
- **Daylight:** Under outdoor condition.
- **Fluorescent:** Under fluorescent light condition.
- **Tungsten:** Under tungsten light condition.

Operation	Display Screen
<ol style="list-style-type: none"> 1. In Movie/Picture Record Mode, touch  (on-screen icon) to show the wheel menu. 2. Scroll and stop on [White Balance]. The submenu of White Balance pops up. 3. Touch the desired option. 4. Touch [OK] to validate the setting. 	

Scene

You can select the mode according to the scene condition.

- **Auto:** Shoot without any special effect on the image.
- **Skin:** Shoot with an effect that makes skin tones more natural.
- **Night:** Use Night Mode for night scenes or low light conditions.
- **Backlight:** You can take shots when the bright light is behind the subject.
- **B/W (Black/White):** The image is converted to black-and-white.
- **Classic:** The image is converted to a sepia look.
- **Negative:** The image is converted as the negative of the normal

Operation	Display Screen
<ol style="list-style-type: none"> 1. In Movie/Picture Record Mode, touch  (on-screen icon) to show the wheel menu. 2. Scroll and stop on [Scene]. The submenu of Scene pops up. 3. Touch the desired option. 4. Touch [OK] to validate the setting. 	



Note

To avoid blurry pictures, place the camera on a flat, steady surface, or use a tripod when taking shots in the Night Mode.

Movie Effect

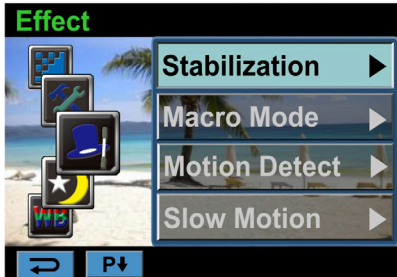
Operation	Display Screen
<ol style="list-style-type: none"> 1. In Movie Record Mode, touch  (on-screen icon) to show the wheel menu. 2. Scroll and stop on [Effect]. The submenu of Effect pops up. 3. Touch the desired Effect option to enter its option screen. 4. The Movie Effect submenu contains 5 options-- Stabilization, Macro Mode, Motion Detection, Slow Motion, and Time Lapse --for you to adjust the camera's settings. 	

Stabilization

Record with an effect of reducing camera shake to result in more stable videos.

Operation	Display Screen
<ol style="list-style-type: none"> 1. In the Effect submenu, touch [Stabilization] to enter the option screen. 2. Touch the desired option. 3. Touch [OK] to validate the setting. 	



Note

Stabilization doesn't apply on FHD(1080p 30) and WVGA60.

Macro Mode

- Auto: The camera adjusts the focus automatically.
- Macro(): The camera adjusts the focus with priority on close- up objects. Shoot in Macro mode when the objects are located in 1 cm~Infinite (setting to the Wide side)/60 cm~Infinite (setting to the Tele side).

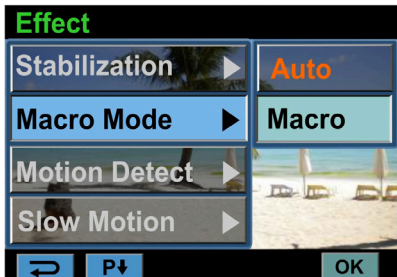
Operation	Display Screen
<ol style="list-style-type: none"> 1. In the Effect submenu, touch [Macro] to enter the option screen. 2. Touch the desired option. 3. Touch [OK] to validate the setting. 	

Motion Detection

Record videos automatically when the camera detects a movement.

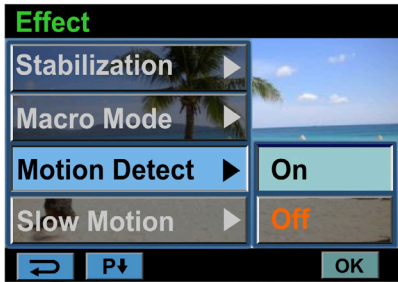
Operation	Display Screen
<ol style="list-style-type: none"> 1. In the Effect submenu, touch [Motion Detect.] to enter the option screen. 2. Touch the desired option. 3. Touch [OK] to validate the setting. 4. Camera will start to record video automatically if it detects a movement. Stop recording if it does not detect a movement. 	 <p>The screenshot shows the 'Effect' menu with 'Motion Detect' highlighted and set to 'On'. Other options include 'Stabilization', 'Macro Mode', and 'Slow Motion' (set to 'Off'). Navigation buttons like 'P+' and 'OK' are visible at the bottom.</p>

Slow Motion

Record videos with slow motion effect. When the video is played, the playback time will be longer than the actual recording time.

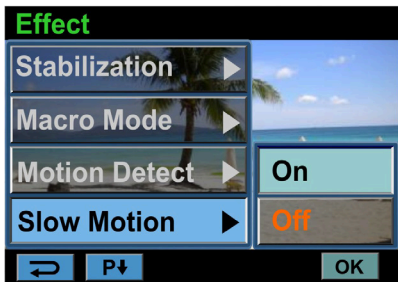
Operation	Display Screen
<ol style="list-style-type: none"> 1. In the Effect submenu, touch [Slow Motion] to enter the option screen. 2. Touch the desired option. 3. Touch [OK] to validate the setting. 	 <p>The screenshot shows the 'Effect' menu with 'Slow Motion' highlighted and set to 'Off'. Other options include 'Stabilization', 'Macro Mode', and 'Motion Detect' (set to 'On'). Navigation buttons like 'P+' and 'OK' are visible at the bottom.</p>

Time Lapse

Record still images at specific intervals you can set and play them as one movie file.

- Off: Disable Time Lapse.
- 1 Sec.: Record one frame per second.
- 3 Sec.: Record one frame every 3 seconds.
- 5 Sec.: Record one frame every 5 seconds.



Operation	Display Screen
<ol style="list-style-type: none"> 1. In the Effect submenu, touch [Time Lapse] to enter the option screen. 2. Touch the desired option. 3. Touch [OK] to validate the setting. 	 <p>The screenshot shows the 'Effect' menu with 'Time Lapse' highlighted and set to 'Off'. Other options include '1 Sec', '3 Sec', and '5 Sec'. Navigation buttons like 'P+' and 'OK' are visible at the bottom.</p>



Note

- *Stabilization function can not be used when Time Lapse function is activated.*

Picture Effect

Operation	Display Screen
<ol style="list-style-type: none"> 1. In Picture Record Mode, touch  (on-screen icon) to show the wheel menu. 2. Scroll and stop on [Effect]. The submenu of Effect pops up. 3. Touch the desired Effect option to enter its option screen. 4. The Picture Effect submenu contains 3 options --Self Timer, Macro Mode, and ISO-- for you to adjust the camera's setting. 	

Self-Timer

The self-timer allows you to take pictures with a ten-second time delay. The self-timer light on the front of the camera will also blink. The speed of blinking will increase just before the picture is taken.

Operation	Display Screen
<ol style="list-style-type: none"> 1. In the Effect submenu, touch [Self-Timer] to enter the option screen. 2. Touch the desired option. 3. Touch [OK] to validate the setting.. 	

Macro Mode

- Auto: The camera adjusts the focus automatically.
- Macro(): The camera adjusts the focus with priority on close- up objects. Shoot in Macro mode when the objects are located in 1 cm~Infinite (setting to the Wide side)/60 cm~Infinite (setting to the Tele side).

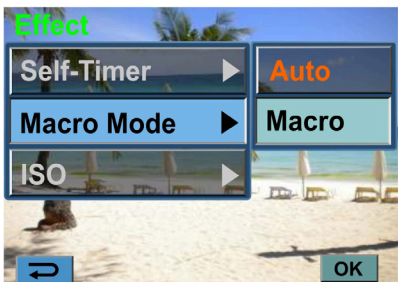
Operation	Display Screen
<ol style="list-style-type: none"> 1. In Effect submenu, touch [Macro Mode] to enter the option screen. 2. Touch the desired option. 3. Touch [OK] to validate the setting. 	

ISO

The camera adjusts the ISO sensitivity of its images automatically. Two manual ISO sensitivity settings are available. (800/1600) The larger the number is, the higher the ISO sensitivity is set to. Select a small number to shoot a smoother image. Select a large number to shoot an image in a dark location or to shoot a subject moving at high speed.

Operation	Display Screen
<ol style="list-style-type: none">1. In the Effect submenu, touch [ISO] to enter the option screen.2. Touch the desired option.3. Touch [OK] to validate the setting.	 A screenshot of a camera's 'Effect' submenu. The word 'Effect' is at the top left in green. Below it are three menu items: 'Self-Timer', 'Macro Mode', and 'ISO'. Each item has a right-pointing arrow. To the right of these items is a vertical list of options: 'Auto' (in orange), '800', and '1600'. At the bottom left of the screen is a blue circular arrow icon, and at the bottom right is a blue 'OK' button. The background of the screen shows a beach scene with palm trees and a person's legs.



Note





The image may become noisy when the ISO number is large.

Section 4

Enjoying the Playback Mode

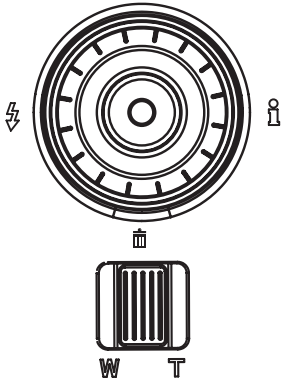
Button Function

The Buttons have the following functions in Playback Mode.







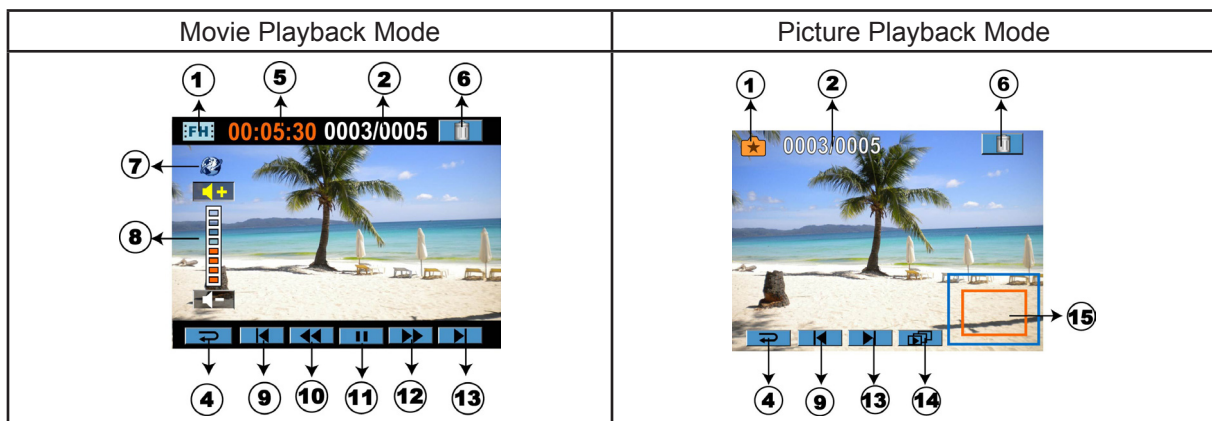
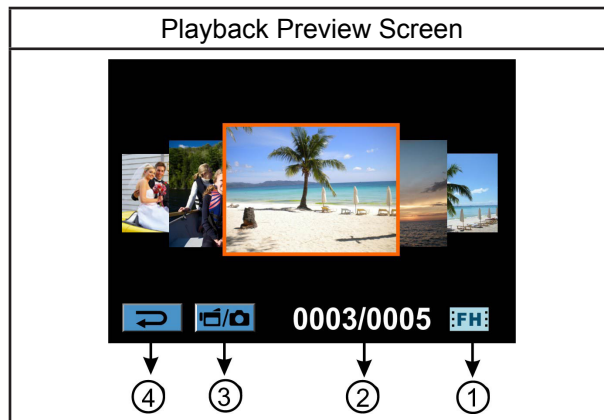







	<p>Rolling Wheel: Rotate to move to the previous/next movie/ picture.</p> <p>Right Button: LCD Information ON/OFF; Fast forward.</p> <p>Left Button: Fast rewind.</p> <p>Down Button: Delete the current movie/picture or all movies/ pictures.</p> <p>OK Button:</p> <ol style="list-style-type: none"> 1. Enter Movie/Picture Playback Mode. 2. Validate the setting. 3. In Picture Playback Mode, press to start/stop the slideshow. <p>Tele Button : Zoom In</p> <p>Wide Button : Zoom out</p>
	<p>Mode Button:</p> <ol style="list-style-type: none"> 1. Switch between Movie Preview Screen and Picture Preview Screen.
	<p>Playback Button:</p> <ol style="list-style-type: none"> 1. Switch between Record /Playback Mode. 2. Return to the previous screen.
	<p>Pre-Record/ Internet Button: In Movie Playback Mode, press to select the current movie to upload to Internet.</p>

LCD Monitor Information

Indicators on the LCD screen while in Playback Mode:









(1)	Movie Resolution	
		FHD(1080p 30)
		HD (720p 30)
		WVGA 60
		VGA (4:3)
		Slow Motion (320x240)
	Picture Resolution	
		High (16 MP)
		Standard (5MP)
		Low (3MP)
		Dual Record (The image resolution captured during movies recording is the same as the video resolution.)
(2)	0003/0005	Current number/ Total number of picture/movie.









(3)		Movie/Picture Preview Screen On
(4)		Return to the previous screen/ Switch to Record Mode
(5)	00:05:30	Movie playback time counter
(6)		Delete
(7)		Upload selected movies to Internet
(8)		Volume
(9)		Previous movie/picture
(10)		Movies fast rewind
(11)		Movies Play
		Movies Pause
(12)		Movies fast forward
(13)		Next movie/picture
(14)		Slideshow
		Slideshow stop
(15)		Magnification Indicator

Operations for Playback Mode

The Playback Mode is for viewing and managing movies and pictures on the built-in memory or on an SD Card.

Operation	Display Screen
<p>1. Press Playback Button () or press  on the screen to switch to the Playback mode.</p>	
<p>2. In the Playback preview screen, press Mode Button or touch  on the screen to switch between the Movie mode and the Picture mode.</p> <p>3. Sweep to the left to go to the previous picture/movie; sweep to the right to go to the next picture/movie.</p> <p>4. Touch on the picture/movie to go to Picture/Movie Playback Mode.</p>	 

Movie Playback



Operation	Display Screen
<p>1. When in Movie Playback mode, touch  to play or pause the movies.</p> <p>2. Sweep to the right or touch  to go to the previous movie; sweep to the left or touch  to go to the next movie.</p> <p>3. While playing movies, touch  /  to fast rewind/forward.</p> <p>4. Touch  to increase the volume; touch  to reduce the volume.</p> <p>5. Touch () to exit.</p> <p>6. Press Internet Button to select the existing movies to upload to Internet.</p>	



Note

When the LCD is idle for a few seconds, the playback function icons will disappear automatically.

Delete Movies

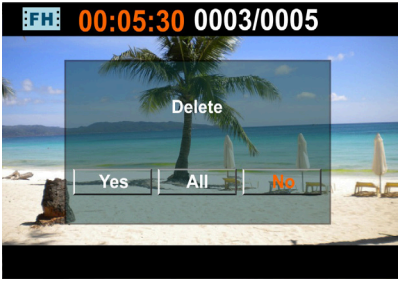
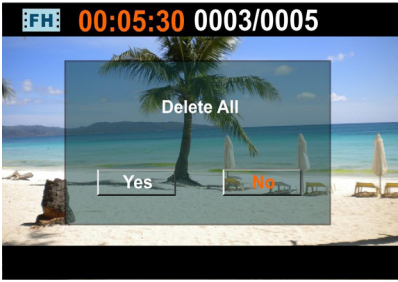





Operation	Display Screen
<p>1. Touch  to go to the Delete option screen.</p>	
<p>2. Touch [Yes] to delete the current movie or [No] to cancel the operation and to exit; touch [All] to delete all movies.</p> <p>3. Before all movies are about to be deleted, a confirmation screen will appear; touch [Yes] to execute the operation and [No] to cancel the operation.</p>	 



Note

- If a memory card has been inserted, you can only delete those movies stored on the card.
- Movies on a written-protected memory card cannot be deleted.

Picture Playback



Operation	Display Screen
<ol style="list-style-type: none"> 1. When in the Picture Playback mode, sweep to the right or touch  to go to the previous picture; sweep to the left or touch  to go to the next picture. 2. While the picture is selected, press on the screen as well as go up to enter Magnification Mode.(The magnification Indicator appears on the screen) 3. In the Magnification Mode, sweep to the top to zoom in or to the bottom to zoom out. 4. To navigate the magnified picture, press on the screen and move as well. (The inner Magnification Indicator turns red) 5. Press OK Button or sweep to the bottom to exit the magnification mode. 6. Touch  /  to start or to stop the slide show. 7. Touch ()to exit. 	



Note

When the LCD is idle for a few seconds, the slideshow function icons will disappear automatically.

Delete Picture

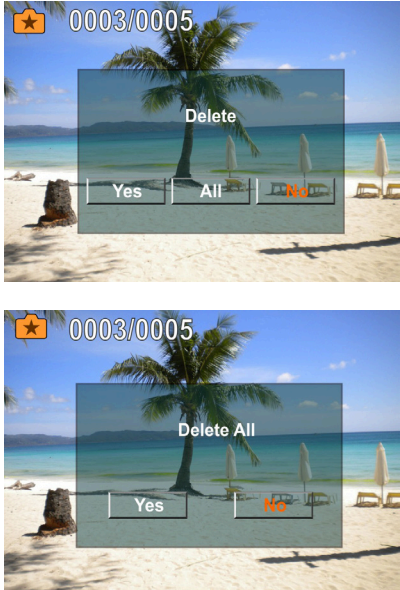
Operation	Display Screen
<p>1. Touch  to go to the Delete option screen.</p>	
<p>2. Touch [Yes] to delete the current picture or [No] to cancel the operation and to exit; touch [All] to delete all pictures.</p> <p>3. Before all pictures are deleted, a confirmation screen will appear; touch [Yes] to execute the operation and [No] to cancel the operation.</p>	





Note

- If a memory card has been inserted, you can only delete those pictures stored on the card.
- Pictures on a written-protected memory card cannot be deleted.

Section 5

Setting Your Camera

Setting Menu

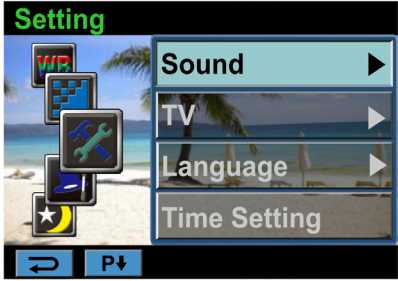
Operation	Display Screen
<ol style="list-style-type: none"> 1. Touch  (on-screen icon) when in Record Mode. The Record menu wheel will show on the screen. 2. Scroll and stop on [Setting]. The submenu of Setting pops up. 3. The Setting submenu contains 6 options for configuring your camera setup. They are Sound (operation sound), TV, Language, Time Setting, Format, and Default Setting. 4. Touch  /  on the screen to change between the pages. 	

Sound

Enable or disable the keypad tone and the operation sound.

Operation	Display Screen
<ol style="list-style-type: none"> 1. In the Setting submenu, touch [Sound] to enter the option screen. 2. Touch the desired option. 3. Touch [OK] to validate the setting. 	

TV

Ensure that the appropriate TV standard of your area is selected – either NTSC or PAL.

Wrong TV system setting may cause image flickers.

- **NTSC(60Hz)**: USA, Canada, Japan, South Korea and Taiwan, etc.
- **PAL(50Hz)**: UK, Europe, China, Australia, Singapore and Hong Kong, etc.

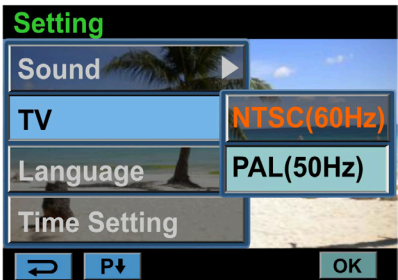
Operation	Display Screen
<ol style="list-style-type: none"> 1. In the Setting submenu, touch [TV] to enter the option screen. 2. Touch the desired option. 3. Touch [OK] to validate the setting. 	 <p>The screenshot shows the 'Setting' menu with 'TV' selected. A sub-menu is displayed with 'NTSC(60Hz)' in orange and 'PAL(50Hz)' in white. At the bottom, there are navigation buttons: a back arrow, 'P↑', 'P↓', and 'OK'.</p>

Language

Use this option to select the language of the user interface.

Operation	Display Screen
<ol style="list-style-type: none"> 1. In the Setting submenu, touch [Language] to enter the option screen. Touch P↑ / P↓ on the screen to change between the pages. 2. Touch the desired option. 3. Touch [OK] to validate the setting. 	 <p>The screenshot shows the 'Setting' menu with 'Language' selected. A sub-menu is displayed with four language options: 'Español' (orange), 'Português' (white), '简体中文' (white), and '繁體中文' (white). At the bottom, there are navigation buttons: a back arrow, 'P↑', 'P↓', 'P↑', 'P↓', and 'OK'.</p>

Time Setting

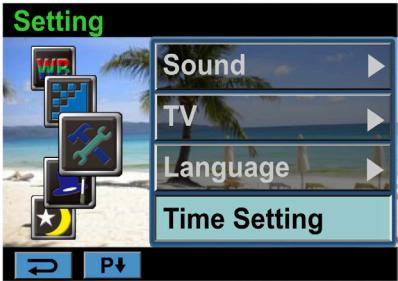
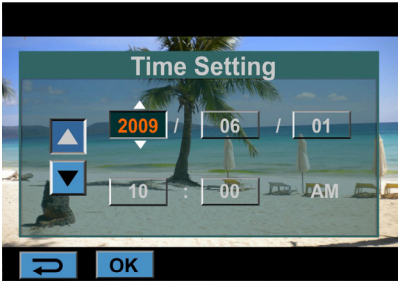
Operation	Display Screen
1. In the Setting submenu, touch [Time Setting] on the screen to go to the Time Setting menu.	
2. Touch Year, Month, Day, Hour, or Minute to set. 3. Adjust the numeric value by touching ▲ / ▼ . 4. Touch [OK] to validate the settings.	

Format

Yes: Format the built-in memory (When there is no SD card in the camera) / SD Card (When there is an SD card in the camera).

No: Do not format the built-in memory (When there is no SD card in the camera) / SD Card (When there is an SD card in the camera).

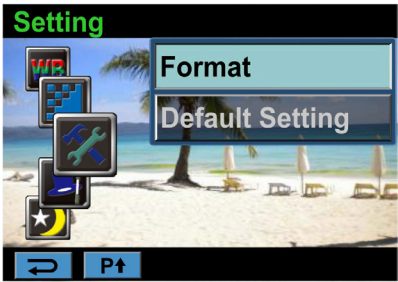
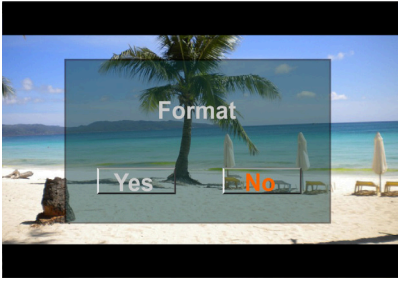
Operation	Display Screen
1. In the Setting submenu, touch [Format] on the screen to go to the format confirmation screen	
2. Touch [Yes] to execute the operation and [No] to cancel the operation.	



Note

All the data will be erased if the SD card is formatted. Make sure all the data are copied to your PC before formatting the SD card.

Default Setting

To restore the default factory setting, select this option.

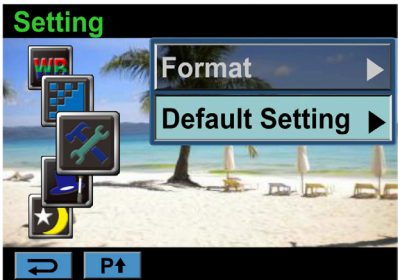
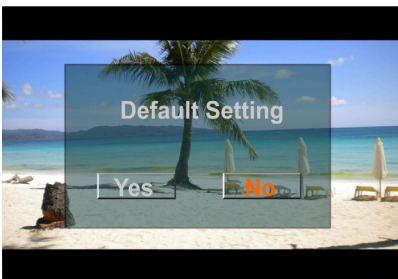
Operation	Display Screen
1. In the Setting submenu, touch [Default Setting] on the screen to go to the Default Setting confirmation screen.	
2. Touch [Yes] to execute the operation and [No] to cancel the operation.	

The following table indicates the camera's default settings

Setting	Default Factory Setting
Resolution	FHD (1080p 30) for Movie Std (5MP) for Picture
Scene	Auto
Stabilization	Off
Macro Mode	Auto
Motion Detection	Off
Slow Motion	Off
Time Lapse	Off
White Balance	Auto
Self Timer	Off
ISO	Auto
Sound	On
TV	Depends on shipping area
Language	Depends on shipping area
Volume	Level 6

Section 6

Viewing Pictures and Movies on TV

Connecting to a High-Definition 16:9(Wide) TV

1. Connect the HDMI cable to your camera's HDMI Out port.
2. Connect the other end of the cable to a television.
3. Set the video input source of your TV to "HDMI."

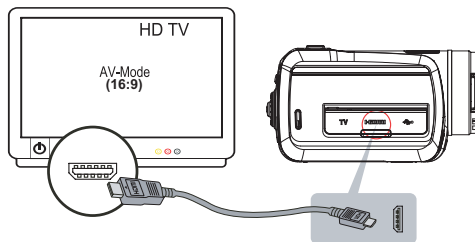

4. Use the buttons to view the stored pictures and movies on the TV.

Operation	On TV
<ol style="list-style-type: none"> 1. Press OK Button to play movies and press it again to pause. 2. While playing movies, press Right/Left Buttons to fast forward/rewind and then release the button to stop. 3. Use Up/Down Buttons to adjust the volume. 4. In the Picture Playback mode, use Tele Button to magnify the picture. To navigate the magnified picture, use Direction Buttons to navigate the magnified picture. Press OK Button to exit the magnification mode. 	



Note

The LCD Panel does not display when the camera is connected to an HDTV.

Connecting to a non-high-definition 4:3 TV

1. Connect one end of the AV cable to your camera's AV out port.
2. Connect the other end of the cable to a television.
3. Use direction button to view stored pictures and movie on a TV.

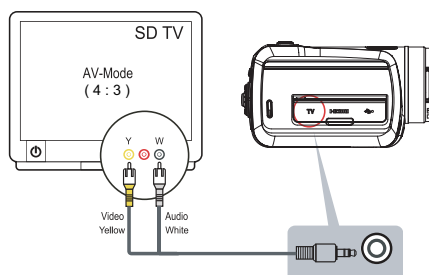

Note

The LCD Panel does not display when the camera is connected to a TV.

Section 7

Using the Software

Installing the Software

You must be connected to the internet to install and run the Vivitar Experience Image Manager software.

1. Insert the installation CD into your CD-ROM drive. The installation screen should automatically open.



2. On PC: The Vivitar Experience Image Manager Installer window appears. If the window does not appear, open the application's CD/DVD drive and click on "Setup.exe" to launch the installer.
3. On Macintosh: Click the icon that appears on the desktop to install the Vivitar Experience Image Manager.
4. If you do not have internet access at the time of inserting the CD-ROM, connect to the internet and then click the "Install Vivitar Experience Image Manager" button to begin the installation.

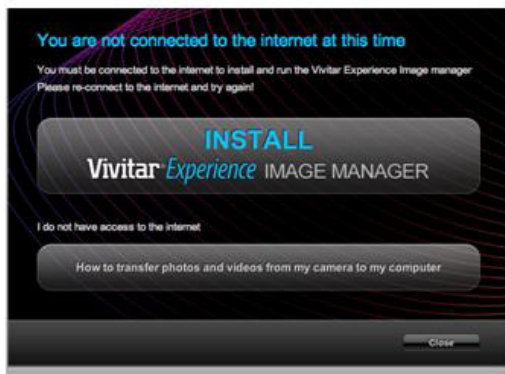

Note

- If you do not have internet access, you can still download media from the camera. Click the "How to transfer photos and videos from my camera to my computer" button for instructions.
5. If you have internet access, the "Choose your language" window opens, choose your language and click "Next" to open the next window.
 6. Select your camera model from the list and click "Next" to open the next window.
 7. Click "Next" to confirm your camera model selection and to install the application.
 8. Please wait while the application is being installed on your computer.
 9. Please review the license terms.
On PC and Macintosh: Click the "I accept the terms of this license agreement" and then click

“Next” to continue.

10. On PC only: Let the “Vivitar Experience Image Manager” installer create the folder to where the program will be installed, and then click “Install”.
11. Please wait while the application continues the installation process on your computer.
12. On PC: Click the “Close” button when the installation is complete.
Click the “Launch Vivitar Experience Image Manager” to open the application.
13. On Macintosh: Click the “Quit” button when the installation is complete.
Click the “Launch Vivitar Experience Image Manager” to open the application.
14. If you close the application you can run the Vivitar Experience Image Manager from the Programs (PC) or Applications (Mac) menu on your computer.



Connecting the Camera to a Computer

1. Use the USB cable that came with your camera to connect your camera to your computer.
2. Power the camera ON.
3. The first time you connect the device to the computer you will have to wait a few seconds until the computer recognizes the device.

Getting Photos and Videos from your Camera to your Computer

Do not disconnect the cable during transfer. Doing so will cancel the transfer of any files on their way to your computer.

1. Select the “Get Images” button from the Main menu.



2. The “Get Images from device” window opens.
3. You can select to download photos, videos or both.
4. Select your camera (removable disk) from the device window. If your camera is the only USB device connected then it will be selected automatically.
5. Select a location on the computer where to place the new photo and video files.
6. Add the new photo and video files to albums if desired.
7. Select to remove the media files from the selected device (removable disk) after the import.
8. Click the “Get Images” button to transfer the photos and videos from your camera to your computer.
9. A media download progress bar appears on the bottom left showing the number of media files downloading to your computer. A message appears when the download is complete.
10. The photo and video files that you selected are now downloaded to your computer to the selected folder and albums ready for your use.

Get Started!

Using the Vivitar Experience Image Manager, you can:

- Upload and manage photos and videos to and from the most popular photo sharing and social networking sites - Facebook, Flickr, Picasa, MySpace, Photobucket, Twitpic, Twitgoo and YouTube
- Seamlessly transfer photos and videos from one social network to another
- Organize your images by creating offline and online albums
- Edit images using automatic and manual tools
- Use automatic “Geotagging” with built in Google Maps

For more details on how to use the Vivitar Experience Image Manager open the Help file or click the “Take the Tour” button on the application’s Home page.

Section 8

Transferring Media

Transfer media: Using Windows

To transfer media from your camera to your computer manually using Windows:

1. Use the USB cable that came with your camera to connect your camera to your computer.
2. MSDC appears on the LCD.
3. A window appears with a list of options, select "Open folder to view files" and click OK.
4. Open the DCIM folder and the folder inside to view the media files.
5. Select the media and copy the files from this folder into your computer. Optionally, select the files and choose Copy from the Edit menu. Then select a folder and choose Paste from the Edit menu.
6. It is recommended that you copy the images into the Pictures/My Pictures folder and the videos into the Videos/My Videos folder.
7. Do not disconnect the cable during transfer. Doing so will cancel the transfer of any files on their way to your computer.

Transfer media: Using Macintosh

To transfer media from your camera to your computer manually using Macintosh:

1. Use the USB cable that came with your camera to connect your camera to your computer.
2. MSDC appears on the LCD.
3. The camera's device icon appears on the desktop.
4. Click on the device icon and open the DCIM folder and the folder inside to view the media files.
5. Select the files and drag them into your computer. Optionally, select the files and choose Copy from the Finder's Edit menu. Then select a folder and choose Paste from the Edit menu.
6. We recommend that you copy the images into the Pictures folder and the videos into the Movies folder.
7. Do not disconnect the cable during transfer. Doing so will cancel the transfer of any files on their way to your computer.

Section 9

Sakar Warranty Card

This warranty covers for the original consumer purchaser only and is not transferable. Products that fail to function properly **UNDER NORMAL USAGE**, due to defects in material or workmanship will be repaired at no charge for parts or labor for a period of one year from the time of purchase.

What Is Not Covered By Warranty:

Damages or malfunctions not resulting from defects in material or workmanship and damages or malfunctions from other than normal use, including but limited to, repair by unauthorized parties, tampering, modification or accident.

What to Do When Service Is Required:

When returning your defective product (postage pre-paid) for service, your package should include:

- 1) Copy of **original** bill of sale
- 2) A detailed written description of the problem.
- 3) Your return address and telephone number (Daytime)

MAIL TO ADDRESS BELOW:

<u>Sakar US</u>	<u>Sakar UK/Europe</u>	<u>Sakar Australia</u>
Sakar International Attention: Service Department 195 Carter Drive Edison, NJ 08817	Attention: Service Department 2D, Siskin Parkway East 4020 Middlemarch Business Park Coventry, CV3 4PE	Return faulty camera to the Refund Counter at the store where purchased

Section 10

Technical Support

For technical support issues please visit our website at www.vivitar.com. You can find manuals, software and FAQ's at the website. Can't find what you are looking for? E-mail us at support@vivitar.com and one of our technical support team members will answer your questions. For phone support in the US please call 1-800-592-9541, in the UK call 0800 917 4831, in Australia call 1800-006-614. If you would like to call from anywhere else, please visit www.vivitar.com for your local toll free number.

Section 11

Specifications and System Requirements

Specification	
Image sensor	5 Mega pixel CMOS sensor
Operation modes	Movie record, Picture record
Lens	f=5.95~59.5mm F2.0~2.8
Focus range	Macro mode: wide:1cm~Infinite, tele:60cm~Infinite Auto mode: wide:10 cm~Infinite, tele:100 cm~Infinite
Zoom	FHD (1080p 30):1X~10X (10X Optical zoom and 1X Digital zoom) Other video resolution:1X~40X (10X Optical zoom and 4X Digital zoom)
Shutter	Electronic
LCD monitor	3" touch LCD
Storage media	Built-in 128MB memory (partial memory is used for firmware code); SD/SDHC card slot support (up to 32GB)
Image resolution	High: 4608x3456 (16M pixels) Standard: 2592x1944 (5M pixels) Low: 2048x1536 (3M pixels)
Movie resolution	FHD (1080p 30) 1920X1080(30fps) HD (720p 30) 1280X720(30fps) WVGA60 848X480(60fps) VGA (4:3) 640X480(30fps)
White balance	Auto/Manual (Daylight, Fluorescent, Tungsten)
ISO	Auto/800/1600
Self-timer	10 seconds delay
Flash	Flash Auto/Red-Eye-Reduction/Digital Light/Flash Off
File format	Picture: JPG Movie: AVI
Image play	Single image/Slideshow
PC interface	Mini USB 2.0 port
TV out	NTSC/PAL selectable, HDMI
Battery	Lithium-ion rechargeable battery
Dimension	67.5(H) * 62.3(W) * 122(L) mm
Weight	270 g (without battery)

System requirements

- Microsoft Windows XP/Vista/7
- Intel Pentium 4, 2.4GHz or above
- 512 MB RAM
- CD-ROM Drive
- 1 GB free HDD space
- Available USB port
- 16-bit Color Display



Note

The LCD screen is manufactured using extremely high-precision technology, so over 99.99% of the pixels are operational for effective use. However, some tiny black and/or bright dots (white, red, blue or green) may appear on the LCD screen. These dots are a normal result of the manufacturing process, and do not affect the recording.

Section 12

Troubleshooting

Troubleshooting

1. If the LCD preview is not clear while shooting, how can the focus be adjusted?

Try to switch between Macro and Auto Mode.

2. The flash is not working.

The battery power is low.

The camera is in DC power mode.

3. The files on the memory card do not display smoothly when the LCD shows the “!” marking.

The “!” means the SD card is low speed or is having wrong content inside. The way to solve this condition is to format SD card by the camera instead of a PC (Please refer to the detailed Format instruction in Section 5).

4. Why is camera flash not active when taking pictures?

In the flash auto mode, the camera flash fires ONLY when necessary (e.g. in the dark).

5. Why do some of my indoor pictures look blurry and dark?

The camera extends picture exposure time under low light/ indoor condition. Keep the camera (and the target subject) steady for several seconds when taking pictures. The shutter will sound when pictures are being taken.

6. How do I charge battery?

You must use the supplied AC charger or the USB cable.

The camera must be turned OFF; blinking light confirms charging, and the light becomes constant when the charging has been completed. Then, the light will turn itself off automatically after 5 minutes. (In AC charging Mode).

7. I have taken photos and selected the “Get Images” button. I get a message that the images were successfully transferred but the photos do not appear on my computer. What do I do?

First ensure that you have in fact taken photos. Press the Shutter button to take some sample photos and then try downloading them again.

With test photos if the camera powers off before you upload them to the computer the photos are not stored in the camera’s memory. These photos should be uploaded quickly before the camera powers off. If the photos are saved to the SD memory card then all the photos should appear.

8. How do I make sure I don’t lose important pictures?

We recommend always downloading your photos to your computer as soon as possible to prevent

unintentional data loss.

9. I deleted images using the Vivitar Experience Image Manager. The images were also deleted from my computer. How do I recover images that I accidentally deleted?

All images deleted using the Vivitar Experience Image Manager are sent to your computer's Recycle or Trash Bin and can be retrieved from there.

Free Manuals Download Website

<http://myh66.com>

<http://usermanuals.us>

<http://www.somanuals.com>

<http://www.4manuals.cc>

<http://www.manual-lib.com>

<http://www.404manual.com>

<http://www.luxmanual.com>

<http://aubethermostatmanual.com>

Golf course search by state

<http://golfingnear.com>

Email search by domain

<http://emailbydomain.com>

Auto manuals search

<http://auto.somanuals.com>

TV manuals search

<http://tv.somanuals.com>