

# DVR 785HD Action Camcorder

## User Manual



**Vivitar**<sup>®</sup>  
we make it easy<sup>™</sup>

© 2009-2012 Sakar International, Inc. All rights reserved.

Windows and the Windows logo are registered trademarks of Microsoft Corporation.

All other trademarks are the property of their respective companies.

## **Contents**

Introduction .....	2
What's Included.....	3
Parts of the Camcorder .....	4
Initial Camcorder Setup.....	5
Main Camcorder Modes .....	8
Camcorder Technical Specifications.....	9
Camcorder Mounts and Accessories.....	10
Powering On Your Camcorder.....	13
Video Capture Mode .....	14
Vehicle Mounted Video Capture Mode .....	15
Photo Capture Mode .....	17
Playback Mode.....	18
Computer System Requirements .....	20
Installing the Software .....	21
Connecting the Camcorder to the Computer.....	22
Getting Videos from the Camcorder to the Computer .....	23
Getting Started! .....	24
Transferring Images Manually from the Camcorder to the Computer.....	24
Camcorder Maintenance .....	26
Sakar Warranty Card.....	26
Technical Support.....	27
Troubleshooting.....	27

## Introduction

Thank you for purchasing this Digital Action Camcorder. Everything you need to take quality digital videos and photos is included with your camcorder.

Vivitar makes capturing those special moments as easy as possible.

Please read this manual carefully first in order to get the most out of your digital camcorder.

### **NOTE:**

- Your digital action camcorder supports a Micro SD Memory Card (up to 32GB).  
In order to use your digital action camcorder normally, please insert the Micro SD Memory card before use.  
Micro SD Memory cards are not included and need to be purchased separately.
- This camera is a plug and play device. You can download the pictures and videos without the software by directly accessing the memory card from your computer. We would however recommend that you install the Vivitar Experience Image Manager software to enjoy the full Vivitar experience.

## What's Included

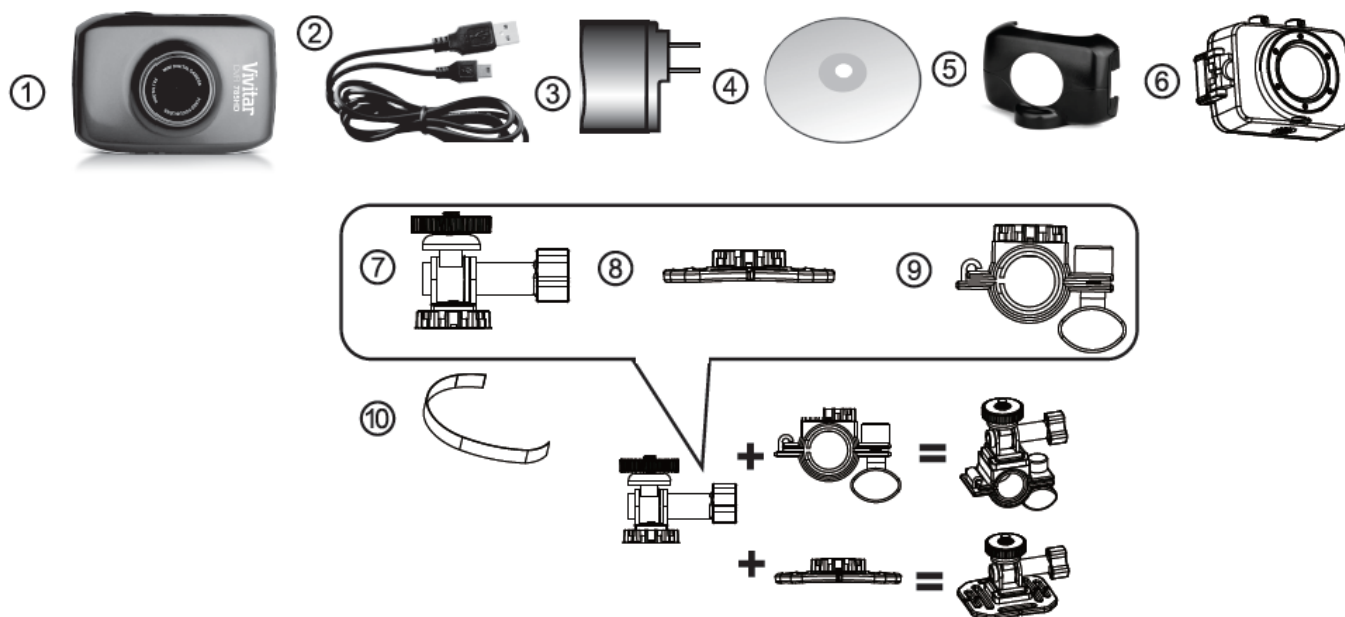

1. Digital Camcorder
2. USB Cable
3. AC Adapter
4. Vivitar Experience Installation CD
5. Stand Accessory
6. Waterproof Casing
7. Helmet and Bicycle Mount Screw
8. Helmet Mount
9. Bicycle Mount
10. Helmet Mount Strap

### NOTE:

- Built-in Lithium Battery included (not shown).
- Micro SD Card not included.

## Parts of the Camcorder

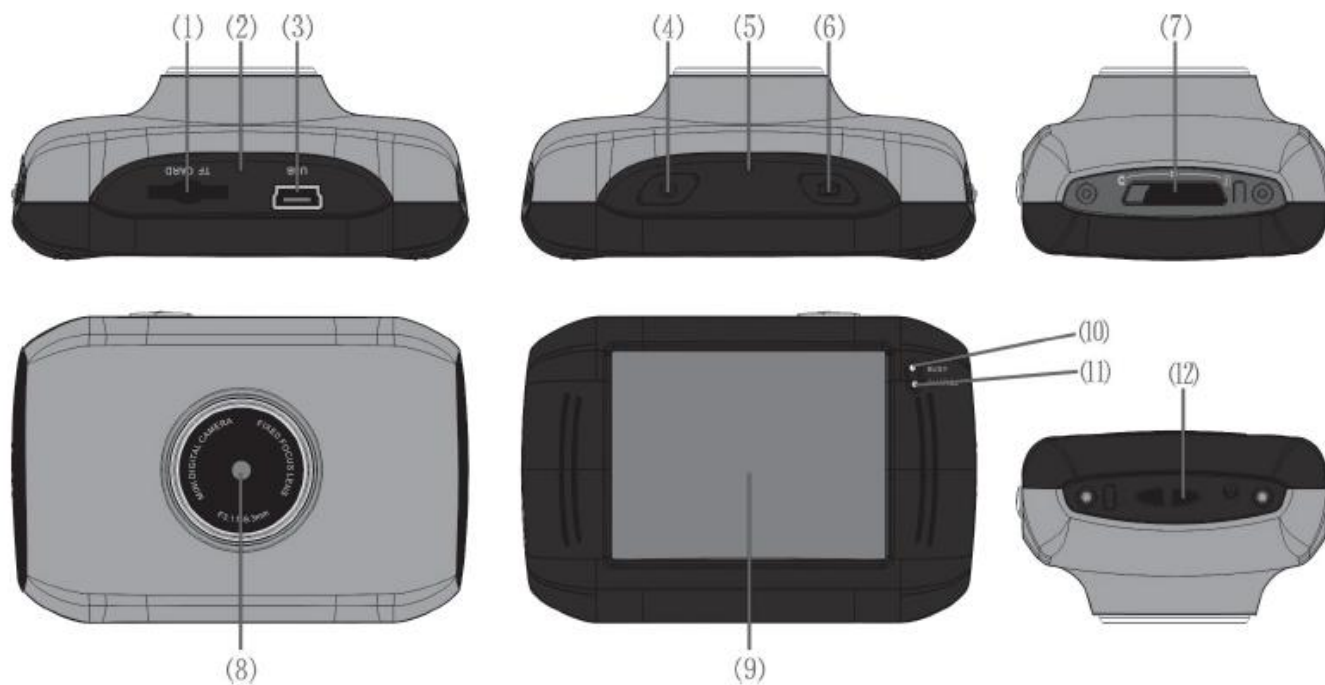

1. Micro SD Memory Card Slot
2. Reset Button
3. USB Interface
4. Power Button
5. Microphone
6. Shutter Button
7. Mode Switch: Photo, Video, Vehicle Mounted
8. Lens
9. LCD TFT Screen
10. Power Indicator/Busy LED Light
11. Charge Indicator LED Light
12. Strap Connector

# Initial Camcorder Setup

## Charging the Battery



To Charge the Built-in Lithium Battery:

- Use the supplied USB cable to connect the camcorder to the computer's USB port or to the AC Adapter.
- The charge light will turn off when the battery is fully charged.

## Installing the Micro SD Memory Card

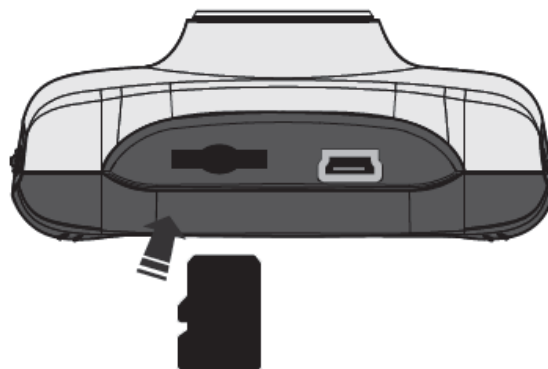

- Micro SD Memory card (up to 32GB) needed for normal use.

## Using the Camcorder

### Turning On the Camera



## **Powering the Digital Camcorder ON**





### ***Battery***

Make sure the built-in lithium battery has been fully charged before using your camcorder.

To Charge the battery:

1. Power off the camcorder.
2. Connect your camcorder to a running computer with the USB cable provided, or use the AC charger provided in the package.
3. The 'Charge' LED light lights up red indicating that your camcorder is in 'Charge' mode. The LED switches off when your camcorder is fully charged.

Battery Indicator:

Battery Indicator	Description
	The battery level is full.
	The battery level is half.
	The battery level is low, indicating to prepare for recharging the built-in lithium battery.
	If the no battery level icon shows, the battery is almost exhausted and the camcorder automatically turns off after a moments. 'Low Battery' flashes once the battery level is completely exhausted and the camcorder automatically turns off after a few seconds.

### ***Micro SD Memory Card***

Make sure a Micro SD Memory card has been properly inserted into your camcorder.

Micro SD Memory card not included.

To properly insert the Micro SD Card:

1. Power off the camcorder.
2. Insert the Micro SD Card into the Micro SD Card slot in the direction as shown on the camcorder (see SD icon by the Micro SD card slot).
3. Gently press the Micro SD Card until you hear a slight clicking sound. This indicates the memory card has been inserted correctly.



If the memory card has successfully been inserted an icon  appears on the LCD screen.

4. To remove the card, gently press on the edge of the card to release it and pull the card out.
5. If the card is inserted or removed while the camcorder's power is on, it may damage the card and/or any recorded data. Always confirm that the power is off before inserting the card into the camcorder.

### ***Power On***

Press the **POWER** button, located on top of the camcorder, to turn on the camcorder.



## Main Camcorder Modes

### Video Capture Mode

---

Use this mode to capture videos with your digital camcorder.

Slide the **MODE** Switch to the Video Capture icon to open the Video Capture Mode.

To take a video, aim your camcorder as desired and press the **Shutter** button to start recording. A blinking, red record indicator appears on the LCD screen while the recording is in progress. To stop the recording, press the **Shutter** button again. The video is automatically saved to your camcorder's memory card.

### Photo Capture Mode

---

Use this mode to capture pictures with your camcorder.

Slide the **MODE** Switch to the Photo Capture icon to open the Photo Capture Mode.

To take a picture, aim your camcorder as desired and press the **Shutter** button.

The picture is automatically saved to your camcorder's memory card.

### Vehicle Mounted Video Capture Mode

---

Use this mode to capture videos with your camcorder while you are in motion and using the helmet or bicycle mount.

Slide the **MODE** Switch to the Vehicle Mounted Capture icon to open the Vehicle Mounted Video Capture Mode.

To take a video, place the camcorder on the desired mount. Press the **Shutter** button to start recording. A blinking, red record indicator appears on the LCD screen while the recording is in progress. To stop the recording, press the **Shutter** button again. The video is automatically saved to your camcorder's memory card.

### Playback Mode (Photos & Videos)

---

Use this mode to view and manage the photos and videos on your camcorder.

Touch the **Playback** icon on the LCD screen to open the Playback mode for photos and videos. You can scroll through the photos and videos that you've previously taken to view or delete them as desired.

## Camcorder Technical Specifications

Image Sensor	CMOS Sensor
Video Resolution	HD(1280x720)@30fps VGA (640x480)@60fps
Photo Resolution	5.1MP (2592X1944) 3.0MP (2048x1536) 1.3 MP (1280x1024)
File Format	AVI (Video), JPEG (Photo)
External Memory	Micro SD Memory card, up to 32GB
LCD Display	2.0”TFT, resistive touch panel
Zoom	4X Digital Zoom
Focus Range	120CM-Infinity
ISO	Auto
Scene	Auto
White Balance	Auto
Light Exposure	Auto
Metering	Center
Auto Power Off	Yes
Interface	USB 2.0
System Requirements	Windows XP (SP3), Vista (SP1) or 7 Mac OSX v10.5.x and above
Battery	Built-in lithium battery

## Camcorder Mounts and Accessories

### Waterproof Case



1. Clamp
2. Shutter Release
3. Power Button

1. Insert a finger at the half circle of the clamp by prying the clamp up - away from the case.
2. Before sealing the case, inspect the water sealing gasket to be sure it's in good condition. You can test the gasket by closing the case without inserting the camcorder. Submerge the case completely in a bowl of water for about a minute. Remove the case from the water, dry off its exterior with a towel, then open the case. If the entire interior is dry, the case and gasket are safe for use under water.
3. There are just two buttons required for recording video and images: the **Shutter** Button and the **Power** Button.
4. Remember to put the **Mode** Switch in your desired recording position before inserting the camcorder in the waterproof case. There is no external button for the **Mode** Switch.

## Installing the Bicycle Mount: Handlebar Clamp



1. 1/4-20 Screw
2. Locking Wheel
3. Bar Clamp Bolt
4. Bar Clamp
5. Tilt Knob

1. The camcorder does not have a standard tripod mount. For all the accessories with a 1/4-20 screw, the camcorder must be enclosed in with the waterproof case or in the included mounting adapter.
2. Turn the waterproof case (or mounting adapter) clockwise onto the 1/4-20 screw of the handlebar clamp until secure.
3. Turn the Locking Wheel so it applies pressure to the case to keep the connection secure.
4. Loosen the Bar Clamp Bolt until the screw can be pushed 90° upward.
5. The bottom half of the Bar Clamp can be opened to allow you to wrap the Handlebar Clamp around the actual handlebar of your bicycle.
6. After positioning the Handlebar Clamp where you want it, close up the bottom half of the clamp and tighten the Bar Clamp Bolt.
7. Loosen the Tilt Knob, to adjust for the proper aiming angle; then tighten the knob.
8. Panning adjustments can be made by loosening the Locking Wheel, adjust the pan angle; then tighten the wheel.



## Installing the Helmet Mounting System



1. Helmet Belt
2. Helmet Mount
3. ¼-20 Screw
4. Locking Wheel
5. Tilt Knob

1. Insert the free end of the Helmet Belt through one of the slots in the base of the Helmet Mount.
2. Thread the same end in to the helmet vent and then back up to the Helmet Mount through another vent. Then insert the belt through the other side of the Helmet mount. Then insert the belt back through the helmet vent.
3. You should now have both ends of the belt inside the helmet. Take both ends of the Belt and pull to tighten and then attach together with the Velcro strap.
4. Turn the Waterproof case (or mounting adapter) onto the ¼-20 screw of the Helmet Mount until secured.
5. Turn the Locking Wheel so it applies pressure to the case to keep the connection secure.
6. Loosen the Tilt Knob, to adjust for the proper aiming angle; then tighten the knob.
7. Please note this helmet mount will only work with vented helmets.

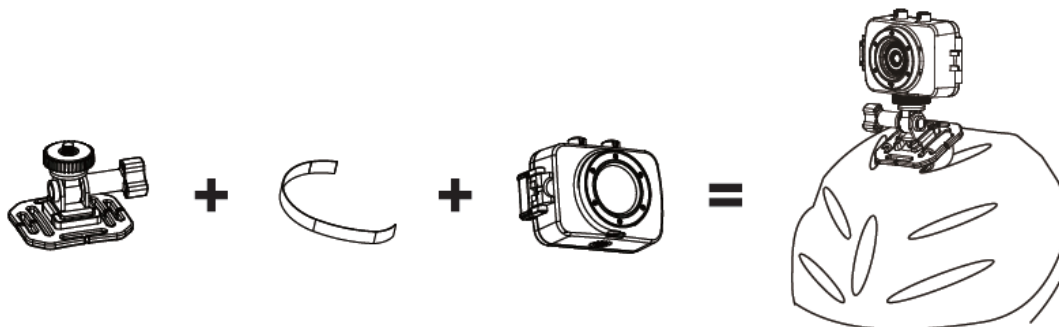

## Mounting Adapter



1. This Mounting Adapter allows you to attach mounting accessories that have a ¼-20 screw.
2. The camcorder will clip right into this adapter.

## Powering On Your Camcorder

### Turning Power On and Off

1. Press the **POWER** button to turn on the camcorder.
2. Press the **POWER** button again to turn the power off.

### Auto Power Off – Power Saving Feature:

Your digital camcorder also has an Auto Power Off power saving feature that automatically turns off your camcorder after 5 minutes that your camcorder is left idle. Once the camcorder is automatically powered off, you can press the **POWER** button to power on the camcorder.

**NOTE:** After 2 minutes of inactivity, the camcorder LCD screen turns black to save energy. The red 'Busy' LED light is on to indicate that the camcorder is in standby mode. Simply press any button or touch the LCD screen to reactivate the camcorder.



## Video Capture Mode

The Video Capture Mode allows you to capture videos with your digital camcorder.

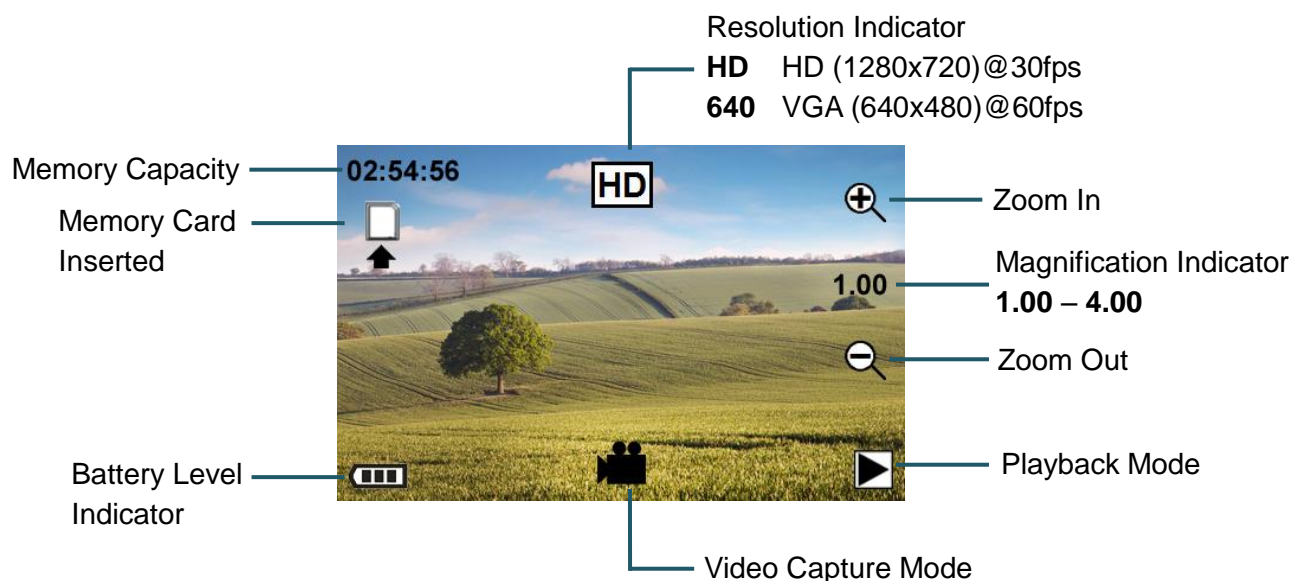
Slide the **MODE** Switch to the middle, to the Video Capture icon, in order to open the Video Capture Mode. The Video Capture icon appears on the bottom of the LCD screen.



### Taking a Video

1. While in Video Capture Mode use the LCD display to direct the camcorder at the scene you would like to capture.
2. Touch the  Zoom In or  Zoom Out in order to better set the camcorder display if desired.

**NOTE:** The Zoom magnification is indicated on the right of the LCD screen (in between the zoom in and zoom out icons).

3. To change the resolution, touch the resolution indicator located on the top, middle of the LCD screen. The resolution indicator toggles between the following resolution options:  
**HD** HD (1280x720)@30fps  
**640** VGA (640x480)@60fps
4. Press the **Shutter** button or touch the center of the LCD screen to start the video capture.
  - A red, blinking indicator appears on the top of the LCD screen indicating the recording is in progress.

- The elapsed time appears on the top left corner of the LCD screen.
5. To stop the video recording, press the **Shutter** button or touch the LCD screen again.
  6. The video is automatically saved to the camcorder's Micro SD card.

**NOTE:** When the storage capacity of the Micro SD Memory card is full, the earliest segment of video will be deleted to release the corresponding space for continuous recording.

## Vehicle Mounted Video Capture Mode

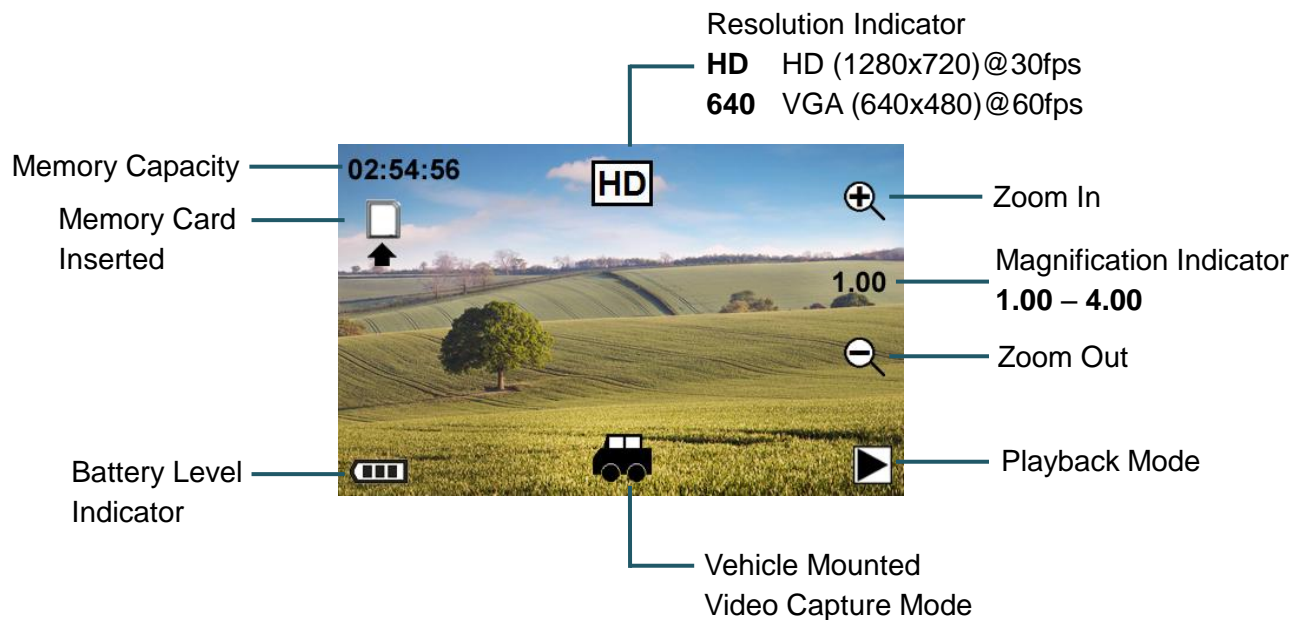

The Vehicle Mounted Video Capture Mode allows you to capture videos with your digital camcorder while you are in motion and using the camcorder with the helmet or bicycle mount. Slide the **MODE** Switch to the bottom, to the Vehicle Mounted Video Capture icon, in order to open the Vehicle Mounted Video Capture Mode. The Vehicle Mounted Video Capture icon appears on the bottom of the LCD screen.



### Taking a Video

1. While in Vehicle Mounted Video Capture Mode use the supplied mounts to place your camcorder as desired. Make sure the resolution and zoom are set before you begin recording and moving. See below for details.



2. Touch the  Zoom In or  Zoom Out in order to better set the camcorder display if desired.

**NOTE:** The Zoom magnification is indicated on the right of the LCD screen (in between the zoom in and zoom out icons).

3. To change the resolution, touch the resolution indicator located on the top, middle of the LCD screen.

The resolution indicator toggles between the following resolution options:

**HD** HD (1280x720)@30fps

**640** VGA (640x480)@60fps

4. Press the **Shutter** button or touch the center of the LCD screen to start the video capture, save a segment for recording every 5 minutes then start recording the next segment of the video.
  - A red, blinking indicator appears on the top of the LCD screen indicating the recording is in progress.
  - The elapsed time appears on the top left corner of the LCD screen.
5. To stop the video recording, press the **Shutter** button or touch the LCD screen again.
6. The video is automatically saved to the camcorder's Micro SD card.

**NOTE:** When the storage capacity of the Micro SD Memory card is full, the earliest segment of video will be deleted to release the corresponding space for continuous recording.



## Photo Capture Mode

The Photo Capture Mode allows you to capture photos with your digital camcorder.

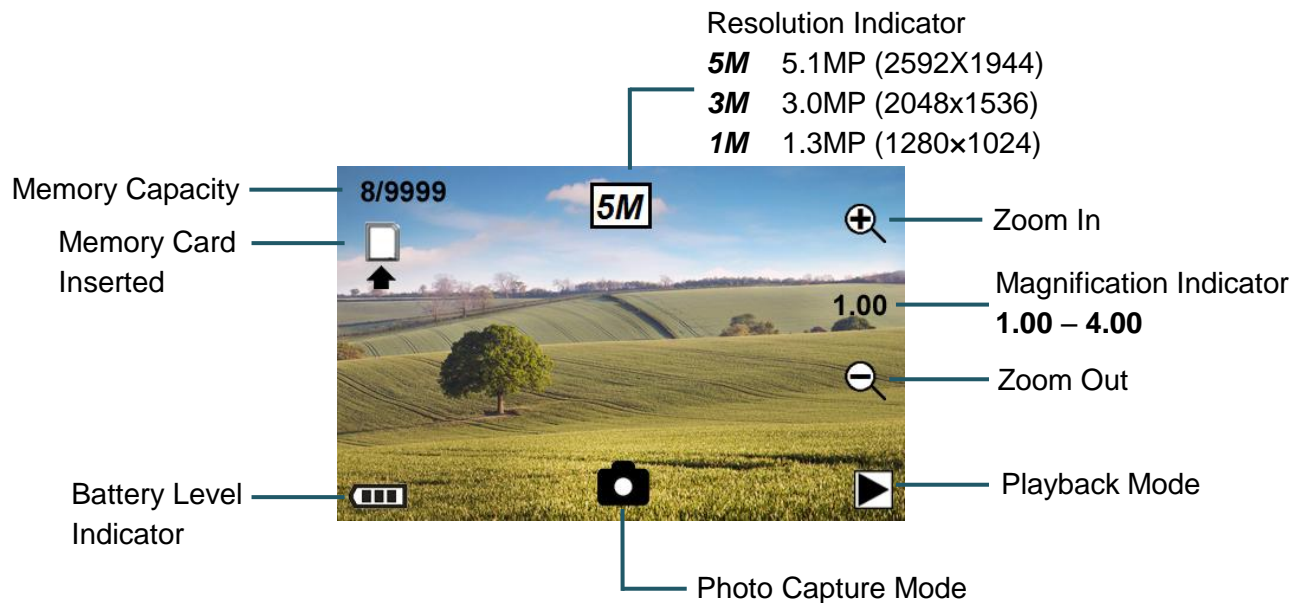
Slide the **MODE** Switch to the top, to the Photo Capture icon, in order to open the Photo Capture Mode. The Photo Capture icon appears on the bottom of the LCD screen.



### Taking a Picture

1. While in Photo Capture Mode use the LCD display to direct the camcorder at the scene you would like to capture.
2. Touch the  Zoom In or  Zoom Out in order to better set the camcorder display if desired.

**NOTE:** The Zoom magnification is indicated on the right of the LCD screen (in between the zoom in and zoom out icons).

3. To change the resolution, touch the resolution indicator located on the top, middle of the LCD screen. The resolution indicator toggles between the following resolution options:
  - 5M** 5.1MP (2592X1944)
  - 3M** 3.0MP (2048x1536)
  - 1M** 1.3MP (1280x1024)
4. Press the **Shutter** button or touch the center of the LCD screen to capture the photo.
  - The amount of photos that can be captured with the available memory appears on the top, left corner of the LCD screen.
5. The photo is automatically saved to the camcorder's Micro SD card.

## Playback Mode



The Playback mode allows you to review and delete photos and videos that you've captured with your camcorder.

When you first turn on the camcorder, the camcorder will be in Capture mode by default.

### ***To enter the Playback Mode:***

From Photo, Video, or Vehicle Mounted Video Capture Mode touch the **Playback Mode** icon on the bottom, right of the LCD screen to open the Playback Mode.

### ***To exit the Playback Mode:***

Touch the current capture mode icon (Photo , Video , or Vehicle Mounted Video ) that appears on the bottom, right of the LCD screen. The camcorder returns to the selected, current capture mode.



## Viewing Captured Images

While in Playback mode, you can scroll through your captured images to view each image.

- Touch the **RIGHT** arrow on the LCD screen to view the next image.
- Touch the **LEFT** arrow on the LCD screen to view the previous image.
- Videos appear with '**AVI**' displayed on the top, left corner of the LCD screen.  
Photos appear with '**JPG**' displayed on the top, left corner of the LCD screen.

**NOTE:** The sequence of captured images is shown on the top right of the LCD screen.

## Playing Captured Videos on Your Camcorder

1. Scroll through your captured images to select the video you would like to play.
2. Press the **Shutter** button or touch the **PLAY** arrow  to begin playing your selected video.  
The **PLAY** arrow is located on the bottom, center of the LCD screen.
3. While the video is playing:
  - Pause the video by touching **PAUSE**  located on the bottom, center of the LCD screen.  
Touch **PLAY** to continue playing the video.

- Fast forward by touching the **FAST FORWARD** right arrows▷▷, located to the right of the Play arrow on the LCD screen.
- Fast rewind by touching the **FAST REWIND** left arrows◁◁, located to the left of the Play arrow on the LCD screen.
- Stop the playing video by pressing the **Shutter** button.

**NOTE:** While the video is playing the elapsed time appears on the top, left of the LCD screen and all icons disappear.

### **Deleting Captured Images**

While in the Playback mode, you can delete captured videos and photos saved to the Micro SD Memory card in your camcorder by touching the **DELETE** icon.

1. Enter the Playback Mode.

The last captured image (video or photo) appears.

2. Touch the **DELETE** icon .

3. A “Delete This File?” message appears on the selected image.

- To delete the selected file:

Touch ‘Yes’ to automatically delete the image. The next captured image appears with the option to delete.

- To cancel:

Touch ‘No’ to return to Playback Mode without deleting the image.

**Caution:** Please use the Delete feature with care. Once images are deleted they are permanently deleted from the Micro SD card. Please make sure that you only use this feature once you have downloaded and saved all the images you wish to your computer.

## Computer System Requirements

To be able to download videos and photos to your computer, you will need the following minimum configuration:

### **WINDOWS OS**

- Microsoft® Windows XP with Service Pack 3, Windows Vista with Service Pack 1 or Windows 7
- Pentium® 4 processor (or above)
- 1 GB of RAM, 250 MB available hard disk space
- 16-bit Color monitor, 1024 X 768 recommended screen resolution
- CD-ROM Drive
- QuickTime® 6 or higher
- Microsoft® Internet Explorer 7 or higher
- Windows Media Player 10 or higher
- DirectX 9 or higher

### **MACINTOSH OS**

- Intel processor running Mac OS X v10.5.x or later
- 1 GB RAM, 250 MB available hard disk space
- Display: 1024 x 768 or higher-resolution monitor
- QuickTime® 6 or higher

### **NOTE:**

- Internet connection required.
- Make sure the latest compatible Adobe® Flash® Player is installed on your computer.

## Installing the Software

**You must be connected to the Internet to install and run the Vivitar Experience Image Manager Software.**

1. Insert the installation CD into your CD-ROM drive. The installation screen should automatically open.



2. On WINDOWS OS: The Vivitar Experience Image Manager Installer window appears. If the window does not appear, open the application's CD/DVD drive and click on "Setup.exe" to launch the installer.
3. On MACINTOSH OS: Click the icon that appears on the desktop to install the Vivitar Experience Image Manager.
4. If you do not have internet access at the time of inserting the CD-ROM, connect to the internet and then click the "Install Vivitar Experience Image Manager" button to begin the installation.



**NOTE:** If you do not have internet access, you can still download media from the camcorder. Click the "How to transfer photos and videos from my camera to my computer" button for instructions.

5. If you have internet access, the "Choose your language" window opens, choose your

language and click “Next” to open the next window.

6. Select your camera model from the list and click “Next” to open the next window.
7. Click “Next” to confirm your camera model selection and to install the application.
8. Please wait while the application is being installed on your computer.
9. Please review the license terms.

On WINDOWS OS and Macintosh: Click the “I accept the terms of this license agreement” and then click “Next” to continue.

10. On WINDOWS OS only: Let the “Vivitar Experience Image Manager” installer create the folder to where the program will be installed, and then click “Install”.
11. Please wait while the application continues the installation process on your computer.  
On MACINTOSH OS: If needed, please follow instructions to install the Adobe® Flash® Player. This requires Internet connection.

12. On WINDOWS OS: Click the “Close” button when the installation is complete.  
Click the “Launch Vivitar Experience Image Manager” to open the application.  
On MACINTOSH OS: Click the “Quit” button when the installation is complete.  
Click the “Launch Vivitar Experience Image Manager” to open the application.

13. If you close the application you can run the Vivitar Experience Image Manager from the Programs (PC) or Applications (Mac) menu on your computer.



## Connecting the Camcorder to the Computer

1. Use the supplied USB cable to connect your digital camcorder to your computer.
2. Power the camcorder ON.
3. The first time you connect the device to the computer you may have to wait a few seconds until the computer recognizes the device.

## Getting Videos from the Camcorder to the Computer

The Micro SD Memory card needs to be inserted. Do not disconnect the cable during transfer. Doing so will cancel the transfer of any files on their way to your computer.

1. Select the “Get Images” button from the Main menu.



2. The “Get media from device” window opens.
3. You can select to download videos.
4. Select your camera (removable disk) from the device window. If your camera is the only USB device connected then it will be selected automatically.
5. Select a location on the computer where to place the new video files.
6. Add the new video files to albums if desired.
7. Select to remove the media files from the selected device (removable disk) after the import.
8. Click the “Get Media” button to transfer the videos from your camera to your computer.
9. A media download progress bar appears on the bottom left showing the number of media files downloading to your computer. A message appears when the download is complete.
10. The video files that you selected are now downloaded to your computer to the selected folder ready for your use.



## Getting Started!

Using the Vivitar Experience Image Manager you can:

- Upload and manage videos to and from the most popular photo sharing and social networking sites - Facebook, Flickr, Picasa, MySpace, Photobucket, Twitpic, Twitgoo and YouTube
- Seamlessly transfer videos from one social network to another
- Organize your images by creating offline and online albums
- Edit images using automatic and manual tools
- Use automatic “Geotagging” with built in Google Maps

**For more details on how to use the Vivitar Experience Image Manager open the Help file or click the “Take a Tour” button on the application’s Home screen.**

## Transferring Images Manually from the Camcorder to the Computer

### WINDOWS OS

1. Use the supplied USB cable to connect your camcorder to your computer’s USB port.
2. Power on the camcorder. The ‘MSDC’ connection icon  displays on the LCD screen.
3. A window appears on your computer with a list of options, select “Open folder to view files” and click ‘OK’.
4. Open the DCIM folder and the folder inside to view the media files.
5. Select the media and copy the files from this folder into your computer. Optionally, select the files and choose ‘Copy’ from the Edit menu. Then select a folder and choose ‘Paste’ from the Edit menu.
6. We recommend that you copy the photos into the Pictures/My Pictures folder and the videos into the Videos/My Videos folder.
7. Do not disconnect the cable during transfer. Doing so will cancel the transfer of any files on their way to your computer.

## **MACINTOSH**

1. Use the supplied USB cable to connect your camcorder to your computer's USB port.
2. Power on the camcorder. The 'MSDC' connection icon  displays on the LCD screen.
3. The camcorder's device icon appears on the desktop.
4. Click on the device icon and open the DCIM folder and the folder inside to view the media files.
5. Select the files and drag them into your computer. Optionally, select the files and choose 'Copy' from the Finder's Edit menu. Then select a folder and choose 'Paste' from the Edit menu.
6. We recommend that you copy the photos into the Pictures folder and the videos into the Movies folder.
7. Do not disconnect the cable during transfer. Doing so will cancel the transfer of any files on their way to your computer.

## **Transferring Photos and Videos: Apple iPad**

**NOTE:** Please check your device packaging for compatibility with the iPad.

### ***Apple iPad Camera Connection:***

For models that are compatible with the iPad, photos and videos can be imported from your digital camcorder to your iPad by following either one of the options below:

1. Connecting your digital camcorder to your iPad using an iPad Camera Connector:

Plug the Camera Connector into the dock connector port on your iPad, then attach your digital camcorder using a USB cable (included) to the Camera Connector.

**NOTE:** iPad Camera Connector not included. This may be purchased separately.

2. Using an iPad SD Card Reader:

Connect the SD Card Reader to your iPad, then insert your digital camcorder's Micro SD Memory card into the slot to import photos and videos directly from your camera's SD card.

**NOTE:** iPad SD Card Reader not included. This may be purchased separately.

After you make the connection, your iPad automatically opens the Photos application. This allows you choose which photos and videos to import, then organizes them into albums.

## Camcorder Maintenance

The digital camcorder is a delicate device.

Please handle your camcorder with care to avoid damaging it.

Do not expose your camcorder to heat sources.

Do not use your camcorder in wet or moist conditions without the waterproof casing.

## Sakar Warranty Card

This warranty covers for the original consumer purchaser only and is not transferable. Products that fail to function properly **UNDER NORMAL USAGE**, due to defects in material or workmanship will be repaired at no charge for parts or labor for a period of one year from the time of purchase.

### What Is Not Covered By Warranty:

Damages or malfunctions not resulting from defects in material or workmanship and damages or malfunctions from other than normal use, including but limited to, repair by unauthorized parties, tampering, modification or accident.

### What to Do When Service Is Required:

When returning your defective product (postage pre-paid) for service, your package should include:

1. Copy of **original** bill of sale.
2. A detailed written description of the problem.
3. Your return address and telephone number (Daytime).

MAIL TO ADDRESS BELOW:

<u>Sakar US</u> Sakar International Attention: Service Department 195 Carter Drive Edison, NJ 08817	<u>Sakar UK/Europe</u> Attention: Service Department 2D, Siskin Parkway East 4020 Middlemarch Business Park Coventry, CV3 4PE	<u>Sakar Australia</u> Return faulty camera to the Refund Counter at the store where purchased
--	---	--

## Technical Support

For technical support issues please visit our website at **www.vivitar.com**. You can find manuals, software and FAQ's at the website. Can't find what you are looking for? E-mail us at **support@vivitar.com** and one of our technical support team members will answer your questions. For phone support in the US please call 1-800-592-9541, in the UK call 0800 917 4831, in Australia call 1800-006-614. If you would like to call from anywhere else, please visit **www.vivitar.com** for your local toll free number.

## Troubleshooting

**Q: I have taken photos and selected the "Get Images" button. I get a message that the images were successfully transferred but the photos do not appear on my computer.**

**What do I do?**

First ensure that you have in fact taken photos. Press the Shutter button to take some sample photos or videos and then try downloading them again.

If the photos are saved to the SD memory card then all the photos should appear.

**Q: How do I make sure I don't lose important pictures?**

This camcorder requires a Micro SD card for normal use. If the camera powers off nothing will happen to the images stored on the memory card. We recommend always downloading your photos and videos to your computer as soon as possible to prevent unintentional data loss.

**Q: I deleted images using the Vivitar Experience Image Manager. The images were also deleted from my computer. How do I recover images that I accidentally deleted?**

All images deleted using the Vivitar Experience Image Manager are sent to your computer's Recycle or Trash Bin and can be retrieved from there.

## Free Manuals Download Website

<http://myh66.com>

<http://usermanuals.us>

<http://www.somanuals.com>

<http://www.4manuals.cc>

<http://www.manual-lib.com>

<http://www.404manual.com>

<http://www.luxmanual.com>

<http://aubethermostatmanual.com>

Golf course search by state

<http://golfingnear.com>

Email search by domain

<http://emailbydomain.com>

Auto manuals search

<http://auto.somanuals.com>

TV manuals search

<http://tv.somanuals.com>