

Operating Guide | Warranty

Model Number | C27J28C | Direct View TV



© Copyright 2003, Zenith Electronics Corporation



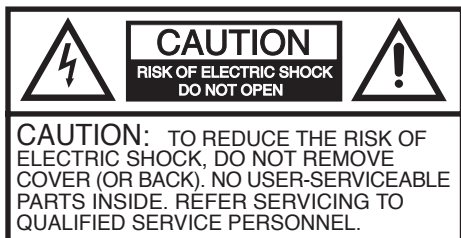

The lightning flash with arrowhead symbol, within an equilateral triangle is intended to alert the user to the presence of uninsulated dangerous voltage within the product's enclosure that may be of sufficient magnitude to constitute a risk of electric shock.



The exclamation point within an equilateral triangle is intended to alert the user to the presence of important operating and maintenance (servicing) instructions in the literature accompanying the appliance.

CAUTION: Changes or modifications not expressly approved by the party responsible for compliance with the FCC Rules could void the user's authority to operate this equipment.

WARNING: TO PREVENT FIRE OR SHOCK HAZARD, DO NOT EXPOSE THIS APPLIANCE TO RAIN OR MOISTURE.

IMPORTANT SAFEGUARDS

1. READ INSTRUCTIONS

All the safety and operating instructions should be read before the unit is operated.

2. RETAIN INSTRUCTIONS

The safety and operating instructions should be retained for future reference.

3. HEED WARNINGS

All warnings on the unit and in the operating instructions should be adhered to.

4. FOLLOW INSTRUCTIONS

All operating and use instructions should be followed.

5. CLEANING

Unplug this unit from the wall outlet before cleaning. Do not use liquid cleaners or aerosol cleaners. Use a damp cloth for cleaning the exterior cabinet only.

6. ATTACHMENTS

The manufacturer of this unit does not make any recommendations for attachments, as they may cause hazards.

7. WATER AND MOISTURE

Do not use this unit near water. For example, near a bathtub, washbowl, kitchen sink, laundry tub, in a wet basement, or near a swimming pool.

8. ACCESSORIES

Do not place this unit on an unstable cart, stand, tripod, bracket, or table.

The unit may fall, causing serious injury, and serious damage to the unit.

- 8A.** An appliance and cart combination should be moved with care. Quick stops, excessive force, and uneven surfaces may cause the appliance and cart combination to overturn.

9. VENTILATION

Slots and openings in the cabinet back or bottom are provided for ventilation, to ensure reliable operation of the unit and to protect it from overheating. These openings must not be blocked or covered. The openings should never be blocked by placing the unit on a bed, sofa, rug, or other similar surface. This unit should never be placed near or over a radiator or heat source. This unit should not be placed in a built-in installation, such as a bookcase, or rack unless proper ventilation is provided or the manufacturer's instructions have been adhered to.

10. POWER SOURCE

This unit should be operated only from the type of power source indicated on the rating plate. If you are not sure of the type of power supply to your home, consult your appliance dealer or local power company. For units intended to operate from battery power, or other sources, refer to the operating instructions.

11. GROUNDING OR POLARIZATION

This unit is equipped with a polarized alternating current line plug (a plug having one blade wider than the other). This plug will fit into the power outlet only one way. This is a safety feature. If you are unable to insert the plug fully into the outlet, try reversing the plug. If the plug should still fail to fit, contact your electrician to replace your obsolete outlet. Do not defeat the safety purpose of the polarized plug. If your unit is equipped with a 3-wire grounding-type plug, a plug having a third (grounding) pin, this plug will only fit into a grounding-type power outlet. This too, is a safety feature. If you are unable to insert the plug into the outlet, contact your electrician to replace your obsolete outlet. Do not defeat the safety purpose of the grounding-type plug.

12. POWER-CORD PROTECTION

Power-supply cords should be routed so that they are not likely to be walked on or pinched by items placed upon or against them, paying particular attention to cords at plugs, convenience receptacles, and the point where they exit from the appliance.

PORTABLE CART WARNING
(symbol provided by RETAC)



S3126A

13. LIGHTNING

To protect your unit during a lightning storm, or when it is left unattended and unused for long periods of time, unplug it from the wall outlet and disconnect the antenna or cable system. This will prevent damage to the unit due to lightning and power line surges.

14. POWER LINES

An outside antenna system should not be located in the vicinity of overhead power lines, other electric light or power circuits, or where it can fall into such power lines or circuits. When installing an outside antenna system, extreme care should be taken to keep from touching such power lines or circuits as contact with them might be fatal.

15. OVERLOADING

Do not overload wall outlets and extension cords as this can result in a risk of fire or electric shock.

16. OBJECT AND LIQUID ENTRY

Do not push objects through any openings in this unit as they may touch dangerous voltage points or short out parts that could result in fire or electric shock. Never spill or spray any type of liquid into the unit.

17. OUTDOOR ANTENNA GROUNDING

If an outside antenna or cable system is connected to the unit, be sure the antenna or cable system is grounded to provide some protection against voltage surges and built-up static charges. Section 810 of the National Electrical Code, ANSI/NFPA 70, provides information with respect to proper grounding of the mast and supporting structure, grounding of the lead-in wire to an antenna discharge unit, size of grounding conductors, location of antenna discharge unit, connection to grounding electrodes, and requirements for the grounding electrode.

EXAMPLE OF ANTENNA GROUNDING AS PER NATIONAL ELECTRICAL CODE

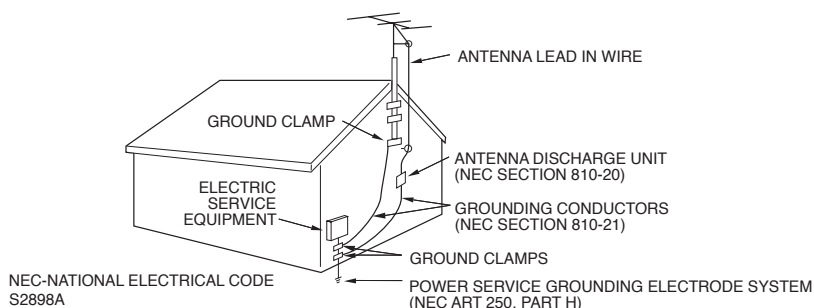

18. SERVICING

Do not attempt to service this unit yourself as opening or removing covers may expose you to dangerous voltage or other hazards. Refer all servicing to qualified service personnel.

19. DAMAGE REQUIRING SERVICE

Unplug this unit from the wall outlet and refer servicing to qualified service personnel under the following conditions:

- When the power-supply cord or plug is damaged.
- If liquid has been spilled, or objects have fallen into the unit.
- If the unit has been exposed to rain or water.
- If the unit does not operate normally by following the operating instructions. Adjust only those controls that are covered by the operating instructions, as an improper adjustment of other controls may result in damage and will often require extensive work by a qualified technician to restore the unit to its normal operation.
- If the unit has been dropped or the cabinet has been damaged.
- When the unit exhibits a distinct change in performance, this indicates a need for service.

20. REPLACEMENT PARTS

When replacement parts are required, be sure the service technician uses replacement parts specified by the manufacturer or those that have the same characteristics as the original part.

Unauthorized substitutions may result in fire, electric shock or other hazards.

21. SAFETY CHECK

Upon completion of any service or repairs to this unit, ask the service technician to perform safety checks to determine that the unit is in proper operating condition.

22. HEAT

The product should be situated away from heat sources such as radiators, heat registers, stoves, or other products (including amplifiers) that produce heat.

23. NOTE TO CATV SYSTEM INSTALLER

This reminder is provided to call the CATV system installer's attention to Article 820-40 of the NEC that provides guidelines for proper grounding and, in particular, specifies that the cable ground shall be connected to the grounding system of the building, as close to the point of cable entry as practical.

Contents

PREPARATIONS

IMPORTANT SAFEGUARDS	2
Contents	4
Features	5
Power source	5
Parts and functions.....	6
Remote control	7
Antenna connections.....	8
Cable TV connections	9
Connections to other equipment	10
Selecting the VIDEO input source	12
Setting the language	13
Memorizing channels	14

OPERATION

TV operation.....	17
Setting the V-Chip	19
Setting the clock	23
Setting the picture size	24
Picture control adjustment/Resetting your picture adjustment	25
Closed Caption.....	26
CC Setting (DIGITAL MODE)	28
CC advanced.....	29
Selecting Stereo/Second Audio Program (SAP)	30
Selecting the audio language (DIGITAL MODE)	31
Using the auto shut off feature	32

OTHERS

Troubleshooting.....	33
Specifications	33
Warranty	34

High Quality Picture Horizontal Resolution more than 500 lines exceeds Super VHS (400 lines) or Laser Disc (430 lines) in resolution.

- **Integrated Digital Tuner** - You can view digital broadcasts without using a Digital TV Set-Top Box.
- **Closed Caption Decoder With Full Text Mode** - Displays text captions or full screen text on the screen for hearing impaired viewers.
- **Picture Adjustments Using The Remote Control** - The On-Screen display allows precise remote control adjustment of BRIGHTNESS, CONTRAST, COLOR, TINT and SHARPNESS.
- **Programmable TV Sleep Timer** - Operable from the remote control, the TV can be programmed for up to 120 minutes to turn off automatically.
- **V-Chip** - The V-Chip function can read the rating of a TV program or movie content if the program is encoded with this information. V-chip will allow you to set a restriction level.
- **Stereo/SAP Reception** - This TV is designed to receive stereo and second audio program (SAP) broadcasts where available.
- **S-Video/Component Video jacks** - A VCR, DVD player, satellite receiver or other audio/video component can be connected to this unit.
- **Video Input Jacks** - This unit is equipped with 3 types of video input jacks. The component video in jacks and S-video in jack enable you to watch the DVD player or the video devices with a high quality picture.
- **On-Screen 3 Language Display** - You can select one of 3 languages, English, Spanish or French for on-screen programming.

Manufactured under license from Dolby Laboratories.

Power source

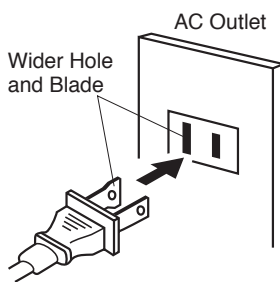

Polarized AC Cord Plug
(One blade is wider than the other)

TO USE AC POWER SOURCE

Use the AC polarized line cord provided for operation on AC. Insert the AC cord plug into a standard 120V 60Hz polarized AC outlet.

NOTES:

- Never connect the AC line cord plug to other than the specified voltage (120V 60Hz). Use the attached power cord only.
- If the polarized AC cord does not fit into a non-polarized AC outlet, do not attempt to file or cut the blade. It is the user's responsibility to have an electrician replace the obsolete outlet.
- If you cause a static discharge when touching the unit and the unit fails to function, simply unplug the unit from the AC outlet and plug it back in. The unit should return to normal operation.

Parts and functions

Front

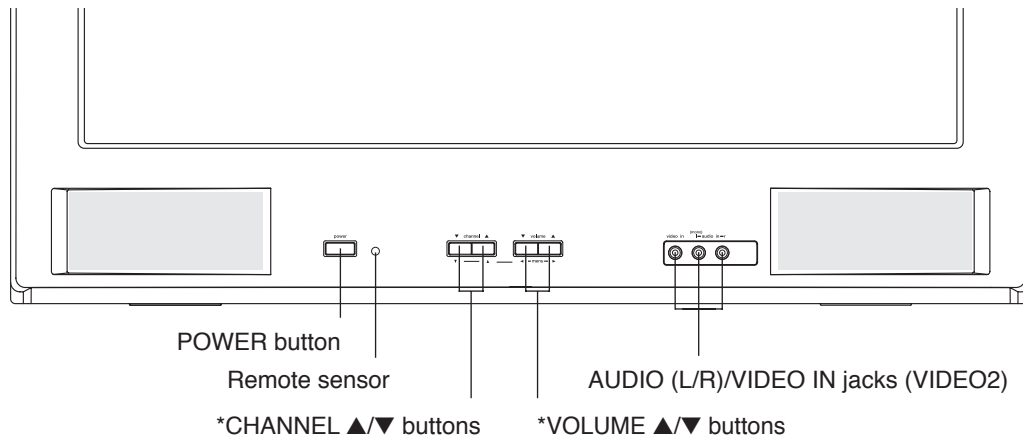

* To display the menu screen.

Press both VOLUME ▲/▼ buttons at the same time to display the menu screen.

CHANNEL ▲/▼ buttons and VOLUME ▲/▼ buttons can be used to select the desired setting during the menu screen operations.

Rear

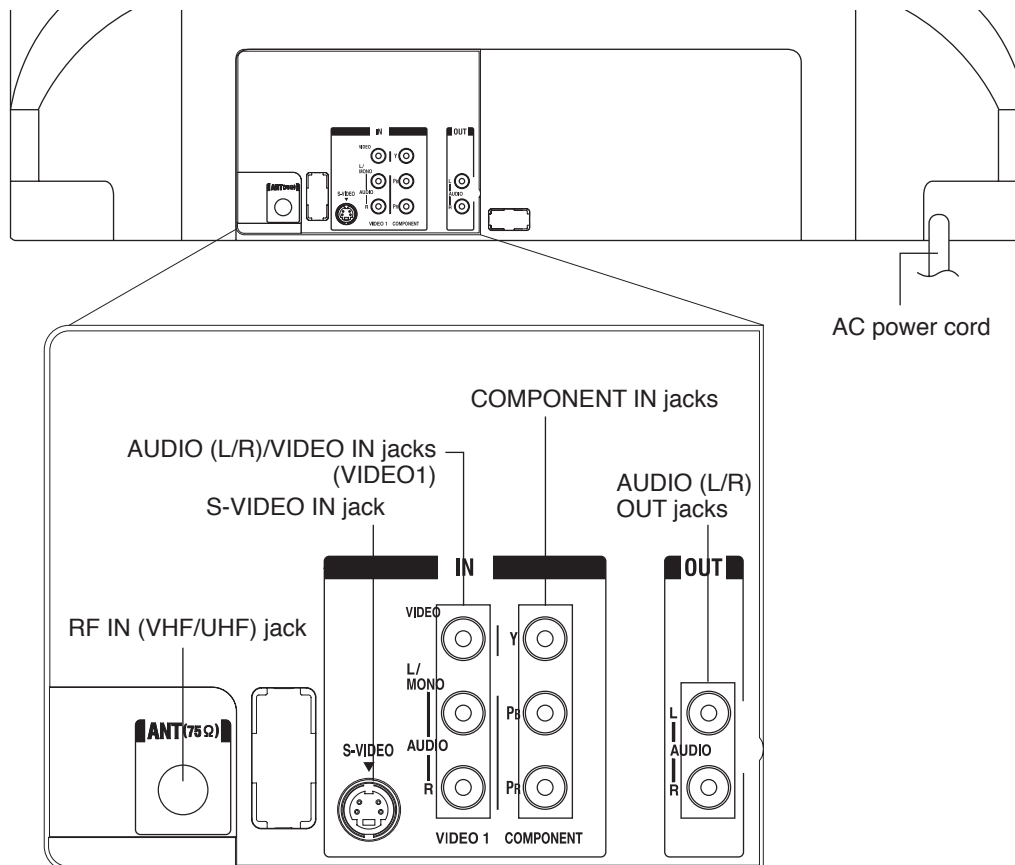

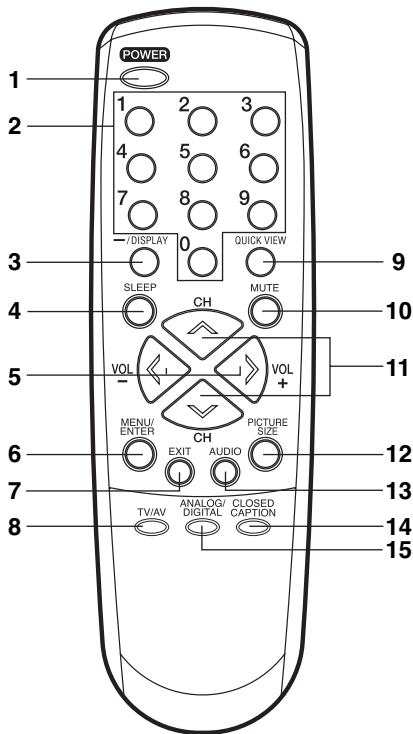

1. **POWER Button** - Press to turn the power on/off to the TV.
2. **Direct Channel Selection Buttons (0-9)** - Allow direct access to any channel.
3. **-/DISPLAY Button** - When the TV is receiving an analog signal pressing this button will display the current information on-screen. When the TV is receiving a digital signal, pressing this button once will display the digital information on-screen; pressing it a second time will display the analog information on-screen. To remove

- the display from the screen, press this button again. This button is also the “-” button used when selecting digital channels.
4. **SLEEP Button** - To set the TV to turn off after a preset amount of time, press the SLEEP button. The clock will count up 10 minutes each time the button is pressed in the order of 0, 10, 20, ...100, 110, 120. After the sleep time is programmed, the display will disappear then reappear momentarily every ten minutes to remind you the sleep timer function is operating. To confirm the sleep time setting, press the SLEEP button once and the remaining time will be momentarily displayed. To cancel sleep time, press the SLEEP button repeatedly until the display turns to 0.
5. **VOL (VOLUME) + / - Buttons** - Press the “+” button to increase, or the “-” button to decrease the volume level. Use to select the desired setting during the menu screen operation.
6. **MENU/ENTER Button** - Press to display the menu screen. While in the on-screen menu, press to enter or select options.
7. **EXIT Button** - Press to exit the menu screen.
8. **TV/AV Button** - Press this button to display SOURCE SELECTION menu to select the video input source.
9. **QUICK VIEW Button** - This button allows you to go back to the previous channel selected by pressing the QUICK VIEW button. Press this button again to return to the channel you were watching.
10. **MUTE Button** - To turn off the sound, press this button once. The TV will be silenced and the symbol “MUTE” will appear on the screen. The muting feature can be released by pressing the MUTE button again or one of the VOL + or - buttons.
11. **CH (CHANNEL) ^ / v Buttons** - Press the ^ button to change to a higher numbered channel set into memory. Press the v button to change to a lower numbered channel set into memory. Use to select the desired setting during the menu screen operation.
12. **PICTURE SIZE Button** - Press to change the picture size.
13. **AUDIO Button** - Press to select the desired audio setting.
14. **CLOSED CAPTION Button** - Press this button to display CLOSED CAPTION menu.
15. **ANALOG/DIGITAL Button** - Press to select analog/digital mode.

Before using the remote control, batteries must first be installed.

HOW TO INSTALL BATTERIES

1. Open the battery compartment cover.

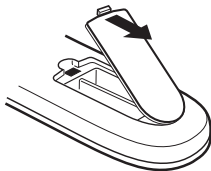

2. Install two “AAA” batteries (not supplied).

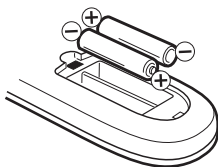

3. Replace the battery compartment cover.

Use two “AAA” size batteries (not supplied). The batteries may last approximately one year depending on how much the remote control is used. For best performance, it is recommended that batteries should be replaced on a yearly basis, or when the remote operation becomes erratic. Do not mix old and new batteries or different types.

BATTERY PRECAUTIONS

These precautions should be followed when using batteries in this device:

- Use only the size and type of batteries specified.
- Be sure to follow the correct polarity when installing the batteries as indicated in the battery compartment. Reversed batteries may cause damage to the device.
- Do not mix different types of batteries together (e.g. Alkaline and Carbon-zinc) or old batteries with fresh ones.
- If the device is not to be used for a long period of time, remove the batteries to prevent damage or injury from possible battery leakage.
- Do not try to recharge batteries not intended to be recharged; they can overheat and rupture (follow battery manufacturer’s directions).

Antenna connections

If you are using an indoor or outdoor antenna, follow the instructions below that correspond to your antenna system. If you are using a cable TV service (CABLE), see page 9 for Cable TV connections.

Combination VHF/UHF Antenna (Single 75 ohm Cable or 300 ohm Twin-lead Wire)

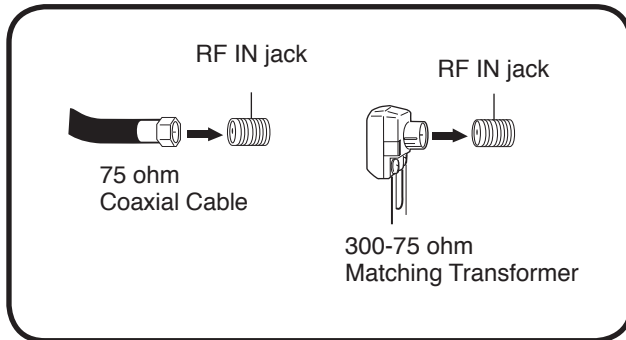

Connect the 75 ohm Cable from the Combination VHF/UHF Antenna to the RF IN Jack.

If your Combination VHF/UHF Antenna has a 300 ohm Twin-lead Wire, the use of the 300-75 ohm Matching Transformer may be necessary.

Combination VHF/UHF Antenna (Separate VHF and UHF 300 ohm Twin-lead Wires)

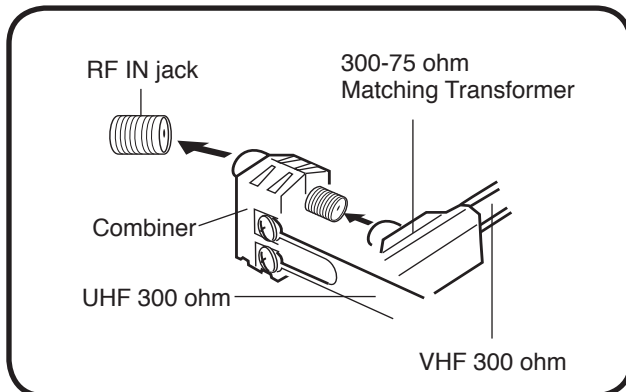

Connect the UHF 300 ohm Twin-lead Wire to the Combiner (not supplied). Connect the VHF 300 ohm Twin-lead Wire to the 300-75 ohm Matching Transformer. Attach the Transformer to the Combiner, then attach the Combiner to the RF IN Jack.

Separate VHF/UHF Antennas (75 ohm VHF Cable and 300 ohm UHF Twin-lead Wires)

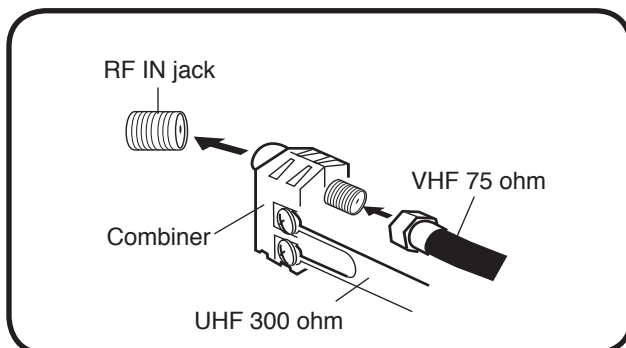

Connect the VHF 75 ohm cable and UHF 300 ohm Twin-lead Wire to the Combiner. Attach the Combiner to the RF IN Jack.

Cable TV connections

This unit has an extended tuning range and can tune most cable channels without using a Cable TV Converter box. Some Cable TV companies offer "premium pay channels" in which the signal is scrambled. Descrambling these signals for normal viewing requires the use of a descrambler device which is generally provided by the Cable TV company.

FOR SUBSCRIBERS TO BASIC CABLE TV SERVICE

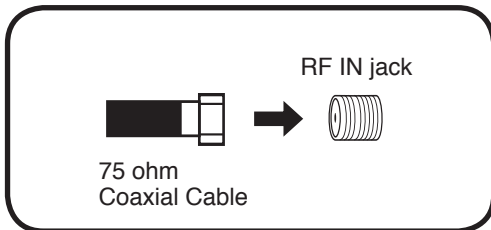

For basic cable service not requiring a Converter/Descrambler box, connect the 75 ohm Coaxial Cable directly to the RF IN Jack on the back of the unit.

FOR SUBSCRIBERS TO SCRAMBLED CABLE TV SERVICE

If you subscribe to a Cable TV service which requires the use of a Converter/Descrambler box, connect the incoming 75 ohm Coaxial Cable to the Converter/Descrambler box. Using another 75 ohm Coaxial Cable, connect the output jack of the Converter/Descrambler box to the RF IN Jack on the unit. Follow the connections shown below. Set the unit to the output channel of the Converter/Descrambler box (usually channel 3 or 4) and use the Converter/Descrambler box to select channels.

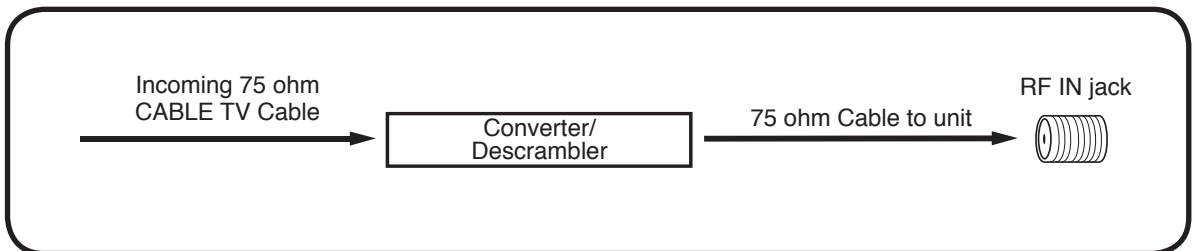

FOR SUBSCRIBERS TO UNSCRAMBLED BASIC CABLE TV SERVICE WITH SCRAMBLED PREMIUM CHANNELS

If you subscribe to a Cable TV service in which basic channels are unscrambled and premium channels require the use of a Converter/Descrambler box, you may wish to use a signal Splitter and an A/B Switch box (available from the Cable TV company or an electronics supply store). Follow the connections shown below. With the switch in the "B" position, you can directly tune any nonscrambled channels on your unit. With the switch in the "A" position, tune your unit to the output of the Converter/Descrambler box (usually channel 3 or 4) and use the Converter/Descrambler box to tune scrambled channels.

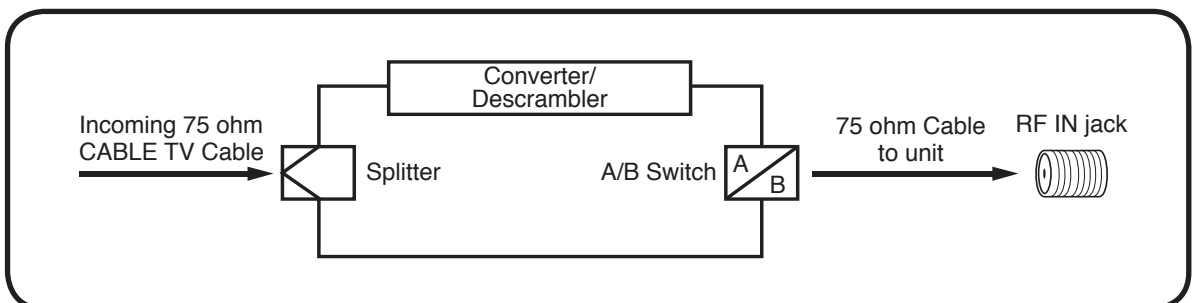

Connections to other equipment

The exact arrangement you use to interconnect various video and audio components to the TV is dependent on the model and features of each component. Check the Owner's Manual provided with each component for the location of video and audio inputs and outputs.

The connection diagrams below are offered as suggestions. You may need to modify them to accommodate your particular assortment of components. The diagrams are intended to show component video and audio interconnections only.

To connect the TV to a VCR

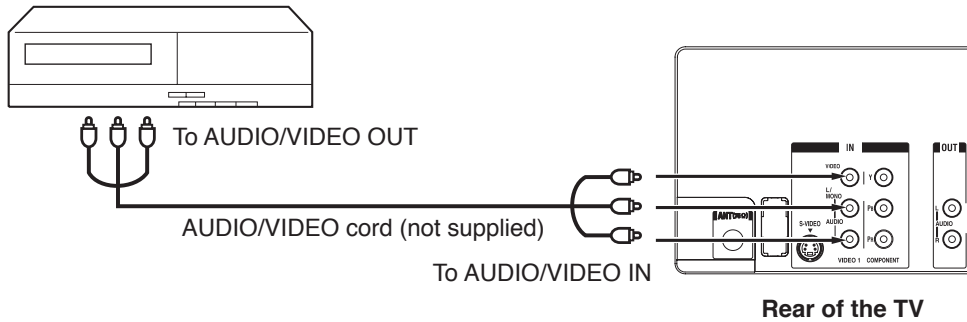

To connect the TV to a VCR with an S-Video cord

If you connect a VCR with a S-VIDEO cord to the S-VIDEO IN jack on the rear of the TV, you must also connect the audio cords to the AUDIO IN jacks on the rear of the TV. The S-VIDEO cord only carries the video signal. The audio signal is separate.

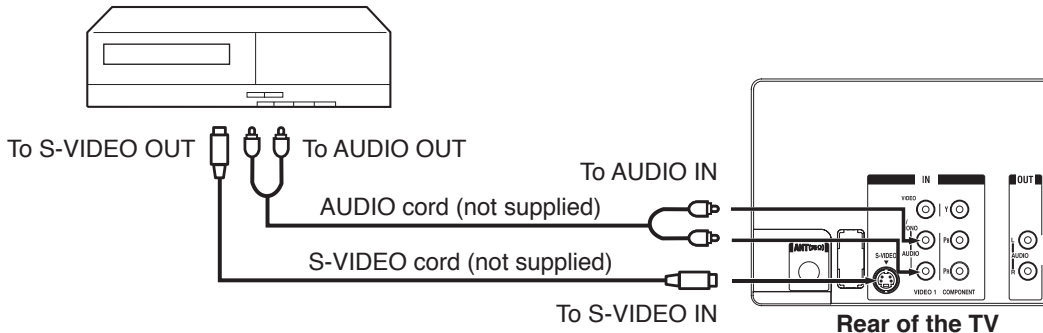

NOTE:

When the S-video cord and the video cord are connected to each jack at the same time, the S-video cord takes precedence over the video cord.

To connect the TV to a DVD player/Satellite receiver

If your DVD player or Satellite receiver has a S-Video out jack, connect cords as shown.

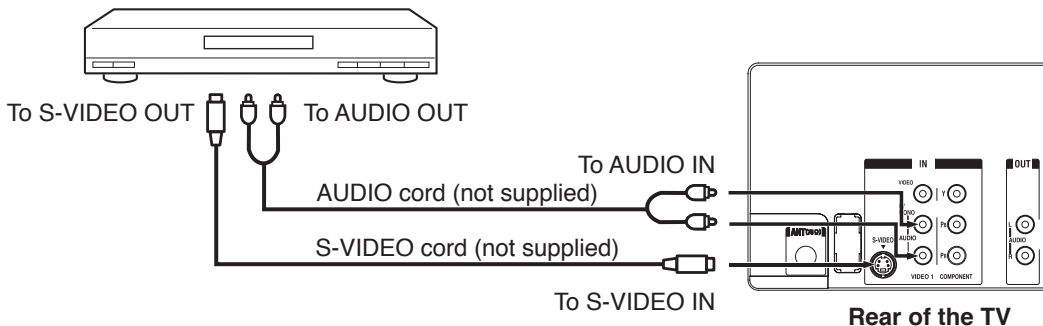

To connect the TV to a DVD player with component video

If your DVD player has component video out jacks, connect your TV to a DVD player using a component video cord. It can greatly enhance picture quality and performance.

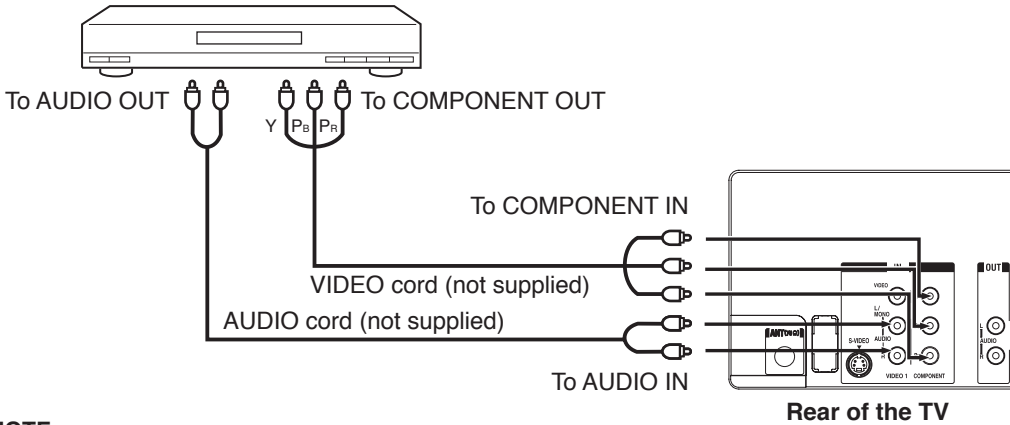

NOTE:

This unit is only capable of displaying 480i interlaced signal when connected to a digital device with component video outputs. If you input a 480p, 720p or 1080i signal to the component video inputs, "COMPONENT" and "NO SIGNAL OR NOT SUPPORTED VIDEO RESOLUTION" will be displayed on a black screen. If this screen appears, set the digital device's component output to 480i.

To connect the TV to a set-top box

If you connect a set-top box, connect your TV to it by using a component video cord.

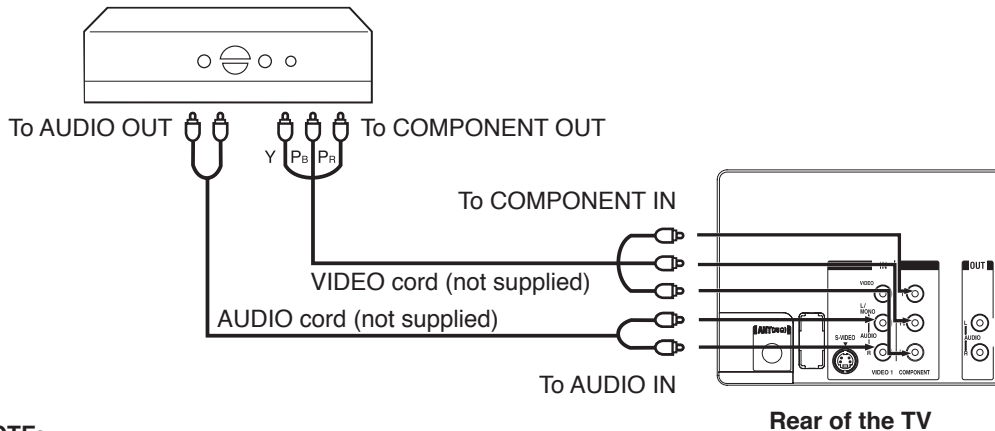

NOTE:

This unit is only capable of displaying 480i interlaced signal when connected to a digital device with component video outputs. If you input a 480p, 720p or 1080i signal to the component video inputs, "COMPONENT" and "NO SIGNAL OR NOT SUPPORTED VIDEO RESOLUTION" will be displayed on a black screen. If this screen appears, set the digital device's component output to 480i.

To connect an audio system

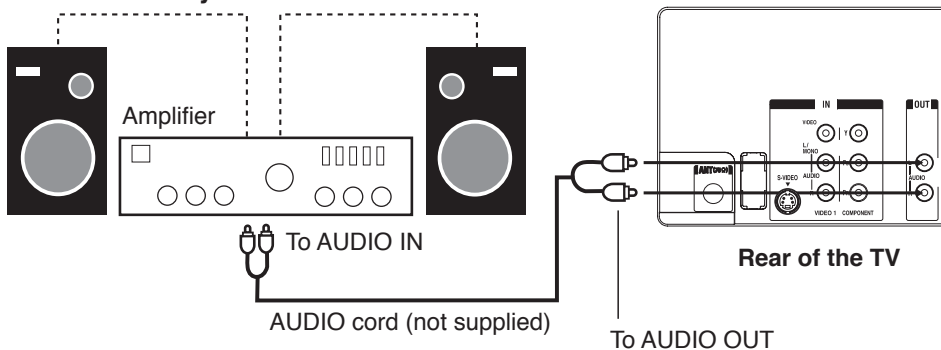

To connect the TV to a camcorder

To playback from a camcorder, connect the camcorder to the TV as shown.

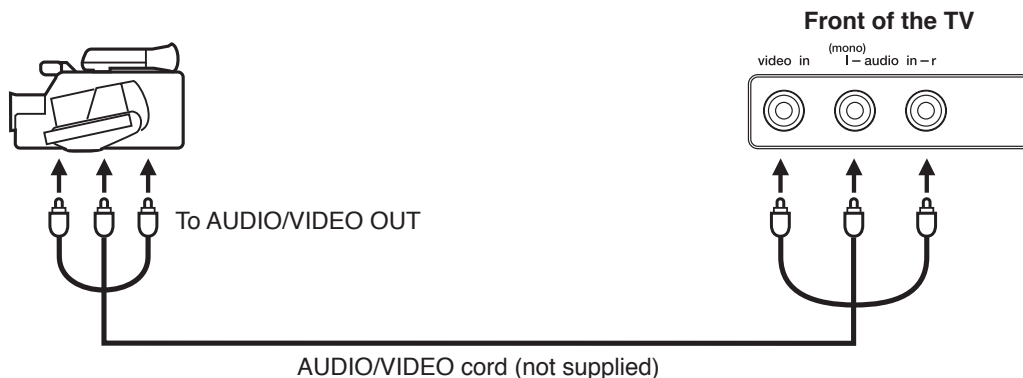

To connect the TV to a Game

The TV can also be used as a display device for many video games. However, due to the wide variety of signals generated by these devices and subsequent hook-up variations required, they have not all been included in the suggested connection diagrams. You'll need to consult each component's Owner's Manual for additional information.

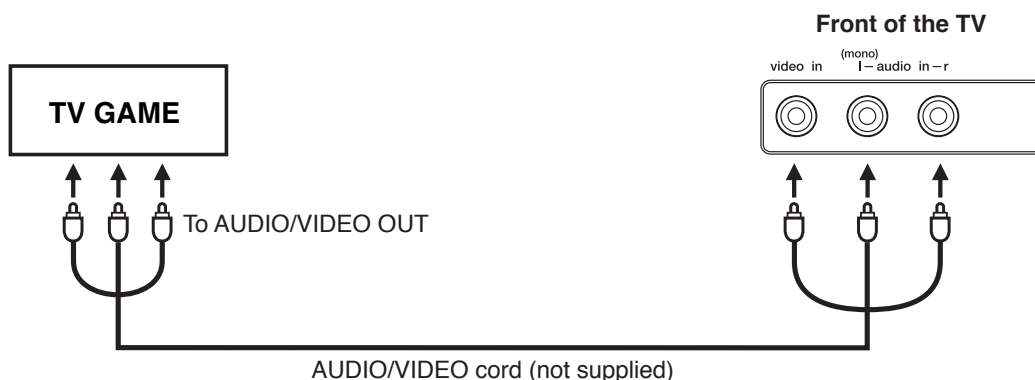

Selecting the VIDEO input source

Press **TV/AV** to view a signal from another device connected to your TV, such as a VCR or DVD player. You can select "ANALOG", "DIGITAL", "VIDEO1", "VIDEO2" (on the front panel), or "COMPONENT" depending on which input jacks you used to connect your devices.

Pressing **TV/AV** on the remote control displays the current signal source.

Press **▲ / ▼** or the **number buttons (0-4)** to select desired mode.

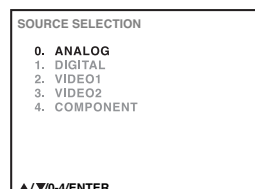

Setting the language

You can choose from three different languages (English, Spanish and French) for the on-screen displays. On-screen language selection (step 4) will automatically appear on the screen when you press MENU/ENTER initially. Select the language you prefer first, then proceed with the other menu options.

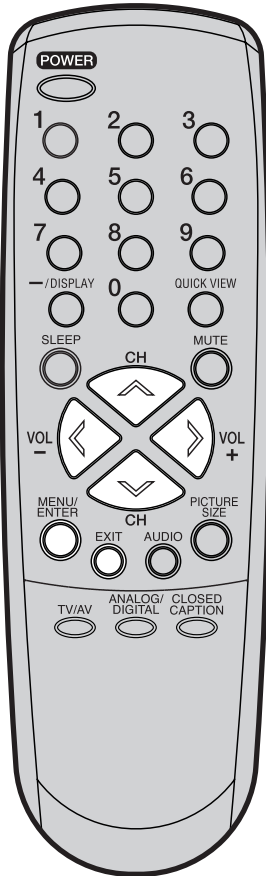

NOTE:

If no buttons are pressed for more than 60 seconds, the MENU screen will return to normal TV-operation automatically.

1 Press **MENU/ENTER**. The menu screen will appear.

2 Press **<** or **>** to select  (SETUP) menu.

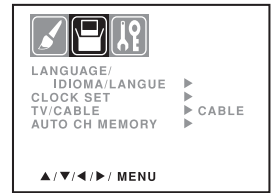

3 Press **^** or **v** to select "LANGUAGE/IDIOMA/LANGUE". Then press **>** to display the LANGUAGE/IDIOMA/LANGUE menu.

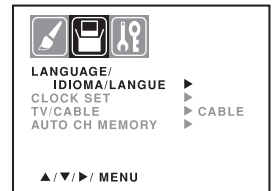

4 Press **^** or **v** to select the desired language: English (ENGLISH), Spanish (ESPAÑOL) or French (FRANÇAIS).



5 Press **MENU/ENTER** repeatedly until the menu screen is cleared. Otherwise, press **EXIT** to return to the normal screen immediately.

Memorizing channels

This TV is equipped with a channel memory feature which allows channels to skip up or down to the next channel set into memory, skipping over unwanted channels. Before selecting channels, they must be programmed into the TV's memory. To use this TV with an antenna, set the TV/CABLE menu option to the TV mode. When shipped from the factory, this menu option is in the CABLE mode.

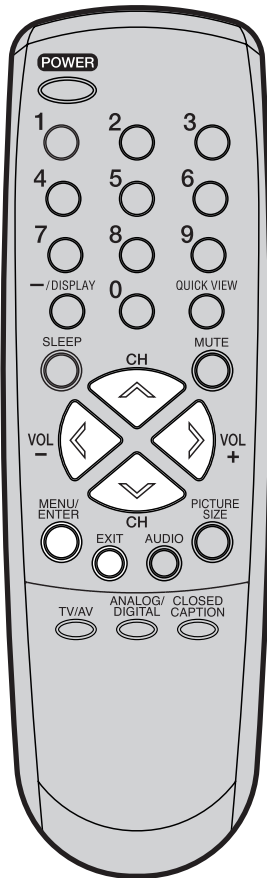

NOTE:

It may take a few seconds for a digital channel picture to appear on screen after being selected.

TV/CABLE selection

1 Press **MENU/ENTER**. The menu screen will appear.

2 Press **<** or **>** to select  (SETUP) menu.

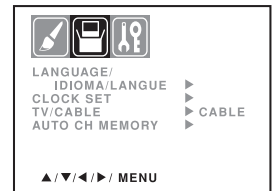

3 Press **^** or **v** to select "TV/CABLE".

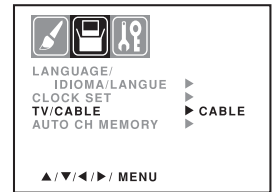

4 Press **<** or **>** to select "TV" or "CABLE".

TV - VHF/UHF channels
CABLE - CABLE TV channels

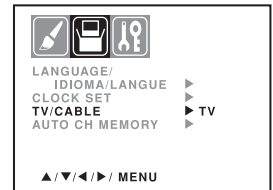

5 Press **MENU/ENTER** repeatedly until the menu screen is cleared. Otherwise, press **EXIT** to return to the normal screen immediately.

CABLE CHART

The chart below is typical of many cable system channel allocations.

Number on this TV													14	15	16	17	18	19	20	21	22	
Corresponding CABLE channel													A	B	C	D	E	F	G	H	I	
23	24	25	26	27	28	29	30	31	32	33	34	35	36	37	38	39	40					
J	K	L	M	N	O	P	Q	R	S	T	U	V	W	AA	BB	CC	DD					
41	42	43	44	45	46	47	48	49	50	51	52	53	54	55	56	57	58					
EE	FF	GG	HH	II	JJ	KK	LL	MM	NN	OO	PP	QQ	RR	SS	TT	UU	VV					
59	60	61	62	63	64	65	66	67	68	69	70	71	72	73	74	75	76					
WW	AAA	BBB	CCC	DDD	EEE	FFF	GGG	HHH	III	JJJ	KKK	LLL	MMM	NNN	OOO	PPP	QQQ					
77	78	79	80	81	82	83	84	85	86	87	88	89	90	91	92	93	94					
RRR	SSS	TTT	UUU	VVV	WWW	XXX	YYY	ZZZ	86	87	88	89	90	91	92	93	94					
95	96	97	98	99	100	101	102	103	104	105	106	107	108	109	110	111	112					
A-5	A-4	A-3	A-2	A-1	100	101	102	103	104	105	106	107	108	109	110	111	112					
113	114	115	116	117	118	119	120	121	122	123	124	125	01									
113	114	115	116	117	118	119	120	121	122	123	124	125	5A									

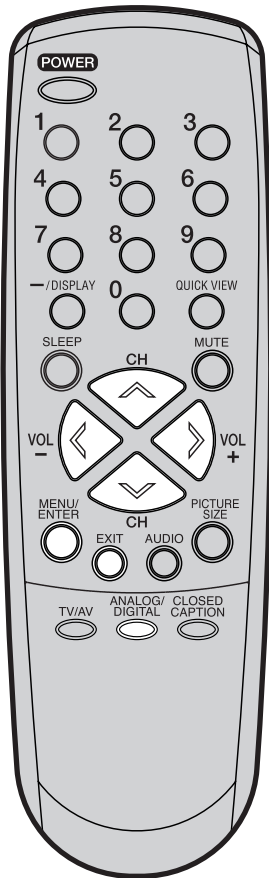

Automatic memory tuning

1 Press **MENU/ENTER**. The menu screen will appear.

2 Press **<** or **>** to select  (SETUP) menu, then press **^** or **v** to select "AUTO CH MEMORY".

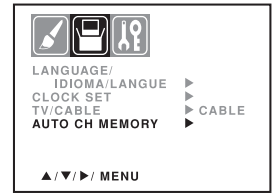

3 Press **>**. The TV will begin memorizing all the channels available in your area. After finishing Analog Tuning, Digital Tuning starts automatically.



- It may take from 15 minutes to 30 minutes to complete memorizing digital cable channels. Depending on the reception condition, a BAR display may not advance for several minutes.

To add or delete channels (ANALOG MODE)

1 Press **ANALOG/DIGITAL** to select the analog mode.

2 Press **MENU/ENTER**. The menu screen appears.

3 Press **<** or **>** to select  (OPTION) menu, then press **^** or **v** to select "ADD/DELETE".

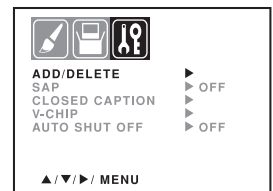

4 Press **>**. The ADD/DELETE menu appears.

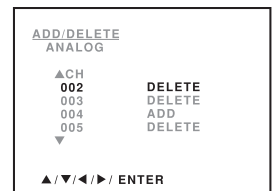

5 Select the desired channel to be memorized or deleted using **^** or **v**.

6 Press **<** or **>** to select "ADD" or "DELETE".

7 Repeat steps 5-6 for other channels you want to add or delete.

8 Press **MENU/ENTER** repeatedly until the menu screen is cleared. Otherwise, press **EXIT** to return to the normal screen immediately.

NOTES:

- Memorizing channels is best accomplished during evening "PRIMETIME" hours, as more stations are broadcasting digital signals. Memorizing channels can only be accomplished while a station is broadcasting a digital signal to set that channel into memory.
- If you are unsure of the digital channels available in your area you may visit www.antennaweb.org to receive a list based on your address or zip code. Should you require further assistance you may call our toll-free customer service line at 1-888-865-3026.
- New digital channels may be added to your area periodically, it is recommended that you perform the "AUTO CH MEMORY" procedure regularly.

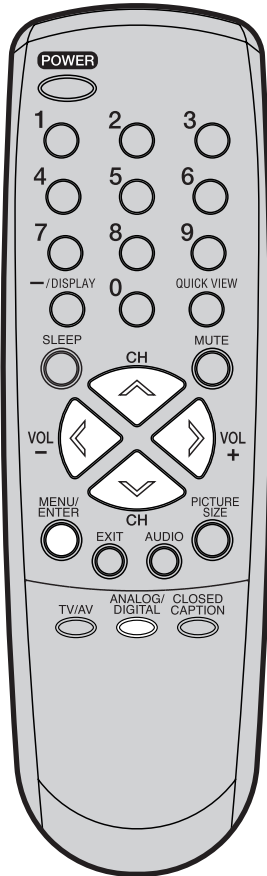

To add or delete channels (DIGITAL MODE)

1 Press **ANALOG/DIGITAL** to select the digital mode.

2 Press **MENU/ENTER**. The menu screen appears.

3 Press **<** or **>** to select  (OPTION) menu, then press **^** or **v** to select "DIGITAL SETUP".

4 Press **>**. The DIGITAL SETUP menu appears.

5 Press **^** or **v** to select "ADD/DELETE", then press **>**. The ADD/DELETE menu appears.

6 Press **^** or **v** to select "ADD/DELETE", then press **>**.

7 Select the desired channel to be memorized or deleted using **^** or **v**.

8 Press **<** or **>** to select "ADD" or "DELETE".

9 Repeat steps 7-8 for other channels you want to add or delete.

10 Press **MENU/ENTER** repeatedly until the menu screen is cleared.

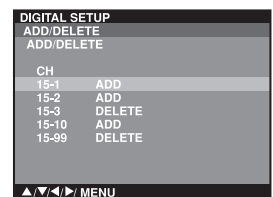
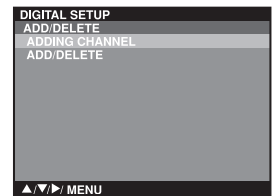
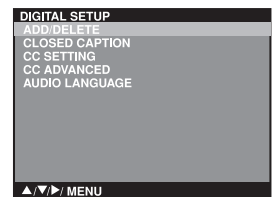

To add a digital channel you are watching

Select the digital channel you want to add. Press **^** or **v** to select "ADDING CHANNEL" as in step 6 above, then press **>**.

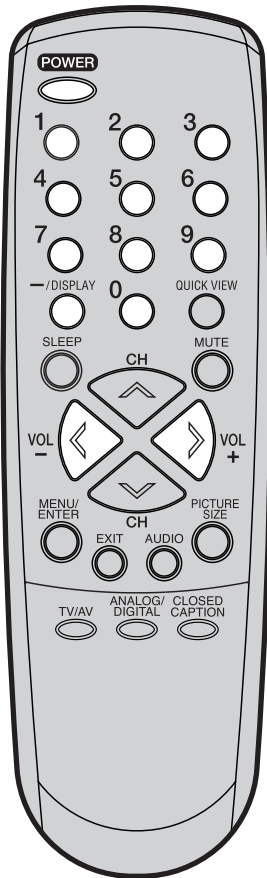

1 To turn on the TV, press **POWER**.

2 Adjust the volume level by pressing **VOL +** or **-**. The volume level will be indicated on the screen by green bars. As the volume level increases, so do the number of bars. If the volume decreases, the number of green bars also decreases.

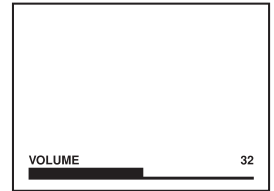

3 Set the **TV/CABLE** menu option to the appropriate position (see page 14).

TV - VHF/UHF channels
CABLE - CABLE TV channels

4 Press the Direct Channel Selection buttons to select the channel.

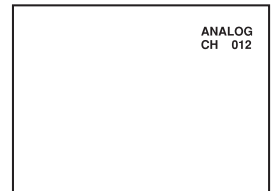

To select analog channels

When the **TV/CABLE** menu option is in the TV position, all channels can be instantly selected by using two buttons. (For example, to select channel 2, press "0", then "2". If you press only "2", channel selection will be delayed for a few seconds.)

For channels 10 and above, press the 2 digits in order.

When the **TV/CABLE** menu option is in the CABLE position, channels can be selected as follows:

- 1-9: Press **0** twice, then 1-9 as needed.
Example, to select channel 2, press **002**.
- 10-12: Press **0**, then remaining 2 digits.
Example, to select channel 12, press **012**.
- 13-99: Press the 2 digits in order.
Example, to select channel 36, press **36**.
- 100-125: Press the 3 digits in order.
Example, to select channel 120, press **120**.

To select digital channels

Press the channel number in order.

When "-" is contained in the channel number, press the first 3 digits, then press **-/DISPLAY**, followed by the remaining 3 digits. (Example, to select channel 015-001, press **015 - 001**.)

- If a channel is selected with only audio content, "AUDIO ONLY" will be displayed on the screen.
- If a channel is selected with a weak digital signal, "DIGITAL CHANNEL SIGNAL STRENGTH IS LOW" will be displayed on the screen. If the digital channel has the same analog channel, you may be able to watch the same channel with analog.
- If a channel is selected to which you have not subscribed, "DIGITAL CHANNEL IS ENCRYPTED" will be displayed on the screen.

NOTES:

- If a channel is selected that is not broadcasting, the sound will automatically be muted.
- If a station being viewed stops broadcasting, the TV will automatically shut itself off after 15 minutes.
- It may take a few seconds for a digital channel picture to appear on screen after being selected.

VHF/UHF/CABLE CHANNELS

TV	CABLE
VHF 2-13	VHF 2-13
UHF 14-69	STD/HRC/IRC 14-36 (A) (W) 37-59 (AA) (WW) 60-85 (AAA) (ZZZ) 86-94 (86) (94) 95-99 (A-5) (A-1) 100-125 (100) (125) 01 (5A)

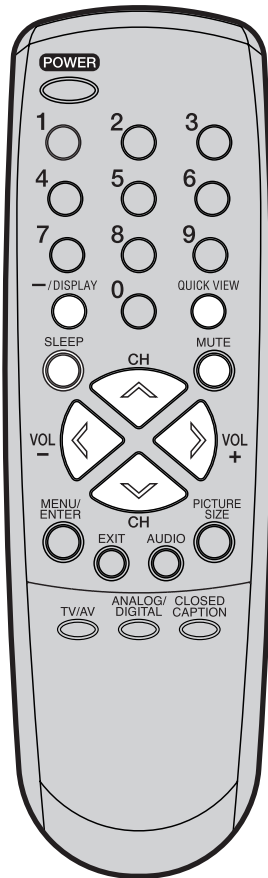

NOTE:

After 10 seconds, DISPLAY screen will return to normal TV-operation automatically, when a Digital signal is received.

After 4 seconds, DISPLAY screen will return to normal TV-operation automatically, when an Analog signal is received.

CH ^ / v

Press and release **CH ^** or **v**. The channel automatically stops at the next channel set into memory. For proper operation, before selecting channels, they should be set into the memory. See pages 14 - 16 "Memorizing channels".

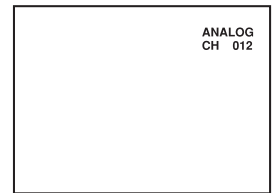

DISPLAY

Press **-/DISPLAY** to display the current information on the screen. When the TV receives a digital signal, the digital information will appear.

- Broadcast program name
- Station name
- Audio language
- Program name
- V-CHIP RATING

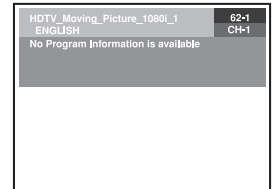

When the TV receives an Analog signal, press **-/DISPLAY** again, the analog information will appear.

- Clock
- Channel number or VIDEO mode selected
- Stereo or SAP (second audio program) audio status
- Picture size

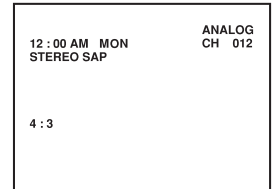

Press **-/DISPLAY** again to clear the call display.

QUICK VIEW

This button allows you to go back to the last channel selected by pressing **QUICK VIEW**. Press **QUICK VIEW** again to return to the last channel you were watching.

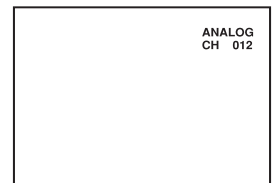

MUTE

Press **MUTE** to switch off the sound. The unit's sound will be silenced and "MUTE" will appear on the screen. The sound can be switched back on by pressing this button again or one of the **VOL +** or **-** buttons.

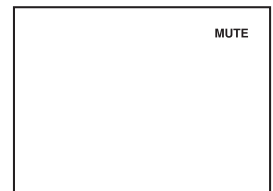

SLEEP

To set the unit to turn off after a preset amount of time, press **SLEEP** on the remote control. The clock will count up 10 minutes for each press of the **SLEEP** button (0, 10, 20, ...100, 110, 120).

After the sleep time is programmed, the display will appear briefly every ten minutes to remind you that the sleep timer is operating.

To confirm the sleep timer setting, press **SLEEP** and the remaining time will be displayed for a few seconds. To cancel the sleep timer, press **SLEEP** repeatedly until the display turns to 0.

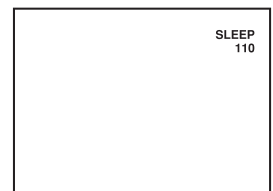

Setting the V-Chip

An age limitation can be set to restrict children from viewing or hearing violent scenes or pictures that you may choose to exclude. The restriction applies to "TV RATING" and "MOVIE RATING" if this data is transmitted. You may set this restriction separately. To use the V-Chip function, you must register a password.

To set a password

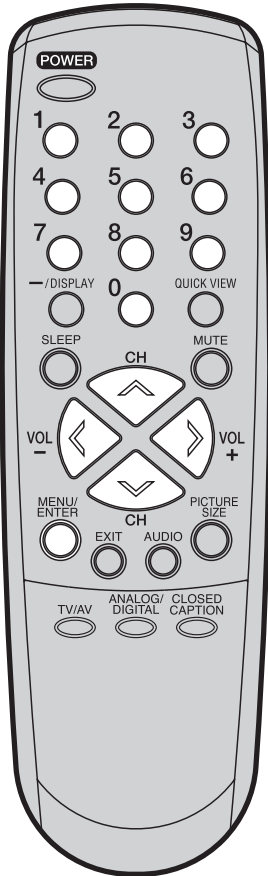

1 Press **MENU/ENTER**. The menu screen appears.

2 Press **<** or **>** to select  (OPTION) menu, then press **^** or **v** to select "V-CHIP".



3 Press **>**. The password entering screen appears.

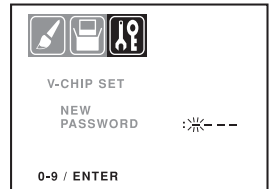

4 Select and enter a password (4 digits) using the **number buttons (0-9)**, then press **MENU/ENTER**.



"*" appears instead of the number.

5 Enter the same password again to confirm, then press **MENU/ENTER**. The password is now set and the V-CHIP menu appears on the screen.

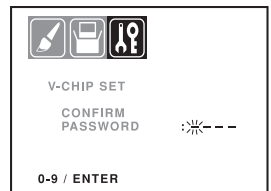

NOTES:

- If you forget the password, contact Customer Service at 1-888-865-3026 for assistance. Your original remote control will be required.
- To avoid forgetting the password, write it down and keep it in a safe place.

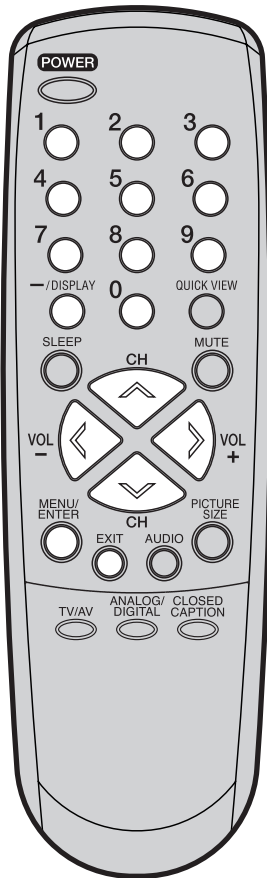

To use the TV after the TV is protected.

When a program is received that is blocked by the V-Chip, enter the password, then press **MENU/ENTER**. When the password is entered correctly the protection will be temporarily overridden.

If the TV is turned off, or the channel is changed the V-Chip restriction will be reactivated.

NOTES:

- The V-Chip function is activated only on programs and input sources that include a rating signal.
- The V-CHIP SET (DTV) will only be selectable when the unit receives a digital broadcast using the new rating system. It may take several minutes for the initial V-Chip Set-up to complete. At this time some stations are still developing this signal, in those cases the V-CHIP SET (DTV) will not function.

To set the V-CHIP

- 1 Press **MENU/ENTER**. The menu screen appears.
- 2 Press **<** or **>** to select  (OPTION) menu.
- 3 Press **^** or **v** to select "V-CHIP".
- 4 Press **>** to display the password entering mode. Use **number buttons (0-9)** to enter your password, then press **MENU/ENTER**. The V-CHIP menu appears.
- 5 Press **^** or **v** to select "V-CHIP SET", then press **>**. The V-CHIP SET menu appears.
- 6 Press **^** or **v** to select "TV RATING", then press **<** or **>** to display the desired rating.
 - OFF** : TV RATING is not set
 - TV-Y** : All children
 - TV-Y7** : 7 years old and above
 - TV-G** : General audience
 - TV-PG** : Parental guidance
 - TV-14** : 14 years old and above
 - TV-MA** : 17 years old and above

• When you select TV-Y7, TV-PG, TV-14, or TV-MA, press **-/DISPLAY** to further define the rating.
Press **^** or **v** to select the desired rating you want.
Press **<** or **>** to select the setting "ON" or "OFF".
- 7 Press **^** or **v** to select "MOVIE RATING", then press **>**. The RATING SET menu appears.
- 8 Press **^** or **v** to select the rating, then press **<** or **>** to select "ON" or "OFF" for each rating.
 - G** : All ages
 - PG** : Parental guidance
 - PG-13** : Parental guidance less than 13 years old
 - R** : Under 17 years old parental guidance suggested
 - NC-17** : 17 years old and above
 - X** : Adult only
- 9 Press **MENU/ENTER** twice to return to the V-CHIP menu, then press **^** or **v** to select "V-CHIP".
- 10 Press **<** or **>** to select "ON". Your settings are now set into memory.
- 11 Press **MENU/ENTER** repeatedly until the menu screen is cleared. Otherwise, press **EXIT** to return to the normal screen immediately.

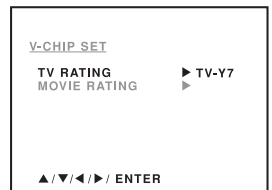
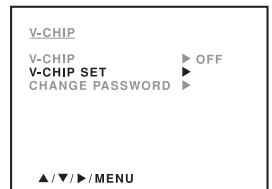
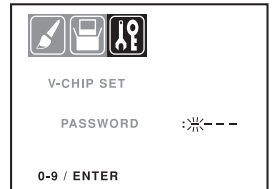
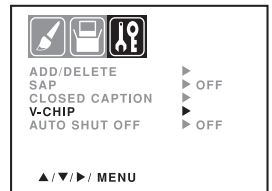

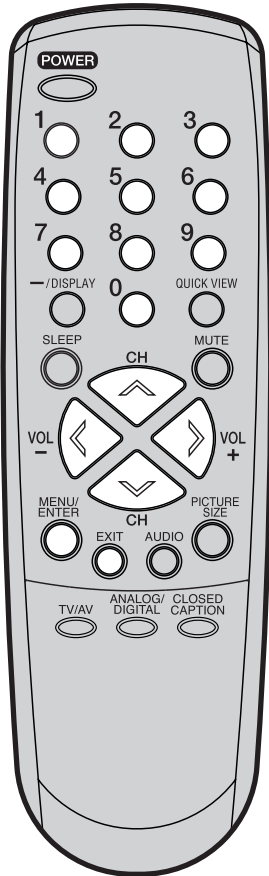

To change the password

1 Press **MENU/ENTER**. The menu screen appears.

2 Press **<** or **>** to select  (OPTION) menu, then press **^** or **v** to select "V-CHIP".

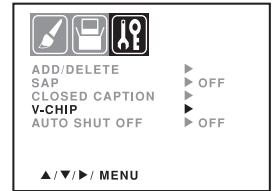

3 Press **>** to display the password entering mode. Use the **number buttons (0-9)** to enter your password, then press **MENU/ENTER**. The V-CHIP menu appears.



4 Press **^** or **v** to select "CHANGE PASSWORD", then press **>**.



5 Enter a new password using the **number buttons (0-9)**, then press **MENU/ENTER**.



6 Enter the same password again to confirm, then press **MENU/ENTER**.

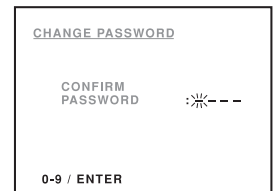

7 Press **MENU/ENTER** repeatedly until the menu screen is cleared. Otherwise, press **EXIT** to return to the normal screen immediately.

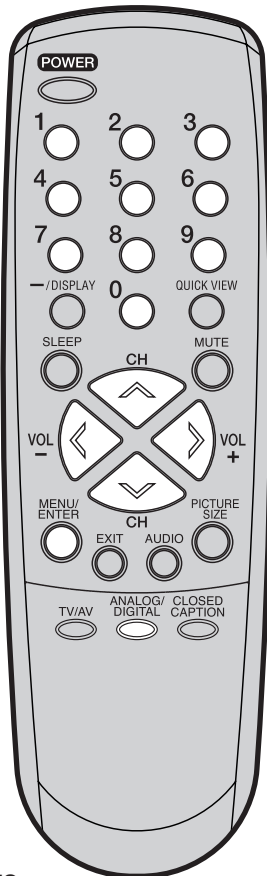

NOTES

- You can only download the additional V-Chip rating system when your TV is receiving a digital signal.
- When you download the additional rating system, it may take some time for the download to occur.
- The V-Chip rating information and system are not determined or controlled by the TV .
- The standard V-Chip rating system is available whether your TV is receiving a digital signal or not, and will block both analog and digital programs. To set the restriction level using the standard V-Chip rating system, select **V-CHIP SET** in step 5.
- The downloadable V-Chip rating system is an evolving technology, and availability, content, and format may vary.
- You cannot select this feature if the TV is not receiving a digital signal for the current station.

Downloading the additional V-Chip rating system

As a supplement to the standard V-Chip rating system, your television will be able to download an additional rating system, if such a system becomes available in the future.

To download the additional V-Chip rating system (when available)

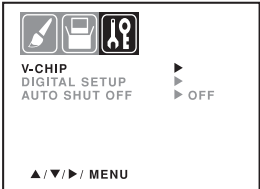
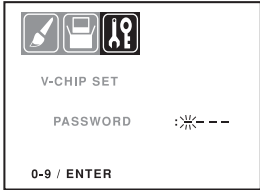
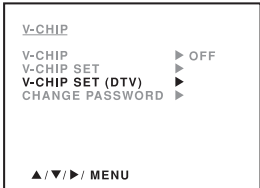
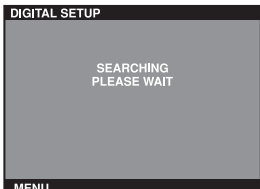
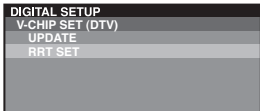
- 1 Press **ANALOG/DIGITAL** to select the digital mode.
- 2 Press **MENU/ENTER**, then press **<** or **>** to display  (OPTION) menu.
- 3 Press **^** or **v** to select "V-CHIP", then press **>**.
 
- 4 Use the Channel **Number** buttons (**0-9**) to enter your password. Press **MENU/ENTER**. The V-CHIP menu appears.
 
- 5 Press **^** or **v** to select "V-CHIP SET (DTV)", then press **>**.
 
- 6 If the TV is not storing the additional rating system, the TV will begin downloading it, which may take some time to be completed.
 
- 7 Press **^** or **v** to select "RRT SET", then press **>**, and set your preferred content rating limits for the additional rating system.
 

Setting the clock

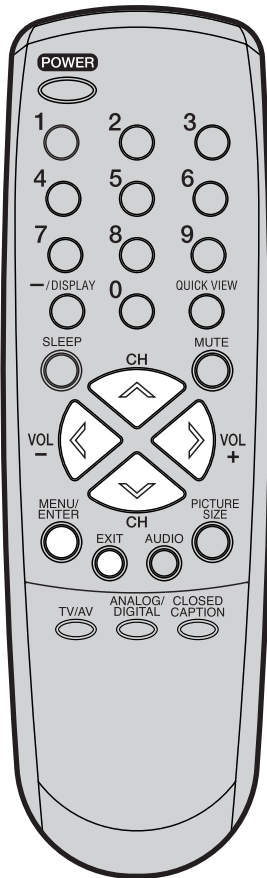

EXAMPLE: Setting the clock to "8:30 AM", 28 th (TUE) October, 2008.

1 Press **MENU/ENTER**, then press < or > to select  (SETUP) menu.

2 Press ^ or v to select "CLOCK SET". Then press > . The CLOCK SET menu will appear.

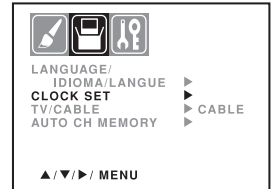

3 Press < or > to set the MONTH, then press v.

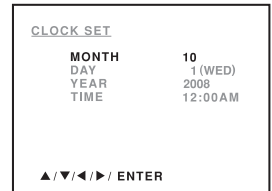

4 Set the DAY, YEAR and TIME as in step 3.

After setting the date and time, the clock will begin functioning automatically.

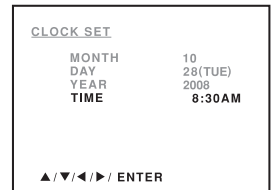

5 Press **MENU/ENTER** repeatedly until the menu screen is cleared. Otherwise, press **EXIT** to return to the normal screen immediately.

NOTE:

After a power failure or disconnection of the power, the clock settings will be lost. In this case, reset the present time.

Setting the picture size

You can view 480i format programs in three picture sizes—4:3, 16:9 and ZOOM.

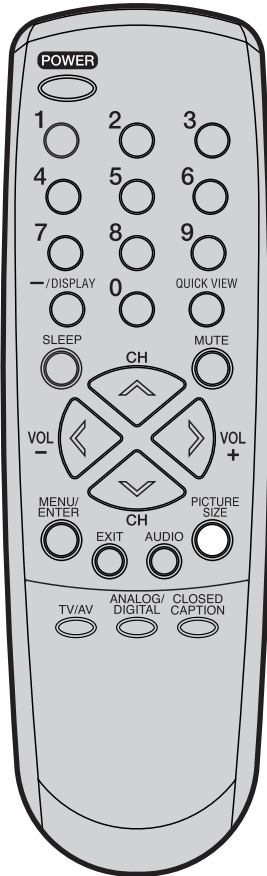

Selecting the picture size

You can change the picture size by pressing the **PICTURE SIZE** button on the remote control.

- If receiving an Analog signal, you can choose 4:3 or 16:9 picture size.
- If you are receiving a Digital signal in the 4:3 format, you are restricted to the 4:3 picture size.
- If receiving a Digital signal of 16:9, you can choose 16:9 or ZOOM.

4:3 picture size

To fill the screen, the top and bottom edges are extended more widely though the center of the picture remains near former ratio.

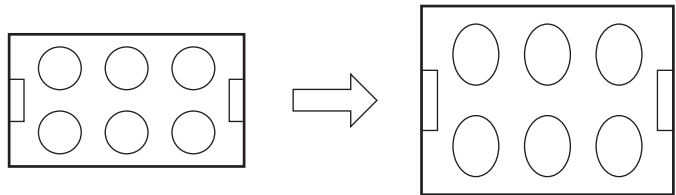

- If receiving a 4:3 format program, the image is displayed its originally formatted proportion.

16:9 picture size

This image will display the size of standard 16:9 with black bars at the top and bottom.

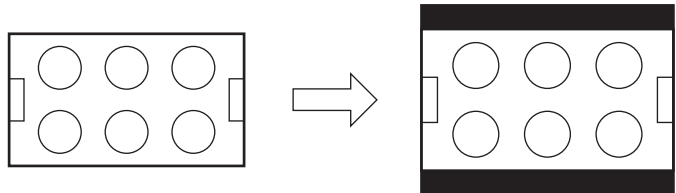

- If receiving a 4:3 format program, the image is displayed with black bars at the top and bottom and stretched wider.

NOTE:

If a fixed black bar remains on the screen for long periods of time, the image can become permanently engrained in the screen and cause subtle but permanent ghost images. Never leave your TV on for an extended period of time while displaying a stationary image(s).

ZOOM picture size (for 16:9 format programs)

The entire picture is uniformly enlarged—it is stretched the same amount both wider and taller (retains its original proportion). The right and left edges of the picture may be hidden.

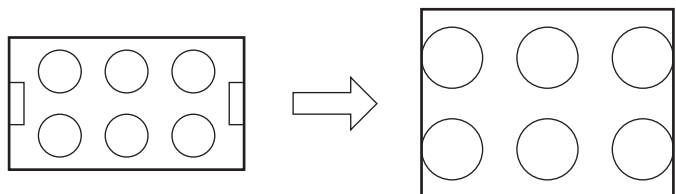

Picture control adjustment/Resetting your picture adjustment

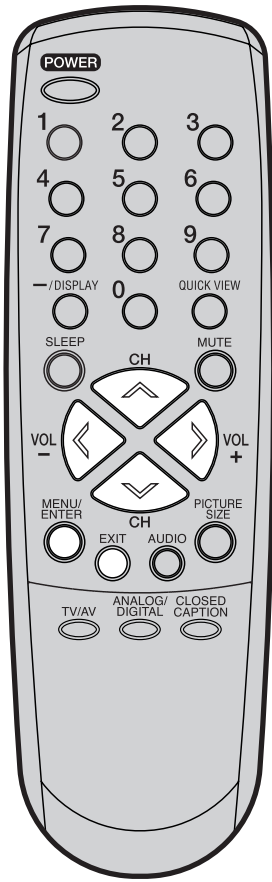

Picture control adjustment

1 Press **MENU/ENTER**, then press **<** or **>** to select  (PICTURE) menu.



2 Press **^** or **v** to select the item you want to adjust. Press **<** or **>** to adjust the setting.



	<	>
BRIGHTNESS	decrease brightness	increase brightness
CONTRAST	decrease contrast	increase contrast
COLOR	paler color	brilliant color
TINT	reddish color tint	greenish color tint
SHARPNESS	makes picture softer	makes picture clearer

3 After you have made your selection, press **EXIT** to return to the normal screen.

NOTE:

The CONTRAST default setting is set to maximum at the factory.

Resetting your picture adjustment

The RESET function returns your picture quality adjustments to the following factory settings:

BRIGHTNESS CENTER (0) TINT CENTER (0)
 CONTRAST MAX (32) SHARPNESS CENTER (0)
 COLOR CENTER (0)

1 Press **MENU/ENTER**, then press **<** or **>** to select  (PICTURE) menu.



2 Press **^** or **v** to select "RESET", then press **>**.

Closed Caption

WHAT IS CLOSED CAPTIONING?

This television has the capability to decode and display Closed Captioned television programs. Closed Captioning will display text on the screen for hearing impaired viewers or it will translate and display text in another language.

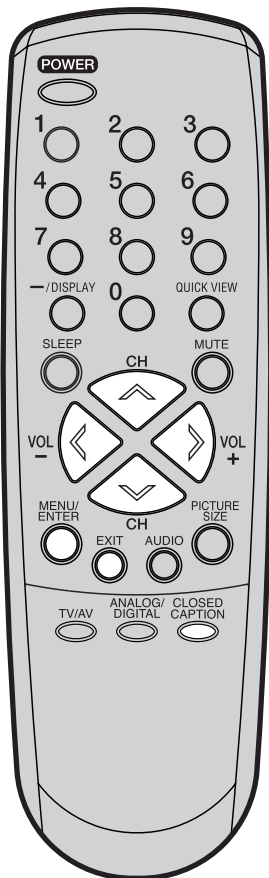

Captions: This Closed Caption Mode will display text on the screen in English or another language. Generally, Closed Captions in English are transmitted on C1 and Closed Captions in other languages are transmitted on C2.

Text: The Text Closed Caption Mode will usually fill 1/2 of the screen with a programming schedule or other information.

To turn on closed captions (ANALOG MODE)

- 1 Tune the television to the desired program in the analog mode.
- 2 Press **MENU/ENTER**, then press < or > to display  (OPTION) menu.
- 3 Press ^ or v to select "CLOSED CAPTION".
- 4 Press >. The CLOSED CAPTION menu appears.

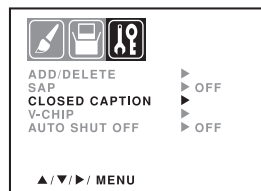

NOTES:

- Depending on the broadcast signal, some analog captions function with a digital broadcast signal.
- This screen can be displayed by pressing **CLOSED CAPTION**.

- 5 Press ^ or v to select the desired closed caption mode, then press **MENU/ENTER**.

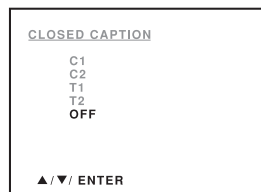

NOTES:

- To view captions, select C1 or C2 (C1 displays translation of the primary language in your area). If the program or video you selected is not closed captioned, no captions will display on-screen.
- To view text, select T1 or T2. If text is not available in your viewing area, a black rectangle may appear on-screen. If this happens, set the Closed Caption feature to **OFF**.

- 6 Press **MENU/ENTER** repeatedly until the menu screen is cleared. Otherwise, press **EXIT** to return to the normal screen immediately.

NOTES:

- If the program or video you selected is not closed-captioned, no captions will display on-screen.
- If text is not available in your viewing area, a black rectangle may appear on-screen. If this happens, set the Closed Caption feature to "OFF".
- When selecting Closed Captions, the captioning will be delayed approx. 10 seconds.
- If no caption signal is received, no captions will appear, but the television will remain in the Caption Mode.
- Misspellings or unusual characters may occasionally appear during Closed Captioning. This is normal with Closed Captioning, especially with live programs. This is because during live programs, captions are also entered live. These transmissions do not allow time for editing.
- When Captions are being displayed, on-screen displays, such as volume and mute may be seen but may interfere with Closed Captions.
- Some Cable TV systems and copy protection systems may interfere with the Closed Captioned signal.
- If using an indoor antenna or if TV reception is very poor, the Closed Caption Decoder may not appear or may appear with strange characters or misspelled words. In this case, adjust the antenna for better reception or use an outdoor antenna.

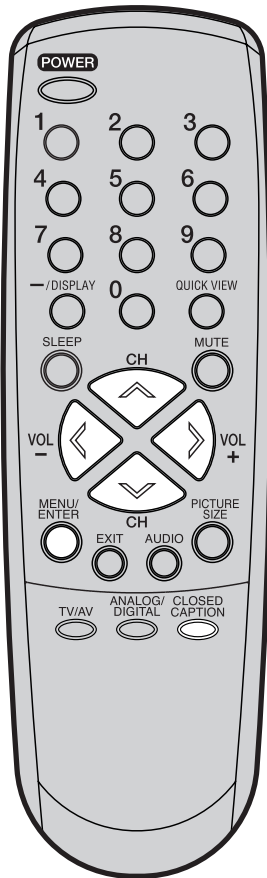

NOTE:
To turn the closed caption feature off, select **OFF** in step 7, above.

To turn on closed captions (DIGITAL MODE)

- 1 Tune the television to the desired program in the digital mode.
- 2 Press **MENU/ENTER**. The menu screen appears.
- 3 Press **<** or **>** to select  (OPTION) menu, then press **^** or **v** to select "DIGITAL SETUP".



- 4 Press **>**. The DIGITAL SETUP menu appears.

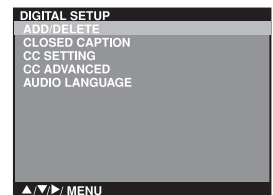

- 5 Press **^** or **v** to select "CLOSED CAPTION", then press **>**. The CLOSED CAPTION menu appears.

- This screen can be displayed by pressing **CLOSED CAPTION**.

- 6 Press **^** or **v** to select "ANALOG CAPTION" or "DIGITAL CAPTION", then press **>**.

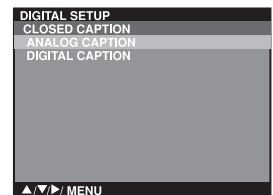

- 7 Press **^** or **v** to select the desired closed caption mode.

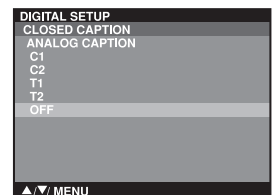

- 8 Press **MENU/ENTER** repeatedly until the menu screen is cleared.

Adjusting closed captioning

Closed captions are factory preset. However you can adjust them individually. This feature is designed to customize digital captions only.

CC Setting (DIGITAL MODE)

You can select the display method of Closed Caption with **AUTO** designated by broadcasting studios or **CUSTOM**.

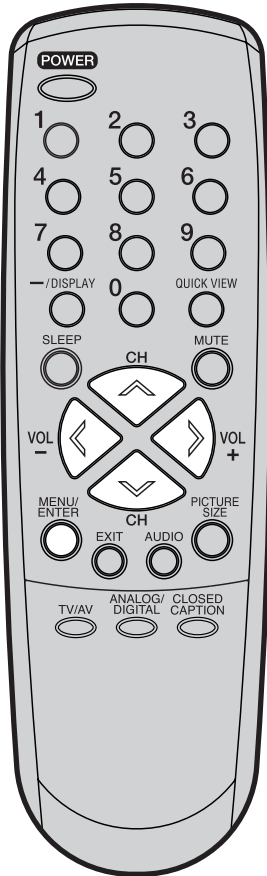

1 Tune the television to the desired program in the digital mode.

2 Press **MENU/ENTER**. The menu screen appears.

3 Press **<** or **>** to select  (OPTION) menu, then press **^** or **v** to select "DIGITAL SETUP".



4 Press **>**. The DIGITAL SETUP menu appears.

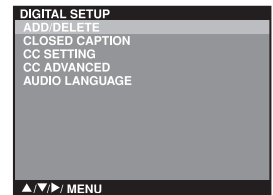

5 Press **^** or **v** to select **CC SETTING** and press **>**. The SETTING menu appears.

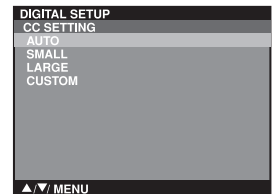

6 You can choose from **AUTO**, **SMALL**, **LARGE**, **CUSTOM**, and press **MENU/ENTER**.

7 Press **MENU/ENTER** repeatedly until the menu screen is cleared.

When you have selected **CUSTOM** as the display method, you can adjust the various setting listed below as follows:

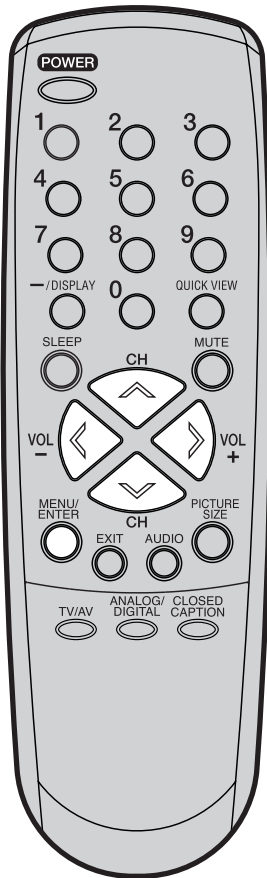

This feature is designed to customize Digital Captions only.

1 Tune the television to the desired program in the digital mode.

2 Press **MENU/ENTER**. The menu screen appears.

3 Press **<** or **>** to select  (OPTION) menu, then press **^** or **v** to select "DIGITAL SETUP".



4 Press **>**. The DIGITAL SETUP menu appears.

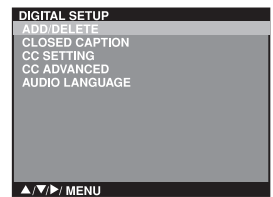

5 Press **^** or **v** to select "CC ADVANCED", then press **>**. The CC ADVANCED menu appears.

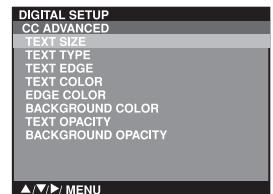

6 Press **^** or **v** to select the item you want to adjust, then press **>**.

7 Press **^** or **v** to select the setting, then press **MENU/ENTER**.

You can select from among the following items and parameters.

TEXT SIZE : SMALL, STANDARD, LARGE

TEXT TYPE : DEFAULT, STYLE 1, STYLE 2, STYLE 3, STYLE 4, STYLE 5, STYLE 6, STYLE 7

TEXT EDGE :NONE, RAISED, DEPRESSED, OUTLINE, LEFT SHADOW, RIGHT SHADOW

TEXT COLOR : BLACK, WHITE, GREEN, BLUE, CYAN, RED, MAGENTA, YELLOW

EDGE COLOR : BLACK, WHITE, GREEN, BLUE, CYAN, RED, MAGENTA, YELLOW

BACKGROUND COLOR : BLACK, WHITE, GREEN, BLUE, CYAN, RED, MAGENTA, YELLOW

TEXT OPACITY :AUTO, TRANSPARENT, TRANSLUCENT, SOLID, FLASHING

BACKGROUND OPACITY : AUTO, TRANSPARENT, TRANSLUCENT, SOLID, FLASHING

8 Press **MENU/ENTER** repeatedly until the menu screen is cleared.

NOTES:

- Do not set the Closed Caption "TEXT COLOR" and "BACKGROUND COLOR" as the same color or you will not be able to see the text.
- Do not set both the "TEXT OPACITY" and the "BACKGROUND OPACITY" to "TRANSPARENT" or you will not be able to see the text.

Selecting Stereo/Second Audio Program (SAP)

Selecting Stereo/Second Audio Program (SAP)

The multi-channel TV sound (MTS) feature provides high-fidelity stereo sound. MTS also can transmit a second audio program (SAP) containing a second language or other audio information. When the TV receives a stereo or SAP broadcast, the word "STEREO" or "SAP" displays on-screen every time you turn the TV on, change the channel, or press **-/DISPLAY**.

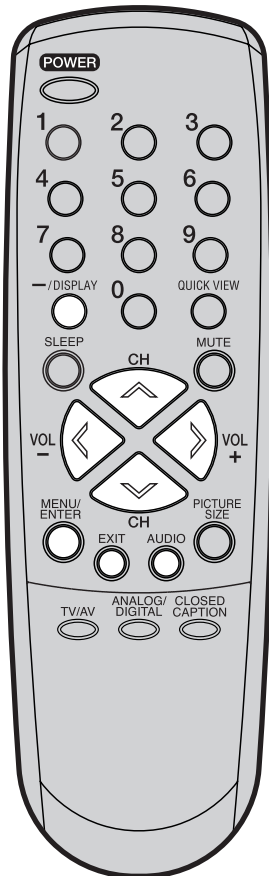

To set the SAP

- 1 Press **MENU/ENTER** in the analog mode, then press **<** or **>** to display  (OPTION) menu.
- 2 Press **^** or **v** to select "SAP", then press **<** or **>** to select "ON" or "OFF".
- 3 Press **MENU/ENTER** repeatedly until the menu screen is cleared. Otherwise, press **EXIT** to return to the normal screen immediately.

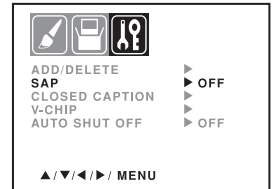

To listen to stereo sound

When the TV is turned on or a channel selection is made, the STEREO will appear on the screen. This means that Stereo broadcasting is available. You can enjoy stereo sound from the left and right speakers.

- When mono broadcasting is received, no indication is displayed.
- If the broadcasting signal is not strong enough or clear stereo sound is not available, press **AUDIO** to change to mono sound. The noise should be eliminated. Press it again to return to the stereo sound.

To listen to second audio program (SAP)

When the TV is turned on or a channel selection is made, SAP will appear on the screen. This means that the Second Audio Program broadcasting is available.

Selecting the audio language (DIGITAL MODE)

Selecting the audio language (DIGITAL MODE)

When two or more audio languages are included in a digital signal, you can select one of the audio language.

To select the audio language

1 Tune the television to the desired program in the digital mode.

2 Press **MENU/ENTER**. The menu screen appears.

3 Press **<** or **>** to select  (OPTION) menu, then press **^** or **v** to select "DIGITAL SETUP".



4 Press **>**. The DIGITAL SETUP menu appears.

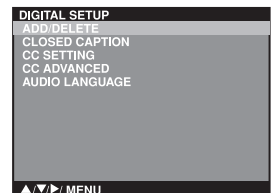

5 Press **^** or **v** to select "AUDIO LANGUAGE", then press **>** to display the AUDIO LANGUAGE menu.

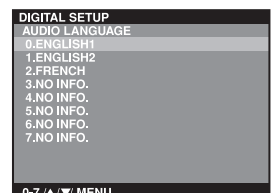

6 Press **^** / **v** or the **number buttons (0-7)** to select your desired language, then press **MENU/ENTER**.

7 Press **MENU/ENTER** repeatedly until the menu screen is cleared.

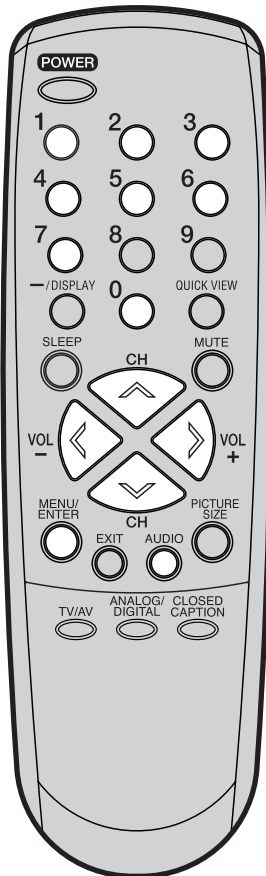

NOTE:

You can also display the AUDIO LANGUAGE menu by pressing "**AUDIO**" on the remote control.

Using the auto shut off feature

If the AUTO SHUT OFF feature is ON, and a station being viewed stops broadcasting, the TV will automatically shut itself off after 15 minutes.

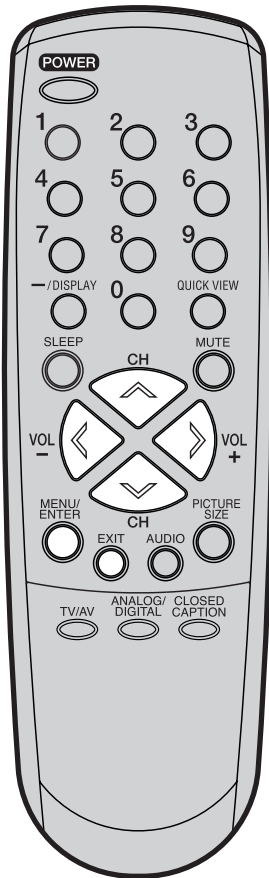

To use the auto shut off feature

1 Press **MENU/ENTER**. The Menu screen will appear.

2 Press **<** or **>** to display  (OPTION) menu.

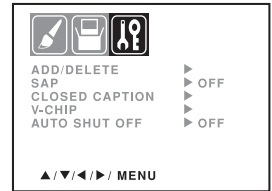

3 Press **^** or **v** to highlight "AUTO SHUT OFF", then press **<** or **>** to select "ON" or "OFF".

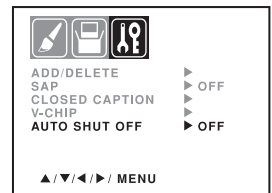

4 Press **MENU/ENTER** repeatedly until the menu screen is cleared. Otherwise, press **EXIT** to return to the normal screen immediately.

Troubleshooting

Use the following check list for troubleshooting when you have problems with your TV. Consult your local dealer or service outlet if problems persist. Be sure all connections are properly made when using with other units.

SYMPTOMS	POSSIBLE SOLUTIONS
TV does not operate.	<ul style="list-style-type: none"> • Make sure the power cord is plugged in. • Try another AC outlet. • Power is off, check fuse or circuit breaker. • Unplug unit for an hour, then plug it back in.
Poor sound or no sound.	<ul style="list-style-type: none"> • Station or CABLE experiencing problems, tune to another station. • Check sound adjustments (Volume and Mute). • Check for sources of possible interference.
Poor picture or no picture.	<ul style="list-style-type: none"> • Station or CABLE experiencing problems, tune to another station. • Make sure channels are set into memory. • Check antenna or CABLE connections, adjust antenna. • Check for sources of possible interference. • Check picture control adjustments.
Poor reception on some channels.	<ul style="list-style-type: none"> • Station or CABLE experiencing problems, tune to another station. • Make sure channels are set into memory. • Station is weak, adjust antenna to receive desired station. • Check for sources of possible interference.
Poor color or no color.	<ul style="list-style-type: none"> • Station or CABLE experiencing problems, tune to another station. • Make sure channels are set into memory. • Check picture control adjustments. • Check antenna or CABLE connections, adjust antenna. • Check for sources of possible interference.
Picture wobbles or drifts.	<ul style="list-style-type: none"> • Station or CABLE experiencing problems, tune to another station. • Make sure channels are set into memory. • CABLE company is scrambling signal. • Adjust antenna.
Digital broadcasting screen problem.	<ul style="list-style-type: none"> • Check digital signal strength.

SYMPTOMS	POSSIBLE SOLUTIONS
No CATV reception.	<ul style="list-style-type: none"> • Check all CABLE connections. • Set TV/CABLE menu option to the CABLE mode. • Station or CABLE system problems, try another station.
Horizontal or diagonal bars on screen.	<ul style="list-style-type: none"> • Check antenna connections, adjust or re-direct antenna. • Check for sources of possible interference.
No reception above channel 13.	<ul style="list-style-type: none"> • Make sure TV/CABLE menu option is in the appropriate mode. • If using antenna, check UHF antenna connections.
No Remote operation.	<ul style="list-style-type: none"> • Batteries are weak, dead or inserted incorrectly. • Remote is out of range, move closer to TV (within 15 feet). • Make sure Remote is aimed at sensor. • Confirm there are no obstructions between the Remote and the TV. • Make sure the power cord is plugged in.
TV shuts off.	<ul style="list-style-type: none"> • No broadcast on station tuned. • Sleep Timer is set. • Power interrupted.
Closed - Caption is not activated.	<ul style="list-style-type: none"> • TV station experiencing problems or program tuned is not closed captioned. Try another channel. • Check CABLE connection or VHF/UHF antenna, reposition or rotate antenna. • Set closed caption decoder in the menu.
Display is not shown in your language.	<ul style="list-style-type: none"> • Select proper language in the menu options.

Specifications

Power supply:	AC 120V, 60Hz
Power Consumption: Operation :	110 Watts
Stand by :	3 Watts
Weight:	71.9 lbs (32.6 kg)
Dimensions:	Width: 25-9/16 inches (650.0 mm)
	Height: 22-1/2 inches (571.5 mm)
	Depth: 19-11/16 inches (500.5 mm)
Inputs:	VIDEO: 1 V (p-p)/75 ohms
	AUDIO: -8 dBm/50k ohms
	S-VIDEO: Y: 1 V (p-p), 75 ohms
	C: 0.286 V (p-p), 75 ohms
	COMPONENT: Y: 1 V (p-p), 75 ohms
	PR: 0.7 V (p-p), 75 ohms
	PB: 0.7 V (p-p), 75 ohms
Output:	AUDIO: -8 dBm/50k ohms

Antenna input:	VHF/UHF/CABLE In 75 ohm coaxial
Picture Size:	67.5cm (27" class/26.6" diagonal)
Tuner Type:	NTSC Standard
	ATSC Standard (8VSB), QAM
Receiving Channels:	VHF 2-13
	UHF 14-69
	CABLE TV 14-36 (A)-(W)
	37-59 (AA)-(WW)
	60-85 (AAA)-(ZZZ)
	86-94 (86)-(94)
	95-99 (A-5)-(A-1)
	100-125 (100)-(125)
	01 (5A)
Speakers:	2 inches (50.8 mm) x 3-1/2 inches (88.9 mm), 8 ohm x 2
Sound output power:	1.0 W + 1.0 W

ACCESSORY

Remote Control

Design and specifications are subject to change without notice.

Your Zenith Direct View TV Warranty

Direct-View Color TV Welcome to the Zenith family! We believe that you will be pleased with your new Zenith TV. Please read this warranty carefully, it is a "LIMITED WARRANTY" as defined under Federal Law. This warranty gives you specific legal rights, and you may also have other rights that vary from state to state within the U.S.A.

ZENITH'S RESPONSIBILITY

- Service Labor** During a period of one year from effective warranty date, Zenith will provide service labor by a Zenith authorized service center when needed, as determined by the Zenith service center, as a result of manufacturing defects.
- Parts** New or remanufactured replacements for factory-defective parts will be supplied by a Zenith authorized service center for one year from effective warranty date (color picture tube – two years). Such replacement parts are warranted for the remaining portion of the original warranty period.
- Warranty Service** Warranty service is provided in the institution in most cases. (Some repairs may require the unit to be taken by the servicer to the repair facility and returned, at no additional charge.) Call **1-888-865-3026** for further information.
- Not Covered** This warranty covers manufacturing defects and does not cover installation, adjustment of customer controls, installation or repair of antenna systems, cable converters or cable company-supplied equipment; it also does not cover damage due to misuse, abuse, negligence, acts of God or other causes beyond the control of Zenith. Any alteration of the product after manufacture voids this warranty in its entirety.

THIS WARRANTY IS IN LIEU OF ANY OTHER WARRANTY, EXPRESS OR IMPLIED, INCLUDING WITHOUT LIMITATION, ANY WARRANTY OF MERCHANTABILITY OR FITNESS FOR A PARTICULAR PURPOSE, AND ZENITH SHALL NOT BE LIABLE FOR ANY CONSEQUENTIAL, INDIRECT, OR INCIDENTAL DAMAGES OF ANY KIND, INCLUDING LOST REVENUES OR PROFITS IN CONNECTION WITH THIS PRODUCT. SOME STATES DO NOT ALLOW LIMITATIONS ON HOW LONG AN IMPLIED WARRANTY LASTS OR THE EXCLUSION OR LIMITATION OF INCIDENTAL OR CONSEQUENTIAL DAMAGES, SO THE ABOVE LIMITATIONS OR EXCLUSIONS MAY NOT APPLY TO YOU.

OWNER'S RESPONSIBILITY

- Effective Warranty** Date Warranty begins on the date of installation of the Commercial Products Direct-View Television Receiver.
For your convenience, keep the dealer's dated bill of sale or delivery ticket as evidence of the purchase date.
- Operating Guide** Read your Operating Guide carefully so that you will understand the operation of the TV and how to adjust the controls.
- Antenna** Reception problems caused by inadequate antenna or faulty antenna connections are the owner's responsibility.
- Important** Product Registration—Please fill out and mail the Product Registration Card. It is imperative that Zenith know how to reach you promptly if we should discover a safety problem that could affect you.
- Warranty Service** **For warranty service information, call 1-888-865-3026.** Parts and service labor that are Zenith's responsibility (see above) will be provided without charge. Other service is at the owner's expense. If you have any problem in obtaining satisfactory warranty service, call **1-888-865-3026**. You must provide the model number, serial number and date of purchase or date of original installation. Before you ask for warranty service, read "Troubleshooting" in the operating guide. You might avoid a service call.

For Customer Support/Service
Please call:
1-888-865-3026
www.zenith.com

Free Manuals Download Website

<http://myh66.com>

<http://usermanuals.us>

<http://www.somanuals.com>

<http://www.4manuals.cc>

<http://www.manual-lib.com>

<http://www.404manual.com>

<http://www.luxmanual.com>

<http://aubethermostatmanual.com>

Golf course search by state

<http://golfingnear.com>

Email search by domain

<http://emailbydomain.com>

Auto manuals search

<http://auto.somanuals.com>

TV manuals search

<http://tv.somanuals.com>