

Model Number | **H20H52DT**
HW20H52DT



Please read this manual carefully before operating your set.
Retain it for future reference. Record model number and serial number of the set.
See the label attached on the back cover and quote this information to your dealer
when you require service.

table of contents | page 5

Internet Home Page : <http://www.zenith.com>

P/N : 3828VA0518B (a) (FCH-50)

For Customer Support/Service please call:

1-888-865-3026

www.zenith.com

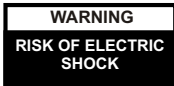

RECORD THE MODEL NUMBER

The serial number of this HealthView™ TV is located on the back of the cabinet. For future reference, we suggest that you record the serial number here:

MODEL NO. **H20H52DT/HW20H52DT**
SERIAL NO. _____

WARNING :



TO REDUCE THE RISK OF ELECTRIC SHOCK DO NOT REMOVE COVER (OR BACK). NO USER SERVICEABLE PARTS INSIDE.

REFER TO QUALIFIED SERVICE PERSONNEL.

The lightning flash with arrowhead symbol, within an equilateral triangle, is intended to alert the user to the presence of uninsulated "dangerous voltage" within the product's enclosure that may be of sufficient magnitude to constitute a risk of electric shock to persons.



The exclamation point within an equilateral triangle is intended to alert the user to the presence of important operating and maintenance (servicing) instructions in the literature accompanying the

WARNING :

TO PREVENT FIRE OR SHOCK HAZARDS, DO NOT EXPOSE THIS PRODUCT TO RAIN OR MOISTURE.

POWER CORD POLARIZATION:

This product is equipped with a 3-wire grounding-type alternating current line plug. This plug will fit into the power outlet only one way. This is a safety feature. If you are unable to insert the plug fully into the outlet, contact your electrician to replace your obsolete outlet. Do not defeat the safety purpose of the three-wire ground type plug.

NOTE TO CABLE/TV INSTALLER:

This reminder is provided to call the cable TV system installer's attention to Article 820-40 of the National Electric Code (U.S.A.). The code provides guidelines for proper grounding and, in particular, specifies that the cable ground shall be connected to the grounding system of the building, as close to the point of the cable entry as practical.

REGULATORY INFORMATION:

This equipment has been tested and found to comply with the limits for a Class B digital device, pursuant to Part 15 of the FCC Rules. These limits are designed to provide reasonable protection against harmful interference when the equipment is operated in a residential installation. This equipment generates, uses and can radiate radio frequency energy and, if not installed and used in accordance with the instruction manual, may cause harmful interference to radio communications. However, there is no guarantee that interference will not occur in a particular installation. If this equipment does cause harmful interference to radio or television reception, which can be determined by turning the equipment off and on, the user is encouraged to try to correct the interference by one or more of the following Measures:

- Reorient or relocate the receiving antenna.
- Increase the separation between the equipment and receiver.
- Connect the equipment into an outlet on a circuit different from that to which the receiver is connected.
- Consult the dealer or an experienced radio/TV technician for help.

CAUTION:

Do not attempt to modify this product in any way without written authorization from Zenith Electronics Corporation. Unauthorized modification could void the user's authority to operate this product.

COMPLIANCE:

The responsible party for this product's compliance is:

Zenith Electronics, Inc. 1000 Sylvan Avenue, Englewood Cliffs, NJ 07632. 1-201-816-2000

© Copyright 2004 Zenith Electronics Corporation

IMPORTANT SAFETY INSTRUCTIONS

Important safeguards for you and your new product.

Your product has been manufactured and tested with safety in mind. However, improper use can result in potential electrical shock or fire hazards. To avoid defeating the safeguards that have been built into the new product, please read and observe the following safety points when installing and using the new product, and save them for future reference.

Observing the simple precautions discussed in this guide can help get and enjoy many years of safe operation that are built into your new product.

This product complies with all applicable U.S. Federal safety requirements, and those of the Canadian Standards Association.

1. Read Instructions

All the safety and operating instructions should be read before the product is operated.

2. Follow Instructions

All operating and use instructions should be followed.

3. Retain Instructions

The safety and operating instructions should be retained for future reference.

4. Heed Warnings

All warnings on the product and in the operating instructions should be adhered to.

5. Cleaning

Unplug this product from the wall outlet before cleaning. Do not use liquid cleaners or aerosol cleaners. Use a damp cloth for cleaning.

6. Water and Moisture

Do not use this product near water for example, near a bath tub, wash bowl, kitchen sink, or laundry tub, in a wet basement, or near a swimming pool.

7. Accessories, Carts, and Stands

Do not place this product on a slippery or tilted surface, or on an unstable cart, stand, tripod, bracket, or table. The product may slide or fall, causing serious injury to a child or adult, and serious damage to the product. Use only with a cart, stand, tripod, bracket, or table recommended by the manufacturer, or sold with the product. Any mounting of the product should follow the manufacturer's instructions, and should use a mounting accessory recommended by the manufacturer.

8. Transporting Product

A product and cart combination should be moved with care.

Quick stops, excessive force, and uneven surfaces may cause the product and cart combination to overturn.

9. Attachments

Do not use attachments not recommended by the product manufacturer as they may cause hazards.

10. Ventilation

Slots and openings in the cabinet are provided for ventilation and to ensure reliable operation of the product and to protect it from overheating, and these openings must not be blocked or covered. The openings should never be blocked by placing the product on a bed, sofa, rug, or other similar surface. This product should not be placed in a built-in installation such as a bookcase or rack unless proper ventilation is provided or the manufacturer's instructions have been adhered to.

11. Power Sources

This product should be operated only from the type of power source indicated on the marking label. If you are not sure of the type of power supply to your home, consult your product dealer or local power company. For products intended to operate from battery power, or other sources, refer to the operating instructions.

12. Power Cord Polarization

This product is equipped with a polarized alternating-current power plug (a plug having on blade wider than the other). This plug will fit into the power outlet only one way. This is a safety feature. If you are unable to insert the plug fully into the outlet, try reversing the plug. If the plug still fail to fit, contact your electrician to replace your obsolete outlet. Do not defeat the safety purpose of the polarized plug.

13. Power Cord Protection

Power-supply cords should be routed so that they are not likely to be walked on or pinched by items placed upon or against them, paying particular attention to cords at plugs, convenience receptacles, and the point where they exit from the product.

14. Outdoor Antenna Grounding

If an outside antenna or cable system is connected to the product, be sure the antenna or cable system is grounded so as to provide some protection against voltage surges and built-up static charges. Article 810 of the National Electrical Code (U.S.A.), ANSI/ NFPA 70 provides information with regard to proper grounding of the mast and supporting structure, grounding of the lead-in wire to an antenna discharge unit, size of grounding conductors, location of antenna-discharge unit, connection to grounding electrodes, and requirements for the grounding electrode.



PORTABLE CART WARNING

(Continued on next page)

IMPORTANT SAFETY INSTRUCTIONS

(Continued from previous page)

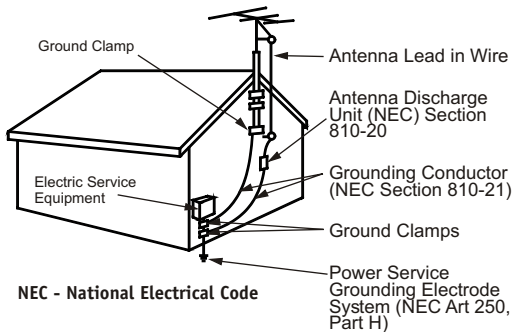

15. Lightning

For added protection for this product (receiver) during a lightning storm, or when it is left unattended and unused for long periods of time, unplug it from the wall outlet and disconnect the antenna or cable system. This will prevent damage to the product due to lightning and power-line Surges.

16. Power Lines

An outside antenna system should not be located in the vicinity of overhead power lines or other electric light or power circuits, or where it can fall into such power lines or circuits. When installing an outside antenna system, extreme care should be taken to keep from touching such power lines or circuits as contact with them might be fatal.

17. Overloading

Do not overload wall outlets and extension cords as this can result in a risk of fire or electric shock.

18. Object and Liquid Entry

Never push objects of any kind into this product through openings as they may touch dangerous voltage points or short-out parts that could result in a fire or electric shock.

Never spill liquid of any kind on the product.

19. Servicing

Do not attempt to service this product yourself as opening or removing covers may expose you to dangerous voltage or other hazards. Refer all servicing to qualified service personnel.

20. Damage Requiring Service

Unplug this product from the wall outlet and refer servicing to qualified service personnel under the following conditions:

- If the power-supply cord or plug is damaged.
- If liquid has been spilled, or objects have fallen into the product.
- If the product has been exposed to rain or water.
- If the product does not operate normally by following the operating instructions. Adjust only those controls that are covered by the operating instructions as an improper adjustment of other controls may result in damage and will often require

extensive work by a qualified technician to restore the product to its normal operation.

E. If the product has been dropped or the cabinet has been damaged.

f. If the product exhibits a distinct change in performance.

21. Replacement Parts

When replacement parts are required, be sure the service technician has used replacement parts specified by the manufacturer or have the same characteristics as the original part. Unauthorized substitutions may result in fire, electric shock, or other hazards.

22. Safety Check

Upon completion of any service or repairs to this product, ask the service technician to perform safety checks to determine that the product is in proper operating condition.

23. Wall or Ceiling Mounting

The product should be mounted to a wall or ceiling only as recommended by the manufacturer. The product may slide or fall, causing serious injury to a child or adult, and serious damage to the product.

24. Heat

The product should be situated away from heat sources such as radiators, heat registers, stoves, or other products (including amplifiers) that produce heat.

25. CAUTION concerning the Power Cord:

Most appliances recommend they be placed upon a dedicated circuit; that is, a single outlet circuit which powers only that appliance and has no additional outlets or branch circuits. Check the specification page of this owner's manual to be certain.

Do not overload wall outlets. Overloaded wall outlets, loose or damaged wall outlets, extension cords, frayed power cords, or damaged or cracked wire insulation are dangerous. Any of these conditions could result in electric shock or fire. Periodically examine the cord of your appliance, and if its appearance indicates damage or deterioration, unplug it, discontinue use of the appliance, and have the cord replaced with an exact replacement part by an authorized servicer.

Protect the power cord from physical or mechanical abuse, such as being twisted, kinked, pinched, closed in a door, or walked upon. Pay particular attention to plugs, wall outlets, and the point where the cord exits the appliance.

26. Outdoor use Marking

WARNING - To reduce the risk of fire or electric shock, do not expose this appliance to rain or moisture.

27. Wet Location Marking

Apparatus shall not be exposed to dripping or splashing and no objects filled with liquids, such as vases, shall be placed on the apparatus.

TABLE OF CONTENTS

Use the steps outlined below as a setup guide and to determine the TV features that will require adjustment for the needs of the end user.

Safety Warnings	2	Setting On/Off Timers	17
Important Safety Instructions	3 - 4	Captions (Caption/Text)	19
Table of Contents	5	Language	21
Step 1. Hook Up the HealthViewTV		Video Menu	22
TV and other Equipment Hookups		FM Radio Menus	23 - 24
Antenna	6	Installer Parental Control Menu	25 - 26
Cable Service	7	Other Menus and On-Screen Displays	27
Antenna with VCR	8	Managing the Channel Banks	28 - 30
Cable service with VCR	9	Installer Menus	31 - 38
External Speaker Connection (8-ohm output) ..	9	LT2000 Quickset II Clone Programmer	39 - 43
Pillow Speaker	10		
Step 2. Channel Search and Reception Setup		Patient Operation Section (Copy for patient usage)	
Auto Program	11	Optional Patient Remote Key Functions	44
(Select Antenna, or cable service then do channel search)		Optional Patient Remote	
Front Panel Controls	12	Key Functions - FM Radio	45
Optional Installer's Remote Key Functions	13	Patient Parental Control Menu	46 - 47
On-Screen Menus Overview	14	Patient Menus and On-Screen Displays	48
Step 3. Customize the TV's Features		Maintenance	49
Setup Menu (Start with page 11, Auto Program)		Troubleshooting	50
Descriptions of the menus on the TV	15	Glossary	51
Setting Add/Del/Blank	16	Warranty for HealthView Series TVs	Back
Clock Set	18		Cover

Optional Installer and Patient Remote Controls:

Shown herein are optional remote controls that can be used by the installer and the patient. Be advise that these remote controls are NOT included with this TV. However, these remotes can be purchased separately, see your Zenith Electronics dealer.

Installer/Hospital Note:

Pages 44, 45, 46, 47 and 48 contain information and menus which the patient can use to operate the TV. It is recommended that these four pages be copied and included with the literature packet that the hospital provides to the patient.

Purchase the Optional Installer's Remote and Clone Programmer

To perform a normal installation set up, you need an installer's remote such as the HP602, and the LT2000 Quickset II Clone Programmer—both are shown and described in later sections. The installer remote allows access to the Installer menus, User menus, and Source/Channel Bank keys. The installer remote has Menu, Select, and Adjust, and Channel Bank Keys. The LT2000 Quickset II Clone Programmer is used to duplicate a TV's setup and install it on another identical TV. See your Zenith Dealer.

Design and specifications subject to change without prior notice.

Antenna Hook Up

Connect an off-air antenna to the HealthView TV.

- 1 Locate the Antenna/Cable jack on the back of the HealthView TV.
- 2 Connect the antenna wire that runs from the wall to this jack, according to one of the diagrams shown to the right.
- 3 Remove the back of the optional remote and put in two AA batteries.

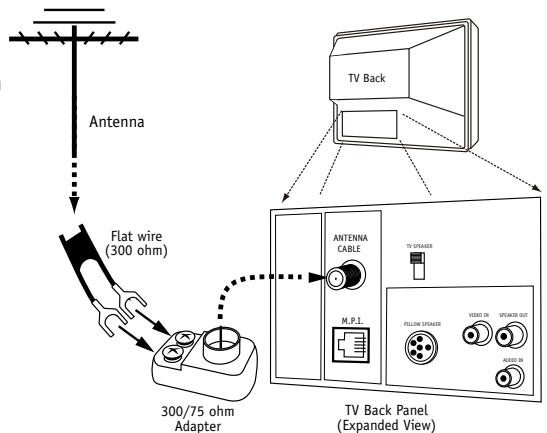
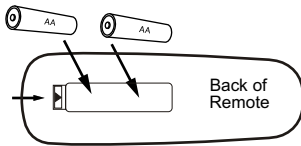

- 4 Plug in the TV. The HealthView TV is designed to operate on standard current, 120-volt 60 Hertz AC. Do not attempt to operate it on DC Power.

- 5 Go to page 11 to Auto Program the TV.



If you have a 75 ohm RF cable, then you don't need any adapters.



A 300 to 75 ohm adapter is not included with the Zenith HealthView TV.

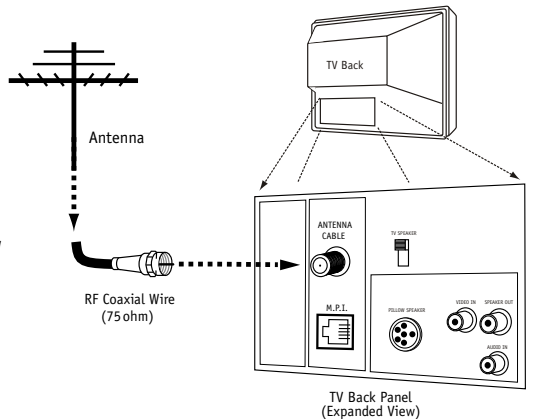

Mini Glossary

75 OHM RF CABLE

The wire that comes from an off-air antenna or cable service provider. Each end looks like a hex shaped nut with a wire sticking through the middle, and it screws onto the threaded jack on the back of the TV.

300 TO 75 OHM ADAPTER

A small device that connects a two-wire 300 ohm antenna to a 75 ohm RF jack. They are usually about an inch long with two screws on one end and a round opening with a wire sticking out on the other end.

Cable Service (CATV) Hook Up

Connect cable service to the HealthView TV.

- 1 Locate the Antenna/Cable jack on the back of the HealthView TV.
- 2 Connect the cable service wire that runs from the wall, according to one of the diagrams to the right.
- 3 Remove the back of the optional remote and put in two AA batteries.

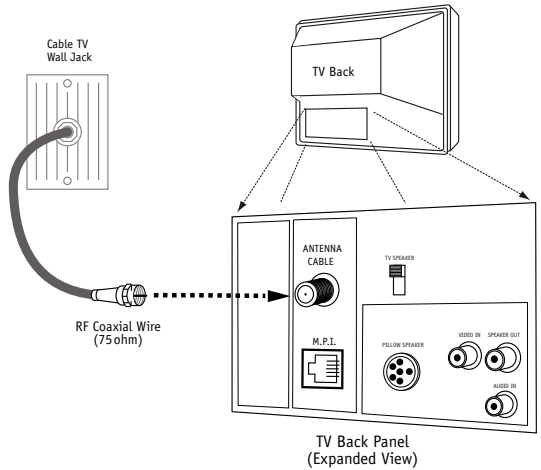
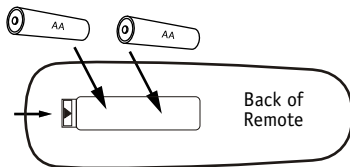

- 4 Plug in the TV. The HealthView TV is designed to operate on standard current, 120-volt 60 Hertz AC. Do not attempt to operate it on DC power.
- 5 Go to page 11 to Auto Program the TV.

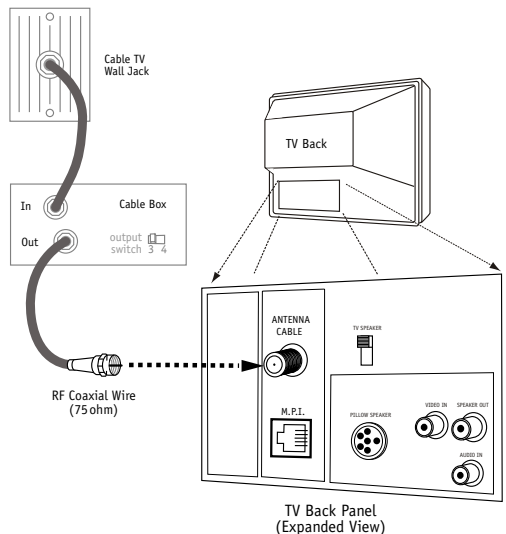

If you're using a cable box, leave the TV on channel 3 or 4 and use the cable box to change channels.



If you're using a cable box, Auto Program might only find the channel the cable service is on (usually channel 3 or 4).

Antenna with VCR Hook Up

Connect an off-air antenna and VCR to the HealthView TV.

- 1 Locate the Antenna/Cable in jack on the back of the VCR.
- 2 Connect the antenna wire according to one of the diagrams to the right.
- 3 Remove the back of the optional remote and put in two AA batteries.

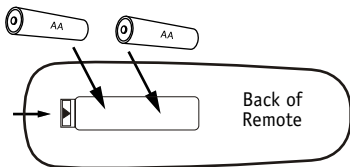

- 4 Plug in the TV. The HealthView TV is designed to operate on standard current, 120-volt 60 Hertz AC. Do not attempt to operate it on DC power.
- 5 Go to page 11 to Auto Program the TV.

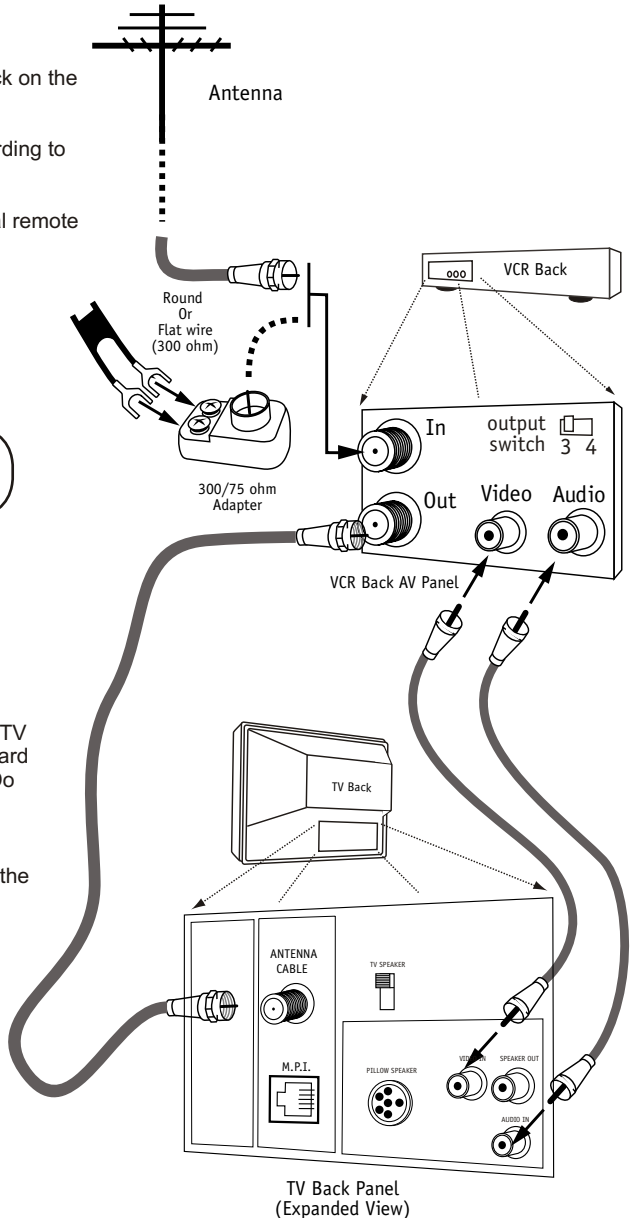

Cable Service (CATV) with VCR Hook Up

Connect Cable service and a VCR to the HealthView TV.

- 1 Locate the Antenna/Cable in jack on the back of the VCR.
- 2 Connect the wire that runs from the cable service wall jack, according to one of the diagrams to the right.
- 3 Remove the back of the optional remote and put in two AA batteries.

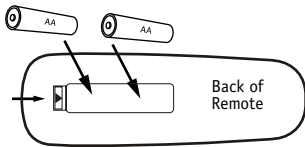

- 4 Plug in the TV. The HealthView TV is designed to operate on standard current, 120-volt 60 Hertz AC. Do not attempt to operate it on DC power.
- 5 Go to page 11 to Auto Program the TV.

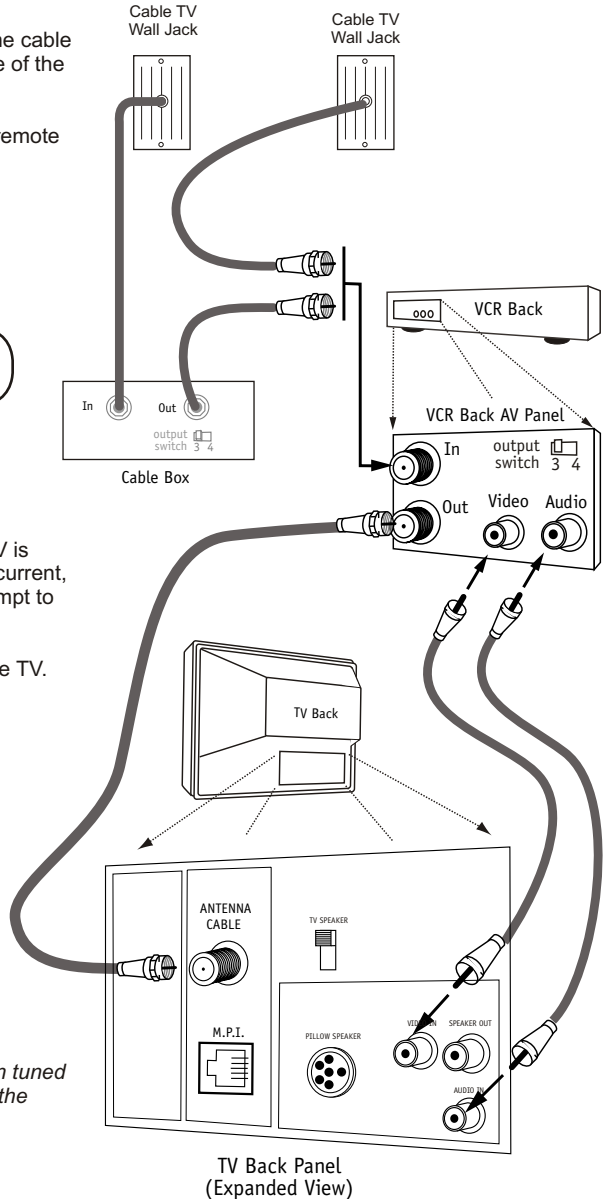

Leave the VCR and the television tuned to channel three or four and use the cable box to change channels.

External Speaker Connection (8-ohm)

Connect Speaker out to an 8-ohm speaker as shown.

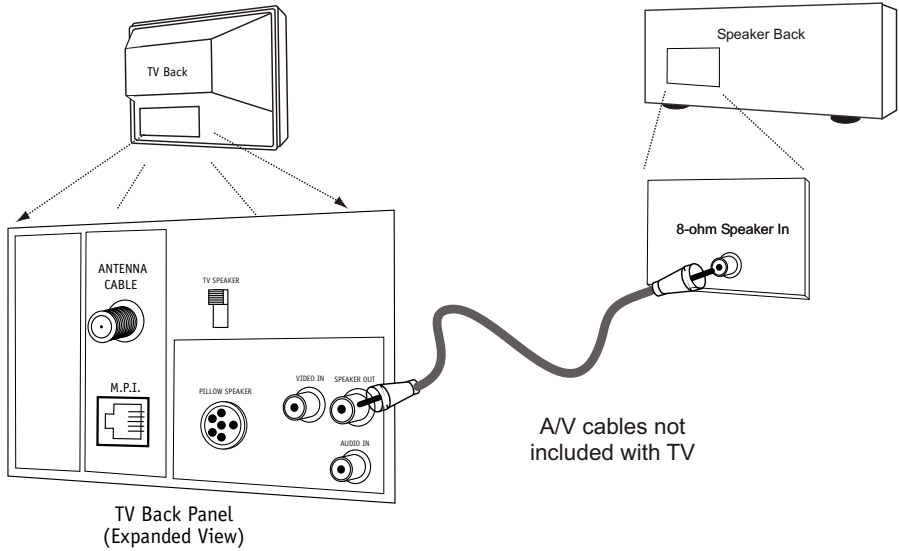

Pillow Speaker Hook Up

Connect a Pillow Speaker to the HealthView TV.

- 1** Locate the Pillow Speaker Output jack on the back of the HealthView TV.
- 2** Connect an accessory pillow speaker or wired remote control unit to this 6-pin jack.
- 3** Select PILLOW SPKR on the rear panel of the HealthView TV.

Use a pillow speaker by Curbell, Model A-16455-02 or other UL recognized pendant control bearing the warning:
"Risk of fire if used in oxygen enriched atmosphere. Keep pendant control away from oxygen equipment."

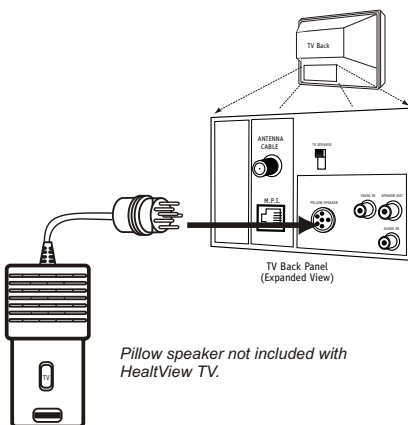

Controlling the TV with Serial Data

The TV is capable of being controlled by a single-wire, serial data signal. This is a Zenith patented technology and is being implemented by certain brands of "smart" pillow speakers, such as Curbell's "GEN-II" models.

Pillow Speaker Interface

This connector furnishes three control lines and an audio output. A patient-pendant remote control, or entertainment audio and nurse call system may be connected here. All lines are isolated from the AC power line and earth ground. (Opto-isolators isolate the control lines, and a transformer isolates the audio. There are no relays or inductive components in the control lines).

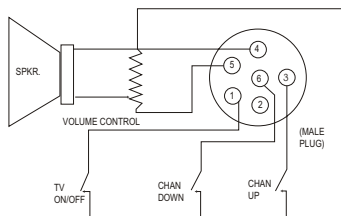

Controlling the TV with mechanical switches

Pin 4 (common) is momentarily connected to pin 1, 3, or 6 via push-action switches to control On/Off and Channel Up/Down. These pins are at +13 volts DC (when measured from pin 4) with the switches open. Current draw is 8 mA when a switch is closed. (This operation using the 5-Wire Interface except that only +7 volts DC was supplied and current draw was only 2.5 mA).

Pin no.	Purpose
1	External TV On/Off switch
2	(Not used)
3	External Channel Up switch or Data in
4	Common connection for control, data, and Audio output. Impedance to earth ground is a 8.2- meg resistor in parallel with a 1000 pf capacitor.
5	Isolated audio output. Nominal 14-ohm source impedance with short circuit protection. Intended for a pillow speaker with a low-impedance pad-type volume control.
6	External Channel Down switch

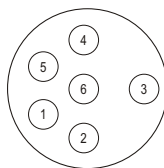



- 1 — TV ON/OFF
- 2 — OPEN
- 3 — CHAN UP/DATA IN
- 4 — COMMON
- 5 — AUDIO OUT
- 6 — CHAN DOWN

Auto Program (Channel Search)

Use Auto Program to specify Cable TV or Off Air Antenna incoming signal source and automatically store in the memory of the TV, all of the channels that are found by the channel search.

- 1 With the optional Installer remote control in hand, press the POWER key to turn on the HealthView TV.
- 2 Press the MENU key to show the Setup menu.
- 3 Using SELECT on the remote control, highlight Auto Program on the screen.
- 4 Press the Right or Left ADJ (Adjust) arrow to go to the Auto Program menu.
- 5 Using SELECT, choose either Cable TV or Off Air Antenna on the screen.
- 6 Press the Right or Left ADJ arrow to begin the Channel Search.
- 7 Press ENTER when the channel search is complete.

 *Auto Program finds channels being received by the TV tuner.*

 *Cable will not work unless the hospital provides a cable service.*

Optional Installer and Patient Remote Controls:

Shown herein are optional remote controls that can be used by the installer and the patient. Be advise that these remote controls are NOT included with this TV. However, these remotes can be purchased separately, see your Zenith dealer.

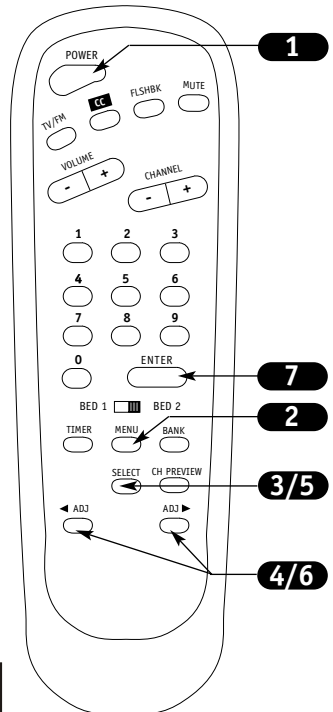
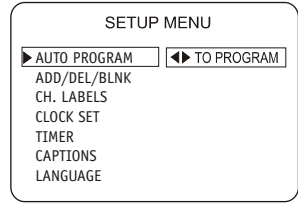

Mini Glossary

OFF AIR ANTENNA If the patient can only view over-the-air broadcast, select Antenna.

CABLE If you provide cable service to the patients, select Cable.

Front Panel Controls

Using the front control panel to operate the television.

- 1** Press the POWER button to turn on the HealthView TV.
- 2** Use the CHANNEL button to cycle through available channels.
- 3** Use the VOLUME button to adjust the sound level of the HealthView TV.
- 4** Press CAPTIONS repeatedly to turn selected closed captions option On or Off. (See Captions Page19).

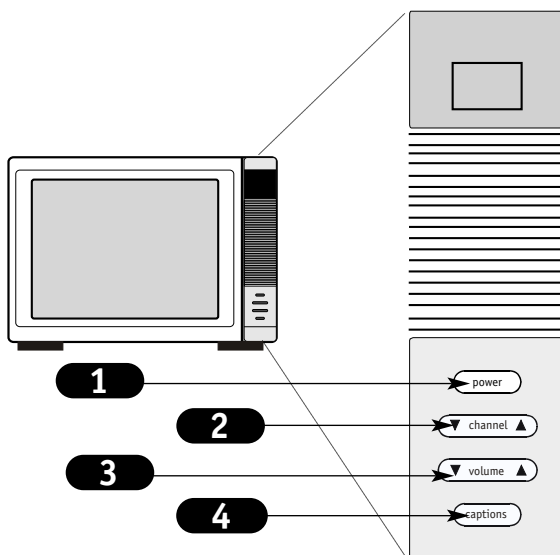

Installer Remote Key Functions

A quick list of the keys on the optional HP602 installer's remote and what they do.

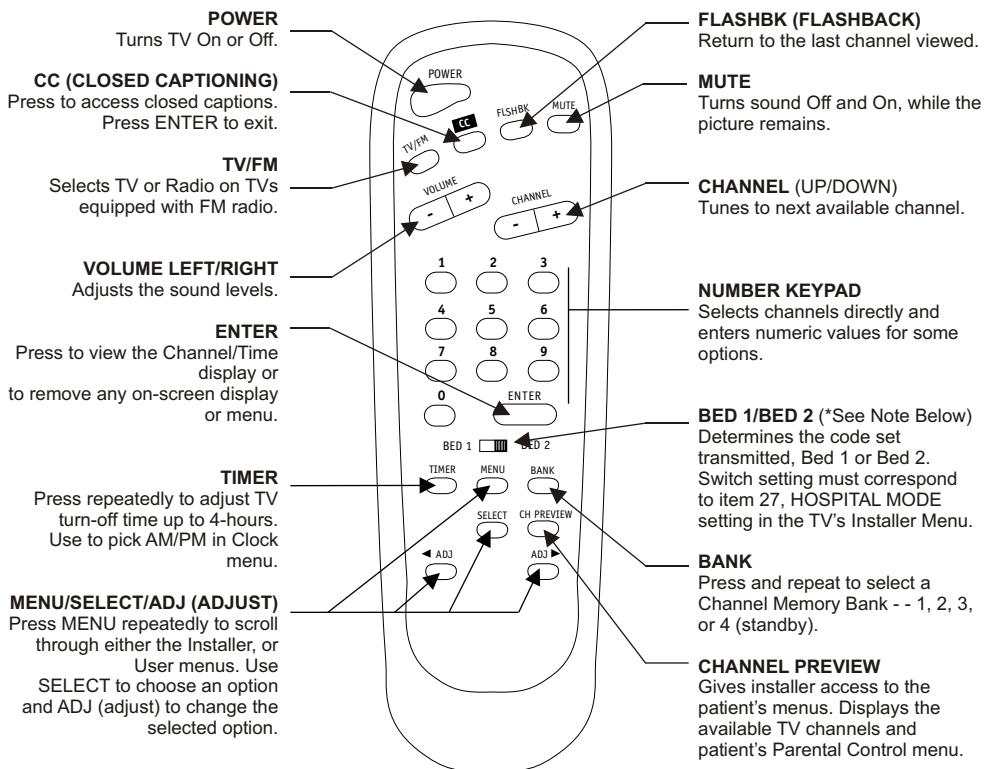

124-213-06
remote control part number
HP602

***Note:** Bed 1 - Bed 2 switch on installer/patient remote. The position of the Bed 1 - Bed 2 switch must correspond to the setting in the Installer's menu. The switch above can be set by sliding it to the Bed 1 or Bed 2 position. On the patients' remote, the Bed 1 or Bed 2 position can be selected by using a paper clip or a ball-point pen to slide the switch to the correct position.

Left position = Bed 1.

Right Position = Bed 2.

On-Screen Menus Overview

Descriptions of the menus on the TV.

Using the Menu button on the optional installer's remote, the installer can access all the menus below.

Menu Name	Page	Description
Setup Menu		Adjusts the basic characteristics of the TV
Auto Program	11	Automatically finds and stores active channels to scroll through using Channel Up/Down.
Add/Del/Blink	15	Manually choose which active channels will appear when using Channel Up/Down.
Channel Labels	16	Labels the channels with their network names (ABC, CBS, HBO, etc.) or create custom names.
Clock Set	17	Sets the time.
On/Off Timers	18	Set the timers to automatically turn the TV On/Off each day at the preset time(s).
Captions	19	Chooses the captioning or text option.
Language	20	Chooses the language the on-screen menus will appear in. Video Menu
Video Menu	21	Adjusts the picture appearance. The options are: Contrast, Brightness, Color, Tint, Sharpness, Picture Pref.
FM Radio Menu	22	Adjusts the FM Radio options.
Parental Control	24	Allows installer to restrict viewable programming for up to 99 hours, with the use of a password.
	26	OTHER MENUS AND ON-SCREEN DISPLAYS
Channel/Time		Shows the current time, selected channel and XDS* data if available.
Sleep Timer		Sets the time the TV will turn off.
Volume		Shows current sound level.
Captions		Sets Caption/Text options.
Ch Preview		Displays the available channels list.
Channel Bank		Shows currently selected channel bank.
Inactive TV		Prompts the patient to arrange for TV service.
INSTALLER MENUS	30	Sets up the TV's operating features.

*XDS (Extended Data Service) Additional program information provided at the discretion of the broadcaster. May include: title of broadcast, length of broadcast, and time remaining until end of broadcast.

Setting Up Channel Line Up/Add/Delete/Blank

Fine-tune the patient's channel selection list.

- 1** Press the MENU key on the optional Installer's remote to show the Setup menu on the screen.
- 2** Press SELECT repeatedly to highlight the Add/Del/Blnk option.
- 3** Using either the NUMBER keypad and ENTER or the Channel Up/Down arrows on the remote, select a channel. (If adding a deleted channel, you will need to use the number keypad and ENTER).
- 4** Using the Right/Left ADJ arrow, choose whether the channel is Added, Deleted, or Blank.
- 5** To continue, select another channel and repeat Step 3. When you are finished, press ENTER to remove menu.

Adding VCR 3, VCR 4, or FM to the Channel Preview List

Go to the Setup menu, select the Add/Del/Blnk option. Use Channel Up/Down to select the option and choose Added.

Note: If the option was turned off in the Service menu, you will have to reinstate it before it can appear as an option in the Channel Preview list.

Note: You can elect to Add, Delete or Blank: **VCR 3** and **VCR 4**. **FM** can be Added or Deleted, but not Blanked.

 If you delete a channel, it isn't gone for good. Just select it using the NUMBER keypad on the remote, or add it later.

SETUP MENU

AUTO PROGRAM

▶ ADD/DEL/BLNK CH 44 ADDED

CH. LABELS

CLOCK SET

TIMER

CAPTIONS

LANGUAGE

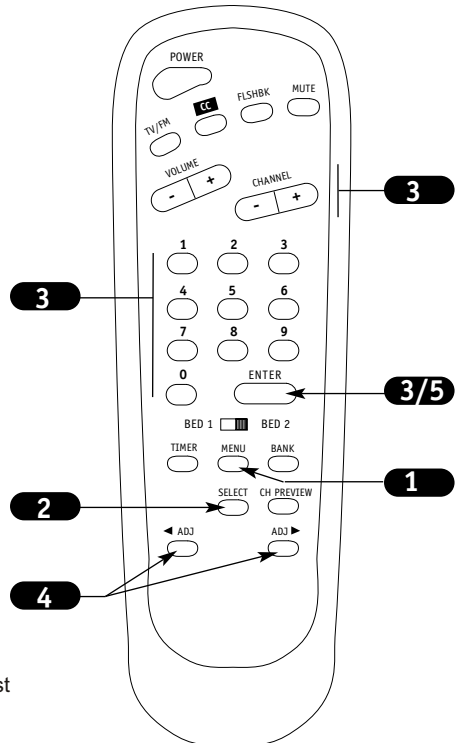

Mini Glossary

ADD Adds new channels to the list that the patient can scroll through when using the remote.

DELETE Removes channels for one reason or another from the list that the patient can scroll through.

BLANK Removes the video signal from a channel so the patient will only receive the audio signal.

Setting Up Channel Labels

Overview

Channel Labels help the user identify the channel or network being viewed.

In the Setup menu with the CH LABELS option highlighted, use the Adjust Left/Right arrows to scroll through the available channel labels, such as, A & E, AMC, ESPN, HBO, etc. These are a series of alphabetically organized preset labels from which you can choose the more common networks. Use any of these or create custom labels.

----, The 4 dashes will allow a channel label to appear; if one is provided by XDS. (Extended Data Service).

NONE, prevents any channel label from appearing.

LAB 1, thru **LAB 20**, are the 20 programmable labels.

The 20 programmable labels can be customized for your needs.

Each programmable label has 5 character spaces available.

To Program a Channel Label

First select a channel using the NUMBER keypad and ENTER or the Channel Up/Down arrows, on the optional Installer's remote control.

(To select a deleted channel, use the NUMBER keypad and ENTER).

To program a channel label, go to the Setup menu and select CH LABELS.

Press the Right/Left adjust arrow to scroll the available preset labels. Scroll past ----, scroll past NONE, to go to the first programmable label slot, LAB 1. Notice that the label appears with the title LAB 1, and is also on a dark background; which will distinguish it from the preset labels.

Operating the Menu

Use Volume Up/Down to select the first letter.

Press MUTE to clear the label if necessary.

Use Channel Up/Down to change the character to one of the 255 characters available.

(A blank letter space is available if required, after the "!" Symbol).

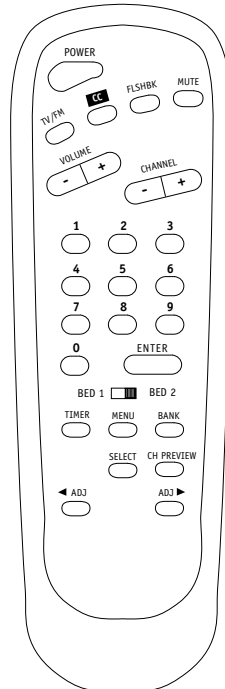
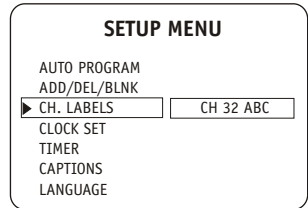

Adjust Left/Right Switches to the next label. -- moves to the next or previous Label.

Volume Up/Down Selects character spaces -- moves to the next or previous character space.

Channel Up/Down Scrolls through the available characters.

ENTER Accept the channel label and removes the menu.

MUTE Removes current label, -- if first character space is selected.

Clock Set

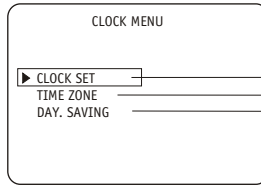
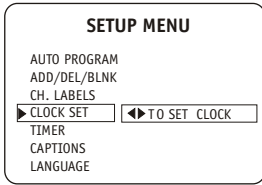

PRESS SELECT TO CHOOSE
PRESS ADJ ◀▶ TO CHANGE

AUTO
AUTO OFF
ON
AUTO EASTERN
CENTRAL
MOUNTAIN
PACIFIC

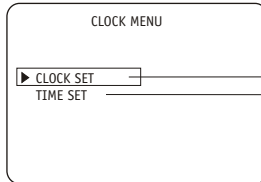
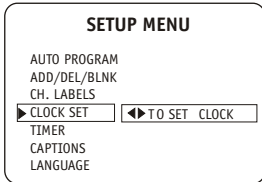

PRESS SELECT TO CHOOSE
PRESS ADJ ◀▶ TO CHANGE

MANUAL
10:43 AM ◀TIMER

Clock Auto/Manual Operating Modes Setup

Use MENU, SELECT, and ADJ Left/Right to choose the Clock menu and to set up the clock menu options, with the optional Installer's remote.

Clock Mode

Auto: TV automatically sets the time. Time Zone: User can choose the time zone or have the TV set it automatically.

Day. Savings: User can choose to have daylight savings adjust the clock time one hour, or have the TV adjust it automatically.

Manual: User sets the time on the clock. Use ENTER repeatedly to remove menus.

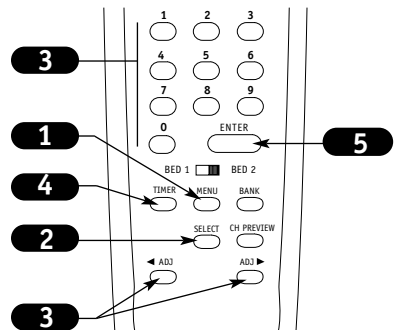

The clock can also be set using 24 hour "military time." For p.m. Settings add 1200. For example, to set 6:30 p.m., add 1200 to 630, = enter 1830.



For Auto Clock Set to work, TV must be tuned to a channel that has XDS data available. Auto Clock Set, sets the time only once while the TV is on. To set the clock with XDS data, turn TV off, then back on again, or set the clock time manually.

Mini Glossary

- TIME** A four-digit figure broken down into hours and minutes, used to enter the current time when setting the clock or wake-up alarm.
- HOURS** First two digits that are entered when setting the clock or the wake-up alarm.
- MINUTES** The last two digits that are entered when setting the clock, or the wake-up alarm.
- TIMER** Chooses AM or PM when setting the clock.

Setting On/Off Timers

Set up On/Off Timers

Note: On/Off Timers operate independently of each other.

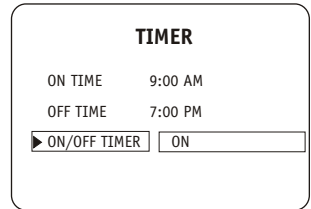
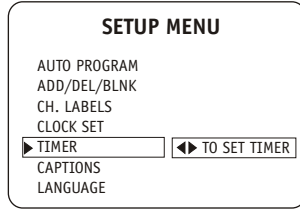

- 1** On the optional HP602 Installer's remote, press MENU repeatedly until the Setup menu appears.
- 2** Press SELECT repeatedly to highlight the Timer option, press the Right arrow.
- 3** Use SELECT to choose an option. Use the number keypad and/or the Left/Right ADJ arrows to enter the times. To set PM, add 12 to the hours. For example, to set 6:00 p.m. Use the number keypad to set 1-8-0-0. (6 for the hours and the extra 12 for PM.) Do not use the TIMER key to set AM/PM.
- 4** Press ENTER to remove menu and return to TV viewing.

Your options are:

- **On Time**
Sets a time that the TV will turn itself On each day.
- **Off Time**
Sets a time that the TV will turn itself Off each day.
- **On/Off Timer**
Enables or disables the On/Off Timer functions. (The On/Off Timer can be disabled but the settings will be retained).

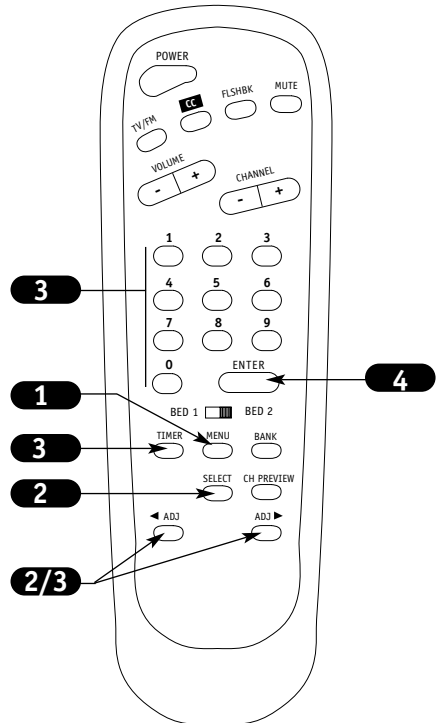

The clock must be set before the Timers will function.



The Off Timer can be used to turn the TV off at the preset time.
Note: No On Timer setting is required to use the Off Timer feature.

Mini Glossary

- TIME** A four-digit figure broken down into hours and minutes, used to enter the time when setting the clock or programming timers.
- HOURS** First two digits that are entered when setting the clock or programming timers. (Add 12 for PM settings).
- MINUTES** The last two digits that are entered when setting the clock, or programming timers.

Captions (Captions/Text)

Set up Closed Caption/Text options for the user.

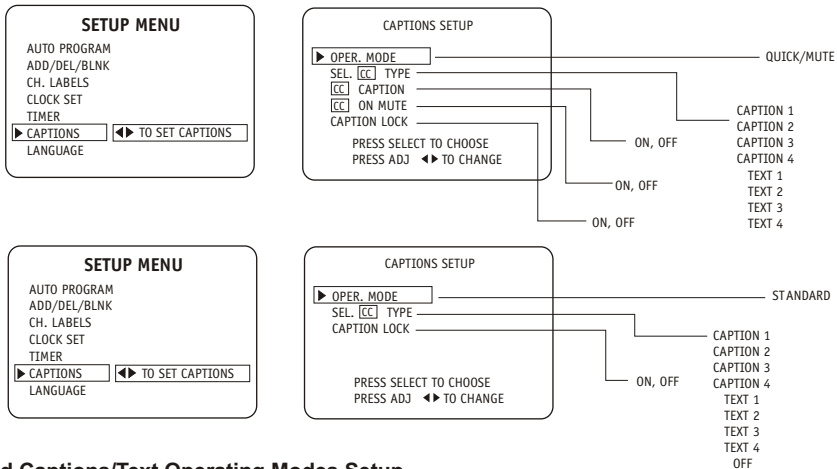

Closed Captions/Text Operating Modes Setup

Use MENU, SELECT, and ADJ Left/Right to choose the Closed Captions/Text mode and to set up the other menu options for the user with the optional Installer's remote.

Quick/Mute When CC is pressed: User can only turn Captions on/off. (If CC on Mute is on, shows captions option on mute.) (If locked, type is retained with Power on/off.)

Standard When CC is pressed: User can choose a captions type. (If locked, type is retained with Power on/off.)

Press ENTER repeatedly to remove menus.

 **Standard closed captioning is available using the Caption 1 option.**

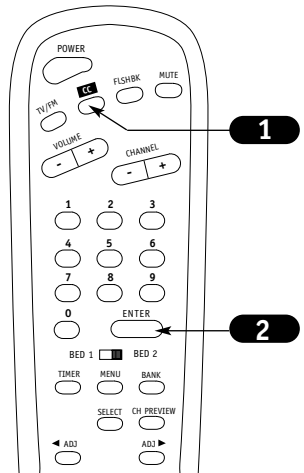

Caption/Text are features which allow the Concierge TV to receive the closed caption and/or text options if made available by the broadcaster.

Availability and functionality of Caption/Text options are determined only by each broadcaster and may not be available in your area

Mini Glossary

CAPTIONS The term for the words that scroll across the bottom of your TV screen; usually the audio portion of the program provided for the hearing impaired.

TEXT The term for the words that appear in a large black frame and almost cover the entire screen; usually messages provided by the broadcaster.

Language

Choose the language for the on-screen menus.

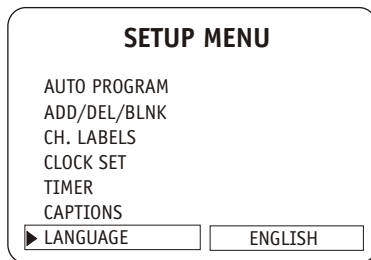

- 1** Press the MENU key on the optional Installer's remote control so the Setup menu appears.
- 2** Use the SELECT key on the remote control, to highlight Language on the screen.
- 3** Press the Right/Left ADJ arrow to choose one of the following options: English, Spanish or French.
- 4** Press ENTER to return to TV viewing.

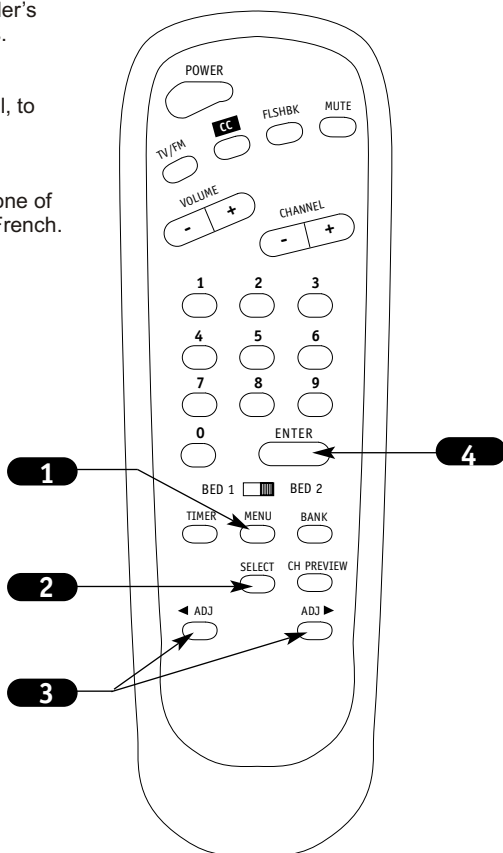

Video Menu

Use the Video menu to customize the picture appearance.

1 Press the MENU key repeatedly until the Video menu appears, on the optional Installer remote.

- **Contrast:** Adjusts the level of difference between white and black in the TV picture. The more contrast, the brighter the picture appears.

- **Brightness:** Increases or decreases amount of white in the TV picture.

- **Color:** Adjusts levels of all colors in the TV picture.

- **Tint:** Balances between amounts of red and green in the TV picture.

- **Sharpness:** Raises or lowers the definition of the TV picture. The lower the level, the softer the images will appear.

- **Picture Preference:** Choose either Custom or Preset. Custom allows you to set the picture the way you want. Preset moves all the above options back to their original, factory-set levels.

2 Using SELECT on the installer's remote control, choose Contrast on the screen.

3 Using the Right/Left ADJ arrow, change the contrast level to your preference.

4 Press ENTER, or MENU one more time to return to TV viewing, or repeat from step two to set the other menu options.

Picture Preference

A Use SELECT to choose Picture Preference on the screen.

B Use the Right/Left ADJ arrow, to choose either the original settings with Preset, or your own settings with Custom.



Choose the Preset option in Picture Preference to quickly reset the levels to their original values.

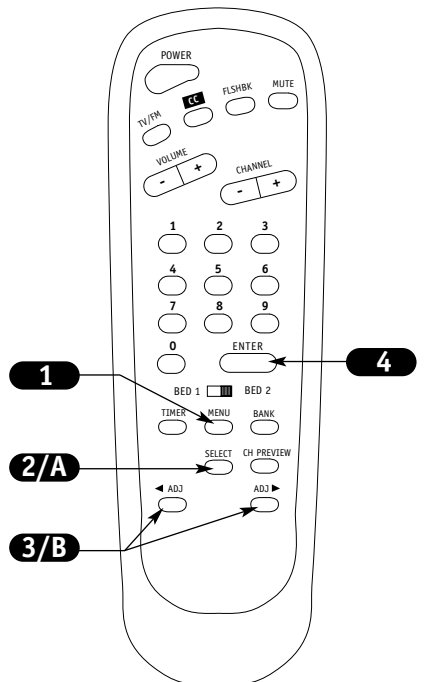
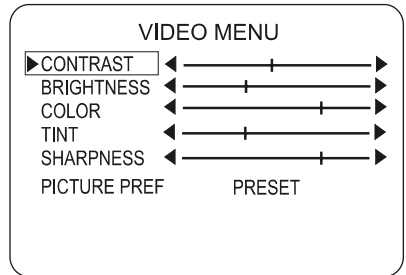

FM Radio Menu

Use the FM Menu to customize FM Radio options.

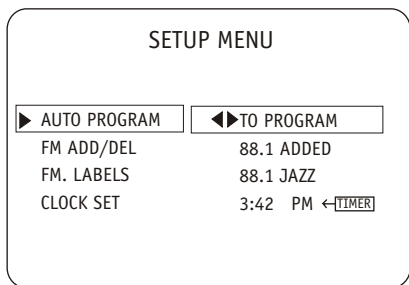

1 Press TV/FM and choose the FM Radio operating mode, on the optional Installer's remote.

2 Press the MENU key repeatedly until the FM Setup Menu appears. Your options are:

- **Auto Program:** In FM Mode, finds the available FM stations and puts them on the MUSIC ID list. You can select a station from this list with CHANNEL Up/Down.

- **FM ADD/DEL:** ADD or DEL (delete) a station in the MUSIC ID list. Stations on this list can be selected with CHANNEL Up/Down. Press ADJ (adjust) Left/Right to select ADD or DEL. Select the applicable station with CHANNEL Up/Down or Numbers, then press ENTER if you used Numbers. ADD Adds station to the MUSIC ID List. DEL deletes station from the MUSIC ID list

- **FM Labels:** Lets you label the stations on the MUSIC ID list. Labels include: Classical, Country, Jazz, News, Oldies, Religious, Rock, Sports, Talk, and Other.

- **Clock Set:** Set the clock in this menu the same way as described on page 17. For manual clock set, use the number keypad. Use TIMER to change AM/PM, followed by ENTER to clear the screen.

3 Use SELECT to choose which option you wish to set Up.

4 Use ADJ Left/Right to set those options.

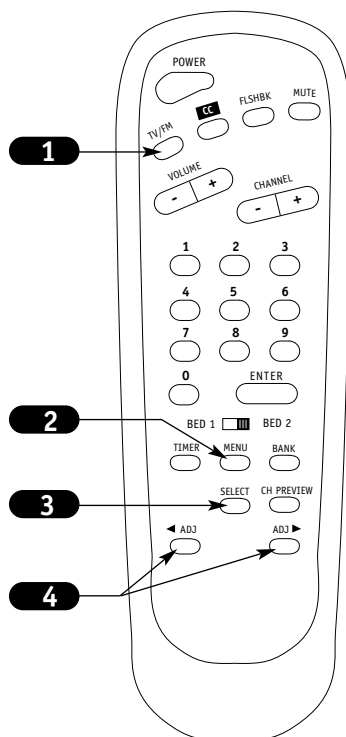

Radio Menu Options

Descriptions of the FM Radio Installer's menus.

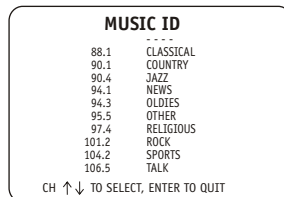
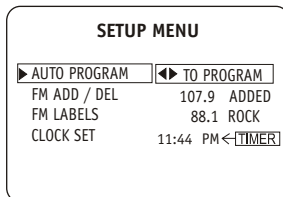
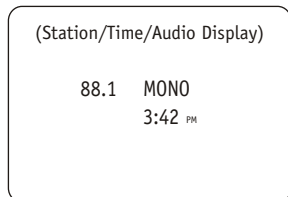

In FM mode using the Menu button on the optional Installer's remote, the installer can access the menus shown above.

Press ENTER to show the FM Radio Station/Time/Audio Signal on-screen display.

Menu Name	Description
FM SETUP MENU OPTIONS	
FM Setup Menu	Adjusts the basic features of the FM radio
Auto Program	Automatically finds and stores all active FM radio stations within the range of 87.7 - 107.9. The user can then choose any FM radio station stored in memory using Channel Up/Down, in FM radio mode.
FM Add / Del	Use to edit the list of active FM stations found with auto program. All stations found are automatically included into memory, however, for one reason or another, you may want to delete or add some FM stations. Note: To add a deleted channel, run FM auto program again.
FM Labels	Assign a label for the type of radio station. Highlight FM Labels. Use CH Up/Down to choose a station, then use the Left/Right arrow to select a classification like ROCK. For example, if the label ROCK is assigned to FM station 88.1, then "ROCK" will appear in the active stations list next to 88.1, whenever the Music ID display is shown. Other labels available (besides Blank - - -) include: CLASSICAL OTHER COUNTRY RELIGIOUS JAZZ ROCK NEWS SPORTS OLDIES TALK
Clock Set	Sets the FM radio's clock memory to the correct time. Set the clock in this menu the same way as described on page 17. To manually set the clock, highlight the Clock Set option, then use the numbers on the remote to enter the current time directly. Press TIMER to choose AM or PM, then press ENTER to remove the menu. Note: You can also enter the time directly using the 24-hour time system. For example, to set 2:30 p.m., key in 1430 then press ENTER and AM/PM will be set for you. Use this method if you use the LT2000 remote which does not have a TIMER key.
STATION/TIME	Shows currently selected FM radio station, current time (if set), and incoming audio signal.
MUSIC ID	Shows available FM radio stations in memory. Press ENTER to show ID.

Installer Parental Control Menu

If used, this optional feature can “block” undesirable programming from appearing on the TV.

Parental Control offers the user a wide variety of options and settings that restrict or “block” the programming that can appear on the TV. Parental control allows the user the capability of defining which program rating they consider acceptable, to the younger or more sensitive viewer. The AUX input can also be blocked. It can be preset and turned either on or off by the user who specifies a secret 4-number code, the password. The number of hours blocked are specified. General audience and children viewer blocks can both be programmed into the TV’s memory. Viewer ratings are specified for both TV and the motion picture industry; both rating systems can be used. The ratings are based mainly on the ages of children

Overview

To insure complete coverage for all TV programs, (movies and regular TV shows) choose a rating for MPAA, from the selections below AND choose ratings from the TV Parental Guidelines Rating System on the next page, using the Age Block option for General Audiences, and for Children. In addition to those, you may wish to add additional restrictions from the Content Block menu. See the Parental Control menu, and submenus example on the next page.

Things To Consider Before Setting Up Parental Control

Determine which rating you consider acceptable to the viewer. (For example, if you choose TV-PG, all more restrictive ratings will be automatically blocked; the viewer will not be able to see: TV-PG, TV-14, or TV-MA rated programming.)

Block program “Content” based on individual parameters such as: Strong Dialog, Mature Language, Sex Scenes, Violence Scenes, or Fantasy Violence Scenes; in the Content Blk option.

How many hours do you want Parental Control to be active? You can set the Hours option for up to 12 hours.

Select a secret password; in the Set Password option. Use the number keys on the remote. Don’t forget the password, it is the only way you can access the Parental Control menu and change rating selections, or turn Parental Control off.

Do you want Parental Control to be active all the time? If not, you can turn it on or off; with the Lock On/Off option.



You can set different Parental Control viewing restrictions for general audiences and for children - - both can be active at the same time.



You cannot disable Parental Control by disconnecting the TV from power. Block hours remaining will be retained if power is lost or power cord is disconnected.



Simply specifying one content block such as Sex Scenes, will not automatically block another content in the programs from appearing.



The AUX input source can also be blocked.

Note

Reset Parental Control Block Hours to Zero and Cancel Password

This provides the institution staff and the installer a means to reset the TV to normal operation, if a patient has either forgotten the password or has left Parental Control Block active after departing. On the installer’s remote control, press and hold down MENU until the menu disappears (about 6 seconds). Immediately press 9, 8, 7, 6 and then CC.

This will reset the Block Hours to Zero and cancel the current 4-number password.

Installer Parental Control Menu

After you have read the preceding page, follow instructions below to set up and activate Parental Control.

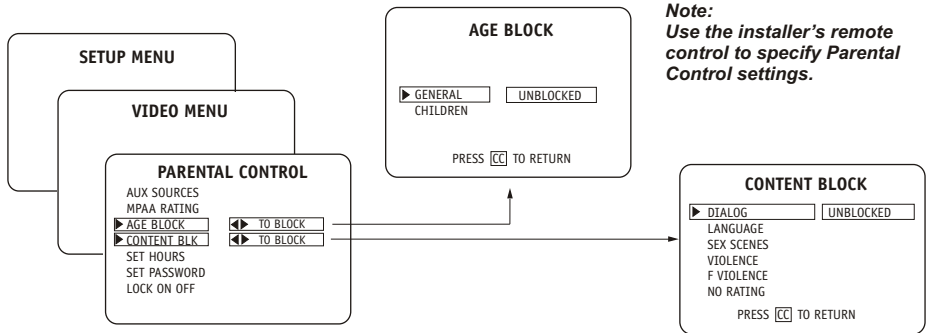

Note:
Use the installer's remote control to specify Parental Control settings.

- 1** Press MENU repeatedly until the Parental Control Menu appears using the optional Installer's remote.
- 2** With the Parental Control menu on-screen, use the SELECT button to access the MPAA Rating menu and customize the level of restriction.
- 3** Use the Left/Right ADJ arrow to adjust or set the rating for an option, for example, use the "PG" setting. (See the Mini Glossary, Ratings Charts on pages 38 and 39 for rating descriptions.)
- 4** After you have selected and adjusted the parental control menu options to your preferences:
 - Set the number of hours Parental Control will be on.
 - Set a 4-number password.
 - Set the Lock On/Off option to either on or off.

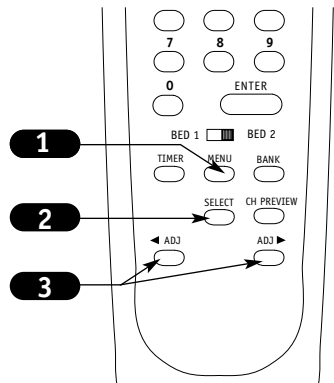

Note: Some broadcasts do not include rating information.

Make Parental Control restrictions permanent, with no preset or fixed hours time limit

In the Installer's Menu, Item 84: PERMANENT BLK, 0 or 1.

0	Blocking restrictions always active, no time limit.
1	Restrictions limited to specified hours, 12 - 99.

Reset the Maximum Number of Parental Control Default Block Hours

You can change the Block hours from the 12-hour default setting to up to 99 hours. In the Installer's Menu, item: 22-I MAX BLK HRS 12, use the ADJ Left/Right adjust arrow to set a different default number of hours.

To Turn the Parental Control Feature Off/On

In the Installer's Menu, Items: 21-I V-CHIP, 0 or 1, 51-I DIS. VCHIP M., 0 or 1

Options Setups for V-CHIP Menu and Block Functions

21-I V-CHIP	51-I DIS. VCHIP M.	
0	0	No menu, no blocking.
0	1	No menu, no blocking.
1	0	Shows menu, Block functions.
1	1	No menu, Block functions.

Other Menus & On-Screen Displays

Use the keys indicated below to access these menus and displays, on the optional remote.

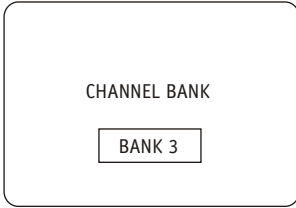

Channel Banks Menu

Press BANK. Gives access to the Channel Banks menus: Bank 1, Bank 2, Bank 3, Bank 4.



Closed Captions Menu

Press CC. Turns selected option on or off. See Caption/Text page to select options.



Sleep Timer Menu

Press TIMER. Selects a preset TV turn-off time, and shows remaining time before the TV turns off.

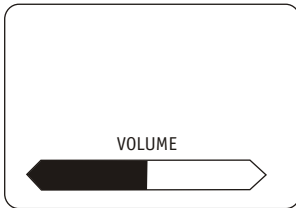

Volume Display

Press VOLUME. Shows currently selected sound setting.

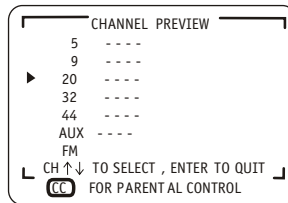

Ch Preview Menu

Press CH PREV. Displays list of the available TV Channels, AUX source, and patient Parental Control menu.

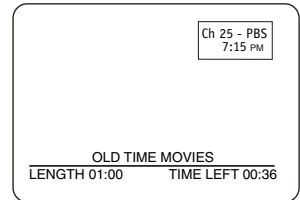

Channel/Time/XDS Display

Press ENTER. Shows currently selected channel, current time if the clock has been set, and XDS data, if being broadcast; title of program, length of program, and time remaining.



Inactive TV Display

Prompts patient to arrange for TV service to room.

Managing the Channel Banks

Using the optional Installer's remote control, the TV has four channel banks, where the administrator or installer can store groups of TV channels.

PLANNING THE CHANNEL BANKS

Generally, TV channels are grouped into "program packages" with terms that are proposed to the end user. The user then opts for a package. Below is an example of how TV channels may be grouped.

You may plan your package by using a chart like the one after the following page.

Remember, you can "blank" a channel for accommodating audio-only, such as an FM radio station or in-house communication.

Sometimes, only one or two channel banks may be needed. You may leave any unused bank with the channels entered during Auto Program; or, you may delete the channels. However, you may want to leave at least one channel in any unused bank. Then, if someone selects an "unused" bank, that channel will assure them that the TV is functional.

Note: Some channels from factory testing may be in the channel banks if you have not yet run Auto Program.

Channel Bank	Program package
1	Basic cable channels
2	Extended cable channels
3	Extended with premium channels
4	Other cable installer options

(Grouping is provided as an example only.)



The BLNK (blank) channel function is "global" -- the same channel number is blanked in channel banks 1, 2, 3, and 4.

ADDING / DELETING CHANNELS

A previously prepared programming chart is helpful.

1. Run Auto Program (in the Setup menu). All channels found on your cable/antenna will be entered in Channel Banks 1, 2, 3, and 4.

Note: Be advised that running Auto Program overwrites any custom channel setups; removes Blanked, Deleted.

2. Select a channel bank with an installer remote -press SOURCE/BANK (and repeat). CHANNEL BANK and BANK number will be displayed.

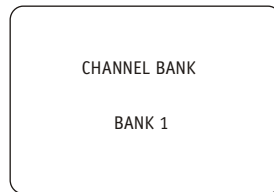

Channel bank number display

3. Use the ADD/DEL/BLNK item (also in the Setup menu) to customize your program package. You may delete channels or add some that have not been entered. You can also "Blank" a channel for accommodating an audio-only program source or in-house communication. The "ADD/DEL/BLNK" item on page 15 has more details.

Note: The Blank Channel feature is global. A channel will be blanked in all channel banks.

4. Repeat steps 2, and 3 to program another channel bank.

Inactive TV Display (Channel Bank 4)

The TV can be set up to be inactive; which would require an attendant using an installer remote to change to a "billable" active channel bank selection: Bank 1, 2, or 3.

Note: For institution control of patient-accessible programming, channels in Bank 4 need to be removed.



Managing the Channel Banks

Examples of typical channel banks chart.

Figure 1. Typical channel banks after running Auto Program

BANK	Purpose	Channel Number																								
		1	2	3	4	5	6	7	8	9	10	11	12	13	14	15	16	17	18	19	20	21	22	23	24	25
1			A			A		A		A					A	A	A	A	A	A	A		A	A	A	A
2			A			A		A		A					A	A	A	A	A	A	A		A	A	A	A
3			A			A		A		A					A	A	A	A	A	A	A		A	A	A	A
4			A			A		A		A					A	A	A	A	A	A	A		A	A	A	A

A= Active - - Channel was found during AUTO PROGRAM.

Figure 2. Typical channel banks after running Auto Program, and customizing with Add/Dell/Blnk

BANK	Purpose	Channel Number																								
		1	2	3	4	5	6	7	8	9	10	11	12	13	14	15	16	17	18	19	20	21	22	23	24	25
1	Basic	BC	A			A		A		A				D	D	D	D	D	D	D	D		D	D	D	D
2	Extend	BC	A			A		A		A				A	D	A	A	D	A	A	A		D	D	D	D
3	All CTV	BC	A			A		A		A				A	D	A	A	D	A	A	A		A	D	A	A
4	Other	BC	A			A		A		A				A	A	A	A	A	A	A	A		A	A	A	A

A = Active Channel was found during AUTO PROGRAM
 D = Deleted Channel was deleted using Add/ Del option.
 BC = Blanked Channel Channel was blanked using BLANK channel option (ADD/DEL/BLNK).

ADDING / DELETING CHANNELS

It is best to do ADD / DEL customizing before doing "BLNK."

AUTO PROGRAM enters the same channels in Banks 1, 2, 3, and 4.

AUTO PROGRAM removes any channels previously customized with ADD / DEL / BLNK. The channels available on your antenna / cable will be entered, and any channels previously entered but not currently available will be deleted.

ADD and DEL (not BLNK) can be used independently for channel banks 1, 2, 3, and 4.

A channel blanked, is blanked in all channel banks.

Channel allocations in tuning bands:

BROADCAST: 2 – 69
 CABLE – CATV, HRC or ICC: 1 – 125

Managing the Channel Banks

PLAN YOUR CHANNEL BANKS BY FILLING IN THESE CHARTS (or use photocopies)

B A N K	Purpose	Channel Number																								
		1	2	3	4	5	6	7	8	9	10	11	12	13	14	15	16	17	18	19	20	21	22	23	24	25
1																										
2																										
3																										
4																										

B A N K	Purpose	Channel Number																													
		26	27	28	29	30	31	32	33	34	35	36	37	38	39	40	41	42	43	44	45	46	47	48	49	50					
1																															
2																															
3																															
4																															

B A N K	Purpose	Channel Number																													
		51	52	53	54	55	56	57	58	59	60	61	62	63	64	65	66	67	68	69	70	71	72	73	74	75					
1																															
2																															
3																															
4																															

B A N K	Purpose	Channel Number																													
		76	77	78	79	80	81	82	83	84	85	86	87	88	89	90	91	92	93	94	95	96	97	98	99	100					
1																															
2																															
3																															
4																															

B A N K	Purpose	Channel Number																									
		101	102	103	104	105	106	107	108	109	110	111	112	113	114	115	116	117	118	119	120	121	122	123	124	125	FM
1																											
2																											
3																											
4																											

Installer Menus

Use the Installer's Menus to make TV operation adjustments.

Accessing the Installer's Menu

Installer's menus can be accessed by using the optional installer's remote control. Just press and hold MENU (about 8 seconds) until the display changes, then press 9, 8, 7, 6, then ENTER. To exit the Installer's Menu, press ENTER again. Changes you make will be stored in nonvolatile memory.

The Installer's Menu opens with item 00-I, INST. SEQ. Use the SELECT key to sequence through the available menu items. Or, access an item directly by entering the line number, then pressing MENU. For example, to access the Start Channel option which is on line 11, press 11, then MENU. To change a current setting use the Left/Right ADJ keys.

Using the Installer's Menu

Items 00-90 are immediately accessible only upon entering the Installer's Menu. Their numbers, descriptions, ranges, factory default settings, and a place for listing any changes made on-site are given below. A second section of the Installer's Menu that is intended for qualified service technicians only is not shown (XX-F Items). Normally these items do not require adjustment.



XX-F Menu Items (Not shown here) are service-type adjustments and only qualified technicians having specialized test equipment should access them.

Items in the Installer's Menu: 0-I to 25-I

Menu Item	Function	Value Range	Default Value	Brief Description of Function and Comments
0-I.	INSTALLER. SEQ	0 - 3	0	Changes installer Entry Sequence. Leave default set 0 (9876), 1 (4321), 2 (1478), 3 (3698)
1-I.	POWER MANAGE	0 - 7	0	Sets number of hours of no activity before auto shutoff.
2-I.	AC ON	0 / 1	0	Set to 1 to enable auto turn on at power up.
3-I.	BAND/AFC	0 - 7	0	Tuning band, see detailed descriptions.
4-I.	STRT CHANNEL	0 - 255	255	Channel at turn-on (255 last Ch).
5-I.	CHAN LOCK	0 / 1	0	When set to 1, cannot tune from current channel.
6-I.	GHOST CH	0 / 1	0	Set to 1 to enable Ghost Channel display.
7-I.	START VOLUME	0 - 63, 255	255	Volume level at TV turn-on (Set 255 to retain last volume level).
8-I.	MIN VOLUME	0 - 63	0	Minimum volume setting.
9-I.	MAX VOLUME	0 - 63	63	Maximum volume setting.
10-I.	MUTE DISABLE	0 / 1	0	Set to 1 to disable mute function.
11-I.	KEY DEFEAT	0 / 1	1	Set to 1 to disable Menu, Select, and Adj keys on front panel.
12-I.	IR BANKS EN.	0 / 1	0	Set to 1: enables TV to respond to IR codes to change Channel Bank directly.
13-I.	SCAN MODE	0 - 3	1	Typically used for Hospitals: puts On-Off and FM in Ch Up/Down sequen ce.
14-I.	STRT CH IN SM	0 / 1	0	Set to 1 to put TV on/off before start channel number.
15-I.	SLEEP TIMER	0 / 1	1	Set to 1 to enable Sleep Timer.
16-I.	EN. TIMER	0 / 1	1	Set to 1 to enable Timer.
17-I.	ALARM	0 / 1	1	Set to 1 to enable Alarm.
18-I.	RADIO	0 / 1	1	Set to 1 for TVs with Radio.
19-I.	NOT USED			
20-I.	FEATURE LEVEL	0 / 1	1 Zen 1	Leave default set 1 (1 Zen 1)
21-I.	V-CHIP	0 / 1	1	Set to 1 to enable V-Chip
22-I.	MAX BLK HRS	0 - 99	12	Select number of Parental Control blocking hours.
23-I.	CAPTION LOCK	0 / 1	0	Set to 1 to retain caption setting at turn off.
24-I.	TEXT MODE	0 / 1	1	Set to 1 to add Text option to closed caption menu.
25-I.	FUNCTION PRE.0	0 - 3	0	Controls channel preview in Pay-Per-View function menu.

Installer Menus

Installer Menu Item 26-I through 63-I.

Menu Item	Function	Value Range	Default Value	Brief Description of Function and Comments
26-I.	6 KEY SYS	0 / 1	0	Leave default set to 0.
27-I.	HOSPITAL MODE	0 / 1	2	Leave default set to 2.
28-I.	CH. OVER RIDE	0 / 1	1	When set to 0, limits direct access to favorite channels.
29-I.	OLD OCV	0 / 1	0	OCV should set to 1.
30-I.	ACK MASK	0 / 1	0	M.P.I. communication parameter.
31-I.	POLL RATE	20 - 169	94	M.P.I. communication parameter.
32-I.	TIMING PULSE	186 - 227	207	M.P.I. communication parameter.
33-I.	NOT USED			
34-I.	NOT USED			
35-I.	NOT USED			
36-I.	NOT USED			
37-I.	NOT USED			
38-I.	NOT USED			
39-I.	REAR VIDEO EN	0 / 1	1	Set to 1 to enable rear AUX video input.
40-I.	NOT USED			
41-I.	NOT USED			
42-I.	NOT USED			
43-I.	NOT USED			
44-I.	NOT USED			
45-I.	NOT USED			
46-I.	NOT USED			
47-I.	NOT USED			
48-I.	DIS. SETUP M.	0 / 1	0	Set to 1 to disable Setup menu.
49-I.	NOT USED			
50-I.	DIS. VIDEO M.	0 / 1	0	Set to 1 to disable Video menu.
51-I.	DIS. VCHIP M.	0 / 1	0	Set to 1 to disable V-Chip (Parental Control) menu.
52-I.	NOT USED			
53-I.	DIS. CH-TIME M.	0 / 1	0	Set to 1 to disable Channel-Time display.
54-I.	EN. SET. COL.	0 / 1	0	Set to 1 to enable custom color for Setup menu.
55-I.	FOR. SETUP M.	0 - 7	6	Custom foreground color for the Setup menu.
56-I.	BCK. SETUP M.	0 - 7	4	Custom background color for the Setup menu.
57-I.	NOT USED			
58-I.	NOT USED			
59-I.	NOT USED			
60-I.	EN. VIDEO COL.	0 / 1	0	Set to 1 to enable custom color for the Video menu.
61-I.	FOR. VIDEO M.	0 - 7	4	Custom foreground color for the Video menu.
62-I.	BCK VIDEO M.	0 - 7	7	Custom background color for the Video menu.
63-I.	EN. PTL. COL.	0 / 1	0	Set to 1 to enable custom color for the V-Chip (Parental Control) menu.

Installer Menus

Installer Menu Items 64-I through 90-I

Menu Item	Function	Value Range	Default Value	Brief Description of Function and Comments
64-I.	FOR. PTL. M.	0 - 7	6	Custom foreground color for the V-Chip (Parental Control) menu.
65-I.	BCK. PTL. M.	0 - 7	4	Custom background color for the V-Chip (Parental Control) menu.
66-I.	NOT USED			
67-I.	NOT USED			
68-I.	NOT USED			
69-I.	EN. CH-T COL.	0 / 1	1	Set to 1 to enable custom color for the Channel-Time display.
70-I.	FOR. CH-T COL.	0 - 7	1	Custom foreground color for the Channel-Time display.
71-I.	BCK. CH-T COL.	0 - 7	1	Custom background color for the Channel-Time display.
72-I.	NOT USED			
73-I.	CH NOT AVBLE	0 / 1	0	When set to 1 and channel override is 0, 0NOT AVAILABLE0 message is displayed when direct accessing a channel not in the favorite channel list.
74-I.	CH-TIME SIZE	0 / 1	0	When set to 1 and transparent background is selected for Channel-Time display, (foreground color = background color and custom color enabled) a large channel number is displayed instead of the normal Channel-Time display.
75-I.	NOT USED			
76-I.	DEFEAT XDS	0 / 1	0	When set to 1, XDS display program information will not appear.
77-I.	QUICK SHUTOFF	0 - 17	0	Allows TV timed power off press and hold setup with pillow speaker channel button.
78-I.	UPN MSB	0 - 255	255	User programmable number, most significant byte.
79-I.	UPN MSB-1	0 - 255	255	User programmable number, most significant byte - 1.
80-I.	UPN MSB-2	0 - 255	255	User programmable number, most significant byte - 2.
81-I.	UPN LSB	0 - 255	255	User programmable number, least significant byte.
82-I.	CHKSM ERROR	0 / 1	0	Enforces rigid M.P.I. checksum
83-I.	HANDSHK TIME	0 - 5	0	Relaxes M.P.I. timing to be compatible with PC based Win dows controlled systems.
84-I.	PERMANENT BLK	0 / 1	0	Remove block hours setting for Parental Control and make blocks permanent.
85-I.	NOT USED	0 / 1	0	
86-I.	NOT USED	0 / 1	0	
87-I.	NOT USED	0 / 1	0	
88-I.	EN NOISE MUTE	0 / 1	1	Enables soft mute when signal is not present.
89-I.	POKE ENABLE	0 / 1	0	Enables poke function thru M.P.I. Commands.
90-I.	KEY LOCK	0 / 1	0	Disables front panel key.

Detailed Descriptions of Installer Menu Items

0-I. INSTALLER SEQUENCE

Gives access to Installer Menu depending on the code selected.

0 = 9876 1 = 4321
2 = 1478 3 = 3698

1-I. POWER MANAGE (Power Management)

Determines hours of no activity before automatic shutoff. The POWER MANAGE function is for saving energy. When set to 0, Power Manage is OFF. Settings range from 0 - 7, with 1 - 7 representing the hours that the TV will remain on, unless there has been activity from either the control panel or remote control.

2-I. AC ON (AC Power Switchable)

Allows the TV to turn ON just by applying AC power. Pressing the ON button is not necessary. This is desirable when the TV is plugged into a cable box or a power outlet controlled by a wall

switch. Use ADJUST to select 0 or 1, where 0 is the default is OFF, and 1 is ON.

NOTE: When set to 1 (ON), the TV does not respond to ON/OFF commands from either the remote or the control panel, and the SLEEP TIMER is also nonfunctional.

3-I. BAND/AFC (Band/Automatic Frequency Control)

There are 8 possible settings for this option:

0 = Broadcast Fixed 4 = Broadcast AFC
5 = CATV Fixed 1 = CATV AFC
6 = HRC Fixed 2 = HRC AFC
7 = ICC Fixed 3 = ICC AFC

Channels are accessed faster when fixed modes are used. The AFC (search modes) should only be used when some channels are not on nominal frequencies.

NOTE: BAND is automatically set by AUTO PROGRAM.

Installer Menus

Installer Menu Item 4-I through 13-I: Detailed Descriptions.

If some channels were not found by AUTO PROGRAM, select the appropriate AFC setting here and add the channels using the ADD/DEL option in the Setup Menu.

4-I. STRT CHANNEL (Start Channel)

When active, this function allows you to determine the initial channel number when the TV is turned ON. This feature is useful for an in-house information channel, since the TV would always select that channel when it is turned on. Setting this to 255 causes the last channel viewed when TV was turned off to be the tuned to channel when the TV is turned on again. The range of values is 0 - 255. Use (adjust) keys to choose numbers that determine the start channel.

5-I. CHAN LOCK (Channel Lock)

CHAN LOCK is ideal if a cable box (or similar) is the sole source for programming—and the TV must always be on the same channel. Changing channels with Channel Up/Down or keypad numbers is impossible. Channel Lock is inactive when set to 0 (default).

Generally, this feature is used in conjunction with START CHANNEL (line 4-I.) where the start channel may, for example, be set to 3 or 4. If the start channel is 3 then the TV will remain on channel 3.

NOTE: When CHANNEL LOCK is active and CHANNEL OVERRIDE is disabled, AUTO PROGRAM is not active.

6-I. GHOST CH (Ghost Channel)

When set to 1, the current channel number is displayed in the upper right corner of the display. The number moves slightly to prevent damage to the screen. The default is "0" or OFF.

NOTE: When captions are on, the "ghost channel" is not displayed.

7-I. START VOLUME

This function allows the Installer to determine the initial volume level setting when the TV is turned ON. This feature is useful for an in-house information channel, since the TV would always select that volume level when it is turned on. The range of values are 0- 63, 255. If 255 is selected, the current volume level will be retained in memory when the TV is turned off; at TV turn on, volume level is automatically set to the previous or last level.

8-I. MIN VOLUME (Minimum Volume)

This function determines the minimum volume level allowable with the VOLUME (VOL) Up/Down control. In this way, for example, someone cannot set the volume too low to hear. The range is from 0 to 63—change values with ADJUST. The factory default is 0, which provides full range of volume control. It may be best to set the same value on every TV.

NOTE: The minimum volume level cannot have a value setting higher than in the MAX VOLUME level (described below).

9-I. MAX VOLUME (Maximum Volume)

This function determines the maximum volume level allowable with the VOLUME VOL Up/Down control. In this way, for example, someone cannot set the volume level high enough to disturb others.

The range is 0 to 63, with 63 as the default which gives the user the full range of volume control. Change values with ADJUST keys. It may be best to set the same value on every TV.

NOTE: The maximum volume level cannot have a value setting lower than the MIN VOLUME level (described previously).

10-I. MUTE DISABLE

Enables or disables sound mute function. When set to 1, sound cannot be muted. When set to 0, sound can be muted.

11 KEY DEFEAT (Keyboard Defeat)

When set to 1, it prevents the end user from accessing screen menus on the front panel—MENU, SELECT, and ADJUST do not function. When set to 0, those keys are functional. The menus can always be accessed with MENU on the remote.

12-I. IR BANKS EN.

For direct access to a particular Channel Bank. When enabled, installer can access a channel bank by inputting the IR code for the bank.

13-I. SCAN MODE

Allows variation in setting the On/Off with Channel UP/DOWN.

You may opt for TV channels only; TV channels + Off/ON; TV channels + FM radio; TV channels + FM radio + Off/On with these settings for Scan Mode:

Installer Menus

Installer Menu Items 14-I through 27-I: Detailed Descriptions.

Scan mode Characteristics

- 0 Channel up/down keys change channels only.
- 1 Channel down below the lowest channel (or channel up higher than the highest) and TV turns off.
- 2 Channel down below the lowest channel (or up higher than the highest) and TV goes to FM radio. Channel down below lowest FM station (or Channel up higher than the highest) and TV channels return.
- 3 Channel down below the lowest channel (or up higher than the highest) and TV goes to FM radio. Press channel down below lowest FM station (or Channel up higher than the highest) and TV turns off.

14-I. STRT CH IN SM

When set to 1, installs TV on/off event below the start channel at TV turn on.

15-I. SLEEP TIMER

When set to 1, the SLEEP TIMER feature may be used (but no message is displayed prior to turn-off). When set to 0, the sleep timer is not available.

16-I. EN. TIMER

Set to 1, timer function is available to user. Set to 0 to disable timer functions. (Clock must be set in order to use Timers.)

17-I. ALARM

Gives you the option of making the alarm function available to the user. Set to 1, alarm function is available to user. Set to 0 to disable the Alarm function.

Note: Clock must be set in order to set the Alarm.

18-I. RADIO

Set to 1, for TVs with a Radio. Set to 0 to disable the Radio function, for TVs without a Radio.

19-I. NOT USED

20-I. FEATURE LEVEL

Default set to ZEN 1 for Zenith IR remote control operation. Set 0, P LBL for Zenith Private Label IR remote control operation.

Warning: Do not set to "0" or remote will not control TV.



**Installer should leave item 20
FEATURE LEVEL set to 1 (default).**

21-I. V-CHIP

Set to 1 to activate V-Chip (Parental Control); have it available to user to filter, control, or restrict programming content. Set to 0 to turn V-Chip feature off, not available to user; no programming restrictions can be set.

22-I. MAX BLK HRS

Set to 0 to 99 for the maximum V-Chip (Parental Control) block hours. Default is 12 blocking hours.

23-I. CAPTION LOCK

Set to 1 to restore previous caption On/Off state after TV turns off. When set to 0, captions are always off, when TV is initially turned on.

24-I. TEXT MODE

Determines whether TEXT 1, TEXT 2, TEXT 3, or TEXT 4 decoding is enabled when TEXT is turned on (either from the Setup Menu or directly with CC on the remote). TIP: Set Text Mode to 1 only if text is offered in your video System.

25-I. FUNCTION PRE.

Set to 0 to suppress CHANNEL PREVIEW from the FUNCTION menu with some Pay-Per-View systems.

26-I. 6 KEY SYS

Set to 1 for 6-key front control panels. Set to 0 for 10-key front control panels. Leave default set to 1.

27-I. HOSPITAL MODE

The default is 2 (which favors most hospitals). With this setting two things are affected: Channel Banks 1, 2, and 3 are accessible, while Bank 4 is inactive.

Hosp. Mode=0 Not hospital mode. IR code depends on Item 20-I.

"Inactive TV" features not available.

Hosp. Mode= 1 Zenith P.L. IR Code (Bed 1)

Hosp. Mode= 2 Zenith IR Code (Bed 2)

Installer Menus

Installer Menu Item 28-I through 59-I: Detailed Descriptions.

28-I. CH. OVERRIDE (Channel Override)

When set to 1, the user can select channels with either Channel Up/Down or by direct keypad entry. When set to 0, only those channels that are entered for scanning may be selected by direct keypad entry. Note: If set to 0, Auto Program is locked; (as shown on Setup menu) channel search is not possible.

29-I. OLD OCV (On Command Video™)

Set to 1 for operation with systems from On Command Corporation.

30-I. ACK MASK

M.P.I. Communication Parameter. Leave at default setting unless changed by Pay-Per-View provider.

31-I. POLL RATE

M.P.I. Communication Parameter. Leave at default setting unless changed by Pay-Per-View provider

32-I. TIMING PULSE

M.P.I. Communication Parameter. Leave at default setting unless changed by Pay-Per-View provider.

33-I. NOT USED

34-I. NOT USED

35-I. NOT USED

36-I. NOT USED

37-I. NOT USED

38-I. NOT USED

39-I. REAR VIDEO EN.

Set to 1 to enable rear AUX (Video) input.
Set to 0 to disable rear AUX input.

40-I. NOT USED

41-I. NOT USED

42-I. NOT USED

43-I. NOT USED

44-I. NOT USED

45-I. NOT USED

46-I. NOT USED

47-I. NOT USED

48-I. DIS. SETUP M.

Set to 1 to disable the Setup menu. Setup menu will not appear. Set to 0 to enable the Setup menu

49-I. NOT USED

50-I. DIS. VIDEO M.

Set to 1 to disable the Video menu. Video menu will not appear. Set to 0 to enable the Video menu.

51 DIS. VCHIP M.

Set to 1 to disable the Parental Control menu. Parental Control menu will not appear. Set to 0 to enable the Parental Control menu.

52-I. NOT USED

53-I. DIS. CH-TIME.

Set to 1 to disable the Channel-Time display. Channel-Time display will not appear. Set to 0 to enable the Channel-Time display.

54-I. EN. SET. COL.

Set to 1 to enable custom color settings for the Setup menu. Set to 0 to disable custom color settings for the Setup menu.

55-I. FOR. SETUP M. (Setup Menu Foreground Color)

Set according to Color Chart.

0 = Black	3 = Yellow	6 = Cyan
1 = Red	4 = Blue	7 = White
2 = Green	5 = Violet	

56-I. BCK. SETUP M. (Setup Menu Background Color)

Set according to Color Chart.

0 = Black	3 = Yellow	6 = Cyan
1 = Red	4 = Blue	7 = White
2 = Green	5 = Violet	

57-I. NOT USED

58-I. NOT USED

59-I. NOT USED

Installer Menus

Installer Menu Items 60-I through 78-I: Detailed Descriptions.

60-I. EN. VIDEO. COL.

Set to 1 to enable custom color settings for the Video menu. Set to 0 to disable custom color settings for the Video menu.

61-I. FOR. VIDEO M. (Video Menu Foreground Color)

Set according to Color Chart.

0 = Black	3 = Yellow	6 = Cyan
1 = Red	4 = Blue	7 = White
2 = Green	5 = Violet	

62-I. BCK. VIDEO. COL. (Video Menu Background Color)

Set according to Color Chart.

0 = Black	3 = Yellow	6 = Cyan
1 = Red	4 = Blue	7 = White
2 = Green	5 = Violet	

63-I. EN. PTL. COL.

Set to 1 to enable custom color settings for the V-Chip menu. Set to 0 to disable custom color settings for the V-Chip menu.

64-I. FOR. PTL. M. (V-Chip Menu Foreground Color)

Set according to Color Chart.

0 = Black	3 = Yellow	6 = Cyan
1 = Red	4 = Blue	7 = White
2 = Green	5 = Violet	

65-I. BCK. PTL. M. (V-Chip Menu Background Color)

Set according to Color Chart.

0 = Black	3 = Yellow	6 = Cyan
1 = Red	4 = Blue	7 = White
2 = Green	5 = Violet	

66-I. NOT USED

67-I. NOT USED

68-I. NOT USED

69-I. EN. CH-T COL.

Set to 1 to enable custom color for the Channel-Time display. Set to 0 to disable custom color for the Channel-Time display.

70-I. FOR. CH-T COL. (Channel-Time Display Foreground Color)

Set according to Color Chart.

0 = Black	3 = Yellow	6 = Cyan
1 = Red	4 = Blue	7 = White
2 = Green	5 = Violet	

Note: If foreground and background color are the same, menu background is transparent.

71-I. BCK. CH-T COL. (Channel-Time Display Background Color)

Set according to Color Chart.

0 = Black	3 = Yellow	6 = Cyan
1 = Red	4 = Blue	7 = White
2 = Green	5 = Violet	

Note: If foreground and background color are the same, menu background is transparent.

72-I. NOT USED

73-I. CH NOT AVBLE

When set to 1 and channel override is set to 0, "NOT AVAILABLE" message is displayed when direct accessing a channel not in the favorite channel list.

74-I. CH-TIME SIZE

When set to 1 and transparent background is selected for Channel-Time display, (foreground color = background color and custom color enabled) a large channel number is displayed instead of the normal Channel-Time display.

75-I. NOT USED

76-I. DEFEAT XDS

Set to 1 to disable XDS display. Set to 0 to enable XDS display.

77-I. QUICK SHUTOFF

Allows TV power off to be controlled by the pillow speaker channel selection button. User would press and hold button down for time required to have TV turn off. Value Range 0 - 17, each number represents 1/2 second. For example, if set to 4, TV would turn off if user held speaker channel button down for 2 seconds.

78-I. UPN MSB

User programmable number, most significant byte readable by M.P.I. Command.

Installer Menus

Installer Menu Item 79-I through 90-I: Detailed Descriptions.

79-I. UPN MSB-1

User programmable number, most significant byte-1 readable by M.P.I. command.

80-I. UPN MSB-2

User programmable number, most significant byte-2 readable by M.P.I. command.

81-I. UPN LSB

User programmable number, least significant byte readable by M.P.I. command.

82-I. CHKSM ERROR

Enforces rigid M.P.I. checksum validation.
Set to 1 for validation. Set to 0 to turn off.

83-I. HANDSHK TIME

Adds an additional delay to the handshake time which is 64 msec, thus relaxing M.P.I. timing requirements to be compatible with PC based Windows controlled systems, range is 0 - 5.
Set to 0 to retain standard 64 msec delay.
Set to 1 - 5 to increase @ 16 msec additional, the delay up to 144 msec.

84-I. PERMANENT BLK

Allows Parental Control blocking schemes to be permanent by removing the blocking hours function.

Set to 1 to install Parental Control blocking restrictions permanently.

Set to 0 for user-specified hours control of blocking schemes.

85-I. NOT USED

86-I. NOT USED

87-I. NOT USED

88-I. EN NOISE MUTE (Enable Noise Mute)

Enables soft mute when a signal is not present.

89-I. POKE ENABLE

Enables poke function through M.P.I. commands

90-I. KEY LOCK

Disables front panel keys. Set to 1 for disable. Set to 0 for enable.

LT2000 QuickSet Programmer

Use the Zenith LT2000 QuickSet II "Clone" Programmer to copy the setup from a "master" TV then quickly transfer the setup to duplicate TVs must be the same model number as the master TV.

THE CLONE HAS CONTROL OF THE TV

THE CLONE IS VERSION	XX
THE TV IS VERSION	XX
THE SW IS REVISION	XX
CLONE CLOCK	= XX:XX
TV CLOCK	= XX:XX

-PRESS ANY KEY TO CONTINUE.
-DISCONNECT CLONE WHEN DONE.

Learn Master TV Typical MPI Connections

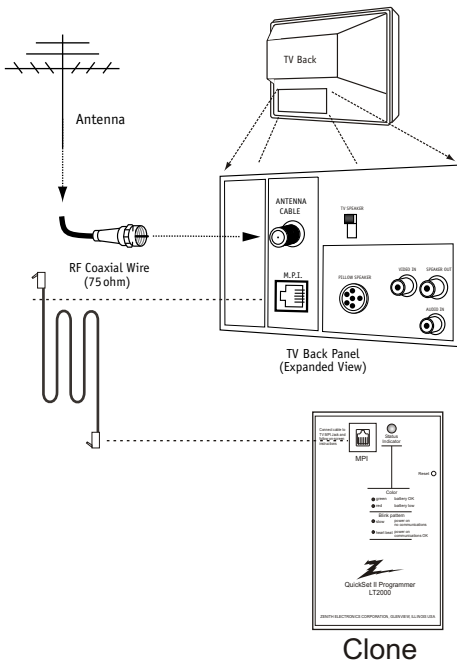

Teach Other TV Typical MPI Connections

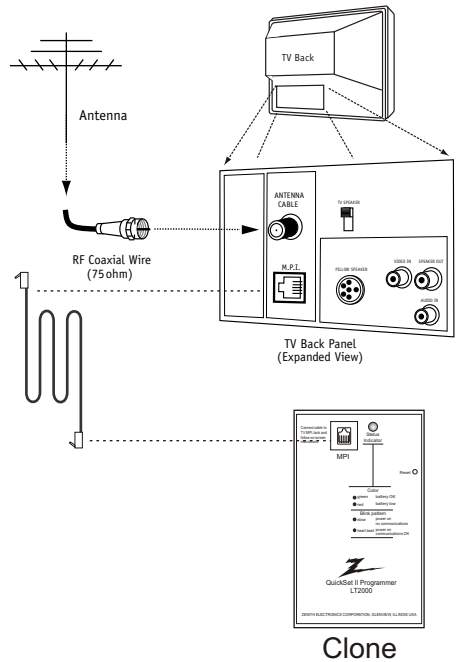

The optional QuickSet II Clone Programmer (LT2000) allows custom setup and programming information to be quickly copied from a master TV into multiple identical television sets. Once learned from the master, setup data is retained in the LT2000 for future use.

When using the LT2000, cloning operations will go easier if the TV set is connected to a good quality signal and operating with a stable picture displayed. To operate the LT2000, use the indicated keys on an HP602, LP702, or MBR3447 remote, or the front panel keys on the TV receiver.

Before you begin:

- The “master TV” should be connected to a good, stable signal from an over-the-air antenna or cable service and turned on.
- Teaching and Learning is only possible between identical model Zenith TVs. (However, the Clone programmer can store 4 different master TV setups.)



WARNING: Copying a blank or incorrect memory into a TV will cause the TV to operate erratically or become inoperable.

- Use a Zenith MBR Remote like the MBR3447 or the TV front panel controls to operate M Learning and Teaching menus.
- Make sure that the batteries in the Clone programmer are fresh.
- If the batteries are removed, the Clone Clock time will be lost.
- Decide if you want to set the time from the Clone programmer or copy the time to the Clone programmer; from a TV which has the clock set to the current time.
- Follow the connection diagrams above to connect the Clone to a master TV and, after learning is complete, to another TV to “teach” it the setup.

- Setting the time and transferring it to the Clone or another TV is a separate procedure.
- Once a TV’s setup is copied to another TV, that TV needs to be disconnected from power for about 5 seconds to activate the newly copied setup.
- See Troubleshooting to solve problems.

A. Set Up a Master TV

Using a Zenith Multi-Brand remote like the MBR3447, set up a “Master” TV with custom settings and features as described in the master TV’s operating guide. The master TV’s Setup is what you will copy to the Clone Programmer and transfer to TVs of the same model so they will operate identically.

B. Connect Clone to Master TV

If there is a good connection, the “Clone has Control of TV” message will appear. (See menu above.)



A slow flashing green light indicates there is a problem with the communications between the TV and the programmer. In this case, check for a damaged cable, poor contacts, or other connection troubles.



If the status indicator is red, the programmer batteries are low and should be replaced. Use 4 good-quality alkaline AA batteries.

Clone Selection Menu Choices

Typical Edit Channel Labels on-screen menus.

THE CLONE HAS CONTROL OF THE TV

THE CLONE IS VERSION XX
THE TV IS VERSION XX
THE SW IS REVISION XX

CLONE CLOCK= XX:XX
TV CLOCK= XX:XX
-PRESS ANY KEY TO CONTINUE.
-DISCONNECT CLONE WHEN DONE.

CLONE SELECTION MENU

- (1) LEARN FROM TV
- (2) TEACH TO TV
- (3) SET CLONE CLOCK FROM TV
- (4) SET TV CLOCK FROM CLONE
- (5) DISPLAY TV SETUP
- (6) DISPLAY CLONE SETUP

-TO CHANGE MENU ITEMS, PRESS CHANNEL KEYS OR DIGITS.

-TO EXECUTE ITEM, PRESS ON/OFF, POWER, OR ENTER

EDIT CHANNEL LABELS FOR MEMORY 1

LABEL 1: LAB 1 FOR CHANNEL ---

EDITING LABEL NUMBER

-VOL TO SELECT ITEM TO EDIT

-CH UP/DOWN CHANGE ITEM VALUE
-MUTE TO CLEAR THIS PROG. LABEL
-CC TO CLEAR ALL PROG. LABELS
-PRESS ENTER TO STORE THIS LABEL
-PRESS POWER OR ON/OFF WHEN DONE

CLONE SELECTION MENU

- (1) LEARN FROM TV
- (2) TEACH TO TV
- (3) SET CLONE CLOCK FROM TV
- (4) SET TV CLOCK FROM CLONE
- (5) DISPLAY TV SETUP
- (6) DISPLAY CLONE SETUP

-TO CHANGE MENU ITEMS, PRESS CHANNEL KEYS OR DIGITS.

-TO EXECUTE ITEM, PRESS ON/OFF, POWER, OR ENTER

SELECT CLONE MEMORY CONTAINING THE LABELS TO BE EDITED.

- (1) CHANNEL LABELS FOR MEMORY 1
- (2) CHANNEL LABELS FOR MEMORY 2
- (3) CHANNEL LABELS FOR MEMORY 3
- (4) CHANNEL LABELS FOR MEMORY 4
- (5) RETURN TO CLONE MENU

-TO CHANGE MENU ITEMS, PRESS CHANNEL KEYS OR DIGITS.

-TO EXECUTE ITEM, PRESS ON/OFF, POWER, OR ENTER.

SEND SELECTED CHANNEL LABEL MEMORY TO TV

- (1) CHANNEL LABELS FOR MEMORY 1
- (2) CHANNEL LABELS FOR MEMORY 2
- (3) CHANNEL LABELS FOR MEMORY 3
- (4) CHANNEL LABELS FOR MEMORY 4
- (5) RETURN TO CLONE MENU

-TO CHANGE MENU ITEMS, PRESS CHANNEL KEYS OR DIGITS.

-TO EXECUTE ITEM, PRESS ON/OFF, POWER, OR ENTER

Clone Selection Menu Choices

C. Learn Setup from Master TV

Press 1 to select the "Learn From TV" option, then press ON/OFF, POWER, or ENTER to go to the Memory Bank Selection Menu.

Pick the Memory "Bank" (1, 2, 3, or 4) you want to store this Master TV's Setup in by pressing either Channel key repeatedly to pick Memory 1, 2, 3, or 4. (If you choose a Memory "Bank" that already has a master TV's setup already in it, it will be overwritten by this Master TV's setup.)

Once the Clone memory bank is selected, press ON/OFF, POWER, or ENTER. The Clone memory bank you have selected will be shown. Press ON/OFF or POWER to begin copying the master TV's setup.

Ca. Set the Clock (Optional)

Set the time on the Master TV's Clock. (If the time has already been copied from another TV into the Clone programmer, you can set the Master TV's clock by copying the time from the Clone programmer.)

The Clone Programmer can copy the current time to both a master TV and to the Clone's internal clock; accurate to within one minute. (Another reason that the Clone programmer should be equipped with fresh, high-quality alkaline batteries is for it to keep the time as accurately as possible.)

Since the Clone Programmer's time cannot be set directly, the time needs to be copied from a Zenith TV equipped with M.P.I. Input capability.

Once the time is copied to the Clone programmer, the current time can then be transferred to another TV. (This can be a Master TV, or another TV which has had the features already set up.)

D. Teach Master TV's Setup to Other TV

Once Learning is complete, remove the M.P.I. cable from the master TV and connect it to the TV that you want to copy the master TV's setup to. With the "TV is Controlled by Clone" message displayed, press 2 or use either Channel key to go to the "Teach to TV" option, press ON/OFF, POWER, or ENTER. Follow on-screen instructions to transfer the Setup and other information to the "Learning" TV. After the "Teach to TV is Complete" message is displayed, press any key to return to the Clone menu option, then press ON/OFF, POWER, or ENTER. If finished, remove M.P.I. Cable from the TV.

E. Disconnect TV Power for 5 Seconds

Remove the TV power cord of the newly "Cloned TV" from the power outlet for about 5 seconds to activate the newly copied Setup.

Clone Selection Menu Choices

Operation Notes

Disconnect the Clone from the TV when you are finished; automatically switching it off. The real-time clock continues to run when the main circuits are switched off.

Reset Clone After Static Shock

After replacing exhausted batteries, or if the programmer behaves strangely after a static shock, use a paper clip or similar instrument inserted through the small hole marked "RESET" to activate the internal reset switch and restore normal operation.

After a reset, check the real-time clock setting. It may be necessary to reset the Clone Programmer clock from a TV containing the correct time.

The LT2000 programmer is designed to be used with TVs containing the 221-01006 and later processors. Use with earlier TV sets may give unpredictable results. The specific microprocessor used in any TV set may be determined by activating the Installer Menu. The microprocessor part number appears at the top of the screen when the Installer Menu is activated. Processors before the 221-01006-04 have a limited screen display capability. They can not display entire screens as shown in the quick setup instructions accompanying the LT2000 clone programmer. Use the printed menu illustrations on the quick setup sheet supplied with the Clone as an aid to making your programming choices. (Although the menus are not all displayed, the clone functions all operate normally).

Troubleshooting

Problem	Possible Cause(s)	Possible Solution(s)
Clone Programmer LED does not blink.	<ul style="list-style-type: none"> M.P.I. cord not connected. TV not turned on. 	<ul style="list-style-type: none"> -Connect M.P.I. cord. -TV must be on for clone to work.
Clone menu hard to read.	<ul style="list-style-type: none"> Weak batteries. Weak signal. 	<ul style="list-style-type: none"> -Install 4 fresh AA high-quality alkaline batteries. -Connect TV to a reliable signal Source.
No time set. time to Clone Programmer. Menu items 7-8 not if they were on Master TV. on clone selection menu.	<ul style="list-style-type: none"> No time on Master TV. Not necessary. 	<ul style="list-style-type: none"> -Set time on master TV, copy -Channel Labels already cloned;

Master and Other TVs

Cloning did not work.	<ul style="list-style-type: none"> Procedure interrupted. Different TV models. 	<ul style="list-style-type: none"> -Wait until procedure complete message is displayed. -Cloning is only possible with identical model TVs.
Clone time disappeared.	<ul style="list-style-type: none"> Batteries were removed. 	<ul style="list-style-type: none"> -Batteries must remain installed to retain time settings.
Channel Labels not present on cloned TV.	<ul style="list-style-type: none"> Saved to other memory. 	<ul style="list-style-type: none"> -Must save channel labels to same memory bank as master TV setup.
New Setup not present.	<ul style="list-style-type: none"> TV not reset. 	<ul style="list-style-type: none"> -Disconnect newly cloned TV from power for 5 seconds.



When cloning operations are complete, just unplug the LT2000 from the TV.



If the TV does not display a picture (blank screen) after a few seconds, just change channels.

Patient Remote Key Functions

A quick list of the keys on the optional patient and what they do in TV mode.

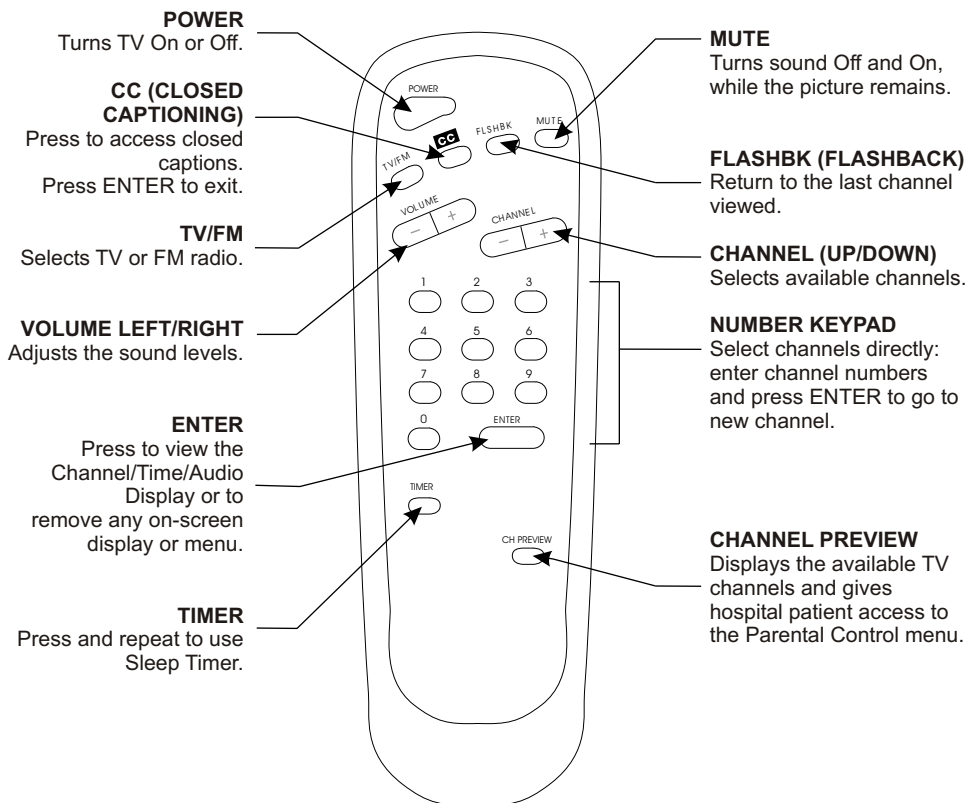

remote control part number

SC637

124-213-05

Patient Remote Key Functions-FM Radio

A quick list of the keys on the optional patient remote and what they do in FM Radio mode.

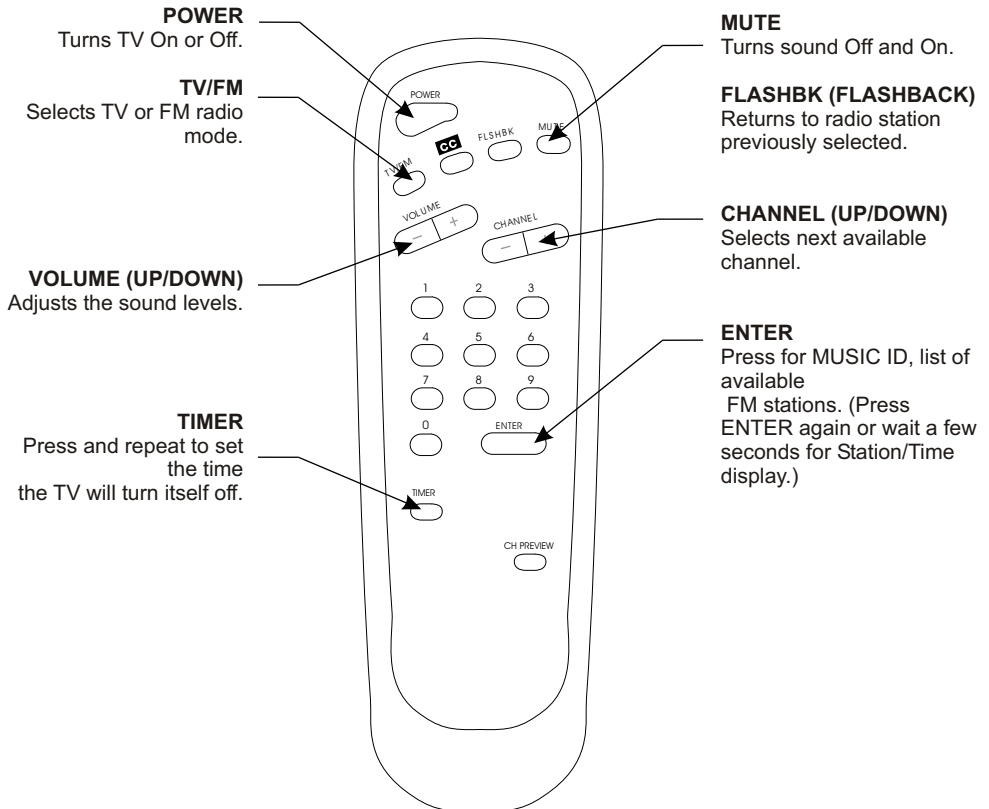

remote control part number

SC637

124-213-05

Parental Control Menu

This optional feature can be used to "block" undesirable programming from appearing on the TV.

Parental Control offers the user a wide variety of options and settings that restrict or "block" the programming that can appear on the TV. Parental control allows the user the capability of defining which program rating they consider acceptable, to the younger or more sensitive viewer. The AUX input can also be blocked. It can be preset and turned either on or off by the user who specifies a secret 4-number code, the password. The number of hours blocked are specified. General audience and children viewer blocks can both be programmed into the TV's memory. Viewer ratings are specified for both TV and the motion picture industry; both rating systems can be used. The ratings are based mainly on the ages of children.

Overview

To insure complete coverage for all TV programs, (movies and regular TV shows) choose a rating for MPA, from the selections below AND choose ratings from the TV Parental Guidelines Rating System on the next page, using the Age Block option for General Audiences, and for Children. In addition to those, you may wish to add additional restrictions from the Content Block menu. See the Parental Control menu, and submenus example on the next page.

Things To Consider Before Setting Up Parental Control

Determine which rating you consider acceptable to the viewer. (For example, if you choose TV-PG, all more restrictive ratings will be automatically blocked; the viewer will not be able to see: TV-PG, TV-14, or TV-MA rated programming.)

Block program "Content" based on individual parameters such as: Strong Dialog, Mature Language, Sex Scenes, Violence Scenes, or Fantasy Violence Scenes; in the Content Blk option.

How many hours do you want Parental Control to be active? You can set the Hours option for up to 12 hours.

Select a secret password; in the Set Password option. Use the number keys on the remote. Don't forget the password, it is the only way you can access the Parental Control menu and change rating selections, or turn Parental Control off.

Do you want Parental Control to be active all the time? If not, you can turn it on or off; with the Lock On/Off option.



You can set different Parental Control viewing restrictions for general audiences and for children -- both can be active at the same time.



You cannot disable Parental Control by disconnecting the TV from power. Block hours will automatically reset to the original block time setting specified if power is disconnected.



Simply specifying one content block such as Sex Scenes, will not automatically block another content in the programs from appearing.



The AUX input source can also be blocked.

MOTION PICTURE ASSOCIATION OF AMERICA (MPAA) RATING SYSTEM

G	General Audiences	Content not offensive to most viewers.
PG	Parental Guidance Suggested	Content is such that parents may not want their children to view the program.
PG-13	Parental Guidance Suggested	Program is inappropriate for preteens, with a greater degree of offensive material than a PG rated program.
R	Restricted viewing	Not for children under age 17. Strong elements of sex and/or violence.
NC-17	Restricted Viewing	Not for children under age 17 under any circumstances. Strong sexual content.
X	Hard Core Films	Same as NC-17 rating.

Note: Zenith Electronics Corporation is not liable for any program content that appears when using this rating system; as always, user discretion is advised.

Parental Control Menu

After you have read the preceding page, follow instructions below to set up and activate Parental Control.

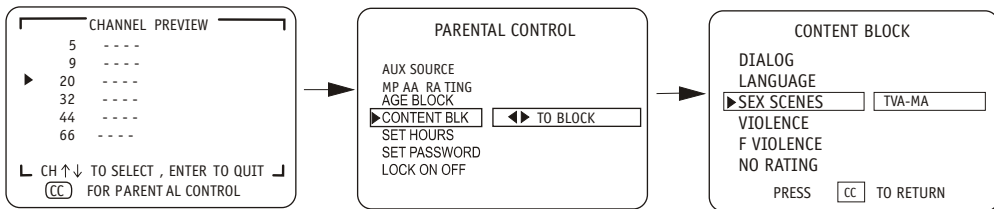

- 1** Press CH PREVIEW on the optional remote control.
- 2** Press CC to access the PARENTAL CONTROL menu.
- 3** Use SELECT to highlight an option like CONTENT BLOCK.
- 4** Press ADJ Right arrow to go to the CONTENT BLOCK menu.
- 5** Use SELECT to highlight an option like SEX SCENES.
- 6** Press ADJ Right arrow to choose: Unblocked, TV-PG AND ABOVE, TV-14 AND ABOVE, or TV-MA. (AND ABOVE means more restrictive headings are automatically included when you choose a low restriction setting like TV-PG.) See the Mini Glossary, Ratings Charts on this and the previous page for rating meanings.
- 7** After you have selected and adjusted the parental control menu options to your preferences:
 - Set the number of hours Parental Control will be on.
 - Set a 4-number password using the NUMBER keypad.
 - Set the Lock On/Off option to either on or off.

Note: some broadcasts do not contain rating Information.

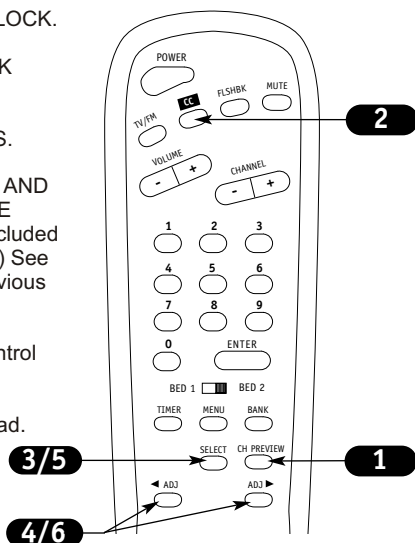

TV PARENTAL GUIDELINE RATING SYSTEM

TV-G	General Audience	Considered suitable for all audiences; children may watch unattended.
TV-PG	Parental Guidance Suggested	Unsuitable for younger children, may contain: Suggestive Dialog, Mature Language, Sex, and Violence Scenes.
TV-14	Parents Strongly Cautioned	Unsuitable for children under 14, may contain: Strong Dialog, Mature Language, Sex, and Violence Scenes.
TV-MA	Mature Audience Only	Adults only, may contain: Strong Dialog, Mature Language, Sex, and Violence Scenes.

CHILDREN'S CLASSIFICATIONS

TV-Y	Children	Considered suitable for all children under 7 years old.
TV-Y7	Children 7 and over	Considered suitable for children over 7, may contain Fantasy Violence Scenes.

Menus & On-Screen Displays

Using the optional remote, press the keys indicated below to access these menus and displays.

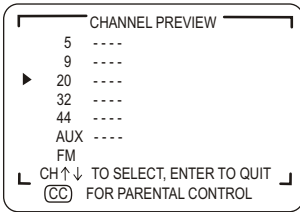

Ch Preview Menu

Press CH PREV. Displays list of the available TV Channels, AUX source, and patient Parental Control menu.



Inactive TV Display

Notify nurse/attendant if you wish to use TV.

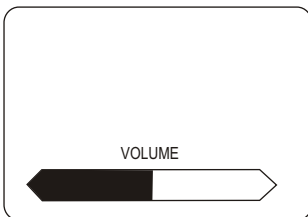

Volume Display

Press VOLUME. Shows currently selected sound setting.

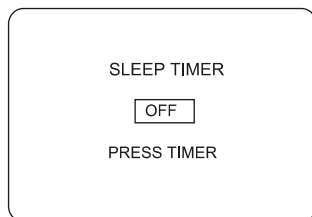

Sleep Timer Menu

Press TIMER. Sets TV shut-off time and shows remaining time before TV shut-off.

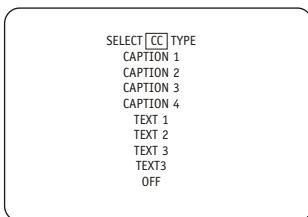

Closed Captions Menu

Press CC. Turns selected closed captions/text option on or off..

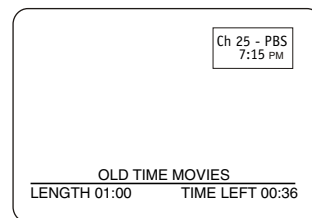

Channel/Time/XDS Display

Press ENTER. Shows currently selected channel, current time if the clock has been set, and XDS data, if being broadcast; title of program, length of program, and time remaining.

Maintenance

Routine TV cabinet and screen cleaning.

Careful and regular cleaning can extend the the useful service life of the TV. Be sure to turn the power off and pull out the power cord before you begin any cleaning.

Screen Cleaning 1. Here's a great way to keep the dust off the screen for a while. Wet a soft cloth in a mixture of lukewarm water and a little fabric softener or dish washing detergent. Wring the cloth until it's almost dry, and then use it to wipe the screen.

2. Make sure the excess water is off the screen, and then let it air-dry before turning it on.

Cabinet Cleaning 1. Use a soft cloth with a mild soap solution to wipe the cabinet. (Avoid using any harsh, industrial strength variety of cleaner.)

2. Rinse the cloth and wipe the cabinet again.

3. Let the cabinet air-dry before turning the HealthView™ TV on.

Extended Absence If the TV is to be left dormant for a long time, it's a good idea to unplug the power cord to protect against possible damage from lightning or power surges. If you use an off-air antenna, you may also want to disconnect it from the back of the TV.

Troubleshooting

Some quick and easy tips to resolving problems.

SYMPTOM POSSIBLE SOLUTIONS

Snowy picture and unclear sound.	<ul style="list-style-type: none">• Check the antenna connection or location.• Check the cable input.• Check to see if the TV/ VCR button on the VCR has the TV selected.
Multiple images or 'ghost shadows'.	<ul style="list-style-type: none">• Check the antenna direction and/or location.• Check the cable input.• Make sure the wire from the antenna to the TV is properly connected.
Interference: Sharp lines across the screen and lousy sound.	<p>The following may cause image problems or distortion: Electrical appliances, powerful lights, cars, trucks; computers or portable phones; medical equipment.</p> <ul style="list-style-type: none">• If possible increase the distance between the TV and the offending appliance. Or shut one of them off.
Normal picture but no sound.	<ul style="list-style-type: none">• Check volume levels.• Make sure the TV sound is not Muted.• Try another channel. The problem may be the broadcast, not the TV.• Is TV SPKR selected on TV back connections panel?• Is PILLOW SPKR selected on TV back connections panel but no pillow speaker connected?• Is the wire for the pillow speaker properly installed?
No picture and unclear sound.	<ul style="list-style-type: none">• Make sure output channels on all A/V equipment are on the same channel (3 or 4).• Check that all connections are tight.
No picture and no sound.	<ul style="list-style-type: none">• Is the AC power cord plugged in?• Check that the AC power outlet works. (Test it by plugging in another device or try another power outlet.)• Make sure the brightness and sound controls are set properly.• Try another channel. The problem may be with the broadcast.
No color, but the sound is O.K.	<ul style="list-style-type: none">• Is the program's picture in black and white?• Check the color control in the Video menu.• Try another channel. The problem may be with the broadcast.
Picture has a big black box On it, but the sound is O.K.	<ul style="list-style-type: none">• The CC (closed caption) option may be in Text mode. Select Caption 1, or OFF in the Captions/Text menu.
Remote control doesn't work.	<ul style="list-style-type: none">• Make sure the batteries are fresh and installed properly.
Menu options can't be Changed or selected.	<ul style="list-style-type: none">• Try unplugging the TV power cord for a few minutes, then plugging it back in.
No XDS Information.	<ul style="list-style-type: none">• XDS data may be provided by the broadcasting station. Not all programs will have this information.

Glossary

A list of definitions for some of the words found in this guide.

75 OHM RF CABLE	The wire that comes from an off-air antenna or cable service provider. The end looks like a hex-shaped nut with a wire sticking through the middle. It screws onto the threaded jack on the back of the TV.
300 TO 75 OHM ADAPTER	A small device that connects a two-wire 300 ohm antenna to a 75 ohm RF jack. They are usually about an inch long with two screws on one end and a round opening with a wire sticking out on the other end.
A/V DEVICE	Any device that produces video or sound (VCR, DVD, cable box, or television).
ADD	Adds new channels to list that the patient will scroll through when using the patient remote.
AMPLIFIER	An electronic device that amplifies sound from a television, CD player, VCR, DVD or other A/V device.
ANTENNA	The physical receiver of television signals sent over the air. A large metal piece of equipment does not always have to be visible for the institution to be using an antenna.
AUTO PROGRAM	AUTO PROGRAM Auto Program has the HealthView TV automatically find all the channels available.
DELETE	DELETE Lets you remove channels from the list the patient will scroll through using the patient remote.
INPUT	INPUT Refers to the jack that receives a signal from a TV, VCR, or other A/V device.
JACK	JACK A connection on the back of a TV, VCR, or any other A/V device.
MONO SOUND	MONO SOUND Mono (monaural) sound is one channel of sound. On more than one speaker, all the speakers play the same audio.
M.P.I.	Multiple Protocol Interface: Zenith protocol for external control of TV through RJ11 (M.P.I.) Input jack on TV connections panel. (M.P.I. jack is used for cloning TV's features.)
OUTPUT	Refers to the jack that sends a signal out of a VCR, DVD, or other A/V device.
SIGNAL	Picture and sound traveling through a cable, or over the air, to the television screen.
TUNER	Device that picks up the audio/video signal and turns it into picture and sound.
XDS	Extended Data Service: Additional program information if provided by the broadcaster.

Direct-View Color TV Welcome to the Zenith family! We believe that you will be pleased with your new TV. Please read this warranty carefully, it is a "LIMITED WARRANTY" as defined under Federal Law. This warranty gives you specific legal rights, and you may also have other rights that vary from state-to-state within the U.S.A.

ZENITH'S RESPONSIBILITY

- Service Labor** During a period of one year from effective warranty date, Zenith will provide service labor by the Zenith authorized service center when needed, as determined by the Zenith service center, as a result of manufacturing defects.
- Parts** New or remanufactured replacements for factory-defective parts will be supplied by a Zenith authorized service center for one year from effective warranty date (color picture tube — two years). Such replacement parts are warranted for the remaining portion of the original warranty period.
- Warranty Service** Warranty service is provided in the institution in most cases. (Some repairs may require the unit to be taken by the servicer to the repair facility and returned, at no additional charge.) Call 1-888-865-3026 for further information.
- Not Covered** This warranty covers manufacturing defects and does not cover installation, adjustment of customer controls, installation or repair of antenna systems, cable converters or cable company-supplied equipment; it also does not cover damage due to misuse, abuse, negligence, acts of God or other causes beyond the control of Zenith. Any alteration of the product after manufacture voids this warranty in its entirety.

THIS WARRANTY IS IN LIEU OF ANY OTHER WARRANTY, EXPRESS OR IMPLIED, INCLUDING WITHOUT LIMITATION, ANY WARRANTY OF MERCHANTABILITY OR FITNESS FOR A PARTICULAR PURPOSE, AND ZENITH SHALL NOT BE LIABLE FOR ANY CONSEQUENTIAL, INDIRECT, OR INCIDENTAL DAMAGES OF ANY KIND, INCLUDING LOST REVENUES OR PROFITS IN CONNECTION WITH THIS PRODUCT. SOME STATES DO NOT ALLOW LIMITATIONS ON HOW LONG AN IMPLIED WARRANTY LASTS OR THE EXCLUSION OR LIMITATION OF INCIDENTAL OR CONSEQUENTIAL DAMAGES, SO THE ABOVE LIMITATIONS OR EXCLUSIONS MAY NOT APPLY TO YOU.

OWNER'S RESPONSIBILITY

- Effective Warranty Date** Warranty begins on the date of installation of the Commercial Products Direct View Television Receiver.
For your convenience, keep the dealer's dated bill of sale or delivery ticket as evidence of the purchase date.
- Operating Guide** Read your Operating Guide carefully so that you will understand the operation of the TV and how to adjust the controls.
- Antenna** Reception problems caused by inadequate antenna or faulty antenna connections are the owner's responsibility.
- Important** Product Registration—Please fill out and mail the Product Registration Card. It is imperative that Zenith know how to reach you promptly if we should discover a safety problem that could affect you.
- Warranty Service** **For warranty service information, call 1-888-865-3026.** Parts and service labor that are Zenith's responsibility (see above) will be provided without charge. Other service is at the owner's expense. If you have any problem in obtaining satisfactory warranty service, call 1-888-865-3026. You must provide the model number, serial number and date of purchase or date of original installation.
Before you ask for warranty service, read "Maintenance and Troubleshooting" in the operating guide. You might avoid a service call.

For Customer Support/Service Please call: 1-888-865-3026

Free Manuals Download Website

<http://myh66.com>

<http://usermanuals.us>

<http://www.somanuals.com>

<http://www.4manuals.cc>

<http://www.manual-lib.com>

<http://www.404manual.com>

<http://www.luxmanual.com>

<http://aubethermostatmanual.com>

Golf course search by state

<http://golfingnear.com>

Email search by domain

<http://emailbydomain.com>

Auto manuals search

<http://auto.somanuals.com>

TV manuals search

<http://tv.somanuals.com>