



Installation and Operating Guide | Warranty

Model Number | L20V54S | LCD TV/Monitor



	table of contents	page 5
	installer quick setup guide	page 60



For Customer Support/Service please call:

1-888-865-3026

www.zenith.com
www.lgcommercial.com

RECORD THE MODEL NUMBER

The model and serial number of this LCD TV/Monitor are located on the back of the cabinet. For future reference, we suggest that you record the serial number here:

MODEL NO. **L20V54S**

SERIAL NO. _____



CAUTION:

TO REDUCE THE RISK OF ELECTRIC SHOCK DO NOT REMOVE COVER (OR BACK). NO USER SERVICEABLE PARTS INSIDE. REFER TO QUALIFIED SERVICE PERSONNEL.



The lightning flash with arrowhead symbol, within an equilateral triangle, is intended to alert the user to the presence of uninsulated "dangerous voltage" within the product's enclosure that may be of sufficient magnitude to constitute a risk of electric shock to persons.



The exclamation point within an equilateral triangle is intended to alert the user to the presence of important operating and maintenance (servicing) instructions in the literature accompanying the appliance.

WARNING:

TO PREVENT FIRE OR SHOCK HAZARDS, DO NOT EXPOSE THIS PRODUCT TO RAIN OR MOISTURE.

THIS PRODUCT MUST BE USED WITH UL LISTED MOUNTING BRACKET.



IT IS FORBIDDEN TO CONNECT THIS TV TO ANY TELECOMMUNICATION NETWORK / TELEPHONE.

NOTE TO CABLE TV INSTALLER:

This reminder is provided to call the CATV system installer's attention to Article 820-40 of the National Electric Code (U.S.A.). The code provides guidelines for proper grounding and, in particular, specifies that the cable ground shall be connected to the grounding system of the building, as close to the point of the cable entry as practical.

REGULATORY INFORMATION:

This equipment has been tested and found to comply with the limits for a Class B digital device, pursuant to Part 15 of the FCC Rules. These limits are designed to provide reasonable protection against harmful interference when the equipment is operated in a residential installation. This equipment generates, uses and can radiate radio frequency energy and, if not installed and used in accordance with the instruction manual, may cause harmful interference to radio communications. However, there is no guarantee that interference will not occur in a particular installation. If this equipment does cause harmful interference to radio or television reception, which can be determined by turning the equipment off and on, the user is encouraged to try to correct the interference by one or more of the following measures:

- Reorient or relocate the receiving antenna.
- Increase the separation between the equipment and receiver.
- Connect the equipment into an outlet on a circuit different from that to which the receiver is connected.
- Consult the dealer or an experienced radio/TV technician for help.

Marketed and Distributed in the United States by LG Electronics U.S.A., Inc.
2000 Millbrook Drive, Lincolnshire, IL 60069.

CAUTION:

Do not attempt to modify this product in any way without written authorization from Zenith Electronics Corporation. Unauthorized modification could void the user's authority to operate this product.

COMPLIANCE:

The responsible party for this product's compliance is:

LG Electronics U.S.A., Inc.,
2000 Millbrook Drive
Lincolnshire, IL 60069, USA.
Phone: 1-847-941-8000

WARNING:

Apparatus shall not be exposed to dripping or splashing and no objects filled with liquids, such as vases, shall not be placed on the apparatus.

CAUTION:

THESE SERVICING INSTRUCTIONS ARE FOR USE BY QUALIFIED SERVICE PERSONNEL ONLY. TO REDUCE THE RISK OF ELECTRIC SHOCK, DO NOT PERFORM ANY SERVICING OTHER THAN THAT CONTAINED IN THE OPERATING INSTRUCTIONS UNLESS YOU ARE QUALIFIED TO DO SO.

CAUTION:

When used outside of the U.S., it may be used HAR cord with fitting of an approved agency is employed.
(When used outside of U.S., other power supply cords may be used if the cord is approved by the local regulating agency.)

CAUTION:

1. Do not put this product next to the patient's bed where it can be reached by the patient.
2. Install product in such a way that patients will not be able to touch this product.
3. This product should only be mounted on a wall.

CLEANING AND DISINFECTION:

Clean the exterior of this television by removing dust with a lint-free cloth.

CAUTION: To avoid damage to the surface of the television, do not use abrasive or chemical cleaning agents.

DISCONNECTING DEVICE FROM MAINS:

Main plug is the disconnecting device. The plug must remain readily operable.

IMPORTANT SAFEGUARDS FOR YOU AND YOUR NEW PRODUCT

YOUR PRODUCT HAS BEEN MANUFACTURED AND TESTED WITH YOUR SAFETY IN MIND. HOWEVER, IMPROPER USE CAN RESULT IN POTENTIAL ELECTRICAL SHOCK OR FIRE HAZARDS. TO AVOID DEFEATING THE SAFEGUARDS THAT HAVE BEEN BUILT INTO YOUR NEW PRODUCT, PLEASE READ AND OBSERVE THE FOLLOWING SAFETY POINTS WHEN INSTALLING AND USING YOUR NEW PRODUCT, AND SAVE THEM FOR FUTURE REFERENCE. OBSERVING THE SIMPLE PRECAUTIONS DISCUSSED IN THIS MANUAL CAN HELP YOU GET MANY YEARS OF ENJOYMENT AND SAFE OPERATION THAT ARE BUILT INTO YOUR NEW PRODUCT.

Notes

- If the TV feels cold to the touch, there may be a small "flicker" when it is turned on. This is normal, there is nothing wrong with the TV.
- Some minute dot defects may be visible on the screen, appearing as tiny red, green, or blue spots. However, they have no adverse effect on the TV's performance.
- Avoid touching the LCD screen or holding your finger(s) against it for long periods of time. Doing so may produce some temporary distortion effects on the screen.

IMPORTANT SAFETY INSTRUCTIONS

1. Read these instructions.
2. Keep these instructions.
3. Heed all warnings.
4. Follow all instructions.
5. Do not use this apparatus near water.
6. Clean only with dry cloth.
7. Do not block any ventilation openings. Install in accordance with the manufacturer's instructions.
8. Do not install near any heat sources such as radiators, heat registers, stoves, or other apparatus (including amplifiers) that produce heat.
9. Do not defeat the safety purpose of the polarized or grounding-type plug. A polarized plug has two blades with one wider than the other. A grounding type plug has two blades and a third grounding prong. The wide blade or the third prong is provided for your safety. If the provided plug does not fit into your outlet, consult an electrician for replacement of the obsolete outlet.
10. Protect the power cord from being walked on or pinched particularly at plugs, convenience receptacles, and the point where they exit from the apparatus.
11. Only use attachments/accessories specified by the manufacturer.
12. Use only with the cart, stand, tripod, bracket, or table specified by the manufacturer, or sold with the apparatus. When a cart is used, use caution when moving the cart/apparatus combination to avoid injury from tip-over.



PORTABLE CART WARNING

13. Unplug this apparatus during lightning storms or when unused for long periods of time.
14. Refer all servicing to qualified service personnel. Servicing is required when the apparatus has been damaged in any way, such as power-supply cord or plug is damaged, liquid has been spilled or object have fallen into the apparatus, the apparatus has been exposed to rain or moisture, does not operate normally, or has been dropped.

Outdoor Antenna Grounding

If an outside antenna or cable system is connected to the product, be sure the antenna or cable system is grounded so as to provide some protection against voltage surges and built-up static charges. Article 810 of the National Electrical Code (U.S.A.), ANSI/NFPA 70 provides information with regard to proper grounding of the mast and supporting structure, grounding of the lead-in wire to an antenna discharge unit, size of grounding conductors, location of antenna-discharge unit, connection to grounding electrodes, and requirements for the grounding electrode.

Example of Grounding According to National Electrical Code Instructions

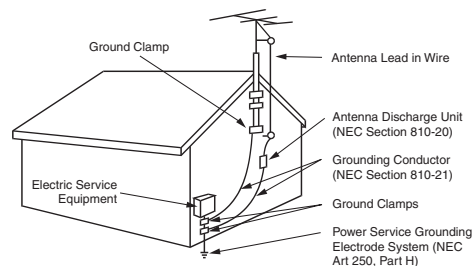

NEC - National Electrical Code

Table of Contents

The table of contents lists the pages to go to for setting up the features for the end user.

Safety Warnings	2-3	Step 3. Customize the TV's Features	
Important Safety Instructions	4	Setup Menu	
Table of Contents	5	Clock Setup	23-25
Step 1. LCD TV/Monitor Installation and Connections		Menu Language	26
Setup Checklist	6	V-Chip	27-30
Installation/Connections Overview	7	Caption Menu	31-32
VESA Standard TV Mounts	8	Sound Menu	33-34
TV and other Equipment Hookup		Picture Menu	35-36
Antenna	9	Managing the Channel Banks	37-39
Cable Service	10	Installer Overview	40
Antenna & VCR	11	Commercial Mode Setup	41
Cable Service with VCR	12	Cloning Connections/Learning Setup	42
Pillow Speaker Hook Up	13	Cloning Programmer Learning Setup	43
Power Cord Hookup	14	Cloning Connections/Teaching Setup	44
Front Panel Controls	15	Installer Menu	45-50
Menus and Displays Overview		Reference	50-53
On-Screen Menus Overview	16	L20V54S Aux Input Configuration/Troubleshooting	54
Other Menus and On-Screen Displays	17	Troubleshooting	55
User Remote Control Key Functions	18	Reference: Cloning Procedure Troubleshooting	56
Installer Remote Control Key Functions	19	Troubleshooting Flow Chart	57
Step 2. Channel Search and Reception Setup		TV Operation Check	58
Auto Program (Do a Channel Search)	20	Glossary of Terms	59
Channel Menu		Installer Quick Setup Guide	60
Channel List	21	Notes	61-63
Channel Labels Setup	22	Warranty	Back Cover

Optional USER and Installer Remote Controls for Model No. L20V54S

Shown herein is an optional Installer remote control available for the L20V54S model only. The Installer remote control is NOT included with the LCD TV/Monitor. However, both the User and Installer remotes can be purchased separately, see your Zenith dealer.

Purchase the Optional Installer's Remote and Clone Programmer

To perform a normal installation set up, you need an installer's remote and the LT2002 Quickset II Clone Programmer – both are shown and described in later sections. See your Zenith/LG dealer if you wish to purchase the Installer remote and LT2002. The installer remote allows access to the Installer menus, User menus, and Channel Banks in the Manual Channel Set options on the Setup menu. The installer remote has Menu, Select, and Adjust Keys. The LT2002 Quickset II Clone Programmer is used to duplicate a TV's setup and install it on another identical TV.

**Note: Design and specifications are subject to change without prior notice.*

Setup Checklist

Installation Overview

- Unpack the LCD TV/Monitor and all accessories.
- Determine installation location for the LCD TV/Monitor, TV stand or mount.
- Determine mounting and installation requirements. If used, AC Power source outlet, Antenna/Cable service connectors, any external equipment required for system or TV operation, all necessary cables, wires, connectors and any other additional required hardware, etc.

Installation Overview & System Setup: Questions to Consider Before Installation

VESA Bracket

Does the VESA Bracket have to be mounted to the TV? Y: Install VESA Bracket on TV following the instructions supplied with the bracket.

Yes___ No___

TV Stand

Does the TV have to be mounted on the stand? Y: Mount the TV on the stand following the instructions provided with the TV stand.

Yes___ No___

Installer's Remote Control

Does the Installer have an the optional Installer's remote control available to use to set up the TV (This is a must for TV setup.)?

Yes___ No___

Master TV Setup

Will the Master TV's features setup be cloned and be copied to other identical LCD TV/Monitors?

Yes___ No___

LT2002 Quickset II Clone Programmer

To copy the TV's setup, the installer will need a clone programmer. Is there a Zenith LT2002 Clone Programmer available?

Yes___ No___

End-User Remote Control

Will a remote control be provided to the end user to operate the TV? (No remote is included with the TV.)

Yes___ No___

End-User Menu Access

Will the end-user have access to all the menus on the TVs from the front panel?

Yes___ No___

LCD TV/Monitor Setup Checklist

1. Install the LCD TV/Monitor where it will be used.

Prior to Operation

The LCD TV/Monitor must be connected to all external antenna/cable, video, and audio source equipment and AC power source. See page 5, Table of Contents.

2. Make all external source equipment connections. See pages 10 - 14.

3. Connect the LCD TV/Monitor to a standard 120V, 60 Hertz, AC power source. See page 14.

4. Turn on the TV and all source equipment.

Review TV Setup Options in the Installer's Menu Section

The Installer's menu includes a number of options for the master TV's setup that enable the installer or system administrator to devise a unique system using the many different options and variables available. See Installer's menus section.

Master TV Features Setup for Cloning Overview

- Set up Installer's remote control, see page 19.
- Do a Channel Search, see page 20.
- Channel List.
- Channel Label.
- Video/picture appearance options setup, see Picture menu.
- Audio/sound options setup, see Sound menu.
- Set up all other features. See page 5, Table of Contents, for a list of features available on this LCD TV/Monitor.

Clone Master TV's Setup

See Clone Programmer section.

Installation/Connections Overview

To hook up source equipment, see below and also refer to the Table of Contents on page 5; shows pages to go to for equipment hookup options.

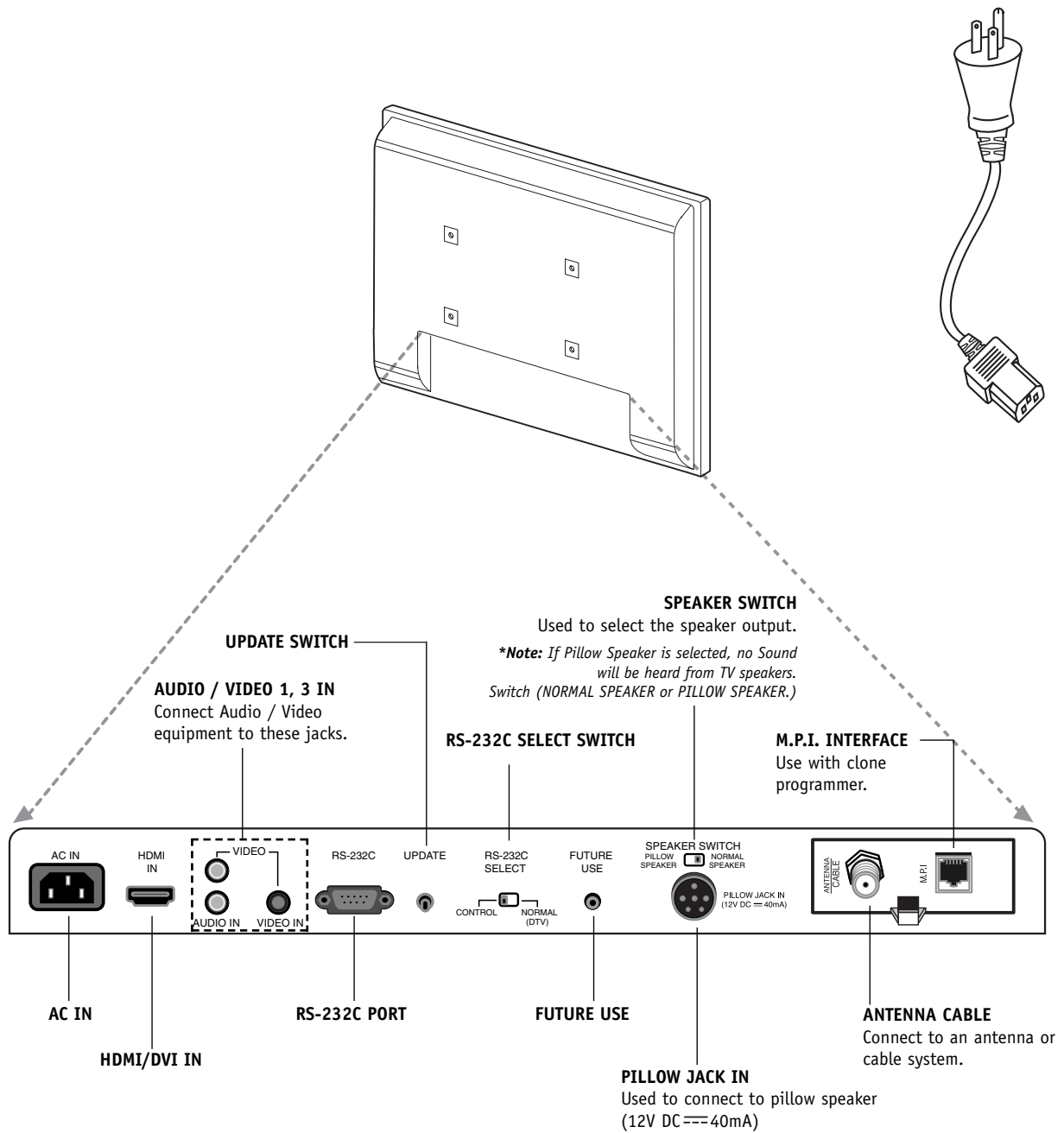

***Note:** RS-232C, Update Switch and RS-232C Select Switch are reserved for qualified and authorized service and technical support personal only.

VESA Standard TV Mounts

VESA Standard 100mm TV Mounts and Stands

Following are shown some examples of VESA standard 100 mm mounts. Since there are numerous types of stands and mounts available, only a few are shown here. Refer to the instructions provided with the TV stand that will be used to mount the TV.

Typical Wall Stud Type Mount with Swivel Bracket

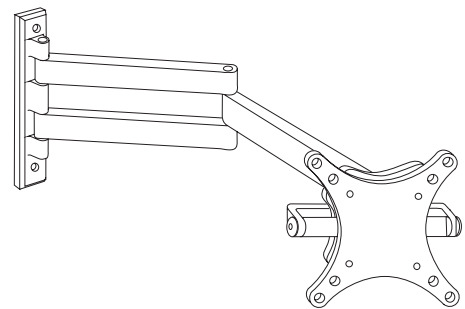
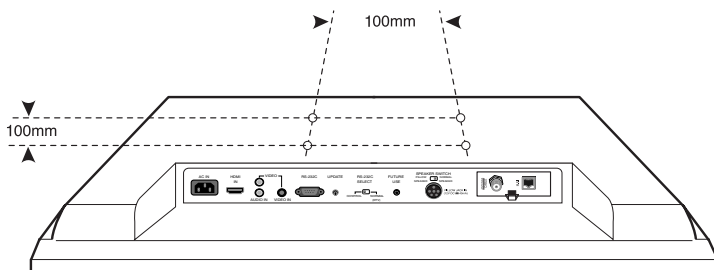

General Guidelines: Choosing a location for installing a VESA Standard Mount

Be sure the style of stand selected is capable of supporting the weight of the TV.

If the mount will be on a wall, a typical wooden stud behind the wall board would be the preferred choice for a location to attach the wall mount. The wall mount location chosen should be appropriate for drilling holes and have available the required power source as well as antenna/cable and other equipment leads.

For pedestal-type mounts, a sturdy surface on a desk or other similar flat table-like surface would be the appropriate location for mounting a pedestal-style TV stand. (Some stands are portable and can be moved from one location to another.) Be sure all safety considerations are followed.

Most stands are designed so that the wiring would be threaded through the stand itself or a loop-through style clamp so that the wiring is neatly bunched and not strung in such a way as to create a potential hazard to the user.

Typical Pedestal Type Mount with Swivel Bracket

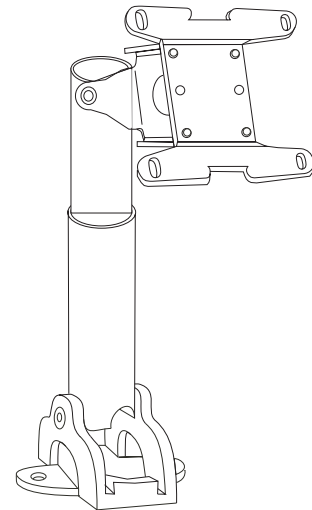

Antenna Hookup

Connect an off-air antenna to the LCD TV/Monitor.

- 1** Locate the Antenna/Cable jack on the back of the LCD TV/Monitor.
- 2** Connect the antenna wire (Flat or Round) that runs from the wall to this jack, according to one of the diagrams shown to the right.
- 3** After all connections are complete, plug in the TV. The LCD TV/Monitor is designed to operate on AC power.



If the antenna is a 75 ohm RF cable, then no adapters are required.



A 300 to 75 ohm adapter is not included with the Zenith LCD TV/Monitor.

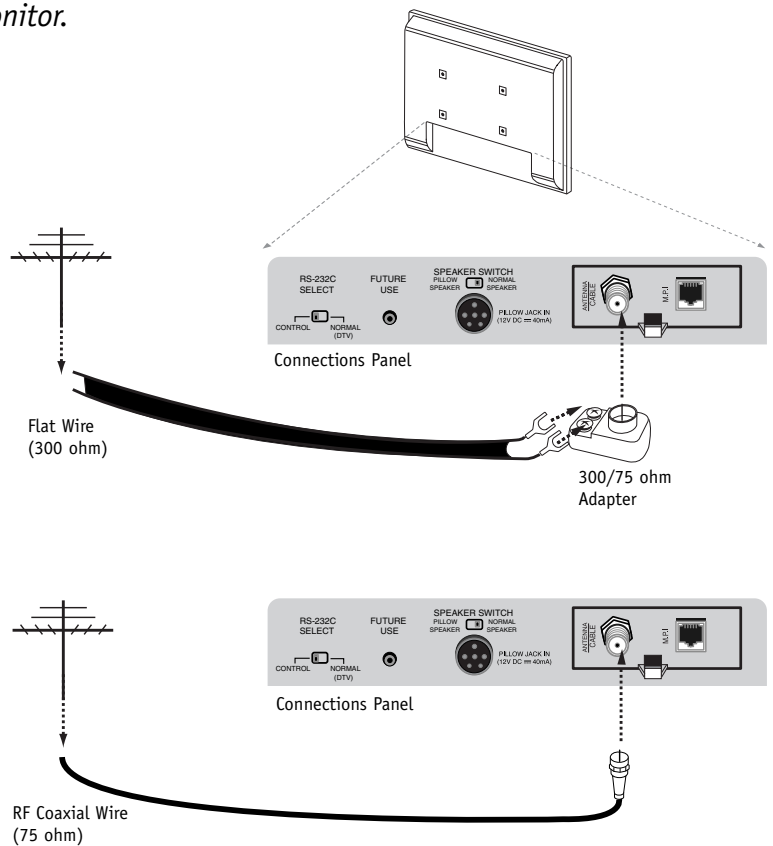

Mini glossary

75 OHM RF CABLE	The wire that comes from an off-air antenna or cable service provider. Each end looks like a hex shaped nut with a wire sticking through the middle, and it screws onto the threaded jack on the back of the TV.
300 TO 75 OHM ADAPTER	A small device that connects a two-wire 300 ohm antenna to a 75 ohm RF jack. They are usually about an inch long with two screws on one end and a round opening with a wire sticking out on the other end.

Cable Service Hookup

Connect cable service to the LCD TV/Monitor.

- 1** Locate the Antenna/Cable jack on the back of the TV.
- 2** Connect the cable wire to the Antenna/Cable jack according to one of the diagrams to the right.
- 3** After all connections are complete, plug in the TV. The LCD TV/Monitor is designed to operate on AC power.



For cable box operation, leave the television tuned to channel three or four and use the cable box to change channels.

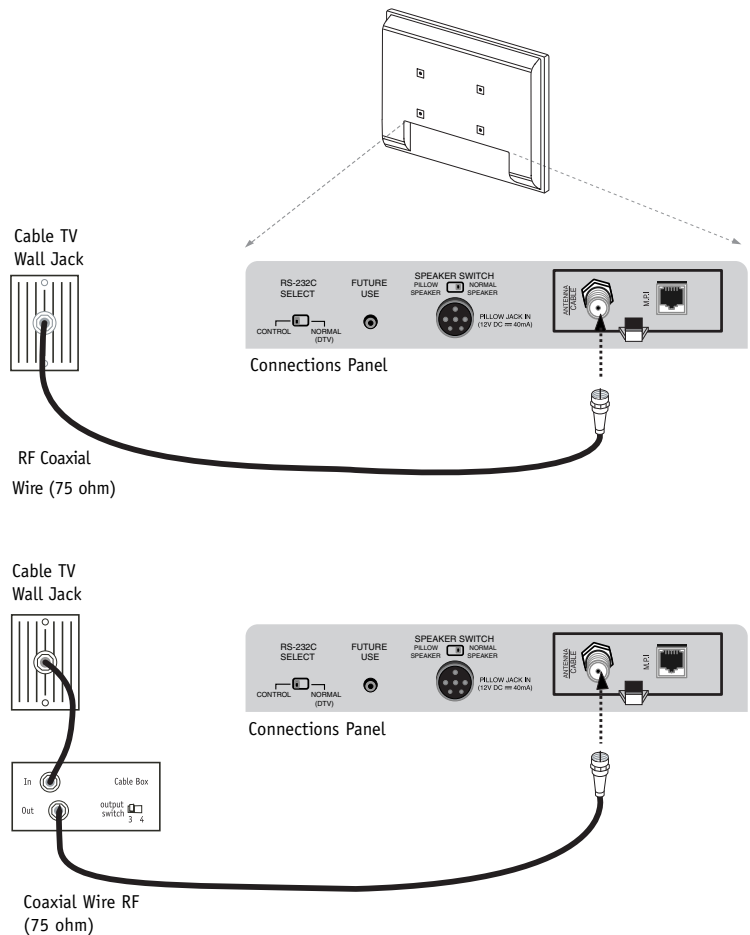

Mini glossary

75 OHM RF CABLE	The wire that comes from an off-air antenna or cable service provider. Each end looks like a hex shaped nut with a wire sticking through the middle, and it screws onto the threaded jack on the back of the TV.
300 TO 75 OHM ADAPTER	A small device that connects a two-wire 300 ohm antenna to a 75 ohm RF jack. They are usually about an inch long with two screws on one end and a round opening with a wire sticking out on the other end.

Antenna & VCR Hookup

Connect antenna and a VCR to the LCD TV/Monitor.

- 1 Locate the Antenna/Cable jack on the back of the VCR.
- 2 Connect the antenna wire that runs from the wall jack to the VCR. Connect other wires according to the diagram to the right.
- 3 After all connections are complete, plug in the TV. The LCD TV/Monitor is designed to operate on AC power.

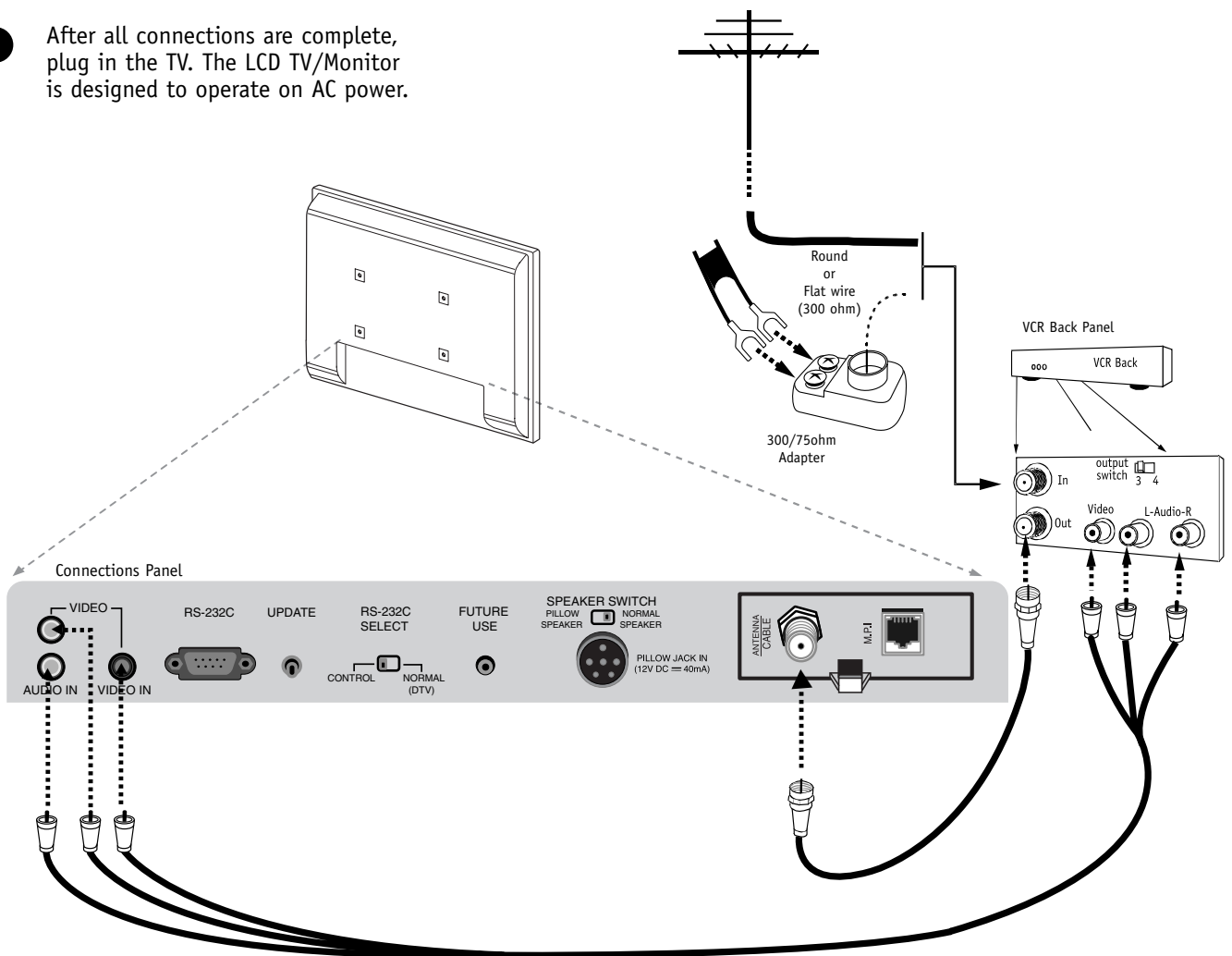

Cable Service with VCR Hookup

Connect cable service and a VCR to the LCD TV/Monitor.

- 1 Locate the Antenna/Cable jack on the back of the VCR.
- 2 Connect the cable service wire to the VCR. Connect other wires according to the diagram to the right.
- 3 After all connections are complete, plug in the TV. The LCD TV/Monitor is designed to operate on AC power.



For cable box operation, leave the VCR and the television tuned to channel three or four and use the cable box to change channels.

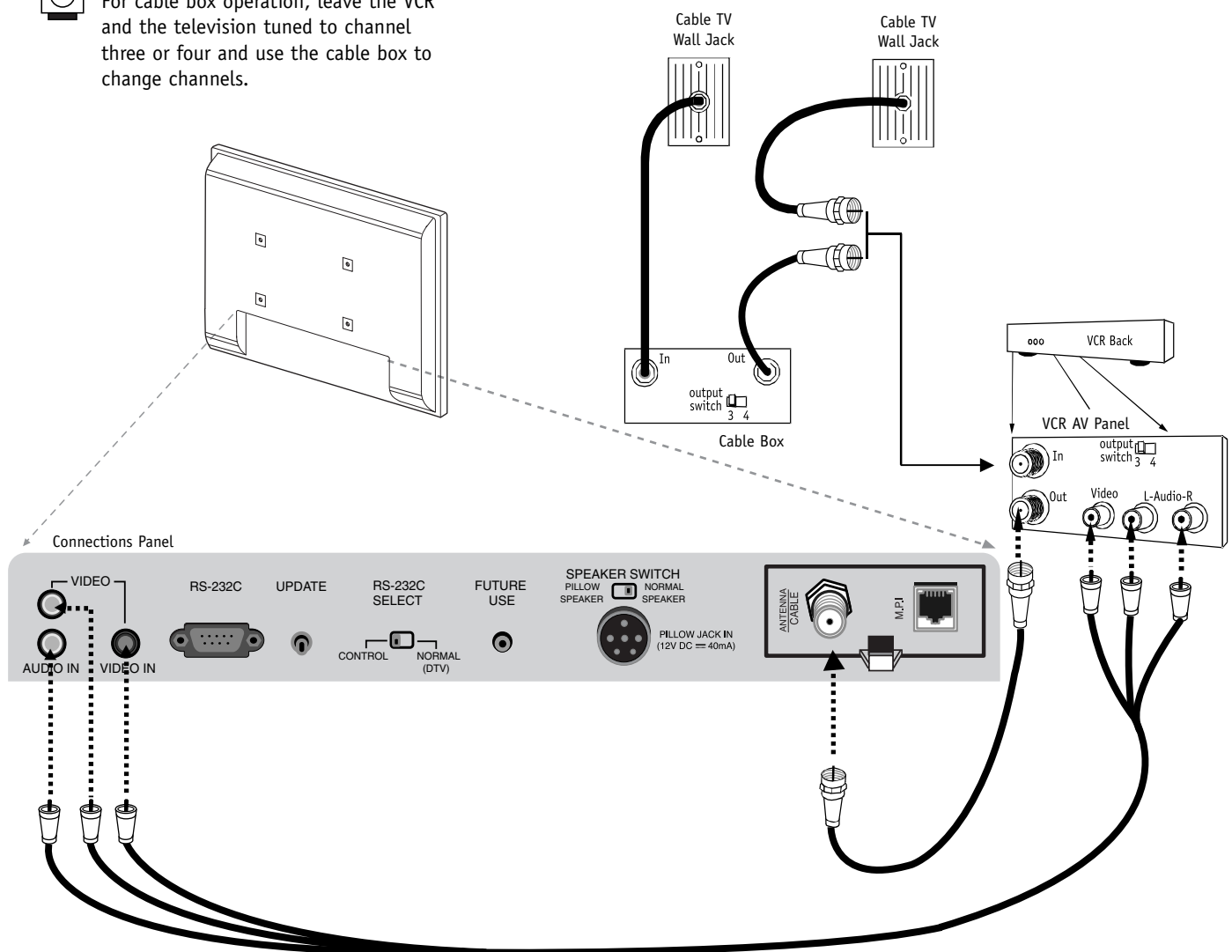

Pillow Speaker Hook Up

Connect a pillow speaker to the LCD TV/Monitor.

- 1** Locate the Pillow Speaker output jack on the back of the LCD TV/Monitor.
- 2** Connect an accessory pillow speaker or wired remote control unit to this 6-pin jack.
- 3** Select PILLOW SPEAKER on the rear panel of the LCD TV/Monitor.

***Notes:** If the pillow speaker switch is set to Pillow Speaker, no sound will be heard from the TV speakers. If pillow speaker switch is set to the Pillow Speaker position, Auto Volume will be grayed out and not accessible on the Sound menu.

Use a pillow speaker by Curbell, Model A-16455-02 or other UL recognized pendant control bearing the warning:

"Risk of fire if used in oxygen enriched atmosphere. Keep pendant control away from oxygen equipment."

Controlling the TV with Serial Data

The TV is capable of being controlled by a single-wire, serial data signal. This is a Zenith patented technology and is being implemented by certain brands of "smart" pillow speakers, such as Curbell's "GEN-II" models.

Pillow Speaker Interface

This connector furnishes three control lines and an audio output. A patient-pendant remote control, or entertainment audio and nurse call system may be connected here. All lines are isolated from the AC power line and earth ground. (Opto-isolators isolate the control lines, and a transformer isolates the audio. There are no relays or inductive components in the control lines.)

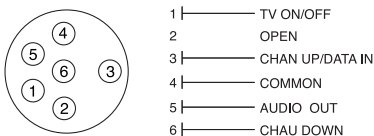

Pin No.	Purpose
1	External TV On/Off switch.
2	(Not used.)
3	External Channel Up switch or Data in.
4	Common connection for control, data, and audio output. Impedance to earth ground is a 10-meg resistor in parallel with a 1100 pF capacitor.
5	Isolated audio output. Nominal 14-ohm source impedance with short circuit protection. Intended for a pillow speaker with a low-impedance pad-type volume control.
6	External Channel Down switch.

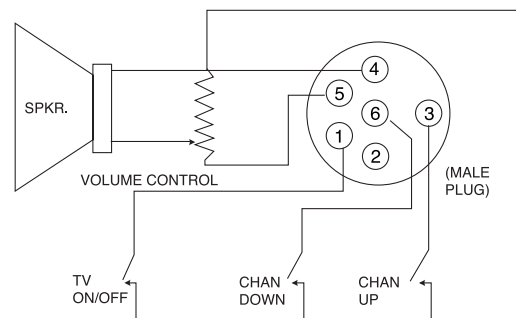
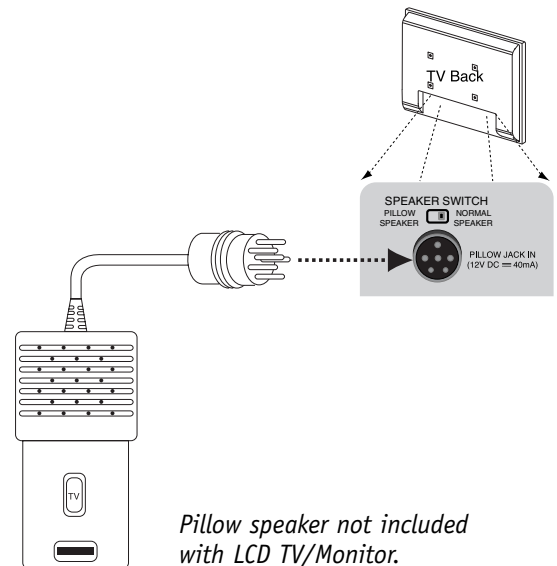

Controlling the TV with Mechanical Switches

Pin 4 (common) is momentarily connected to pin 1, 3, or 6 via push-action switches to control On/Off and Channel Up/Down. These pins are at +13 volts DC (when measured from pin 4) with the switches open. Current draw is 8 mA when a switch is closed. (This operation is identical to previous Zenith models using the 5-Wire Interface except that only +7 volts DC was supplied and current draw was only 2.5 mA.)

Power Cord Hookup

Connect the AC power cord directly to the LCD TV/Monitor.

AC Power Cord Hookup

The LCD TV/Monitor is designed to operate on 120V AC power.

1 Locate the AC Power Cord input socket on the back of the LCD TV/Monitor.

2 Insert the AC power cord connector into the AC Socket on the TV as shown below.

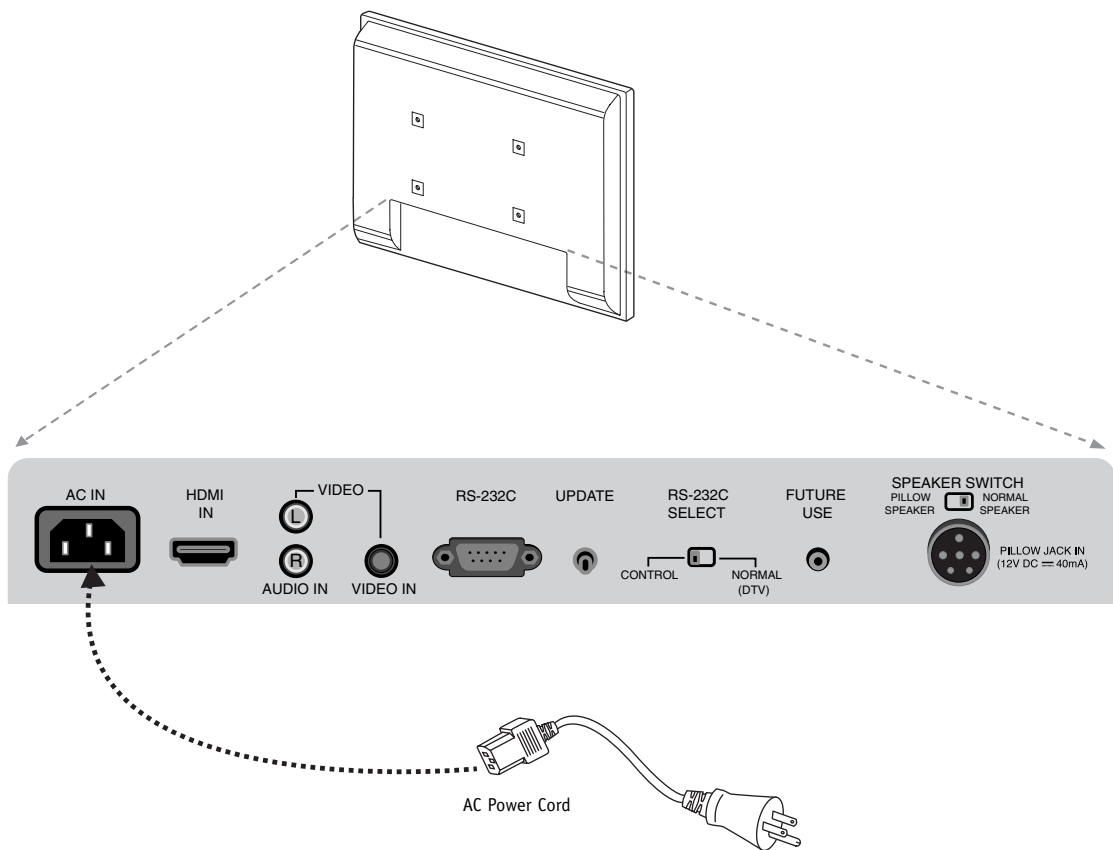

Front Panel Controls

Using the front control panel to operate the LCD TV/Monitor.

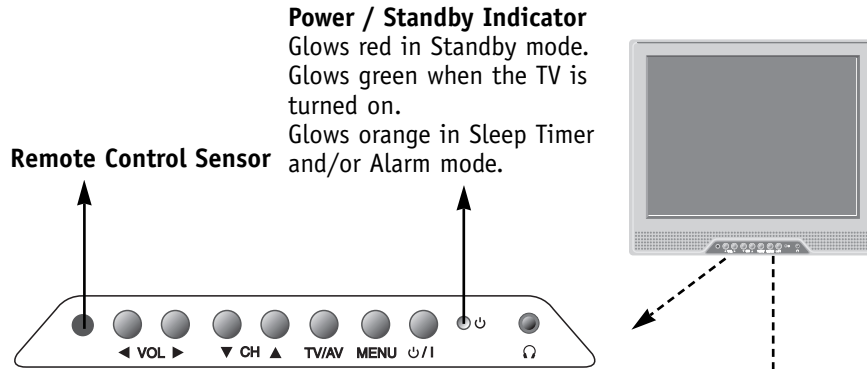

A TV Operation

Press the POWER button to turn the LCD TV/Monitor on from standby mode.

B Press MENU repeatedly to scroll through menus.

**Note: With Installer menu item 11 Key Defeat set to 000 (the default setting), Menu and TV/AV keys are disabled.*

C Displays the current channel bank. Press again to change banks.

D Use the CH (Channel) Up/Down button to cycle through the available channels.

E Use the VOL (Volume) Up/Down button to adjust the sound level to your preference.

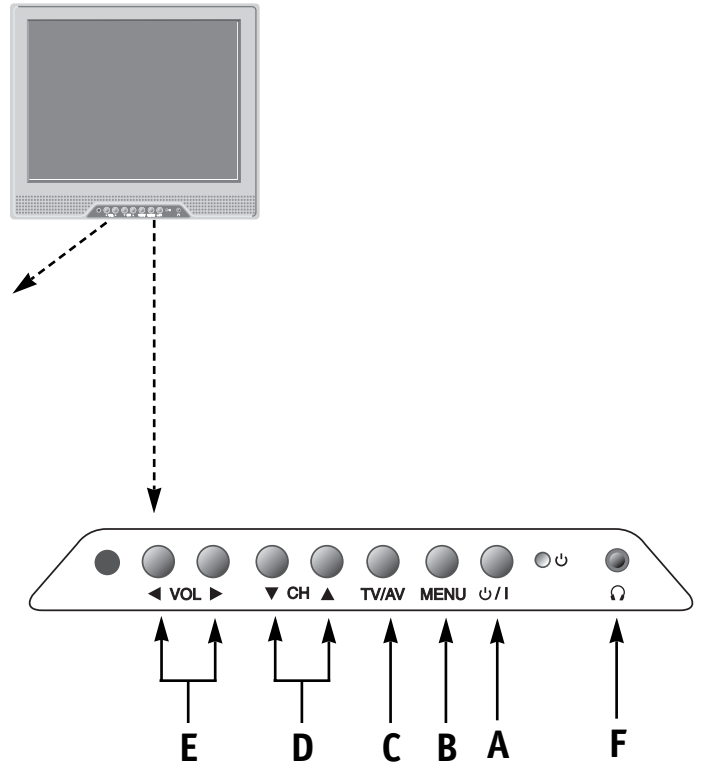

On-Screen Displays

See descriptions on page 18. On-screen displays will appear when the feature is active or the function is being used.

LED Color	Action/Status	
RED	Power is Off (Standby)	
GREEN is flashing	Power On sequence is processing	
GREEN	Power is On	
ORANGE	If Power is Off	On Timer is set or Alarm is set
	If Power is On	Off Timer is set or Sleep Timer is set

On-Screen Menus Overview

Descriptions of the menus and on-screen displays.

Menu Name	Page	Description
ON-SCREEN MENUS		
CHANNEL MENU		Adjusts the basic operational features of the TV.
Auto Program	21	Automatically finds and stores active channels to scroll through using Channel Up/Down.
Channel List	22	Manually picks and chooses which active channels will appear when using Channel Up/Down
Channel Label	23	Labels the channels with their network names (ABC, CBS, HBO, etc.).
Fine Tune		Automatically adjusts the picture for optimum appearance.
Signal Strength		Reveals the strength of the incoming digital signal.
SETUP MENU		
Time	24	Sets the time.
V-Chip	28	Sets up restrictions or changes the password for Parental Control.
Menu Language	27	Picks the language the on-screen menus will appear in.
Menu Transparency		Selects the degree of menu opacity.
Set ID		Specifies the TV's identity
CAPTION MENU	32	Chooses analog and digital captioning options.
SOUND MENU	34	Sets up the sound. Options are: Mode, Balance, Auto Volume, Multi-Track, Internal Speaker.
PICTURE MENU	36	Sets up the picture appearance. Options are: Mode, Color Temperature, Screen Format, Noise Reduction, Film Mode.
Channel Bank	38	Show currently selected channel bank.
18 OTHER MENUS AND ON-SCREEN DISPLAYS		
Volume		Shows current sound level.
Sleep Timer		Sets a time the TV will turn off.
SAP		Selects MTS sound: Mono, Stereo, and SAP in analog mode. Change the audio language in DTV mode.
Captions		Selects Caption/Text options.
Alarm		Set a time for the TV to turn itself on.
Guide		View DTV program information.
Channel Preview -> V-Chip		Displays the available TV channels and guest's Parental Control menu.
Info		Shows program details: Title, Broadcast Time, Signal Format, Signal Strength, CC, V-Chip, Language, Sound Format, Time, Date, Channel Icon, Channel Label.
INSTALLER MENUS		
Installer Menus	41	Makes adjustments to the TV's operational features.

Other Menus & On-Screen Displays

Use the remote keys indicated below to access these menus and displays. In this manual, the OSD (On Screen Displays shown) may be different. The following are just generic examples to familiarize you with the TV's options.

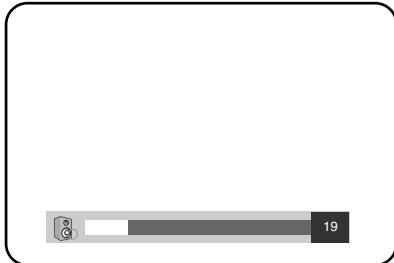

Volume Display

Press VOLUME.
Shows currently selected sound setting.

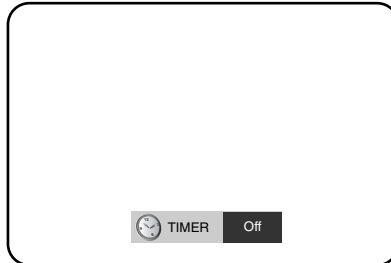

Sleep Timer Menu

Press TIMER.
Sets a time to automatically turn the TV off and shows remaining time before TV shutoff.



SAP Display

Selects MTS sound: Mono, Stereo, and SAP in analog mode. Change the audio language in DTV mode.



Caption Display

Press the CC.
Turns selected option on or off. See Closed Captions page to select options.

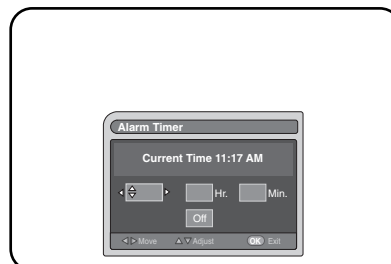

Alarm Display

Press the ALARM.
Set a time for the TV to turn itself on.

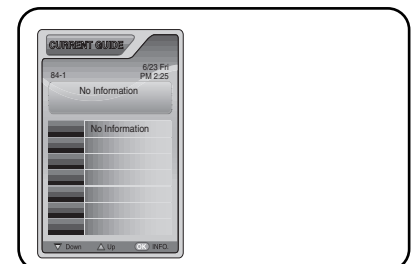

Guide Display

Press the GUIDE to view DTV program information.

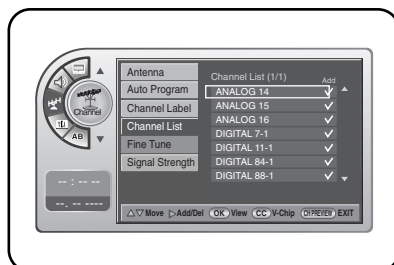

Channel Preview

Press the CH PREVIEW.
Displays available TV channels.

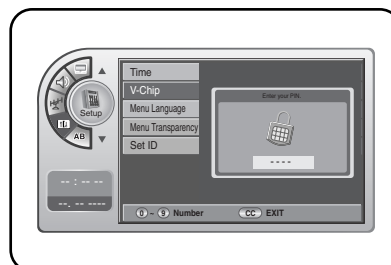

V-Chip

Press the CC.
Move to the V-Chip menu.

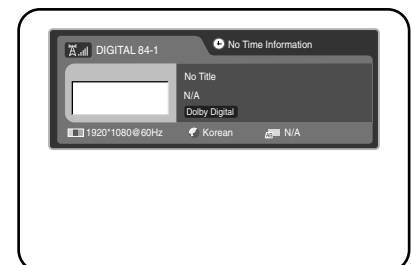

INFO

Press the INFO.
Check the current program information.

User Remote Control Key Functions

A brief list of the keys on the optional patient remote control and what they do.

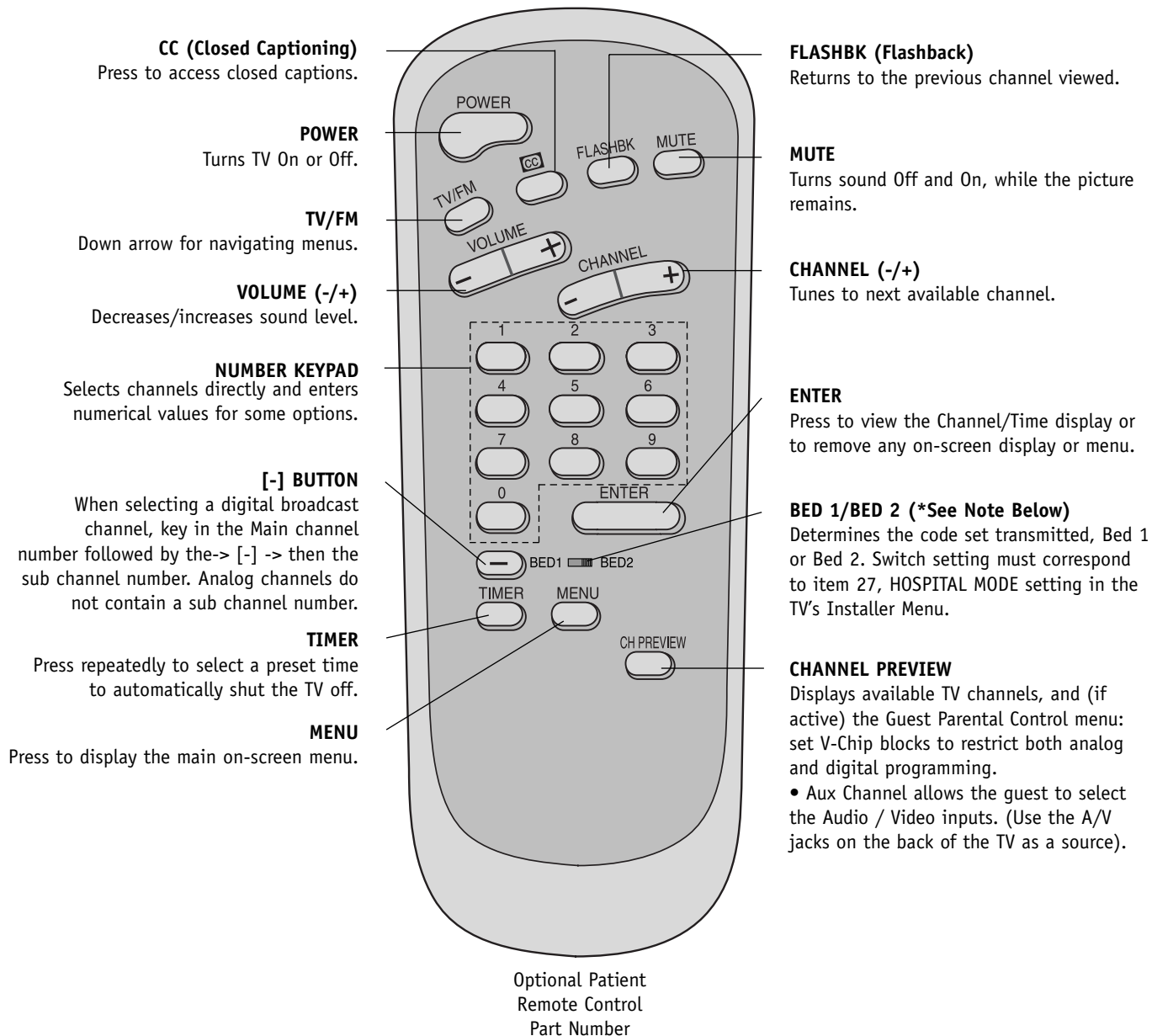

***Note:** Bed 1 - Bed 2 switch on patient remote. The position of the Bed 1 - Bed 2 switch must correspond to the setting in the Installer's menu. The switch above can be set by sliding it to the Bed 1 or Bed 2 position. On the patient's remote, the Bed 1 or Bed 2 position can be selected by using a paper clip or a ball-point pen to slide the switch to the correct position.
 Left position = Bed 1.
 Right Position = Bed 2.

Installer Remote Control Key Functions

A brief list of the keys on the optional installer's remote and what they do.

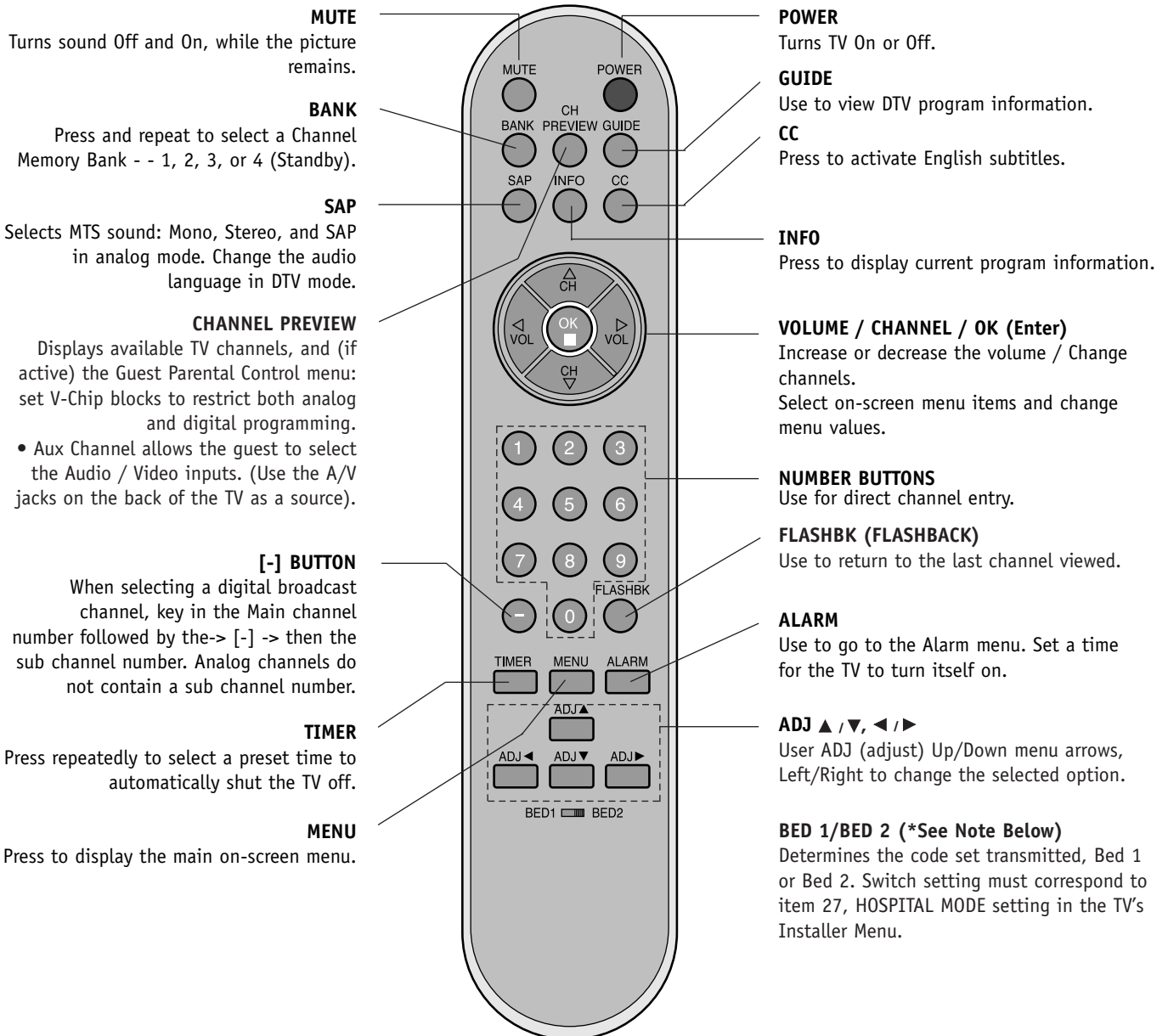

Optional Installer
Remote Control
Part Number
31400SKZ003AR6

***Note:** Bed 1 - Bed 2 switch on patient remote. The position of the Bed 1 - Bed 2 switch must correspond to the setting in the Installer's menu. The switch above can be set by sliding it to the Bed 1 or Bed 2 position. On the patient's remote, the Bed 1 or Bed 2 position can be selected by using a paper clip or a ball-point pen to slide the switch to the correct position.

Left position = Bed 1.
Right Position = Bed 2.

Auto Program (Channel Search)

Use Auto Program to automatically find and store all of the channels available in the selected Tuning Band.

***Note:** Tuning Band must be set before doing the channel search. See Installer menu item 003 Band/AFC. Default setting is 1, for CATV. When Auto Program is run, any assigned channel labels are automatically removed.

- 1 With the optional Installer remote control in hand, press the **POWER** key to turn the TV on.
- 2 Press the **MENU** button and then use the **ADJ ▲ / ▼** button to select the Channel menu.
- 3 Press the **OK (Enter)** button.
- 4 With Auto Program highlighted, press the **OK (Enter)** button.
- 5 Press the **OK (Enter)** button to start the channel search. After finding all available channels, a display appears briefly showing the number of analog and digital channels found.
- 6 Press the **MENU** button to remove the menus.



Auto Program finds channels being received by the TV's analog and digital tuners.



Cable will not work unless you subscribe to a cable service.

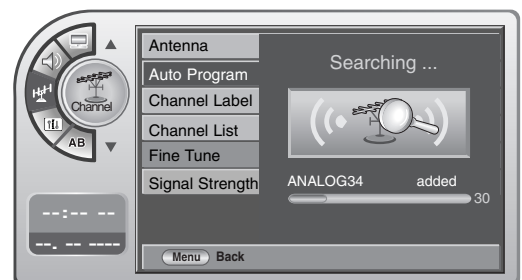
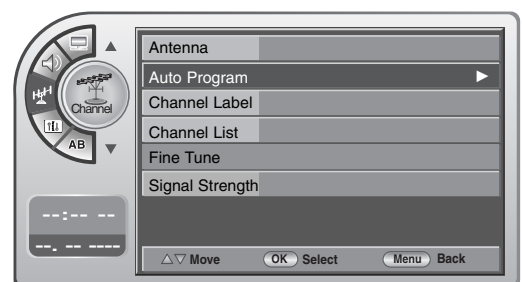

Channel List

After the channel search, remove unwanted channels.

Removing unwanted channels

Review the channels found, you may remove unwanted channels.

- 1 Press the **MENU** button. Then use the **ADJ ▲ / ▼** button to select the Channel menu, then press the **OK (Enter)** button.
- 2 Use the **ADJ ▲ / ▼** button to highlight Channel List, then press the **OK (Enter)** button.
- 3 Use the **ADJ ▲ / ▼** button to highlight the channel you wish to delete, then press the **ADJ ►** Right arrow button. The right arrow toggles the check mark on and off. If the check mark appears next to the channel number, the channel appears in the channel scan.
- 4 Press the **MENU** button repeatedly to remove the menus.



If you delete a found channel, it isn't gone forever. Simply re-enter the Channel List menu and re-add the channel to show the check mark.

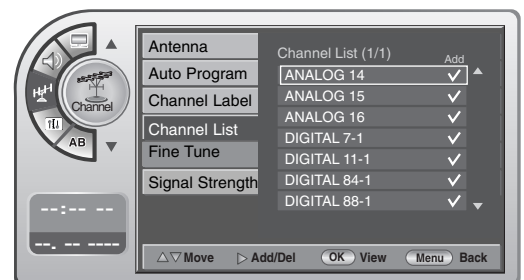
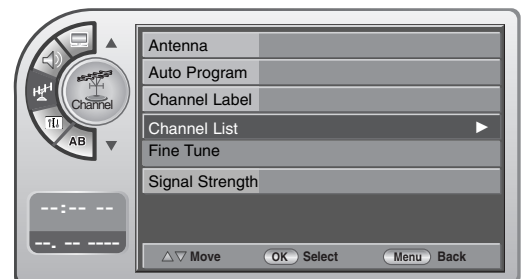

Channel Labels Setup

***Note:** If you add channel labels to existing channels, then re-run Auto Program, the labels will all be deleted.

Channel Labels Setup

Channel Labels help the user identify the channel or network being viewed. In the Setup menu with the Channel Labels option highlighted, use the ADJ Left/Right arrow to scroll through the available channel labels, such as, A&E, AMC, ESPN, HBO, etc. These are a series of preset labels from which you can choose the more common networks. Use any of these to label the channels in the TV's memory.

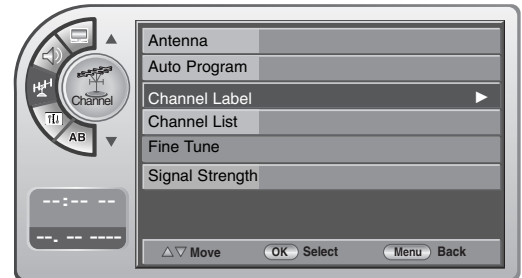

Operating the Channel Label Menu

- 1 Press the **MENU** button and then use the **ADJ ▲ / ▼** button to select the Channel menu. Press the **OK (Enter)** button.
- 2 Use the **ADJ ▲ / ▼** button to highlight Channel Labels, then press the **OK (Enter)** button. This action displays the Channel Labels menu.
- 3 Use Channel Up/Down to select channels and the Up/Down Left/Right ADJ arrow buttons to navigate the labels menu.
- 4 When the label is highlighted you want for the channel shown in the screen, press **OK (Enter)** to add the label to the channel.
- 5 Select the next channel to label with Channel Up/Down or if finished channel labeling, press Menu repeatedly to remove menus.



Clock Setup

Manual Time Settings

- Use the ▲ / ▼ / ◀ / ▶ **ADJ** buttons to set the year, month, day, hours and minutes.

- 1 Press the **MENU** button and then use the **ADJ** ▲ / ▼ button to highlight the Setup menu.
- 2 Press the **OK (Enter)** button to highlight Time.
- 3 Press the **OK (Enter)** button to highlight Clock. Manual or Auto will appear on the menu next to clock. If manual is selected, on the menu use the Down arrow to highlight Manual and press the **OK (Enter)** button.
- 4 Use the **ADJ** Left/Right arrows to choose the menu options and the Up/Down arrows to set the options.
- 5 When finished setting the clock, press Menu repeatedly to remove the menus.

On-Off Timers Setup

Set the *On-Off Timers* using the procedures described above.

***Note:** If you intend to use the *On-Off Timers*, it is best to set the clock manually.

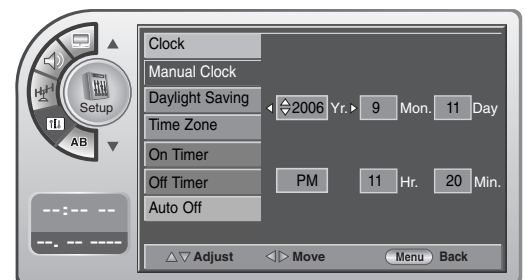
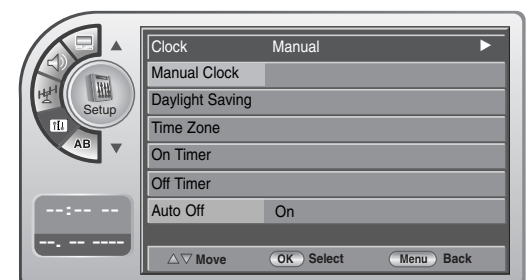
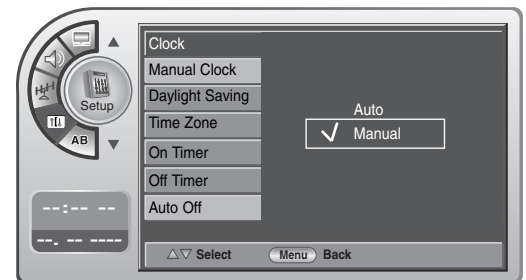
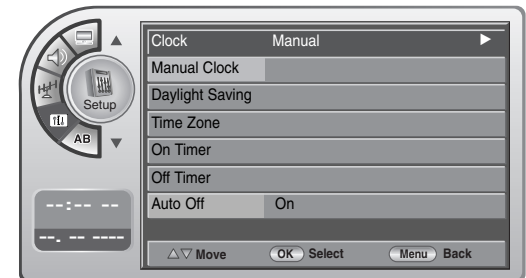

Clock Setup (Continued)

Automatic Time Settings

- If you select auto time setting, time will be set from the digital broadcast information.

- 1 Press the **MENU** button and then use the **ADJ ▲ / ▼** button to highlight the Setup menu.
- 2 Press the **OK (Enter)** button to highlight Time.
- 3 Press the **OK (Enter)** button to highlight Clock. Manual or Auto will appear on the menu next to clock. Select Auto on the submenu with the Down arrow and press the **OK (Enter)** button.
- 4 Use the ADJ Up/Down/Left/Right arrows to set the Daylight Savings and Time Zone options for your local area. See the next page.
- 5 When finished setting the clock, press **MENU** repeatedly to remove the menus.



Caution: Some digital channels may change the time incorrectly using the Automatic Clock Set feature.

In this event, the Alarm may not function as intended and the TV may not turn on at the expected time.

If the end user will have access to the Alarm, it may be best to use the Manual Clock Set mode and set the clock to local time manually.

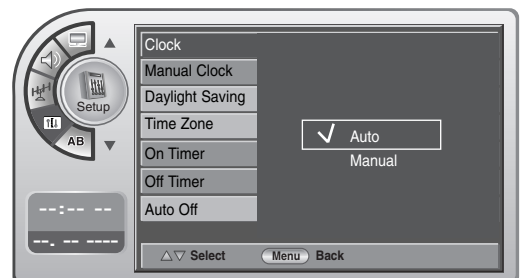
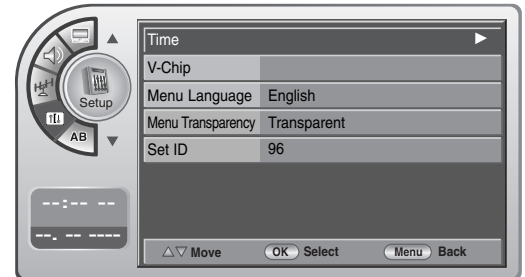

Mini glossary

TIME	A four-digit figure broken down into hours and minutes, used to enter the current time when setting the clock or wake-up alarm.
HOURS	First two digits that are entered when setting the clock or the wake-up alarm.
MINUTES	The last two digits that are entered when setting the clock, or the wake-up alarm.

Clock Setup (Continued)

Daylight Saving

Installer can elect to use Daylight Savings to adjust the clock time. This is operated from the Automatic Time Settings.

- 1 Press the **MENU** button and then use the **ADJ ▲ / ▼** button to highlight the Setup men.
- 2 Press the **OK (Enter)** button to highlight Time.
- 3 Press the **OK (Enter)** button to highlight Clock. Manual or Auto will appear on the menu next to clock. Select Auto on the submenu with the Down arrow and press the **OK (Enter)** button.
- 4 Use the ADJ Up/Down/Left/Right arrows to highlight and set the Daylight Savings options: On=Yes or Off=No for your local area.
- 5 When finished, press Menu repeatedly to remove the menus.

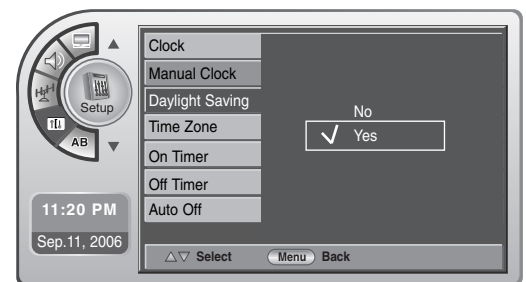
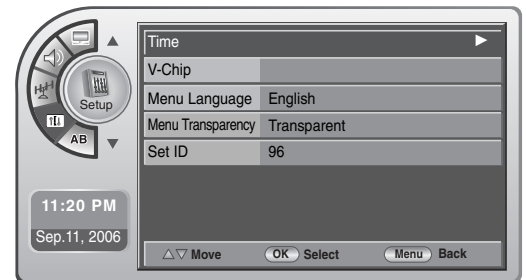

Time Zone Settings

Installer can set the Time Zone.

- 1 Press the **MENU** button and then use the **ADJ ▲ / ▼** button to highlight the Setup menu.
- 2 Press the **OK (Enter)** button to highlight Time.
- 3 Press the **OK (Enter)** button to highlight Clock. Manual or Auto will appear on the menu next to clock. Select Auto on the submenu with the Down arrow and press the **OK (Enter)** button.
- 4 Use the ADJ Up/Down/Left/Right arrows to highlight and set the Time Zone for your local area.
- 5 Use the **ADJ ◀ / ▶** button to select the time zone, then press the **ENTER** button.
- 6 When finished, press Menu repeatedly to remove the menus.

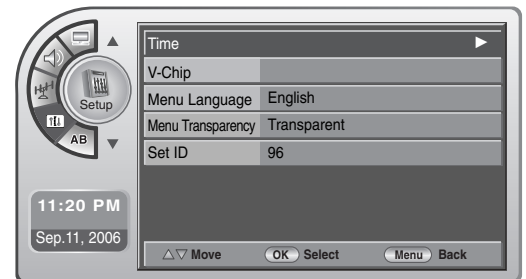

Menu Language

Choose a language for the on-screen menus.

- 1 Press the **MENU** button and then use the **ADJ ▲ / ▼** button to highlight the Setup menu.
- 2 Press the **OK (Enter)** button.
- 3 Use the Down ADJ arrow to highlight Menu Language and press the **OK (Enter)** button.
- 4 Use the ADJ Up/Down/Left/Right arrows to highlight and set the Menu Language: English, Spanish or French.
- 5 Press the **MENU** repeatedly to remove the menus.

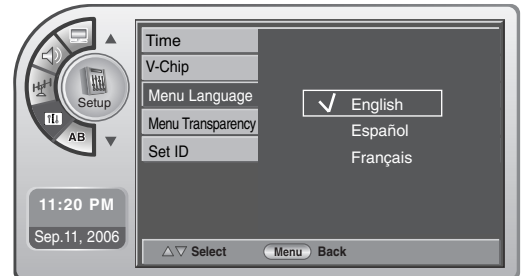
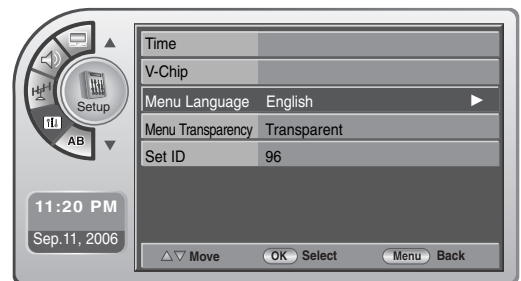
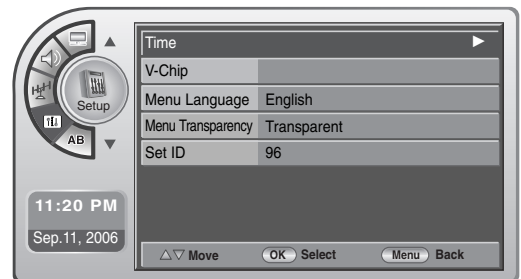

V-Chip

Entering a PIN (Password)

-This option sets up or changes the password for blocking program ratings.

- 1 Press the **MENU** button and then use the **ADJ ▲ / ▼** button to highlight the Setup menu.
- 2 Press the **OK (Enter)** button.
- 3 Use the Down ADJ arrow to highlight V-Chip and press the **OK (Enter)** button.
- 4 If a password has been entered, key it in using the number keypad.
If no password has been set, enter a 4-digit password (0~9) using the remote control. This is the PIN. Each time the menu is entered, the password will be required until the block time expires. The TV is set up with the default password "0-0-0-0".
- 5 Press the **MENU** button several times to remove the menus.



If you ever forget your password, key in '7', '7', '7', '7' on the remote control.

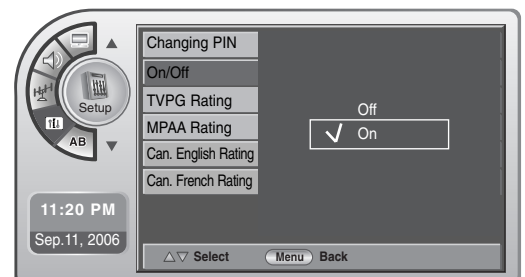
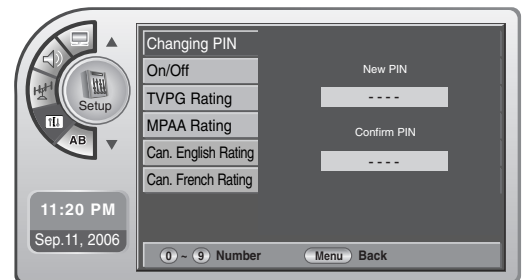
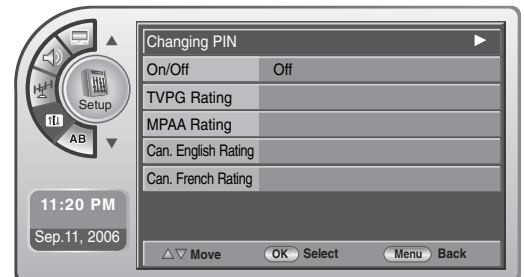
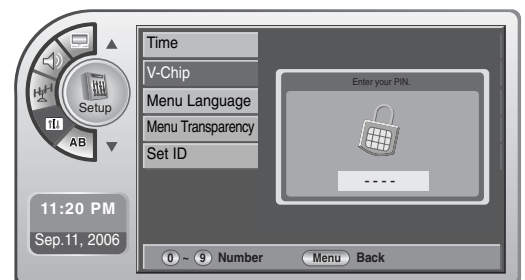
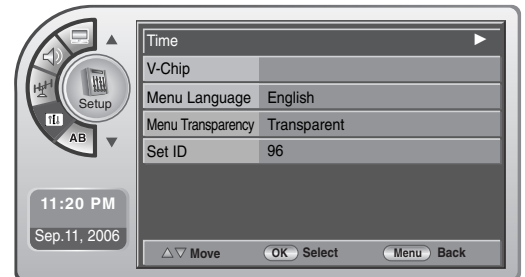

V-Chip (Continued)

TVPG Ratings

-You can block programs based on the TV program rating.

- 1 Press the **MENU** button and then use the **ADJ ▲ / ▼** button to highlight the Setup menu.
- 2 Press the **OK (Enter)** button.
- 3 Use the Down ADJ arrow to highlight V-Chip and press the **OK (Enter)** button.
- 4 Use the Up/Down/Left/Right arrows buttons to choose and set up the menu options for TVPG Rating.
- 5 Press the **MENU** button several times to remove the menus.

Description of the TV (FCC) Rating Codes:

TV (FCC) Age Categories

TV-MA

Mature audiences only. This program may contain mature themes, profane language, graphic violence and explicit sexual content.

TV-14

Parents strongly cautioned. This program may contain sophisticated themes, sexual content, strong language and more intense violence.

TV-PG

Parental guidance suggested. The program may contain infrequent coarse language, limited violence, some suggestive sexual dialog and situations.

TV-G

General audience. This contains little or no violence, no strong language, and little or no sexual dialog or situations.

TV-Y7

Directed for older children. Themes and elements in this program may include mild physical or comedic violence, or may frighten children under the age of seven.

TV-Y

All children. The themes and elements in this program are specifically designed for a very young audience, including children from ages two – six.

TV (FCC) Content Sub-Categories:

V Violence.

S Sexual content.

L Offensive language.

D Dialog...sexual innuendo.

FV Fantasy or cartoon violence.

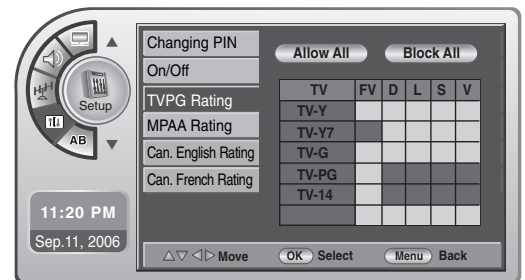
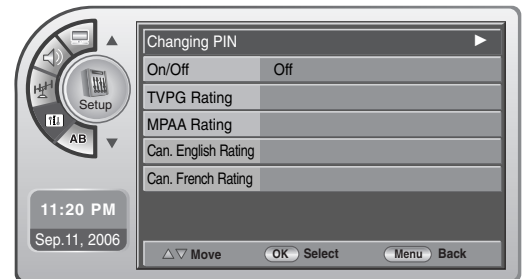
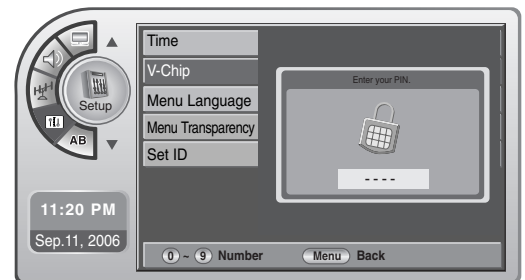
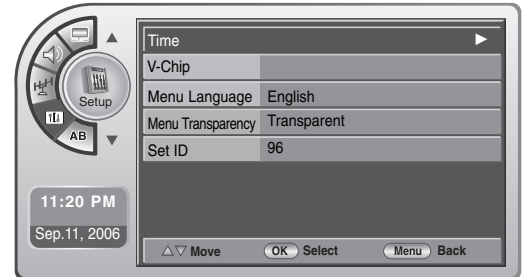

V-Chip (Continued)

MPAA Ratings

-Restricting movies by their rating.

- 1** Press the **MENU** button and then use the **ADJ ▲ / ▼** button to highlight the Setup menu.
- 2** Press the **OK (Enter)** button.
- 3** Use the Down ADJ arrow to highlight V-Chip and press the **OK (Enter)** button.
- 4** Use the Up/Down/Left/Right arrows buttons to choose and set up the menu options for MPAA Rating.
- 5** Press the **MENU** button several times to remove the menus.

Description of the MPAA and TV (FCC) Rating Codes:

The MPAA Rating System (Movies)

G General Audience. No restrictions.

PG Children under 13 should be accompanied by an adult.

PG-13 Parental guidance suggested. Children under 13 should be accompanied by an adult.

R Restricted. Viewers should be 17 or older.

NC-17 Not classified. Viewers should be 17 or older.

X Adults only.

- MPAA ratings: The selected rating will be locked. In addition, any ratings that are more restrictive will also be blocked.

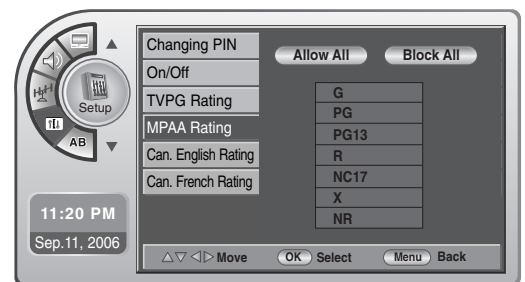
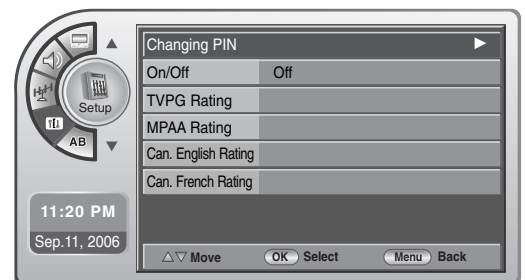
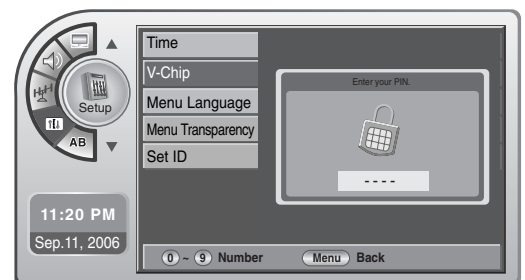

V-Chip (Continued)

Canadian English Ratings

- 1 Press the **MENU** button and then use the **ADJ ▲ / ▼** button to highlight the Setup menu.
- 2 Press the **OK (Enter)** button.
- 3 Use the Down ADJ arrow to highlight V-Chip and press the **OK (Enter)** button.
- 4 Use the Up/Down/Left/Right arrows buttons to choose and set up the menu options for Canadian English Rating.
- 5 Press the **MENU** button several times to remove the menus.

Canadian English Ratings

E Expect No restriction.
C Children
C8+ Viewers should be 8 or older.
G General Audience.
PG Parental guidance suggested. Children under 14 should be accompanied by an adult.
14+ Restricted. Viewers should be 14 or older.
18+ Restricted. Viewers should be 18 or older.

Canadian French Ratings

- 1 Press the **MENU** button and then use the **ADJ ▲ / ▼** button to highlight the Setup menu.
- 2 Press the **OK (Enter)** button.
- 3 Use the Down ADJ arrow to highlight V-Chip and press the **OK (Enter)** button.
- 4 Use the Up/Down/Left/Right arrows buttons to choose and set up the menu options for Canadian French Rating.
- 5 Press the **MENU** button several times to remove the menus.

Canadian French Ratings

E Expect No restriction.
G For all
8+ Restricted. Viewers should be 8 or older.
13+ Restricted. Viewers should be 13 or older.
16+ Restricted. Viewers should be 16 or older.
18+ Restricted. Viewers should be 18 or older.

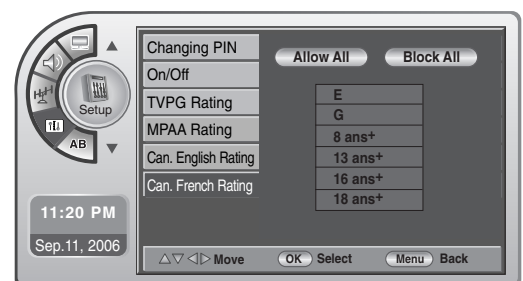
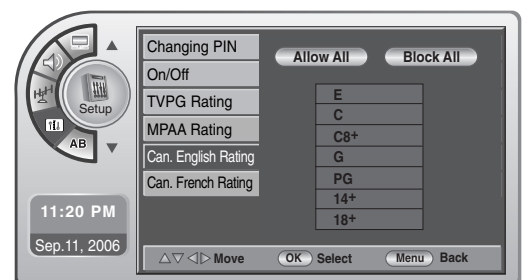
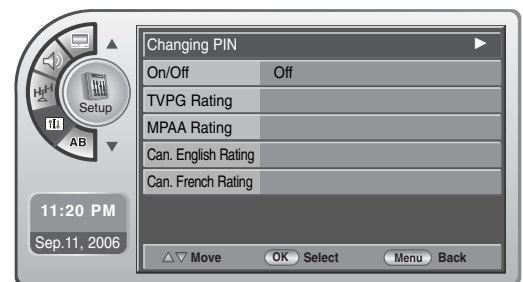
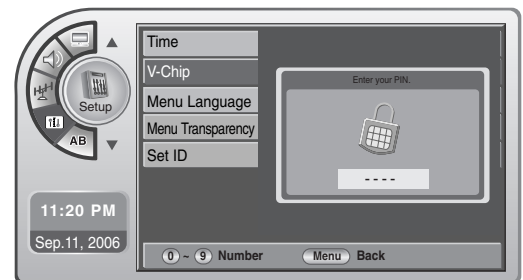
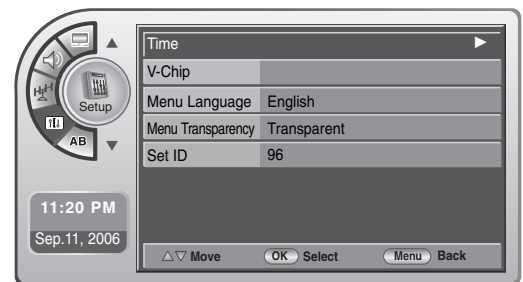

Caption Menu

Turn Captions On/Off

**Note: Pressing CC on the remote to select a captions option will also turn closed captions on.*

- 1 Press the **MENU** button and then use the **ADJ ▲ / ▼** button to highlight the Caption menu.
- 2 Press the **OK (Enter)** button.
- 3 Use the Down ADJ arrow to highlight On or Off and press the **OK (Enter)** button.
- 4 Press the **MENU** button several times to remove the menus.

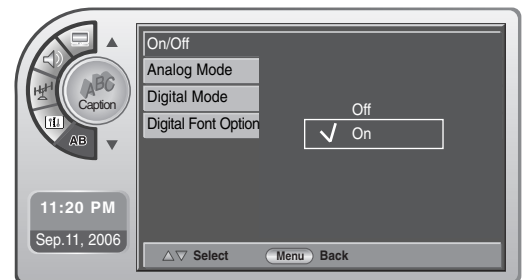
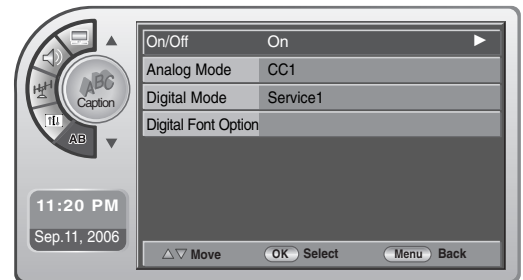

Analog Mode

- Analog Captions will display on the screen whether the signal is from an RF channel or external equipment input.

**Note: Pressing CC on the remote selects a captions option.*

- 1 Press the **MENU** button and then use the **ADJ ▲ / ▼** button to highlight the Caption menu.
- 2 Press the **OK (Enter)** button.
- 3 Use the Down ADJ arrow to highlight Analog Mode and press the **OK (Enter)** button.
- 4 Use the **▲ / ▼ / ◀ / ▶** ADJ buttons to choose CC1~TEXT4.
- 5 Press the **OK (Enter)** button.
- 6 Press the **MENU** button several times to remove the menus.

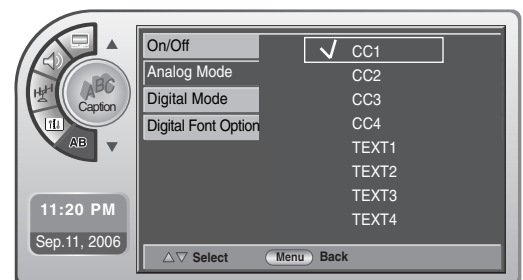
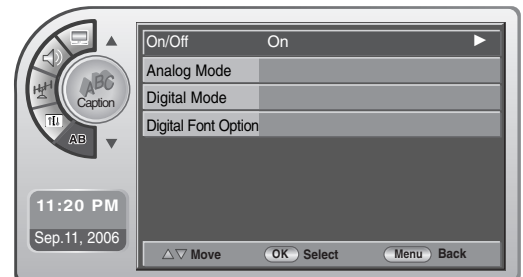

Mini glossary

CAPTIONS	The term for the words that scroll across the bottom of the TV screen; usually the audio portion of the program provided for the hearing impaired.
TEXT	The term for the words that appear in a large black frame and almost cover the entire screen; usually messages provided by the broadcaster.

Caption Menu (Continued)

Digital Captions Mode

- Digital Captions only appear on digital channels, tune in a digital channel that is actually broadcasting digital captions.

***Note:** Pressing CC on the remote selects a captions option.

- 1 Press the **MENU** button and then use the **ADJ ▲ / ▼** button to highlight the Caption menu.
- 2 Press the **OK (Enter)** button.
- 3 Use the Down ADJ arrow to highlight Digital Mode and press the **OK (Enter)** button.
- 4 Use the **▲ / ▼ / ◀ / ▶** ADJ buttons to choose Service 1~ Service 6.
- 5 Press the **OK (Enter)** button.
- 6 Press the **MENU** button several times to remove the menus.

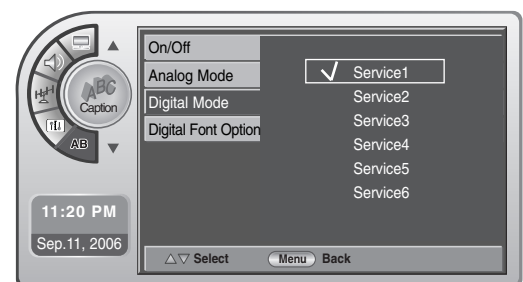
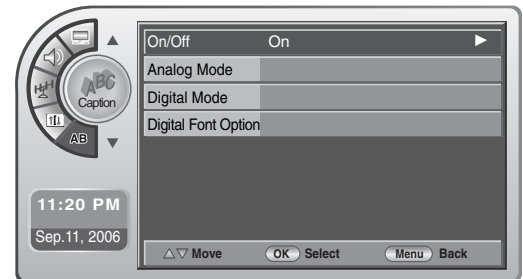

Digital Font Options

- 1 Press the **MENU** button and then use the **ADJ ▲ / ▼** button to highlight the Caption menu..
- 2 Press the **OK (Enter)** button.
- 3 Use the Down ADJ arrow to highlight Digital Font Options and press the **OK (Enter)** button.
- 4 Use the **▲ / ▼ / ◀ / ▶** ADJ buttons to customize each option: Font Size, Font Style, Foreground Color etc.
- 5 When finished, press the **MENU** button several times to remove the menus.

***Note:** If the digital options custom settings are to be cloned, all menu options should be set to any option other than Default. If Default is left set for any one option, then all the options will be reset to default after cloning.

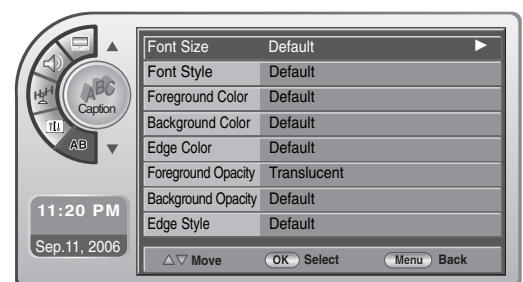
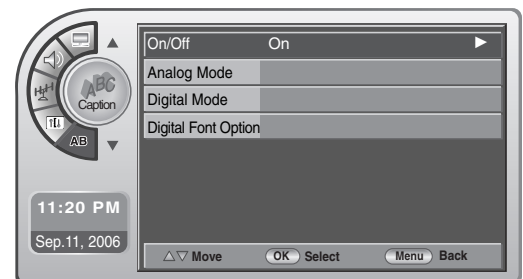

Sound Menu

Set up the audio options for the end user

Sound Mode Setup

- Match the sound mode to the program's character, Music, Movie, Sports, or News.

- 1 Press the **MENU** button and then use the **ADJ ▲ / ▼** button to highlight the Sound menu.
- 2 Press the **OK (Enter)** button.
- 3 With Mode highlighted, press the **OK (Enter)** button.
- 4 Use the **▲ / ▼ / ◀ / ▶ ADJ** buttons to customize each option: or choose a preset mode like Music, Movie, etc.
- 5 When finished, press the **MENU** button several times to remove the menus.

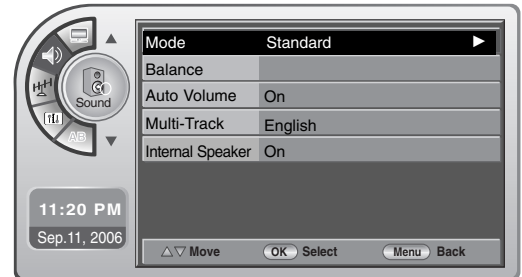

Sound Balance Setup

- Adjust the speaker balance for optimum sound quality.

- 1 Press the **MENU** button and then use the **ADJ ▲ / ▼** button to highlight the Sound menu.
- 2 Press the **OK (Enter)** button.
- 3 Use the Up/Down arrow button to highlight Balance, press the **OK (Enter)** button.
- 4 Use the **◀ / ▶ ADJ** buttons to move the sound more to the Left or Right.
- 5 When finished, press the **MENU** button several times to remove the menus.

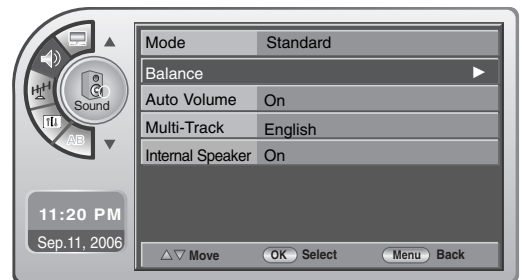

Automatic Volume Control Settings

- Have the TV automatically maintain the sound level between different channels.

- 1 Press the **MENU** button and then use the **ADJ ▲ / ▼** button to highlight the Sound menu.
- 2 Press the **OK (Enter)** button.
- 3 Use the Up/Down arrow button to highlight Auto Volume, press the **OK (Enter)** button.
- 4 Use the **◀ / ▶ ADJ** buttons to choose On or Off.
- 5 Press the **MENU** button several times to remove the menus.

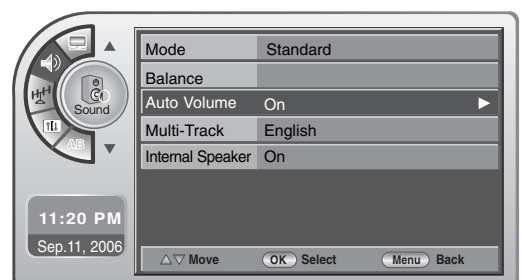

<Dolby Digital>



This product is under license of Dolby Laboratories.
The "Dolby" or D symbol is a trademark of Dolby Laboratories.

Sound Menu (Continued)

Digital Audio Language Settings

- You can set digital audio language.

- 1 Press the **MENU** button and then use the **ADJ ▲ / ▼** button to highlight the Sound menu.
- 2 Press the **OK (Enter)** button.
- 3 Use the Up/Down arrow button to highlight Multi-Track, press the **OK (Enter)** button.
- 4 Use the **◀ / ▶ ADJ** buttons to choose English, Spanish or French press the **OK (Enter)** button.
- 5 Press the **MENU** button several times to remove the menus.

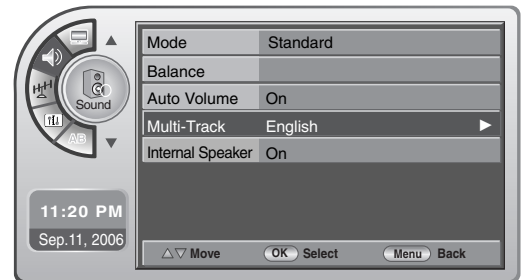

Using External Speakers

- Set the internal speaker to Off to listen to the TV through an external audio system, the TV sound will not be heard.

- 1 Press the **MENU** button and then use the **ADJ ▲ / ▼** button to highlight the Sound menu.
- 2 Press the **OK (Enter)** button.
- 3 Use the Up/Down arrow button to highlight Internal Speaker, press the **OK (Enter)** button.
- 4 Use the **◀ / ▶ ADJ** buttons to choose English, On or Off press the **OK (Enter)** button.
- 5 Press the **MENU** button several times to remove the menus.

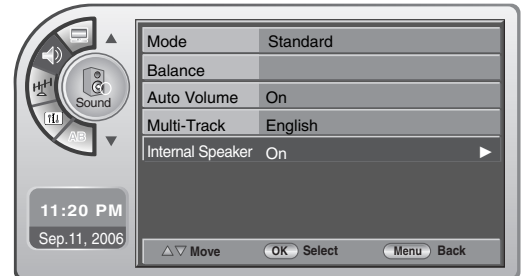

Picture Menu

Picture Mode Setup

- Set the picture mode to the program content, e.g. Dynamic or Mild etc.

- 1 Press the **MENU** button and then use the **ADJ ▲ / ▼** button to highlight the Picture menu.
- 2 Press the **OK (Enter)** button.
- 3 Use the Up/Down arrow button to highlight Mode, press the **OK (Enter)** button.
- 4 Use the **◀ / ▶ ADJ** buttons to choose a preset picture setup. When finished, press the **OK (Enter)** button.
- 5 Press the **MENU** button several times to remove the menus.

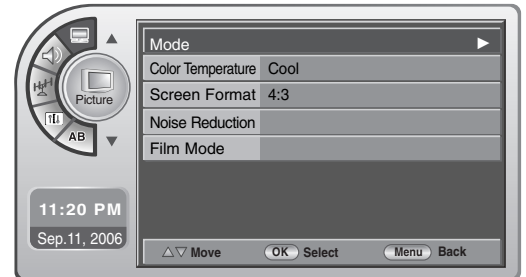

Custom Color Setup

- Use the Manual settings for the best presentation of movies.
The patient will then be able to view movies with more realism.

To make custom picture settings, set the Mode to Manual on the menu.

- 1 Press the **MENU** button and then use the **ADJ ▲ / ▼** button to highlight the Picture menu.
- 2 Press the **OK (Enter)** button.
- 3 Use the Up/Down arrow button to highlight Mode, press the **OK (Enter)** button.
- 4 Use the **◀ / ▶ ADJ** buttons to choose Manual and use Up/Down/Left/Right arrow buttons to set your own settings for the options. When finished, press the **OK (Enter)** button.
- 5 Press the **MENU** button several times to remove the menus.

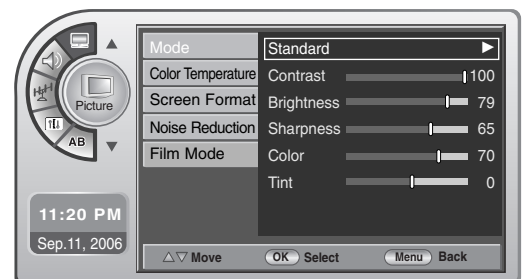

Picture Menu (Continued)

Color Temperature Settings

- 1 Press the **MENU** button and then use the **ADJ ▲ / ▼** button to highlight the Picture menu.
- 2 Press the **OK (Enter)** button.
- 3 Use the Up/Down arrow button to choose Color Temperature, press the **OK (Enter)** button.
- 4 Use the **◀ / ▶ ADJ** buttons to choose Warm, Cool or Normal. When finished, press the **OK (Enter)** button.
- 5 Press the **MENU** button several times to remove the menus.

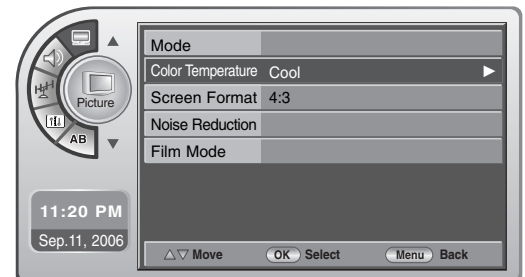

Screen Format Adjustments

- The user can choose preset formats for the picture.

- 1 Press the **MENU** button and then use the **ADJ ▲ / ▼** button to highlight the Picture menu.
- 2 Press the **OK (Enter)** button.
- 3 Use the Up/Down arrow button to choose Screen Format, press the **OK (Enter)** button.
- 4 Use the **◀ / ▶ ADJ** buttons to choose a preset screen format: Set By Program, 16:9 or 4:3. When finished, press the **OK (Enter)** button.
- 5 Press the **MENU** button several times to remove the menus.

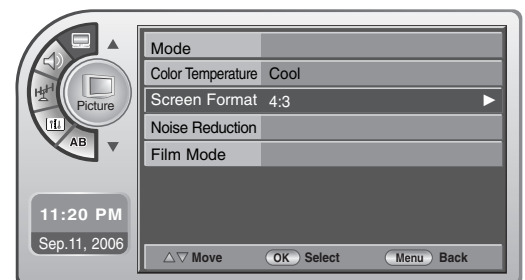

Film Mode Options

- Turn Film Mode On to view movies with optimum preset picture settings.
The user can watch movies with a more realistic picture on analog channels.

- 1 Press the **MENU** button and then use the **ADJ ▲ / ▼** button to highlight the Picture menu.
- 2 Press the **OK (Enter)** button.
- 3 Use the Up/Down arrow button to choose Film Mode, press the **OK (Enter)** button.
- 4 Use the Left/Right ADJ buttons to choose on or off. When finished, press the **OK (Enter)** button.
- 5 Press the **MENU** button several times to remove the menus.

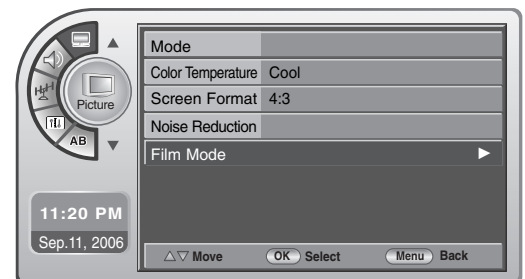

Managing the Channel Banks

The TV has four channel banks, where the administrator or installer can store groups of TV channels.

PLANNING THE CHANNEL BANKS

Generally, TV channels are grouped into “program packages” with terms that are proposed to the end user. The user then chooses a package. Below is an example of how TV channels may be grouped.

You may plan your packages by using a chart like the one after the following page.

Remember, you can “blank” a channel for accommodating audio-only, such as an FM radio station or in-house communication.

Sometimes, only one or two channel banks may be needed. You may leave any unused bank with the channels entered during Auto Program; or, you may delete the channels. However, you may want to leave at least one channel in any unused bank. Then, if someone selects an “unused” bank, that channel will assure them that the TV is functional.

***Note:** Some channels from factory testing may be in the channel banks if you have not yet run Auto Program.

Channel Bank	Program package
1	Basic cable channels
2	Extended cable channels
3	Extended with premium channels
4	Other cable service options

(Grouping is provided as an example only.)



The BLNK (blank) channel function is “global” -- the same channel number is blanked in all channel banks 1, 2, 3, and 4.

ADDING / DELETING CHANNELS

A previously prepared programming chart is helpful.

1. Run Auto Program (in the Setup menu). All channels found on your cable/antenna will be entered in Channel Banks 1, 2, 3, and 4.

***Note:** Be advised that running Auto Program overwrites any custom channel setups; removes Blanked, Deleted.

2. Select a channel bank with an installer remote - -press SOURCE/BANK (and repeat). CHANNEL BANK and BANK number will be displayed.

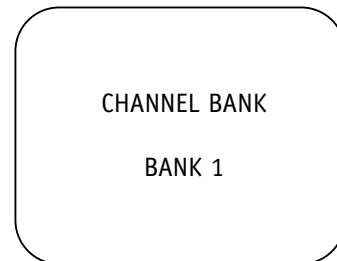

Channel Bank Number Display

3. Use the ADD/DEL/BLNK option (also in the Setup menu) to customize your program package. You may delete channels or add some that have not been entered. You can also “Blank” a channel for accommodating an audio-only program source or in-house communication. The “ADD/DEL/BLNK” option on page 15 has more details.
***Note:** The Blank Channel feature is global. A channel will be blanked in all channel banks.
4. Repeat steps 2, and 3 to program another channel bank.

Inactive TV Display (Channel Bank 4)

The TV can be set up to be inactive; which would require an attendant using an installer remote to change to a “billable” active channel bank selection: Bank 1, 2, or 3.

***Note:** For institution control of patient-accessible programming, channels in Bank 4 need to be removed.



Managing the Channel Banks

Examples of typical channel banks chars filled in

Figure 1. Typical channel banks after running Auto Program

BANK	Purpose	Channel Number																								
		1	2	3	4	5	6	7	8	9	10	11	12	13	14	15	16	17	18	19	20	21	22	23	24	25
1			A			A		A		A					A	A	A	A	A	A	A		A	A	A	A
2			A			A		A		A					A	A	A	A	A	A	A		A	A	A	A
3			A			A		A		A					A	A	A	A	A	A	A		A	A	A	A
4			A			A		A		A					A	A	A	A	A	A	A		A	A	A	A

A = Active - - Channel was found during AUTO PROGRAM

Figure 2. Typical channel banks after running Auto Program, and customizing with Add/Del/Blnk

BANK	Purpose	Channel Number																								
		1	2	3	4	5	6	7	8	9	10	11	12	13	14	15	16	17	18	19	20	21	22	23	24	25
1	Basic	BC	A			A		A		A					D	D	D	D	D	D	D		D	D	D	D
2	Extend	BC	A			A		A		A					A	D	A	D	A	A	A		D	D	D	D
3	All CTV	BC	A			A		A		A					A	D	A	D	A	A	A		A	D	A	A
4	Other	BC	A			A		A		A					A	A	A	A	A	A	A		A	A	A	A

A = Active Channel was found during AUTO PROGRAM
D = Delete Channel was deleted using Add/Del option.
BC = Blanked Channel Channel was blanked using BLANK channel option (ADD/DEL/BLNK).

ADDING / DELETING CHANNELS

It is best to do ADD / DEL customizing before doing "BLNK."

AUTO PROGRAM enters the same channels in banks 1, 2, 3 and 4.

AUTO PROGRAM removes any channels previously customized with ADD / DEL / BLNK. The channels available on your antenna / cable will be entered, and any channels previously entered but not currently available will be deleted.

ADD and DEL (not BLNK) can be used independently for channel banks 1, 2, 3 and 4.

A channel blanked, is blanked in all channel banks.

Channel allocations in tuning bands:

BROADCAST: 2 - 69
CABLE - CATV, HRC or ICC: 1 - 125

Managing the Channel Banks

PLAN YOUR CHANNEL BANKS BY FILLING IN THESE CHARTS (or use photocopies)

BANK	Purpose	Channel Number																								
		1	2	3	4	5	6	7	8	9	10	11	12	13	14	15	16	17	18	19	20	21	22	23	24	25
1																										
2																										
3																										
4																										

BANK	Purpose	Channel Number																								
		26	27	28	29	30	31	32	33	34	35	36	37	38	39	40	41	42	43	44	45	46	47	48	49	50
1																										
2																										
3																										
4																										

BANK	Purpose	Channel Number																								
		51	52	53	54	55	56	57	58	59	60	61	62	63	64	65	66	67	68	69	70	71	72	73	74	75
1																										
2																										
3																										
4																										

BANK	Purpose	Channel Number																								
		76	77	78	79	80	81	82	83	84	85	86	87	88	89	90	91	92	93	94	95	96	97	98	99	100
1																										
2																										
3																										
4																										

BANK	Purpose	Channel Number																									
		101	102	103	104	105	106	107	108	109	110	111	112	113	114	115	116	117	118	119	120	121	122	123	124	125	FM
1																											
2																											
3																											
4																											

Installer Overview

Following is the Commercial Mode Operation Setup.

Operating Installer Menu

To set up the controls for the TV you will need to know how to enter the L20V54S Installer menu and make changes to the default values as required. If necessary, familiarize yourself with the L20V54S Installer menu and how to make and save changes in the menu.

Optional Installer Remote

You will need an **Installer remote** control similar to the one shown to the right.

The TV's clonable features need to be set up before 2-5-5 + Menu is done. This is a critical step.

If the Master TV display panel's clonable features like: Clock Set, adding channel icons and channel labels, etc. are not done properly, then the cloned L20V54S TVs will all have problems. For example, do not do 2-5-5 + Menu more than once or the TV setup will become corrupted. If you need to start the procedure over, then begin by setting installer item 117 to 001, and pressing Enter to reset the TV to default values in the installer menu. You can do 2-5-4 + Menu mode more than once but this mode is limited to only editing channel icons and channel labels.

Refer to the appropriate section in the Manual for other TV features: Picture, Sound etc.

LT2002 Clone Programmer

As the cloning procedure is being performed, specific steps need to be done at the indicated times to achieve the desired result. Be sure to do each cloning task as indicated. If a procedure or step is left out or not performed correctly, then the TV setup will be wrong and cloning may not work. At each step, pay attention to assure the TV screen shows the proper message(s) when cloning. If the message indicated does not appear, there is a problem with that step and cloning may not be successful. Cloning is only possible when the signal source is an Analog channel, not a digital channel.

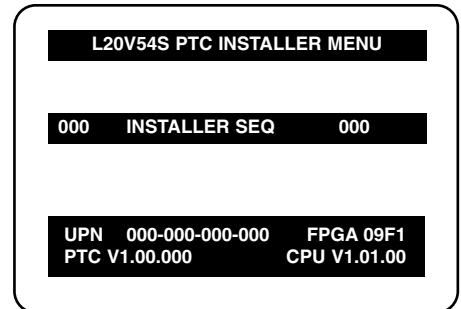
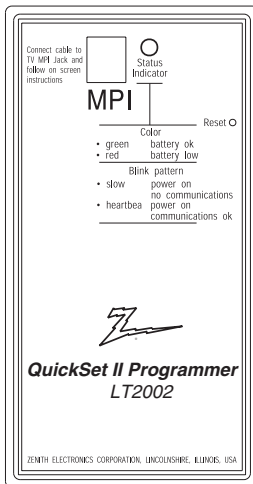

Typical Installer Menu



Commercial Mode Setup

This page provides an overview of the TV configuration. See the pages listed below for more specific, detailed instructions at each step; how to access and use the Installer menu etc.

***Note 1:** Disconnect all Aux inputs. Under certain conditions, Auto Program (Channel search) is disabled if there is an Aux input active.

Overview: Commercial Mode Setup Procedure

1. Set Installer Menu Items

(Enter Installer Menu, see page 43 for detailed instructions.)

- Set Installer menu item **117 FACT DEFAULT**, to **001** and press **ENTER**.
(This clears all installer menu items, custom settings, channel labels/icons and reloads the factory default settings.)
- Set Item **003 BAND/AFC**.
 - **Broadcast:** set to **000**. - **HRC:** set to **002**
 - **CATV:** set to **001**. - **IRC:** set to **003**
- Set item **028 CH OVERRIDE** to **001**. This allows access to Auto Program, Channel Labels and Channel List options in the Channel Menu.
- Set other particular installer items that affect your TV programming network. See pages 46 - 51.
- After all required installer menu item settings have been adjusted, press **ENTER** on the remote to remove Installer Menu.

2. Set Up TV Features

(See Picture, Sound, Setup menus etc. See TV Clonable options list on page 52.) Installer Note: Some TV features will have to be set up after running Auto Program. An example is Digital Font options. This feature is not available until digital channels are found in the channel scan. Set up Digital Font options after Auto Program finds a digital channel with digital captions. Do this **before** running **2-5-5 + Menu**.

3. Run Auto Program

(Search for all available channels.) Go to the Channel menu and access the Auto Program option, follow on-screen instructions.

- Edit Channel Scan. In the Channel Menu, access the Channel List menu.
- Delete channels per your system requirements: do you want to delete any free channels so the guest cannot access them?
- Add familiar Channel Icons like ABC, CBS, NBC etc. to the channel on-screen display. Add identifiable labels for the end user to readily know what common networks are available. In the Channel menu, select the Channel Label option, follow instructions on the bottom of the screen.

4. Transfer TV Setup to Controller Box: 2-5-5 + Menu

After the TV channel scan has been edited and channel label icons added, enter the Installer menu. Once in the Installer menu, press 2-5-5 and MENU on the remote. This transfers the TV setup to the internal controller box.

***Note:** Only do 2-5-5 + MENU once or TV setup may be corrupted.
TV scans available channels and exits menu when transfer to controller is complete.

5. Perform Adding Custom Channel Labels: 2-5-4 + Menu Mode

Enter Installer menu, press 2-5-4 and Menu. Add your own custom labels to the channel on-screen displays. (See page 53.) To remove menu press **MENU**.

***Note:** 2-5-4 + MENU can be performed more than once.

Verify TV Setup

At this point, verify that the channel lineup, channel icons and custom labels are correct. Make sure the TV features are set per your requirements.

Set item **028 CH OVERRIDE** to **000** to lock the channel scan. After the preceding has been completed, the Master TV setup is ready to be copied to the LT2002 Clone Programmer, see next page.

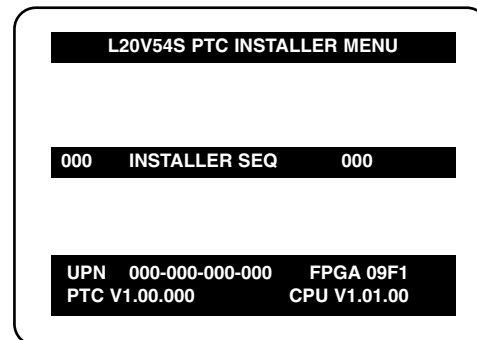

L20V54S Installer Menu

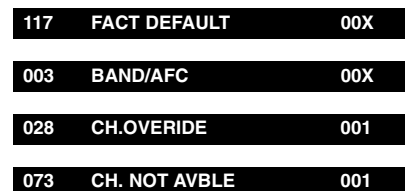

L20V54S Installer Menu Items

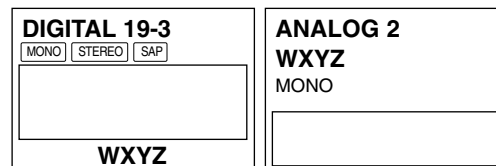

Custom Channel Label 'WXYZ' created in 2-5-4 + Menu Add Channel Label Mode



After TV setup has been verified, set item 028 Ch Override back to 000.

***Note:** Default setting for Aux sources is to be active in the installer menu. The Aux sources will appear between the highest Analog and lowest Digital channel number with Channel Up/Down. If the Aux sources will not be used, it is advisable to set them to 000 (Off) before doing 2-5-5 + Menu. After doing 2-5-5 + Menu, the only way to turn the Aux source off so they will not appear in the channel scan, is to go to the Channel Bank menus and turn each Aux source off by selecting 'Normal Delete'.
Refer to installer items: 35, 39.

Cloning Connections/Learning Setup

Connections for the LT2002 Clone Programmer to Learn the L20V54S Master TV Setup.

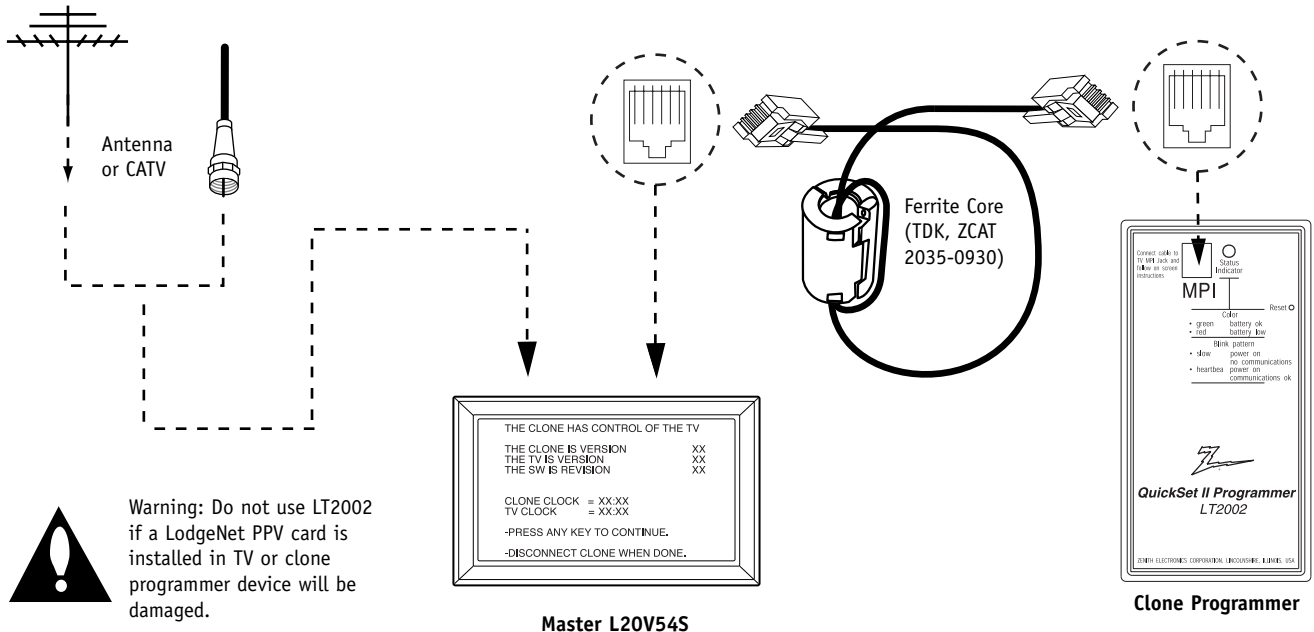

***Note:** It is assumed that the L20V54S is connected to a signal source, the source selected is Antenna (RF) In, the signal is from an Analog channel, not a digital channel, all equipment is connected to power and turned on and the LT2002 Clone Programmer main menu (THE CLONE HAS CONTROL OF THE TV) menu is displayed on the TV screen, the clone programmer LED is blinking the required heart beat pattern, see above and next page.

***Note:** Once the clone is connected, do not touch the unit or otherwise disturb it or the MPI connections. Any disturbance while the clone is operating may disrupt the master setup transfer or copying etc.

Before you begin cloning...

- The Master L20V54S should be connected to a good, stable signal from an over-the-air antenna or cable service Analog channel and connected to power. (See above.)
- Teaching and Learning is only possible between identical model devices. (However, the LT2002 Clone programmer can store up to 3 different 'master' setups.)

WARNING: Copying a blank or incorrect memory into a TV, STB or other device will cause the TV, STB or other device to operate erratically or become inoperable.

- Use an Installer's remote to operate Learning and Teaching menus.
- Make sure that the batteries in the Clone programmer are fresh.
- If batteries are removed, the Clone Clock time will be lost.
- Decide if you want to set the time from the Clone programmer or copy the time to the Clone programmer; from a compatible TV which has the clock set to the current time.

- Setting the time and transferring it to the Clone or other device is a separate procedure.
- Follow the connection diagram above to connect the Clone to a Master L20V54S TV display panel. After learning is complete, to another identical L20V54S TV display panel to "teach" it the master setup.
- After the L20V54Ss setup has been copied to another identical L20V54S, that identical unit with the copied setup, needs to be disconnected from power for about 15 seconds to activate the newly-copied setup.
- See the Clone Troubleshooting section to resolve problems.

Turn to the next page to continue Cloning Setup.

Clone Programmer Learning Setup

Learning the Master TV Setup

Instructions for the Clone Programmer to Learn the Master L20V54S Setup.

Use MPI Cable to Connect LT2002 Clone Programmer to Master L20V54S MPI Port

If there is a good connection, "THE CLONE HAS CONTROL OF TV" message will appear. Press any key on the Installer remote.

Learn Setup from Master L20V54S

Press 1 to select the "LEARN FROM TV" option, then press ON/OFF, POWER, or ENTER to go to the Memory Bank Selection Menu. Pick the Memory "Bank" you want to store the master L20V54S's setup in by pressing either Channel key repeatedly to choose Memory 1, 2 or 3. (If you choose a Memory "Bank" that has a master device's setup programmed into it, that setup will be overwritten by the new master L20V54S's setup.) Once the Clone memory bank is selected, press ON/OFF, POWER, or ENTER. The Clone memory bank you have selected will be shown. Press ON/OFF or POWER to begin copying the master L20V54S's setup.

Set the Clock (Optional)

Set the time on a Master TV's Clock. (If the time has already been copied from a TV into the Clone programmer, you can set a master TV's clock by copying the time from the Clone programmer.) The Clone Programmer can copy the current time to both a master TV and to the Clone's internal clock; accurate to within one minute. (Another reason that the Clone programmer should be equipped with fresh, high-quality alkaline batteries, is for it to keep the time as accurately as possible.)

Since the Clone Programmer's time cannot be set directly, the current time needs to be copied from a Zenith/LG TV equipped with M.P.I. input capability.

After the time is copied to the Clone programmer, the current time can then be transferred to another TV. (This can be a master TV, or another TV which has already had the features set up.)

***Note:** When using the clone programmer for teaching or learning, be sure that the heartbeat pattern is shown on the LEDs. Both learning and teaching should take about 45 or more seconds depending on the complexity of the master setup. While the clone is functioning, do not move it or otherwise disturb the clone or wiring connections. If the clone finishes the function in less than 45 seconds, redo the function again. Press the reset button if the clone does not act normally.

THE CLONE HAS CONTROL OF THE TV

THE CLONE IS VERSION XX
THE TV IS VERSION XX
THE SW IS REVISION XX

CLONE CLOCK= XX:XX
TV CLOCK= XX:XX

-PRESS ANY KEY TO CONTINUE.

-DISCONNECT CLONE WHEN DONE.

This menu should appear by itself after the LT2002 is connected to the L20V54S MPI port.

CLONE SELECTION MENU

- (1) LEARN FROM TV
- (2) TEACH TO TV
- (3) SET CLONE CLOCK FROM TV
- (4) SET TV CLOCK FROM CLONE
- (5) DISPLAY TV SETUP
- (6) DISPLAY CLONE SETUP

- TO CHANGE MENU ITEMS, PRESS CHANNEL KEYS OR DIGITS.

- TO EXECUTE ITEM, PRESS ON/OFF, POWER, OR ENTER

LT2002 Clone Programmer Communication Problems

- A slow flashing green light indicates there are communication problems between the L20V54S and the LT2002 clone programmer. If this is the case, check for a damaged cable, poor contacts, or other connection troubles.
- If the status indicator is red, the programmer batteries are low and should be replaced. Install 4 high-quality alkaline AA batteries.

Cloning Connections / Teaching Setup

Teaching the Master Setup to Another L20V54S

Connections for the LT2002 to Teach another L20V54S the Master Setup

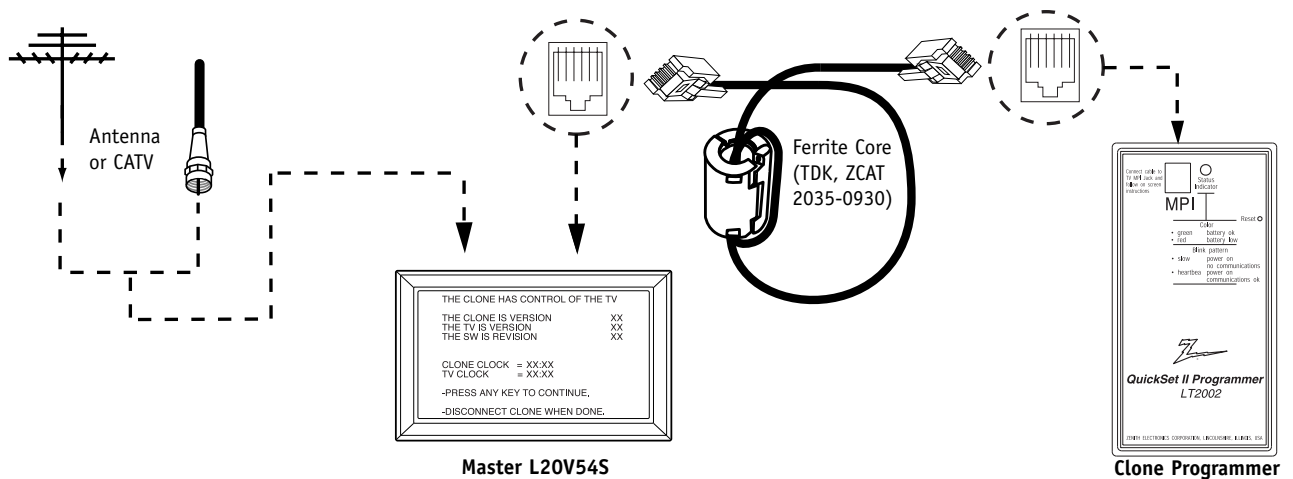

Teach Master L20V54S's Setup to the target L20V54S

After learning is complete, remove the M.P.I. cable from the master L20V54S and connect it to the target L20V54S that you want to copy the master L20V54S's setup into. With "THE CLONE HAS CONTROL OF TV" message displayed, press 2 to go to the "TEACH TO TV" option, press ON/OFF, POWER, or ENTER.

Select the LT2002 memory that the new setup is in. Press On/Off to transfer the new setup and other information to the new L20V54S. Teaching usually takes 2-3 minutes.

After the "TEACHING COMPLETE" message is displayed, press any key to return to the Clone menu, then press ON/OFF, POWER, or ENTER. If finished, detach M.P.I. cable from the target, newly cloned L20V54S.

Disconnect L20V54S Power for 15 Seconds

Unplug the AC power cord of the newly cloned L20V54S from the power outlet for about 15 seconds to activate the newly-copied setup.

CLONE SELECTION MENU

- (1) LEARN FROM TV
- (2) TEACH TO TV
- (3) SET CLONE CLOCK FROM TV
- (4) SET TV CLOCK FROM CLONE
- (5) DISPLAY TV SETUP
- (6) DISPLAY CLONE SETUP

- TO CHANGE MENU ITEMS, PRESS CHANNEL KEYS OR DIGITS.
- TO EXECUTE ITEM, PRESS ON/OFF, POWER, OR ENTER

This menu should appear after any key is pressed on the Installer remote.

TEACHING IN PROGRESS,

PLEASE WAIT

This display will appear during Teaching function.

TEACHING COMPLETE

This display will appear after Teaching is complete.

Installer Menu

Use the Installer's Menu to set up or change operational settings.
See more detailed descriptions of the Installer menu items on the following pages...

Accessing the Installer's Menu

Make sure TV is on. Installer's menu items can be accessed by using an installer's remote control. Just press MENU repeatedly (at least 10 times) until the TV seems to stop responding, then press 9, 8, 7, 6, then ENTER to access the Installer's menu. To remove the Installer's menu, press ENTER again. *Any changes you make will be stored in non-volatile memory. (The menu also disappears automatically.)*

The Installer's menu opens with item 000 INSTALLER SEQ 000. Use the Up/Down arrow keys to sequence through the available menu items. Or, access an item directly by keying in the line number, then pressing MENU. For example, to access the Sleep Timer option which is item 015, press 0-1-5, then MENU. To change a setting, use the Left/Right arrow keys. Or, enter a value directly.

Using the Installer's Menu

Items 000 ~ 117 are immediately accessible only upon entering the Installer's Menu. Their numbers, descriptions, ranges, factory default settings, and a place for listing any changes made on-site are given below and on the following pages.

Installer Menu Items 000 through 117

Menu Item	Function	Value Range	Default Value	Brief Description of Function and Comments
000	INSTALLER SEQ	0 ~ 3	0	Leave default set to 0.
001	POWER MANAGE	0 ~ 7	0	Sets number of hours of no activity before auto shut Off.
002	AC ON	0 / 1	0	Set to 1 to enable auto turn On at power up.
003	BAND/AFC	0 ~ 3	1	Selects Tuning Band: 0=Broadcast, 1=CATV, 2=HRC, 3=IRC
004	STRT CHANNEL	0 ~ 127, 255	255	Channel at turn-on (Set 255 to return to last channel before power Off).
005	CHAN LOCK	0 / 1	0	If set to 1, cannot tune from current channel.
007	STRT VOLUME	0 ~ 63, 255	255	Sets Volume level at TV turn-on (Set 255 to retain last volume level).
008	MIN VOLUME	0 ~ 63	0	Sets minimum allowable volume setting.
009	MAX VOLUME	0 ~ 63	63	Sets maximum allowable volume setting.
010	MUTE DISABLE	0 / 1	0	Set to 1 to disable mute function.
011	KEY DEFEAT	0 / 1	1	Set to 1 to disable menu navigation keys on display panel.
012	IR BANKS EN.	0 / 1	0	Set to 1: enables TV to respond to IR code
013	SCAN MODE	0 / 1	1	Typically used for Hospitals: puts On-Off and FM in Ch Up/Down sequence.
014	STRT CH IN SM	0 / 1	0	Set to 1 to put TV on/off below start channel number.
015	SLEEP TIMER	0 / 1	1	Set to 1 to enable Sleep Timer.
016	EN TIMER	0 / 1	1	Set to 1 to enable On/Off Timers.
017	ALARM	0 / 1	1	Set to 1 to enable Alarm.
020	FEATURE LEVEL	0 / 1	1	Zen 1 Leave default set 1 (1 Zen 1)
021	V-CHIP	0 / 1	1	Set to 1 to enable V-Chip functions.
022	MAX BLK HRS	0 ~ 99	12	Sets number of V-Chip (Parental Control) blocking hours.
023	CAPTION LOCK	0 / 1	0	Set to 1 to retain caption setting at power Off.
025	FUNCTION PRE.	0 ~ 3	1	Controls channel preview in Pay-Per-View function
027	HOSPITAL MODE	0 ~ 2	2	Leave default set to 2.
028	CH. OVERRIDE	0 / 1	1	If set to 0, limits direct access to favorite channels.
029	OLD OCV	0 / 1	0	Set to 1 to change M.P.I. operation to OCV.
030	ACK MASK	0 / 1	0	If set to 1, changes M.P.I. for some OCV boxes.
031	POLL RATE	20 ~ 169	94	Selects poll rate for M.P.I.
032	TIMING PULSE	186 ~ 227	207	Sets baud rate for M.P.I.

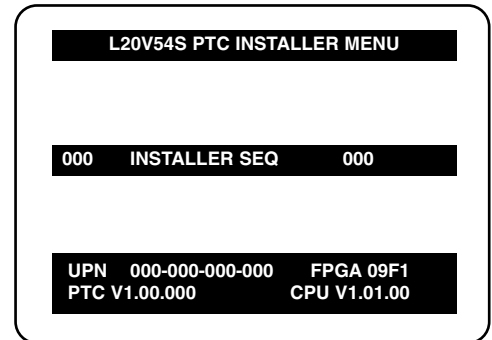

Typical Installer Menu

Installer Menu

Installer Menu Items 035 through 117

Menu Item	Function	Value Range	Default Value	Brief Description of Function and Comments
035	COMPPORT EN.	0 / 1	1	Set to 1 to enable HDMI. Set to 0 to disable.
039	REAR AUX EN	0 / 1	1	Set to 1 to enable display panel Video 1 input jack.
046	STRT AUX SRCE	1 ~ 7, 255	255	Sets the starting AUX source.
047	AUX STATUS	0 / 1	0	Set to 1 for M.P.I. AUX source to be reported as a channel number instead of Channel 0.
053	DIS. CH-TIME	0 / 1	0	Set to 1 to disable Channel-Time display.
069	EN. CH-T COL.	0 / 1	1	Set to 1 to enable custom color for the Channel-Time display.
070	FOR. CH-TIME	0 ~ 7	1	Chooses custom foreground color for the Channel-Time display.
071	BCK. CH-TIME	0 ~ 7	1	Chooses custom background color for the Channel-Time display.
073	CH NOT AVBLE	0 / 1	0	If set to 1 and channel override is 0, "NOT AVAILABLE" message is displayed when directly accessing a channel not in the favorite channel list.
075	REVERT CH	0 / 1	0	If set to 1 and loss of M.P.I. communication occurs, TV tunes to Start Channel.
077	QUICK SHUTOFF	0~17	0	Allows TV timed power off press and hold setup with pillow speaker channel button.
078	UPN MSB	0 ~ 255	255	User programmable number, most significant byte.
079	UPN MSB-1	0 ~ 255	255	User programmable number, most significant byte - 1.
080	UPN MSB-2	0 ~ 255	255	User programmable number, most significant byte - 2.
081	UPN LSB	0 ~ 255	255	User programmable number, least significant byte.
082	CHKSM ERROR	0 / 1	0	Enforces rigid M.P.I. checksum.
083	HANDSHK TIME	0 ~ 5	5	Relaxes M.P.I. timing to be compatible with PC based Windows-controlled systems.
084	PERMANENT BLK	0 / 1	0	Removes block hours setting for Parental Control and makes block permanent.
088	EN NOISE MUTE	0 / 1	1	If set to 1, mutes audio if no signal is present.
090	KEY LOCK	0 / 1	0	If set to 1, keyboard is locked out, IR is still functional.
094	SAP MENU EN	0 / 1	1	Set to 0 to disable feature on Function menu. Set to 1 to enable feature on Function menu.
096	DEF. ASP. RATIO	0, 1, 2, 4, 5	2	Sets default aspect ratio at power up. See detailed descriptions and item 106.
102	ATSC BAND	0 ~ 4	4	Selects ATSC band.
103	ATSC TUNE MODE	0 / 1	1	Sets ATSC tuning mode. Set to 0 for virtual channels, set to 1 for physical channels.
104	START MINOR CH	0 ~ 255	0	Selects Minor start channel. Set 0 for NTSC. Not 0, sets Minor channel number.
106	ASP RATIO LOCK	0 / 1	0	To retain set aspect ratio on power cycle, set to 1. Set to 0 for default ratio on power cycle.
107	BANNER SELECT	N/A	N/A	Not applicable.
116	VIDEO MUTE EN	0 / 1	0	Set to 0 for normal, set to 1 for Blank.
117	FACT DEFAULT	0 / 1	0	0=Normal. 1=Loads factory default presets of all above settings.

Installer Menu

Detailed Descriptions of Installer Menu Items

000 - INSTALLER SEQUENCE

Specifies entry sequence to the Installer Menu.

0 = 9876	1 = 4321
2 = 1478	3 = 3698

001 - POWER MANAGE (Power Management)

Determines hours of no activity before automatic shutoff. The POWER MANAGE function is for saving energy. If set to 0, Power Manage is Off. Settings range from 0 ~ 7, with 1 ~ 7 representing the hours that the TV will remain On, unless there has been activity from either the control panel or remote control.

002 - AC ON (AC Power Switchable)

If set to 1, allows the L20V54S to turn On just by applying AC power. Pressing the On button is not necessary. This is desirable if the L20V54S is plugged into a cable box or a power outlet controlled by a wall switch. Use ADJ Left/Right arrow to choose 0 or 1 where 0 is the default is Off, and 1 is On.

**Note: If set to 1 (On), the L20V54S does not respond to On/Off commands from either the remote or the display control panel, and the SLEEP TIMER is also nonfunctional.*

003 - BAND/AFC (Band/Automatic Frequency Control)

Selects the tuning band. There are 4 possible settings for this option:

0 = Broadcast	1 = CATV
2 = HRC	3 = IRC

If some channels were not found by Auto Program, select the appropriate Band setting here and add the channels using the Channel List option in the Channel Menu.

004 - STRT CHANNEL (Start Channel)

If active, this function allows you to determine the initial channel number when the L20V54S is turned On. This feature is useful for an in-house information channel, since the L20V54S would always select that channel when it is turned On. Setting this to 255 causes the last channel viewed when the L20V54S was turned Off, to be the tuned to channel when the L20V54S is turned On again.

255 = Last channel	1 ~ 125 = Ch X	0 = Aux
126 Map to Channel 3.	127 Map to Channel 4.	

005 - CHAN LOCK (Channel Lock)

CHAN LOCK is ideal if the system must always be on the same channel. Changing channels with Channel Up/Down or keypad numbers is impossible. Channel Lock is inactive if set to 0 (default).

Generally, this feature is used in connection with START CHANNEL (Installer item 004) where the start channel may, for example, be set to 3 or 4. If the start channel is 3, then the L20V54S will remain locked on Channel 3.

***Note: For Items 007, 008 and 009**

For legacy reasons, the scale used is 0 - 63. The PTC software will translate this to the 0 - 100 scale used by the TV.

To translate a TV volume level to the installer menu value, use the following formula:

$$\text{Installer Value} = \frac{\text{TV Value} \times 63}{100}$$

Enter only the whole number (disregard fractions).

007 - STRT VOLUME (Start Volume)

This function allows the Installer to determine the initial volume level setting when the L20V54S is turned On. This feature is useful for an in-house information channel, since the L20V54S would always select that volume level when it is turned On. The range of values are 0 - 63, 255. If 255 is selected, the current volume level will be retained in memory when the L20V54S is turned Off; at turn On, the volume level will be automatically set at the previous or last level.

008 - MIN VOLUME (Minimum Volume)

This function determines the minimum volume level allowable with the VOLUME (VOL) Up/Down control. In this way, for example, someone cannot set the volume too low to hear. The value range is from 0 to 63 — change values with ADJ Left/Right arrow. The factory default is 0, which provides the full range of volume control, if item 009 MAX VOLUME is also set to 63. It may be best to set the same value on every L20V54S.

**Note: The minimum volume level cannot have a value setting higher than the MAX VOLUME level (described below).*

009 - MAX VOLUME (Maximum Volume)

This function determines the maximum volume level allowable with the VOLUME (VOL) Up/Down controls. In this way, for example, someone can not set the volume level high enough to disturb others.

(Continued on next page)

Installer Menu

(Continued from previous page)

The value range is 0 to 63, with 63 as the default, which gives the user the full range of volume control, if item 008 MIN VOLUME is also set at 0. Change values with ADJ Left/Right arrow keys. It may be best to set the same value on every L20V54S.

***Note:** The maximum volume level cannot have a value setting lower than the MIN VOLUME level (described previously).

010 - MUTE DISABLE

Enables or disables sound mute function. If set to 1, sound cannot be muted, mute is disabled. If set to 0, sound can be muted.

011 - KEY DEFEAT (Keyboard Defeat)

If set to 1, key defeat prevents the end user from accessing the on-screen menus with the display front panel—MENU, SELECT, and Left / Right arrow keys and TV/AV do not function. If set to 0, those keys do function.

***Note:** The menus can always be accessed by pressing MENU on the remote.

012 - IR BANKS EN. (IR Banks Enable)

For direct access to a particular Channel Bank. When enabled, installer can access a channel bank by inputting the IR code for the bank.

013 - SCAN MODE

Allows variation in setting the On/Off with Channel UP/DOWN. You may opt for TV channels only; TV channels + Off/ON; TV channels + FM radio; TV channels + FM radio + Off/On with these settings for Scan Mode:

SCAN MODE	Characteristics
0	Channel up/down keys change channels only.
1	Channel down below the lowest channel (or channel up higher than the highest) and TV turns off.

014 - STRT CH IN SM (Start Channel in Scan Mode)

When set to 1, installs TV On/Off event below the start channel at TV turn on.

015 - SLEEP TIMER

If set to 1, the SLEEP TIMER feature may be used. If set to 0, the Sleep Timer is not available.

016 - EN TIMER (Enable On/Off Timers)

If set to 1, Timer function is available to user. Set to 0 to disable On/Off Timer functions. (Clock must be set in order to use Timers.)

017 - ALARM

Gives the installer the option of making the Alarm function available to the end user. If set to 1, Alarm function is available to end user. Set to 0 to disable the Alarm function.

***Note:** Clock must be set before the Alarm function will work.

Installer should leave item 20 FEATURE LEVEL set to 1 (default).



020 - FEATURE LEVEL

Default set to ZEN 1 for Zenith IR remote control operation. Set 0, P LBL for Zenith Private Label IR remote control operation. Warning: Do not set to "0" or remote will not control TV.

021 - V-CHIP (Parental Control)

Set to 1 to activate V-Chip (Parental Control); have it available to end user to filter and control or otherwise restrict programming content that can appear. Set to 0 to turn V-Chip feature Off, not available to user; no programming restrictions can be set.

022 - MAX BLK HRS (Maximum Block Hours)

Sets hours from 0 to 99 for the maximum V-Chip (Parental Control) block hours. Default setting is for 12 blocking hours.

023 - CAPTION LOCK

Set to 1 to restore previous caption On/Off state after turn Off. If set to 0, captions are always Off at turn On.

025 - FUNCTION PRE. (Function Preview)

Set to 0 to suppress CHANNEL PREVIEW from the FUNCTION menu with some Pay-Per-View systems.

027 - HOSPITAL MODE

The default is 2 (which favors most hospitals). With this setting two things are affected: Channel Banks 1, 2, and 3 are accessible, while Bank 4 is inactive.

028 - CH. OVERRIDE (Channel Override)

If set to 1, the user can select channels with either Channel up/down or by direct keypad entry. If set to 0, only those channels that are entered for scanning can be selected.

029 - OLD OCV (On Command Video™)

Set to 1 for operation with systems from On Command Corporation.

030 - ACK MASK

M.P.I. Communication Parameter. Leave at default setting unless changed by Pay-Per-View provider. When set to 1, changes M.P.I. for some OCV boxes.

031 - POLL RATE

M.P.I. Communication Parameter. Selects Poll Rate for M.P.I. Leave at default setting unless changed by Pay-Per-View provider. Step size of 16 ms.

032 - TIMING PULSE

M.P.I. Communication Parameter. Leave at default setting unless changed by Pay-Per-View provider. Sets baud rate. Step size of 4.3 uS.

035 - COMPPORT EN. (Computer Port Enable)

Enable/disables display panel HDMI input jack. Set to 0 to disable, set to 1 to enable.

Installer Menu

Detailed Descriptions of Installer Menu Items

039 - REAR AUX EN. (Rear Aux Enable)

Set to 1 to enable display panel rear AUX (Video 1) input.
Set to 0 to disable display panel rear AUX (Video 1) input.

046 - STRT AUX SRCE (Start Aux Source)

Sets the starting AUX source.
Start source if start channel =0

1 = Video1 3 = HDMI 1 255 = Last Aux

047 - AUX STATUS

Set to 1 for M.P.I. AUX source to be reported as a channel number instead of channel 0. Set to 0 to disable AUX identification change. Controls M.P.I. status channel response for AUX inputs.

053 - DIS. CH-TIME (Disable Channel-Time)

Set to 1 to disable the Channel-Time display, Channel-Time display will not appear.
Set to 0 to enable the Channel-Time display.

069 - EN. CH-T COL. (Enable Channel-Time Custom Color)

Set to 1 to enable custom color for the Channel-Time display.
Set to 0 to disable custom color for the Channel-Time display.

070 - FOR. CH-TIME (Channel-Time Display Foreground Color)

Set according to Color Chart.

0 = Black 3 = Yellow 6 = Cyan
1 = Red 4 = Blue 7 = White
2 = Green 5 = Violet

**Note: If foreground and background colors are the same, menu background is transparent.*

071 - BCK. CH-TIME (Channel-Time Display Background Color)

Set according to Color Chart.

0 = Black 3 = Yellow 6 = Cyan
1 = Red 4 = Blue 7 = White
2 = Green 5 = Violet

**Note: If foreground and background colors are the same, menu background is transparent.*

073 - CH NOT AVBLE (Channel Not Available)

If set to 1 and item 028 CHANNEL OVERRIDE is set to 0, "NOT AVAILABLE" message is displayed when directly accessing a channel not in the channel scan list available in memory.

075 - REVERT CH (Revert to Start Channel)

If set to 1 and loss of M.P.I. communication occurs, TV automatically tunes to the specified Start Channel.

077 - QUICK SHUTOFF

Allows TV power off to be controlled by the pillow speaker channel selection button. User would press and hold button down for time required to have TV turn off. Value Range 0 ~ 17, each number represents 1/2 second. For example, if set to 4, TV would turn off if user held speaker channel button down for 2 seconds.

078 - UPN MSB (UPN Most Significant Byte)

User programmable number, most significant byte readable by M.P.I. command.

**Note: Not linked to serial number.*

079 - UPN MSB-1 (UPN Most Significant Byte-1)

User programmable number, most significant byte-1 readable by M.P.I. command. Not linked to serial number.

080 - UPN MSB-2 (UPN Most Significant Byte-2)

User programmable number, most significant byte-2 readable by M.P.I. command. Not linked to serial number.

081 - UPN LSB (UPN Least Significant Byte)

User programmable number, least significant byte readable by M.P.I. command. Not linked to serial number.

082 - CHKSM ERROR (Checksum Error)

Enforces rigid M.P.I. checksum validation.

Set to 1 for validation.

Set to 0 to disable (does not check checksum on M.P.I. async port). SPI is always checked.

083 - HANDSHK TIME (Handshake Time)

Adds an additional delay to the handshake time which is 64 msec, thus relaxing M.P.I. timing requirements to be compatible with PC based Windows controlled systems, range is 0 - 5.
(Timeout = 25.5MS + [25.5 MS* Handshake time]).

084 - PERMANENT BLK (Permanent Block)

Allows Lock (Parental Control) blocking schemes to be permanent by disabling the blocking hours function.

Set to 1 to install Parental Control restrictions permanently.

Set to 0 for user-specified hours control of blocking schemes.

088 - EN NOISE MUTE (Enable Noise Mute)

If set to 1, audio mutes if no signal is present.

090 - KEY LOCK

If set to 1, display panel keyboard is locked out, not available to end user. IR receiver remains functional.

094 - SAP MENU EN (2nd Audio Program)

Set to 1 to enable SAP feature, if available.

Set to 0 to disable SAP feature.

096 - DEF. ASP. RATIO (Default Aspect Ratio)

Selects default aspect ratio at power up, see settings below.

Set to 0 for set by program.
Set to 1 for 4:3.
Set to 2 for 16:9 (Factory Default).
Set to 4 for Zoom 1
Set to 5 for Zoom 2

102 - ATSC BAND

Sets up TV to receive different types of incoming signals:
0=Broadcast, 1=CATV, 2=HRC, 3=IRC, 4=Same as NTSC.

(Continued on next page)

Installer Menu

(Continued from previous page)

103 - ATSC TUNE MODE

Selects ATSC tuning mode: 0=Virtual, 1=Physical.

***Note:** The setting above is ignored if Installer item 102 ATSC BAND, is set to 1=CATV, 2=HRC, or 3=IRC. Then **103 - ATSC TUNE MODE** above always resets itself to Physical (1), regardless of what value appears for item 103 on the Installer menu.

104 - START MINOR CHANNEL

Sets XX-XX minor starting channel at power up: 0=NTSC. If not 0, number selected is the Minor start channel number.

106 - ASP RATIO LOCK (Aspect Ratio Lock)

Set to 1 to retain previous aspect ratio with power Off.

Set to 0 to retain default aspect ratio with power Off. See item 96 Default Aspect Ratio above.

107 - BANNER SELECT

Not applicable.

116 - VIDEO MUTE EN (Video Mute Enable)

Set to 0 for normal.

Set to 1 for blank.

117 - FACT DEFAULT (Factory Default)

Set to 0 for normal.

Set to 1 to load default settings for all installer menu items.

WARNING: Setting this to 1 will reload the factory defaults and clear the channel list including erasing any assigned Channel Icons and Labels.



Reference: TV Features / Menus that can be Cloned

Clonable Menu Features

Channel	Picture	Sound	Setup	Caption
Auto Program (Active channels found with the channel search)	Mode	Mode	Time	On/Off
Channel Labels	Contrast	Treble	Clock	Analog Mode
Channel List	Brightness	Bass	Auto Off	Digital Mode
Fine Tune	Color	Balance	V-Chip	Digital Font Option
	Sharpness	Auto Volume	TVPG Rating	
	Tint	Multi-Track	MCAA Rating	
	Color Temperature	Internal Speaker	Menu Language	
	Screen Format		SET ID	
	Film Mode			

***Note:** For Digital Font Options, if any default setting is left unchanged prior to cloning, then all the digital font options will be set to default settings. If you want custom digital font options to be clonable, set all digital font options to settings other than Default.

Reference: Procedures for adding Channel Label Icons/Custom Channel Labels (2-5-4 + MENU Mode)

Adding Channel Icons and Labels in the 2-5-4 + Menu Mode

Editing/Adding Channel ICONs and/or Labels

If there is no pre-assigned ICON, you can make a channel label of up to 7 characters to help in identifying the channel or network. At your option, channel labels can also be added in addition to a pre-assigned ICON. You may also add labels for the Aux input sources to clearly identify the devices that are connected to the Aux inputs.

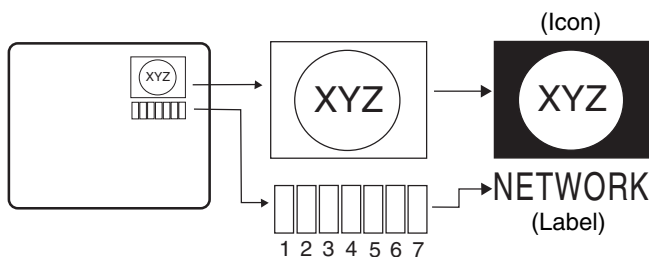

Editing and adding the labels can only be done if there are channels entered into the L20V54S's channel map either by using the method described in item 6 (page 51), by cloning or by the use of the master remote control from the PPV provider.

To Do Channel Editing/Labeling, proceed as follows

1. Enter L20V54S Installer menu.
2. After the installer menu appears, press '2', '5', '4', 'MENU'. This enters the channel label edit mode. Add your channel icons and channel labels in this menu, see below. (You can do this more than once.)
3. To exit the menu when done press "MENU".

Changing a Channel's ICON on Master TV

1. With Channel Up/Down, select the channel you want to change the Icon for.
2. With the Right or Left ADJ arrow, select the letter 'I' on the channel ID display.
3. With the Up or Down arrow, select the desired ICON you want to appear to identify the channel. (If you know the ICON number, enter the number followed by Enter / Select.)
**Note: If no Icon is available, leave at or select the default blank icon display.*
4. Proceed with Changing/Adding Labels or go to the next channel.

Changing/Adding Channel Labels on Master TV

1. Channel Up/Down to select the desired channel.
2. Press the Right or Left ADJ arrow repeatedly until the numbers 1 to 7 show up. The number shows the position of the character that can be changed. Number 1 is the first character, number 2 the second character and so on.
3. With the Up or Down arrow, select the desired character.
4. Proceed to the next number position or use Channel Up/Down to go to the next channel.

Changing Source Labels on Master TV

1. Press "TV/AV" to select the desired Aux input source; Video 1, HDMI.
2. Press the Right or Left arrow repeatedly until the numbers 0 to 9 show up. The number shows the position of the character that can be changed.
3. Use the Up or Down arrows to select the desired character.
4. Press "TV/AV" for the next Aux source or proceed with Changing Icon or Changing/Adding Labels.

Installer Remote Control Key Functions for Master TV Channel Editing/Labeling Menu

- **CHANNEL Up/Down** - Tunes in the next channel in scan.
- **Left/Right Arrows** - Select the item to change. If "I" is shown, the ICON can be changed. If a number is shown, it indicates the position of the character that can be changed.
- **Up/Down Arrows** - Select the ICON or the character to be displayed.
- **0 - 9** - Use to enter the index number of the ICON, if known.
- **OK (Enter/Select)** - Changes the ICON after the number has been entered.
- **TV/AV** - Changes the Aux input label. This key is located on side of set and on Installer remote control.
- **MENU** - Exits the labeling/editing menu.

Reference: Detailed Information For Making A Master TV

IMPORTANT INSTALLER SETUP INFORMATION! PLEASE READ THE FOLLOWING...



To set up a master TV you will need to know how to enter the L20V54S Installer menu and make changes to the default values as required. If necessary, familiarize yourself with the L20V54S Installer menu and how to make and save changes in the menu, before attempting to clone the L20V54S Master TV setup.

You will also need an **Installer remote control** similar to the one shown in the front of this manual.

Finally, the TV's clonable features need to be set up. This is a critical step. If the Master TV display panel's clonable features like

adding channel icons or channel labels are not correctly added, then the cloned L20V54S TVs will all have problems.

As the cloning procedure is being performed, specific steps need to be done at the indicated times to achieve the desired result. Be sure to do each task as indicated. If a procedure or step is left out or not performed completely, cloning may not work. At each step, pay attention to assure the TV screen shows the proper message when cloning. If the message indicated does not appear, there is a problem with that step and cloning may not be successful. Cloning is only possible when the signal source is an Analog channel, not a digital channel.

Making a Master TV

Detailed Instructions

The following describes the procedure for preparing a Master L20V54S for cloning and the procedure for adding Channel Icons and/or Labels.

***Note: 1:** Disconnect all Aux inputs. Under certain conditions, Auto Program Scan is disabled if there is an Aux input active.

1. Enter the L20V54S installer menu.
 - a. Reset the internal controller to factory default by accessing installer menu item 117 FACT DEFAULT, set it to 1 and press "ENTER". The value will change back to 0 after the TV's internal controller has been restored to factory default condition.
 - b. Within the Installer menu, set the Installer menu items to the configuration required of your institution.
 - c. It is important to set the tuning band at this time, see Installer menu item 03 BAND/AFC.
 - d. Set Installer menu item 28 - CH OVERRIDE to 001 to allow access to the Auto Program and Channel List/Channel Label features in the Channel Menu. Exit the Installer menu.
2. Access the Master TV menus and set the clonable options on the menus to the desired configuration. Refer to the **Clonable Menu Features** Chart on see page 52.
3. Run Auto Program.
4. Enter the Channel List/Channel Label menu and edit the channel line-up to include the Free-To-Guest Channels only.

5. Assign ICONs to the channels using the Channel Label Menu.
***Note:** You can add Channel ICONS typically network logos like ABC, NBC, PBS etc. in this step. Or, in Step 7, add Channel ICONS or labels for channels without Icons.
6. Transfer the TV setup: Enter the L20V54S installer menu. Press '2', '5', '5', 'MENU' to start the transfer of the TV's setup to the L20V54S. Once the transfer is complete, the system will exit the Installer menu.
***Note:** Only do 2-5-5 + MENU once. The TV setup may be corrupted if 255 + Menu is done more than one time.
7. Edit/Add Channel ICONs and Channel Labels as needed. Enter Installer menu. With menu displayed, press 2-5-4 + MENU. See page 50 for detailed instructions:
 - **Editing/Adding Channel ICON and Labels on Master TV**
 - **Changing a Channel's ICON on Master TV**
 - **Changing/Adding Channel Labels on Master TV**
 - **Changing Source Labels on Master TV**
8. Verify Master TV setup and feature configuration:
 - Did you add Channel ICONS?
 - Did you add Channel Labels?
 - Did you add Aux Source Labels?
 - Did you adjust all TV menu options as required?The TV master setup is now ready to be cloned. Go to the master TV cloning section or continue on to page 53.

Reference: Software Version Check

Procedure to Check Software Version

The software version of the L20V54S may be checked by accessing the INSTALLER MENU. To do this, press the MENU button at least 10 times until the menu display ceases to respond to MENU key presses. Then, press "9", "8", "7", "6", "OK (Enter/Select)".

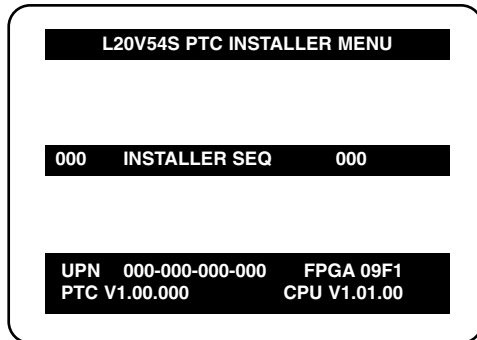

Typical Installer Menu

L20V54S Aux Input Configuration / Troubleshooting

L20V54S Aux Input Configuration

DIRECT ACCESS Tuning		L20V54S		ENABLE				MPI DATA			STATUS AUX SOURCE ASSIGNMENT
				Installer Menu		MPI DATA STATUS TYPE 0x41 SOURCES ENABLED (RW)		DATA STATUS TYPE 0xD2 CURRENT AV SOURCE (R)		DATA STATUS TYPE 0X0D AUX SOURCE (R)	
OLD_OCV =0	OLD_OCV =1	Source Input	Source Mode	Number	Labeling	Value	Labeling	Value	Labeling		
131	91	Video1(Rear)	CV ONLY	39	REAR_AUX_EN	0x02	Rear Video (Aux)	1	Rear Video (Aux)	0(VIDEO)	1
133	93	DVI/HDMI1	DTV/PC Auto	35	COMPPOINT EN	0x08	Front Computer	3	Front Computer	0(VIDEO)	3

Troubleshooting

Some quick and easy tips to resolving problems.

Symptoms	Possible Cause(s)	Possible Solution(s)	See Page(s)
Software Problems			
TV not functioning properly.	Software lockup.	Remove power cord for 5 minutes.	41
Software Corrupted.	2-5-5 + MENU performed more than once.	Start all over with item 117, set to 001, press Enter then redo Auto Program, Channel List, Clock, etc. *Note: 2-5-4 + MENU can be done more than once.	41
Virtual and Physical channels appear in channel scan w/Channel Up/Down.	2-5-5 + MENU not performed.	After Auto Program and Channel List, etc. press 2-5-5 + MENU to transfer channels and TV setup to internal TV controller. Afterward, only Physical or only Virtual channels will appear in digital channel scan, analog channel scan will be normal. *Note: Be sure to set item 028 Ch Override to 000.	41
Can not direct enter channel number	Channel not included in channel scan in TV controller.	After 2-5-5 + MENU, only channels included in TV controller will appear. If channel is available, redo channel scan. If it is not available it will not appear on the TV screen.	41

Troubleshooting

Some quick and easy tips to resolving problems

Symptoms	Possible Cause(s)	Possible Solution(s)	See Page(s)
Power			
No Power.	See troubleshooting flow chart.		57
Display Panel Picture			
No Picture.	<ul style="list-style-type: none"> • Display panel is turned off. • Antenna/Cable not connected. • Connections incorrect. • M.P.I. not connected. • Encrypted program. • Wrong tuning band. 	<ul style="list-style-type: none"> -Turn TV on. -Power failure? -Connect Antenna/Cable signal source to L20V54S. -Check connections on L20V54S. -If applicable, connect M.P.I. cable to M.P.I. device. -Try another channel. -Adjust Installer menu settings. 	9~11 7 / 9~14 45~50
Erratic Operation			
Installer menu setup.	<ul style="list-style-type: none"> • Wrong Installer menu settings. • Software problem. 	<ul style="list-style-type: none"> -Adjust Installer menu settings as required. -Remove TV power cord for 15 seconds. 	45~50
Remote Control			
Remote doesn't work.	<ul style="list-style-type: none"> • Remote not in TV mode. • Not aimed at IR remote sensor. • Remote too far from IR sensor. • IR path to TV's receiver obstructed. • Weak batteries. • Wrong battery polarity. • Too much light in room. • Wrong Installer remote control. • Incorrect Bed 1-2 setting. 	<ul style="list-style-type: none"> -Use Mode key to select TV; puts remote into L20V54S mode. -Point remote at TV's IR receiver on TV. -Move remote closer to TV's IR receiver or darken room. -Remove obstructions. -Replace batteries. -Check that "+" and "-" match in battery compartment. -Dim room light. -Requires compatible Installer remote, contact your LG dealer. -Set correct Bed 1-2 setting. 	18~19 40 18
Picture Reception			
Normal picture, poor or no sound.	<ul style="list-style-type: none"> • Audio muted. • Broadcast problem. 	<ul style="list-style-type: none"> -Press MUTE or use Volume Up key to increase sound level. -Try a different channel. 	18~19 18~19
Broadcast Tuning Mode Digital Channel OSD			
No Information available display.	<ul style="list-style-type: none"> • Item 103 set to 1 physical channels tuning. 	<ul style="list-style-type: none"> - Set Item 103 to 0 for information to be added to virtual channel tuning digital OSD. 	45~50

***Note:** For other problems not caused by the L20V54S, refer to other devices' operating guide.

Reference: Cloning Procedure Troubleshooting



Warning: Do not use LT2002 while a LodgeNet PPV card is installed in TV or clone programmer will be damaged.

Reset Clone After Static Shock

After replacing exhausted batteries, or if the programmer behaves strangely after a static shock, activate the internal reset switch and restore normal operation.

After a reset, check the real-time clock setting. It may be necessary to reset the Clone Programmer clock from a TV containing the correct time.

*Note:

The LT2002 programmer is designed to be used with TVs containing the 221-01006 and later processors. Use with earlier TV sets may give unpredictable results. Processors used before the 221-01006-04 have a limited screen display capability. They cannot display entire screens as shown in the quick setup instructions accompanying the LT2002 clone programmer. Use the printed menu illustrations on the quick setup sheet supplied with the Clone as an aid to making your programming choices. (Although the menus are not all displayed, the clone functions all operate normally.)

Clone Programmer Troubleshooting

Clone Programmer

Cloning Notes: While clone is copying or transferring a master setup, do not touch or otherwise disturb clone or connections between clone and TV. Cloning a master TV setup should take at least 45 seconds. Transferring the master TV setup to the target TV should take at least 45 seconds. Monitor LED on clone to assure that the blinking heartbeat pattern is present throughout clone operations. After cloning, be sure to disconnect power from the target TV for about 15 seconds.

Problem	Possible Cause(s)	Possible Solution(s)
Remote does not operate clone.	<ul style="list-style-type: none">• Wrong Installer remote.	<ul style="list-style-type: none">- Only use an appropriate Installer remote to operate clone programmer with L20V54S.
LED does not blink.	<ul style="list-style-type: none">• M.P.I. cord not connected.• L20V54S not turned on.• Weak batteries.	<ul style="list-style-type: none">- Connect M.P.I. cord.- L20V54S must be powered On for clone to work.- Install 4 fresh AA high-quality alkaline batteries.
Clone menu hard to read.	<ul style="list-style-type: none">• Weak signal.	<ul style="list-style-type: none">- Connect L20V54S to a reliable Analog channel signal source.
No time set.	<ul style="list-style-type: none">• Time not available.	<ul style="list-style-type: none">- Set time on a TV, copy time to Clone Programmer.
Clone not working.	<ul style="list-style-type: none">• Clone programmer problem.	<ul style="list-style-type: none">- Try a different LT2002 Clone programmer.- Reset Clone Programmer.
Clone Scans Channels more than once.	<ul style="list-style-type: none">• Clone should only scan channels once.	<ul style="list-style-type: none">- Retry cloning again.

Master and Other L20V54S

Cloning did not work.	<ul style="list-style-type: none">• Procedure interrupted.• Different TV models.• Step(s) omitted or not performed.• Insufficient cloning time. • Cloning erratic.	<ul style="list-style-type: none">- Wait until procedure complete message is displayed.- Cloning is only possible with identical model TVs.- Reread 43 - 44 - 45 pages to be sure all tasks were performed.- Redo cloning and be sure learning/teaching time is about 1 min. and 5 to 15 seconds (75 seconds).- Reset Clone Programmer.
Clone time disappeared.	<ul style="list-style-type: none">• Batteries were removed.	<ul style="list-style-type: none">- Batteries must remain installed to retain time settings.
New Setup not present.	<ul style="list-style-type: none">• L20V54S not reset.	<ul style="list-style-type: none">- Disconnect newly cloned unit from power for 5 seconds.

- After cloning operations are complete, just unplug the LT2002 from the L20V54S.
- If the L20V54S does not display a picture on the TV (blank screen) after a few seconds, just change channels.

Clone Troubleshooting Flow Chart

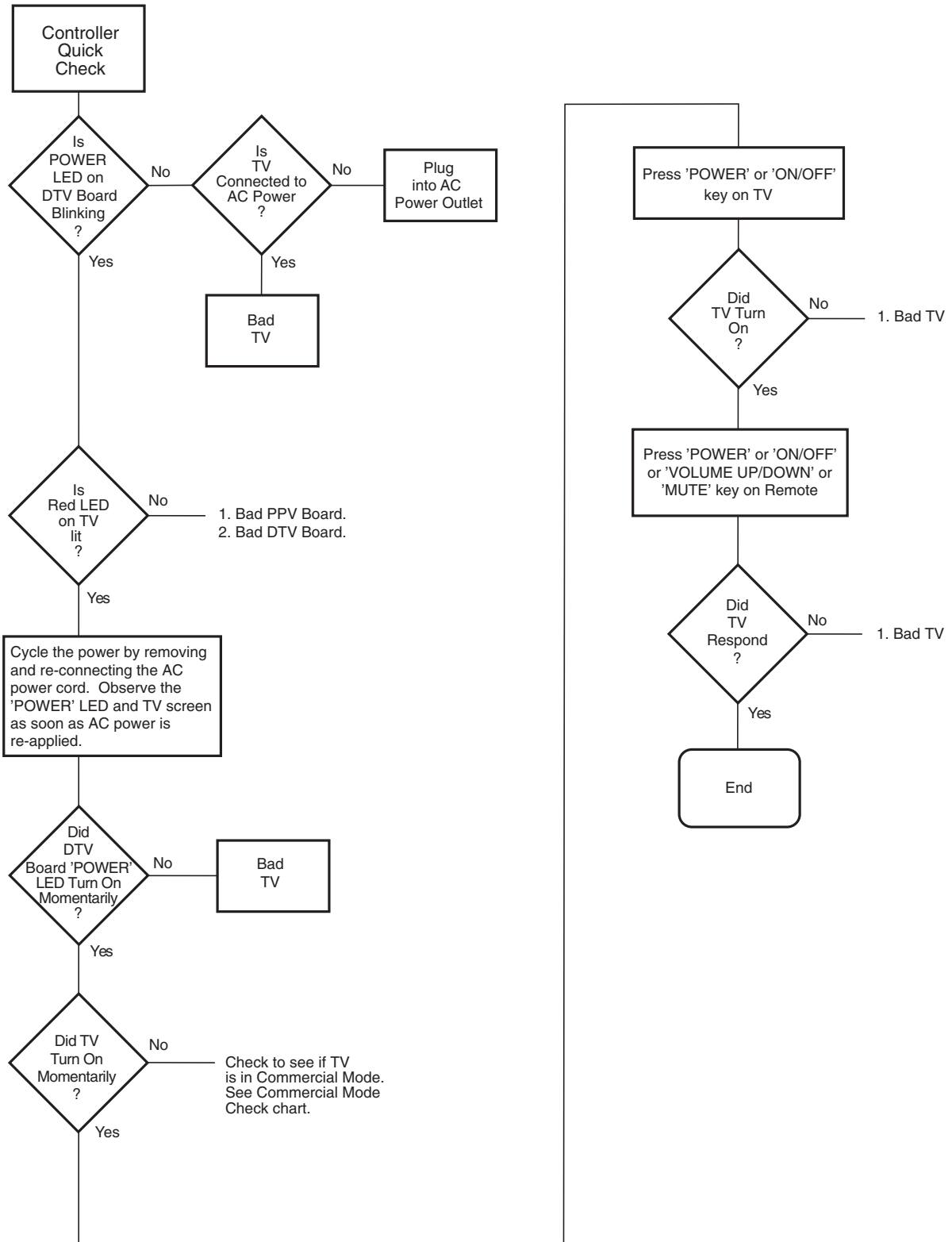

TV Operation Check

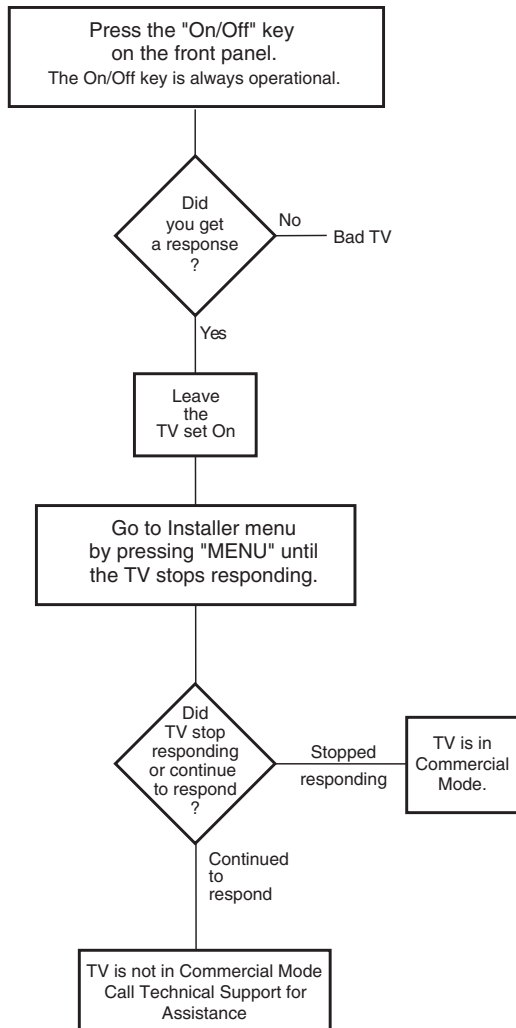

Glossary of Terms

A list of definitions for some of the words found in this guide

75 OHM RF CABLE

The wire that comes from an off-air antenna or cable service provider. The end looks like a hex-shaped nut with a wire sticking through the middle. It screws onto the Antenna/Cable threaded jack on the back of the L20V54S.

300 TO 75 OHM ADAPTER

A small device that connects a two-wire 300 ohm antenna to a 75 ohm RF jack. They are usually about an inch long with two screws on one end and a round opening with a wire sticking out on the other end.

ANALOG TELEVISION

Standard television broadcasting format in 4:3 picture aspect ratio.

A/V CABLES

Audio/Video cables. Three cables bunched together—right audio (red), left audio (white), and video (yellow). A/V cables are used for stereo playback of videocassettes and for higher quality picture and sound from other A/V devices.

A/V DEVICE

Any device that produces video or sound (VCR, DVD, cable box, or television).

AMPLIFIER

An electronic device that amplifies sound from a television, CD player, VCR, DVD, or other Audio/Video device.

ANTENNA

The physical receiver of television signals sent over the air. A large metal piece of equipment does not always have to be visible to be using an antenna.

CABLE

Cable service box. Refers to the descrambler box cable subscribers use to receive cable programming signals.

CATV

Programming provided by a cable service.

DIGITAL TELEVISION

High-resolution, cinema-quality television signals transmitted digitally.

DVI

Digital Video Interface
Accommodates analog and digital interfaces with a single connector.

COMPOSITE VIDEO

Typical video jack, uses one wire for transporting three-color video signals.

DELETED

Lets you remove channels from the list that the end user can scroll through using CH (Channel) Up/Down.

HDMI

High-definition multimedia interface.

HDTV

High-definition television. Refers to television signals that have higher resolution than ordinary analog TV signals.

HDSTB

High-definition set top box. Refers to a tuner device that receives high-definition television signals which have higher resolution than ordinary analog TV signals.

INPUT

Refers to the input jack that receives a signal from a TV, VCR, DVD Player or other Audio/Video device.

JACK

An input or output connector on the back of a TV, VCR, DVD Player or other Audio/Video device.

MONO SOUND

Mono (monaural) sound is one channel of sound. On more than one speaker, all the speakers play the same audio.

OUTPUT

Refers to the output jack that sends a signal out of a VCR, DVD, or other A/V device.

PHYSICAL CHANNEL NUMBER

Actual digital major, dashed minor channel number that a station is broadcasting on.

RGB (Red, Green, Blue)

Connection input or output port available for producing a video image using three separate colors: Red, Green, and Blue.

2ND AUDIO PROGRAMMING/SAP

Second Audio Programming (SAP) is another, separate audio channel available with some programming. Choosing SAP often refers to listening to audio in another language, such as Spanish or French.

SIGNAL

Picture and sound traveling through a cable, or over the air, to the TV.

STEREO SOUND

Stereo (Stereophonic) sound refers to audio that's divided into right and left sides.

TUNER

Device that picks up the broadcast signal and turns it into picture and sound.

VIRTUAL CHANNEL NUMBER

The arbitrarily assigned digital dashed minor channel number that a station is broadcasting on.

Installer Quick Setup Guide

Quick Setup Guide for Integrated Master TVs

See table of contents for more information.

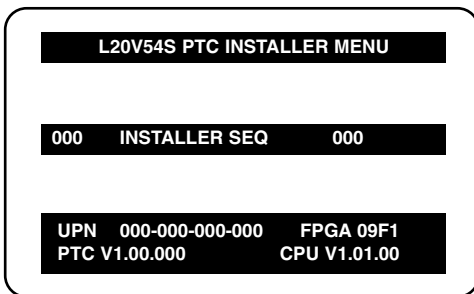
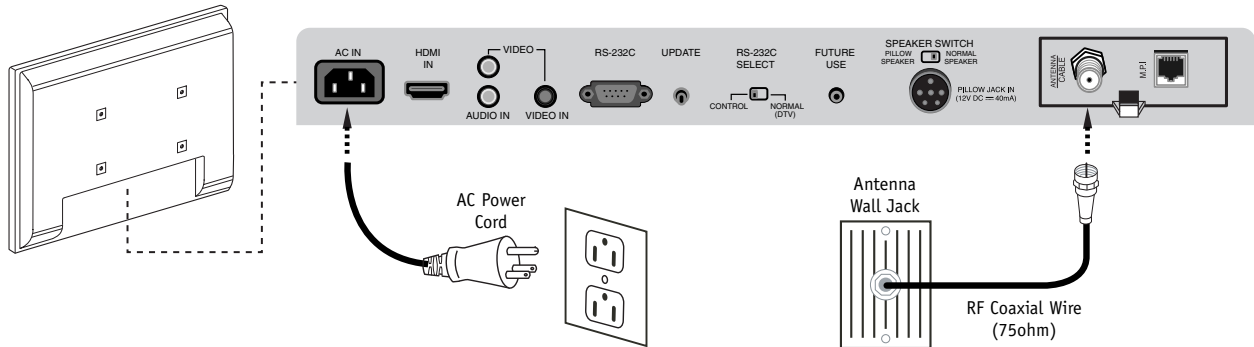

117 FACT DEFAULT 00X

003 BAND/AFC 00X

028 CH.OVERRIDE 001

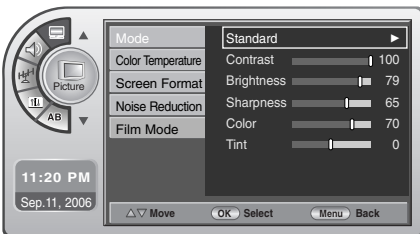
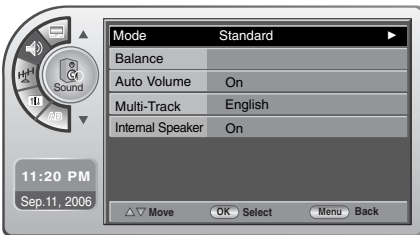

Setup Instructions for Making a Master TV

1. Connect TV to signal source, connect power cord and turn TV power on.
2. Enter the TV installer menu.
 - *Note:** If this is not a new setup, set Installer item 117 to 001 and press Enter to reset TV to default condition.
 - Set Tuning Band.
 - Set Installer menu item **003 BAND/AFC** to CATV: 001, Broadcast: 000 etc.
 - If necessary, set Installer menu item **028 CH OVERRIDE** to 001.
 - In addition, set any other installer items as required of your system.
 - Exit Installer menu.
3. Access the Master TV menu and set the clonable options on the menus to the desired configurations. Refer to the **Clonable Menu Features** Chart for the TV. (Picture, Sound, Time etc.)
4. Do a Channel Search; run Auto Program. (aka EZ Scan.)
5. Enter the Channel Edit menu and delete channels per your requirements.
6. Enter the Channel Label menu and assign ICONs to the channels.
 - *Note:** You can add Channel ICONs typically network logos like ABC, NBC, PBS etc. in this step. Or, in Step 8, add Channel ICONs or custom text labels for channels which no Icons are available for.
7. Transfer the TV setup. After all menu options and features are set to your requirements, enter the installer menu. Press '2', '5', '5', 'MENU' to start the transfer of the TV's setup to the PTC. After the transfer is complete, the system will exit the Installer menu.
8. Set any Channel Labels as needed.
 - a. Enter Installer menu.
 - b. Press '2', '5', '4', 'MENU' to enter the menu. In this menu edit the assigned channel Icons, assign custom text labels for channels and assign labels for active Aux sources. Press 'Menu' to exit.
9. Enter the Installer menu. Set item 028 Ch Override to 000 and exit menu.

028 CH.OVERRIDE 000

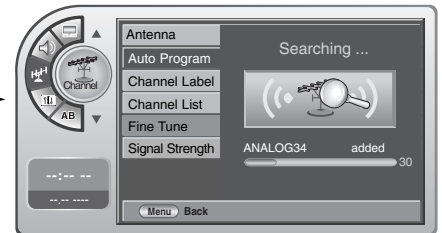
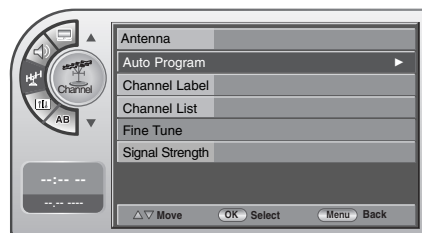
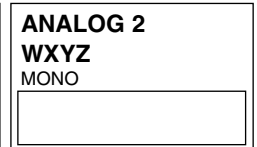
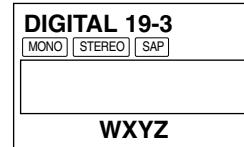

Your Zenith LCD TV/Monitor Warranty



LCD TV/Monitor

Welcome to the LG family! We believe that you will be pleased with your LCD TV/Monitor. Please read this warranty carefully, it is a "LIMITED WARRANTY" as defined under Federal Law. This warranty gives you specific legal rights, and you may also have other rights that vary from state-to-state within the U.S.A.

LG'S RESPONSIBILITY

Service Labor

During a period of one year from effective warranty date, LG will provide service labor by a LG authorized service center when needed, as determined by the LG service center, as a result of manufacturing defects.

Parts

New or remanufactured replacements for factory-defective parts will be supplied by an LG authorized service center for one year from effective warranty date (color picture tube — two years). Such replacement parts are warranted for the remaining portion of the original warranty period.

Warranty Service

Warranty service is provided. (Some repairs may require the unit to be taken by the service to the repair facility and returned, at no additional charge.) Call 1-888-865-3026 for further information.

Not Covered

This warranty covers manufacturing defects and does not cover installation, adjustment of customer controls, installation or repair of antenna systems, cable converters or cable company-supplied equipment; it also does not cover damage due to misuse, abuse, negligence, acts of God or other causes beyond the control of LG. Any alteration of the product after manufacture voids this warranty in its entirety.

THIS WARRANTY IS IN LIEU OF ANY OTHER WARRANTY, EXPRESS OR IMPLIED, INCLUDING WITHOUT LIMITATION, ANY WARRANTY OF MERCHANTABILITY OR FITNESS FOR A PARTICULAR PURPOSE, AND NEITHER THE MANUFACTURER NOR ITS DISTRIBUTORS SHALL NOT BE LIABLE FOR ANY CONSEQUENTIAL, INDIRECT, OR INCIDENTAL DAMAGES OF ANY KIND, INCLUDING LOST REVENUES OR PROFITS IN CONNECTION WITH THIS PRODUCT. SOME STATES DO NOT ALLOW LIMITATIONS ON HOW LONG AN IMPLIED WARRANTY LASTS OR THE EXCLUSION OR LIMITATION OF INCIDENTAL OR CONSEQUENTIAL DAMAGES, SO THE ABOVE LIMITATIONS OR EXCLUSIONS MAY NOT APPLY TO YOU.

OWNER'S RESPONSIBILITY

Effective Warranty Date

Warranty begins on the date of installation of the Commercial Products LCD TV/Monitor.
For your convenience, keep the dealer's dated bill of sale or delivery ticket as evidence of the purchase date.

Operating Guide

Read the Installation and Operating Guide carefully so that you will understand the operation of the unit and how to adjust the controls.

Antenna

Reception problems caused by inadequate antenna or faulty antenna connections are the owner's responsibility.

Warranty Service

For warranty service information, call 1-888-865-3026. Parts and service labor that are LG's responsibility (see above) will be provided without charge. Other service is at the owner's expense. If you have any problem in obtaining satisfactory warranty service, call 1-888-865-3026.

- You must provide the model number, serial number and date of purchase or date of original installation.
- Before you ask for warranty service, read "Troubleshooting" in this installation guide. You might avoid a service call.

For Customer Support/Service
Please call:

1-888-865-3026

www.zenith.com
www.lgcommercial.com

Marketed and Distributed in the United States by LG Electronics U.S.A., Inc.
2000 Millbrook Drive, Lincolnshire, IL 60069.

Free Manuals Download Website

<http://myh66.com>

<http://usermanuals.us>

<http://www.somanuals.com>

<http://www.4manuals.cc>

<http://www.manual-lib.com>

<http://www.404manual.com>

<http://www.luxmanual.com>

<http://aubethermostatmanual.com>

Golf course search by state

<http://golfingnear.com>

Email search by domain

<http://emailbydomain.com>

Auto manuals search

<http://auto.somanuals.com>

TV manuals search

<http://tv.somanuals.com>