

Installation and Operating Guide | Warranty

Model Numbers | R45W47, R50W47, R57W47 | Projection TV



© Copyright 2004, LG Electronics USA, Inc.



Warning



WARNING
RISK OF ELECTRIC SHOCK
DO NOT OPEN



WARNING:
TO REDUCE THE RISK OF ELECTRIC SHOCK DO NOT REMOVE COVER (OR BACK). NO USER SERVICEABLE PARTS INSIDE. REFER TO QUALIFIED SERVICE PERSONNEL.

The lightning flash with arrowhead symbol, within an equilateral triangle, is intended to alert the user to the presence of uninsulated "dangerous voltage" within the product's enclosure that may be of sufficient magnitude to constitute a risk of electric shock to persons.

The exclamation point within an equilateral triangle is intended to alert the user to the presence of important operating and maintenance (servicing) instructions in the literature accompanying the appliance.

WARNING:

TO PREVENT FIRE OR SHOCK HAZARDS, DO NOT EXPOSE THIS PRODUCT TO RAIN OR MOISTURE.

POWER CORD POLARIZATION:

CAUTION: TO PREVENT ELECTRIC SHOCK, MATCH WIDE BLADE OF PLUG TO WIDE SLOT, FULLY INSERT.

NOTE TO CABLE/TV INSTALLER:

This reminder is provided to call the CATV system installer's attention to Article 820-40 of the National Electric Code (U.S.A.). The code provides guidelines for proper grounding and, in particular, specifies that the cable ground shall be connected to the grounding system of the building, as close to the point of the cable entry as practical.

REGULATORY INFORMATION:

This equipment has been tested and found to comply with the limits for a Class B digital device, pursuant to Part 15 of the FCC Rules. These limits are designed to provide reasonable protection against harmful interference when the equipment is operated in a residential installation. This equipment generates, uses and can radiate radio frequency energy and, if not installed and used in accordance with the instruction manual, may cause harmful interference to radio communications. However, there is no guarantee that interference will not occur in a particular installation. If this equipment does cause harmful interference to radio or television reception, which can be determined by turning the equipment off and on, the user is encouraged to try to correct the interference by one or more of the following measures:

- Reorient or relocate the receiving antenna.
- Increase the separation between the equipment and receiver.
- Connect the equipment into an outlet on a circuit different from that to which the receiver is connected.
- Consult the dealer or an experienced radio/TV technician for help.

Any changes or modifications not expressly approved by the party responsible for compliance could void the user's authority to operate the equipment.

CAUTION:

Do not attempt to modify this product in any way without written authorization from Zenith Electronics. Unauthorized modification could void the user's authority to operate this product.

COMPLIANCE:

The responsible party for this product's compliance is:

Zenith Electronics Corporation

1-201-816-2000

Marked and Distributed in the United States by LG Electronics U.S.A., Inc.

1000 Sylvan Avenue, Englewood Cliffs, NJ 07632

<http://www.zenith.com>

Safety Instructions

Important safeguards for you and your new product

Your product has been manufactured and tested with your safety in mind. However, improper use can result in electrical shock or fire hazards. To avoid defeating the safeguards that have been built into your new product, please read and observe the following safety points when installing and using your new product, and save them for future reference.

Observing the simple precautions discussed in this manual can help you get many years of enjoyment and safe operation that are built into your new product.

This product complies with all applicable U.S. Federal safety requirements, and those of the Canadian Standards Association.

1. Read Instructions

All the safety and operating instructions should be read before the product is operated.

2. Follow Instructions

All operating and use instructions should be followed.

3. Retain Instructions

The safety and operating instructions should be retained for future reference.

4. Heed Warnings

All warnings on the product and in the operating instructions should be adhered to.

5. Cleaning

Unplug this product from the wall outlet before cleaning. Do not use liquid cleaners or aerosol cleaners. Use a damp cloth for cleaning.

6. Water and Moisture

Do not use this product near water, for example, near a bath tub, wash bowl, kitchen sink, or laundry tub, in a wet basement, or near a swimming pool.

7. Accessories, Carts, and Stands

Do not place this product on a slippery or tilted surface, or on an unstable cart, stand, tripod, bracket, or table. The product may slide or fall, causing serious injury to a child or adult, and serious damage to the product. Use only with a cart, stand, tripod, bracket, or table recommended by the manufacturer, or sold with the product. Any mounting of the product should follow the manufacturer's instructions, and should use a mounting accessory recommended by the manufacturer.

8. Transporting Product

A product and cart combination should be moved with care. Quick stops, excessive force, and uneven surfaces may cause the product and cart combination to overturn.

9. Attachments

Do not use attachments not recommended by the product manufacturer as they may cause hazards.

10. Ventilation

Slots and openings in the cabinet are provided for ventilation and to ensure reliable operation of the product and to protect it from overheating, and these openings must not be blocked or covered. The openings should never be blocked by placing the product on a bed, sofa, rug, or other similar surface. This product should not be placed in a built-in installation such as a bookcase or rack unless proper ventilation is provided or the manufacturer's instructions have been adhered to.

11. Power Sources

This product should be operated only from the type of power source indicated on the marking label. If you are not sure of the type of power supply to your home, consult your product dealer or local power company. For products intended to operate from battery power, or other sources, refer to the operating instructions.

12. Power-Cord Polarization

This product is equipped with a wire grounding type plug, a plug having a third (grounding) pin. This plug will only fit into the grounding-type power outlet. This is a safety feature. If you are unable to insert the plug into the outlet, contact your electrician to replace your obsolete outlet. Do not defeat the safety purpose of the grounding-type plug.

13. Power-Cord Protection

Power-supply cords should be routed so that they are not likely to be walked on or pinched by items placed upon or against them, paying particular attention to cords at plugs, convenience receptacles, and the point where they exit from the product.



PORTABLE CART WARNING

Safety Instructions continued

14. Outdoor Antenna Grounding

If an outside antenna or cable system is connected to the product, be sure the antenna or cable system is grounded so as to provide some protection against voltage surges and built-up static charges. Article 810 of the National Electrical Code (U.S.A.), ANSI/ NFPA 70 provides information with regard to proper grounding of the mast and supporting structure, grounding of the lead-in wire to an antenna discharge unit, size of grounding conductors, location of antenna-discharge unit, connection to grounding electrodes, and requirements for the grounding electrode.

Example of Grounding According to National Electrical Code Instructions

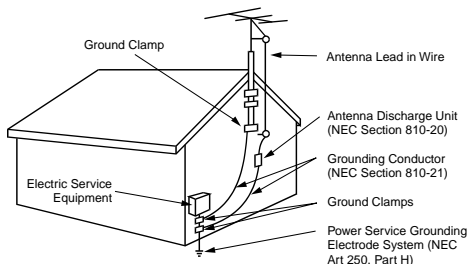

NEC - National Electrical Code

15. Lightning

For added protection for this product (receiver) during a lightning storm, or when it is left unattended and unused for long periods of time, unplug it from the wall outlet and disconnect the antenna or cable system. This will prevent damage to the product due to lightning and power-line surges.

16. Power Lines

An outside antenna system should not be located in the vicinity of overhead power lines or other electric light or power circuits, or where it can fall into such power lines or circuits. When installing an outside antenna system, extreme care should be taken to keep from touching such power lines or circuits as contact with them might be fatal.

17. Overloading

Do not overload wall outlets and extension cords as this can result in a risk of fire or electric shock.

18. Object and Liquid Entry

Never push objects of any kind into this product through openings as they may touch dangerous voltage points or short-out parts that could result in a fire or electric shock. Never spill liquid of any kind on the product.

19. Servicing

Do not attempt to service this product yourself as opening or removing covers may expose you to dangerous voltage or other hazards. Refer all servicing to qualified service personnel.

20. Damage Requiring Service

Unplug this product from the wall outlet and refer servicing to qualified service personnel under the following conditions:

- If the power-supply cord or plug is damaged.
- If liquid has been spilled, or objects have fallen into the product.
- If the product has been exposed to rain or water.
- If the product does not operate normally by following the operating instructions. Adjust only those controls that are covered by the operating instructions as an improper adjustment of other controls may result in damage and will often require extensive work by a qualified technician to restore the product to its normal operation.
- If the product has been dropped or the cabinet has been damaged.
- If the product exhibits a distinct change in performance.

21. Replacement Parts

When replacement parts are required, be sure the service technician has used replacement parts specified by the manufacturer or have the same characteristics as the original part. Unauthorized substitutions may result in fire, electric shock, or other hazards.

22. Safety Check

Upon completion of any service or repairs to this product, ask the service technician to perform safety checks to determine that the product is in proper operating condition.

23. Wall or Ceiling Mounting

The product should be mounted to a wall or ceiling only as recommended by the manufacturer. The product may slide or fall, causing serious injury to a child or adult, and serious damage to the product.

24. Heat

The product should be situated away from heat sources such as radiators, heat registers, stoves, or other products (including amplifiers) that produce heat.

Contents

Warnings2	Time Menu Options	
Safety Instructions3~4	Auto Clock Setup20
Introduction		Manual Clock Setup20
Controls6	On/Off Timer Setup20
Connection Options7	Sleep Timer / Auto Off21
Remote Control Key Functions8	Option Menu Features	
Installation		Aspect Ratio Control22
External Equipment Connections9~12	Caption22
Antenna Connection9	Caption Mode23
VCR Setup / Cable TV (CATV) Setup10	Caption Option23
Monitor Out Setup10	VM (Velocity Modulation)24
External A/V Source Setup11	Auto Convergence24
DVD Setup / External Stereo11	EZ Demo24
HDSTB Setup / Digital Audio Output12	Lock Menu Options	
Dolby Digital Audio Connection12	Parental Lock Setup26
EZ Notice; Make A/V Connection12	PIP (Picture-in-Picture)/POP/Twin Picture	
Operation		Watching the PIP/POP/Twin Picture27
TV Operation Overview13	Selecting an Input Signal Source for PIP/Twin Picture ..	.27
On-screen Menus Language Selection13	Swapping PIP/Twin Picture27
Setup Menu Options		TV Program Selection for PIP/Twin Picture ..	.27
EZ Scan (Channel Search)14	Moving the PIP Sub Picture28
Channel Edit14	Adjusting Main and Sub Picture Sizes for Twin Picture ..	.28
DTV Signal Strength15	POP (Picture-out-of-Picture: Channel Scan) ..	.28
Channel Labels Setup15	Programming the Remote29
Main Picture Source Selection15	Programming Codes30~31
Video Menu Options		Troubleshooting Checklist32~33
EZ Picture16	Maintenance34
Manual Picture Control (Off Option)16	Product Specifications34
Color Temperature Control16	Notes35
Z-View17	WarrantyBack cover
Video Preset17		
Audio Menu Options			
Audio Language18		
EZ SoundRite / EZ Sound18		
Manual Sound Control (Off Option)18		
Stereo/SAP Broadcasts Setup19		
Front Surround19		
TV Speakers Setup19		

Setup and Operation Checklist

Setup and Operation Checklist
(See pages 11~15 for available connection and operational setup options.)

1. Unpack TV and all accessories.
2. Connect all external video and audio equipment.
see pages 9 ~ 12.
3. Install batteries in remote control.
See page 8.
4. Turn TV on.
See page 13.
5. Turn video source equipment on.
6. Select viewing source for TV.
See page 15.
7. Fine-tune source image and sound to your personal preference or as required by source.
See pages 16 ~ 19.
8. Additional features set up
See Contents above.

After reading this manual, keep it handy for future reference.

Introduction

Controls

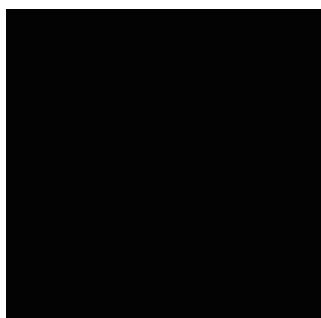
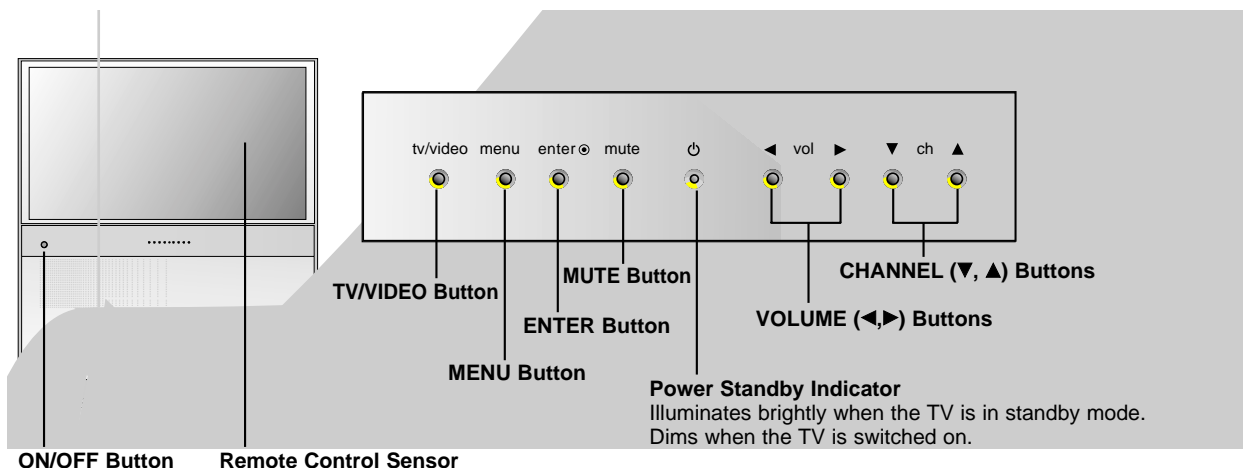

Securing TV Position

- Position the TV and prevent it from being moved, by placing the 4 stoppers under the roller casters on the bottom of the TV.
- **Casters (on TV bottom)**
Use to turn and move the TV easily.

Connection Options

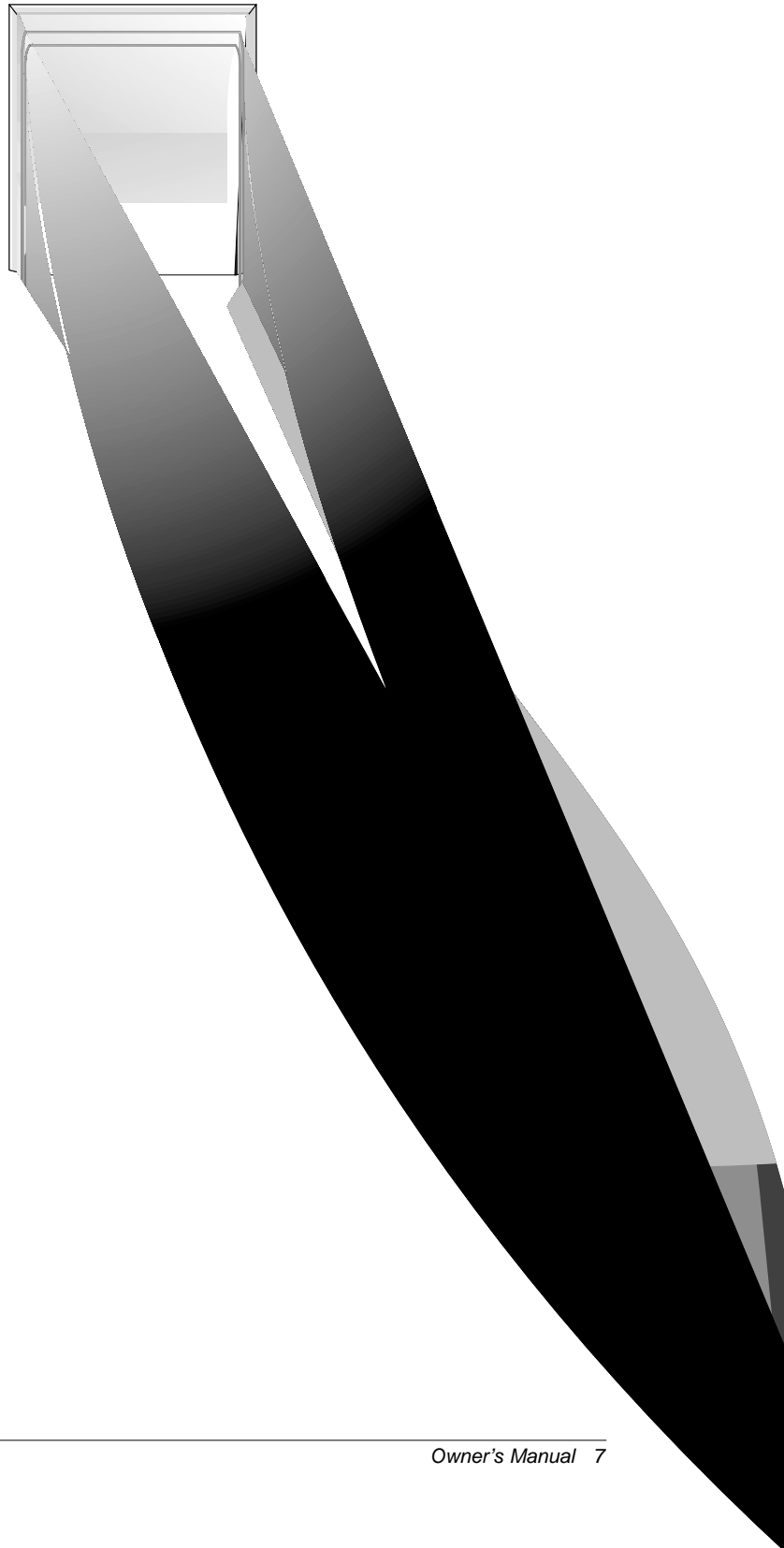

Remote Control Key Functions

- When using the remote control, aim it at the remote control sensor on the TV.

LIGHT
Illuminates the remote control buttons.

MODE
Selects the remote operating mode: TV, VCR, Cable Box, DVD, or Satellite. Select other operating modes, for the remote to operate external devices.

TV/VIDEO
Selects: DTV, Analog, Video1-2, Front Video, Video4, Component 1-2, and DVI input sources.

RATIO
Changes the aspect ratio.

NUMBER buttons

DASH
Used to enter a program number for multiple program channels such as 2—1,2—2, etc.

MUTE
Switches the sound on or off.

AUDIO
Selects MTS sound: Mono, Stereo, and SAP. Change the audio language in DTV mode.

VOLUME UP/DOWN
Increases/decreases the sound level.

INFO
When you watch the TV, displays information on top of the screen. Not available in Component 1-2, RGB and DVI mode.

TIMER
Lets you select the amount of time before your TV turns itself off automatically.

THUMBSTICK (Up/Down/Left/Right/OK)
Allows you to navigate the on-screen menus and adjust the system settings to your preference.

MENU
Brings up the main menu to the screen.

VCR/DVD BUTTONS
Control some video cassette recorders or DVD player ("RECORD" button is not available for DVD player).

MODE INDICATOR LIGHTS
Show active remote mode every time any button is pressed.

POWER
Turns your TV or any other programmed equipment on or off, depending on mode.

FRONT
Selects the front video input sources.

COMP/DVI
Selects: Component 1-2, and DVI input sources.

FREEZE
Freezes the currently-viewed picture. Main picture is frozen in PIP/Twin picture mode.

SIGNAL
Displays the digital signal strength.

FLASHBK
Tunes to the last channel viewed.

SURF
Use to scroll the Surf channel list.

VIDEO
Adjusts the factory preset picture according to the room.

CHANNEL UP/DOWN
Selects available channels found with EZ scan.

PIP
Switches between PIP, POP (Picture-out-of-Picture) and Twin picture modes.

PIPCH-/PIPCH+
Changes to next higher/lower PIP channel.

PIP INPUT
Selects the input source for the sub picture.

SWAP
Exchanges the PIP/main images.

CC
Select a closed caption: Off, EZ Mute, and On.

EXIT
Clears all on-screen displays and returns to TV viewing from any menu.

Installing Batteries

- Open the battery compartment cover on the back side and install the batteries matching correct polarity (+ with +, - with -).
- Install two 1.5V AA batteries. Don't mix old or used batteries with new ones. Replace cover.

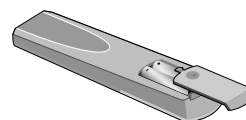

Antenna Connection

Connections for Analog and Digital TV signals provided on one antenna

- Antenna or Cable Service without a Cable Box Connections
- For optimum picture quality, adjust antenna direction if needed.

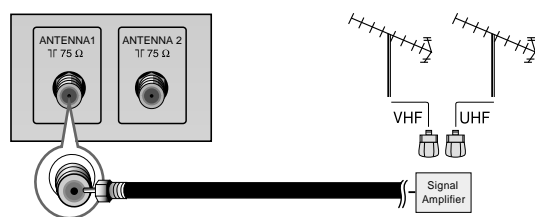
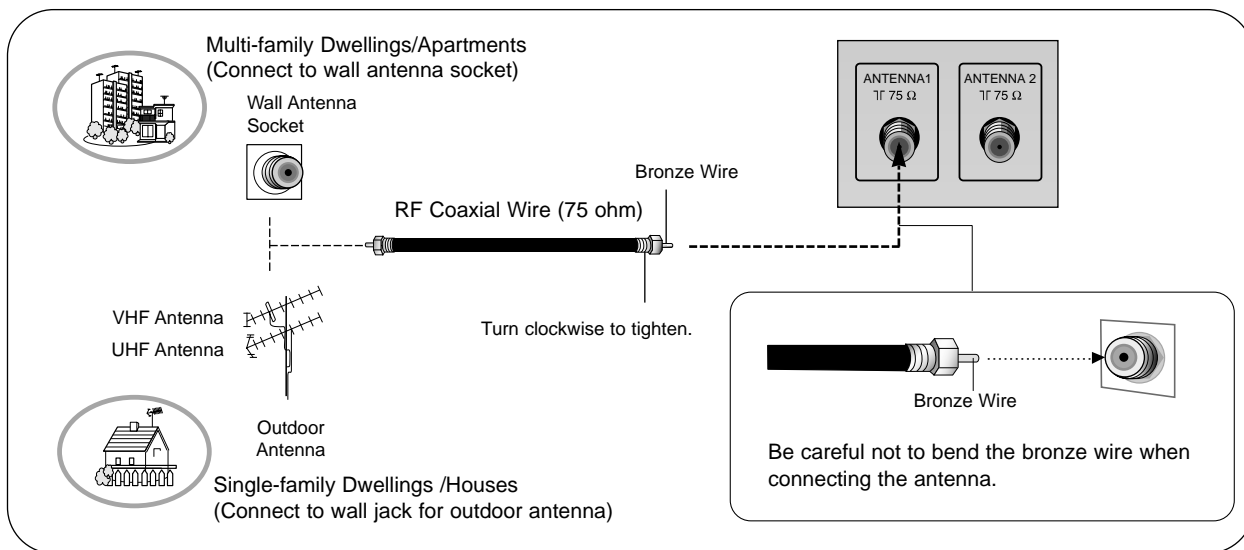

- In a poor signal area to improve picture quality, purchase and install a signal amplifier.
- If the antenna needs to be split for two TV's, install a "2-Way Signal Splitter" in the connections.
- If the antenna is not installed properly, contact your dealer for assistance.

Connections for Analog and Digital TV signals provided on two separate antennas

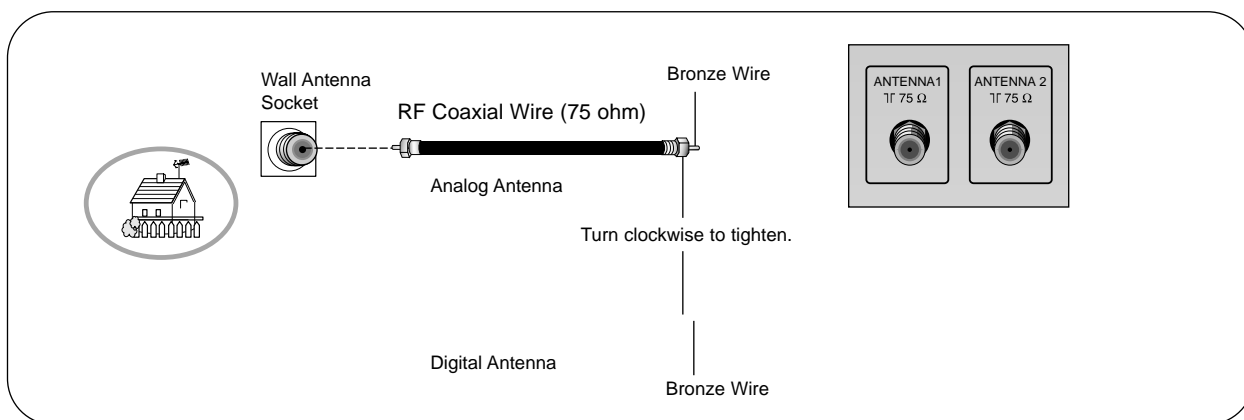

NOTE: If you are not sure of the type of signal(s) you are receiving, let EZ Scan complete all the channel signal-type searches. The TV will let you know when the analog, cable, and digital channel scans are complete.

VCR Setup

Connection Option 1

Set VCR output switch to 3 or 4 and then tune TV to the same channel number.

Connection Option 2

1. Connect the audio/video output jacks on VCR to the corresponding input jacks on the TV.
When connecting the TV to VCR, match the jack colors (Video = yellow, Audio Left = white, and Audio Right = red). If you have available an S-VIDEO output, the picture quality is improved; compared to connecting a regular VCR to the Video input.
2. Insert a video tape into the VCR and press PLAY on the VCR. (Refer to the VCR owner's manual.)
3. Select the input source with the **tv/video** button on the remote control. (If connected to **IN 1**, select **Video 1** input source)

Do not connect to both Video and S-Video at the same time.

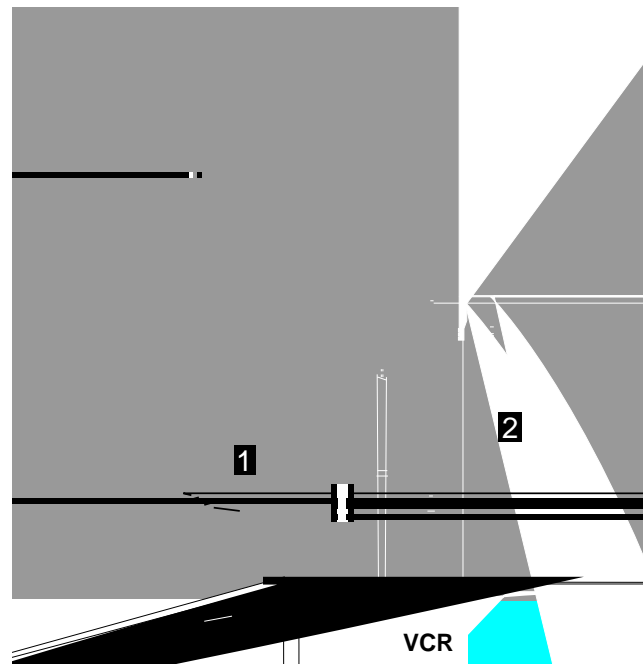

HDSTB Setup

- This TV can receive Digital Over-the-air/Cable signals without an external digital set-top box. However, if you do receive Digital signals from a digital set-top box or other digital external device, refer to the figure as shown below.
- This TV supports HDCP (High-bandwidth Digital Contents Protection) protocol for DTV (480p,720p,1080i) modes.

How to connect

Use the TV's COMPONENT (Y, P_B, P_R) INPUT or DVI inputs for video connections, depending on your set-top box connection options. Then, make the corresponding audio connections.

How to use

1. Turn on the digital set-top box. (Refer to the owner's manual for the digital set-top box.)
2. Use **tv/video** or **comp/dvi** on the remote control to select **Component 1**, **Component 2**, or **DVI** source.

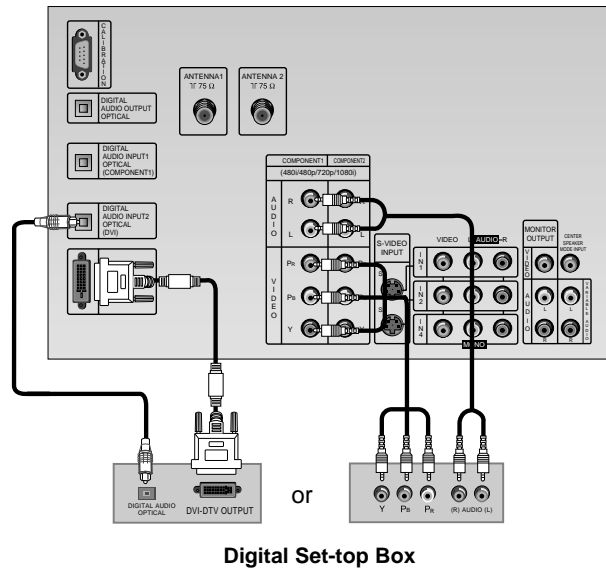

Digital Audio Output

Send the TV's audio to external audio equipment (stereo system) via the Digital Audio Optical Output port.

How to connect

1. Connect one end of an optical cable to the TV Digital Audio Optical Output port.
2. Connect the other end of the optical cable to the digital audio optical input on the audio equipment.
3. Set the **TV Speaker** option to - **"Off"**, see the AUDIO menu. Refer to page 19.
See the external audio equipment instruction manual for operation.

Caution: Do not look into the optical output port. Looking at the laser beam may damage your vision.

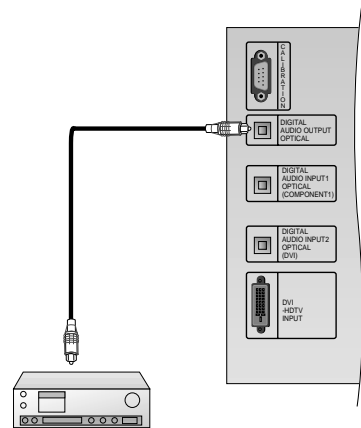

Dolby Digital Audio Connection

How to connect

1. Connect the Dolby Digital Output jacks from the TV to the input jacks on the Dolby Digital Receiver.
2. Set up your Dolby Digital Receiver according to the directions provided with that device.
3. If you wish to use your TV as the "Center channel" for your home theater, re-direct the center channel to **Center speaker mode input** jack on the TV. Set the **TV Speaker** option to - **"Center Speaker"** on the AUDIO menu. Refer to page 19.

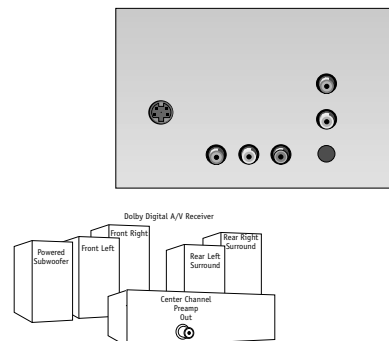

EZ Notice: Make A/V Connection

You have to connect the external equipment to select the input source with the tv/video, or comp/dvi button on the remote control. (You can select every input source with front button though your TV disconnect to an external equipment.)

Operation

* In this manual, the OSD (On Screen Display) may be different from your TV's because it is just example to help the TV operation.

TV Operation Overview

1. First, make all equipment connections. Connect power cord correctly. At this time, the TV is switched to stand-by mode.
 - In standby mode, press the **power**, **tv/video**, **comp/dvi**, **front**, **ch (+, -)**, **Number (0 ~ 9)** button on the remote control or **on/off**, **tv/video**, **ch (▲ / ▼)** located on the TV to turn the TV on.
2. Select the viewing source by pressing **tv/video**, **front** or **comp/dvi** repeatedly.
 - Note: See page 14 if you have not auto programmed the TV to receive channels in your local broadcast area.
3. After viewing, press the **power** button on the remote control or **on/off** located on the TV. The TV reverts to stand-by mode.

NOTE

- If you intend to be away on vacation, disconnect the power plug from the wall power outlet.

On-screen Menus Language Selection

- The menus can be shown on the screen in the selected language. First select your language.

1. Press the **menu** button and then use **▲ / ▼** button to select the **OPTION** menu.
2. Press the **▶** button and then use **▲ / ▼** button to select **Language**.
3. Press the **▶** button and then use **▲ / ▼** button to select your desired language, and the on-screen menus will then appear in that language.
4. Press **exit** button to return to TV viewing or press **menu** button to return to the previous menu.

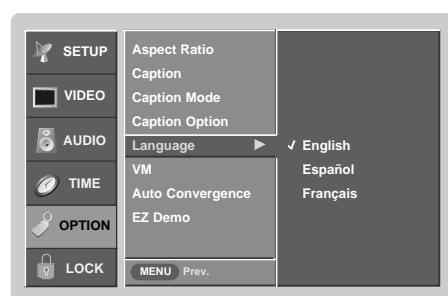

EZ Scan (Channel Search)

- Automatically finds all channels available through the antenna and cable sources, and stores them in memory on the channel list.
- Run EZ Scan again after any Antenna/Cable connection change.

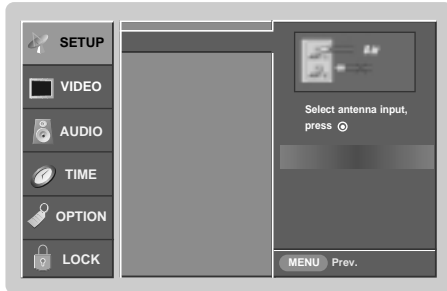

1. Press the **menu** button and then use **▲ / ▼** button to select the **SETUP** menu.
2. Press the **▶** button and then use **▲ / ▼** button to select **EZ Scan**.
3. Press the **▶** button and then use **▲ / ▼** button to select antenna input (Based on your connections to antenna 1-2).
 - Analog/DTV Air:
Watching Over-the-air, cable, and digital over-the-air signals via antenna 1 input jack.
 - Analog/DTV Cable:
Watching Over-the-air, cable, and digital cable signals via antenna 1 input jack.
 - Analog+DTV Air (ANT2):
Watching Over-the-air, and cable signal via antenna 1 input port and the digital over-the-air signal via the antenna 2 input jack.
 - Analog/DTV Cable (ANT2):
Watching Over-the-air, and cable signal via antenna 1 input port and the digital cable signal via the antenna 2 input jack.

* Cable Service Band Note: Select Std=Standard, HRC=HRC Band, or IRC=IRC Band.
(For further band information, contact your cable service provider.)
4. Press the **enter** button to begin the channel search.
Allow EZ Scan to complete the channel search cycle for TV, CATV, and DTV/CADTV.

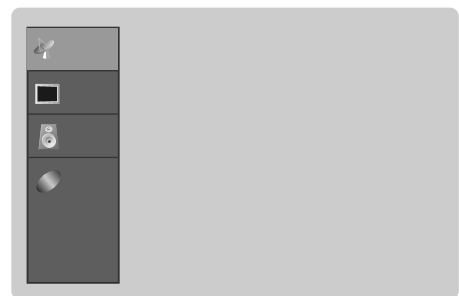

DTV Signal Strength

- Reveals how strong your DTV signal is and whether you need to adjust your antenna or digital cable input. The higher the signal strength, the less likely you are to experience picture degradation.
- Digital DTV Signals: May not be available in all areas, nor are broadcast on all programs.

1. Press the **signal** button.
2. View the on-screen signal strength monitor to see the quality of the signal being received.
 - You can also check the **DTV Signal** strength with the **SETUP** menu.

Channel Labels Setup

- Choose preset labels for your channels.
- If a channel label is provided on the signal from the broadcasting station, the TV displays a short name for a DTV channel - even if you didn't preset a label for the channel.

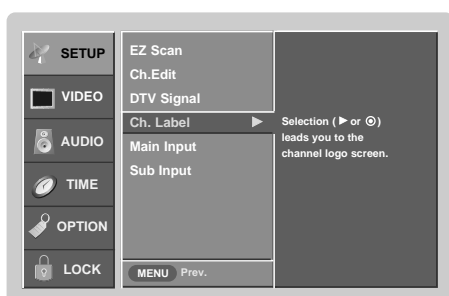

1. Press the **menu** button and then use **▲ / ▼** button to select the **SETUP** menu.
2. Press the **▶** button and then use **▲ / ▼** button to select **Ch. Label**.
3. Press the **▶** button. You will now see a menu filled with labels and a preview screen.
4. Use the **ch +/-** button to select a channel to label.
5. Use **▲ / ▼ / ◀ / ▶** button to select the appropriate label for the channel, then press **enter** button to set the label to the selected channel.
6. Press **exit** button to return to TV viewing or press **menu** button to return to the previous menu.

Main Picture Source Selection

- Changes the picture source so you can watch your off-air TV, cable TV, VCR, DVD, or any other devices that are connected to your TV.

1. Press the **menu** button and then use **▲ / ▼** button to select the **SETUP** menu.
2. Press the **▶** button and then use **▲ / ▼** button to select **Main Input**.
3. Press the **▶** button and then use **▲ / ▼** button to select the source: DTV, Analog, Video1, Video2, Front Video, Video4, Component1, Component2, or DVI.
4. Press **exit** button to return to TV viewing or press **menu** button to return to the previous menu.

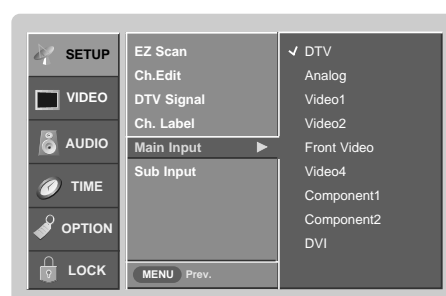

Video Menu Options

EZ Picture

- EZ Picture adjusts the TV for the best picture appearance. Choose the option on the EZ Picture menu that is appropriate for the kind of picture.
 - If adjusting Video menu options (contrast, brightness, color, sharpness, tint, or color temperature) manually, EZ Picture automatically changes to **Off**.
 - **Normal, Digital Preset, Night Time, Movie, Weak Signal, Video Game, and Sports** settings are preset for optimum picture quality at the factory and are not adjustable.
1. Press the **video** button repeatedly to select a picture appearance option from the following: **Off** (your own settings), **Normal, Digital Preset, Night Time, Movie, Weak Signal, Video Game, or Sports**.
 - You can also use the **VIDEO** menu to adjust **EZ Picture**.
 2. Press the **exit** button to save and return to TV viewing.

Manual Picture Control (**Off** option)

- Adjust the picture appearance to suit your preference and viewing situation.
1. Press the **menu** button and then use **▲ / ▼** button to select the **VIDEO** menu.
 2. Press the **▶** button and then use **▲ / ▼** button to select the desired picture option (**Contrast, Brightness, Color, Sharpness, or Tint**).
 3. Press the **▶** button and then use **◀ / ▶** button to make appropriate adjustments.
 4. Press **exit** button to return to TV viewing or press **menu** button to return to the previous menu.

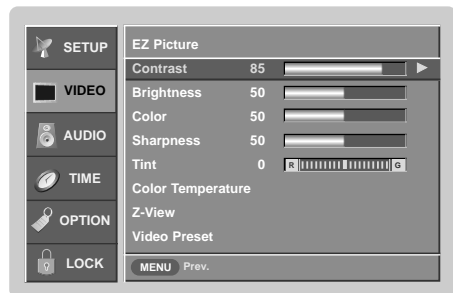

Color Temperature Control

- Choose one of three automatic color adjustments. Set to warm to enhance hotter colors such as red, or set to cool to see less intense colors with more blue. Set to Medium for normal color.
1. Press the **menu** button and then use **▲ / ▼** button to select the **VIDEO** menu.
 2. Press the **▶** button and then use **▲ / ▼** button to select **Color Temperature**.
 3. Press the **▶** button and then use **▲ / ▼** button to select either **Warm, Medium, or Cool**.
 4. Press **exit** button to return to TV viewing or press **menu** button to return to the previous menu.

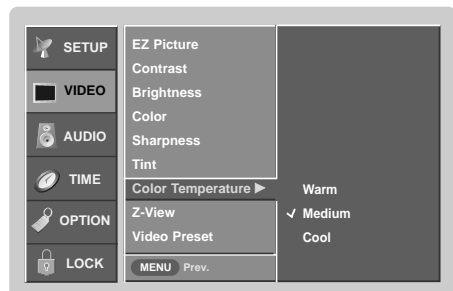

Z-View

- Automatically adjusts the picture for optimum quality.
1. Press the **menu** button and then use ▲ / ▼ button to select the **VIDEO** menu.
 2. Press the ► button and then use ▲ / ▼ button to select **Z-View**.
 3. Press the ► button and then use ▲ / ▼ button to select **Off** or **On**.
 - **On**, automatically adjusts the picture display for optimum quality.
 4. Press **exit** button to save and return to TV viewing.

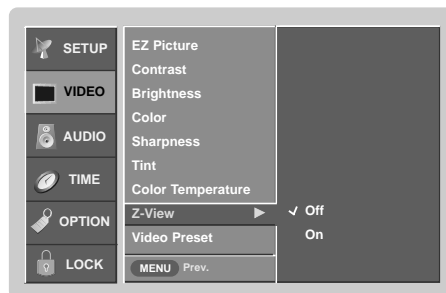

Video Preset

- Use to quickly reset all the Video menu options to their original factory preset values.
1. Press the **menu** button and then use ▲ / ▼ button to select the **VIDEO** menu.
 2. Press the ► button and then use ▲ / ▼ button to select **Video Preset**.
 3. Press the ► button to reset the Video menu options to original values.

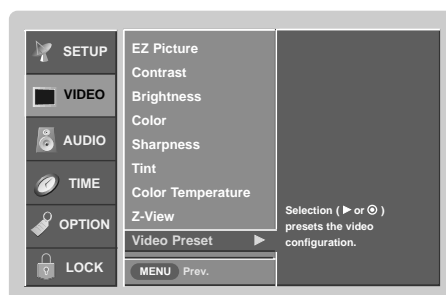

Audio Menu Options

Audio Language

- Other languages may be available if a digital signal is provided by the broadcasting station.
1. Press the **menu** button and then use **▲ / ▼** button to select the **AUDIO** menu.
 2. Press the **▶** button and then use **▲ / ▼** button to select **Audio Language**.
 3. Press the **▶** button and then use **▲ / ▼** button to select: English, Spanish, or French.
 4. Press **exit** button to return to TV viewing or press **menu** button to return to the previous menu.



EZ SoundRite

- Scans for changes in sound level during commercials, then adjusts the sound to match the specified audio level. SoundRite makes sure that the volume level remains consistent whether you are watching a commercial or a regular TV program.
1. Press the **menu** button and then use **▲ / ▼** button to select the **AUDIO** menu.
 2. Press the **▶** button and then use **▲ / ▼** button to select **EZ SoundRite**.
 3. Press the **▶** button and then use **▲ / ▼** button to select **On** or **Off**.
 4. Press **exit** button to return to TV viewing or press **menu** button to return to the previous menu.



EZ Sound

- EZ Sound lets you enjoy the best sound without any special adjustment because the TV selects the appropriate sound options based on the program content.
- If adjusting sound options (treble, bass, or front surround) manually, EZ Sound automatically switches to **Off**.
- **Normal, Stadium, News, Music, and Theater** are programmed for good sound quality and are not adjustable.

1. Press the **menu** button and then use **▲ / ▼** button to select the **AUDIO** menu.
2. Press the **▶** button and then use **▲ / ▼** button to select **EZ Sound**.
3. Press the **▶** button and then use **▲ / ▼** button to select **Off** (your own settings), **Normal, Stadium, News, Music, or Theater**
4. Press **exit** button to return to TV viewing or press **menu** button to return to the previous menu.

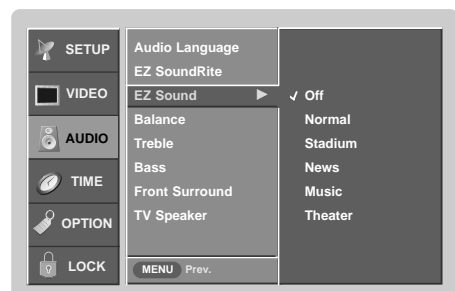

Manual Sound Control (Off option)

- Adjust the sound to suit your taste and room situations.
1. Press the **menu** button and then use **▲ / ▼** button to select the **AUDIO** menu.
 2. Press the **▶** button and then use **▲ / ▼** button to select the desired sound option (**Balance, Treble, or Bass**).
 3. Press the **▶** button and then use **◀ / ▶** button to make appropriate adjustments.
 4. Press **exit** button to return to TV viewing or press **MENU** button to return to the previous menu.



1. Press the **menu** button and then use ▲ / ▼ button to select the **AUDIO** menu.
2. Press the ► button and then use ▲ / ▼ button to select **Front Surround**.
3. Press the ► button and then use ▲ / ▼ button to select **Off**, **3D EchoSound System**, or **SRS** (Sound Retrieval System) **TruSurround XT**.

• **SRS TruSurround XT**

Takes advantage of any multi-channel format without the need to add extra speakers or equipment. Dialog clarity, bass enrichment, and the addition of stereo audio enhancement that produces an immersive sound experience from standard stereo material.

• **3D EchoSound System**

Creates a stunning simulated stereo effect from any mono sound and a realistic three-dimensional sound with a very wide and deep sound stage into stereo sound.

4. Press **exit** button to return to TV viewing or press

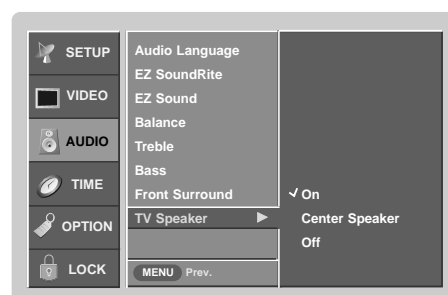

Time Menu Options

Auto Clock Setup

- The time is set automatically from a digital channel signal.
- The digital channel signal includes information for the current time provided by the broadcasting station.
- Set the clock manually, if the current time is set incorrectly by the auto clock function.

1. Press the **menu** button and then use **▲ / ▼** button to select the **TIME** menu.
2. Press the **▶** button and then use **▲ / ▼** button to select **Auto Clock**.
3. Press the **▶** button and then use **▲ / ▼** button to select **On**.
4. Press the **▶** button and then use **▲ / ▼** button to select your viewing area time zone: **Eastern, Central, Mountain, Pacific, Alaska, or Hawaii**.
5. Press **exit** button to return to TV viewing or press **menu** button to return to the previous menu.

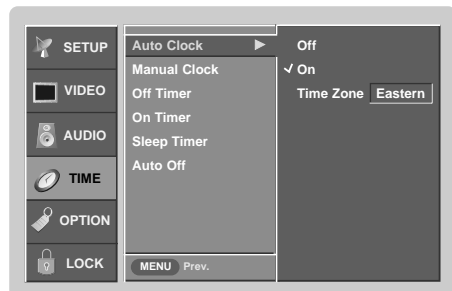

Manual Clock Setup

- If current time setting is wrong, reset the clock manually.

1. Press the **menu** button and then use **▲ / ▼** button to select the **TIME** menu.
2. Press the **▶** button and then use **▲ / ▼** button to select **Manual Clock**.
3. Press the **▶** button and then use **◀ / ▶** button to select either the year, date, or time option. Once selected, use the **▲ / ▼** button to set the year, date, and time options.
4. Press **exit** button to return to TV viewing or press **menu** button to return to the previous menu.

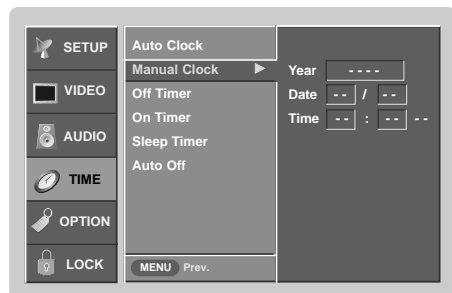

On/Off Timer Setup

- Timer function operate only if current time has been set.
- Off-Timer function overrides On-Timer function if they are set both set to the same time.
- If you do not press any button within 2 hours after the TV turns on with the On Timer function, the TV will automatically revert to standby mode.
- TV must be in standby mode for the On Timer to work.

1. Press the **menu** button and then use **▲ / ▼** button to select the **TIME** menu.
2. Press the **▶** button and then use **▲ / ▼** button to select **Off Timer** or **On Timer**.
3. Press the **▶** button and then use **▲ / ▼** button to select **On**.
 - To cancel **On/Off timer** function, select **Off**.
4. Press the **▶** button and then use **▲ / ▼** button to set the hour.
5. Press the **▶** button and then use **▲ / ▼** button to set the minutes.
6. **For On timer function only**
 - Press the **▶** button and then use **▲ / ▼** button to select the channel at turn-on.
 - Press the **▶** button and then use **▲ / ▼** button to set the sound level at turn-on.
7. Press **exit** button to return to TV viewing or press **menu** button to return to the previous menu.

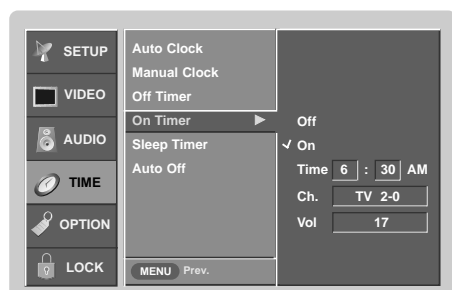

Sleep Timer

- The Sleep Timer turns the TV off at the preset time. Note that this setting is cleared when the TV is turned off.
 - You can also set up the **Sleep Timer** using the **TIME** menu.
1. Press the **timer** button repeatedly to select the number of minutes. First the **Off** option appears on the screen, followed by the turn off times in minutes: 10, 20, 30, 60, 90, 120, 180, and 240 minutes.
 2. When the number of minutes you want is displayed on the menu, press the **enter** button. The timer begins to count down from the number of minutes selected.
 3. To check the remaining minutes before the TV turns off, press the **timer** button once.
 4. To cancel the Sleep Timer, press the **timer** button repeatedly to select **Off**.

Auto Off

- If set to on and there is no input signal, the TV turns off automatically after 10 minutes.
1. Press the **menu** button and then use **▲ / ▼** button to select the **TIME** menu.
 2. Press the **▶** button and then use **▲ / ▼** button to select **Auto off**.
 3. Press the **▶** button and then use **▲ / ▼** button to select **On** or **Off**.
 4. Press **exit** button to return to TV viewing or press **menu** button to return to the previous menu.

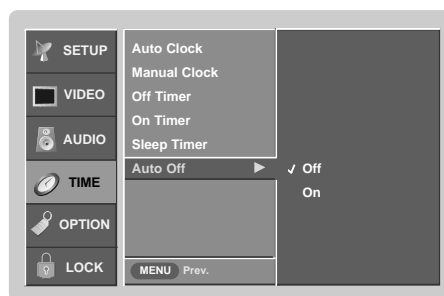

Option Menu Features

Aspect Ratio Control

- Gives you the option to choose the way an analog picture with a 4:3 aspect ratio is displayed on your 16:9 aspect ratio TV screen. When you receive an analog picture with a 4:3 aspect ratio on your 16:9 TV, you need to specify how the picture is to be displayed.
 - If you are viewing a picture with a 16:9 aspect ratio, you can't use the Horizon aspect ratio option.
 - **Note:** If a fixed image is displayed on the screen for a long time, that fixed image may become imprinted on the screen and remain visible.
1. Press the **ratio** button repeatedly to select the desired picture format.
You can also adjust **Aspect Ratio** using the **OPTION** menu.
 - **Set By Program**
Selects the proper picture proportion to match the source's image. (4:3 → 4:3, 16:9 → 16:9)
 - **4:3**
Choose **4:3** when you want to view a picture with an original 4:3 aspect ratio, with black bars appearing at both the left and right sides.
 - **16:9**
Choose **16:9** when you want to adjust the picture horizontally, in a linear proportion to fill the entire screen.
 - **Horizon**
Choose **Horizon** when you want to adjust the picture in a non-linear proportion, that is, more enlarged at both sides, to create a spectacular view.
 - **Zoom 1**
Choose **Zoom 1** when you want to view the picture without any alteration. However, the top and bottom portions of the picture will be cropped.
 - **Zoom 2**
Choose **Zoom 2** when you want the picture to be altered, both horizontally extended and vertically cropped. The picture taking a halfway trade off between alteration and screen coverage.
 - **Cinema Zoom**
Choose **Cinema Zoom** if you want to enlarge the picture proportionally correct. Note: When enlarging or reducing the picture, the image may become distorted.
The adjustment range for Cinema Zoom is 1~16. Use the **▲ / ▼** button to make adjustments.

Caption

1. Press the **cc** button repeatedly to select Caption **Off**, **EZ Mute**, or **On**.
 - **EZ Mute** shows the selected captions option (if available on program) when the TV sound is muted
 - You can also use the **OPTION** menu to select **Caption**.
2. Press the **exit** button to save and return to TV viewing.

Caption Mode

Analog Broadcasting System Captions

- Select a caption mode for displaying captioning information if provided on a program.
- Analog caption displays information at any position on the screen usually the program's dialog.
- Text displays information, usually at the bottom position and is used for a data service, generally not program related.
- Caption/Text, if provided by the broadcaster, would be available for both digital and analog channels on the Antenna 1 source.
- This TV is programmed to remember the caption/text mode it was last set to, when you turn the power off.

1. Press the **menu** button and then use **▲ / ▼** button to select the **OPTION** menu.
2. Press the **▶** button and then use **▲ / ▼** button to select **Caption Mode**.
3. Press the **▶** button and then use **▲ / ▼** button to select caption: **CC1, CC2, CC3, CC4, Text1, Text2, Text3, or Text4**.

• **CAPTION**

The term for the words that scroll across the bottom of the TV screen; usually the audio portion of the program provided for the hearing impaired.

• **TEXT**

The term for the words that appear in a large black frame and almost cover the entire screen; usually messages provided by the broadcaster.

4. Press **exit** button to return to TV viewing or press **menu** button to return to the previous menu.

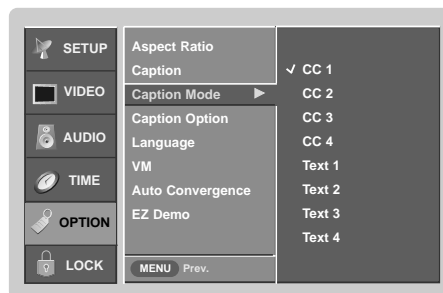

Digital Broadcasting System Captions

- Choose the language you want the DTV/CADTV Captions to appear in.
- Languages can be chosen for digital sources only if they are included on the program.

1. Press the **menu** button and then use **▲ / ▼** button to select the **OPTION** menu.
2. Press the **▶** button and then use **▲ / ▼** button to select **Caption Mode**.
3. Press the **▶** button and then use **▲ / ▼** button to select available caption languages: **English, Spanish, or French**.
4. Press **exit** button to return to TV viewing or press **menu** button to return to the previous menu.

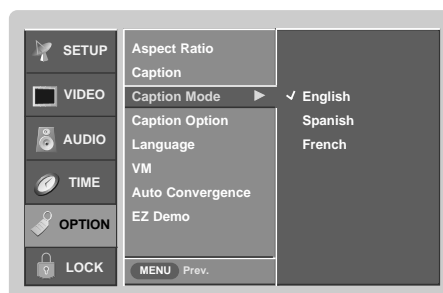

Caption Option

- Customize the DTV/CADTV captions that appear on your screen.

1. Press the **menu** button and then use **▲ / ▼** button to select the **OPTION** menu.
2. Press the **▶** button and then use **▲ / ▼** button to select **Caption Option**.
3. Press the **▶** button and then use **◀ / ▶** button to select **Custom**.
4. Use **▲ / ▼** button to customize the Style, Font, etc., to your preference. A preview icon is provided at the bottom of the screen, use it to see the caption language.

- **Size:** Set the size the words will appear in.
- **Font:** Select a typeface for the words.
- **Text Color:** Choose a color for the text.
- **Text Opacity:** Specify the opacity for the text color.
- **Bg (Background) Color:** Select a background color.
- **Bg (Background) Opacity:** Select the opacity for the background color.
- **Edge Type:** Select an edge type.
- **Edge Color:** Select a color for the edges.

5. Press **exit** button to return to TV viewing or press **menu** button to return to the previous menu.

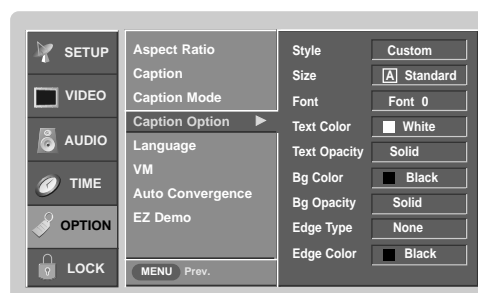

Option Menu Features continued

VM(Velocity Modulation)

- Use this function to improve the outline distinction for the picture's edges.
- If you select VM 'Off', the TV will automatically return the picture's edge appearance to factory settings.

1. Press the **menu** button and then use **▲ / ▼** button to select the **OPTION** menu.
2. Press the **▶** button and then use **▲ / ▼** button to select **VM**.
3. Press the **▶** button and then use **▲ / ▼** button to select either **Off**, **Low**, or **High**.
4. Press **exit** button to return to TV viewing or press **menu** button to return to the previous menu.

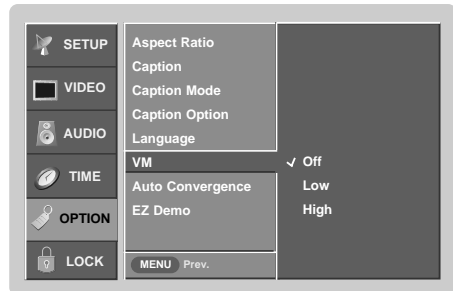

Auto Convergence

- When the TV is first installed or relocated, the picture may be unstable and have three color ghosts (red, green, blue). This problem can be solved with Auto Convergence.
- This function can adjust the picture color convergence automatically if the TV is receiving a stable signal.
- Wait 20 minutes after turning on the TV before using Auto Convergence.
- Darken the room before adjusting color convergence.

1. Press the **menu** button and then use **▲ / ▼** button to select the **OPTION** menu.
2. Press the **▶** button and then use **▲ / ▼** button to select **Auto Convergence**.
3. Press the **▶** button to start auto convergence.
 - The color convergence order will be: blue, green, then red.
 - The auto convergence function takes about 60 seconds.

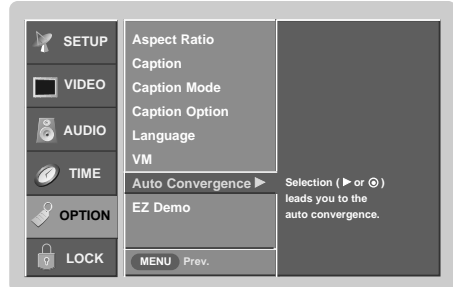

EZ Demo

- Shows you how to navigate the TV's on-screen menus.

1. Press the **menu** button and then use **▲ / ▼** button to select the **OPTION** menu.
2. Press the **▶** button and then use **▲ / ▼** button to select **EZ Demo**.
3. Press the **▶** button to start EZ Demo. Press **exit** button to stop EZ Demo.

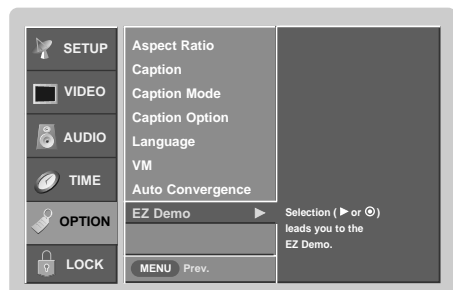

Lock Menu Options

Parental Control can be used to block specific channels, ratings and other viewing sources.

The Parental Control Function (V-Chip) is used to block program viewing based on the ratings sent by the broadcasting station. The default setting is to allow all programs to be viewed. Viewing can be blocked by the type of program and by the categories chosen to be blocked. It is also possible to block all program viewing for a time period. To use this function, the following must be done :

1. Set ratings and categories to be blocked.
2. Specify a password
3. Enable the lock

V-Chip rating and categories

Rating guidelines are provided by broadcasting stations. Most television programs and television movies can be blocked by TV Rating and/or Individual Categories. Movies that have been shown at the theaters or direct-to-video movies use the Movie Rating System (MPAA) only.

Ratings for Movies previously shown in theaters:

Movie Ratings :

- Blocking Off
- G (general audience)
- PG (parental guidance suggested)
- PG-13 (13 years and up)
- R (restricted)
- NC-17 (18 years and up)
- X (adult)

If you set PG-13 : G and PG movies will be available , PG-13, R, NC-17 and X will be blocked.

Ratings for Television programs including made-for-TV movies :

- TV-G (general audience) (individual categories do not apply)
- TV-PG (parental guidance suggested)
- TV-14 (14 years and older)
- TV-MA (mature audience)
- TV-Y (youth) (individual content categories do not apply)
- TV-Y7 (youth, 7 years and up)

TV Rating Children:

- Age (applies to TV-Y, TV-Y7)
- Fantasy Violence (applies to TV-Y7)

TV Rating General:

- Age (applies to TV-G, TV-PG, TV-14, TV-MA)
- Dialogue - sexual dialogue (applies to TV-PG, TV-14)
- Language - adult language (applies to TV-PG, TV-14, TV-MA)
- Sex - sexual situations (applies to TV-PG, TV-14, TV-MA)
- Violence (applies to TV-PG, TV-14, TV-MA)

Aux. Block

- Video 1, 2, 4 (On, Off)
- Front Video (On, Off)
- Component 1, 2 (On, Off)
- DVI (On, Off)

Lock Menu Options continued

Parental Lock Setup

- Lets you set up blocking schemes to block specific channels, ratings, and external viewing sources.
- A password is required to gain access to this menu if the Lock System is turned on

1. Press the **menu** button and then use **▲ / ▼** button to select the **LOCK** menu. Then, press the **▶** button

- If **Lock** is already set, enter the password as requested.
- The TV is set up with the initial password "7-7-7-7".

2. Use the **▲ / ▼** button to choose from the following Lock Menu options. Once the option is selected, change the settings to your preference.

- **Lock System:** Activates or disables the blocking scheme you set up previously.
- **Set Password:** Change the password by inputting a new password twice.
- **Movie Rating (MPPA):** Blocks movies according to the movie ratings limits specified, so children cannot view certain movies. You can set the ratings limit by blocking out all the movies with the ratings above a specified level. Keep in mind that the movie ratings limit only applies to movies shown on TV, not TV programs, such as soap operas.
- **TV Rating-Children:** Prevents children from watching certain children's TV programs, according to the ratings limit set. The children rating does not apply to other TV programs. Unless you block certain TV programs intended for mature audiences in the TV Rating - sub menu, your children can view those programs.
- **TV Rating-General:** Based on the ratings, blocks certain TV programs that you and your family do not want to view.
- **Aux. Block:** Enables you to select a source to block from the external source devices you have hooked up.

3. Press **exit** button to return to TV viewing or press **menu** button to return to the previous menu.

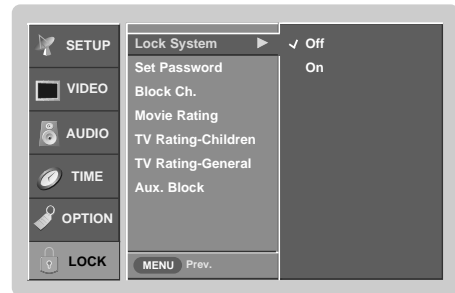

PIP (Picture-In-Picture) / POP / Twin Picture

- PIP lets you view 2 different inputs (sources) on your TV screen at the same time. One source will be large, and the other source will show a smaller inset image.
- Twin Picture mode splits the screen into 2, allowing 2 picture sources to be shown on the TV screen at the same time. Each source is given half the screen.

Watching PIP/POP/Twin Picture

Press the PIP button to access the sub picture. Each press of PIP changes the PIP options as shown below.

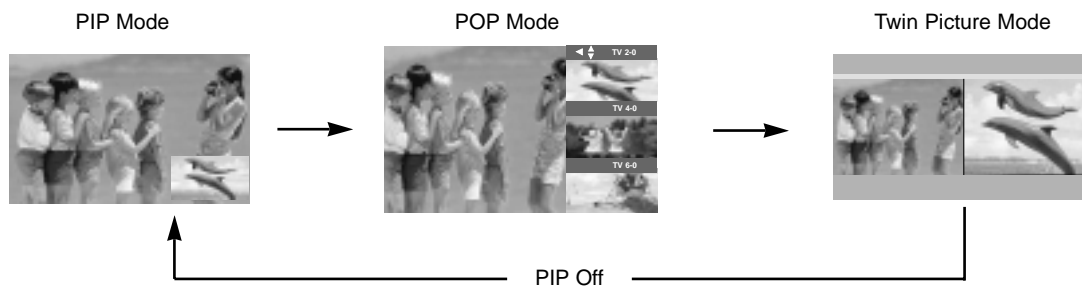

Selecting an Input Signal Source for PIP/Twin Picture

Use the **pip input** button to select the input source for the sub picture. Each press of **pip input** button changes the PIP source. You can also select sources for the **Sub Input** in the **SETUP** menu.

Main Picture Source	Available Sub Picture Sources
DTV Signal	Analog, Video 1, Video 2, Front Video, and Video 4
Analog Signal	DTV, Analog, Video 1, Video 2, Front Video, and Video 4

Swapping the PIP/Twin Picture

Use the **swap** button to switch the main and sub pictures.



TV Program Selection for PIP/Twin Picture

Select the Analog or DTV option on the Sub input menu or with the **pip input** button in PIP or Twin picture. Use the **pipch+pipch-** button to select a channel for the sub picture.

PIP (Picture-In-Picture) / POP / Twin Picture continued

Moving the PIP Sub Picture

In PIP mode, use the ▲ / ▼ / ◀ / ▶ buttons to move the sub picture to a different location on the screen.



Adjusting Main and Sub Picture Sizes for Twin Picture

Use the ▲ / ▼ / ◀ / ▶ buttons to change main and sub picture sizes in Twin Picture mode.



POP (Picture-out-of-Picture): Channel Scan

- Use POP to search the programs of all the memorized channels one-by-one on the 3 PIP screen display, (while the main picture source remains the current channel). The pictures of all the programmed channels are searched with the 3 POP screen.
- Note: Run EZ Scan channel search before using POP mode.

1. Press the **PIP** button to activate the POP mode while in PIP mode.

- **Channel selection:** Use ◀ button to enlarge the selected channel being searched on the POP screen to shift it for viewing on the Main screen.
- **POP selection:** Use ▲ / ▼ button to select one of 3 POP screen pictures in POP mode.
- **Input source selection for PIP:** Use **pip input** button or Sub Input option on the SETUP menu to select an input source for the sub picture (You can't select DTV for both the main and sub pictures simultaneously). You can only select the Analog or DTV signal for sub input source in POP mode.

2. Press the **exit** button to cancel POP mode.



Programming the Remote

- ▶ The remote control is a multi-brand or universal remote control. It can be programmed to operate most remote-controllable devices of other manufacturers. Note that the remote control may not control all models of other brands.

Programming a code into a remote mode

1. Test your remote control.
To find out whether your remote control can operate the device without programming, turn on the device such as a VCR and press the corresponding **mode** button (VCR) on the remote control. While pointing at the device, test the **power** and **ch+/-** buttons to see if the device responds properly. If not, the remote requires programming to operate the device.
2. Turn on the device to be programmed, then press the corresponding **mode** button on the remote control.
3. Press the **power** and **mute** buttons simultaneously, the remote control is ready to be programmed for the code.
4. There are two ways to find the right code for the component.
 - A. If you press the **ch +/-** buttons repeatedly, the codes will change one at-a-time. Press the **power** button after each code change. If the right code is found, the device will turn off.
 - B. Enter a code number using the number buttons on the remote. Programming code numbers for the corresponding device can be found on the following pages. Again, if the code is correct, the device will turn off.
5. Press the **exit** button to store the code.
6. Test the remote control functions to see if the component responds properly. If not, repeat from step 2.

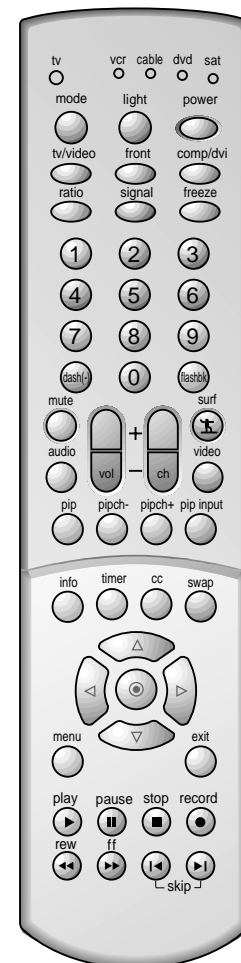

Programming Codes

VCRs

Brand	Codes	Brand	Codes	Brand	Codes	Brand	Codes
AIWA	034	KENWOOD	014 034 039 043	PORTLAND	108	TATUNG	039 043
AKAI	016 043 046 124		047 048	PULSAR	072	TEAC	034 039 043
	125 146	LG (GOLDSTAR)	001 012 013 020	QUARTZ	011 014	TECHNICS	031 033 070
AMPRO	072		101 106 114 123	QUASAR	033 066 075 145	TEKNIKA	019 031 033 034
ANAM	031 033 103	LLOYD	034	RCA	013 020 033 034		101
AUDIO DYNAMICS	012 023 039 043	LXI	003 009 013 014		040 041 062 063	THOMAS	034
BROKSONIC	035 037 129		017 034 101 106		107 109 140 144	TMK	006
CANON	028 031 033	MAGIN	040		145 147	TOSHIBA	008 013 042 047
CAPEHART	108	MAGNAVOX	031 033 034 041	REALISTIC	003 008 010 014		059 082 112 131
CRAIG	003 040 135		067 068		031 033 034 040	TOTEVISION	040 101
CURTIS MATHES	031 033 041	MARANTZ	012 031 033 067		053 054 101	UNITECH	040
DAEWOO	005 007 010 064		069	RICO	058	VECTOR RESEARCH	012
	065 108 110 111	MARTA	101	RUNCO	148	VICTOR	048
	112 116 117 119	MATSUI	027 030	SALORA	014	VIDEO CONCEPTS	012 034 046
DAYTRON	108	MEI	031 033	SAMSUNG	032 040 102 104	VIDEOSONIC	040
DBX	012 023 039 043	MEMOREX	003 010 014 031		105 107 109 112	WARDS	003 013 017 024
DYNATECH	034 053		033 034 053 072		113 115 120 122		031 033 034 040
ELECTROHOME	059		101 102 134 139		125		053 054 131
EMERSON	006 017 025 027	MGA	045 046 059	SANSUI	022 043 048 135	YAMAHA	012 034 039 043
	029 031 034 035	MINOLTA	013 020	SANYO	003 007 010 014	ZENITH	034 048 056
	036 037 046 101	MITSUBISHI	013 020 045 046		102 134		058 072 080 101
	129 131 138 153		049 051 059 061	SCOTT	017 037 112 129		
FISHER	003 008 009 010		151		131		
FUNAI	034	MTC	034 040	SEARS	003 00 009		
GE	031 033 063 072	MULTITECH	024 034	010	013 014 017 020		
	107 109 144 147	NEC	012 023 039 043		031 042 073 081		
GO VIDEO	132 136		048		101		
HARMAN KARDON	012 045	NORDMENDE	043	SHARP	031 054 149		
HITACHI	004 018 026 034	OPTONICA	053 054	SHINTOM	024		
	043 063 137 150	PANASONIC	066 070 074 083	SONY	003 009 031 052		
INSTANTREPLAY	031 033		133 140 145		056 057 058 076		
JCL	031 033	PENTAX	013 020 031 033		077 078 149		
JCPENNY	012 013 015 033		063	SOUNDESIGN	034		
	040 066 101	PHILCO	031 034 067	STS	013		
JENSEN	043	PHILIPS	031 033 034 054	SYLVANIA	031 033 034 059		
JVC	012 031 033 043		067 071 101		067		
	048 050 055 060	PILOT	101	SYMPHONIC	034		
	130 150 152	PIONEER	013 021 048	TANDY	010 034		

Cable Boxes

Brand	Codes	Brand	Codes	Brand	Codes	Brand	Codes
ABC	003 004 039 042	GOLDEN CHANNEL	030	PIONEER	065 085 090	SL MARX	030
	046 052 053	HAMLIN	049 050 055		034 051 052 063	SPRUCER	047 078
AJIN	112	HITACHI	052 055		076	STARCOM	002 004 008 009
ANTRONIK	014	HOSPITALITY	070 077	POST NEWS WEEK	016	STARGATE	008 030
ARCHER	005 007 014 024	JERROLD	002 003 004 008	PRUCER	059	SYLVANIA	067
CABLE STAR	026		009 010 052 069	PTS	011 048 071 072	TADIRAN	030
CENTURION	092		074		073 074	TAEKWANG	110
CENTURY	007	LG (GOLDSTAR)	001 106 101 005	PULSAR	100	TAIHAN	105
CITIZEN	007	M-NET	037	RCA	047	TANDY	017
COLOUR VOICE	065 090	MACOM	033	REGAL	049 050	TEXSCAN	029 067
COMBANO	080 081	MAGNAVOX	010 012 064 079	REGENCY	057	TOCOM	039 040 056
COMTRONICS	019 030	MEMOREX	100	REMBRANT	025	TOSHIBA	100
DIAMOND	023	MOVIE TIME	028 032	RK	091	UNIKA	007 014 024
EAGLE	020 030 040	NSC	015 028 038 071	SAMSUNG	102 107 030 068	UNITED CABLE	004 053
EASTERN	057 062 066		073	SCIENTIFIC ATLANTA	003 011 041 042	UNIVERSAL	005 007 014 024
ELECTRICORD	032	OAK	016 031 037 053		043 045 046		026 027 032 035
GE	072	PANASONIC	044 047	SHERITECH	022	VIEWSTAR	012 015 018 086
GEMINI	008 022 025 054	PARAGON	100	SIGNAL	030		087 088 089
GI	052 074	PHILIPS	006 012 013 020	SIGNATURE	052	ZENITH	100 114 060 093

Satellite

Brand	Codes	Brand	Codes	Brand	Codes	Brand	Codes
ALPHASTAR DSR	123	EUROPLUS	114	MEMOREX	057	STARCAST	041
AMPLICA	050	FUJITSU	017 021 022 027	NEXTWAVE	028 124 125	SUPER GUIDE	020 124 125
BIRDVIEW	051 126 129		133 134	NORSAT	069 070	TEECOM	023 026 075 087
BSR	053	GENERAL INSTRUMENT	003 004 016 029	PACE SKY SATELLITE	143		088 090 107 130
CAPETRONICS	053		031 059 101	PANASONIC	060 142		137
CHANNEL MASTER	013 014 015 018	HITACHI	139 140	PANSAT	121	TOSHIBA	002 127
	036 055	HOUSTON TRACKER	033 037 039 051	PERSONAL CABLE	117	UNIDEN	016 025 042 043
CHAPARRAL	008 009 012 077		057 104	PHILIPS	071		044 045 048 049
CITOH	054	HUGHES	068	PICO	105		078 079 080 086
CURTIS MATHES	050 145	HYTEK	053	PRESIDENT	019 102		101
DRAKE	005 006 007 010	JANIEL	060 147	PRIMESTAR	030 110 111	UNIDEN	135 136
	011 052 112 116	JERROLD	061	PROSAT	072	VIEWSTAR	115
	141	KATHREIN	108	RCA	066 106	WINEGARD	128 146
DX ANTENNA	024 046 056 076	LEGEND	057	REALISTIC	043 074	ZENITH	081 082 083 084
ECHOSTAR	038 040 057 058	LG	001	SAMSUNG	123		091 120
	093 094 095 096	LUTRON	132	SATELLITE SERVICE CO	028 035 047 057		
	097 098 099 100	LUXOR	062 144		085		
	122	MACOM	010 059 063 064	SCIENTIFIC ATLANTA	032 138		
ELECTRO HOME	089		065	SONY	103		

DVD

Brand	Codes	Brand	Codes	Brand	Codes	Brand	Codes
APEX DIGITAL	022	MAGNAVOX	013	PHILIPS	013	SONY	007
DENON	020 014	MARANTZ	024	PIONEER	004 026	THOMPSON	005 006
GE	005 006	MITSUBISHI	002	PROCEED	021	TOSHIBA	019 008
HARMAN KARDON	027	NAD	023	PROSCAN	005 006	YAMAHA	009 018
JVC	012	ONKYO	008 017	RCA	005 006	ZENITH	010 016 025
LG	001 010 016 025	PANASONIC	003 009	SAMSUNG	011 015		

Troubleshooting Checklist

<p>Snowy picture and unclear sound.</p>	<ul style="list-style-type: none"> • Check your antenna connection or location. • Check your cable input. • Check to see if the TV/VCR button on your VCR has the TV selected.
<p>Multiple images or 'ghost shadows.'</p>	<ul style="list-style-type: none"> • Check your antenna direction and/or location. • Check your cable input. • Make sure the cable from your antenna to your TV is properly connected.
<p>Interference: Sharp lines across the screen and unclear sound.</p>	<p>The following may cause image problems or distortion: Electrical appliances, powerful lights, cars, trucks; computers or portable phones; medical equipment</p> <ul style="list-style-type: none"> • If possible increase the distance between your TV and the offending appliance, or shut one of them off.
<p>Normal picture but no sound.</p>	<ul style="list-style-type: none"> • Check volume levels. • Make sure the TV is not Muted. • Try another channel. The problem may be with the broadcast, not your TV. • Are the Audio cables installed properly? • Are the wires for external speakers (if you have external speakers) installed properly? • Make sure your speakers are turned on in the Audio menu. • If your audio mode is set to SAP, the program may not have SAP.
<p>No picture and unclear sound.</p>	<ul style="list-style-type: none"> • Are you in TV or cable tuning mode, and should be in the other? • Make sure output channels on all A/V equipment are on the same channel (3 or 4). • Check that all connections are tight.
<p>No picture or sound.</p>	<ul style="list-style-type: none"> • Is the AC power plugged in? • Check that your AC power cord outlet works. (Test it by plugging in something else or try another power outlet.) • Make sure your brightness and audio controls are set properly. • Try another channel. The problem may be with the broadcast.
<p>Picture has a big black box on it, but the sound is okay.</p>	<ul style="list-style-type: none"> • The analog caption option may be set up for Text mode. Select CC 1, in the analog caption menu.
<p>No color, but the sound is okay.</p>	<ul style="list-style-type: none"> • Check the color settings in the Video menu. • Try another channel. The problem may be with the broadcast.

Picture has two horizontal black bars, one on top and one on bottom.

- Select correct Aspect Ratio in Option menu.

Forgot Secret Lock

- If you forget your password, when the display asks you to enter the secret code, key in '7', '7', '7', '7' on the remote control.

Remote control doesn't work.

- Make sure the batteries are fresh and installed properly.
- Is correct remote operating mode selected?

Menu options can't be changed or selected.

- Try unplugging your TV for a few minutes, then plug it back in.

No picture or sound when any non-cable source is selected.

- Check to see if the source equipment has been turned on.
- Make sure that the connections are secure on the back of your TV and on the source equipment.

Weak or no Stereo Sound when using a stereo VCR.

- Check to see if all the connections are secure.
- Look in the Audio mode menu to see if all the settings are correct.
- If you are using channel 3 or 4 to view your VCR, stereo sound will not be available.

The PIP inset is black or lacks contrast.

- Check to be sure that the PIP source is turned on.
- Check that all the wires are connected properly.
- Check to see if your input source for PIP is set correctly.

The PIP inset is "snowy" when the source is TV.

- Look to see if the TV/VCR button on your VCR has the TV selected or change the PIP to another source.

Time is incorrect.

- Make sure the time was set initially. Probably power was lost.
- Reset clock manually.

Maintenance

- Early malfunctions can be prevented. Careful and regular cleaning can extend the amount of time you will have your new TV. Be sure to turn the power off and unplug the power cord before you begin any cleaning.

Cleaning the Screen

1. Here's a great way to keep the dust off your screen for a while. Wet a soft cloth in a mixture of lukewarm water and a little fabric softener or dish washing detergent. Wring the cloth until it's almost dry, and then use it to wipe the screen.
2. Make sure the excess water is off the screen, and then let it air-dry before you turn on your TV.

Cleaning the Cabinet

To remove dirt or dust, wipe the cabinet with a soft, dry, lint-free cloth. Please be sure not to use a wet cloth.

Extended Absence



If you expect to leave your TV dormant for a long time (such as a vacation), it's a good idea to unplug the power cord to protect against possible damage from lightning or power surges.

Product Specifications

MODEL	R45W47, R50W47, R57W47
Power Requirement	AC 120V, 60Hz
Television System	American TV Standard, NTSC, ATSC with STB
Television Channels	VHF 2 ~ 13, UHF 14 ~ 69, CATV 1 ~ 125, CADTV 1 ~ 135
Power Consumption (W)	300W
Antenna	75 ohm external terminal for VHF/UHF
Audio Output (W)	15W + 15W

Notes

ZENITH ELECTRONICS CORPORATION
Projection TV Limited Warranty - USA



Zenith will repair or replace your product, at Zenith's option, if it proves to be defective in material or workmanship under normal use, during the warranty period ("Warranty Period") listed below, effective from the date ("Date of Purchase") of original consumer purchase of the product. This warranty is good only to the original purchaser of the product and effective only when used in the United States, excluding U.S.Territories.

<p>WARRANTY PERIOD:</p> <p>LABOR: ONE YEAR from the Date of Purchase.</p> <p>PARTS: ONE YEAR from the Date of Purchase.</p> <p>CRT Picture Tubes: 2 Years from the Date of Purchase.</p> <p>* Parts replaced are warranted for the remaining portion of the original warranty period.</p>	<p>HOW SERVICE IS HANDLED:</p> <p>Please call the Zenith Customer Interactive Center at</p> <p>In-Home Service: Please retain dealer's dated bill of sale or delivery ticket as evidence of the Date of Purchase for proof of warranty, and submit a copy of the bill of sale to the service person at the time warranty service is provided.</p> <p>Please call 1-877-9Zenith (1-877-993-6484) to locate your nearest Zenith Authorized Service Center.</p> <p>Replacement parts may be new or factory remanufactured.</p>
---	--

THIS WARRANTY IS IN LIEU OF ANY OTHER WARRANTIES, EXPRESS OR IMPLIED, INCLUDING WITHOUT LIMITATION, ANY WARRANTY OF MERCHANTABILITY OR FITNESS FOR A PARTICULAR PURPOSE. TO THE EXTENT ANY IMPLIED WARRANTY IS REQUIRED BY LAW, IT IS LIMITED IN DURATION TO THE EXPRESS WARRANTY PERIOD ABOVE. ZENITH WILL NOT BE LIABLE FOR ANY INCIDENTAL, CONSEQUENTIAL, INDIRECT, SPECIAL OR PUNITIVE DAMAGES OF ANY NATURE, EVEN IF ADVISED OF THE POSSIBILITY OF SUCH DAMAGES, INCLUDING WITHOUT LIMITATION, LOST REVENUES OR PROFITS, LOST OR CORRUPTED PROGRAMMING OR DATA, OR ANY OTHER DAMAGE WHETHER BASED IN CONTRACT, TORT, OR OTHERWISE. Some states do not allow the exclusion or limitation of incidental or consequential damages or limitation on how long an implied warranty lasts, so the above exclusion or limitation may not apply to you. This warranty gives you specific legal rights and you may also have other rights that may vary from state to state.

THIS LIMITED WARRANTY DOES NOT APPLY TO:

- 1.Damages or operating problems that result from shipping, installation, adjustment of user controls, calibration, maintenance or failure to maintain, or separate system components; and
- 2.Damages or operating problems that result from normal wear and tear, misuse, abuse, operation outside environmental specifications or contrary to the requirements or precautions in the Operating Guide, accident, lightning strikes or other natural causes, unauthorized modification or alteration, incorrect electrical current or voltage, reception problem caused by inadequate home antenna or faulty antenna connections, computer software, institutional or commercial use, or other causes not arising out of defect in material or workmanship.
3. **Therefore, the cost of repair or replacement of such a defective product shall be borne by the consumer.**

CUSTOMER INTER-ACTIVE CENTER NUMBERS:

<p>For nearest Authorized Service Center, Where to buy, Product Assistance, or Customer Assistance</p>	<p>Call 1-877-9Zenith (1-877-993-6484) (24 hours a day, 365 days per year) and select an appropriate option from the menu.</p> <p>Or visit our website at http://www.zenithservice.com</p>
---	---

LG Customer Interactive Center
201 James Record Road
Huntsville, Alabama 35824
<http://www.zenithservice.com>

Zenith Part No. 206-3949

P/NO : 3828VA0419B (AP03NB)

Free Manuals Download Website

<http://myh66.com>

<http://usermanuals.us>

<http://www.somanuals.com>

<http://www.4manuals.cc>

<http://www.manual-lib.com>

<http://www.404manual.com>

<http://www.luxmanual.com>

<http://aubethermostatmanual.com>

Golf course search by state

<http://golfingnear.com>

Email search by domain

<http://emailbydomain.com>

Auto manuals search

<http://auto.somanuals.com>

TV manuals search

<http://tv.somanuals.com>